

**PROFESSIONAL-GRADE  
ILLUMINATION TOOLS  
2016**



**STREAMLIGHT®**  
Heroes Trust Streamlight®





# HEROES TRUST STREAMLIGHT®

THE LOYALTY AND TRUST THAT PUBLIC SAFETY AND THE MILITARY HAVE GIVEN STREAMLIGHT IS BASED ON YEARS OF TESTING IN THE FIELD, AND THE PROVEN PERFORMANCE EARNED BY CARRYING OUR LIGHTS IN DANGEROUS SITUATIONS. UNCOMPROMISING PRODUCT QUALITY. OUR STRIVING FOR EXCELLENCE AND ACCOUNTABILITY HAVE DRIVEN CONTINUOUS PRODUCT IMPROVEMENT AND NEW PRODUCT INNOVATION. THAT TRUST HAS LED TO GROWTH ACROSS MARKETS AND IS WHY A STREAMLIGHT IS ONE OF THE MOST RECOGNIZED PROFESSIONAL FLASHLIGHTS AND LANTERNS.

## 2016 STREAMLIGHT FULL-LINE

<b>STINGER SERIES</b>	Stinger LED HL® Series	Pg. 12	<b>WEAPON-MOUNTED SERIES</b>	ProTac® Rail Mount Series	Pgs. 66-67		
	Stinger® HPL Series	Pg. 13		TLR Series Full-Size Series	Pgs. 68-75		
	Stinger® LED Series	Pg. 14		TLR Series Full-Size Accessories	Pgs. 76-77		
	Ultrastinger® LED	Pg. 15		TLR Sub-Compact Series	Pgs. 78-81		
	PolyStinger® Series	Pgs. 16-17					
<b>STRION SERIES</b>	Stinger® Specialty Series	Pgs. 16-17	<b>TACTICAL SERIES</b>	Super Tac® X // TL-2® X	Pg. 82		
	Stinger Accessories	Pg. 18		Scorpion® HL // Scorpion® X // NightFighter® X	Pg. 83		
				PolyTac® Series	Pgs. 84-85		
				ProTac® Rail Mount Series	Pgs. 86-87		
				ProTac® Series	Pgs. 88-93		
<b>SL SERIES</b>			Sidewinder® Series	Pgs. 94-95			
	SL Series	Pgs. 22-23	<b>CAMO SERIES</b>				
				Buckmasters® Series	Pgs. 96-97		
<b>LANTERN SERIES</b>			<b>STYLUS SERIES</b>	Stylus® Series	Pgs. 98-101		
	Portable Scene Light	Pg. 26		Stylus Reach® Series	Pgs. 102-103		
	HID LiteBox®	Pg. 27					
	E-Flood HL® LiteBox® HL	Pgs. 28-29		<b>HEADLAMP SERIES</b>	Headlamp Series	Pgs. 106-109	
	E-Flood® LiteBox® // E-Flood® FireBox®	Pg. 30					
	E-Spot® LiteBox® // E-Spot® FireBox®	Pg. 31			<b>TWIN-TASK SERIES</b>	Twin-Task® Series	Pgs. 110-112
	Fire Vulcan® LED	Pg. 32					
	Lantern Accessories	Pg. 33				<b>TASK-LIGHT SERIES</b>	Task-Light® Series
Waypoint® Series	Pgs. 34-35						
Siege® Series	Pgs. 36-37	<b>SPECIALTY SERIES</b>	Specialty Series				Pg. 113
<b>RIGHT ANGLE SERIES</b>	Survivor® Series		Pgs. 40-41	<b>STREAMLIGHT JR. SERIES</b>	Streamlight Jr.® Series	Pg. 115	
	PolyTac 90®	Pg. 42					
	Vantage®	Pg. 43	<b>POCKET LIGHT SERIES</b>		Pocket Lights	Pgs. 116-117	
	Knucklehead® Series	Pgs. 44-45					
<b>SAFETY-RATED SERIES</b>			<b>LIGHTS FOR A CAUSE SERIES</b>	Lights For A Cause	Pgs. 118-121		
	Dualie® Series	Pgs. 50-51					
	Knucklehead® HAZ-LO® Series	Pgs. 52-53					
	Safety-Rated Headlamps	Pgs. 54-55					
	Safety-Rated ProPolymer® Series	Pgs. 56-61					



// STAY CONNECTED WITH US:



# LEADING THE INDUSTRY

## WITH THE GREATEST VARIETY OF PROFESSIONAL GRADE LIGHTS:



STINGER LED HL®  
pg. 12



STINGER DS LED HL®  
pg. 12



STINGER® HPL  
pg. 13



STINGER DS® HPL  
pg. 13



STINGER® LED  
pg. 14



STINGER DS® LED  
pg. 14



ULTRASTINGER® LED  
pg. 15



POLYSTINGER®  
LED HAZ-LO® pg. 16



PORTABLE SCENE LIGHT  
pg. 26



HID LITEBOX®  
pg. 27



E-FLOOD® LITEBOX® HL  
pg. 29



E-FLOOD® LITEBOX®  
pg. 30



E-SPOT® LITEBOX®  
pg. 31



FIRE VULCAN® LED  
pg. 32



WAYPOINT®  
pg. 34



3AA HAZ-LO®  
pg. 54



SEPTOR®  
HAZ-LO® pg. 54



ARGO®  
HAZ-LO® pg. 55



TRIDENT®  
HAZ-LO® pg. 55



2AA PROPOLYMER®  
HAZ-LO® pg. 56



4AA PROPOLYMER®  
LED pg. 57



4AA PROPOLYMER®  
LUX pg. 57



4AA PROPOLYMER®  
MAX pg. 58



3C PROPOLYMER®  
LED pg. 58



TLR IR™ LIGHTS  
pg. 72-73



TLR-VIR® LIGHTS  
pg. 75



TLR-6®  
pg. 78



TLR-4®  
pg. 79



TLR-3®  
pg. 79



TLR-4® G  
pg. 80



TLR-2 HL® G  
pg. 81



TLR-2® G  
pg. 81



SUPER TAC® X  
pg. 82



TL-2® X  
pg. 82



18650 LI-ION BATTERIES  
& CHARGER pg. 89



PROTAC HL® USB  
pg. 90



PROTAC HL®  
pg. 91



PROTAC HL®  
HEADLAMP pg. 91



PROTAC® 1L  
pg. 92



PROTAC® 2L  
pg. 92



PROTAC® EMS  
pg. 92



PROTAC® 1AA  
pg. 93



PROTAC® 2AA  
pg. 93



BUCKMASTERS®  
TWIN-TASK® 2L pg. 97



STYLUS PRO® USB &  
STYLUS PRO® USB UV pg. 99



STYLUS PRO® 360 pg. 99



STYLUS PRO®  
pg. 100



MICROSTREAM®  
pg. 100



STYLUS® &  
STYLUS® UV pg. 101



STYLUS PRO  
REACH® pg. 102



STYLUS REACH® &  
STYLUS REACH® 18 pg. 103



DOUBLE CLUTCH™  
USB pg. 106



TWIN-TASK®  
3C LED pg. 110



TWIN-TASK®  
3C-UV LED pg. 110



TWIN-TASK®  
3AA LED pg. 111



TWIN-TASK®  
3AAA-LASER LED  
pg. 111



TWIN-TASK®  
1L LED  
pg. 112



TWIN-TASK®  
2L LED  
pg. 112



TASK-LIGHT®  
3AA LED  
pg. 112



NIGHT COM® LED  
pg. 113



NIGHT COM® UV  
pg. 113



MULTI OPS®  
pg. 113

# STREAMLIGHT

PERFORMANCE. PERIOD.



STINGER® LITE PIPE pg. 16    POLYSTINGER DS® LED pg. 17    POLYSTINGER® LED pg. 17    STINGER® CLASSIC LED pg. 17    STRION LED HL® pg. 19    STRION® HPL pg. 20    STRION® LED pg. 20    SL-20L® pg. 22    SL-20LP® pg. 23



WAYPOINT® RECHARGEABLE pg. 35    **NEW** SUPER SIEGE® pg. 36    THE SIEGE® pg. 37    SIEGE® AA pg. 37    SURVIVOR® pg. 41    POLYTAC 90® pg. 42    VANTAGE® pg. 43    KNUCKLEHEAD® FLOOD & SPOT MODELS pg. 45    3AA PROPOLYMER® DUALIE® MODELS pg. 51    KNUCKLEHEAD® HAZ-LO® MODELS pg. 53



3C PROPOLYMER® HAZ-LO® pg. 59    3AA PROPOLYMER® HAZ-LO® pg. 60    3N PROPOLYMER® LED pg. 61    **NEW** PROTAC RAIL MOUNT 2 pg. 67    **NEW** PROTAC RAIL MOUNT 1 pg. 67    TLR-1 HL® & TLR-2 HL® pg. 68    TLR-1® & TLR-1®s pg. 69    TLR-2® & TLR-2®s pg. 69    TLR-1 HPL® pg. 70    TLR-1® GAME SPOTTER® pg. 71



SCORPION® HL pg. 83    SCORPION® X pg. 83    NIGHTFIGHTER® X pg. 83    POLYTAC 90® pg. 84    POLYTAC® pg. 85    POLYTAC® HP pg. 85    PROTAC RAIL MOUNT 2 pg. 87    PROTAC RAIL MOUNT 1 pg. 87    PROTAC HL® 4 pg. 88    PROTAC HL® 3 pg. 89

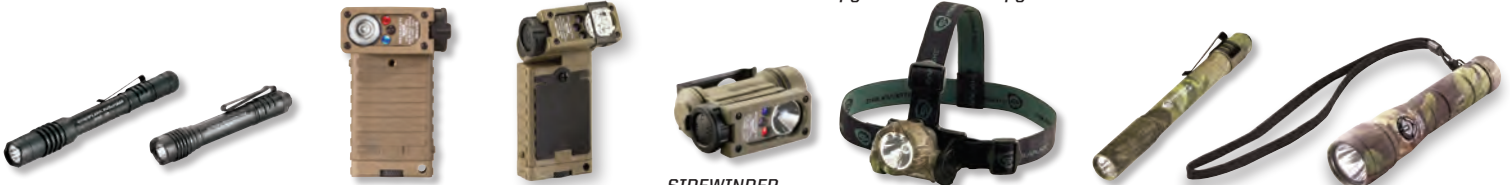

PROTAC® 2AAA pg. 93    PROTAC® 1AAA pg. 93    SIDEWINDER® MILITARY pg. 94    SIDEWINDER® RESCUE pg. 94    SIDEWINDER COMPACT® II MILITARY pg. 95    **NEW** BUCKMASTERS® CAMO TRIDENT® pg. 96    **NEW** BUCKMASTERS® STYLUS PRO® CAMO pg. 97    **NEW** BUCKMASTERS® PACKMATE® pg. 97



PROTAC HL® HEADLAMP pg. 107    ENDURO® pg. 107    SEPTOR® pg. 108    ARGO® pg. 108    TRIDENT® pg. 109    GREEN TRIDENT® pg. 109    BUCKMASTERS® TRIDENT® pg. 109



STREAMLIGHT JR.® LED pg. 115    STREAMLIGHT JR.® REACH LED pg. 115    CLIPMATE® USB pg. 116    EPU-5200™ (Light Not Included) pg. 116    CLIPMATE® pg. 117    THE LOGO™ pg. 117    KEY-MATE® pg. 117    NANO LIGHT® pg. 121

# AT STREAMLIGHT, WE POWER INNOVATION.

**MULTI-FUEL LIGHTS, USB COMPATIBILITY,  
PORTABLE POWER. STREAMLIGHT CREATES IT.**

*Streamlight works to deliver products that fit our customers workstyles and lifestyles. Longer run times, more power options - all designed to deliver a product that performs and gets you through the workday or power outage.*



## **PORTABLE USB CHARGER // EPU-5200™ pg. 116**

*We've made it easier than ever to keep your USB flashlights and mobile devices powered up and ready. You can clip the electronic power unit to a vest and take it anywhere. It's lightweight, yet rugged and durable to stand up to almost anything. And it's also a flashlight! IPX4 water-resistant.*

## **LIGHT + POWER // SUPER SIEGE® LANTERN pg. 36**

*What happens when you take our industry-leading lantern and engineer an 8800 mAh rechargeable battery in it? Pure perfection. The lithium ion battery supplies the power for the lantern as well as enabling you to recharge all your electronic devices from the handy USB port.*



**USB COMPATIBILITY // PROTAC HL® USB pg. 90**

USB compatibility means you're always prepared. With a USB plug in your laptop, TV or car - you're always able to ensure your light is charged and at the ready. Tri-fuel capability makes this light incredibly versatile.



**MULTI-FUEL LIGHTS // PROTAC HL® 4 pg. 88**

Flexibility is king and that's what we've built into our new ProTac HL4. With dual-fuel capability that allows you to choose from CR123A Lithium Batteries or our new 18650 Li-Ion Batteries and charger - you're sure to be equipped.



**INNOVATIVE CHARGERS // FAST PIGGYBACK® pg. 21**

Streamlight offers a full compliment of chargers that suit your needs. Steady chargers, bank chargers and the most convenient charger of all the Fast Piggyback Charger. Charges fast and has a second battery charged and ready to go so you'll never miss a beat.

**18650 LI-ION BATTERIES AND CHARGER pg. 89**

Dual input power sources provide a wide variety of battery charging options when a wall outlet is not available, such as a PC, power pack or 12VDC automotive power. Models available with charger, two 18650 batteries and either a 120V AC/micro-USB adapter or custom micro-USB cord, depending on model.

# WE DON'T JUST MAKE FLASHLIGHTS, WE SHAPE ILLUMINATION.



## GENERAL USE CIRCULAR

**SUPER SIEGE®** pg. 36

### PERFORMANCE CHARACTERISTICS

- Optimal balance of candela and lumens
- Longest regulated run times
- The best value

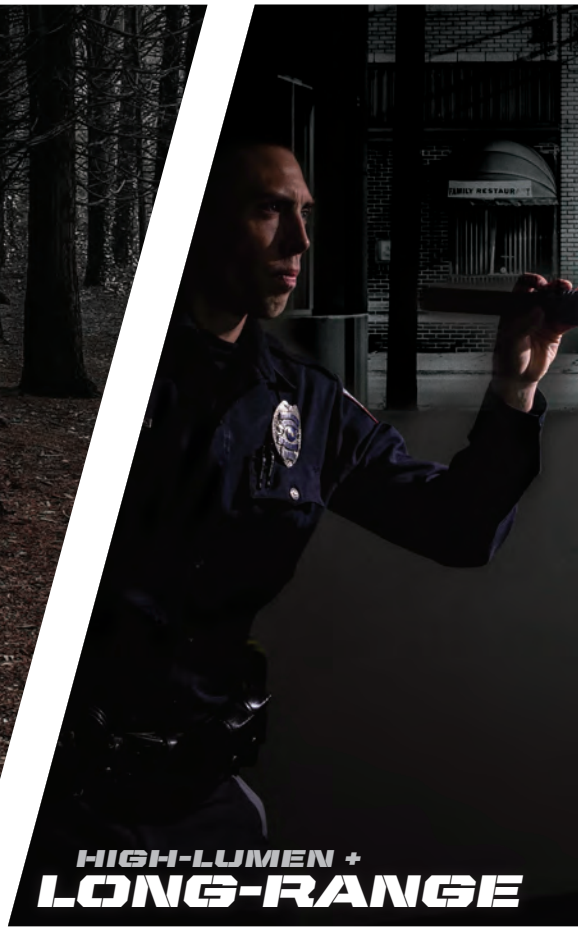

## HIGH-LUMEN + LONG-RANGE

**STINGER® HPL** pg. 13

### PERFORMANCE CHARACTERISTICS

- High-candela beam
- Delivers long-range lighting
- Casts a bright peripheral beam



Whether we are engineering the highest performing rechargeable lights on the market, developing durable new lights for standard and hazardous tasks, or shaping our innovative beam patterns into hand-held, hands free, and even scene lighting, you can be sure you are always getting industry-leading illumination at a great value.



## LARGE AREA SCENE LIGHT

### PORTABLE SCENE LIGHT pg. 26 PERFORMANCE CHARACTERISTICS

- High-lumen beam with selectable beam pattern
- Delivers maximum illumination
- Selectable intensity provides a good level of candela

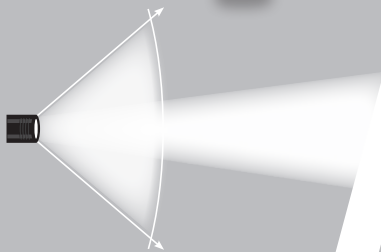

**STINGER/STRION** SERIES  
// STREAMLIGHT 2016



"MY STINGER DS LED  
**WAS RUN OVER**  
AGAIN AND AGAIN ON A MAJOR HIGHWAY,  
**BUT IT'S STILL SHINING!"**

*Officer Robert Willmon  
Lufkin, TX*









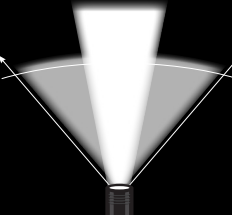

// TELL US YOUR STORY ... 

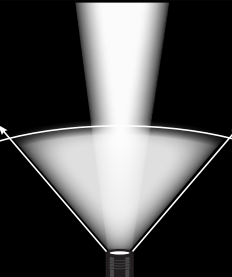
USE THIS EASY COMPARISON CHART TO CHOOSE THE BEST LIGHT FOR YOU BASED ON THE FEATURES THAT YOU NEED!

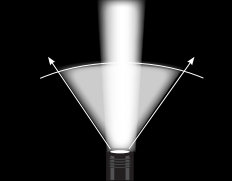
BEAM PATTERN

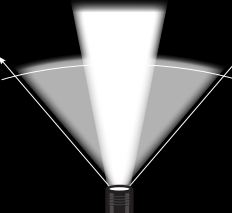
SPECS

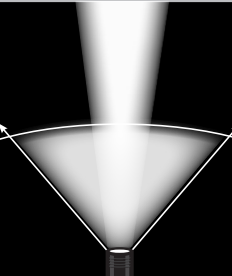
HIGH MODE PERFORMANCE SHOWN. FOR SPECS IN OTHER MODES, SEE MODEL PAGES.

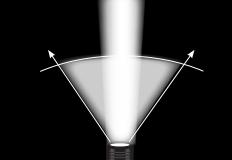
<p><b>STINGER DS LED HL®</b> <b>STINGER LED HL®</b> Pg. 12</p>  <p><b>HL SERIES</b></p>		<p>OUTPUT: 640 lumens INTENSITY: 22,000 candela BATTERY: NiMH BEAM DISTANCE: 297 meters RUN TIME: 1h 15m DS SIZE: 8.85" x 1.62" x 1.17" (22.48 x 4.11 x 2.97 cm) DS WEIGHT: 12.8 oz (364 g) COLOR: Black or Kryptek® Highlander</p>
<p><b>STINGER DS® HPL</b> <b>STINGER® HPL</b> Pg. 13</p>  <p><b>HPL SERIES</b></p>		<p>OUTPUT: 740 lumens INTENSITY: 48,000 candela BATTERY: NiMH BEAM DISTANCE: 438 meters RUN TIME: 1h 15m DS SIZE: 9.65" x 2.2" x 1.17" (24.51 x 5.59 x 2.97 cm) DS WEIGHT: 14 oz (396 g) COLOR: Black</p>
<p><b>STINGER DS® LED</b> <b>STINGER® LED</b> Pg. 14</p>  <p><b>TRADITION SERIES</b></p>		<p>OUTPUT: 350 lumens INTENSITY: 24,000 candela BATTERY: NiMH or NiCd BEAM DISTANCE: 310 meters RUN TIME: 2h DS SIZE: 8.85" x 1.62" x 1.17" (22.48 x 4.11 x 2.97 cm) DS WEIGHT: 12.8 oz (364 g) COLOR: Black</p>
<p><b>STRION LED HL®</b> Pg. 19</p>  <p><b>HL SERIES</b></p>		<p>OUTPUT: 500 lumens INTENSITY: 10,000 candela BATTERY: Li-ion BEAM DISTANCE: 200 meters RUN TIME: 1h SIZE: 5.90" x 1.25" x .95" (14.99 x 3.18 x 2.41 cm) WEIGHT: 5.2 oz (148 g) COLOR: Black or Kryptek® Highlander</p>
<p><b>STRION® HPL</b> Pg. 20</p>  <p><b>HPL SERIES</b></p>		<p>OUTPUT: 615 lumens INTENSITY: 40,000 candela BATTERY: Li-ion BEAM DISTANCE: 400 meters RUN TIME: 1h SIZE: 7" x 2.2" x .95" (17.78 x 5.59 x 2.41 cm) WEIGHT: 7.1 oz (202 g) COLOR: Black</p>
<p><b>STRION® LED</b> Pg. 20</p>  <p><b>TRADITION SERIES</b></p>		<p>OUTPUT: 260 lumens INTENSITY: 10,000 candela BATTERY: Li-ion BEAM DISTANCE: 200 meters RUN TIME: 2h SIZE: 5.9" x 1.25" x .95" (14.99 x 3.18 x 2.41 cm) WEIGHT: 5.2 oz (148 g) COLOR: Black or Pink</p>

**STINGER/STRION** SERIES  
// **STREAMLIGHT 2016**

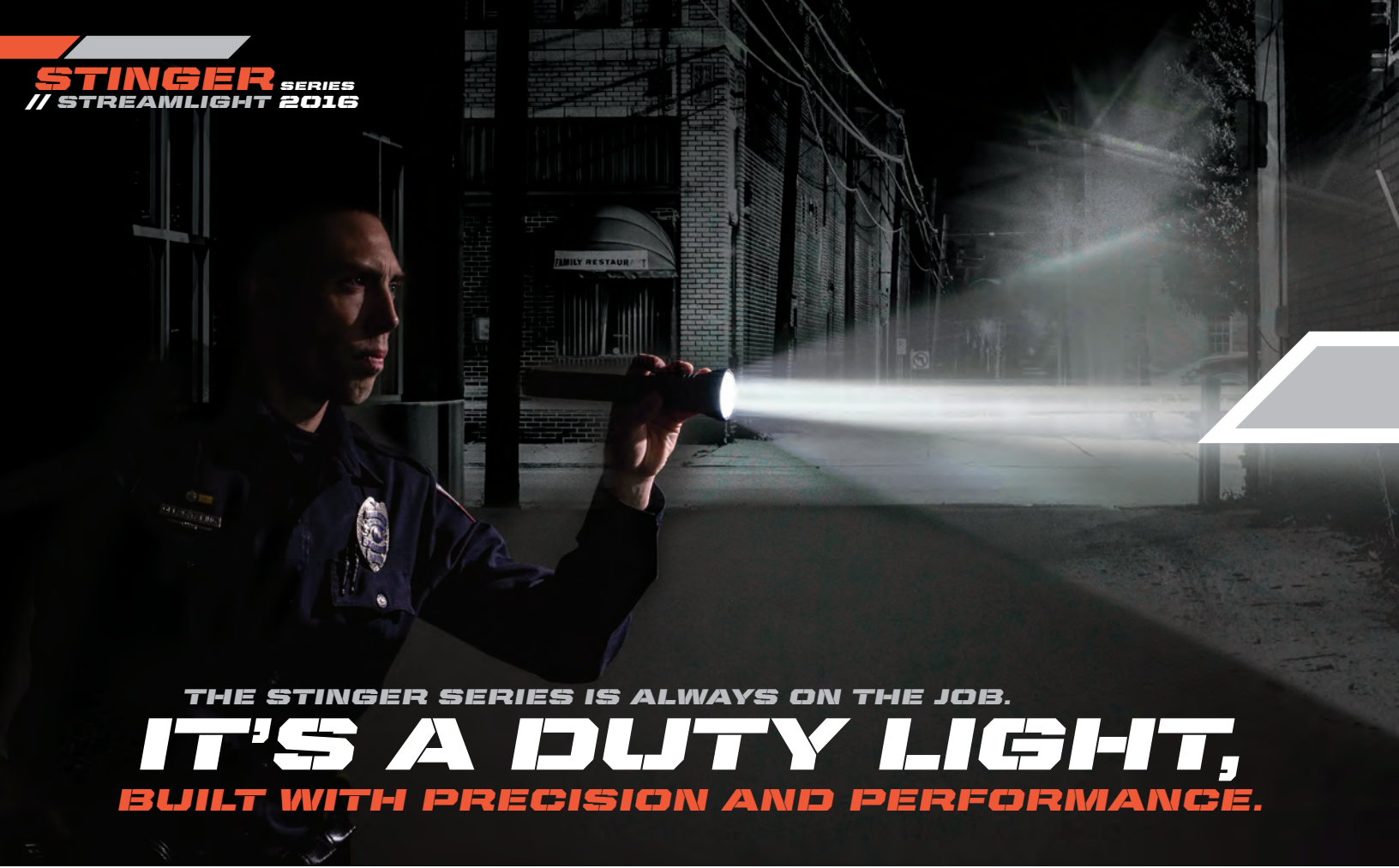

THE STINGER SERIES IS ALWAYS ON THE JOB.  
**IT'S A DUTY LIGHT,**  
BUILT WITH PRECISION AND PERFORMANCE.

**STINGER DS LED HL®**  
**STINGER LED HL®**

**HL SERIES**

Everything you love about the Stinger, with more lumens for more brightness and a wider beam that lights up a whole area from side to side. Now you'll see the dangers that may be hiding in corners, in rooms, tunnels, alleyways, cars, and more.

**STINGER DS LED HL**

**BATTERY:** 3-cell, 3.6V NiMH sub-C

**DS SIZE:** 8.85" x 1.62" x 1.17"  
(22.48 x 4.11 x 2.97 cm)

**DS WEIGHT:** 12.8 oz (364 g)

**COLOR:** Black

**STINGER LED HL**

**BATTERY:** 3-cell, 3.6V NiMH sub-C

**SIZE:** 8.41" x 1.62" x 1.17"  
(21.36 x 4.11 x 2.97 cm)

**WEIGHT:** 12.4 oz (352 g)

**COLOR:** Black or Kryptek®

**DS LED HL LED HL**

75454	75430	with 120V AC/12V DC - 2 holders (NiMH)-Black
75455	75431	with 120V AC (NiMH)-Black
75456	75432	with 12V DC (NiMH)-Black
75458	75434	with 120V AC/12V DC - 1 PiggyBack (NiMH)-Black
-	75699	with 120V AC/12V DC - 1 PiggyBack (NiMH)-Kryptek® Highlander
75457	75433	with 120V AC/12V DC - Fast Charge 2 holders (NiMH)-Black
75453	75429	without Charger (NiMH)-Black
-	75698	without Charger (NiMH)-Kryptek® Highlander

	HIGH	MEDIUM	LOW
<b>LUMENS:</b>	640	340	170
<b>CANDELA:</b>	22,000	11,000	5,500
<b>DISTANCE:</b>	297m	210m	148m
<b>RUN TIME:</b>	1h 15m	2h	4h

Strobe mode: 3 hours of continuous run time

**640 LUMENS**

The Kryptek® Highlander pattern is specially designed for those geographical regions and elevations that are varied. Kryptek® Highlander increases stealth when pursuing a wide range of quarry in mixed terrain.

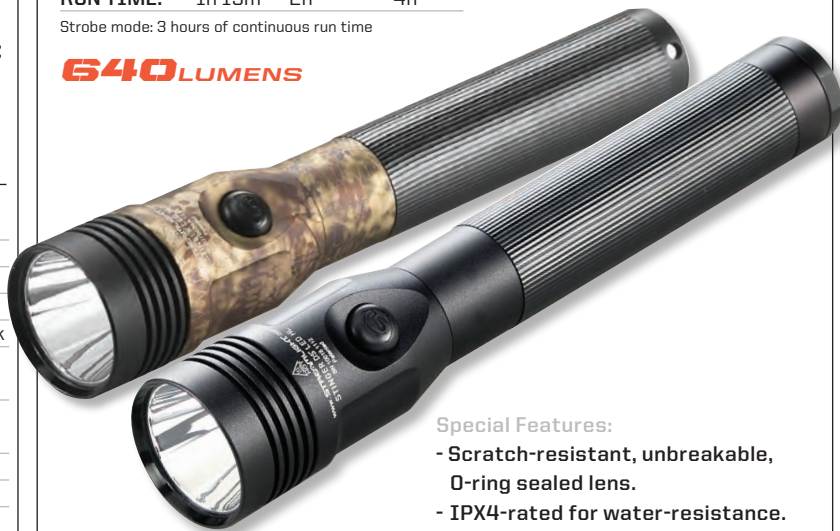

**Special Features:**

- Scratch-resistant, unbreakable, O-ring sealed lens.
- IPX4-rated for water-resistance.
- 1 meter impact-resistance tested.



With **[(STROBE)]**  
Double tap switch to activate.

AVAILABLE IN BOTH DUAL SWITCH AND STANDARD STYLES

**STINGER DS® HPL**  
**STINGER® HPL**

**STINGER  
 DUTY+TACTICAL  
 HOLSTER**



- DUTY + TACTICAL HOLSTER**
- Super-tough nylon construction
  - Quick, Easy Access

	HIGH	MEDIUM	LOW
LUMENS:	740	380	190
CANDELA:	48,000	24,000	12,000
DISTANCE:	438m	310m	219m
RUN TIME:	1h 15m	2h 30m	4h 30m

Strobe mode: 3 hours of continuous run time

**740 LUMENS**



With **[(STROBE)]**  
 Double tap switch to activate.

AVAILABLE IN BOTH DUAL SWITCH AND STANDARD STYLES

**Special Features:**

- Scratch-resistant, unbreakable, O-ring sealed lens.
- IPX4-rated for water-resistance.
- 1 meter impact-resistance tested.

**HPL SERIES**

The Stinger® HPL has combined two intensely bright illumination patterns into one multi-tasking beam giving you clarity up-close and deep into the horizon. Its long distance beam reaches 438 meters and the 740 lumen beam provides side to side visibility to fill in up-close areas and corners.

<b>STINGER DS HPL</b>	<b>STINGER HPL</b>
<b>BATTERY:</b> 3-cell, 3.6V NiMH sub-C	<b>BATTERY:</b> 3-cell, 3.6V NiMH sub-C
<b>DS SIZE:</b> 9.65" x 1.62" x 1.17" (24.51 x 4.11 x 2.97 cm)	<b>SIZE:</b> 9.23" x 1.62" x 1.17" (23.44 x 4.11 x 2.97 cm)
<b>DS WEIGHT:</b> 14.0 oz (396 g)	<b>WEIGHT:</b> 13.6 oz (385 g)
<b>COLOR:</b> Black	<b>COLOR:</b> Black

DS HPL	HPL	
75863	75763	with 120V AC/12V DC - 2 holders
75861	75761	with 120V AC
75899	75799	with 12V DC
75882	75782	with 120V AC/12V DC - 1 PiggyBack
75885	-	with 120V AC/12V DC - Fast Charge
75900	75980	without Charger

SEE STINGER ACCESSORIES P. 18



THE STINGER IS FOUND  
**IN MORE TOOL BOXES**  
AND HOLSTERS FOR TWO SIMPLE REASONS...  
**PERFORMANCE AND DEPENDABILITY.**

**STINGER DS<sup>®</sup> LED**  
**STINGER<sup>®</sup> LED**

The Stinger LED and Stinger DS LED deliver the optimal balance of performance and value with the longest run time in the Stinger family. The DS model provides both a tailcap and head switch.

<b>STINGER DS LED</b>	<b>STINGER LED</b>
<b>BATTERY:</b> NiMH or NiCd	<b>BATTERY:</b> NiMH or NiCd
<b>DS SIZE:</b> 8.85" x 1.62" x 1.17" (22.48 x 4.11 x 2.97 cm)	<b>SIZE:</b> 8.41" x 1.62" x 1.17" (21.36 x 4.11 x 2.97 cm)
<b>DS WEIGHT:</b> 12.8 oz (364 g)	<b>WEIGHT:</b> 12.4 oz (352 g)
<b>COLOR:</b> Black	<b>COLOR:</b> Black

DS LED	LED	(NiCd Battery unless otherwise noted)
75813	75713	with 120V AC/12V DC Steady Charge-Black
75811	75711	with 120V AC Steady Charge-Black
75832	75732	with 120V AC/12V DC Steady PiggyBack <sup>®</sup> -Black
75835	75735	with 120V AC/12V DC Fast Charge-Black
75812	75712	with 12V DC Steady Charge-Black
75853	75753	with 12V DC Steady Charge (NiMH)-Black
75810	75710	without Charge-Black
75970	75960	without Charger (NiMH)-Black



**TRADITION SERIES**

**350 LUMENS**

	HIGH	MEDIUM	LOW
<b>LUMENS:</b>	350	175	85
<b>CANDELA:</b>	24,000	12,000	6,000
<b>DISTANCE:</b>	310m	219m	155m
<b>RUN TIME:</b>	2h	3h 45m	7h 15m

Strobe mode: 5h 30m of continuous run time



With **((STROBE))**  
Double tap switch to activate.

AVAILABLE IN BOTH DUAL SWITCH AND STANDARD STYLES

**Special Features:**

- Scratch-resistant, unbreakable, O-ring sealed lens.
- IPX4-rated for water-resistance.
- 1 meter impact-resistance tested.



**FAR REACHING BEAM +  
1,100 LUMENS...  
THERE'S A REASON IT'S CALLED THE  
ULTRASTINGER LED.**

**ULTRASTINGER® LED**

**HL SERIES**

We pumped up the brightness to give the UltraStinger LED a piercing 1,100 lumens. But that's not all. It now has a farther-reaching beam, TEN-TAP® programming for its multiple intensities and strobe; plus a rubber sleeve for a better grip. It's IPX4 rated for water resistance and it works with existing Stinger® chargers and accessories.

**ULTRASTINGER LED**

**BATTERY:** 5-cell, 6V Ni-MH sub-C

**SIZE:** 11.82" x 2.37" x 1.19"  
(30 x 6.01 x 3 cm)

**WEIGHT:** 19.9 oz (564 g)

**COLOR:** Black

**ULTRASTINGER LED**

- 77553 with AC/DC Steady Charge-Black
- 77554 with AC/DC Fast Charge-Black
- 77551 with AC Steady Charge-Black
- 77552 with AC Fast Charge-Black
- 77555 with DC Steady Charge-Black
- 77556 with DC Fast Charge-Black
- 77550 without Charger-Black

	HIGH	MEDIUM	LOW
<b>LUMENS:</b>	1,100	350	90
<b>CANDELA:</b>	65,000	21,000	5,000
<b>DISTANCE:</b>	510m	290m	141m
<b>RUN TIME:</b>	1h 30m	4h 30m	16h

Strobe mode: 3h 15m of continuous run time

**1,100 LUMENS**



With **((STROBE))**  
Double tap switch to activate.

TEN-TAP® Programmable switch allows user selection of one of three different programs:

- High/medium/low with strobe (factory default)
- High only without strobe
- High/medium/low without strobe

**POLYSTINGER® LED HAZ-LO®**

If you're working in a potentially hazardous location, this is the light you need. It provides lots of bright, white light, yet it's intrinsically safe, with a Class I, Div. 1. rating. It has an O-ring sealed, unbreakable, scratch-resistant lens. It's IPX4-rated for water-resistance, and 3 meter impact-resistance tested.

**POLYSTINGER LED HAZ-LO**

**BATTERY:** 4-cell, 4.8V NiCd sub-C

**SIZE:** 10.2" x 1.76" x 1.34"  
(25.9 x 4.47 x 3.4 cm)

**WEIGHT:** 13.5 oz (382 g)

**COLOR:** Black or Yellow

**YELLOW BLACK**

76412 76442 120V AC/12V DC

76411 76441 12V DC

76410 76440 Without Charger

**ACCESSORIES**

76409 Lanyard

75928 Loop Holster

75906 Ring Holder

76375 NiCd Battery Stick

75401 5 Unit Bank Fast Charger 120V

75400 5 Unit Bank Charger 120V

75103 Charger Holder Fast Charge (2.5 hr)

75100 Charger Holder Stinger (10 hr)

22311 120V AC Charge Cord

22051 DC1 Charge Cord

22050 DC2 Direct Wire Charge Cord

**TRADITION SERIES**

	HIGH	LOW
<b>LUMENS:</b>	130	50
<b>CANDELA:</b>	15,000	5,700
<b>DISTANCE:</b>	245m	151m
<b>RUN TIME:</b>	4h	12h

Moonlight mode: 20 days of continuous run time



Lanyard Ring with lanyard for tail cap.



Class I & II, Division 1, Groups C,D,F,G;  
Class I, Division 2, Groups A,B,C,D;  
Class III; 138°C, T-Code: T3C

**Special Features:**

- Non-conductive, corrosion-resistant body.
- IPX4-rated for water-resistance.
- 3 meter impact-resistance tested.

**STINGER® LITE PIPE**

Ultra-thin rechargeable work light features 8 LEDs. It features a head-mounted, push-button switch and a removable, rotating hook which can hang almost anywhere. Thin enough to fit into the tightest spots. Available as a complete system or, if you have a xenon Stinger, you can buy the Lite Pipe kit to convert it to a Stinger Lite Pipe.

**STINGER LITE PIPE**

**BATTERY:** 3-cell, 3.6V NiCd sub-C. Available NiMH sub-C.

**SIZE:** 19.62" x 1.5" x 1.07"  
(49.84 x 3.81 x 2.71 cm)

**WEIGHT:** 12.3 oz (339 g)

**COLOR:** Black

**NiCd NiMH**

75684 75685 with 120V AC/DC Steady Charge

75652 - with 120V AC

75654 - with 120V AC/DC PiggyBack Steady Charge

75650 75651 without Charger

**ACCESSORIES**

75951 Stinger Lite Pipe Kit (For use with existing Xenon Stinger)

<b>LUMENS:</b>	220
<b>RUN TIME:</b>	3h 25m



**Special Features:**

- Scratch-resistant, cone.
- IPX4-rated for water-resistance.
- 1 meter impact-resistance tested.



Stinger Lite Pipe Kit  
(Works with Xenon Stingers manufactured after 2002)



# POLYSTINGER DS<sup>®</sup> LED

## POLYSTINGER<sup>®</sup> LED

Intense brightness, long-range and long run time in a durable nylon polymer housing. It's the ideal combination of power, performance and durability. The DS model has the convenience of two full-function, independent switches: one on the head and a tail switch.

### POLYSTINGER DS LED

**BATTERY:** 3-cell, 3.6V NiCd sub-C. Available NiMH sub-C.

**DS SIZE:** 8.64" x 1.76" x 1.21"  
(21.95 x 4.47 x 3.07 cm)

**DS WEIGHT:** 11.9 oz (338 g)

**DS COLOR:** Black

### POLYSTINGER LED

**BATTERY:** 3-cell, 3.6V NiCd sub-C. Available NiMH sub-C.

**SIZE:** 8.07" x 1.76" x 1.21"  
(20.50 x 4.47 x 3.07 cm)

**WEIGHT:** 11.5 oz (326 g)

**COLOR:** Black or Yellow

DS LED	LED	(NiCd Battery unless otherwise noted)
-	76163	120V AC/DC 2 Holders—Yellow
76813	76113	120V AC/DC 2 Holders—Black
-	76161	120V AC—Yellow
76811	76111	120V AC—Black
-	76162	12V DC—Yellow
-	76199	12V DC—Yellow (NiMH) Battery
76812	76112	12V DC—Black
76849	76149	12V DC—Black—(NiMH) Battery
-	76182	120V AC/DC 1 PiggyBack Holder—Yellow
76832	76132	120V AC/DC 1 PiggyBack Holder—Black
-	76185	120V AC/DC Fast Charge—2 holders—Yellow
76835	76135	120V AC/DC Fast Charge—2 holders—Black
-	76166	120V AC/DC Fast Charge—1 PiggyBack—Yellow
-	76116	120V AC/DC Fast Charge—1 PiggyBack—Black
-	76160	Without Charger—Yellow
-	76203	Without Charger—Yellow—(NiMH) Battery
76810	76110	Without Charger—Black
76850	76150	Without Charger—Black—(NiMH) Battery

## TRADITION SERIES



	HIGH	MEDIUM	LOW
<b>LUMENS:</b>	385	195	95
<b>CANDELA:</b>	26,000	13,000	6,500
<b>DISTANCE:</b>	322m	228m	161m
<b>RUN TIME:</b>	2h	3h 45m	7h 15m

Strobe mode: 5.5 hours of continuous run time



With **[(STROBE)]**  
Double tap switch to activate.

AVAILABLE IN BOTH DUAL SWITCH AND STANDARD STYLES

### Special Features:

- Scratch-resistant, unbreakable, O-ring sealed lens.
- IPX4-rated for water-resistance.
- 3 meter impact-resistance tested.

## STINGER<sup>®</sup> CLASSIC LED

So many people loved the size, shape and feel of the original Stinger xenon model that we updated it to a powerful, durable, rechargeable LED flashlight. It produces 390 lumens on high, a smooth beam and lots of peripheral light.

### STINGER CLASSIC LED

**BATTERY:** 3-cell, 3.6V NiCd sub-C. Available NiMH sub-C.

**SIZE:** 7.65" x 1.60" x 1.08"  
(19.43 x 4.06 x 2.74 cm)

**WEIGHT:** 11.1 oz (315 g)

**COLOR:** Black

NiCd	NiMH	
75662	-	with 120V AC/DC - 2 Holders
75663	-	with 120V AC
75664	75675	with 12V DC
75666	-	with 120V AC/DC - 1 PiggyBack Holder
75665	-	with 120V AC/DC Fast Charger - 2 Holders
75660	75661	without Charger



	HIGH	MEDIUM	LOW
<b>LUMENS:</b>	390	210	100
<b>CANDELA:</b>	13,200	6,500	3,100
<b>DISTANCE:</b>	230m	161m	111m
<b>RUN TIME:</b>	1h 45m	3h 45m	6h 45m

Strobe mode: 5 hours of continuous run time



With **[(STROBE)]**  
Double tap switch to activate.

### Special Features:

- IPX4-rated for water-resistance.
- 1 meter impact-resistance tested.

**STINGER  
ACCESSORIES**

*At Streamlight, we engineer the highest performing, most rugged, durable and innovative lights on the market. In addition, we support them with the accessories you can depend on and the options and configurations that you need to accommodate all your portable lighting needs.*

Stinger Accessories	DS LED HL LED HL	DS LED HPL LED HPL	DS LED LED	UltraStinger LED	PolyStinger LED HAZ-LO	PolyStinger LED / DS LED	Stinger Lite Pipe	Stinger Classic LED
 5 Unit Bank Charger	75400	75400	75400	75400	75400	75400	75400	75400
 5 Unit Bank Fast Charger	75401	75401	75401	75401	75401	75401	75401	75401
 2.5 hr Fast Charger	75103	75103	75103	75103	75103	75103	75103	75103
 Fast Piggyback® Charger	75276	75276	75276	-	75276	75276	75276	75276
 Steady Piggyback®	75275	75275	75275	-	75275	75275	75275	75275
 Li-Ion Battery Stick	75176	75176	75176	77175	75176	75176	75176	75176
 NiCd Battery Stick	-	75175	75175	-	75175	75175	75175	75175
 NiMH Battery Stick	75375	75375	75375	77375	-	75375	75375	75375
 12V Cig Charge Cord	22051	22051	22051	22051	22051	22051	22051	22051
 12V DC Charge Cord	22050	22050	22050	22050	22050	22050	22050	22050
 120V AC Charge Cord	22311	22311	22311	22311	22311	22311	22311	22311
 Leather Plain Holster	75133	-	75133	-	-	75133	-	75133
 Leather Weave Holster	75134	-	75134	-	-	75134	-	75134
 Std. Nylon Holster	75927	75927	75927	-	-	75910	-	75910
 Loop Nylon Holster	75928	75928	75928	75928	75928	75928	75928	75928
 Duty Holster	88053	88053	88053	88053	-	-	-	-
 Ring Holder	75906	75906	75906	75906	75906	75906	75906	75906
 Red Flip Lens	75115	-	75115	-	-	-	-	-
 Green Flip Lens	75117	-	75117	-	-	-	-	-
 Blue Flip Lens	75116	-	75116	-	-	-	-	-
Red Wand	75903	75946	75903	78903	-	75933	-	75933
White Wand	75908	75949	75908	78908	-	75938	-	75938
Blue Wand	75902	75947	75902	-	-	75932	-	75932
Yellow Wand	75904	75948	75904	78904	-	75934	-	75934
Glow Wand	75913	75950	75913	78913	-	75943	-	75943



# LITTLE

IN STATURE, BIG IN

# LIGHT.

## STRION LED HL®

The power of a Stinger in a more compact Lithium Ion rechargeable flashlight. It even fits long-gun mounts. Casts a bright white beam that spreads out to illuminate an entire area. You'll see what's in front of you and what may be hiding in the corners.

### STRION LED HL

**BATTERY:** Lithium-ion with on-board safety control circuit. 3.75V, 2200 mAh minimum.

**SIZE:** 5.90" x 1.25" x .95" (14.99 x 3.18 x 2.41 cm)

**WEIGHT:** 5.2 oz (148 g)

**COLOR:** Black or Kryptek® Highlander

### BLACK KRYPTEK® HIGHLANDER

74752	-	with 120V AC/12V DC - 2 holders
74751	-	with 120V AC/12V DC - 1 holder
74755	-	with 120V AC/12V DC - 1 holder
74778	74395	with 120V AC/12V DC - 1 PiggyBack
74753	-	with 120V AC
74754	-	with 12V DC
74750	74394	without Charger
74509	-	Strion LED HL with grip - with 120V AC

### HL SERIES

	HIGH	MEDIUM	LOW
<b>LUMENS:</b>	500	250	125
<b>CANDELA:</b>	10,000	5,000	2,500
<b>DISTANCE:</b>	200m	141m	100m
<b>RUN TIME:</b>	1h	2h	3h 30m

Strobe mode: 2h 30m of continuous run time

### 500 LUMENS



The Kryptek® Highlander pattern is specially designed for those geographical regions and elevations that are varied. Kryptek® Highlander increases stealth when pursuing a wide range of quarry in mixed terrain.



With **[(STROBE)]**  
Double tap switch to activate.

### Special Features:

- IPX4-rated for water-resistance.
- 2 meter impact-resistance tested.

**STRION® HPL**

	HIGH	MEDIUM	LOW
<b>LUMENS:</b>	615	320	160
<b>CANDELA:</b>	40,000	20,000	10,000
<b>DISTANCE:</b>	400m	283m	200m
<b>RUN TIME:</b>	1h	2h	3h 45m

Strobe mode: 2h 30m of continuous run time



**615 LUMENS**  
With **[(STROBE)]**  
Double tap switch to activate.

**Special Features:**

- Scratch-resistant, unbreakable, O-ring sealed lens.
- IPX4-rated for water-resistance.
- 2 meter impact-resistance tested.

**HPL SERIES**

Lightweight and ultra-compact, yet extremely powerful. It throws its long beam far out in the distance while casting plenty of peripheral light along the way. Features three intensities plus strobe. Rechargeable battery and powerful illumination result in one of the lowest operating costs of any flashlight. Easy, one-handed operation with multi-function push-button tailswitch.

**STRION HPL**

**BATTERY:** Lithium-ion with on-board safety control circuit. 3.75V, 2000m Ah minimum.

**SIZE:** 7" x 2.2" x .95"  
(17.78 x 5.59 x 2.41 cm)

**WEIGHT:** 7.1 oz (202 g)

**COLOR:** Black

**STRION HPL**

74501	with 120V AC/12V DC-1 Holder-Black
74502	with 120V AC/12V DC-2 Holders-Black
74503	with 120V AC-Black
74504	with 12V DC-Black
74500	without Charger-Black

**STRION® LED**

	HIGH	MEDIUM	LOW
<b>LUMENS:</b>	260	130	65
<b>CANDELA:</b>	10,000	5,000	2,500
<b>DISTANCE:</b>	200m	141m	100m
<b>RUN TIME:</b>	2h	4h	7h 30m

Strobe mode: 5h 30m of continuous run time



**260 LUMENS**  
With **[(STROBE)]**  
Double tap switch to activate.

**Special Features:**

- 2 meter impact-resistance tested.
- Anti-roll head.

**TRADITION SERIES**

A powerful value that's perfect for the broadest range of lighting needs. IPX4-rated for water-resistance. Optional model with adjustable ring provides a sure-grip for easy one-handed operation.

**STRION LED**

**BATTERY:** Lithium-ion with on-board safety control circuit. 3.75V, 2000m Ah minimum.

**SIZE:** 5.9" x 1.25" x .95"  
(14.99 x 3.18 x 2.41 cm)

**WEIGHT:** 5.2 oz (148 g)

**COLOR:** Black or Pink

**STRION LED**

74301	with 120V AC/12V DC-1 Holder-Black
74302	with 120V AC/12V DC-2 Holders-Black
74303	with 120V AC-Black
74304	with 12V DC-Black
74308	with 120V AC/12V DC-Black
74300	without Charger-Black
74309	with Grip Ring 120V AC-Black
74350	with 120V AC/12V DC-1 Holder-Pink

## STRION ACCESSORIES

Strion Accessories	STRION LED HL	STRION LED HPL	STRION LED
 6 Unit Bank Charger 120V	74400	74400	74400
 6 Unit Bank Charger DC	74401	74401	74401
 Piggyback® Charger Holder	74115	74115	74115
 Charger Holder	74102	74102	74102
 Li-ion Battery Stick	74175	74175	74175
 12V Cig Charge Cord	22051	22051	22051
 12V DC Charge Cord	22050	22050	22050
 120V AC Charge Cord	22311	22311	22311
 Rail Mount	74200	74200	74200
 Vertical Grip	69114	69114	69114
 Leather Plain Holster	74059	-	74059
 Leather Weave Holster	74060	-	74060
 Std. Nylon Holster	-	75910	-
 Nylon Option Holster	85905	-	85905
Tactical Holster	88051	88051	88051
Red Flip Lens	85115	-	85115
Green Flip Lens	85117	-	85117
Blue Flip Lens	85116	-	85116
Red Wand	74903	75946	74903
White Wand	-	75949	-
Blue Wand	74902	75947	74902
Yellow Wand	-	75948	-
Glow Wand	74913	75950	74913

REDUCE DOWNTIME,  
**DOUBLE**  
THE BATTERIES  
YOU HAVE ON HAND.

INTEGRATED  
USB PORT

NEW STRION®  
PIGGYBACK®  
CHARGER

STRION® PIGGYBACK® CHARGER – 74115

- Always Be Ready
- Charge via 12v DC, 120 AC or USB
- Quick and Convenient
- Charges Light & Spare Battery

**SL-20L** SERIES  
// STREAMLIGHT 2016



**SL-20L**®

Full-size, professional grade light that delivers the intense brightness and run times you need for a wide variety of jobs.

**SL-20L**

**BATTERY:** 5-cell, 6V NiCd sub-C. Available with NiMH sub-C.

**SIZE:** 13.1" x 2.5" x 1.5"  
(33.3 x 6.35 x 3.81 cm)

**WEIGHT:** 1 lb 11.2 oz (770 g)

**COLOR:** Black

NiCd	NiMH	
20603	20703	with 120V AC/DC-2 Sleeves-Black
20601	20701	with 120V AC-Black
20602	20702	with 12V DC-Black
20600	20700	without Charger-Black



With **[(STROBE)]**  
Double tap switch to activate.



	HIGH	MEDIUM	LOW
<b>LUMENS:</b>	350	160	10
<b>CANDELA:</b>	60,000	27,000	1,000
<b>DISTANCE:</b>	490m	329m	63m
<b>RUN TIME:</b>	2h	4h	50h

Strobe mode: 4 hours of continuous run time

**Special Features:**

- Unbreakable, scratch-resistant, O-ring sealed lens.
- IPX4-rated for water-resistance.
- 1 meter impact-resistance tested.

**SL ACCESSORIES**

Our legacy products remain available (i.e. SL-20X, SL-20XP)  
Please see [www.streamlight.com](http://www.streamlight.com) for our full product offering.



	5 Unit Bank Charger 120v	5 Unit Bank Charger DC	Charger Sleeve	12V Cig Charge Cord	12V DC Charge Cord	120V AC Charge Cord
SL-20L	21400	21401	22052	22051	22050	22311
SL-20LP	21400	21401	22052	22051	22050	22311

# A HISTORY OF PERFORMANCE, THE LEGENDARY FULL-SIZE DUTY LIGHT.

**SL-20LP®**

All the power and performance of our SL-20L® in a durable, nylon polymer lightweight housing.

**SL-20LP**

**BATTERY:** 5-cell, 6V NiCd sub-C. Available with NiMH sub-C.

**SIZE:** 13.2" x 2.5" x 1.5"  
(33.5 x 6.35 x 3.81 cm)

**WEIGHT:** 1 lb 4.8 oz (590 g)

**COLOR:** Black, Yellow or Orange

NiCd	NiMH	
25223	25323	with 120V AC/12V DC 2 Sleeves - Yellow
25203	25303	with 120V AC/12V DC 2 Sleeves - Black
25213	25313	with 120V AC/12V DC 2 Sleeves - Orange
25221	25321	with 120V AC - Yellow
25201	25301	with 120V AC - Black
25211	25311	with 120V AC - Orange
25222	25322	with 12V DC - Yellow
25202	25302	with 12V DC - Black
25212	25312	with 12V DC - Orange
25220	25320	without Charger - Yellow
25200	25300	without Charger - Black
25210	25310	without Charger - Orange



With **[(STROBE)]**  
Double tap switch to activate.

	HIGH	MEDIUM	LOW
<b>LUMENS:</b>	350	160	10
<b>CANDELA:</b>	60,000	27,000	1,000
<b>DISTANCE:</b>	490m	329m	63m
<b>RUN TIME:</b>	2h	4h	50h

Strobe mode: 4 hours of continuous run time

**Special Features:**

- Unbreakable, scratch-resistant, O-ring sealed lens.
- IPX4-rated for water-resistance.
- 1 meter impact-resistance tested.



	NiCd Battery Stick	NiMH Battery Stick	Ring Holder	Std. Nylon Holster	Red Wand	White Wand	Blue Wand	Yellow Wand	Glow in the Dark Wand
SL-20L	77175	77375	22911	25090	22511	22517	22512	22519	22513
SL-20LP	77175	77375	22911	25090	22511	22517	22512	22519	22513

BEAM STYLE

SPECS

HIGH MODE PERFORMANCE SHOWN.  
FOR PERFORMANCE IN OTHER  
MODES, SEE MODEL PAGES.

**PORTABLE SCENE LIGHT**

Pg. 26

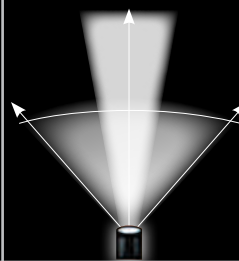

**OUTPUT:** 5,300 lumens  
**BEAM DISTANCE:** 410 meters  
**RUN TIME:** 4 hours  
**SIZE:** 22" x 6.5" x 11"  
(55.88 x 16.5 x 27.9 cm)  
**WEIGHT:** 25 lb (11.3 kg)  
**COLOR:** Yellow

**E-FLOOD® LITEBOX® HL**

Pg. 29



**HL SERIES**

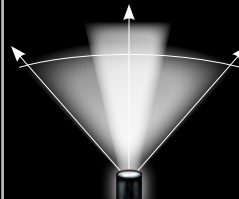

**OUTPUT:** 3,600 lumens  
**INTENSITY:** 31,000 candela  
**BEAM DISTANCE:** 352 meters  
**RUN TIME:** 2 hours  
**SIZE:** 12.3" x 5.1" x 7.7"  
(31 x 13 x 19 cm)  
**WEIGHT:** 10.4 lb (4.7 kg)  
**COLOR:** Orange

**E-FLOOD® LITEBOX®  
E-FLOOD® FIREBOX®**

Pg. 30



**OUTPUT:** 615 lumens  
**INTENSITY:** 4,000 candela  
**BEAM DISTANCE:** 126 meters  
**RUN TIME:** 8 hours  
**SIZE:** 11.5" x 5.1" x 7"  
(29.2 x 13 x 17.8 cm)  
**WEIGHT:** 7 lbs 14.4 oz (3.58 kg)  
**COLOR:** Orange, Yellow, or Beige

**E-SPOT® LITEBOX®  
E-SPOT® FIREBOX®**

Pg. 31

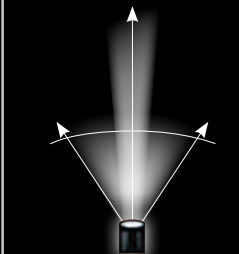

**OUTPUT:** 540 lumens  
**INTENSITY:** 55,000 candela  
**BEAM DISTANCE:** 469 meters  
**RUN TIME:** 7 hours  
**SIZE:** 11.5" x 5.1" x 7"  
(29.2 x 13 x 17.8 cm)  
**WEIGHT:** 7 lbs 14.4 oz (3.58 kg)  
**COLOR:** Orange, Yellow, or Beige

**FIRE VULCAN® LED**

Pg. 32

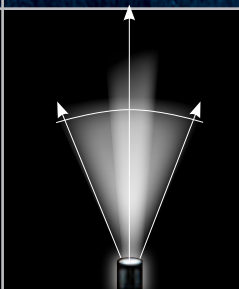

**OUTPUT:** 145 lumens  
**INTENSITY:** 80,000 candela  
**BEAM DISTANCE:** 566 meters  
**RUN TIME:** 3 hours  
**SIZE:** 7.5" x 5" x 6.5"  
(19.05 x 12.7 x 16.51 cm)  
**WEIGHT:** 1 lb 13.6 oz (839 g)  
**COLOR:** Orange

**HID LITEBOX®**

Pg. 27

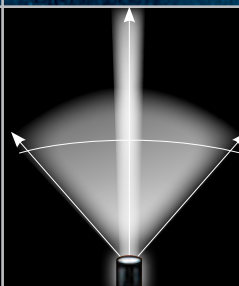

**OUTPUT:** 3,350 lumens  
**INTENSITY:** 1,000,000 candela  
**BEAM DISTANCE:** 2,000 meters  
**RUN TIME:** 1.75 hours  
**SIZE:** 14.9" x 5.1" x 8.8"  
(38 x 13 x 23 cm)  
**WEIGHT:** 10 lbs 1.6 oz (4.6 kg)  
**COLOR:** Orange or Black





**LANTERN** SERIES  
// STREAMLIGHT 2016



PORTABLE SCENE LIGHT:

# PORTABILITY. DEPLOYABILITY. PERFORMANCE.

## PORTABLE SCENE LIGHT

Our Portable Scene Light provides rapid deployment on site, and it goes anywhere. With its 90° swivel neck, it's easy to shine light into the most out-of-the-way place. Equipped with a high-performance light head, identical to the E-Flood® HL, that extends to 72" within seconds. It provides 3 levels of lighting and substantial run time to last through several shifts, even days. The unique diffuser lets you select a flood or spot beam in all three levels. It's designed to adapt to tight spaces, but rugged enough to be stable in wide open terrain or steps. The regulated light provides consistent output throughout the life of the battery. It's an indispensable tool for first responders, construction crews, and utility workers.

### PORTABLE SCENE LIGHT

**BATTERY:** Zero-maintenance 12V, 14.4 Ah sealed lead acid. Can also be powered by 12V DC or AC power cord.

**SIZE:** 22" x 6.5" x 11"  
(55.88 x 16.5 x 27.9 cm)

**WEIGHT:** 25 lb (11.3 kg)

**COLOR:** Yellow

### PORTABLE SCENE LIGHT

45670 120V AC/12V DC Portable Scene Light - Yellow



	HIGH	MEDIUM	LOW
<b>LUMENS:</b>	5,300	2,500	1,300
<b>DISTANCE:</b>	410m	292m	215m
<b>RUN TIME:</b>	4h	9h	18h

/// UPDATED FOR 2016



### HL SERIES

Full extension to 72" with the stabilization legs fully deployed and locked in less than 30 seconds

Cord is built into the pole avoiding snags during deployment

Balanced design; lead acid batteries and integrated legs provide ballast and stability

### Special Features:

- IP67 rated; dust-tight and waterproof to 1 meter for 30 minutes.
- Pole extends to 72"; cord built into pole to avoid snags.
- Runs on AC or DC power source.



**THE HID LITEBOX:  
THE POWER  
TO LIGHT AN  
ENTIRE SCENE.**

**HID LITEBOX**<sup>®</sup>

This portable, one million candela searchlight illuminates objects up to a mile away. Its 35-watt, high intensity xenon lamp has a 3,000-hour minimum lifetime and a 90° swivel head. The intense brightness and amazing 1-mile reach make this the ideal hand-held light when you absolutely must be able to inspect an entire area quickly and efficiently. It plugs into your vehicle's power source for an unlimited run time.

**HID LITEBOX**

**BATTERY:** Zero-maintenance 12V, 7.2 Ah sealed lead acid

**SIZE:** 14.9" x 5.1" x 8.8"  
(38 x 13 x 23 cm)

**WEIGHT:** 10 lbs 1.6 oz (4.6 kg)

**COLOR:** Orange or Black

**ORANGE    BLACK**

45601	45621	w/ 120V AC/12V DC includes shoulder strap and flood lens
45600	45620	without Charger includes shoulder strap and flood lens
45605	45625	Vehicle Mount System with 12V DC includes shoulder strap and flood lens



	<b>HIGH</b>
<b>LUMENS:</b>	3,350
<b>CANDELA:</b>	1,000,000
<b>RUN TIME:</b>	1h 45m



10 ft (3 meters) 12V DC power cord plugs into port at rear of light to provide duration lighting

HID LiteBox battery will continue to charge while operating directly from an external 12V DC power source when using the remote cord



Swivel neck shown in 90° position.



Swivel neck shown in 45° position.



THE E-FLOOD HL  
DELIVERS **FULL**  
**ILLUMINATION**  
**FLOOD OR SPOT.**

**E-FLOOD® LITEBOX® HL**

The intense brightness of its 3600 lumens stretches from side to side and floods an entire area with light. Unique diffuser lets you select from a flood and spot lens in all three lighting modes. 90° swivel neck lets you aim light where it's needed. Ideal for illuminating a rescue scene, an entire plant floor or any site that requires a large flood beam. The portability and full illumination is perfect for underground construction.

**E-FLOOD LITEBOX HL**

**BATTERY:** Zero-maintenance 12V, 4.4 Ah sealed lead acid. Can also be powered by 12V DC power cord.

**SIZE:** 12.3" x 5.1" x 7.7"  
(31 x 13 x 19 cm)

**WEIGHT:** 10.4 lb (4.7 kg)

**COLOR:** Orange

**E-FLOOD HL LITEBOX**

45661 120V AC/12V DC, shoulder strap & mounting rack - Orange

45665 Vehicle Mount System, 12V DC direct wire rack, shoulder strap - Orange

45660 without Charger - includes shoulder strap - Orange

	HIGH	MEDIUM	LOW
<b>LUMENS:</b>	3,600	2,400	1,200
<b>CANDELA:</b>	31,000	20,000	11,000
<b>DISTANCE:</b>	352m	283m	210m
<b>RUN TIME:</b>	2h	4h	8h

**HL SERIES**



**NFPA**

Rack meets requirements of NFPA 1901-14.1.11.2 (2003) mounted in any position



**Special Features:**

- Six super-bright C4® LEDs
- Unbreakable, scratch-resistant, O-ring sealed lens.
- Provides regulated light output throughout battery life.

Our legacy products remain available. Please see [www.streamlight.com](http://www.streamlight.com) for our full product offering.



**E-FLOOD® LITEBOX®**  
**E-FLOOD® FIREBOX®**

Six C4® LEDs spread light over an entire area. It has an extended run time - 18 hrs. on low - so you can keep large areas illuminated no matter how long your shift lasts. With its swivel head, you can point light right where it's needed. The FireBox has 2 rear blue LEDs so you can be seen from behind: a life-saving feature for firefighters!

**E-FLOOD LITEBOX / E-FLOOD FIREBOX**

**BATTERY:** Zero-maintenance 6V, 12 Ah sealed lead acid

**SIZE:** 11.5" x 5.1" x 7"  
(29.2 x 13 x 17.8 cm)

**WEIGHT:** 7 lbs 14.4 oz (3.58 kg)

**COLOR:** Orange, Yellow or Beige (Power Failure model only)

**E-FLOOD LITEBOX**

- 45801 120V AC/12V DC, shoulder strap and mounting rack—Orange
- 45821 120V AC/12V DC, shoulder strap and mounting rack—Yellow
- 45805 Vehicle Mount System with 12V DC, shoulder strap—Orange
- 45825 Vehicle Mount System with 12V DC, shoulder strap—Yellow
- 45807 Power Failure w/120V AC/12V DC Chargers, mounting rack—Orange
- 45817 Power Failure w/120V AC/12V DC Chargers, mounting rack—Beige
- 45806 without Charger - with shoulder strap—Orange
- 45816 without Charger - Power Failure with shoulder strap—Beige
- 45826 without Charger - with shoulder strap—Yellow

**E-FLOOD FIREBOX**

- 45811 120V AC/12V DC, dual rear LEDs, strap, mounting rack—Orange
- 45815 Vehicle Mount System w/DC, dual rear LEDs, shoulder strap—Orange
- 45832 without Charger incl. shoulder strap—dual rear LEDs—Orange



	HIGH	LOW
<b>LUMENS:</b>	615	330
<b>CANDELA:</b>	4,000	2,150
<b>DISTANCE:</b>	126m	93m
<b>RUN TIME:</b>	8h	18h

**NFPA**

Rack meets requirements of NFPA 1901-14.1.11.2 (2003) mounted in any position



E-Flood FireBox includes dual rear LEDs.



The Power Failure System features "Smart" power failure circuitry which automatically illuminates the light when the power goes off

THE E-FLOOD & E-SPOT SERIES ARE ABOUT  
**DELIVERING**  
**THE RIGHT LIGHT**  
**EXACTLY WHERE**  
**YOU NEED IT.**

**E-SPOT® LITEBOX®**  
**E-SPOT® FIREBOX®**

Three C4® LEDs spotlight an area with focused bright light so you can search or inspect from a distance. Its beam has more of a hotspot than the E-Flood, providing more concentrated, brighter light. Its swivel head makes it easy to inspect high bays, ceilings, and out-of-the-way places. IPX4-rated for water-resistance. Optimized electronics provide regulated intensity. Unbreakable, scratch-resistant lens.

**E-SPOT LITEBOX / E-SPOT FIREBOX**

**BATTERY:** Zero-maintenance 6V, 12 Ah sealed lead acid

**SIZE:** 11.5" x 5.1" x 7"  
 (29.2 x 13 x 17.8 cm)

**WEIGHT:** 7 lbs 14.4 oz (3.58 kg)

**COLOR:** Orange, Yellow or Beige (Power Failure model only)

**E-SPOT LITEBOX**

- 45851 120V AC/12V DC, shoulder strap and mounting rack—Orange
- 45871 120V AC/12V DC, shoulder strap and mounting rack—Yellow
- 45855 Vehicle Mount System with 12V DC, shoulder strap—Orange
- 45875 Vehicle Mount System with 12V DC, shoulder strap—Yellow
- 45857 Power Failure System, shoulder strap and mounting rack—Orange
- 45867 Power Failure System, shoulder strap and mounting rack—Beige
- 45856 without Charger - with shoulder strap—Orange
- 45866 without Charger - Power Failure with shoulder strap—Beige
- 45876 without Charger - with shoulder strap—Yellow

**E-SPOT FIREBOX**

- 45861 120V AC/12V DC, dual rear LEDs, strap, mounting rack—Orange
- 45865 Vehicle Mount System w/DC, dual rear LEDs, shoulder strap—Orange
- 45882 without Charger incl. shoulder strap—dual rear LEDs—Orange

	HIGH	LOW
<b>LUMENS:</b>	540	330
<b>CANDELA:</b>	55,000	32,000
<b>DISTANCE:</b>	469m	358m
<b>RUN TIME:</b>	7h	15h

**NFPA**

Rack meets requirements of NFPA 1901-14.1.11.2 (2003) mounted in any position

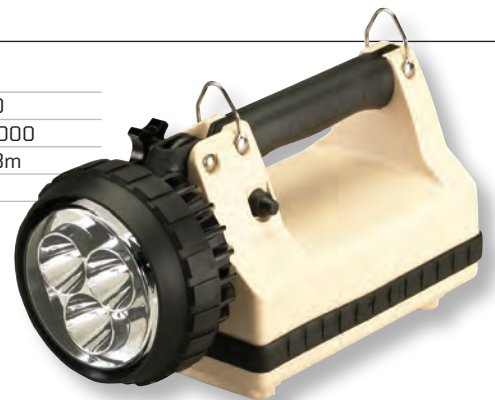

Power Failure System



E-Spot FireBox includes dual rear LEDs.





**FIRE VULCAN® LED**

This lightweight lantern with taillight LEDs helps you be seen even in thick smoke. It's IPX7-rated for water resistance to 1 meter for 30 minutes. It even floats! Delivers regulated, consistent light throughout battery life. The light modes are programmable, so you can control the order in which the modes come on. Features an unbreakable, scratch-resistant, O-ring sealed lens.

**FIRE VULCAN LED**

**BATTERY:** 2 lightweight Lithium-ion nanotechnology cells

**SIZE:** 7.5" x 5" x 6.5"  
(19.05 x 12.7 x 16.51 cm)

**WEIGHT:** 1 lb 13.6 oz (839 g)

**COLOR:** Orange

44450 Standard System with 120V AC/12V DC—Orange

44451 Vehicle Mount with 12V DC—Orange

44454 without Charger—Orange



Class I, Div. 2, Groups A, B, C, D;  
Class II, Div. 2, Groups F, G;  
Class III T-Code: T4

**NFPA**

Rack meets requirements  
of NFPA 1901-14.1.11.2  
(2003) mounted in  
any position

	HIGH	LOW
<b>LUMENS:</b>	145	70
<b>CANDELA:</b>	80,000	40,000
<b>RUN TIME:</b>	3h	7h



Ultra-bright blue tail light LEDs make certain you can be seen, even in thick smoke.



**TWO FIRE VULCAN® LED MODELS:**















**Standard System:** Includes charging rack and both AC and DC chargers.

**Vehicle Mount System:** Includes 12V DC vehicle-mountable, direct-wire charging rack.



## LANTERN SERIES ACCESSORIES

At Streamlight, we engineer the highest performing, most rugged, durable and innovative lights on the market. In addition, we support them with the accessories you can depend on and the options and configurations that you need to accommodate all your portable lighting needs.

Lantern Accessories	PORTABLE SCENE LIGHT	HID LITEBOX	E-FLOOD LITEBOX HL	E-FLOOD LITEBOX / FIREBOX	E-SPOT LITEBOX / FIREBOX	FIRE VULCAN LED
 Standard Charge Rack	-	-	-	-	-	44101-Orange
 Direct Wire 12V DC Charge Rack	-	-	-	-	-	44131-Orange
 Standard Mounting Rack	-	45070-Orange 45075-Black	45070-Orange 45072-Yellow 45071-Beige	45070-Orange 45072-Yellow 45071-Beige	45070-Orange 45072-Yellow 45071-Beige	-
 Vehicle Mounting Rack	-	45071-Orange 45074-Yellow	45071-Orange 45074-Yellow	45071-Orange 45074-Yellow	45071-Orange 45074-Yellow	-
 12V CIG Charge Cord	-	22051	22051	22051	22051	22051
 12V DC Charge Cord	-	22050	22050	22050	22050	22050
 12V DC Charge Cord (10ft / 3m)	22056	22056	-	-	-	-
 120 AC Charge Cord	-	22665 - For HID	22665	22311	22312	22312
 E-Spot Upgrade for LiteBox/FireBox	-	-	-	45845	45845	-
 E-Flood Upgrade for LiteBox/FireBox	-	-	-	45842	45842	-
 HID LiteBox Lens/Filters	-	45637-HID Bulb Kit 45638-Lens Refl. Assy. 45657-Flood Lens 45654-IR Filter	-	-	-	-
 Shoulder Strap	44050	44050	44050	44050	44050	44050
 Quick Release Shoulder Strap	45232	45232	45232	45232	45232	45232
 Replacement Battery	45630	45630	45630	45937	45937	44610



**WAYPOINT®**



Trigger style switch with momentary operation.

This long-distance, pistol-grip lantern is the light you need to inspect a power line from the ground, find a dock from the interior of a lake or to see whatever lies up ahead. Its beam reaches about the length of 6 football fields! It also has plenty of peripheral light, so you can see what's all around you. Set it down to illuminate an entire area or aim it to check on trees or power lines far away. This next generation alkaline model features 3 modes including an emergency signal mode.

**WAYPOINT**

**BATTERY:** 4 "C" batteries (not included). Can also be powered by 12V DC power cord (included)

**SIZE:** 6.75" x 7.14" x 3.5"  
(17.15 x 18.14 x 8.89 cm)

**WEIGHT:** 1 lb 12.8 oz (816 g)

**COLOR:** Yellow or Black

**YELLOW    BLACK**

44900	44902	12V DC power cord* - w/polymer storage mount
44904	44905	12V DC power cord*

**ACCESSORIES**

44908	44908	Polymer Storage Mount
44903	44903	12V DC power cord
44924	44924	Red Filter
44925	44925	Green Filter

\*12V DC power cord does not recharge batteries

**550 LUMENS**

	HIGH	LOW
<b>LUMENS:</b>	550	40
<b>CANDELA:</b>	100,000	7,900
<b>DISTANCE:</b>	625m	178m
<b>RUN TIME:</b>	10h	82h



Unlimited run time when using 12V DC power cord. Emergency signal run time 82 hours.

The Waypoint holder allows for secure storage (included with product and also offered as an accessory).



Green Filter reduces shadows.

Red Filter preserves night vision.



**Special Features:**

- Unbreakable, O-ring sealed polycarbonate lens.
- IPX4-rated for water-resistance.
- 1 meter impact-resistance tested.
- Integrated stand for hands-free scene lighting.

# WAYPOINT RECHARGEABLE... 5 FEET OF CHARGING CORD 1,800 FEET OF LIGHT.



**WAYPOINT® RECHARGEABLE**

The rechargeable model has a broad, wide beam. It spreads bright light across a whole room, campsite or backyard illuminating everything, yet its beam still reaches an impressive 678 meters. IPX8-rated design waterproof to 2 meters. Light floats if dropped in water. Includes 3 modes: low, medium and high. With its integrated stand you can set it up for easy area illumination. Fully recharges in 4 hours.

#### WAYPOINT RECHARGEABLE

**BATTERY:** Lithium Ion with on-board safety control circuit

**SIZE:** 6.75" x 7.14" x 3.62"  
(17.15 x 18.14 x 9.29 cm)

**WEIGHT:** 1 lb 8.32 oz (691 g)

**COLOR:** Yellow or Black

#### YELLOW BLACK

44910 44911 with 120V AC charge cord

#### ACCESSORIES

44918 44918 Polymer Storage Mount

44915 44915 Red Filter

44916 44916 Green Filter

44923 44923 12V DC charge cord

44909 44909 120V AC charge cord



#### 1,000 LUMENS

	HIGH	MEDIUM	LOW
<b>LUMENS:</b>	1,000	550	35
<b>CANDELA:</b>	115,000	60,000	10,000
<b>DISTANCE:</b>	678m	490m	200m
<b>RUN TIME:</b>	3h	6h	80h

Emergency signal run time 35 hours.

#### Special Features:

- Unbreakable, O-ring sealed lens.
- IPX8-rated for water-resistance.
- 1 meter impact-resistance tested.
- Integrated stand for hands-free scene lighting.



Includes 120V AC Charge Cord.



Green Filter reduces shadows.

Red Filter preserves night vision.



12V Charge Cord.



The Waypoint rechargeable holder allows for secure storage (included with product and also offered as an accessory).

THE MOST VERSATILE LANTERN FAMILY  
WELCOMES THE HARDEST  
**WORKING**  
SIEGE LANTERN.



**SUPER SIEGE® LANTERN**

The Super Siege® Lantern features five C4® power LEDs, one white and four red with six output modes and a battery level indicator built into the on/off button. An 8800 mAh rechargeable lithium ion battery supplies the power for the lantern as well as enabling you to recharge all your electronic devices from the handy USB port. With the outer lantern globe in place, the light will float. Use the lantern with or without the outer globe cover. Remove the outer globe and hang the body upside down by the D ring for large area lighting needs. Utilize the included Glare Guard™ to shield light from 1/2 the globe, allowing you to direct light on your work zone. A small storage area is provided in the base of the light for all your “keep dry” needs. Simply rotate the bottom cover counter clock wise to remove and access the storage compartment.

**SUPER SIEGE**

**BATTERY:** Rechargeable 8800 mAh Lithium Ion battery  
**SIZE:** 3.8" x 7.5" (9.65 x 19.05 cm)  
**WEIGHT:** 1 lb 14 oz (867 g)  
**COLOR:** Coyote or Yellow

44947 Super Siege Lantern w/ AC power cord—Coyote  
44945 Super Siege Lantern w/ AC power cord—Yellow

(1) WHITE C4 LED	HIGH	MEDIUM	LOW
<b>LUMENS:</b>	1,100	550	125
<b>RUN TIME:</b>	5h	10.5h	35h

Light output with outer globe removed.

(4) RED LEDs	HIGH	FLASH/SOS MODE	LOW
<b>LUMENS:</b>	2.7	2.7	1
<b>RUN TIME:</b>	110h	230h	288h

**NEW FOR 2016**  
**1,100 LUMENS**



With **((RED SOS))**  
Hold on/off button to activate.



A small dry storage area is provided in the lights base for all your “keep dry” needs



8800 mAh rechargeable lithium ion battery supplies the power for the lantern as well as enabling you to recharge all your electronic devices from the handy USB port

**Special Features:**  
- IPX7-rated waterproof to 1 meter.

## THE SIEGE® LANTERN

The Siege is brighter, more durable, and much more versatile than other emergency/camping lanterns. It's bright enough to light up a whole campsite. It runs for over 30 hours on high, and over 12 days on low! Its handle and D-rings allow you to hang it or clip it almost anywhere, upright or inverted. It has 3 white light setting, a red light for softer, less intense light, and an SOS mode. Remove the top for brighter light. Battery indicator flashes to alert you to low battery.

### THE SIEGE

**BATTERY:** (3) "D" size alkaline

**SIZE:** 3.8" x 7.25"  
(9.65 x 18.41 cm)

**WEIGHT:** 1 lb 15 oz (878 g)

**COLOR:** Coyote

44931 The Siege Lantern—Coyote

(4) WHITE C4 LEDs	HIGH	MEDIUM	LOW
<b>LUMENS:</b>	340	175	33
<b>RUN TIME:</b>	30h	70h	295h

Light output with outer globe removed.

(1) RED LED	HIGH	FLASH/SOS MODE
<b>LUMENS:</b>	10	10
<b>RUN TIME:</b>	235h	430h

### Special Features:

- Floats for easy retrieval.
- Waterproof to 1 meter.
- 2 meter impact-resistance tested.
- Unbreakable polycarbonate lens.
- Rugged, non-slip base.

Versatile design features Shown with outer  
rugged carry handle and globe removed.  
D-rings clip to hang  
virtually anywhere.



With **[(RED SOS)]**  
Hold on/off button to activate.

## SIEGE® AA LANTERN

The Siege® AA lantern features one C4® power LED, and two red LEDs (Blue model has blue LEDs). There are five output modes and a battery level indicator built into the on/off button. With the outer lantern globe in place, the light will float. Use the lantern with or without the outer globe cover. Remove the outer globe and hang the body upside down by the D ring for large area lighting needs. Battery indicator flashes to alert you to low battery. Battery replacement is a breeze with the center post orienting the battery cover correctly every time.

### SIEGE AA

**BATTERY:** (3) "AA" size alkaline

**SIZE:** 2.37" x 5.44" (6.00 x 13.82 cm)

**WEIGHT:** 8.8 oz (249.47 g)

**COLOR:** Coyote, Yellow, Pink or Blue

44941 Siege AA Lantern—Coyote

44943 Siege AA Lantern—Yellow w/magnetic base

44944 Siege AA Lantern—Pink

44949 Siege AA Lantern—Blue

### SIEGE AA ACCESSORY

44942 Magnetic Base—Coyote

WHITE C4 LED	HIGH	MEDIUM	LOW
<b>LUMENS:</b>	200	100	50
<b>RUN TIME:</b>	7h	15h 30m	37h

Light output with outer globe removed.

(2) RED LEDs	HIGH	FLASH/SOS MODE
<b>LUMENS:</b>	.7	.7
<b>RUN TIME:</b>	192h	288h

### Special Features:

- Floats for easy retrieval.
- Waterproof to 1 meter.
- 2 meter impact-resistance tested.
- Unbreakable polycarbonate lens.
- Rugged, non-slip base.



The yellow Siege AA has three strong magnets in the base. It's now a versatile, hands-free work light that can be attached to steel surfaces like engines, machines, or other equipment.



With **[(SOS)]**  
Hold on/off button to activate.



**NEW FOR 2016**











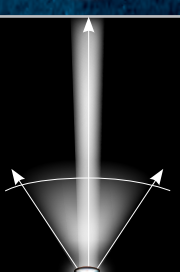

USE THIS EASY COMPARISON CHART TO CHOOSE THE BEST LIGHT FOR YOU BASED ON THE FEATURES THAT YOU NEED!

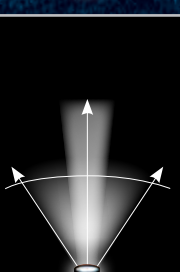
BEAM STYLE

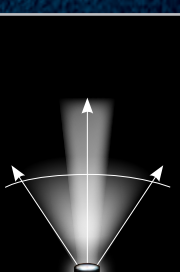
SPECS

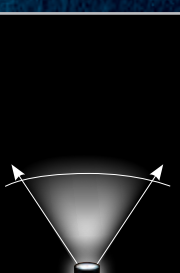
HIGH MODE PERFORMANCE SHOWN. FOR PERFORMANCE IN OTHER MODES, SEE MODEL PAGES.

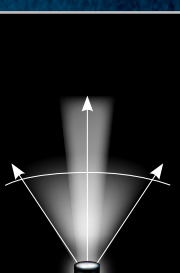
<p><b>SURVIVOR®</b> <b>RECHARGEABLE</b> Pg. 41</p> 		<p><b>OUTPUT:</b> 175 lumens <b>INTENSITY:</b> 41,000 candela <b>BEAM DISTANCE:</b> 405 meters <b>RUN TIME:</b> 3 hours 30 min <b>SIZE:</b> 7.06" x 2.85" x 2.87" (17.92 x 7.24 x 7.29 cm) <b>WEIGHT:</b> 18 oz (510 g) <b>COLOR:</b> International Safety Orange, High-Visibility Yellow, or Black</p>
<p><b>SURVIVOR®</b> <b>ALKALINE</b> Pg. 41</p> 		<p><b>OUTPUT:</b> 175 lumens <b>INTENSITY:</b> 41,000 candela <b>BEAM DISTANCE:</b> 405 meters <b>RUN TIME:</b> 4 hours <b>SIZE:</b> 7.06" x 2.85" x 2.87" (17.92 x 7.24 x 7.29 cm) <b>WEIGHT:</b> 13.7 oz (388 g) <b>COLOR:</b> International Safety Orange, High-Visibility Yellow, or Black</p>
<p><b>VANTAGE®</b> Pg. 43</p> 		<p><b>OUTPUT:</b> 115 lumens <b>INTENSITY:</b> 7,000 candela <b>BEAM DISTANCE:</b> 167 meters <b>RUN TIME:</b> 6 hours <b>SIZE:</b> 3.26" x 1.47" x 2.56" (8.28 x 3.73 x 6.5 cm) <b>WEIGHT:</b> 5.14 oz (145.7 g) <b>COLOR:</b> Black, Green or Red</p>
<p><b>POLYTAC 90®</b> Pg. 42</p> 		<p><b>OUTPUT:</b> 170 lumens <b>INTENSITY:</b> 7,000 candela <b>BEAM DISTANCE:</b> 167 meters <b>RUN TIME:</b> 3 hours 45 min <b>SIZE:</b> 5.22" x 1.25" x 1" (13.3 x 3.18 x 2.54 cm) <b>WEIGHT:</b> 4.1 oz (116 g) <b>COLOR:</b> Black, Yellow, or Orange</p>
<p><b>KNUCKLEHEAD®</b> <b>FLOOD</b> Pg. 45</p> 		<p><b>OUTPUT:</b> 200 lumens <b>INTENSITY:</b> 1,150 candela <b>BEAM DISTANCE:</b> 68 meters <b>RUN TIME:</b> 3 hours 30 min <b>SIZE:</b> 9.2" x 2.85" x 2.75" (23.4 x 7.2 x 7 cm) <b>NiCd WEIGHT:</b> 1 lb 7.1 oz (655 g) <b>ALKALINE WEIGHT:</b> 1 lb 2.3 oz (519 g) <b>COLOR:</b> International Safety Orange, High-Visibility Yellow, or Black</p>
<p><b>KNUCKLEHEAD®</b> <b>SPOT</b> Pg. 45</p> 		<p><b>OUTPUT:</b> 180 lumens <b>INTENSITY:</b> 11,000 candela <b>BEAM DISTANCE:</b> 210 meters <b>RUN TIME:</b> 3 hours 30 min <b>SIZE:</b> 9.2" x 2.85" x 2.75" (23.4 x 7.2 x 7 cm) <b>NiCd WEIGHT:</b> 1 lb 7.1 oz (655 g) <b>ALKALINE WEIGHT:</b> 1 lb 2.3 oz (519 g) <b>COLOR:</b> International Safety Orange, High-Visibility Yellow, or Black</p>

**RIGHT ANGLE SERIES**  
**// STREAMLIGHT 2016**

**RIGHT ANGLE** SERIES  
// STREAMLIGHT 2016



The new, low profile Survivor shown at actual size.

**SURVIVOR ACCESSORIES**

Battery Chargers	Fits All	Battery Packs	Fits All	Charge Cords	PN
Steady Charger Plug-In Charger Holder	90010	Alkaline Battery Cartridge	90542	120V AC	22311
Steady Charger PiggyBack® Charger	90110	Battery Pack Assembly-LED Div. 1	90130	12V DC Cigarette Lighter	22051
AC Fast Charger (Includes Holder)	90011	Battery Pack Assembly-LED Div. 2	90338	12V DC Direct Wire	22050
AC PiggyBack® Fast Charger	90111				
DC#1 Cigarette Lighter Cord/Fast Charger (Includes Holder)	90012				
DC#1 Cigarette Lighter PiggyBack® Fast Charger	90112				
DC#2 Direct Wire Cord/Fast Charger (Includes Holder)	90113				
120V AC Bank Charger	90400				
12V DC Bank Charger	90401				



# THE MOST TRUSTED RIGHT ANGLE LIGHT, JUST GOT THINNER, BRIGHTER & MORE VERSATILE. THE NEW SURVIVOR.

**SURVIVOR®**

The leading Class I, Div. 1 right angle, clip-on flashlight has been redesigned with a slimmer profile and a new clip/hook for more accurate light orientation. 4 light modes include high, low, flash, and a moonlight mode for low-level lighting that runs for 20 days. Spring-loaded clip easily attaches to belts and harnesses. Comes with two special, interchangeable Smoke Cutter® plugs that help create your preferred beam pattern: Black plug significantly reduces peripheral light for a tighter beam while the Amber plug reduces peripheral light and eye fatigue caused by glare. Available in alkaline and rechargeable models.

All openings are O-ring sealed for weather-resistance. IPX4-rated water-resistant. 2 meter impact resistance tested. Unbreakable, scratch-resistant polycarbonate lens. Designed for easy operation even with heavy gloves.

## SURVIVOR

**BATTERY:** Rechargeable NiCd 4.8V, 1.8 Ah, 4-cell sub-C or (4) "AA" Alkaline depending on model selected

**SIZE:** 7.6" x 2.85" x 2.87"  
(17.92 x 7.24 x 7.29 cm)

**NiCd WEIGHT:** 18 oz (510 g)

**ALKALINE WEIGHT:** 13.7 oz (388 g)

**COLOR:** Orange, Yellow, or Black

YELLOW	ORANGE	BLACK	
90513	90503	90523	w/Charger/ Holders 120V AC/DC cords
90512	90502	90522	with 120V AC Fast Charger
90519	90509	90528	with 12V DC Fast Charger
90510	90500	90520	without Charger
90541	90540	90545	Alkaline



Alkaline battery cartridge holds four "AA" alkaline batteries.



NICD MODEL	HIGH	LOW
<b>LUMENS:</b>	175	60
<b>CANDELA:</b>	41,000	14,000
<b>DISTANCE:</b>	405m	237m
<b>RUN TIME:</b>	3h 30m	13h

Moonlight mode: 20 days of continuous run time  
Flash runs 8 hours

ALKALINE MODEL	HIGH	LOW
<b>LUMENS:</b>	175	60
<b>CANDELA:</b>	41,000	14,000
<b>DISTANCE:</b>	405m	237m
<b>RUN TIME:</b>	4h	15h

Moonlight mode: 20 days of continuous run time  
Flash runs 8 hours

**NFPA** Rack meets requirements of 1901-14.1.11.2 (2003) mounted in any position



Class I & II, Division 1, Groups C,D,E,F,G;  
Class III, T4  
Class I, Division 2, Groups A,B,C,D; T4

Interchangeable Smoke Cutter® plugs:



Black reduces peripheral light for a tighter beam

Amber reduces peripheral light and eye fatigue caused by glare



Clip/hook design for accurate light orientation



**POLYTAC 90®**

Versatile, right angle compact flashlight can clip on to turn-out gear or be used as a headlamp. It's super bright, extremely durable in a nylon polymer housing and can be operated easily with gloves. 3 modes include a strobe function. 90° swiveling head. 1 meter impact resistance tested. IPX7 rated design; waterproof to 1 meter for 30 minutes. Integrated carabiner style D-ring for a variety of attachment methods. Versatile clip allows a variety of mounting positions. Maximum light output throughout battery life.

**POLYTAC 90**

**BATTERY:** (2) 3V CR123A Lithium batteries

**SIZE:** 5.22" x 1.25" x 1"  
(13.3 x 3.18 x 2.54 cm)

**WEIGHT:** 4.1 oz (116 g)

**COLOR:** Black, Yellow or Orange

**YELLOW ORANGE BLACK**

88831	88834	88830	with lithium batteries
-	88832	-	with lithium batteries & Gear Keeper

**ACCESSORIES**

88833	88833	88833	Gear Keeper®
14059	14059	14059	Elastic Headstrap - Coyote

Gear Keeper® makes your job easier while preventing loss of light.

	HIGH	LOW
<b>LUMENS:</b>	170	17
<b>CANDELA:</b>	7,000	700
<b>DISTANCE:</b>	167m	53m
<b>RUN TIME:</b>	3h 45m	30h

Strobe runs 6 hours



Gear Keeper® Tether features spectra nylon line with 36" extension and 6 oz. retraction force.



Headstrap



# WHEN IT COMES TO RIGHT ANGLE & HELMET LIGHTING THERE'S ALWAYS MORE THAN ONE RIGHT ANSWER.

## VANTAGE®

The solution to firefighters' hands-free lighting needs. Attaches easily to helmets and hard hats, and rotates 360°. Fits snugly against helmet to prevent snags. Includes a bright tail light so you can be seen from behind even in heavy smoke (blue on black & red models, green on green model). Easy to operate with gloves. Fits both traditional and modern helmets.

### VANTAGE

**BATTERY:** (2) 3V CR123A lithium

**SIZE:** 3.26" x 1.47" x 2.56"  
(8.28 x 3.73 x 6.5 cm)

**WEIGHT:** 5.14 oz (145.7 g)

**COLOR:** Black, Green or Red

69140 Vantage LED Tactical Helmet Light – Black

69189 Vantage LED Tactical Helmet Light – Green

69157 Vantage LED Tactical Helmet Light – Red

85175 Lithium Batteries – 2 Pack

**NFPA** Meets requirements of NFPA 1971-8.6 (2007); 500° heat resistance test

**CE** Meets applicable European Community Directives

**LUMENS:** 115  
**CANDELA:** 7,000  
**DISTANCE:** 167m  
**RUN TIME:** 6h

Dual direction, easy access on/off switch.



470nm ultra-bright tail light LED.



Congress created the National Fallen Firefighters Foundation to lead a nationwide effort to honor America's fallen firefighters. Since 1992, the non-profit foundation has developed and expanded programs that fulfill that mandate. Their mission is to honor and remember America's fallen fire heroes and to provide resources to assist their survivors in rebuilding their lives. For more information, visit [www.firehero.org](http://www.firehero.org).



## STREAMLIGHT TECHNOLOGY: PRODUCT-SPECIFIC DESIGN ALLOWS YOU TO TARGET THE BEAM.

### MOUNTING VERSATILITY:

Clamp the Vantage® light with C4® technology onto any traditional or modern firefighter's helmet or hard hat. It rotates and can be clamped above or below the brim.





WHETHER YOU'RE WORKING ON THE FLOOR  
**OR OVERHEAD, THE  
KNUCKLEHEAD  
IS YOUR PARTNER.**

STREAMLIGHT TASK-SPECIFIC TECHNOLOGY:  
CHOOSE THE LIGHT INTENSITY ALLOWING YOU TO  
**CHOOSE THE RIGHT LIGHT FOR THE JOB.**



**AIM IT ANYWHERE //**  
WITH AN ARTICULATING HEAD.

**ATTACH IT TO STEEL //**  
WITH ITS MAGNET.



**CLIP IT ANYWHERE //**  
WITH A SPRING-LOADED  
CLIP. (ORANGE MODEL.)



**HANG IT ANYWHERE //**  
WITH AN INTEGRATED  
STOWABLE HOOK. (YELLOW & BLACK MODELS.)



## KNUCKLEHEAD® FLOOD

	HIGH	LOW
<b>LUMENS:</b>	200	63
<b>CANDELA:</b>	1,150	350
<b>DISTANCE:</b>	68m	37m
<b>RUN TIME:</b>	3h 30m	16h

Moonlight mode: 20 days of continuous run time  
Flash: 8 hours continuous time



Class I, Div. 2, Grps A, B, C, D,  
Class II, Div. 2, Grps F, G  
Class III T4

### NFPA

Rack meets requirements of 1901-14.1.11.2 (2003) mounted in any position



A lightweight, rechargeable, hand-held work light that hangs or attaches a variety of ways to flood your entire work area with light. Even light pattern is easy on your eyes. Articulating head rotates 360°, making it easy to aim light where it's needed. Removable magnet. Stowable hook. Unbreakable, anti-scratch, O-ring sealed lens. IPX4-rated for water-resistance. All openings are O-ring sealed. 2 meter impact-resistance tested. Orange model comes with clip; integrated hook on yellow and black models.

### KNUCKLEHEAD FLOOD

**BATTERY:** Rechargeable NiCd 4.8V, 1.8 Ah, 4-cell sub-C; optional 4 "AA" alkaline non-rechargeable battery cartridge.

**SIZE:** 9.2" x 2.85" x 2.75"  
(23.4 x 7.2 x 7 cm)

**NiCd WEIGHT:** 1 lb 7.1 oz (655 g)

**ALKALINE WEIGHT:** 1 lb 2.3 oz (519 g)

**COLOR:** Orange, Yellow, or Black

### YELLOW ORANGE BLACK

90627	90657	90607	Charger/Holder and 120V AC & 12V DC cords
90622	-	90602	120V AC Charger/Holder
90626	-	90606	12V DC
90633	-	90613	120V AC/DC PiggyBack® Charger
90631	90661	90611	120V AC Fast Charger
90640	90670	90620	12V DC Fast Charger
90621	90651	90601	without Charger
90642	90644	90641	Alkaline Model

Orange model comes with Clip, Black & Yellow models come with Hook

## KNUCKLEHEAD® SPOT

	HIGH	LOW
<b>LUMENS:</b>	180	55
<b>CANDELA:</b>	11,000	3,300
<b>DISTANCE:</b>	210m	115m
<b>RUN TIME:</b>	3h 30m	16h

Moonlight mode: 20 days of continuous run time  
Flash: 8 hours continuous time

Spring-loaded clip attaches to turnout gear for convenient hands-free lighting.



Class I, Div. 2, Grps A, B, C, D,  
Class II, Div. 2, Grps F, G  
Class III T4

### NFPA

Rack meets requirements of 1901-14.1.11.2 (2003) mounted in any position



Powerful magnet adheres to steel surfaces.

Its far-reaching beam helps locate hazards or victims from a distance. Articulating beam makes it easy to aim light where it's needed. Powerful, removable magnet. Smoke-cutting beam. Spring-loaded clip for easy attachment to turnout gear and uneven surfaces. 4 modes include high, low, flash and a moonlight mode for 20-day runtime. Features are designed to give firefighters added flexibility. Unbreakable, anti-scratch, O-ring sealed lens. IPX4-rated for water-resistance. 2 meter impact-resistance tested. All openings are O-ring sealed.

### KNUCKLEHEAD SPOT

**BATTERY:** Rechargeable NiCd 4.8V, 1.8 Ah, 4-cell sub-C; optional 4 "AA" alkaline non-rechargeable battery cartridge.

**SIZE:** 9.2" x 2.85" x 2.75"  
(23.4 x 7.2 x 7 cm)

**NiCd WEIGHT:** 1 lb 7.1 oz (655 g)

**ALKALINE WEIGHT:** 1 lb 2.3 oz (519 g)

**COLOR:** Orange

90757	120V AC/12V DC - Orange
90761	120V AC Fast Charge - Orange
90770	12V DC Fast Charge - Orange
90751	Light Only (without charger) Orange
90744	Alkaline Model - Orange



# STREAMLIGHT SAFETY-RATED SERIES.

## // STREAMLIGHT GIVES YOU MORE SAFETY-RATED LIGHTS FOR MORE OPTIONS IN HAZARDOUS LOCATIONS.

Streamlight flashlights are tested and certified by the world's leading independent laboratories – including Underwriters Laboratories, ATEX, Demko, and the Mine Safety and Health Administration (MSHA). This testing is your assurance that the Streamlight flashlight you choose will be safe in the environment(s) in which you'll be using it.



3N ProPolymer® LED

4AA ProPolymer® LED

4AA ProPolymer® LUX

3C ProPolymer® LED



## // DIFFERENT LIGHTS FOR DIFFERENT HAZARDOUS LOCATIONS.

The National Electric Code (NEC) defines hazardous locations by “class” and “division.” There are three classes:



**CLASS I** locations are made hazardous by the presence of flammable gases, liquids or vapors.



**CLASS II** locations are hazardous because combustible dusts are present.



**CLASS III** locations contain easily ignitable fibers or flyings.

The “Division” designation refers to the likelihood that ignitable concentrations of flammable materials are present. There are two divisions:



**DIVISION 1** designates an environment where ignitable concentrations of flammable gases, liquids, vapors or dusts can exist some of the time or all of the time under normal operating conditions, or where easily ignitable fibers and flyings are manufactured, handled or used.



**DIVISION 2** locations are where ignitable concentrations are not likely to exist under normal operating conditions or where Class 3 materials are stored or handled.

Hazardous classes are further defined by “groups” based on the physical properties of their combustible materials. These groups include (but are not limited to):



- GROUP A** Acetylene
- GROUP B** Hydrogen
- GROUP C** Ethylene, carbon monoxide
- GROUP D** Propane, gasoline, naphtha, benzene, butane, ethyl alcohol, acetone, methane



- GROUP E** Metals including aluminum, magnesium (Div. 1 only)
- GROUP F** Carbonaceous dusts including coal, carbon black, coke
- GROUP G** Dusts not included in E and F including wood, plastics, flour, starch or grain dusts



POLYSTINGER® LED HAZ-LO®

2AA ProPolymer® HAZ-LO®

3AA ProPolymer® HAZ-LO®

3AA ProPolymer® Dualie®

3C ProPolymer® HAZ-LO®

SURVIVOR®

KNUCKLEHEAD® HAZ-LO® // SPOT & FLOOD

3AA HAZ-LO®

SEPTOR® HAZ-LO®

TRIDENT® HAZ-LO®

ARGO® HAZ-LO®

STYLUS®

STYLUS REACH®

## STREAMLIGHT'S HAZ-LO LIGHTS - 2 STANDARDS PROVIDE DIFFERENT PATHS TO THE SAME RESULT: A DIVISION 1 RATING!

When working in a Division 1 area, we expect explosive atmospheres to be present. Streamlight's HAZ-LO product line is suitable for use in Division 1 areas. Streamlight uses different protection standards and testing at Nationally Recognized Test Labs (NRTL) to achieve the Division 1 rating that is common to all Streamlight HAZ-LO Lighting. This is the best possible performance while ensuring that your flashlight will not become an ignition source. ANSI/UL 783 is the specific standard for flashlights used in hazardous locations. ANSI/UL 913 is the intrinsically safe standard for general electronic equipment. While either standard can direct certification to Division 1 level, it is important to note Class, Group and Temperature code requirements to select the correct flashlight for specific applications.











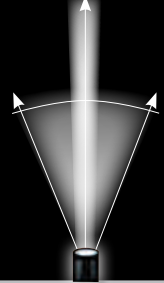

## WHY ARE SAFETY RATINGS IMPORTANT?

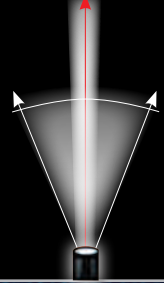
There are several types of locations in which it can be extremely dangerous to use any light that has not been specifically designed – and approved – for that kind of location. These are areas where fire or explosion hazards may exist due to the presence of flammable gases, liquids, vapors, dusts, or ignitable fibers or flyings. If you will be using a flashlight in any potentially hazardous location, it is critical that your light be safety-rated for that specific kind of environment.

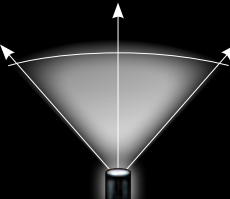

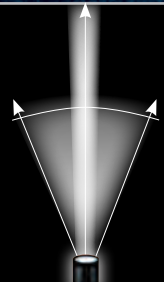

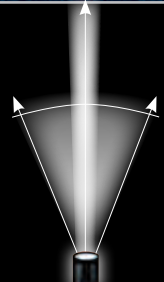

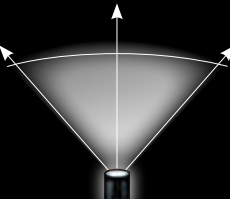



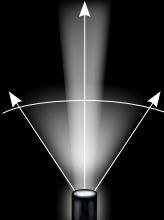

## ATEX RATINGS

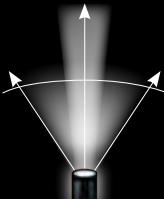
Streamlight also offers safety-rated lights which comply with the European Union (EU) Directive 94/9/EC (ATEX) for products intended for use in potentially explosive atmospheres within the EU member countries. Please visit our web site ([www.streamlight.com](http://www.streamlight.com)) for more information on ATEX-rated products. We also have a catalog of ATEX-rated products available upon request.

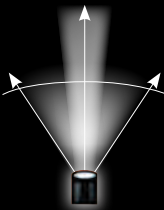
HIGH MODE PERFORMANCE SHOWN.  
 FOR PERFORMANCE IN OTHER  
 MODES, SEE MODEL PAGES.

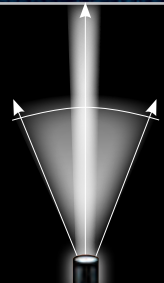
	BEAM PATTERN	SPECS
<p><b>3AA PROPOLYMER®                      DUALIE®</b> Pg. 51</p>  		<p><b>OUTPUT:</b> 140 lumens  <b>INTENSITY:</b> 7,300 candela  <b>BEAM DISTANCE:</b> 171 meters  <b>RUN TIME:</b> 1 hour 15 min  <b>SIZE:</b> 7.00" x 1.52" x 1.06"                      (17.78 x 3.86 x 2.69 cm)  <b>WEIGHT:</b> 6.8 oz (193 g)  <b>COLOR:</b> Yellow or Black</p>
<p><b>3AA PROPOLYMER®                      DUALIE® LASER</b> Pg. 51</p>  		<p><b>OUTPUT:</b> 150 lumens  <b>INTENSITY:</b> 7,700 candela  <b>BEAM DISTANCE:</b> 175 meters  <b>RUN TIME:</b> 17 hours  <b>SIZE:</b> 7.00" x 1.52" x 1.06"                      (17.78 x 3.86 x 2.69 cm)  <b>WEIGHT:</b> 6.8 oz (193 g)  <b>COLOR:</b> Yellow or Black</p>
<p><b>KNUCKLEHEAD®                      FLOOD HAZ-LO®</b> Pg. 53</p>  		<p><b>OUTPUT:</b> 163 lumens  <b>INTENSITY:</b> 730 candela  <b>BEAM DISTANCE:</b> 54 meters  <b>RUN TIME:</b> 3 hours 45 min  <b>SIZE:</b> 9.2" x 2.85" x 2.75"                      (23.4 x 7.2 x 7 cm)  <b>NiCd WEIGHT:</b> 1 lb 7.1 oz (655 g)  <b>ALKALINE WEIGHT:</b> 1 lb 2.3 oz (519 g)  <b>COLOR:</b> International Safety Orange,                      or High-Visibility Yellow</p>
<p><b>KNUCKLEHEAD®                      SPOT HAZ-LO®</b> Pg. 53</p>  		<p><b>OUTPUT:</b> 150 lumens  <b>INTENSITY:</b> 12,900 candela  <b>BEAM DISTANCE:</b> 227 meters  <b>RUN TIME:</b> 3 hours 30 min  <b>SIZE:</b> 9.2" x 2.85" x 2.75"                      (23.4 x 7.2 x 7 cm)  <b>NiCd WEIGHT:</b> 1 lb 7.1 oz (655 g)  <b>ALKALINE WEIGHT:</b> 1 lb 2.3 oz (519 g)  <b>COLOR:</b> International Safety Orange,                      or High-Visibility Yellow</p>
<p><b>3AA HAZ-LO®                      HEADLAMP</b> Pg. 54</p>  		<p><b>OUTPUT:</b> 120 lumens  <b>INTENSITY:</b> 6,800 candela  <b>BEAM DISTANCE:</b> 165 meters  <b>RUN TIME:</b> 11 hours  <b>SIZE:</b> 1.88" x 2.5" x 3.08"                      (4.76 x 6.35 x 7.82 cm)  <b>WEIGHT:</b> 7.1 oz (202 g)  <b>COLOR:</b> Yellow</p>
<p><b>SEPTOR®                      HAZ-LO®</b> Pg. 54</p>  		<p><b>OUTPUT:</b> 85 lumens  <b>INTENSITY:</b> 620 candela  <b>BEAM DISTANCE:</b> 50 meters  <b>RUN TIME:</b> 8 hours  <b>SIZE:</b> 1.75" x 2.70" x 2.40"                      (4.45 x 6.85 x 6.09 cm)  <b>WEIGHT:</b> 5.5 oz (156 g)  <b>COLOR:</b> Yellow</p>

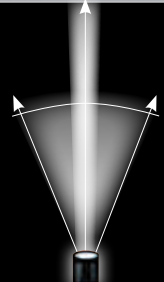

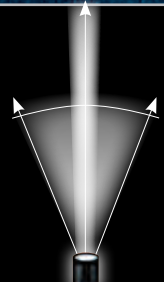
	BEAM PATTERN	SPECS HIGH MODE PERFORMANCE SHOWN. FOR PERFORMANCE IN OTHER MODES, SEE MODEL PAGES.
<p><b>ARGO®</b> HAZ-LO® Pg. 55</p>  		<p>OUTPUT: 90 lumens INTENSITY: 3,200 candela BEAM DISTANCE: 113 meters RUN TIME: 8 hours SIZE: 1.75" x 2.70" x 2.40" (4.45 x 6.85 x 6.09 cm) WEIGHT: 5.4 oz (153 g) COLOR: Yellow</p>
<p><b>TRIDENT®</b> HAZ-LO® Pg. 55</p>  		<p>OUTPUT: 85 lumens INTENSITY: 2,600 candela BEAM DISTANCE: 102 meters RUN TIME: 8 hours SIZE: 1.75" x 2.70" x 2.40" (4.45 x 6.85 x 6.09 cm) WEIGHT: 5.50 oz (156 g) COLOR: Yellow</p>
<p><b>2AA PROPOLYMER®</b> HAZ-LO® Pg. 56</p>  		<p>OUTPUT: 65 lumens INTENSITY: 2,300 candela BEAM DISTANCE: 96 meters RUN TIME: 24 hours SIZE: 6.4" x 1.32" x .89" (16.26 x 3.35 x 2.26 cm) WEIGHT: 3.6 oz (100 g) COLOR: Yellow or Black</p>
<p><b>4AA PROPOLYMAX®</b> Pg. 58</p>  		<p>OUTPUT: 300 lumens INTENSITY: 17,000 candela BEAM DISTANCE: 261 meters RUN TIME: 2 hours 45 min SIZE: 7" x 1.05" x 1.5" (17.78 x 2.67 x 3.81 cm) WEIGHT: 8.2 oz (233 g) COLOR: Yellow, Black or Orange</p>
<p><b>3C PROPOLYMER®</b> HAZ-LO® Pg. 59</p>  		<p>OUTPUT: 150 lumens INTENSITY: 7,000 candela BEAM DISTANCE: 167 meters RUN TIME: 18 hours SIZE: 9.3" x 1.46" x 2.08" (23.62 x 3.71 x 5.28 cm) WEIGHT: 13.9 oz (394 g) COLOR: Yellow or Orange</p>
<p><b>3AA PROPOLYMER®</b> HAZ-LO® Pg. 60</p>  		<p>OUTPUT: 120 lumens INTENSITY: 14,000 candela BEAM DISTANCE: 237 meters RUN TIME: 6 hours 30 min SIZE: 7.0" x 1.05" x 1.50" (17.78 x 2.67 x 3.81 cm) WEIGHT: 7.5 oz (213 g) COLOR: Yellow, Black or Orange</p>



**DUAL BEAM DESIGN:**



The Dualie design allows you to see what's ahead of you and right in front of your feet. Its bright light, which shines both ahead of you and downward, helps you avoid slips, trips and falls.

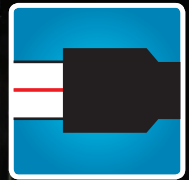

The Dualie Laser features a simultaneous spot beam and laser pointer. Allowing you to illuminate the work area and pinpoint out-of-reach objects.



# THE 3AA PROPOLYMER® DUALIE® AND THE 3AA PROPOLYMER® DUALIE® LASER DIV. 1, INTRINSICALLY SAFE, **DUAL BEAMS,** HANDS-FREE & INCREDIBLY VERSATILE.

## 3AA PROPOLYMER® DUALIE®

One light, two beams: Choose one spot beam or one flood light or both. The 3AA ProPolymer Dualie® provides two types of illumination for multi-directional lighting and special uses. Intuitive activation allows you to use either beam or both at the same time. This intrinsically safe flashlight allows you to see your entire work area and helps you avoid slips, trips, and falls.

### 3AA PROPOLYMER DUALIE

**BATTERY:** 3 "AA" size alkaline or lithium batteries

**SIZE:** 7.00" x 1.52" x 1.06"  
(17.78 x 3.86 x 2.69 cm)

**WEIGHT:** 6.8 oz (193 g)

**COLOR:** Yellow or Black

#### YELLOW BLACK

68750 68752 White LED w/3AA alkaline batteries. Clam.  
68751 68753 White LED w/o batteries. Mailer.

#### ACCESSORIES

68089 Poly Mount Kit  
99075 Rubber Helmet Strap

	SPOT	FLOOD
<b>LUMENS:</b>	140	140
<b>CANDELA:</b>	7,300	80
<b>DISTANCE:</b>	171m	18m
<b>RUN TIME:</b>	18h	18h



Features a forward facing LED spot beam and a side facing LED flood light that can be used individually or at the same time for enhanced safety.



Rugged, integrated, snag-free clip conforms to body of light; grabs onto shirts, pockets and gear for hands-free use.



Class I & II, Div. I, Groups A, B, C, D, F, G  
Class III, CL I, ZN 0, IIC  
T-Code: T4; Exia

## 3AA PROPOLYMER® DUALIE® LASER

The 3AA ProPolymer® Dualie® Laser is an intrinsically safe, high performance, 3 AA battery powered dual function LED flashlight. The Dualie Laser model features forward facing LED spot beam and laser pointer that can be used individually or at the same time for location identification. Opposing switches for easy user activation of desired function(s).

### 3AA PROPOLYMER DUALIE LASER

**BATTERY:** 3 "AA" size alkaline or lithium batteries

**SIZE:** 7.00" x 1.52" x 1.06"  
(17.78 x 3.86 x 2.69 cm)

**WEIGHT:** 6.8 oz (193 g)

**COLOR:** Yellow or Black

68760 White LED/Laser/alkaline batteries - Yellow  
68762 White LED/Laser/alkaline batteries - Black

#### ACCESSORIES

68089 Poly Mount Kit  
99075 Rubber Helmet Strap

	LED	LASER
<b>LUMENS:</b>	150	<5mW output
<b>CANDELA:</b>	7,700	-
<b>DISTANCE:</b>	175m	-
<b>RUN TIME:</b>	17h	70h



Features a forward facing LED spot beam and Laser that can be used individually or at the same time for enhanced safety.



Simultaneous spot beam and laser pointer allows you to illuminate the work area and pinpoint out-of-reach objects.



Class I & II, Div. I, Groups A, B, C, D, F, G  
Class III, CL I, ZN 0, IIC  
T-Code: T4; Exia



# THE HARD WORKING KNUCKLEHEAD... NOW CLASS 1, DIV.1 RATED.

## STREAMLIGHT HAZ-LO® SERIES: // WHAT IS "INTRINSICALLY SAFE?"

Streamlight offers a variety of lights that are safety-rated for hazardous environments. We even have several lights that are "intrinsically safe"—these are lights that have been tested to ANSI/U.L.- Std-913 and found to be safe for use in a Division 1 classified environment.



### KNUCKLEHEAD ACCESSORIES



**Battery  
Chargers**

**Fits All**

**Battery Packs**

**Fits All**

**Charge Cords**

**PN**

Steady Charger Plug-In Charger Holder	90010	Alkaline Battery Cartridge	90542	120V AC	22311
Steady Charger PiggyBack® Charger	90110	NiCd Battery Pack Assembly	90335	12V DC Cigarette Lighter	22051
AC Fast Charger (Includes Holder)	90011			12V DC Direct Wire	22050
AC PiggyBack® Fast Charger	90111				
DC#1 Cigarette Lighter Cord/Fast Charger (Includes Holder)	90012				
DC#1 Cigarette Lighter PiggyBack® Fast Charger	90112				
DC#2 Direct Wire Cord/Fast Charger (Includes Holder)	90113				
120V AC Bank Charger	90400				
12V DC Bank Charger	90401				

## GNUCKLEHEAD® FLOOD HAZ-LO®

	HIGH	LOW
<b>LUMENS:</b>	163	50
<b>CANDELA:</b>	730	230
<b>DISTANCE:</b>	54m	30m
<b>RUN TIME:</b>	3h 45m	12h

Moonlight mode: 20 days of continuous run time  
Flash: 8 hours continuous time



**LED**  
**HAZ-LO**  
DIVISION 1  
LIGHTING

**MSHA**  
Permissible Flashlight  
App. No. 20-A140001-0

**USTC**

Class I & II Division 1, Groups C,D,F,G;  
Class III; T-Code: T4; Exia;  
NON-INCENDIVE: Class I Division 2;  
Groups A,B,C,D, T-CODE T4

**NFPA**  
Rack meets requirements  
of 1901-14.1.11.2 (2003)  
mounted in any position

Class I & II, Div. 1 safety-approved work light with articulating head that hangs or attaches a variety of ways. Its soft flood pattern illuminates your work area, yet the beam is easy on your eyes. Articulating head rotates 210°. Includes high, low, moonlight and flash modes. Removable magnet. Yellow model features an integrated hook for hands-free use. Orange model has a clip that clamps to objects or turn-out gear. IPX4-rated for water-resistance. 2 meter impact-resistance tested.

### GNUCKLEHEAD FLOOD HAZ-LO

**BATTERY:** Dual power source: accepts rechargeable NiCd battery pack or (4) "AA" alkaline batteries

**SIZE:** 9.2" x 2.85" x 2.75"  
(23.4 x 7.2 x 7 cm)

**NiCd WEIGHT:** 1 lb 7.1 oz (655 g)

**ALKALINE WEIGHT:** 1 lb 2.3 oz (519 g)

**COLOR:** Orange or Yellow

YELLOW	ORANGE	
91627	91657	Charger/Holder and 120V AC & 12V DC cords
91622	91652	120V AC
91621	91651	without Charger
91642	91644	Alkaline Model

## GNUCKLEHEAD® SPOT HAZ-LO®

	HIGH	LOW
<b>LUMENS:</b>	150	55
<b>CANDELA:</b>	12,900	4,300
<b>DISTANCE:</b>	227m	131m
<b>RUN TIME:</b>	3h 30m	12h

Moonlight mode: 20 days of continuous run time  
Flash: 8 hours continuous time



**LED**  
**HAZ-LO**  
DIVISION 1  
LIGHTING

**MSHA**  
Permissible Flashlight  
App. No. 20-A140001-0

**USTC**

Class I & II Division 1, Groups C,D,F,G;  
Class III; T-Code: T4; Exia;  
NON-INCENDIVE: Class I Division 2;  
Groups A,B,C,D, T-CODE T4

**NFPA**  
Rack meets requirements  
of 1901-14.1.11.2 (2003)  
mounted in any position

Class I & II, Div. 1 safety-approved for hazardous locations. Far-reaching beam helps locate hazards or victims from a distance. Articulating head makes it easy to aim light where it's needed. 4 light modes include a flash for signaling and a moonlight mode for 20-day runtime. Hangs or attaches various ways. Powerful, removable magnet. Yellow model features an integrated hook for hands-free use. Orange model has a clip that clamps to objects or turn-out gear for hands-free use. IPX4-rated for water-resistance. 2 meter impact-resistance tested.

### GNUCKLEHEAD SPOT HAZ-LO

**BATTERY:** Dual power source: accepts rechargeable NiCd battery pack or (4) "AA" alkaline batteries

**SIZE:** 9.2" x 2.85" x 2.75"  
(23.4 x 7.2 x 7 cm)

**NiCd WEIGHT:** 1 lb 7.1 oz (655 g)

**ALKALINE WEIGHT:** 1 lb 2.3 oz (519 g)

**COLOR:** Orange or Yellow

YELLOW	ORANGE	
91727	91757	Charger/Holder and 120V AC & 12V DC cords
91722	91752	120V AC
91721	91751	without Charger
91742	91744	Alkaline Model

**3AA HAZ-LO® HEADLAMP**

**SEPTOR® HAZ-LO®**

LUMENS:	120
CANDELA:	6,800
DISTANCE:	165m
RUN TIME:	11h





SEPTOR HAZ-LO	HIGH	LOW
LUMENS:	85	20
CANDELA:	620	150
DISTANCE:	50m	24m
RUN TIME:	8h	50h





Includes a rubber head strap that ensures a non-slip grip for hardhats.

This compact, long-running, high-performance headlamp meets the stringent requirements of Div. 1 hazardous locations. Exceptional light output. Long run time. Unbreakable, O-ring sealed lens. Easy operation even when wearing heavy gloves. Impact-resistant housing - 1 meter drop-test verified. Intrinsically safe.

**3AA HAZ-LO**  
**BATTERY:** (3) "AA" alkaline  
**SIZE:** 1.88" x 2.5" x 3.08"  
 (4.76 x 6.35 x 7.82 cm)  
**WEIGHT:** 7.1 oz (202 g)  
**COLOR:** Yellow

61200 with alkaline batteries—rubber and elastic straps—Yellow



Class I, Div. 1, Groups A, B, C, D,  
 Class II, Div. 1, Groups E, F, G,  
 Class III, T4



Permissible Portable Headlamp Assembly  
 App. No. 20-A070001-01  
 Tested for use in methane-air mixtures only



Class I, Div. 1, Groups A, B, C, D, T4;  
 Class II, Div. 1, Groups E, F, G,  
 Class III, T4 "Exia"



The perfect headlamp for close-up tasks or tasks at arm's length is now safe to use in hazardous locations and is intrinsically safe. 90° tilting head. High and low lighting modes. Unbreakable lens. IPX4-rated for water-resistance. 2 meter impact-resistance tested.

**SEPTOR HAZ-LO HEADLAMP**  
**BATTERY:** (3) "AAA" alkaline  
**SIZE:** 1.75" x 2.70" x 2.40"  
 (4.45 x 6.85 x 6.09 cm)  
**WEIGHT:** 5.5 oz (156 g)  
**COLOR:** Yellow

61024 Septor HAZ-LO w/alkaline batteries—rubber and elastic straps—Yellow



Class I, Division 1, Groups A,B,C,D;  
 Class II, Division 1, Groups E,F,G;  
 Class III, T-Class: T4 Exia.  
 (Using: Rayovac No. 824, Panasonic AM-4PA, Energizer EA92, or Energizer Lithium L92 batteries.)



INTRODUCING A FULL-LINE OF HAZ-LO HEADLAMPS ALL  
**CLASS 1, DIV. 1**  
**SAFETY-RATED.**

**ARGO® HAZ-LO®**

With its intense, long-distance beam that reaches as far as 113 meters, and its Class 1, Division 1 safety rating, the Argo® HAZ-LO® headlamp is ideal any where you need hands-free lighting, even in hazardous environments. Intrinsically safe and offers 3 lighting modes and a 90° tilting head. Unbreakable lens. Low battery indicator on Div. 2 model. IPX4-rated for water-resistance. 2 meter impact-resistance tested.

**ARGO HAZ-LO HEADLAMP**

**BATTERY:** (3) "AAA" alkaline

**SIZE:** 1.75" x 2.70" x 2.40"  
 (4.45 x 6.85 x 6.09 cm)

**WEIGHT:** 5.4 oz (153 g)

**COLOR:** Yellow

61026 Argo HAZ-LO w/alkaline batteries—rubber and elastic straps  
 —Yellow



Class 1, Division 1, Groups A,B,C,D;  
 Class II, Division 1, Groups E,F,G;  
 Class III, T-Class: T4 Exia.  
 (Using: Rayovac No. 824, Panasonic  
 AM-4PA, Energizer EA92,  
 or Energizer Lithium L92 batteries.)



ARGO HAZ-LO	HIGH	LOW
<b>LUMENS:</b>	90	20
<b>CANDELA:</b>	3,200	700
<b>DISTANCE:</b>	113m	53m
<b>RUN TIME:</b>	8h	50h



Includes a rubber head strap that ensures a non-slip grip for hardhats.

**TRIDENT® HAZ-LO®**

Now you can safely use this multi-purpose headlamp in hazardous environments. The Class 1, Division 1 safety-rated Trident® HAZ-LO® headlamp is intrinsically safe and gives you the versatility to switch between a bright C4® power LED to illuminate objects at a distance (102 meters!) or a soft flood light for close-up tasks. 90° tilting head. Unbreakable lens. IPX4-rated for water-resistance. 2 meter impact-resistance tested.

**TRIDENT HAZ-LO HEADLAMP**

**BATTERY:** (3) "AAA" alkaline

**SIZE:** 1.75" x 2.70" x 2.40"  
 (4.45 x 6.85 x 6.09 cm)

**WEIGHT:** 5.50 oz (156 g)

**COLOR:** Yellow

61025 Trident HAZ-LO w/alkaline batteries—rubber and elastic straps  
 —Yellow



Class 1, Division 1, Groups A,B,C,D;  
 Class II, Division 1, Groups E,F,G;  
 Class III, T-Class: T4 Exia.  
 (Using: Rayovac No. 824, Panasonic  
 AM-4PA, Energizer EA92,  
 or Energizer Lithium L92 batteries.)



Includes a rubber head strap that ensures a non-slip grip for hardhats.

HAZ-LO Model	HIGH	LOW
<b>LUMENS:</b>	85	30
<b>CANDELA:</b>	2,600	300
<b>DISTANCE:</b>	102m	35m
<b>RUN TIME:</b>	8h	24h



90° tilting head with a new, more durable ratcheting system.



**STREAMLIGHT STORIES...**

**“MY 4AA PROPOLYMER MELTED & MUTATED. BUT IT STILL WORKS!”**

*Your flashlights are amazing! I was using a 4AA ProPolymer along with a torch for preheating. The light got too close to the torch; and, as you can see by the pictures, the torch melted the flashlight ... but it still works! Thanks and please continue making great durable products.*

*Jason Palmer  
Alberta, Canada*

**2AA PROPOLYMER® HAZ-LO®**

This virtually indestructible safety-rated flashlight is big on brightness and long on run time, but small enough to fit in a pocket or even strap on a helmet. Provides a focused beam with optimum peripheral illumination. O-ring sealed construction. IPX7-rated waterproof to 1 meter for 30 minutes. Dust and water protected. 1 meter impact-resistance tested. Drop-tested.

**2AA PROPOLYMER HAZ-LO**  
**BATTERY:** 2 “AA” size alkaline  
**SIZE:** 6.4” x 1.32” x .89”  
 (16.26 x 3.35 x 2.26 cm)  
**WEIGHT:** 3.6 oz (100 g)  
**COLOR:** Yellow or Black

67101	2AA HAZ-LO with alkaline batteries—Yellow
67100	2AA HAZ-LO with alkaline batteries—Black

**ACCESSORIES**

Rubber Helmet Strap	99075
Red Safety Wand	74903
Yellow Safety Wand	74904
Glow-In-The-Dark Safety Wand	74913
Nylon Holster	85905
Polymount Kit	68089

<b>LUMENS:</b>	65
<b>CANDELA:</b>	2,300
<b>DISTANCE:</b>	96m
<b>RUN TIME:</b>	24h



Class I, II, Division 1, Groups A, B, C, D, E, F, G;  
 Class III; T-Class: T4  
 (approved for use with Energizer E91,  
 Duracell MN1500 and Rayovac NO.815)



Permissible Flashlight. Approval No. 20-A140002-D.  
 Tested for Intrinsic Safety in Methane-Air mixtures only.  
 (approved for use with Energizer E91,  
 Duracell MN1500 and Rayovac NO.815)



**Rubber  
Helmet  
Strap**



# THE PROPOLYMER SERIES IS ALWAYS READY FOR HAZARDOUS DUTY.

## 4AA PROPOLYMER® LED

Its soft, diffused light is perfect for up close work; and with 155 hrs. of run time, this safety-rated light is always ready. Contains seven ultra-bright LEDs. IP65-rated, waterproof, dust-resistant. Unbreakable, scratch-resistant lens.

### 4AA PROPOLYMER LED

**BATTERY:** 4 "AA" size alkaline

**SIZE:** 6.5" x 1.63" x 1.34"  
(16.51 x 4.14 x 3.4 cm)

**WEIGHT:** 6.3 oz (178.6 g)

**COLOR:** Yellow or Black

#### YELLOW BLACK

68202	68302	White LEDs/alkaline batteries—Clam packaged
68201	68301	White LEDs/alkaline batteries—in box
68200	68300	White LEDs w/o alkaline batteries—in box

**LUMENS:** 67  
**RUN TIME:** 155h



Class I, Div. 1, Groups C, D;  
Class I, Div. 2, Groups A, B, C, D;  
Class II, Div. 2, Groups F&G;  
Class III, T3C



Class I, Div. 2, Groups A, B, C, D;  
Class II, Div. 2, Groups F&G;  
Class III, T3C



Permissible Flashlight  
App. No. 10C-658-0  
Tested for use in methane-air  
mixtures only

## 4AA PROPOLYMER® LUX

This safety-rated light has a long-reaching, bright beam and an ergonomic design for comfortable handling. Unbreakable, scratch-resistant lens. IP67-rated; waterproof to 1 meter for 30 minutes. 1 meter impact-resistance tested. Corrosion-proof.

### 4AA PROPOLYMER LUX

**BATTERY:** 4 "AA" size alkaline

**SIZE:** 7" x 1.48" x 1.69"  
(17.8 x 3.76 x 4.29 cm)

**WEIGHT:** 7.6 oz (216 g)

**COLOR:** Yellow or Black

#### YELLOW BLACK

68244	68344	4AA Lux Div. 2 w/alkaline batteries
68602	68702	4AA Lux Div. 1 w/alkaline batteries

ACCESSORIES	4AA LED ProPolymer	4AA Lux ProPolymer
Yellow Safety Wand	75904	75904
Red Safety Wand	75903	75903
Blue Safety Wand	75902	75902
White Safety Wand	75908	75908
Glow-In-The-Dark Safety Wand	75913	75913
Helmet Mount	68085	68085
Gallet Helmet Mount	68269	68269
Polymount Kit	68089	68089



Safety Wands



Gallet Helmet Mount Helmet Mount

**LUMENS:** 100  
**CANDELA:** 4,200  
**DISTANCE:** 130m  
**RUN TIME:** 6h



Gallet Helmet Mount



Helmet Mount



Rubber Helmet Strap

#### 4AA Lux Div. 1



Class I & II, Div. 1, Groups C, D, F & G;  
Class I, Div. 2, Groups A, B, C, D;  
Class III, T4



Class I & II, Div. 1, Groups C, D, F & G;  
Class III, T4 Exia  
Non-incendive:  
Class I, Div. 2, Groups A, B, C, D



Permissible Flashlight  
App. No. 20-A060002-0  
Tested for use in methane-air  
mixtures only

#### 4AA Lux Div. 2



Class I, Div. 2, Groups A, B, C, D;  
Class II, Div. 2, Groups F&G;  
Class III, T3C (142 C)



Class I, Div. 2, Groups A, B, C, D;  
Class II, Div. 2, Groups F&G;  
Class III, T3C (142 C)

#### NFPA

Meets requirements of  
NFPA 1971-8.6 (2007);  
500° heat resistance test

## 4AA PROPOLYMAX®

The brightest light in our ProPolymer® series stands up to the toughest environments. Produces a tight beam with optimum peripheral illumination. Accepts belt clip and attaches to hard hat. Sealed switch design protects it from corrosion caused by battery leakage. Unbreakable, scratch-resistant lens. Features TEN-TAP® programming, allowing user to select the order in which light modes come on.

IP67-rated for dust-tight and waterproof to 1 meter for 30 minutes. IPX4 for water spray. Non conductive; corrosion-proof.

### 4AA PROPOLYMAX

**BATTERY:** 4 "AA" size alkaline

**SIZE:** 7" x 1.05" x 1.5"  
(17.78 x 2.67 x 3.81 cm)

**WEIGHT:** 8.2 oz (233 g)

**COLOR:** Yellow, Black or Orange

68820 with alkaline batteries - Yellow

68821 with alkaline batteries - Black

68822 with alkaline batteries - Orange

### ACCESSORIES

68088 Belt Clip - fits 4AA ProPolymax

68089 Poly Mount Kit - universal mounting via MSA V-Gard slot or self-adhesive mount



Class I, Div. 2, Groups A, B, C, D;  
Class II, Div. 2, Groups F&G;  
Class III, T4



Class I, Div. 2, Groups A, B, C, D;  
Class II, Div. 2, Groups F&G;  
Class III, T4

	HIGH	LOW
<b>LUMENS:</b>	300	50
<b>CANDELA:</b>	17,000	2,500
<b>DISTANCE:</b>	261m	100m
<b>RUN TIME:</b>	2h 45m	24h

Strobe runs 6 hours



TEN-TAP® Programmable switch allows user selection of one of three different programs:

- high/low/strobe (factory default)
- high only
- low/high



Belt Clip



Poly Mount Kit



## 3C PROPOLYMER® LED

10 ultra-bright LEDs provide lots of bright white light and an extended run time - up to 336 hrs! Safety-rated for use in hazardous locations. Unbreakable, scratch-resistant lens. Waterproof.

### 3C PROPOLYMER LED

**BATTERY:** 3 "C" size alkaline

**SIZE:** 8.55" x 1.95" x 1.48"  
(21.72 x 4.95 x 3.76 cm)

**WEIGHT:** 13.5 oz (382.73 g)

**COLOR:** Yellow or Black

33202 White LEDs w/o alkaline batteries - Yellow

33302 White LEDs w/o alkaline batteries - Black

### ACCESSORIES

33903 Red Wand

33908 White Wand

25090 Holster

<b>LUMENS:</b>	85
<b>RUN TIME:</b>	336h



Permissible Flashlight  
App. No. 10C-658-D  
Tested for use in methane-air mixtures only



Class I, Div. 1, Group D;  
Class I, Div. 2, Groups A, B, C, D;  
Class II, Div. 2, Groups F&G;  
Class III, T3C



Class I, Div. 2, Groups A, B, C, D;  
Class II, Div. 2, Groups F&G;  
Class III, T3C





## 3C PROPOLYMER® HAZ-LO®

An intrinsically safe, high-performance flashlight for hazardous locations. Produces a smooth, uniform beam with optimum peripheral illumination. Virtually indestructible body. Resistant to chemicals and solvents. Sealed switch design protects it from corrosion caused by battery leakage. Unbreakable, scratch-resistant lens. 3 meter impact-resistance tested. IP67-rated for dust-tight and waterproof to 1 meter for 30 minutes. IPX4 for water spray. Anti-static and non-conductive.

### 3C PROPOLYMER HAZ-LO

**BATTERY:** 3 "C" size alkaline

**SIZE:** 9.3" x 1.46" x 2.08"  
(23.62 x 3.71 x 5.28 cm)

**WEIGHT:** 13.9 oz (394 g)

**COLOR:** Yellow or Orange

33820 3C ProPolymer HAZ-LO - Yellow

33822 3C ProPolymer HAZ-LO - Orange

### ACCESSORIES

25090 Holster

**LUMENS:** 150  
**CANDELA:** 7,000  
**DISTANCE:** 167m  
**RUN TIME:** 18h



Permissible Flashlight  
App. No. 20-A130003-0  
Tested for Intrinsic Safety in  
Methane-Air mixtures only



Class I, Div 1, Groups A, B, C, D T4;  
Class II, Div. 1, Groups E, F, G;  
Class III, T4 Classified



Class I, Div 1, Groups A, B, C, D T4;  
Class II, Div. 1, Groups E, F, G;  
Class III, T4 Exia



THE PROPOLYMER SERIES IS ALWAYS  
**READY FOR**  
HAZARDOUS DUTY.

**3AA PROPOLYMER® HAZ-LO®**

The premiere light in our ProPolymer series with the strongest blend of performance and safety ratings. Intrinsically safe for use in hazardous locations. Produces a tight beam with optimum peripheral illumination. Resistant to chemicals and solvents. Combination of visual and mechanical polarity protection ensures correct installation of batteries. Consistent performance throughout battery life. Unbreakable, scratch-resistant lens. IP67-rated for dust-resistance. Waterproof to 1 meter for 30 minutes. IPX4-rated for water spray.

**3AA PROPOLYMER HAZ-LO**

**BATTERY:** 3 "AA" size alkaline

**SIZE:** 7.0" x 1.05" x 1.50"  
(17.78 x 2.67 x 3.81 cm)

**WEIGHT:** 7.5 oz (213 g)

**COLOR:** Yellow, Black or Orange

YELLOW	BLACK	ORANGE	
68720	68721	68722	HAZ-LO with alkaline batteries - Clam
68723	68724	-	HAZ-LO with alkaline batteries - Box
68270	-	-	Helmet Lighting Kit- 3AA HAZ-LO with whiteLED, alkaline batteries, helmet mount, helmet band, clam packaged

**ACCESSORIES**

68085	Helmet Mount
68086	Gallet Helmet Mount
68089	Polymount Kit
68088	Beltclip

<b>LUMENS:</b>	120
<b>CANDELA:</b>	14,000
<b>DISTANCE:</b>	237m
<b>RUN TIME:</b>	6h 30m



Helmet Mount



Helmet Lighting Kit



Permissible Flashlight  
App. No. 20-A140003-0  
Tested for Intrinsic Safety in  
Methane-Air mixtures only



Class I, Div 1, Groups A, B, C, D;  
Class II, Div 1, Groups E, F, G;  
Class III, T4 Exia

## 3N PROPOLYMER® LED

Lightweight, alkaline battery-powered personal light with 3 ultra-bright LEDs. Long run time. Impact-resistant body and face cap. Unbreakable, polycarbonate scratch-resistant lens. Push-button tail switch for momentary and on-off operation

### 3N PROPOLYMER LED

**BATTERY:** 3 "N" size alkaline

**SIZE:** 5.25" x .96" x .69"  
(13.33 x 2.44 x 1.75 cm)

**WEIGHT:** 2.1 oz (59.54 g)

**COLOR:** Yellow or Black

62202 White LEDs and alkaline batteries—Yellow

62302 White LEDs and alkaline batteries—Black

<b>LUMENS:</b>	30
<b>CANDELA:</b>	300
<b>DISTANCE:</b>	35m
<b>RUN TIME:</b>	10h



Class I, II, Div. 1, Groups A,B,C,D,E,F,G;  
Class III, Exia, T4A Classified  
(approved for use with Energizer E90,  
and Duracell MN9100)



## POLYSTINGER® LED HAZ-LO®

If you're working in a potentially hazardous location, this is the light you need. It provides lots of bright, white light, yet it's intrinsically safe, with a Class I, Div. 1. rating. It has an O-ring sealed, unbreakable, scratch-resistant lens. It's IPX4-rated for water-resistance, and 3 meter impact-resistance tested.

### POLYSTINGER LED HAZ-LO

**BATTERY:** 4-cell, 4.8V NiCd sub-C

**SIZE:** 10.2" x 1.76" x 1.34"  
(25.9 x 4.47 x 3.4 cm)

**WEIGHT:** 13.5 oz (382 g)

**COLOR:** Black or Yellow

#### YELLOW BLACK

76412 76442 120V AC/12V DC

76411 76441 12V DC

76410 76440 Without Charger

#### ACCESSORIES

76409 Lanyard

75928 Loop Holster

75906 Ring Holder

76375 NiCd Battery Stick

75401 5 Unit Bank Fast Charger 120V

75400 5 Unit Bank Charger 120V

75103 Charger Holder Fast Charge (2.5 hr)

75100 Charger Holder Stinger (10 hr)

22311 120V AC Charge Cord

22051 DC1 Charge Cord

22050 DC2 Direct Wire Charge Cord

### TRADITION SERIES

	HIGH	LOW
<b>LUMENS:</b>	130	50
<b>CANDELA:</b>	15,000	5,700
<b>DISTANCE:</b>	245m	151m
<b>RUN TIME:</b>	4h	12h

Moonlight mode: 20 days of continuous run time



Lanyard Ring  
with lanyard for tail cap.



Class I & II, Division 1, Groups C,D,F,G;  
Class I, Division 2, Groups A,B,C,D;  
Class III; 138°C, T-Code: T3C

#### Special Features:

- Non-conductive, corrosion-resistant body.
- IPX4-rated for water-resistance.
- 3 meter impact-resistance tested.



**STREAMLIGHT,  
THE WIDEST ARRAY OF  
WEAPON-MOUNTED  
LIGHTS.**

*At Streamlight, we engineer the highest performing, most rugged, durable and innovative lights on the market. We create lights that add real value... for specific tasks as well as for a wide variety of applications – including the widest array of weapon mounted lights. Whether you're LEO, S.W.A.T., Military, home defense or a sportsman, Streamlight builds the products you can depend on and the options and configurations that you need.*

*In developing lights that help our customers work more efficiently, safely, and economically, we've changed the shape of the flashlight industry. And we've literally changed the shape of illumination. Streamlight's cutting edge beam patterns, like our HL and HPL lights, have set new standards, and demonstrated just how practical advanced design can be.*

USE THIS EASY COMPARISON CHART TO CHOOSE THE BEST LIGHT FOR YOU BASED ON THE FEATURES THAT YOU NEED!

BEAM PATTERN

SPECS

HIGH MODE PERFORMANCE SHOWN. FOR PERFORMANCE IN OTHER MODES, SEE MODEL PAGES.

**PROTAC®**  
**RAIL MOUNT 2** Pg. 67

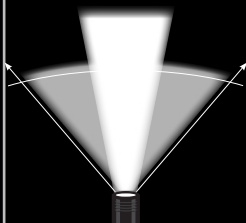

**OUTPUT:** 625 lumens  
**INTENSITY:** 22,000 candela  
**BEAM DISTANCE:** 297 meters  
**RUN TIME:** 2 hours  
**SIZE:** 5.00" x 1.50" x 1.20"  
(12.7 x 3.81 x 3.04 cm)  
**WEIGHT:** 5.00 oz (141.7 g)  
**COLOR:** Black

**PROTAC®**  
**RAIL MOUNT 1** Pg. 67

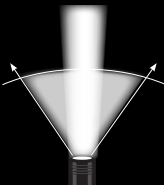

**OUTPUT:** 350 lumens  
**INTENSITY:** 12,000 candela  
**BEAM DISTANCE:** 219 meters  
**RUN TIME:** 1 hour 45 min  
**SIZE:** 4.25" x 1.50" x 1.20"  
(10.8 x 3.81 x 3.04 cm)  
**WEIGHT:** 4.3 oz (121.9 g) w/CR123  
**COLOR:** Black

**TLR-1 HL®** Pg. 68  
White Light Illuminator

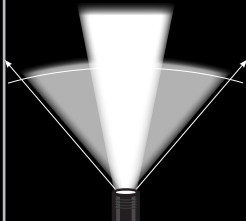

**OUTPUT:** 800 lumens  
**INTENSITY:** 15,000 candela  
**BEAM DISTANCE:** 245 meters  
**RUN TIME:** 1 hour 15 min  
**SIZE:** 3.39" x 1.47" x 1.44"  
(8.61 x 3.73 x 3.65 cm)  
**WEIGHT:** 4.18 oz (118.6 g)  
**COLOR:** Black, Flat Dark Earth or Flat Dark Earth Brown

**HL SERIES**

**TLR-2 HL®** Pg. 68  
White Light Illuminator / Red Laser

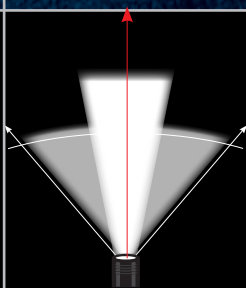

**OUTPUT:** 800 lumens  
**INTENSITY:** 15,000 candela  
**BEAM DISTANCE:** 245 meters  
**RUN TIME:** 1 hour 15 min  
**SIZE:** 3.39" x 1.47" x 1.83"  
(8.61 x 3.73 x 4.64 cm)  
**WEIGHT:** 4.78 oz (135.5 g)  
**COLOR:** Black

**HL SERIES**

**TLR-1® // TLR-1®s** Pg. 69  
White Light Illuminator

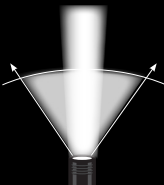

**OUTPUT:** 300 lumens  
**INTENSITY:** 12,000 candela  
**BEAM DISTANCE:** 219 meters  
**RUN TIME:** 2 hours 30 min  
**SIZE:** 3.26" x 1.47" x 1.44"  
(8.28 x 3.73 x 3.65 cm)  
**WEIGHT:** 4.18 oz (118.6 g)  
**COLOR:** Black

**TRADITION SERIES**

**TLR-2® // TLR-2®s** Pg. 69  
White Light Illuminator / Red Laser

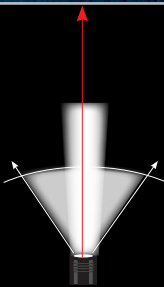









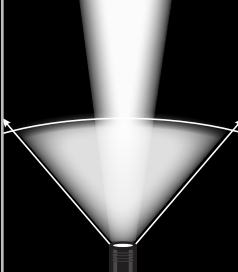

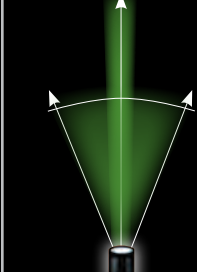
**OUTPUT:** 300 lumens  
**INTENSITY:** 12,000 candela  
**BEAM DISTANCE:** 219 meters  
**RUN TIME:** 2 hours 30 min  
**SIZE:** 3.39" x 1.47" x 1.83"  
(8.61 x 3.73 x 4.64 cm)  
**WEIGHT:** 4.72 oz (133.8 g)  
**COLOR:** Black

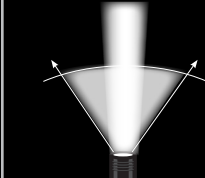
**TRADITION SERIES**

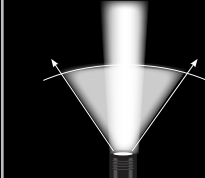
**TACTICAL SERIES**  
**// STREAMLIGHT 2016**

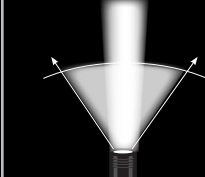
HIGH MODE PERFORMANCE SHOWN.  
 FOR PERFORMANCE IN OTHER  
 MODES, SEE MODEL PAGES.

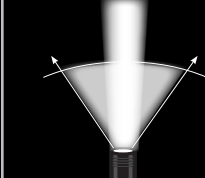
	BEAM PATTERN	SPECS
<p><b>TLR-1 HPL</b>® Pg. 70                      White Light Illuminator</p>  <p><b>HPL SERIES</b></p>		<p><b>OUTPUT:</b> 775 lumens  <b>INTENSITY:</b> 48,000 candela  <b>BEAM DISTANCE:</b> 438 meters  <b>RUN TIME:</b> 1 hour 45 min  <b>SIZE:</b> 4.83" x 1.44" x 2.2"                      (12.27 x 3.66 x 5.59 cm)  <b>WEIGHT:</b> 5.3 oz (150.3 g)  <b>COLOR:</b> Black</p>
<p><b>TLR-1 GAME SPOTTER</b>® Pg. 71                      Green Illuminator</p>  <p><b>TRADITION SERIES</b></p>		<p><b>OUTPUT:</b> 150 lumens  <b>INTENSITY:</b> 31,000 candela  <b>BEAM DISTANCE:</b> 352 meters  <b>RUN TIME:</b> 1 hour 45 min  <b>SIZE:</b> 4.83" x 1.44" x 2.2"                      (12.27 x 3.66 x 5.59 cm)  <b>WEIGHT:</b> 5.6 oz (158.8 g)  <b>COLOR:</b> Black</p>
<p><b>TLR-2 IR EYE SAFE</b> Pg. 72                      IR Illuminator / Eye Safe IR Laser</p> 		<p><b>IR LED OUTPUT:</b> 125mW/sr  <b>IR LASER OUTPUT:</b> less than .8mW  <b>RUN TIME:</b> 7 hours 30 min  <b>SIZE:</b> 3.39" x 1.47" x 1.83"                      (8.61 x 3.73 x 4.64 cm)  <b>WEIGHT:</b> 4.72 oz (133.8 g)  <b>COLOR:</b> Black</p>
<p><b>TLR-2 IRW</b> Pg. 73                      White Light Illuminator / Eye Safe IR Laser</p> 		<p><b>OUTPUT:</b> 300 lumens  <b>IR LASER OUTPUT:</b> less than .8mW  <b>INTENSITY:</b> 12,000 candela  <b>VISIBLE RUN TIME:</b> 2 hours 30 min  <b>SIZE:</b> 3.39" x 1.47" x 1.83"                      (8.61 x 3.73 x 4.64 cm)  <b>WEIGHT:</b> 4.72 oz (133.8 g)  <b>COLOR:</b> Black</p>
<p><b>TLR-VIR PISTOL</b> Pg. 75                      White Light Illuminator / IR Illuminator</p>  <p><b>TRADITION SERIES</b></p>		<p><b>OUTPUT:</b> 300 lumens  <b>IR OUTPUT:</b> 1,000mW/sr  <b>INTENSITY:</b> 11,000 candela  <b>VISIBLE RUN TIME:</b> 2 hours 30 min  <b>IR RUN TIME:</b> 32 hours  <b>SIZE:</b> 3.39" x 1.47" x 1.44"                      (9.7 x 3.73 x 3.65 cm)  <b>WEIGHT:</b> 4.2 oz (119 g) With Batteries  <b>COLOR:</b> Black</p>
<p><b>TLR-VIR</b> Pg. 75                      White Light Illuminator / IR Illuminator</p>  <p><b>TRADITION SERIES</b></p>		<p><b>OUTPUT:</b> 300 lumens  <b>IR OUTPUT:</b> 1,000mW/sr  <b>INTENSITY:</b> 11,000 candela  <b>VISIBLE RUN TIME:</b> 2 hours 30 min  <b>IR RUN TIME:</b> 20 hours  <b>SIZE:</b> 3.39" x 1.47" x 2.03"                      (9.7 x 3.73 x 5.16 cm)  <b>WEIGHT:</b> 6.0 oz (170 g) With Batteries  <b>COLOR:</b> Black</p>











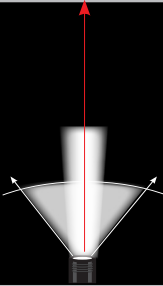

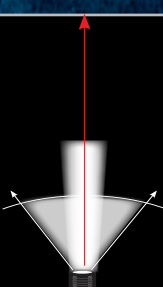
USE THIS EASY COMPARISON CHART TO CHOOSE THE BEST LIGHT FOR YOU BASED ON THE FEATURES THAT YOU NEED!

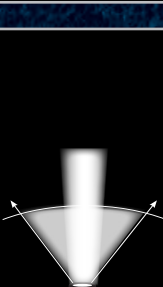
BEAM PATTERN

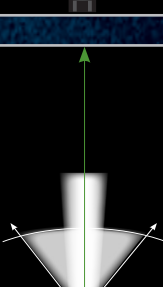
SPECS

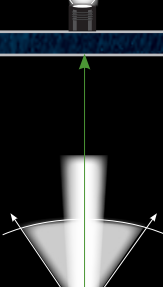
HIGH MODE PERFORMANCE SHOWN. FOR PERFORMANCE IN OTHER MODES, SEE MODEL PAGES.

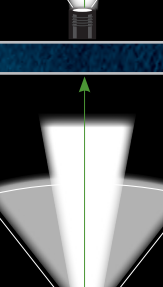
<p><b>TLR-6®</b> Pg. 78 White Light Illuminator / Red Laser</p>  <p><b>TRADITION SERIES</b></p>		<p><b>OUTPUT:</b> 100 lumens <b>INTENSITY:</b> 2,000 candela <b>RUN TIME:</b> 1 hour <b>SIZE:</b> * 2.30" x .085" x 1.42" (5.84 x 2.16 x 3.61 cm) <b>WEIGHT:</b> * 1.27 oz (36 g) <b>COLOR:</b> Black or Flat Dark Earth Brown *Size 6 Weight vary by model. Glock® 42/43 listed.</p>
<p><b>TLR-4®</b> Pg. 79 White Light Illuminator / Red Laser</p>  <p><b>TRADITION SERIES</b></p>		<p><b>OUTPUT:</b> 125 lumens <b>INTENSITY:</b> 5,300 candela <b>RUN TIME:</b> 1 hour 30 min <b>SIZE:</b> 2.73" x 1.2" x 1.99" (6.93 x 3.05 x 5.05 cm) <b>WEIGHT:</b> 2.81 oz (79.7 g) <b>COLOR:</b> Black</p>
<p><b>TLR-3®</b> Pg. 79 White Light Illuminator</p>  <p><b>TRADITION SERIES</b></p>		<p><b>OUTPUT:</b> 125 lumens <b>INTENSITY:</b> 5,300 candela <b>RUN TIME:</b> 1 hour 30 min <b>SIZE:</b> 2.71" x 1.18" x 1.51" (6.98 x 3 x 3.84 cm) <b>WEIGHT:</b> 2.32 oz (65.8 g) <b>COLOR:</b> Black</p>
<p><b>TLR-4® G</b> Pg. 80 White Light Illuminator / Green Laser</p>  <p><b>TRADITION SERIES</b></p>		<p><b>OUTPUT:</b> 115 lumens <b>INTENSITY:</b> 5,200 candela <b>RUN TIME:</b> 1 hour 45 min <b>SIZE:</b> 2.73" x 1.2" x 1.99" (6.93 x 3.05 x 5.05 cm) <b>WEIGHT:</b> 2.81 oz (79.7 g) <b>COLOR:</b> Black</p>
<p><b>TLR-2® G</b> Pg. 81 White Light Illuminator / Green Laser</p>  <p><b>TRADITION SERIES</b></p>		<p><b>OUTPUT:</b> 300 lumens <b>INTENSITY:</b> 12,000 candela <b>BEAM DISTANCE:</b> 159 meters <b>RUN TIME:</b> 2 hours 30 min <b>SIZE:</b> 3.39" x 1.47" x 1.83" (8.61 x 3.73 x 4.64 cm) <b>WEIGHT:</b> 4.58 oz (130 g) <b>COLOR:</b> Black</p>
<p><b>TLR-2® HL G</b> Pg. 81 White Light Illuminator / Green Laser</p>  <p><b>HL SERIES</b></p>		<p><b>OUTPUT:</b> 800 lumens <b>INTENSITY:</b> 15,000 candela <b>BEAM DISTANCE:</b> 245 meters <b>RUN TIME:</b> 1 hour 30 min <b>SIZE:</b> 3.39" x 1.47" x 1.83" (8.61 x 3.73 x 4.64 cm) <b>WEIGHT:</b> 4.78 oz (135.5 g) <b>COLOR:</b> Black</p>

**TACTICAL SERIES**  
**// STREAMLIGHT 2016**

**PROTAC** WEAPON-MOUNTED SERIES  
// STREAMLIGHT 2016



# THE NEW PROTAC RAIL MOUNT LIGHTS SHATTER THE DARK WITHOUT BREAKING THE BANK.

## PROTAC® RAIL MOUNT 2

The ProTac series expands into weapon-mounted lights with this 625 lumen light featuring a dedicated fixed-mount for MIL-STD-1913 (Picatinny) rails. Lightweight, this bright, down range light can be used in close quarter compact or to identify medium range threats. Rugged and reliable. Its easy to use pressure switch comes with a button for on/off and a pressure switch for momentary activation. TEN-TAP® programming provides operator custom options.

### PROTAC RAIL MOUNT 2

**BATTERY:** (2) 3V "CR123A" lithium

**SIZE:** 5.00" x 1.50" x 1.20"  
(12.7 x 3.81 x 3.04 cm)

**WEIGHT:** 5.00 oz (141.7 g)

**COLOR:** Black

88059 with (2) lithium batteries-Black

CR123	HIGH	LOW
<b>LUMENS:</b>	625	60
<b>CANDELA:</b>	22,000	2,000
<b>DISTANCE:</b>	297m	89m
<b>RUN TIME:</b>	2h	18h

Strobe runs 2h 45m

An additional tail cap switch is included in each Rail Mount package if the remote switch is not preferred.



TEN-TAP® Programmable switch allows user selection of one of three different programs:

- high/strobe (factory default)
- high only
- low/high



With **[(STROBE)]**  
Double tap switch to activate.

**NEW FOR 2016**  
**625 LUMENS**

## PROTAC® RAIL MOUNT 1

The new Streamlight ProTac® Rail Mount 1 features an integrated rail clamp that securely fits rifles, carbines and sub-machine guns with a MIL-STD-1913 (Picatinny) rail. It comes with both remote pressure and standard push-button tail switches and offers the added convenience of using either one lithium or one AA alkaline battery.

### PROTAC RAIL MOUNT 1

**BATTERY:** (1) 3V "CR123A" lithium or (1) "AA" Alkaline

**SIZE:** 4.25" x 1.50" x 1.20"  
(10.8 x 3.81 x 3.04 cm)

**WEIGHT:** 4.3 oz (121.9 g) w/CR123

**COLOR:** Black

88058 with (1) lithium battery-Black

CR123	HIGH	LOW
<b>LUMENS:</b>	350	40
<b>CANDELA:</b>	12,000	1,380
<b>DISTANCE:</b>	219m	19m
<b>RUN TIME:</b>	1h 45m	14h 30m

Strobe runs 2h 45m

TEN-TAP® Programmable switch allows user selection of one of three different programs:

- high/strobe (factory default)
- high only
- low/high

**DUAL FUEL DESIGN:**  
Runs on one "AA" alkaline or CR123A lithium battery - both included.



With **[(STROBE)]**  
Double tap switch to activate.

**NEW FOR 2016**  
**350 LUMENS**

ALKALINE	HIGH	LOW
<b>LUMENS:</b>	150	40
<b>CANDELA:</b>	4,950	1,380
<b>DISTANCE:</b>	141m	19m
<b>RUN TIME:</b>	1h 30m	8h

Strobe runs 2h 45m



**TLR-1 HL®**  
**TLR-2 HL®**

This versatile tactical light fits handguns and long guns, and you can switch from one to the other in seconds. Its wide peripheral beam lets you see what's all around you, including what's lurking in corners. Includes a strobe for signaling/disorienting. Unbreakable, scratch-resistant, gasket-sealed lens. Operates in temperatures from -40°F to +120°F. TLR-1 HL IPX7-rated waterproof to 1 meter for 30 minutes. Impact resistant. Easy, fast battery installation/replacement. TLR-2 HL features a 640-660nm red laser and IPX4-rated for water resistance.

**TLR-1 HL**

**BATTERY:** (2) 3V "CR123A" lithium  
**SIZE:** 3.39" x 1.47" x 1.44"  
(8.61 x 3.73 x 3.65 cm)  
**WEIGHT:** 4.18 oz (118.6 g)  
**COLOR:** Black, Flat Dark Earth or Flat Dark Earth Brown

**TLR-2 HL**

**BATTERY:** (2) 3V "CR123A" lithium  
**SIZE:** 3.39" x 1.47" x 1.83"  
(8.61 x 3.73 x 4.64 cm)  
**WEIGHT:** 4.78 oz (135.5 g)  
**COLOR:** Black

**TLR-1 HL TLR-2 HL**

69260	69261	Includes Rail Locating Keys for use with Glock® style, MIL-STD-1913 rails, S&W 99/TSW, and Beretta® 90two. Lithium batteries. Black.
69266	-	Includes Rail Locating Keys for use with Glock® style, MIL-STD-1913 rails, S&W 99/TSW, and Beretta® 90two. Lithium batteries. Flat Dark Earth.
69267	-	Includes Rail Locating Keys for use with Glock® style, MIL-STD-1913 rails, S&W 99/TSW, and Beretta® 90two. Lithium batteries. Flat Dark Earth Brown.
69262	-	Long Gun Kit includes: TLR-1 HL with thumb screw and "safe off" door switch, remote pressure switch and mounting clips, lithium batteries. For pistol mounting the kit also includes standard door switch, rail locating keys. Lithium batteries. Black.

**WHITE LIGHT ILLUMINATOR // HL SERIES**



TLR-1 HL® Now Available in Flat Dark Earth and FDE Brown

**UPDATED FOR 2016**  
**800 LUMENS**



With **[(STROBE)]**  
Double tap tailswitch to activate.

**LUMENS:** 800  
**CANDELA:** 15,000  
**DISTANCE:** 245m  
**RUN TIME:** 1h 15m

TLR-2HL Laser mode: 45 hours of run time



TLR-1 HL Long Gun Kit



**WHITE LIGHT ILLUMINATOR // RED LASER**

DURABILITY, POWER, LONG-RUNNING.

# ADVANTAGE: TLR TACTICAL LIGHTS

## TLR-1® // TLR-1s

WHITE LIGHT ILLUMINATOR //



LUMENS:	300
CANDELA:	12,000
DISTANCE:	219m
RUN TIME:	2h 30m

**300 LUMENS**

**C4 LED** With **[(STROBE)]**  
Double tap tailswitch to activate.

AVAILABLE WITH STROBE

## TLR-2® // TLR-2s

WHITE LIGHT ILLUMINATOR // RED LASER



LUMENS:	300
CANDELA:	12,000
DISTANCE:	219m
RUN TIME:	2h 30m

**300 LUMENS**

**C4 LED** With **[(STROBE)]**  
Double tap switch to activate.

AVAILABLE WITH STROBE

### TRADITION SERIES

Intensely bright, durable tactical light available in standard, strobe and IR. Securely fits a broad range of weapons. Produces a concentrated beam with optimum peripheral illumination. Mounts directly to handguns with Glock-style rails and to all MIL-STD-1913 (Picatinny) rails. Operates in temperatures from -40°F to +120°F. IPX7-rated waterproof to 1 meter for 30 minutes. Impact resistant. The TLR-1s includes a strobe.

#### TLR-1 / TLR-1S

**BATTERY:** (2) 3V "CR123A" lithium

**SIZE:** 3.39" x 1.47" x 1.44"  
(8.61 x 3.73 x 3.65 cm)

**WEIGHT:** 4.18 oz (118.6 g)

**COLOR:** Black

69110	Includes Rail Locating Keys for Glock style, MIL-STD-1913 rails, S&W 99/TSW, and Beretta 90two. Lithium batteries. Black.
69210	Strobe model includes Rail Locating Keys for Glock style, MIL-STD-1913 rails, S&W 99/TSW, and Beretta 90two. Lithium batteries. Black.
69211	Strobe model with Earless Screw Kit, includes Rail Locating Keys for Glock style, MIL-STD-1913 rails, S&W 99/TSW, and Beretta 90two. Lithium batteries. Black.

### TRADITION SERIES

The same great features as the TLR-1 lights with a 650-600nm red laser for accurate aiming. Strobe ("S") model available. IPX4-rated for water resistance.

#### TLR-2 / TLR-2S

**BATTERY:** (2) 3V "CR123A" lithium

**SIZE:** 3.26" x 1.47" x 1.83"  
(8.28 x 3.73 x 4.64 cm)

**WEIGHT:** 4.72 oz (133.8 g)

**COLOR:** Black

69120	with Red Laser. Includes Rail Locating Keys for Glock style, MIL-STD-1913 rails, S&W 99/TSW, and Beretta 90two. Lithium batteries. Black.
69230	Strobe model w/ Red Laser. Includes Rail Locating Keys for Glock style, MIL-STD-1913 rails, S&W 99/TSW, and Beretta 90two. Lithium batteries. Black.

# TLR-1 HPL®

**HIGH-LUMEN + LONG-DISTANCE.  
 SEE EVERYWHERE.**

## TLR-1 HPL®

This high lumen, long-range, rail-mounted tactical light has an intensely bright, far-reaching beam with a large hotspot. It throws a wide beam to illuminate your target downrange, while illuminating everything in your path. Fits long-guns. Attaches/detaches with one hand in seconds. Includes a strobe for signaling/disorienting. Operates in extreme temperatures (-40°F to +120°F). IPX4-rated for water-resistance. Impact-resistant. Easy, fast battery replacement.

TLR-1 HPL W/REMOTE	TLR-1 HPL
<b>BATTERY:</b> (2) 3V "CR123A" lithium	<b>BATTERY:</b> (2) 3V "CR123A" lithium
<b>SIZE:</b> 5.25" x 1.44" x 2.2" (13.34x 3.66 x 5.59 cm)	<b>SIZE:</b> 4.83" x 1.44" x 2.2" (12.27x 3.66 x 5.59 cm)
<b>WEIGHT:</b> 5.6 oz (158.8 g)	<b>WEIGHT:</b> 5.3 oz (150.3 g)
<b>COLOR:</b> Black	<b>COLOR:</b> Black

69215	Standard model. Includes Rail Locating Keys for Glock style, MIL-STD-1913 rails, S&W 99/TSW, and Beretta 90two. Lithium batteries. Black.
69216	Remote model. Includes Rail Locating Keys for Glock style, MIL-STD-1913 rails, S&W 99/TSW, and Beretta 90two. Remote switch and Lithium batteries. Black.
69219	Long Gun Kit with thumbscrew, "Safe Off" door switch and remote pressure switch. Includes Rail Locating Keys for Glock style, MIL-STD-1913 rails, S&W 99/TSW, and Beretta 90two. Lithium batteries. Black.

### WHITE LIGHT ILLUMINATOR // HPL SERIES

<b>LUMENS:</b>	775
<b>CANDELA:</b>	48,000
<b>DISTANCE:</b>	438m
<b>RUN TIME:</b>	1h 45m



shown with standard switch backplate.



shown with remote switch backplate.

**775 LUMENS**



With **[(STROBE)]**  
 Double tap tailswitch to activate.



## TLR-1® GAME SPOTTER®

A long gun/long-range light with a green LED that preserves night vision and won't spook game. Mounts directly to long guns with MIL-STD-1913 (Picatinny) rails. Unbreakable, scratch-resistant, O-ring sealed lens. Operates in temperatures from -40°F to +120°F. IPX4-rated waterproof to 1 meter for 30 minutes. Impact resistant.

### TLR-1 GAME SPOTTER

**BATTERY:** (2) 3V "CR123A" lithium

**SIZE:** 4.83" x 1.44" x 2.2"  
(12.27 x 3.66 x 5.59 cm)

**WEIGHT:** 5.6 oz (158.8 g)

**COLOR:** Black

69227 Standard model. Includes Rail Locating Keys for Glock style, MIL-STD-1913 rails, S&W 99/TSW, and Beretta 90two. Lithium batteries. Black.

69228 Remote model. Includes Rail Locating Keys for Glock style, MIL-STD-1913 rails, S&W 99/TSW, and Beretta 90two. Remote switch and Lithium batteries. Black.

## GREEN LIGHT ILLUMINATOR // HP SERIES

**LUMENS:** 150  
**CANDELA:** 31,000  
**DISTANCE:** 352m  
**RUN TIME:** 1h 45m

### 150 LUMENS



With **[(STROBE)]**

Double tap tailswitch to activate.

shown with  
standard switch  
backplate.



shown with  
remote switch  
backplate.



# STREAMLIGHT

**OFFERS A COMPLETE RANGE OF  
IR ILLUMINATORS AND LASERS FOR  
USE WITH NIGHT VISION GOGGLES.**

## TLR-2® IR EYE SAFE

Lightweight, compact, lithium battery powered Gun-Mounted Infrared Active Illuminator with Class 1 eye safe integrated IR aiming laser. The illuminator features the latest in shock-proof high power infrared LED technology providing at least 7.5 hrs of continuous run time when in dual mode with the infrared laser. Rail clamp designed to rapidly attach/detach from side of weapon.

### TLR-2 IR EYE SAFE

**BATTERY:** (2) 3V "CR123A" lithium

**SIZE:** 3.39" x 1.47" x 1.83"  
(8.61 x 3.73 x 4.64 cm)

**WEIGHT:** 4.72 oz (133.8 g)

**COLOR:** Black

69166 IR w/ Eye Safe Laser. Includes Rail Locating Keys for Glock style, MIL-STD-1913 rails, S&W 99/TSW, and Beretta 90two. Lithium batteries. Black.

## IR ILLUMINATOR // EYE SAFE IR LASER

**IR LED OUTPUT:** 125mW/sr

**IR LASER OUTPUT:** Less than .8mW

**RUN TIME:** 7h 30m

IR Laser mode: 45+ hours of run time







## TLR-2® IRW



Features a Class 1 "Eye Safe" Infrared laser along with a blinding bright white light for long-range targeting. User programmable strobe enable/disable. Mounts directly to handguns with Glock-style rails and to all MIL-STD-1913 (Picatinny) rails. Operates in temperatures from -40°F to +140°F. IPX4-rated for water resistance.

### TLR-2 IRW EYE SAFE

**BATTERY:** (2) 3V "CR123A" lithium

**SIZE:** 3.39" x 1.47" x 1.83"  
(8.61 x 3.73 x 4.64 cm)

**WEIGHT:** 4.72 oz (133.8 g)

**COLOR:** Black

69165 TLR-2 IRW. Includes Rail Locating Keys for Glock style, MIL-STD-1913 rails, S&W 99/TSW, and Beretta 90two. Lithium batteries. Black.

## WHITE LIGHT ILLUMINATOR // EYE SAFE IR LASER

**LUMENS:** 300

**CANDELA:** 12,000

**IR LASER OUTPUT:** Less than .8mW

**DISTANCE:** 219m

**RUN TIME:** 2h 30m

Laser mode: 45+ hours of run time



**300 LUMENS**

## TLR-1® IR LED



Lightweight, compact, lithium battery powered Gun-Mounted Active Illuminator featuring the latest in high power infrared LED technology. The illuminator is built with a shock-proof LED and provides at least 7.5 hours of continuous run time. Rail clamp designed to rapidly attach/detach from side of weapon.

### TLR-1 IR LED

**BATTERY:** (2) 3V "CR123A" lithium

**SIZE:** 3.26" x 1.47" x 1.44"  
(8.28 x 3.73 x 3.65cm)

**WEIGHT:** 4.18 oz (118.6 g) with batteries

**COLOR:** Black

69150 IR. Includes Rail Locating Keys for Glock style, MIL-STD-1913 rails, S&W 99/TSW, and Beretta 90two. Lithium batteries. Black.

## IR ILLUMINATOR

**IR LED OUTPUT:** 125mW/sr

**IR RUN TIME:** 7h 30m



**TACTICAL** WEAPON-MOUNTED SERIES  
// STREAMLIGHT 2016



**TLR-VIR<sup>®</sup>**  
**BLINDING LIGHT OR  
INVISIBLE IR ILLUMINATOR...**  
**YOU CHOOSE.**

## TLR-VIR® PISTOL

This combination bright white C4® LED and Infrared illuminator is designed for use with a pistol. It has a lower profile than the original TLR-VIR, and it's waterproof to 66 ft. in its standard configuration. The IR illuminator is within the same lens as the white light. You can easily transition from white light to IR with a switch at the bottom of the light. There's no need to remove your eyes from the target or alter your firing grip. It has the standard momentary and constant-on ambidextrous switch as well.

### TLR-VIR PISTOL

**BATTERY:** (2) 3V "CR123A" lithium

**SIZE:** 3.39" x 1.47" x 1.44"  
(8.61 x 3.73 x 3.65cm)

**WEIGHT:** 4.2 oz (119 g) with batteries

**COLOR:** Black

69190 Includes rail locating keys for Glock style, MIL-STD-1913 rails, S&W 99/TSW, and Beretta 90two, and 2 CR123A lithium batteries.



*Ambidextrous Momentary/ steady On-Off switch*

## WHITE LIGHT ILLUMINATOR // IR ILLUMINATOR

### TLR-VIR PISTOL

**LUMENS:** 300

**CANDELA:** 11,000

**IR OUTPUT:** 1000mW/sr

**VISIBLE RUN TIME:** 2h 30m

**IR RUN TIME:** 32h

**300 LUMENS**



*3 Position mode selector switch  
(IR, safe off, visible)*



## TLR-VIR®

Designed to be used with a long gun, includes both a white LED and an Infrared (IR) illuminator for use with night vision goggles. Also features programmable strobe. Momentary/steady On-Off switch with plug port for momentary remote switch. Switch between white and IR as needed. User programmable strobe enable/disable. Includes a standard mount and remote switch. Operates in temperatures from -40°F to +150°F. IPX7-rated waterproof to 1 meter for 30 minutes. Designed to fit all long guns with MIL-STD-1913 rails.

### TLR-VIR

**BATTERY:** (2) 3V "CR123A" lithium

**SIZE:** 3.82" x 1.47" x 2.03"  
(9.70 x 3.73 x 5.16cm)

**WEIGHT:** 6.0 oz (170 g) with batteries, retained lens cap and remote switch

**COLOR:** Black

69180 Includes opaque lens cover, remote switch, 1913 key. (2) CR123A Lithium batteries.

## WHITE LIGHT ILLUMINATOR // IR ILLUMINATOR

### TLR-VIR

**LUMENS:** 300

**CANDELA:** 12,000

**IR OUTPUT:** 1000mW/sr

**VISIBLE RUN TIME:** 2h 30m

**IR RUN TIME:** 20h

**300 LUMENS**



With **[(STROBE)]**

*Double tap tailswitch to activate.*



*opaque lens cover*

**TLR SERIES ACCESSORIES**

At Streamlight, we engineer the highest performing, most rugged, durable and innovative lights on the market and the widest array of weapon mounted lights. Whether you're LED, S.W.A.T., Military, home defense or a sportsman, Streamlight builds the accessories you can depend on and the options and configurations that you need to accommodate all your weapon-mounted needs.

**MOUNTS**



**GRIPS**



**KEY KIT**



**REMOTES**

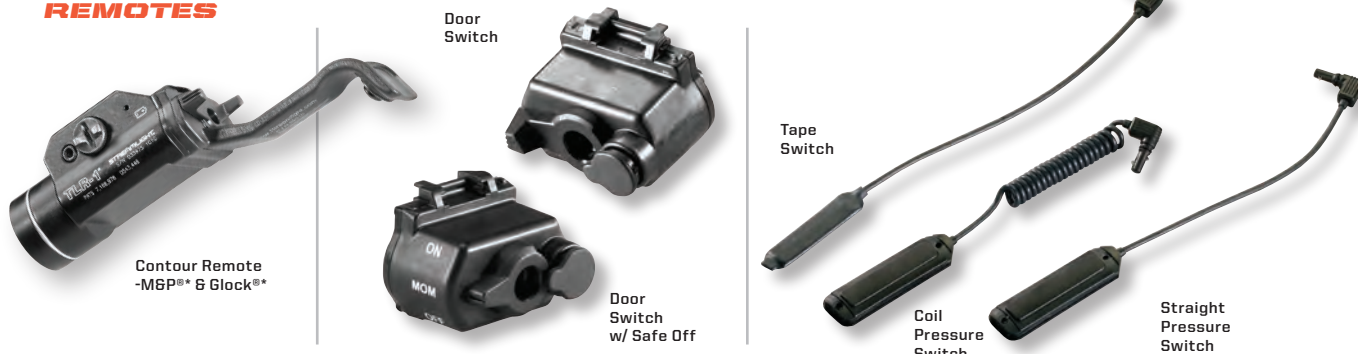

**HOLSTERS**



**LENSES**



**BATTERIES**



## TLR SERIES ACCESSORIES

TLR Accessories	TLR-1 HL/ TLR-2 HL	TLR-2 HL G	TLR-2 G	TLR-1/ TLR-1s	TLR-2/ TLR-2s	TLR-2 IR EYE SAFE	TLR-2 IRW	TLR-1 IR LED	TLR-1 HPL	TLR-1 GAMESPOTTER
Remington 870 Mount 	69906	69906	69906	69906	69906	69906	69906	69906	69906	69906
TLR 12 ga. Mag Mount 	69901	69901	69901	69901	69901	69901	69901	69901	69901	69901
AR-15 M16 Mount 	69902	69902	69902	69901	69902	69902	69902	69901	69902	69902
Ambidextrous Vert. Grip w/Rail 	69114	69114	69114	69114	69114	69114	69114	69114	69114	69114
TLR Key Kit 	69175	69175	69175	69175	69175	69175	69175	69175	69175	69175
Nylon Holster 	1: 69201 2: 69202	69202	69202	69201	69202	69202	69202	69201	-	-
Contour Remote -Glock® 	69300	69300	69300	69300	69300	69300	69300	69300	-	-
Contour Remote -M&P® 	69310	69310	69310	69310	69310	69310	69310	69310	-	-
Door Switch 	69130	69130	69130	69130	69130	69130	69130	69130	69130	69130
Door Switch w/Safe Off 	69161	69161	69161	69161	69161	69161	69161	69161	69161	69161
Tape Switch 	69132	69132	69132	69132	69132	69132	69132	69132	69132	69132
Coil Pressure Switch 	69134	69134	69134	69134	69134	69134	69134	69134	69134	69134
Straight Pressure Switch 	69135	69135	69135	69135	69135	69135	69135	69135	69135	69135
Red Flip Lens 	69115	69115	69115	69115	69115	-	69115	-	-	-
Blue Flip Lens 	69116	69116	69116	69116	69116	-	69116	-	-	-
Green Flip Lens 	69117	69117	69117	69117	69117	-	69117	-	-	-
IR Flip Lens 	69118	69118	69118	69118	69118	-	69118	-	-	-
Opaque Flip Lens 	69124	69124	69124	69124	69124	69124	69124	69124	-	-
CR123A Batteries 	2 Pk. // 85175 6 Pk. // 85180 12 Pk. // 85177 400 Pk. // 85179									

\* Note: Must be used in conjunction with 69130 remote door switch. Fits Glock® 17/22 and 19/23 size frames or Smith & Wesson M&P frames.



**STREAMLIGHT TLR-6**  
**PERFECTLY BALANCED**  
**PERFECTLY INTEGRATED.**

**TLR-6®**

An industry first, the ultra-compact TLR-6® weapon light with white light and red laser features ambidextrous operation and the ability to replace the batteries without removal from the weapon or the need to re-sight the laser. The light provides 1 hour of regulated runtime when in dual light/laser mode. Designed to securely attach to the trigger guard of the subcompact pistols. Durable, impact-resistant polymer construction. IPX4 water-resistant. 1 meter impact resistance tested.

**TLR-6**

**BATTERY:** (2) 3V CR-1/3 N lithium

**SIZE:**\* 2.30" x .085" x 1.42"  
 (5.84 x 2.16 x 3.61 cm)

**WEIGHT:**\* 1.27 oz (36 g)

**COLOR:** Black or Flat Dark Earth Brown

69270	TLR-6 (Glock® 42/43) with lithium batteries-Black
69278	TLR-6 (Glock® 42/43) with lithium batteries-Flat Dark Earth Brown
69272	TLR-6 (Glock® 26/27/33) with lithium batteries-Black
69273	TLR-6 (M&P Shield™) 40/9 with lithium batteries-Black
69274	TLR-6 (Kahr®) with lithium batteries-Black
69275	TLR-6 (SIG SAUER® P238/P938) with lithium batteries-Black
69276	TLR-6 (Kimber® Micro) with lithium batteries-Black
69277	TLR-6 Universal Kit includes all 6 housing models and 1 light/laser combo with lithium batteries-Black

\*Size & Weight vary by model. Glock® 42/43 listed.

**WHITE LIGHT ILLUMINATOR // RED LASER**

<b>LUMENS:</b>	100
<b>CANDELA:</b>	2,000
<b>DISTANCE:</b>	89m
<b>RUN TIME:</b>	1h

Laser mode: 11 hours of run time

**100 LUMENS**

**// NEW MODELS FOR 2016**

Fits the following weapons:

- Glock® 42, Glock® 43
- Glock® 26, Glock® 27, Glock® 33
- M&P Shield™ 40, M&P Shield™ 9
- Kahr® CT9, CT40, CW9, CW40, CM9, CM40, TP9, TP40, P9, P40, PM9, PM40
- SIG SAUER® P238, P938
- Kimber® Micro

All Rights Reserved. M&P Shield™, Glock®, SIG SAUER®, KIMBER®, & KAHR® are registered trademarks of Smith & Wesson, Glock®, Inc., SIG SAUER, KIMBER, IP LLC & Saeilo Enterprises, Inc. Streamlight has not sought endorsement of this product from Smith & Wesson®, Glock®, SIG SAUER®, KIMBER®, KAHR® Arms or Saeilo Enterprises, Inc.



Available in Flat Dark Earth Brown for Glock® 42/43

## TLR-4®

Designed for sub-compact and compact weapons with all the same great features as the TLR-3 plus a red laser to guide your aim. Operates in temperatures from -40°F to +120°F. IPX4-rated water-resistant.

### TLR-4

**BATTERY:** (1) 3V "CR2" lithium

**SIZE:** 2.73" x 1.2" x 1.99"  
(6.93 x 3.05 x 5.05 cm)

**WEIGHT:** 2.81 oz (79.7 g)

**COLOR:** Black

69240 Standard model includes rail locating keys for a variety of weapons with Picatinny or Glock style rails. Lithium battery. Black.

69241 H&K USP Compact Model. Black.

69242 H&K USP Full-Size Model. Black.

### TLR-3/TLR-4/TLR-4G ACCESSORIES:

Accessory Name	TLR-3	TLR-4/TLR-4G
CR2 lithium batteries—2 Pack	69223	69223
H&K USP Conversion Kit—Compact	69224	69224
H&K USP Conversion Kit—Full Size	69225	69225
Holster	69201	69202
Key Kit	69176	69176

## WHITE LIGHT ILLUMINATOR // RED LASER

LUMENS:	125
CANDELA:	5,300
RUN TIME:	1h 30m

Laser mode: 11 hours of run time



**125 LUMENS**



## TLR-3®

Lightweight and powerful, this super-bright light is designed for sub-compact and compact weapons, yet it fits the broadest array of handguns - up to full size. Operates in temperatures from -40°F to +120°F. IPX4-rated waterproof to 1 meter for 30 minutes.

### TLR-3

**BATTERY:** (1) 3V "CR2" lithium

**SIZE:** 2.71" x 1.18" x 1.51"  
(6.88 x 3 x 3.84 cm)

**WEIGHT:** 2.32 oz (65.8 g)

**COLOR:** Black

69220 Standard model includes rail locating keys for a variety of weapons with Picatinny or Glock style rails. Lithium battery. Black.

69221 H&K USP Compact Model. Black.

69222 H&K USP Full-Size Model. Black.

## WHITE LIGHT ILLUMINATOR //

LUMENS:	125
CANDELA:	5,300
RUN TIME:	1h 30m



**125 LUMENS**





**DURABILITY, POWER, LONG-RUNNING.**  
**ADVANTAGE:**  
**TLR TACTICAL LIGHTS**

**TLR-4® G**

Extremely compact weapon-mounted light specifically designed for compact/sub-compact weapons, yet still fits a broad range of handguns. Produces a concentrated beam with optimum peripheral illumination. It includes a long-range green laser to help guide your aim. Thanks to new technology, the laser operates through an extended temperature range - from -20°F to +120°F. IPX4-rated for water-resistance.

**TLR-4 G**

**BATTERY:** (1) 3V "CR2" lithium

**SIZE:** 2.73" x 1.2" x 1.99"  
(6.93 x 3.05 x 5.05 cm)

**WEIGHT:** 2.81 oz (79.7 g)

**COLOR:** Black

- |       |                                                                                                                                  |
|-------|----------------------------------------------------------------------------------------------------------------------------------|
| 69245 | Standard model includes rail locating keys for a variety of weapons with Picatinny or Glock style rails. Lithium battery. Black. |
| 69246 | H&K USP Compact Model. Black.                                                                                                    |
| 69247 | H&K USP Full-Size Model. Black.                                                                                                  |

**WHITE LIGHT ILLUMINATOR // GREEN LASER**

<b>LUMENS:</b>	115
<b>CANDELA:</b>	5,200
<b>RUN TIME:</b>	1h 45m

**115 LUMENS**





INTRODUCING THE TLR-2 HL G...  
**HOME DEFENSE  
 HAS GONE HIGH-LUMEN.**

**TLR-2 HL® G**

We added a direct drive green laser to this powerful high-lumen weapons light. The green is clearly visible to guide your aim even in bright sunlight. You can count on the light and laser even in extreme temperatures from -20°F to +120°F. IPX4-rated for water resistance.

**TLR-2 HL G**

**BATTERY:** (2) 3V "CR123A" lithium

**SIZE:** 3.39" x 1.47" x 1.83"  
 (8.61 x 3.73 x 4.64 cm)

**WEIGHT:** 4.78 oz (135.5 g)

**COLOR:** Black

69265 Includes Rail Locating Keys for Glock style, 1913 Picatinny, S&W 99/TSW, and Beretta 90two. Lithium batteries. Black.

**WHITE LIGHT ILLUMINATOR // GREEN LASER**

**LUMENS:** 800  
**CANDELA:** 15,000  
**DISTANCE:** 245m  
**RUN TIME:** 1h 30m

Laser mode: 17 hours of run time



UPDATED FOR 2016  
**300 LUMENS**



With **[(STROBE)]**  
 Double tap tailswitch to activate.

**TLR-2® G**

The G is for green. Highly visible (even in daylight) green laser assists in target acquisition. Mounts directly to handguns with Glock-style rails and to all MIL-STD-1913 (Picatinny) rails. Operates in temperatures from 32°F to 104°F. IPX4-rated for water-resistance. Features a strobe that can be disabled.

**TLR-2 G**

**BATTERY:** (2) 3V "CR123A" lithium

**SIZE:** 3.39" x 1.47" x 1.83"  
 (8.61 x 3.73 x 4.64 cm)

**WEIGHT:** 4.58 oz (130 g)

**COLOR:** Black

69250 Includes Rail Locating Keys for Glock style, 1913 Picatinny, S&W 99/TSW, and Beretta 90two. Lithium batteries. Black.

**WHITE LIGHT ILLUMINATOR // GREEN LASER**

**LUMENS:** 300  
**CANDELA:** 12,000  
**DISTANCE:** 159m  
**RUN TIME:** 2h 30m

Laser mode: 17 hours of run time



**300 LUMENS**



With **[(STROBE)]**  
 Double tap tailswitch to activate.

WHEN IT COMES TO HAND-HELD TACTICALS...  
**THE BRIGHTEST  
LIGHT CONTROLS  
THE FIGHT.**

**SUPER TAC® X**

Super bright with high, low and strobe modes. Far-reaching beam is ideal for long-range target acquisition. Unbreakable, scratch-resistant lens. IPX4-rated for water resistance. 2 meter impact-resistance tested. Openings O-ring sealed. Regulated intensity throughout battery life.

**SUPER TAC X**

**BATTERY:** (2) 3V "CR123A" lithium

**SIZE:** 6.62" x 2.2" x .9"  
(16.81 x 5.59 x 2.29 cm)

**WEIGHT:** 7.1 oz (200 g)

**COLOR:** Black

88708 with holster and lithium batteries. Boxed. Black.

88709 with lithium batteries. Clam packaged. Black.

88710 Super Tac Kit: Vert. grip with mount. Boxed. Black.

	HIGH	LOW
<b>LUMENS:</b>	200	10
<b>CANDELA:</b>	40,000	2,000
<b>DISTANCE:</b>	400m	89m
<b>RUN TIME:</b>	2h 30m	50h

Strobe runs 6 hours



Suitable for weapon-mount.



With **[(STROBE)]**  
Double tap switch to activate.

Super Tac Kit. Includes vertical grip with rail and low profile mount.

**TL-2® X**

Pierces the darkness and shines for hours. Produces smooth beam with optimum peripheral illumination to aid in navigation. High, low modes plus strobe. Includes belt/pocket clip. IPX4-rated for water-resistance. 3 meter impact-resistance tested. Maximum light output throughout battery life.

**TL-2 X**

**BATTERY:** (2) 3V "CR123A" lithium

**SIZE:** 5.65" x 1.25" x 0.9"  
(13.33 x 3.18 x 2.29 cm)

**WEIGHT:** 4.7 oz (129 g)

**COLOR:** Black

88119 with lithium batteries. Black.

	HIGH	LOW
<b>LUMENS:</b>	200	10
<b>CANDELA:</b>	11,000	550
<b>DISTANCE:</b>	210m	47m
<b>RUN TIME:</b>	2h 30m	50h

Strobe runs 6 hours



Suitable for weapon-mount.



With **[(STROBE)]**  
Double tap switch to activate.



	Remote Switch Retaining Clips	12 Ga. Mag Tube	Rail Mount	Amb. Vert Grip w/Rail	AR15/M16 Adapter	Low Profile Mount	Remote Switch w/Coil Cord*	Remote Switch w/8" Cord*
Super Tac X	88178	69903	69100	69114	69902	88118	88186	88185
TL-2 X	88178	69903	69100	69114	69902	88118	88186	88185
NightFighter X	-	-	-	-	-	-	-	-
Scorpion X	-	-	-	-	-	-	-	-

\*Fits TangoDown Rail Covers (includes two screws, tie wrap, double stick tape and retaining clips)

The only tactical light with a rubberized grip and tail switch is now a water-resistant, high lumen flashlight! It has 600 lumens of blinding light, TEN-TAP® programming and a new sleeve design for better grip.

**SCORPION HL**

**BATTERY:** (2) 3V "CR123A" lithium

**SIZE:** 5.46" x 1.375" x .96"  
(13.87 x 3.49 x 2.44 cm)

**WEIGHT:** 4.8 oz (136 g)

**COLOR:** Black

85400 with lithium batteries. Black.

	HIGH	LOW
<b>LUMENS:</b>	600	33
<b>CANDELA:</b>	16,000	800
<b>RUN TIME:</b>	1.25h	18h

Strobe runs 2h 30m

TEN-TAP® programmable switch allows user selection of one of three different programs:

- high/strobe/low (factory default)
- high only
- low/high



With **[(STROBE)]**  
Double tap switch to activate.



Full-featured tactical light with high, low and strobe modes and a rubberized housing for secure grip. IPX4-rated for water-resistance. Unbreakable, scratch-resistant lens. 3 meter impact-resistance tested. Maximum light output throughout battery life.

**SCORPION X**

**BATTERY:** (2) 3V "CR123A" lithium

**SIZE:** 5.6" x 1.25" x .94"  
(14.22 x 3.18 x 2.39 cm)

**WEIGHT:** 5.0 oz (142 g)

**COLOR:** Black

85011 with lithium batteries. Black.

	HIGH	LOW
<b>LUMENS:</b>	200	10
<b>CANDELA:</b>	11,000	550
<b>DISTANCE:</b>	210m	47m
<b>RUN TIME:</b>	2h 30m	50h

Strobe runs 6 hours



With **[(STROBE)]**  
Double tap switch to activate.



The brightest light in the ultra-light Nightfighter series. Unique adjustable ring for one-handed operation. Features high, low and strobe modes. IPX4-rated for water-resistance. 3 meter impact-resistance tested. Maximum light output throughout battery life.

**NIGHTFIGHTER X**

**BATTERY:** (2) 3V "CR123A" lithium

**SIZE:** 5.4" x 1.25" x .88"  
(13.72 x 3.18 x 2.24 cm)

**WEIGHT:** 5.2 oz (147 g)

**COLOR:** Black

88008 with lithium batteries. Black.

	HIGH	LOW
<b>LUMENS:</b>	200	10
<b>CANDELA:</b>	11,000	550
<b>DISTANCE:</b>	210m	47m
<b>RUN TIME:</b>	2h 30m	50h

Strobe runs 6 hours



With **[(STROBE)]**  
Double tap switch to activate.



The fully adjustable ring – unique to the NightFighter X – adjusts to any hand size, providing a sure grip for one-handed operation.

**TACTICAL ACCESSORIES**



	Nylon Holster	Tactical Holster	Red Flip Lens	Green Flip Lens	Blue Flip Lens	IR Flip Lens	CR123A Batteries
Super Tac X	75910	88051	–	–	–	–	2 Pk. 85175 6 Pk. 85180
TL-2 X	85905	88051	85115	85117	85116	74039	12 Pk. 85177
NightFighter X	85905	88051	85115	85117	85116	74039	400 Pk. 85179
Scorpion X	85905	88051	85115	85117	85116	74039	



Our legacy products remain available. Please see [www.streamlight.com](http://www.streamlight.com) for details.



**POLYTAC 90®**

This versatile, right-angle compact light is great for a wide variety of uses. It has a super-bright, far-reaching beam and a slip-resistant grip. It clips onto turnout gear or can be used as a headlamp. 90° swiveling head. Integrated carabiner style D-ring for a variety of attachment methods. IPX7-rated waterproof to 1 meter/30 minutes. 1 meter impact-resistant tested. Removable clip allows for variety of mounting positions

**POLYTAC 90**

**BATTERY:** (2) 3V "CR123A" lithium  
**SIZE:** 5.22" x 1.25" x 1"  
(13.3 x 3.18 x 2.54 cm)  
**WEIGHT:** 4.1 oz (116 g)  
**COLOR:** Black, Yellow or Orange

- 88830 with lithium batteries—Black
- 88831 with lithium batteries—Yellow
- 88834 with lithium batteries—Orange
- 88832 with lithium batteries & Gear Keeper®—Orange

**NFPA**

Meets requirements of  
NFPA 1971-8.6 (2007)

	HIGH	LOW
<b>LUMENS:</b>	170	17
<b>CANDELA:</b>	7,000	700
<b>DISTANCE:</b>	167m	53m
<b>RUN TIME:</b>	3h 45m	30h

Strobe runs 6 hours



Includes integrated clip and foldable hook.

Top-mounted switch for easy on/off.



**POLYTAC ACCESSORIES**

Gear Keeper® Tether features spectra nylon line with 36" extension and 6 oz. retraction force.



	Rubber Helmet Strap	Elastic Headstrap	Gear Keeper®	Deluxe Holster	Red Flip Lens	Green Flip Lens	Blue Flip Lens	Infrared Lens	Polymount Kit	CR123A Batteries
PolyTac	99075	—	—	85909	69115	69117	69116	69118	68089	2 Pk. 85175 6 Pk. 85180
PolyTac HP	99075	—	—	88051	—	—	—	—	—	12 Pk. 85177
PolyTac 90	—	14059	88833	85909	69115	69117	69116	69118	—	400 Pk. 85179

THE POLYTAC LIGHTS ARE SUPER-BRIGHT AND  
**WITHSTAND  
 CONSTANT  
 PUNISHMENT.**

**POLYTAC®**



Rugged housing, extreme brightness and extended run times make this ideal for the broadest range of lighting applications at the best value. Superior grip texture for a comfortable/slip-resistant feel. TEN-TAP® programming lets you choose the order of operating modes (high, low, strobe). IPX7-rated waterproof to 1 meter/30 minutes. Maximum light output throughout battery life.

**POLYTAC**

**BATTERY:** (2) 3V "CR123A" lithium

**SIZE:** 5.34" x 1.36" x 1"  
 (13.56 x 3.54 x 2.54 cm)

**WEIGHT:** 4.1 oz (116 g)

**COLOR:** Black, Coyote or Yellow

**NFPA**

Meets requirements of  
 NFPA 1971-8.6 (2007)

88850	with lithium batteries—Black
88851	with lithium batteries—Coyote
88853	with lithium batteries—Yellow
88854	Helmet Lighting Kit—includes rubber strap & helmet mount

**TRADITION SERIES**

	HIGH	LOW
<b>LUMENS:</b>	275	14
<b>CANDELA:</b>	9,500	500
<b>DISTANCE:</b>	195m	45m
<b>RUN TIME:</b>	3h	65h

Strobe runs 5h 30m



With **[(STROBE)]**  
 Double tap switch to activate.



Helmet Lighting Kit



**POLYTAC® HP**



Super-bright with a long-range beam – ideal for lighting the way to the end of a dark alley, down a wooded path, inspecting utility lines from the ground, or conducting search and rescue missions. Virtually indestructible housing. Features a superior grip texture for a comfortable/slip-resistant feel. TEN-TAP® programming lets you choose the order of operating modes (high, low, strobe). IPX7-rated waterproof to 1 meter/30 minutes. Maximum light output throughout battery life.

**POLYTAC HP**

**BATTERY:** (2) 3V "CR123A" lithium

**SIZE:** 5.90" x 1.68" x 1"  
 (14.35 x 4.26 x 2.54 cm)

**WEIGHT:** 5.2 oz (148 g)

**COLOR:** Black, Coyote or Yellow

88860	with lithium batteries—Black
88861	with lithium batteries—Coyote
88863	with lithium batteries—Yellow

**HP SERIES**

	HIGH	LOW
<b>LUMENS:</b>	275	14
<b>CANDELA:</b>	19,000	1,000
<b>DISTANCE:</b>	275m	63m
<b>RUN TIME:</b>	3h	56h

Strobe runs 5h 30m



With **[(STROBE)]**  
 Double tap switch to activate.



**PROTAC** WEAPON-MOUNTED SERIES  
// STREAMLIGHT 2016



# THE NEW PROTAC RAIL MOUNT LIGHTS SHATTER THE DARK WITHOUT BREAKING THE BANK.

## PROTAC® RAIL MOUNT 2

The ProTac series expands into weapon-mounted lights with this 625 lumen light featuring a dedicated fixed-mount for MIL-STD-1913 (Picatinny) rails. Lightweight, this bright, down range light can be used in close quarter compact or to identify medium range threats. Rugged and reliable. Its easy to use pressure switch comes with a button for on/off and a pressure switch for momentary activation. TEN-TAP® programming provides operator custom options.

### PROTAC RAIL MOUNT 2

**BATTERY:** (2) 3V "CR123A" lithium

**SIZE:** 5.00" x 1.50" x 1.20"  
(12.7 x 3.81 x 3.04 cm)

**WEIGHT:** 5.00 oz (141.7 g)

**COLOR:** Black

88059 with (2) lithium batteries-Black

CR123A	HIGH	LOW
<b>LUMENS:</b>	625	60
<b>CANDELA:</b>	22,000	2,000
<b>DISTANCE:</b>	297m	89m
<b>RUN TIME:</b>	2h	18h

Strobe runs 2h 45m

An additional tail cap switch is included in each Rail Mount package if the remote switch is not preferred.



TEN-TAP® Programmable switch allows user selection of one of three different programs:

- high/strobe (factory default)
- high only
- low/high



With **[(STROBE)]**  
Double tap switch to activate.

**NEW FOR 2016**  
**625 LUMENS**

## PROTAC® RAIL MOUNT 1

The new Streamlight ProTac® Rail Mount 1 features an integrated rail clamp that securely fits rifles, carbines and sub-machine guns with a MIL-STD-1913 (Picatinny) rail. It comes with both remote pressure and standard push-button tail switches and offers the added convenience of using either one lithium or one AA alkaline battery.

### PROTAC RAIL MOUNT 1

**BATTERY:** (1) 3V "CR123A" lithium or (1) "AA" Alkaline

**SIZE:** 4.25" x 1.50" x 1.20"  
(10.8 x 3.81 x 3.04 cm)

**WEIGHT:** 4.3 oz (121.9 g) w/CR123

**COLOR:** Black

88058 with (1) lithium battery-Black

CR123A	HIGH	LOW
<b>LUMENS:</b>	350	40
<b>CANDELA:</b>	12,000	1,380
<b>DISTANCE:</b>	219m	19m
<b>RUN TIME:</b>	1h 45m	14h 30m

Strobe runs 2h 45m

TEN-TAP® Programmable switch allows user selection of one of three different programs:

- high/strobe (factory default)
- high only
- low/high

**DUAL FUEL DESIGN:**  
Runs on one "AA" alkaline or CR123A lithium battery - both included.



With **[(STROBE)]**  
Double tap switch to activate.

**NEW FOR 2016**  
**350 LUMENS**

ALKALINE	HIGH	LOW
<b>LUMENS:</b>	150	40
<b>CANDELA:</b>	4,950	1,380
<b>DISTANCE:</b>	141m	19m
<b>RUN TIME:</b>	1h 30m	8h

Strobe runs 2h 45m

**NEED HIGH LUMEN PERFORMANCE?  
CHOOSE FROM THE  
PROTAC HL FAMILY  
INCLUDING THE NEW  
2,200 LUMEN PROTAC HL® 4.**

**PROTAC HL® 4**

With 2,200 lumens of blinding light, the ProTac HL® 4 is the newest and brightest addition to the ProTac® series. It offers the latest in power LED technology and three different user selectable programs. The output from the C4® LED results in one of the brightest tactical lights available. The sure grip rubber sleeve and included lanyard ensures you'll never lose your grip

**PROTAC HL 4**

**BATTERY:** (4) 3V "CR123A" lithium or (2) 18650 Li-Ion 3.7v 2600mAh rechargeables

**SIZE:** 8.63" x 2.35" x 1.24" (21.92 x 5.97 x 3.15 cm)

**WEIGHT:** 17 oz (482 g)

**COLOR:** Black

88060 with lithium batteries and holster—Black

**HL SERIES**

WITH CR123A	HIGH	MEDIUM	LOW
<b>LUMENS:</b>	2,200	600	60
<b>CANDELA:</b>	30,000	8,300	800
<b>DISTANCE:</b>	346m	182m	56m
<b>RUN TIME:</b>	1h 30m	4h	40h

Strobe runs 2h 30m

WITH 18650	HIGH	MEDIUM	LOW
<b>LUMENS:</b>	2,200	600	60
<b>CANDELA:</b>	30,000	8,300	800
<b>DISTANCE:</b>	346m	182m	56m
<b>RUN TIME:</b>	1h 45m	4h 15m	43h

Strobe runs 2h 30m

**DUAL FUEL DESIGN:**

Runs on CR123 or 18650 batteries

**TEN-TAP®** Programmable switch allows user selection of one of three different programs:

- high/strobe/low (factory default)
- high only
- low/med/high



With **[(STROBE)]**  
Double tap switch to activate.

**NEW FOR 2016**  
**2,200 LUMENS**



## PROTAC HL® 3

New technology allows us to put 1,100 lumens in the palm of your hands with a wide beam pattern that illuminates an entire area. TEN-TAP® programming lets you choose the order of operating modes (high, low, strobe). Sure grip rubber sleeve. IPX7-rated waterproof to 1 meter/30 minutes. 1 meter impact-resistance tested.

### PROTAC HL 3

**BATTERY:** (3) 3V "CR123A" lithium

**SIZE:** 7.1" x 1.73" x 1.0"  
(18.03 x 4.39 x 2.54 cm)

**WEIGHT:** 9.3 oz (263 g)

**COLOR:** Black

88047 with lithium batteries and holster—Black

88048 Holster

## HL SERIES

	HIGH	LOW
<b>LUMENS:</b>	1,100	35
<b>CANDELA:</b>	36,000	1,200
<b>DISTANCE:</b>	379m	69m
<b>RUN TIME:</b>	2h	43h

Strobe runs 2h



**1,100 LUMENS**



With **[(STROBE)]**  
Double tap switch to activate.

TEN-TAP® Programmable switch allows user selection of one of three different programs:

- high/strobe/low (factory default)
- high only
- low/high

## 18650 LI-ION BATTERIES AND CHARGER

The 18650 Li-Ion batteries provide an alternate power source for newer Streamlight products that accept either standard CR123A lithium batteries or 18650 batteries. The two bay 18650 battery charger can recharge one 18650 battery in as little as 3.5 hours, or two batteries in as little as 6.5 hours. The charger features dual input power sources, accepting either 5V USB power or 12VDC power. Dual input power sources provide a wide variety of battery charging options when a wall outlet is not available, such as a PC, power pack or 12VDC automotive power. Models available with charger, two 18650 batteries and either a 120V AC/micro-USB adapter or custom micro-USB cord, depending on model.

### 18650 LI-ION BATTERY AND CHARGER

**BATTERY:** 3.7V, 2600mAh, rechargeable

**CHARGER SIZE:** 4.5" x 2.0" x 1.45"  
(11.4 x 5.1 x 3.7cm)

**CHARGER WEIGHT:** 2.4 oz (68 g)

22010 18650 Charger Kit - USB (includes two 18650 batteries)

22011 18650 Charger Kit - 120V AC (includes two 18650 batteries)

Two bay design with single bay priority speeds charging when used with single battery products.

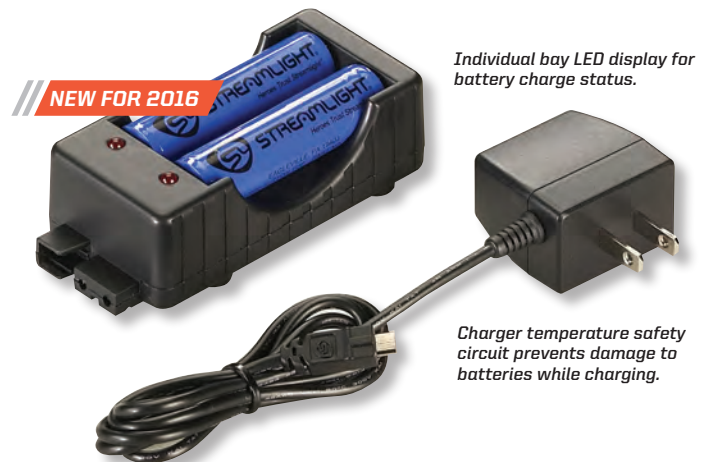

NEW FOR 2016

Individual bay LED display for battery charge status.

Charger temperature safety circuit prevents damage to batteries while charging.



**PROTAC HL® USB**

The ProTac HL USB is incredibly bright and features new multiple power source capability. It runs on either our lithium ion rechargeable battery, aftermarket Li-On 18650 rechargeable battery or CR123A batteries. It recharges by connecting to a USB port, so it's easy to charge on the go. Anti-rattle battery compartment keeps batteries securely and quietly in place and doesn't need a battery carrier. TEN-TAP® programming lets you choose the operating modes (high/strobe/low, high only or low/medium/high). IPX4-rated for water resistance.

**PROTAC HL USB**

**BATTERY:** Lithium-ion or (2) 3V "CR123A" lithium

**SIZE:** 6.5" x 1.23" x 1.07"  
(16.5 x 3.1 x 2.7 cm)

**WEIGHT:** 7.2 oz (204 g) with Li Ion battery

**COLOR:** Black

88052 with USB Cord and holster—Black

88054 with USB 120V/DC and holster—Black

22057 USB Cord

22058 120V AC Wall Adapter

	HIGH	MEDIUM	LOW
<b>LUMENS:</b>	850	350	85
<b>CANDELA:</b>	10,000	4,000	1,000
<b>DISTANCE:</b>	200m	126m	63m
<b>RUN TIME:</b>	1h 30m	4h	12h

Strobe runs 1h 30m

**TEN-TAP®** Programmable switch allows user selection of one of three different programs:

- high/strobe/low (factory default)
- high only
- low/medium/high



Recharge by plugging into USB port or optional AC wall adapter



**850 LUMENS**



With **[(STROBE)]**  
Double tap switch to activate.

# THE PROTAC HL FAMILY IS AS VERSATILE AS IT IS BRIGHT.

## PROTAC HL®

One of the brightest tactical personal carry lights of its size. Far-reaching beam. TEN-TAP® programming lets you choose the order of operating modes (high, low, strobe). IPX7-rated waterproof to 1 meter/30 minutes. 1 meter impact-resistance tested.

### PROTAC HL

**BATTERY:** (2) 3V "CR123A" lithium

**SIZE:** 5.4" x 1.375" x 1.0"  
(13.72 x 3.49 x 2.54 cm)

**WEIGHT:** 5.6 oz (158 g)

**COLOR:** Black

88040 with lithium batteries and holster-Black

88043 Holster

### HL SERIES

	HIGH	LOW
<b>LUMENS:</b>	750	35
<b>CANDELA:</b>	18,300	900
<b>DISTANCE:</b>	270m	60m
<b>RUN TIME:</b>	1h 15m	18h

Strobe runs 2h 30m

Nylon  
Holster



**750 LUMENS**



With **[(STROBE)]**  
Double tap switch to activate.

TEN-TAP® Programmable switch allows user selection of one of three different programs:

- high/strobe/low (factory default)
- high only
- low/high

## PROTAC HL® HEADLAMP

The perfect light for when your task requires both hands and a bright light with a wide, long-range beam. 90° tilting head reduces neck fatigue. TEN-TAP® programming lets you choose the order of operating modes (high, medium, low). IPX4-rated for water resistance. 1 meter impact-resistance tested. Maximum light output throughout battery life.

### PROTAC HL HEADLAMP

**BATTERY:** (2) 3V "CR123A" lithium

**SIZE:** 3.66" x 1.2" x 2.6"  
(9.30 x 3.05 x 6.60 cm)

**WEIGHT:** 6.6 oz (187 g)

**COLOR:** Black

61304 with lithium batteries-Black

### HL SERIES

	HIGH	MEDIUM	LOW
<b>LUMENS:</b>	635	105	20
<b>CANDELA:</b>	8,500	1,450	280
<b>DISTANCE:</b>	184m	76m	33m
<b>RUN TIME:</b>	1h 45m	8h	36h

TEN-TAP® Programmable switch allows user selection of one of three different programs:

- high/medium/low (factory default)
- high only
- low/medium/high



**635 LUMENS**



With **[(STROBE)]**  
Double tap switch to activate.

**PROTAC** SERIES  
// STREAMLIGHT 2016

THE PROTAC SERIES...  
**SMALLEST,  
LIGHTEST HAND-HELD  
TACTICALS.**



**PROTAC® 1L**  
**PROTAC® 2L**

They're both compact and lightweight, yet powerful and bright, with long run times and lots of important features. TEN-TAP® programming for user selection of mode programs (high, low, strobe). IPX7-rated waterproof to 1 meter for 30 minutes. 2 meter impact resistance tested. Maximum light output throughout battery life.

**PROTAC 1L**

**BATTERY:** (1) 3V "CR123A" lithium  
**SIZE:** 3.43" x .9" x .77"  
(8.71 x 2.29 x 1.96 cm)  
**WEIGHT:** 2.0 oz (57 g)  
**COLOR:** Black

**PROTAC 2L**

**BATTERY:** (2) 3V "CR123A" lithium  
**SIZE:** 4.77" x .9" x .77"  
(12.12 x 2.29 x 1.96 cm)  
**WEIGHT:** 2.8 oz (79 g)  
**COLOR:** Black

**PROTAC® 1L**

88030 with (1) lithium battery and holster - Black  
88035 Holster

**PROTAC® 2L**

88031 with (2) lithium batteries and holster - Black  
88036 Holster

	HIGH	LOW
<b>LUMENS:</b>	180	12
<b>CANDELA:</b>	3,800	250
<b>DISTANCE:</b>	123m	32m
<b>RUN TIME:</b>	2h	24h

Strobe runs 4 hours



Nylon Holster

TEN-TAP® Programmable switch allows user selection of one of three different programs:

- high/strobe/low (factory default)
- high only
- low/high



With **[(STROBE)]**  
Double tap switch to activate.

Nylon Holster



	HIGH	LOW
<b>LUMENS:</b>	260	13
<b>CANDELA:</b>	5,600	300
<b>DISTANCE:</b>	150m	35m
<b>RUN TIME:</b>	3h	50h

Strobe runs 6 hours

**PROTAC® EMS**

Provides optimal non-glare light for pupil and wound examination. Long run time. Tempered glass lens for maximum beam clarity. IPX7-rated waterproof to 1 meter for 30 minutes. Maximum light output throughout battery life. Removable pocket clip.

**PROTAC EMS**

**BATTERY:** (1) "AA" alkaline or lithium  
**SIZE:** 3.97" x .9" x .65"  
(10.08 x 2.29 x 1.65 cm)  
**WEIGHT:** 2.3 oz (65 g)  
**COLOR:** EMS Blue

88034 with (1) alkaline battery and holster - EMS Blue  
88037 Holster

	LOW	MED	HIGH
<b>LUMENS:</b>	3.6	10	50
<b>CANDELA:</b>	120	340	1,450
<b>DISTANCE:</b>	20m	36m	76m
<b>RUN TIME:</b>	36h	14h	1h 30m

Nylon Holster



## PROTAC® 1AA PROTAC® 2AA

Both models are small enough to carry in a pocket, lightweight, yet extremely bright. TEN-TAP® programming for user selection of mode programs (high, low, strobe). IPX7-rated waterproof to 1 meter for 30 minutes. 2 meter impact resistance tested. Maximum light output throughout battery life.

### PROTAC 1AA

**BATTERY:** (1) "AA" alkaline or lithium

**SIZE:** 4.16" x .9" x .65"  
(10.57 x 2.29 x 1.65 cm)

**WEIGHT:** 2.3 oz (65 g)

**COLOR:** Black

### PROTAC 2AA

**BATTERY:** (2) "AA" alkaline or lithium

**SIZE:** 6.14" x .9" x .65"  
(15.60 x 2.29 x 1.65 cm)

**WEIGHT:** 3.4 oz (96 g)

**COLOR:** Black

### PROTAC® 1AA

88032 with (1) alkaline battery and holster—Black

88037 Holster

### PROTAC® 2AA

88033 with (2) alkaline batteries and holster—Black

88038 Holster

	HIGH	LOW
<b>LUMENS:</b>	70	5
<b>CANDELA:</b>	1,450	125
<b>DISTANCE:</b>	76m	22m
<b>RUN TIME:</b>	2h	32h

Strobe runs 4 hours



With **[(STROBE)]**  
Double tap switch to activate.

	HIGH	LOW
<b>LUMENS:</b>	155	11
<b>CANDELA:</b>	3,300	200
<b>DISTANCE:</b>	115m	28m
<b>RUN TIME:</b>	2h	36h

Strobe runs 4 hours

Nylon  
Holster



Nylon  
Holster



## PROTAC® 2AAA

Lightweight personal flashlight with three modes (high, low, and strobe), a removable pocket clip and a 30-hr. run time on low. IPX7-rated waterproof to 1 meter for 30 minutes. Maximum light output throughout battery life.

### PROTAC 2AAA

**BATTERY:** (2) "AAA" alkaline

**SIZE:** 5.62" x .72" x .5"  
(14.27 x 1.83 x 1.27 cm)

**WEIGHT:** 2.0 oz (57 g)

**COLOR:** Black

### PROTAC® 2AAA

88039 w/alkaline batteries—Black

88045 Holster

	HIGH	LOW
<b>2AAA</b>		
<b>LUMENS:</b>	80	10
<b>CANDELA:</b>	1,550	200
<b>DISTANCE:</b>	80m	28m
<b>RUN TIME:</b>	1h 30m	30h

Strobe runs 5 hours



With **[(STROBE)]**  
Double tap switch to activate.



## PROTAC® 1AAA

Our smallest, brightest ProTac in the ProTac family. It's ultra-compact and ultra-powerful for its size with all the features of the ProTac family including TEN-TAP® programming. The perfect pocket light to carry with you wherever you go. IPX7-rated waterproof to 1 meter for 30 minutes. ProTac 1AAA also accepts a lithium battery for longer run time.

### PROTAC 1AAA

**BATTERY:** (1) "AAA" alkaline or lithium

**SIZE:** 3.94" x .71" x .57"  
(10.0 x 1.80 x 1.44 cm)

**WEIGHT:** 1.3 oz (37 g)

**COLOR:** Black

### PROTAC® 1AAA

88049 with (1) alkaline battery and holster—Black

	HIGH	LOW
<b>LITHIUM</b>		
<b>LUMENS:</b>	70	5
<b>CANDELA:</b>	550	40
<b>DISTANCE:</b>	47m	13m
<b>RUN TIME:</b>	2h 15m	22h

Strobe runs 5 hours

	HIGH	LOW
<b>ALKALINE</b>		
<b>LUMENS:</b>	70	5
<b>CANDELA:</b>	550	40
<b>DISTANCE:</b>	47m	13m
<b>RUN TIME:</b>	30m	11h

Strobe runs 1h 15m



With **[(STROBE)]**  
Double tap switch to activate.

TEN-TAP® Programmable switch allows user selection of one of three different programs:

- high/strobe/low (factory default)
- high only
- low/high

**SIDEWINDER®**

Meets a wide variety of hands-free illumination requirements with various color LEDs at different outputs. 185° tilting head and belt/web clip for multiple positioning/aiming of light. Designed for easy selection of light modes when in the field and when wearing gloves. IPX7-rated waterproof to 1 meter for 30 minutes. 3 meter impact-resistance tested. O-ring and gasket-sealed for waterproof operation. Meets MIL-STD-810F, METHOD 512.4.

**SIDEWINDER**

**BATTERY:** (2) "AA" alkaline or (2) "AA" lithium for extended operation in extreme temperatures (-40°F to +150°F)

**SIZE:** 2.34" x 1.08" x 4.65"  
 (5.94 x 2.74 x 11.81 cm)

**LITHIUM WEIGHT:** 4.38 oz (124 g)

**ALKALINE WEIGHT:** 5.02 oz (142 g)

**COLOR:** Coyote

**Military Model**

- 14000 w/alkaline-White, Red, Blue, IR LEDs. Clam packaged.  
NSN-6230-01-556-0487
- 14027 w/alkaline-White, Red, Blue, IR LEDs w/Helmet Mount. Clam packaged.  
NSN-6230-01-571-8752
- 14031 w/alkaline-White, Red, Blue, IR LEDs w/E-mount. Clam packaged.
- 14032 w/alkaline-White, Red, Blue, IR LEDs. Boxed.  
NSN-6230-01-571-1331

**Aviation Model**

- 14008 w/alkaline-White, Green, Blue, IR LEDs. Clam packaged.
- 14024 w/alkaline-White, Green, Blue, IR LEDs with MOLLE retainer. Boxed.  
NSN-6230-01-572-6216

<b>LUMENS:</b>	55
<b>CANDELA:</b>	1,175
<b>DISTANCE:</b>	69m
<b>RUN TIME:</b>	5h 30m



Tactile battery polarity indicator on body, aids in battery replacement in dark environments

**SIDEWINDER® RESCUE**

A lightweight hands-free lighting tool with four different color LEDs, each with varying intensities for a wide variety of tasks along with two flash patterns for signaling. The sliding diffuser projects omnidirectional light to be seen by all directions. Accepts either two "AA" alkaline batteries or two "AA" lithium batteries for maximum versatility in the field. IPX7 waterproof to 1 meter for 30 minutes.

**SIDEWINDER RESCUE**

**BATTERY:** (2) "AA" alkaline or (2) "AA" lithium for extended operation in extreme temperatures (-40°F to +150°F)

**SIZE:** 2.34" x 1.08" x 4.65"  
 (5.94 x 2.74 x 11.81 cm)

**LITHIUM WEIGHT:** 4.38 oz (124 g)

**ALKALINE WEIGHT:** 5.02 oz (142 g)

**COLOR:** Coyote

**Rescue Model**

- 14065 Kit (Aviation Model) White C4 LED, Green, Blue, IR LEDs Includes MOLLE retainer, paracord and 2 "AA" alkaline batteries. Boxed  
NSN-6230-01-581-2486
- 14069 Kit (Aviation Model) White C4 LED, Green, Blue, IR LED Includes MOLLE retainer, paracord and 2 "AA" alkaline batteries. Clam
- 14066 w/alkaline-White, Blue, Green, IR LEDs. Light only. Box
- 14067 w/alkaline-White, Blue, Green, IR LEDs. Light only. Clam
- 14068 w/alkaline-White, Blue, Green, IR LEDs. Includes E-Mount. Boxed

<b>LUMENS:</b>	55
<b>CANDELA:</b>	1,175
<b>DISTANCE:</b>	69m
<b>RUN TIME:</b>	5h 30m

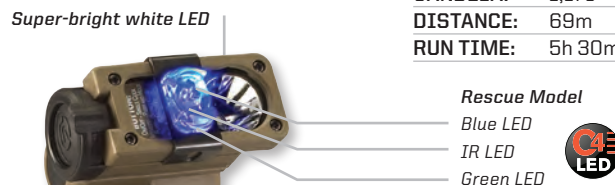

"Slide-in-Place" diffuser can be used with any LED color for omnidirectional light

Aluminum plate provides flat surface to adhere Velcro® for attaching to helmet

Cord attachment for para-cord lanyard, which provides extra security from loss of light and allows it to be worn around the neck

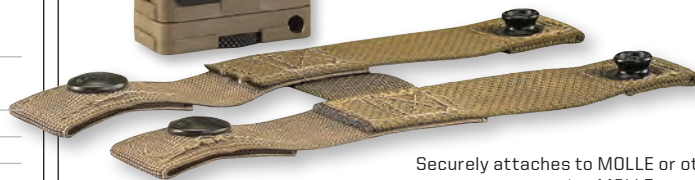

Securely attaches to MOLLE or other straps using MOLLE retainer



Extremely versatile lighting tool with white and a variety of color LEDs for multiple tasks. Fits in the palm of your hand, clips to MOLLE vest, belt, hat brim or pocket. Helmet mount is also available. Entire body rotates 185° for easy aiming of light. Unbreakable, scratch-resistant lens. Special design for easy operation even when wearing heavy gloves. IPX7-rated waterproof to 1 meter for 30 minutes. 3 meter impact-resistance tested. O-ring and gasket-sealed for waterproof operation. Meets MIL-STD-810F, METHOD 512.4.

**SIDEWINDER COMPACT II**

**MULTIPLE POWER SOURCES:**

(1) "CR123A" lithium, or (1) "AA" Alkaline, or (1) "AA" lithium

**SIZE:** 3" x 1.07" x 2.04"  
(7.62 x 2.72 x 5.21 cm)

**WEIGHT:** 2.4 oz (68 g)

**COLOR:** Coyote

**Military Model**

14510	White, Red, Blue, IR LEDs with Helmet Mount. Mailer NSN-6230-01-603-7205
14512	White, Red, Blue, IR LEDs with Helmet Mount. Clam
14513	White, Red, Blue, IR LEDs with E-Mount. Clam
14514	White, Red, Blue, IR LEDs with E-Mount and headstrap. Mailer NSN-6230-01-613-4312
14518	White, Red, Blue, IR LEDs with Helmet Mount and Rail Mount. Clam

**Aviation Model**

14531	White, Green, Blue, IR LEDs
14532	White, Green, Blue, IR LEDs w/Helmet Mount. Boxed
14533	White, Green, Blue, IR LEDs w/NVG Mount (for HGU-84 rotary wing aircrew helmet) and a AA alkaline battery. Boxed NSN-6230-01-626-6789

**Sidewinder Compact II Accessory Kits**

14112	Helmet Mount Accessory Kit-Coyote Helmet Mount, Headstrap, and MOLLE plate
14113	Rail Mount Accessory Kit-Coyote Rail Mount, Headstrap and MOLLE plate

	C4 HIGH W/CR123 LITHIUM	C4 HIGH W/"AA" LITHIUM	C4 HIGH W/"AA" ALKALINE
<b>LUMENS:</b>	55	47	47
<b>CANDELA:</b>	1,175	1,000	1,000
<b>DISTANCE:</b>	69m	63m	63m
<b>RUN TIME:</b>	6h	6h	2h



The Sidewinder Compact II is designed for versatility. It can operate on a "AA" Lithium, "AA" alkaline or CR123 Lithium battery.



**Military Model**

- Super-bright white C4® LED
- Blue LED
- IR/IFF LED
- Red LED

*Operates on either a AA Alkaline, AA Lithium or CR123A Lithium battery*



**Aviation Model**

- Super-bright white C4® LED
- Blue LED
- IR/IFF LED
- Green LED

**SIDEWINDER... THE MOST VERSATILE MILITARY LIGHT IN THE WORLD.**

**SIDEWINDER ACCESSORIES**

Sidewinder Accessories	Sidewinder	Sidewinder Compact II
Helmet Mount - Coyote	14055	14055
Rail Mount for Helmet - Coyote	14057	14057
	NSN-8470-01-633-3996	
Night Vision Goggle Mount	14135	14135
	NSN-5340-01-641-3916	
Safety Wand - Glow in the dark	14902	14902
Elastic Headstrap	-	14059
E-Mount (ACH, ECH, MICH, LWH compatible)	14136	14136
	NSN-5340-01-641-3930	
E-Mount Access. Kit (Includes E-Mount, MOLLE Retainer and paracord)	14137	14137
Paracord	14138	14138
Sidewinder Rescue Access. Kit (Includes MOLLE Retainer and paracord)	14139	14139
Helmet Mount Kit-Coyote Helmet Mount, Headstrap, and MOLLE plate	14112	14112
Rail Mount Kit-Coyote Rail Mount, Headstrap and MOLLE plate	14113	14113
CR123A Batteries		2 Pk. 85175 6 Pk. 85180 12 Pk. 85177 400 Pk. 85179

NON-RECHARGEABLE

**CAMO** BUCKMASTER SERIES  
// STREAMLIGHT 2016



WHEN YOU'RE HEADED INTO THE WOODS,  
**RELY ON THE EXPERTS...**  
**STREAMLIGHT & BUCKMASTERS.**

**BUCKMASTERS® TRIDENT®**

Hands-free lighting with 90° tilting head. Features super-bright, white C4 LED and 3 safety-green LEDs in the same reflector. Green LEDs preserve night vision and won't spook game. Unbreakable lens. Low battery indicator. IPX4-rated for water-resistance. 2 meter impact-resistance tested.

**BUCKMASTERS CAMO TRIDENT**

**BATTERY:** (3) "AAA" alkaline or lithium

**SIZE:** 1.75" x 2.70" x 2.40"  
(4.45 x 6.85 x 6.09 cm)

**WEIGHT:** 5.50 oz (156 g)

**COLOR:** RealTree® Hardwoods® Green High Definition (HD)

61070 with alkaline batteries - Camo



Camo Model	C4 LED	3 LEDs	1 LED
LUMENS:	80	20	6
CANDELA:	4,000	175	55
DISTANCE:	126m	26m	15m
RUN TIME:	5h	20h	63h





## BUCKMASTERS® STYLUS PRO®

Powerful multi-task penlight in RealTree® Hardwoods® camouflage for the great outdoors. Unbreakable, scratch-resistant lens. O-ring sealed, shock-proof and drop-tested. IPX4-rated for water-resistance. Removable pocket clip.

### BUCKMASTERS STYLUS PRO

**BATTERY:** (2) "AAA" alkaline

**SIZE:** 5.3" x .6"  
(13.4 x 1.5 cm)

**WEIGHT:** 1.64 oz (46.9 g)

**COLOR:** RealTree® Hardwoods® Green High Definition (HD)

66124 with Green LED – RealTree® Hardwoods® Green HD

66028 Holster

<b>LUMENS:</b>	5
<b>CANDELA:</b>	73
<b>DISTANCE:</b>	17m
<b>RUN TIME:</b>	11h



## BUCKMASTERS® PACKMATE®

Designed specifically for the outdoorsman's lighting needs, which features an extended run time mode and green LEDs that preserve night vision and will not spook game. Unbreakable lens. O-ring sealed for weather-resistance. Drop-tested.

### BUCKMASTERS PACKMATE

**BATTERY:** (2) 3V "CR123A" lithium

**SIZE:** 5.43" x 1.33" x .98"  
(13.79 x 3.38 x 2.49 cm)

**WEIGHT:** 5.44 oz (152 g)

**COLOR:** RealTree® Hardwoods® Green High Definition (HD)

51057 with lithium batteries – Camo

#### ACCESSORIES

85175 CR123A lithium batteries – 2 Pack

	C4 HIGH	C4 LOW	GREEN HIGH	GREEN LOW
<b>LUMENS:</b>	125	20	7.5	4
<b>CANDELA:</b>	6,000	1,000	80	40
<b>RUN TIME:</b>	2h 45m	15h	38h	52h



## BUCKMASTERS® TWIN-TASK® 2L

Lightweight, versatile light switches from powerful xenon bulb to 3 ultra-bright safety green LEDs that preserve night vision and won't spook game. Unbreakable lens. Water/corrosion-resistant, durable casing. O-ring sealed for weather-resistance. Drop-tested.

### BUCKMASTERS TWIN-TASK 2L

**BATTERY:** (2) 3V "CR123A" lithium

**SIZE:** 5.43" x 1.33" x .98"  
(13.79 x 3.38 x 2.49 cm)

**WEIGHT:** 5.44 oz (152 g)

**COLOR:** RealTree® Hardwoods® Green High Definition (HD)

51025 with lithium batteries – Camo

#### ACCESSORIES

85905 Nylon Holster

85175 CR123A lithium batteries – 2 Pack

	XENON	(3) GREEN LEDs
<b>LUMENS:</b>	72	10
<b>RUN TIME:</b>	2h 30m	28h





THE STYLUS PRO SERIES

# MORE OPTIONS TO USE IN EVEN MORE PLACES & WAYS!

## STYLUS PRO® USB & USB UV

## STYLUS PRO® 360

### STYLUS PRO UV W/400 nm UV LED

UV LED OUTPUT: 325mW

UV RUN TIME: 2h 30m

UV Model features a purple sleeve for easy identification



### STYLUS PRO

LUMENS: 70

CANDELA: 630

DISTANCE: 50m

RUN TIME: 3h 30m

Sliding metal sleeve protects micro USB port

Recharge by plugging into USB port or optional AC wall adapter

LUMENS: 65

CANDELA: 430

DISTANCE: 41m

RUN TIME: 6h 30m



BEZEL CLOSED



BEZEL OPEN



The 360° feature allows the light to be used as a small lantern



Rubber tail boot allows the light to stand upright

NEW FOR 2016

You won't want to be without this sleek, compact penlight that recharges at any USB port or with optional AC wall adaptor. Consistent light output throughout battery life. IPX4 water-resistant. 1 meter impact-resistance tested. Removable pocket clip. UV LED model provides ultraviolet light for detection of fraudulent documents, forensic investigations, or detecting engine or HVAC leaks.

### STYLUS PRO USB & USB UV

BATTERY: Lithium ion cell pack

SIZE: 6.15" x .74" (15.6 x 1.9 cm)

WEIGHT: 1.9 oz (53.8 g)

COLOR: Black

66133	with 120V AC adapter, USB cord, Nylon holster - Black
66134	with USB cord, nylon holster - Black
66149	Stylus Pro USB UV with USB cord, Nylon holster - Black
66148	UV with 120V AC adapter, USB Cord, Nylon holster - Black

### ACCESSORIES

66143	Stylus Pro USB Battery
22057	USB Cord
22058	120V AC Wall Adapter
66029	Holster

Versatile new light that functions as a typical Stylus Pro or adjust the head to reveal the 360° feature allows the light to be used as a small lantern. Equipped with a rubber tail boot allows the light to stand upright. It features a tail cap switch, momentary or constant on operation, a pocket clip for convenience, and amazing brightness and run time for a light of its size and price.

### STYLUS PRO 360

BATTERY: (2) "AAA" alkaline

SIZE: 5.9" x .64"  
(15 x 1.625 cm)

WEIGHT: 1.9 oz (53.8 g)

COLOR: Black

66218	Stylus Pro 360 - Black
-------	------------------------



**STYLUS PRO®**

**MICROSTREAM®**

	C4 WHITE LED	GREEN LED
LUMENS:	90	5
CANDELA:	860	73
DISTANCE:	58m	17m
RUN TIME:	6h 30m	11h

Holster

**UPDATED FOR 2016**

LUMENS:	45
CANDELA:	420
DISTANCE:	41m
RUN TIME:	2h 15m

**UPDATED FOR 2016**

Compact size, durable construction and optimum beam output make this an ideal light for multiple tasks. Unbreakable lens. O-ring sealed. IPX4-rated for water-resistance. 1 meter impact-resistance tested. Removable pocket clip.

**STYLUS PRO**  
**BATTERY:** (2) "AAA" alkaline  
**SIZE:** 5.3" x .6"  
 (13.4 x 1.5 cm)  
**WEIGHT:** 1.64 oz (46.9 g)  
**COLOR:** Matte Black, Silver, Blue or Red

- 66118 White LED—Matte Black
- 66121 White LED—Silver
- 66120 White LED—Red
- 66122 White LED—Blue
- 66124 with Green LED – RealTree® Hardwoods® Green HD
- 66028 Holster

So small, you can keep it in your pocket or clip it to a cap for hands-free lighting. Ideal if you carry a lot of gear and don't want to be weighed down. Unbreakable lens. O-ring sealed. IPX4-rated for water-resistance. 1 meter impact-resistance tested. Removable pocket/hat clip.

**MICROSTREAM**  
**BATTERY:** (1) "AAA" alkaline  
**SIZE:** 3.5" x .6"  
 (90 x 15 mm)  
**WEIGHT:** 1.04 oz (29.7 g)  
**COLOR:** Matte Black

- 66318 White LED—Black



## STYLUS®

This bright, long-running LED penlight has a long battery life, and it goes anywhere you need it. IPX4-rated for water-resistance. Removable pocket clip.

### STYLUS

**BATTERY:** (3) "AAAA" alkaline

**SIZE:** 6.21" x .375"  
(15.17 x .95 cm)

**WEIGHT:** 1.1 oz (31.19 g)

**COLOR:** Black, Gold, Silver, US Flag, Red, Blue, Camo or Olive Drab

65006	Red LED-Black
65012	White LED-Silver
65016	Blue LED-Silver
65018	White LED-Black
65020	Green LED-Black
65022	Blue LED-Black
65024	White LED-Gold
65035	White LED-Red
65050	White LED-Blue
65058	White LED-Black, UL Listed
65080	White LED-US Flag
65186	IR LED-Olive Drab
65075	Green LED-Camo
65030	AAAA Batteries-6 Pack
65905	Holster

SAFETY RATED  
MODEL OFFERED



Intrinsic Safety for Haz. Loc.  
Class I, Div. 1,  
Groups A, B, C, D, T3C  
"Classified"



Intrinsic Safety for Haz. Loc.  
Class I, Div. 1,  
Groups A, B, C, D, T3C  
"Exia"

<b>LED COLOR:</b>	<b>WHITE</b>	<b>GREEN</b>	<b>BLUE</b>	<b>RED</b>
<b>LUMENS:</b>	11	7	2	2
<b>CANDELA:</b>	140	59	110	53
<b>DISTANCE:</b>	24m	15m	21m	15m
<b>RUN TIME:</b>	24h	24h	24h	24h



SAFETY RATED MODEL OFFERED



## STYLUS® UV

An ultraviolet penlight for fluorescent detection of fraudulent documents and for use in forensic investigations. IPX4-rated for water-resistance. Removable pocket clip.

### STYLUS UV

**BATTERY:** (3) "AAAA" alkaline

**SIZE:** 6.21" x .375"  
(15.17 x .95 cm)

**WEIGHT:** 1.1 oz (31.19 g)

**COLOR:** Black

65069	365nm UV LED-Black
65905	Holster

<b>OUTPUT:</b>	3.8 mW
<b>RUN TIME:</b>	24h





## STYLUS PRO REACH®

We added an 8" PVC cable for extended reach and flexibility to our powerful Stylus Pro® penlight. It now provides 14" of reach to get intense light right where you need it. Unbreakable, scratch-resistant lens. O-ring sealed, shock-proof and drop-tested. IPX4-rated water-resistant. Unbreakable pocket clip.

### STYLUS PRO REACH

**BATTERY:** (2) "AAA" alkaline

**SIZE:** 14.6" x .6"  
(37.1 x 1.5 cm)

**WEIGHT:** 2.7 oz (76.5 g)

**COLOR:** Matte Black

66418 White LED includes Clip Holder – Matte Black

<b>LUMENS:</b>	38
<b>CANDELA:</b>	825
<b>DISTANCE:</b>	57m
<b>RUN TIME:</b>	8h

A textured grip for non-slip handling makes it easier to maneuver the light in slippery or wet conditions.



Magnetic  
Clip Holder

THE STYLUS SERIES ELIMINATES  
**HARD-TO-SEE**  
**NOOKS AND CRANNIES**  
**AND LIGHTS THE WAY.**

**STYLUS REACH®**

**STYLUS REACH® 18**

<b>LUMENS:</b>	11	Twist and turn the flexible cable into any position to light the most out-of-the-way places.
<b>CANDELA:</b>	140	
<b>DISTANCE:</b>	24m	
<b>RUN TIME:</b>	24h	



Features a high-intensity white LED and a 7" cable (providing 14" of reach) that allows you to see into the tightest spots. IPX4-rated for water-resistance. Pocket clip.

**STYLUS REACH**

**BATTERY:** (3) "AAAA" alkaline

**SIZE:** 14" x .375"  
(35.6 x .95 cm)

**WEIGHT:** 1.7 oz (48.2 g)

**COLOR:** Black or Silver

**SAFETY RATED  
 MODEL OFFERED**

65618	White LED-Black
65658	White LED-UL Listed Black
65612	White LED-Silver



**SAFETY RATED  
 MODEL OFFERED**



Intrinsic Safety for Haz. Loc.  
 Class I, Div. 1,  
 Groups A, B, C, D, T3C  
 "Classified"



Intrinsic Safety for Haz. Loc.  
 Class I, Div. 1,  
 Groups A, B, C, D, T3C  
 "Exia"

<b>LUMENS:</b>	11
<b>CANDELA:</b>	140
<b>DISTANCE:</b>	24m
<b>RUN TIME:</b>	24h



A textured grip for non-slip handling makes it easier to maneuver the light in slippery or wet conditions.

All the great features of the Stylus Reach® with a longer cable. With a total of 25.5" of reach, nothing is out of sight. IPX4-rated for water-resistance. Pocket clip.

**STYLUS REACH 18**

**BATTERY:** (3) "AAAA" alkaline

**SIZE:** 25.5" x .375"  
(64.77 x .95 cm)

**WEIGHT:** 3.5 oz (99.2 g)

**COLOR:** Black

65418	White LED-18" Cable-Black
65030	AAAA Batteries-6 Pack

"AAAA"  
 Batteries



**HEADLAMP** SERIES  
// STREAMLIGHT 2016







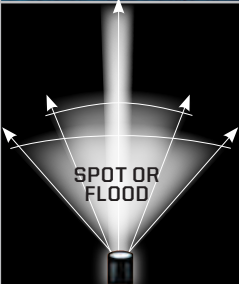

# HANDS-FREE LIGHTING SPECIALISTS

BECAUSE WORK IS TOUGH ENOUGH  
WITHOUT HAVING TO WORRY ABOUT  
YOUR LIGHTING.

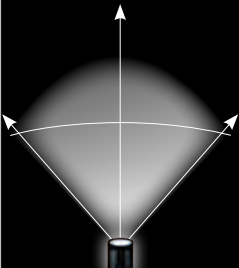

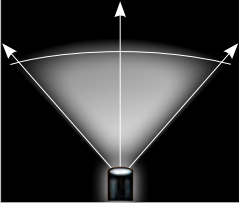
**STREAMLIGHT TASK-SPECIFIC TECHNOLOGY:  
CHOOSE THE LIGHT INTENSITY ALLOWING YOU TO  
CHOOSE THE RIGHT LIGHT FOR THE JOB.**

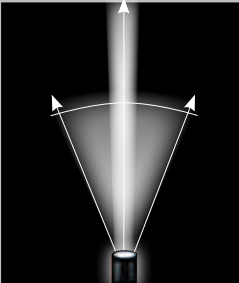
USE THIS EASY COMPARISON CHART TO CHOOSE THE BEST LIGHT FOR YOU BASED ON THE FEATURES THAT YOU NEED!

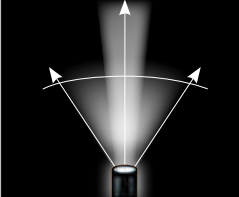
	BEAM STYLE	SPECS
<p><b>DOUBLE CLUTCH™ USB</b> Pg. 106</p> 	 <p>SPOT OR FLOOD</p>	<p>OUTPUT: 125 lumens INTENSITY: 1,700 candela BEAM DISTANCE: 82 meters RUN TIME: 3 hours 30 min SIZE: 1.75" x 2.50" x 1.66" (4.44 x 6.35 x 4.22 cm) WEIGHT: 4.0 oz (113 g) COLOR: Yellow or Black</p>
<p><b>PROTAC HL® HEADLAMP</b> Pg. 107</p> 		<p>OUTPUT: 635 lumens INTENSITY: 8,500 candela BEAM DISTANCE: 184 meters RUN TIME: 1 hours 45 min SIZE: 3.66" x 1.2" x 2.6" (9.29 x 3.05 x 6.60 cm) WEIGHT: 6.6 oz (187 g) COLOR: Black</p>
<p><b>SEPTOR®</b> Pg. 108</p> 		<p>OUTPUT: 120 lumens INTENSITY: 900 candela BEAM DISTANCE: 60 meters RUN TIME: 3 hours 30 min SIZE: 1.75" x 2.70" x 2.40" (4.45 x 6.85 x 6.09 cm) WEIGHT: 5.5 oz (156 g) COLOR: Yellow</p>
<p><b>ARGO®</b> Pg. 108</p> 		<p>OUTPUT: 150 lumens INTENSITY: 9,250 candela BEAM DISTANCE: 190 meters RUN TIME: 3 hours SIZE: 1.75" x 2.70" x 2.40" (4.45 x 6.85 x 6.09 cm) WEIGHT: 5.4 oz (153 g) COLOR: Yellow</p>
<p><b>TRIDENT® YELLOW</b> Pg. 109</p> 		<p>OUTPUT: 80 lumens INTENSITY: 4,000 candela BEAM DISTANCE: 126 meters RUN TIME: 5 hours SIZE: 1.75" x 2.70" x 2.40" (4.45 x 6.85 x 6.09 cm) WEIGHT: 5.50 oz (156 g) COLOR: Yellow</p>

HIGH MODE PERFORMANCE SHOWN.  
FOR PERFORMANCE IN OTHER  
MODES, SEE MODEL PAGES.



**THE DOUBLE CLUTCH.**  
**SPOT TO FLOOD**  
**IN ONE EASY**  
**SHIFT.**

**DOUBLE CLUTCH™ USB HEADLAMP**



**STREAMLIGHT TECHNOLOGY:**  
**DECADES OF ILLUMINATION**  
**INNOVATION.**



**SHIFT BEAMS //**

- SHIFTS EASILY TO SPOT OR FLOOD
- MODES WITH THE TURN OF THE WRIST
- GLOVE-FRIENDLY FACECAP ROTATION

**SHIFT BATTERIES //**

- USB RECHARGEABLE LITHIUM POLYMER OR "AAA" BATTERIES

**SHIFT BRIGHTNESS //**

- DOUBLE SHIFT FOR HIGH TO LOW IN SPOT OR FLOOD MODES.
- 125 LUMENS ON HIGH. 30 LUMENS ON LOW.



	HIGH	LOW	ALKALINE "AAA"	HIGH	LOW
LITHIUM POLYMER					
LUMENS:	125	30	LUMENS:	125	30
SPOT DIST:	82m	40m	SPOT DIST:	82m	40m
SPOT CANDELA:	1,700	400	SPOT CANDELA:	1,700	400
FLOOD DIST:	31m	4m	FLOOD DIST:	31m	4m
FLOOD CANDELA:	250	70	FLOOD CANDELA:	250	70
RUN TIME:	3h 30m	10h	RUN TIME:	6h	18h

This dual-power, dual-function, dual-output headlamp gives you the flexibility of using either a USB-rechargeable battery or 3 AAA alkaline batteries. It also lets you choose either a spot or a flood beam, both with high and low mode. It's lightweight and long-running with a 60° tilting head. Unbreakable lens. IPX4-rated. Water-resistant. 2 meter impact resistance tested.

**DOUBLE CLUTCH USB**

**BATTERY:** Rechargeable Lithium Polymer pack or (3) "AAA" alkaline or lithium batteries

**SIZE:** 1.75" x 2.50" x 1.66"  
(4.44 x 6.35 x 4.22 cm)

**WEIGHT:** 4.0 oz (113 g)

**COLOR:** Yellow or Black

Includes a rubber head strap that ensures a non-slip grip for hardhats.



YELLOW	BLACK	
61602	61603	120V AC with elastic and rubber straps
61600	61601	with USB Cord (only)
61607	61608	Alkaline Model
22058	22058	120V AC Wall Adapter
22057	22057	USB Cord
61604	61604	Lithium Polymer Battery



## PROTAC HL® HEADLAMP

	HIGH	MEDIUM	LOW
<b>LUMENS:</b>	635	105	20
<b>CANDELA:</b>	8,500	1,450	280
<b>DISTANCE:</b>	184m	76m	33m
<b>RUN TIME:</b>	1h 45m	8h	36h



**635 LUMENS**



### HL SERIES

The perfect light for when your task requires both hands and a bright light with a wide, long-range beam. 90° tilting head reduces neck fatigue. TEN-TAP® programming lets you choose the order of operating modes (high, medium, low). IPX4-rated for waster resistance. 1 meter impact-resistance tested. Maximum light output throughout battery life.

#### PROTAC HL HEADLAMP

**BATTERY:** (2) 3V "CR123A" lithium

**SIZE:** 3.66" x 1.2" x 2.6"  
(2.54 x 3.05 x 6.60 cm)

**WEIGHT:** 6.6 oz (187 g)

**COLOR:** Black

61304 with lithium batteries and elastic and rubber straps—Black

## ENDURO®

One of the lightest, brightest and most comfortable headlamps. Features an integrated rubber/elastic combination head strap and a clip that attaches to the brim of your hat, coat lapel or car visor. Unbreakable lens. O-ring sealed, waterproof to 1 meter for 1 hour. Impact-resistant housing - drop-test verified. Maximum light output throughout battery life.

#### ENDURO HEADLAMP

**BATTERY:** (2) "AAA" alkaline

**SIZE:** 1.3" x 2.25" x 1.6"  
(3.25 x 5.7 x 4 cm)

**WEIGHT:** 2.75 oz (78.5 g)

**COLOR:** Black or RealTree® Hardwoods® Green High Definition (HD)

61400 with alkaline batteries—elastic strap and visor clip—Black  
61405 with alkaline batteries—elastic strap and visor clip—Camo



	HIGH	LOW
<b>WHITE LED</b>		
<b>LUMENS:</b>	14.5	6
<b>CANDELA:</b>	850	—
<b>RUN TIME:</b>	6h	12h

Includes integrated rubber/elastic combination head strap and a clip that attaches to the brim of your hat, coat lapel or car visor.



STREAMLIGHT HEADLAMPS GIVE YOU THE  
**VERSATILITY**  
AND THE BRIGHTNESS  
YOU NEED TO ACCOMPLISH  
ANY TASK.

**SEPTOR®**

**ARGO®**

	HIGH	MED	LOW
LUMENS:	120	45	13
CANDELA:	900	375	100
DISTANCE:	60m	35m	20m
RUN TIME:	3h 30m	10h	55h



Includes a rubber head strap that ensures a non-slip grip for hardhats.

	HIGH	MED	LOW
LUMENS:	150	100	45
CANDELA:	9,250	6,375	2,750
DISTANCE:	190m	160m	103m
RUN TIME:	3h	4h 30m	30h



Includes a rubber head strap that ensures a non-slip grip for hardhats.

The Septor task-light headlamp now shines brighter! When you need a hands-free flood light for close-up tasks or tasks at arm's length, the Septor gives you 120 lumens of a soft, wide beam to illuminate your work area.

**SEPTOR HEADLAMP**

**BATTERY:** (3) "AAA" alkaline

**SIZE:** 1.75" x 2.70" x 2.40"  
(4.45 x 6.85 x 6.09 cm)

**WEIGHT:** 5.5 oz (156 g)

**COLOR:** Yellow

**SEPTOR HEADLAMP**

61052 with alkaline batteries—rubber and elastic straps—Yellow



Class I, Div. 2, Groups A, B, C, D;  
Class II, Div. 2, Groups F, G,  
Class III, T5

Featuring an intense, long-distance beam for down range illumination with 3 levels of output.

**ARGO HEADLAMP**

**BATTERY:** (3) "AAA" alkaline

**SIZE:** 1.75" x 2.70" x 2.40"  
(4.45 x 6.85 x 6.09 cm)

**WEIGHT:** 5.4 oz (153 g)

**COLOR:** Yellow

**ARGO HEADLAMP**

61301 with alkaline batteries—rubber and elastic straps—Yellow



Class I, Div. 2, Groups A, B, C, D;  
Class II, Div. 2, Groups F, G,  
Class III, T5



## TRIDENT®

The Trident multi-purpose headlamp now shines brighter! When you need the versatility of switching between either a bright light to illuminate objects at a distance (126 meters) or a soft flood light for tasks at arm's length.

### TRIDENT HEADLAMP

**BATTERY:** (3) "AAA" alkaline  
**SIZE:** 1.75" x 2.70" x 2.40"  
 (4.45 x 6.85 x 6.09 cm)

**WEIGHT:** 5.50 oz (156 g)

**COLOR:** Yellow or Green or RealTree® Hardwoods® Green High Definition (HD)

### THREE TRIDENT MODELS:

**Yellow Model:** Contains C4® LED and three ultra-bright white LEDs

**Green Model:** Contains C4® LED, one safety green LED, two white 5mm LEDs

**Buckmasters Camo Model:** RealTree® Hardwoods® Green High Definition camo; contains super-bright C4 LED and three safety-green 5mm LEDs

### TRIDENT HEADLAMP

61051 2 White and 1 Green LED with alkaline batteries—Green

61050 with White LEDs with alkaline batteries—Yellow

61070 3 Green LEDs with alkaline batteries—Camo



Class I, Div. 2, Groups A, B, C, D;  
 Class II, Div. 2, Groups F, G,  
 Class III, T5



### Yellow

Model	C4 LED	3 LEDS	1 LED
LUMENS:	80	35	11
CANDELA:	4,000	385	120
DISTANCE:	126m	39m	22m
RUN TIME:	5h	10h	53h

### Green

Model	C4 LED	3 LEDS	1 LED
LUMENS:	80	25	6
CANDELA:	4,000	275	55
DISTANCE:	126m	33m	15m
RUN TIME:	5h	19h 30m	63h

### Camo

Model	C4 LED	3 LEDS	1 LED
LUMENS:	80	20	6
CANDELA:	4,000	175	55
DISTANCE:	126m	26m	15m
RUN TIME:	5h	20h	63h



90° tilting head with a new, more durable ratcheting system.



Includes a rubber head strap that ensures a non-slip grip for hardhats.

THE TWIN-TASK SERIES HAS  
**VERSATILITY**  
BUILT RIGHT IN.

**TWIN-TASK® 3C LED**

**TWIN-TASK® 3C-UV LED**



CHOOSE FROM C4®, 6 LEDS OR 3 LEDS.

	C4 LED	6 LED	3 LED
LUMENS:	180	80	50
CANDELA:	3,550	980	612
DISTANCE:	120m	62m	50m
RUN TIME:	26h	48h	72h



CHOOSE FROM C4®, 6 UV LEDS OR 3 UV LEDS.

	C4 LED	6 UV LED	3 UV LED
LUMENS:	185	40mw	30mw
CANDELA:	3,730	n/a	n/a
DISTANCE:	116m	n/a	n/a
RUN TIME:	27h	63h	81h

Three lighting modes let you choose exactly the brightness, distance and run time you need. Provides an even beam, along with a piercing hotspot for distance. Unbreakable lens. IPX4-rated for water-resistance. O-ring sealed. 1 meter impact-resistance tested.

**TWIN-TASK 3C LED**  
BATTERY: (3) "C" alkaline  
SIZE: 9.02" x 1.68" x 1.26"  
(22.9 x 4.26 x 3.2 cm)  
WEIGHT: 1 lb (449 g)  
COLOR: Matte Black

51039 Matte Black

Three lighting modes include ultraviolet light for detection of fraudulent documents or engine and HVAC leaks. The white LED mode provides an even beam with a piercing hotspot for distance. Unbreakable lens. IPX4-rated for water-resistance. O-ring sealed. 1 meter impact-resistance tested.

**TWIN-TASK 3C UV LED**  
BATTERY: (3) "C" alkaline  
SIZE: 9.02" x 1.68" x 1.26"  
(22.9 x 4.26 x 3.2 cm)  
WEIGHT: 1 lb (449 g)  
COLOR: Matte Black

51045 Matte Black

THEY'RE CALLED TWIN-TASK<sup>®</sup>,

**BUT THESE LIGHTS  
ARE SO VERSATILE,**

THEY SHOULD  
BE CALLED... **ANY-TASK.**

**TWIN-TASK<sup>®</sup> 3AA LED**



CHOOSE FROM C4<sup>®</sup>, OR 3 LED.

	C4 LED	3 LED
LUMENS:	100	33
CANDELA:	2,283	467
DISTANCE:	96m	43m
RUN TIME:	5h 45m	34h

Versatile, long-running light that cuts through the dark with extreme brightness. Choose either the piercing bright beam with a hotspot for distance or the ultra-bright beam for area lighting and a longer run time. Unbreakable lens. IPX4-rated for water-resistance. O-ring sealed. 1 meter impact-resistance tested.

**TWIN-TASK 3AA LED**  
**BATTERY:** (3) "AA" alkaline  
**SIZE:** 8.54" x 1.33" x .79"  
 (21.7 x 3.38 x 2.0 cm)  
**WEIGHT:** 6.91 oz (196 g)  
**COLOR:** Matte Black

51038 with alkaline batteries. Matte Black.

**TWIN-TASK<sup>®</sup> 3AAA LASER LED**



CHOOSE FROM C4<sup>®</sup>, 5 LED OR LASER.

	C4 LED	5 LED
LUMENS:	100	68
CANDELA:	2,000	800
DISTANCE:	90m	57m
RUN TIME:	2h 45m	5h 15m

Features a mode with piercing brightness and a hotspot for distance, plus a mode for ultra-bright area lighting and extended runtime. Also includes a red laser pointer. Unbreakable lens. IPX4-rated for water-resistance. O-ring sealed. 1 meter impact-resistance tested.

**TWIN-TASK 3AAA LASER LED**  
**BATTERY:** (3) "AAA" alkaline  
**SIZE:** 5.38" x 1.57" x 1.17"  
 (13.69 x 3.98 x 2.98 cm)  
**WEIGHT:** 7.04 oz (200 g)  
**COLOR:** Matte Black

51043 with alkaline batteries. Matte Black.



**TWIN-TASK® 1L LED**  
**TWIN-TASK® 2L LED**

**TASK-LIGHT® 3AA LED**



TWIN-TASK 1L LED	C4 LED	LED
LUMENS:	96	20
CANDELA:	2,117	200
DISTANCE:	92m	28m
RUN TIME:	2h 15m	13h



CHOOSE FROM C4®, OR 3 LEDs.



TWIN-TASK 2L LED	C4 LED	LED
LUMENS:	120	31
CANDELA:	2,483	375
DISTANCE:	100m	39m
RUN TIME:	4h	15h



LUMENS:	95
CANDELA:	1,600
RUN TIME:	16h

These compact, lightweight flashlights feature two lighting modes: A C4® LED that provides a bright, even beam with a piercing hotspot for distance; and 3 ultra-bright LEDs for area lighting and extended run time. Unbreakable lens. IPX4-rated for water-resistance. O-ring sealed. 1 meter impact-resistance tested.

**TWIN-TASK 1L LED**  
BATTERY: (1) 3V "CR123A" lithium  
SIZE: 4.09" x 1.33" x .98"  
(10.39 x 3.38 x 2.49 cm)  
WEIGHT: 4.1 oz (115 g)  
COLOR: Matte Black

**TWIN-TASK 2L LED**  
BATTERY: (2) 3V "CR123A" lithium  
SIZE: 5.43" x 1.33" x .98"  
(13.79 x 3.38 x 2.49 cm)  
WEIGHT: 5.44oz (152 g)  
COLOR: Matte Black

**TWIN-TASK® 1L LED**  
51036 with lithium battery. Matte Black.

**TWIN-TASK® 2L LED**  
51037 with lithium batteries. Matte Black.

The long life of an LED with the longer range and brighter beam of a conventional high-powered light. Unbreakable lens. O-ring sealed for water-resistance. Drop-tested.

**TASK-LIGHT 3AA LED**  
BATTERY: (3) "AA" alkaline  
SIZE: 8.60" x 1.33" x .79"  
(21.7 x 3.38 x 2.01 cm)  
WEIGHT: 6.4 oz (180 g)  
COLOR: Matte Black or Titanium

51006 with alkaline batteries. Matte Black.

51016 with alkaline batteries. Titanium.



## NIGHT COM® LED

Choose from 3 lighting options: C4® LED for extreme brightness, night vision protection that meets or exceeds MIL-1472D, or ultra-bright red for use when night vision preservation is not needed. Unbreakable lens. O-ring sealed for weather resistance. Drop-tested.

**NIGHT COM LED**  
**BATTERY:** (2) 3V "CR123A" lithium  
**SIZE:** 5.43" x 1.33" x .98"  
 (13.79 x 3.38 x 2.49 cm)  
**WEIGHT:** 5.44 oz (152 g)  
**COLOR:** Matte Black

51056 with lithium batteries. Red LEDs. Matte Black.



	C4 LED	LED
<b>LUMENS:</b>	105	2.5
<b>CANDELA:</b>	4,500	-
<b>RUN TIME:</b>	3h 30m	28h

LED - Indicator Type: Preserves complete dark adaptation per MIL-1472D (<0.05 lumens)



## NIGHT COM® UV

Choose a far-reaching, bright, white light or an ultraviolet light for detection of fraudulent documents and detecting engine/HVAC leaks. Unbreakable lens. IPX4-rated for water-resistance. 1 meter impact-resistance tested.

**NIGHT COM UV**  
**BATTERY:** (2) 3V "CR123A" lithium  
**SIZE:** 5.40" x 1.33" x .98"  
 (13.7 x 3.39 x 2.49 cm)  
**WEIGHT:** 5.44 oz (152 g)  
**COLOR:** Matte Black

51046 with lithium batteries. Matte Black.



	HIGH C4 LED	LOW C4 LED
<b>LUMENS:</b>	115	50
<b>CANDELA:</b>	4,200	1,600
<b>DISTANCE:</b>	130m	80m
<b>RUN TIME:</b>	4h 15m	13h 30m

UV LEDs: 10 Hours of continuous run time

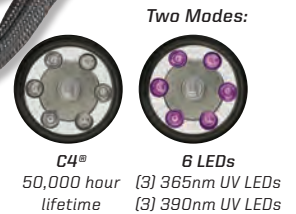

## MULTI OPS®

An ultra-bright white light, or (5) UV LEDs for fluid detection, and a laser pointer all in one. IPX4-rated for water-resistance. All openings are O-ring or gasket sealed. 1 meter impact-resistance tested.

**MULTI-OPS**  
**BATTERY:** (3) "AAA" alkaline  
**SIZE:** 5.38" x 1.57" x 1.17"  
 (13.69 x 3.98 x 2.98 cm)  
**WEIGHT:** 7.04 oz (200 g)  
**COLOR:** Matte Black

51072 with alkaline batteries. Matte Black.



<b>LUMENS:</b>	50
<b>CANDELA:</b>	2,500
<b>DISTANCE:</b>	100m
<b>RUN TIME:</b>	4h 45m

C4 + UV LEDs: 4 Hours of continuous run time  
 UV LEDs: 10 Hours of continuous run time

**LASER OUTPUT:** Useable laser range of 100+ feet when in LED/laser mode, and 100+ yards when in laser only mode.

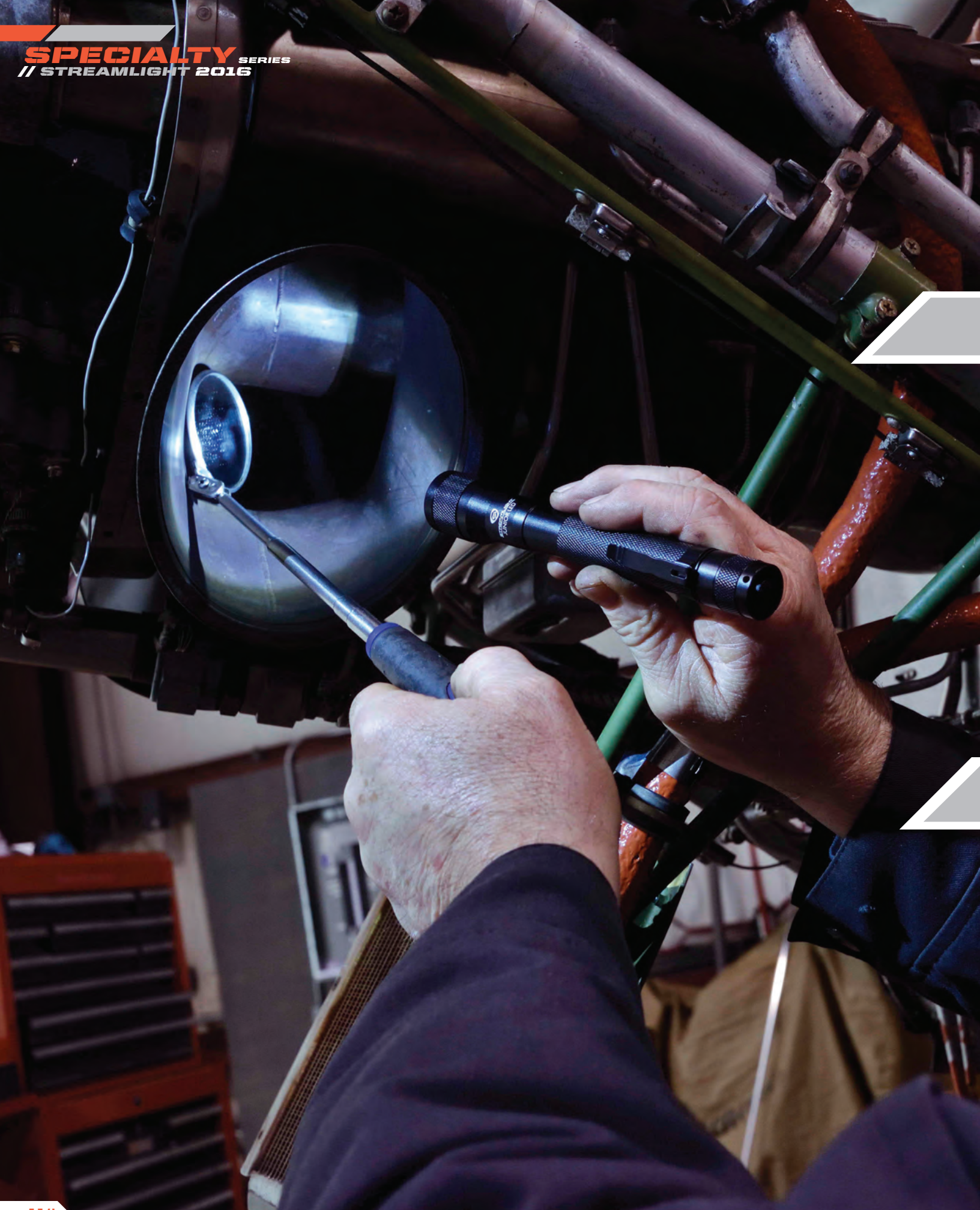

# THE LIGHT SEEN IN EVERY TOOL BOX, IS THE LIGHT THAT CAN HELP YOU SEE ANYWHERE.

## STREAMLIGHT JR.<sup>®</sup> LED

Cutting edge technology makes this lightweight flashlight super-bright and super-convenient. Unbreakable lens. Regulated light output throughout battery life. IPX4-rated for water-resistance. All openings are O-ring sealed. 1 meter impact-resistance tested.

### STREAMLIGHT JR. LED

**BATTERY:** (2) "AA" alkaline or lithium

**SIZE:** 6.5" x 1" x .73"  
(16.51 x 2.54 x 1.85 cm)

**WEIGHT:** 4.1 oz (117 g)

**COLOR:** Black

71500	with alkaline batteries. Black.
71503	Nylon Holster
71510	Magnetic Clip Holder
99075	Rubber Helmet Strap

LUMENS:	85
CANDELA:	3,800
DISTANCE:	123m
RUN TIME:	4h



Magnetic Clip Holder

Rubber Helmet Strap

Nylon Holster

## STREAMLIGHT JR.<sup>®</sup> REACH LED

With its flexible cable and magnetic clip, you can put this handy light anywhere and see anything. Unbreakable lens. IPX4-rated for water-resistance. All openings O-ring sealed. 1 meter impact-resistance tested.

### STREAMLIGHT JR. REACH LED

**BATTERY:** (2) "AA" alkaline

**SIZE:** 20" x .8" x .73"  
(50.8 x 2.03 x 1.85 cm)

**WEIGHT:** 6.1 oz (173 g)

**COLOR:** Black

71600	with alkaline batteries. Black.
71510	Magnetic Clip Holder

LUMENS:	140
CANDELA:	1,500
DISTANCE:	80m
RUN TIME:	4h 30m

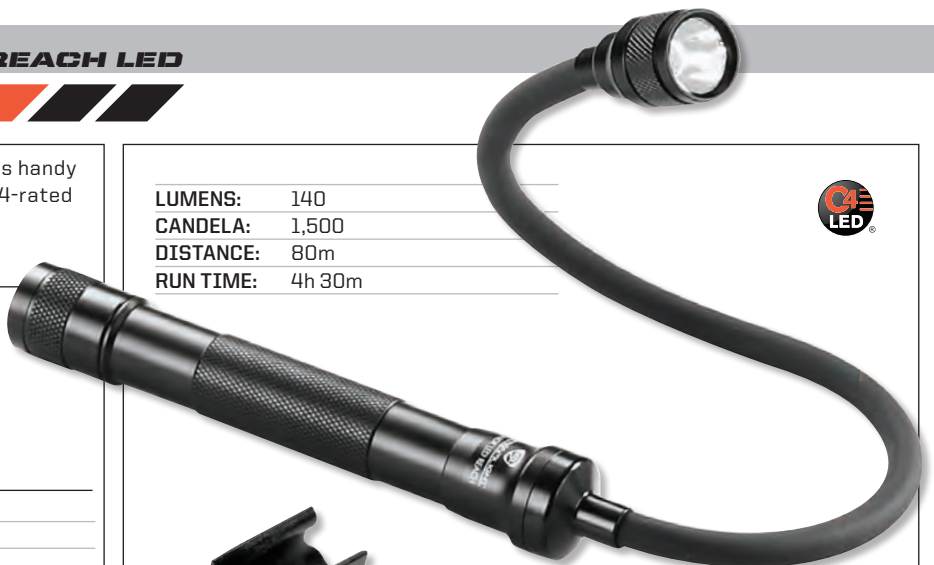

Magnetic Clip Holder

UPDATED FOR 2016

# POCKET LIGHT SERIES

## // STREAMLIGHT 2016



### CLIPMATE® USB



This multi-function light clips to pocket or cap for hands-free use. Recharges by plugging into USB port or optional AC wall adaptor. IPX4 water-resistant. 1 meter impact-resistance tested.

#### CLIPMATE USB

**BATTERY:** Lithium polymer cell

**SIZE:** 3.20" x 1.39" x .65"  
(8.1 x 3.5 x 1.7 cm)

**WEIGHT:** 1.9 oz (53.8 g)

**COLOR:** Black



**LUMENS:** 70 5 (red)  
**CANDELA:** 500  
**DISTANCE:** 44m  
**RUN TIME:** 3.5h

Flexible, extension cable targets the beam where you need it

Dual LEDs: High-intensity white LED  
Night vision red LED



61125	Light only. Black.
61126	120V AC. Black.
22057	USB Cord
22058	120V AC Wall Adapter
61128	Clipmate USB Battery

### EPU-5200™ ELECTRONIC POWER UNIT

We've made it easier than ever to keep your USB flashlights and mobile devices powered up and ready. You can clip the electronic power unit to a vest and take it anywhere. It's lightweight, yet rugged and durable to stand up to almost anything. And it's also a flashlight! IPX4 water-resistant.

#### EPU-5200

**BATTERY:** Lithium ion cell pack

**SIZE:** 4.45" x 1.83" x 1.25"  
(11.3 x 4.7 x 3.2 cm)

**WEIGHT:** 5.4 oz (153 g)

**COLOR:** Black

22600	with USB cord, nylon holster-Black
-------	------------------------------------

Charges most USB products with micro-USB input.

- 4+ full charges for Streamlight Stylus ProUSB, Clipmate USB and Double Clutch USB
- 2 full charges for Streamlight ProTac HL USB
- 1+ full charges for most smartphones and tablets



(Light not included).

# SURE, THEY'RE CALLED POCKET LIGHTS BUT REALLY THEY'RE GO-ANYWHERE, DO-ANYTHING LIGHTS.

## CLIPMATE®

This innovative little light rotates 360° and is equipped with 3 high-intensity LEDs.

### CLIPMATE

**BATTERY:** (3) "AAA" alkaline

**SIZE:** 3.52" x .85"  
(8.94 x 2.16 cm)

**WEIGHT:** 2.4 oz (66.7 g)

**COLOR:** Yellow with three white LEDs;  
Black with a choice of white or green LEDs



<b>LUMENS:</b>	27 (white)
<b>RUN TIME:</b>	40h

- |       |                                               |
|-------|-----------------------------------------------|
| 61100 | Yellow with White LEDs and alkaline batteries |
| 61101 | Black with White LEDs and alkaline batteries  |
| 61102 | Black with Green LEDs and alkaline batteries  |

## THE LOGO™

Weighs less than half an ounce and has 3 light levels plus a blink mode that will flash for 45 hours. To conserve battery, it automatically turns off after 6 minutes in high, medium or low modes. Weather-resistant. 1 meter impact-resistance tested.

### THE LOGO

**BATTERY:** (2) 3V CR2016 lithium coin cell

**SIZE:** 1.8" x 1.2" x .37"  
(45.7 x 30.5 x 9.4 mm)

**WEIGHT:** .37 oz (10.7 g)

**COLOR:** Black



<b>LUMENS:</b>	10 (white)
<b>RUN TIME:</b>	45h on blink

- |       |                   |
|-------|-------------------|
| 73100 | White LED. Black. |
|-------|-------------------|

## KEY-MATE®

One of the brightest, longest-running, most durable keychain lights. O-ring sealed for water-resistance.

### KEY-MATE

**BATTERY:** (4) alkaline button cell

**SIZE:** 2.36" x .74" x .57"  
(5.9 x 1.88 x 1.45 cm)

**WEIGHT:** .9 oz (25.4 g)

**COLOR:** Black or Titanium, white or green LED, and RealTree® Hardwoods® High Definition® (HD) Green with green LED

<b>LUMENS:</b> white led	10
<b>LUMENS:</b> green led	2.6
<b>RUN TIME:</b>	96h



- |       |                                                                  |
|-------|------------------------------------------------------------------|
| 72001 | Black with White LED and batteries                               |
| 72101 | Titanium with White LED and batteries                            |
| 72003 | Black with Green LED and batteries                               |
| 72203 | Camo with Green LED and batteries                                |
| 72016 | Filter Combo - Black w/ White LED, Red & Green Filters, lanyard. |
| 72030 | 4 pack Key-Mate Batteries                                        |
| 72025 | Key-Mate Filter - Red                                            |
| 72026 | Key-Mate Filter - Green                                          |
| 72027 | Key-Mate Filter - Blue                                           |
| 72028 | Key-Mate Filter - IR                                             |

Batteries



Colored & Infrared Lenses

**LIGHTS FOR A CAUSE** SERIES  
// STREAMLIGHT 2016



# STREAMLIGHT LIGHTS FOR A CAUSE

SUPPORTING THE THINGS THAT MATTER TO YOU.

## SIEGE® AA LANTERN

The Siege® AA lantern features one C4® power LED, and two red LEDs (or two blue LEDs on the C.O.P.S. model). There are five output modes and a battery level indicator built into the on/off button. With the outer lantern globe in place, the light will float. Use the lantern with or without the outer globe cover. Remove the outer globe and hang the body upside down by the D ring for large area lighting needs. Battery replacement is a breeze with the center post orienting the battery cover correctly every time.

**SIEGE AA**  
**BATTERY:** (3) "AA" size alkaline  
**SIZE:** 2.37" x 5.44"  
 (6.00 x 13.82 cm)  
**WEIGHT:** 8.8 oz (249.47 g)  
**COLOR:** Pink or Blue

**SIEGE AA**  
 44944 Siege AA Lantern - Pink  
 44949 Siege AA Lantern - Blue



For every pink Siege AA sold, Streamlight will donate \$2 to the Breast Cancer Research Foundation.®

For every blue Siege AA sold, Streamlight will donate \$2 to C.O.P.S. - Concerns of Police Survivors.



Shown with outer globe removed.



With **[(SOS)]**  
 Hold on/off button to activate.

WHITE C4 LED	HIGH	MEDIUM	LOW
<b>LUMENS:</b>	200	100	50
<b>RUN TIME:</b>	7h	15h 30m	37h

Light output with outer globe removed.

(2) RED LEDs	HIGH	FLASH/SOS MODE
<b>LUMENS:</b>	.7	.7
<b>RUN TIME:</b>	192h	288h

### Special Features:

- Floats for easy retrieval.
- Waterproof to 1 meter.
- 2 meter impact-resistance tested.
- Unbreakable polycarbonate globe.
- Rugged, non-slip base.

## STRION® LED

A powerful value that's perfect for the broadest range of lighting needs. IPX4-rated for water-resistance. Adjustable ring provides a sure-grip for easy one-handed operation. 2 meter impact-resistance tested.

**STRION LED**  
**BATTERY:** Lithium-ion with on-board safety control circuit  
**SIZE:** 5.9" x 1.25" x .95"  
 (14.99 x 3.18 x 2.41 cm)  
**WEIGHT:** 5.2 oz (148 g)  
**COLOR:** Pink

74350 with AC/12V DC-1 Holder. Pink.



For every pink Strion® LED sold, Streamlight will donate \$5 to the Breast Cancer Research Foundation.®



With **[(STROBE)]**  
 Double tap switch to activate.

	HIGH	MEDIUM	LOW
<b>LUMENS:</b>	260	130	65
<b>CANDELA:</b>	10,000	5,000	2,500
<b>DISTANCE:</b>	200m	141m	100m
<b>RUN TIME:</b>	2h	4h	7h 30m

The Breast Cancer Research Foundation® is an independent 501(c)(3) not-for-profit organization whose mission is to achieve prevention and a cure for breast cancer in our lifetime by providing critical funding for innovative clinical and genetic research at leading medical centers worldwide, and increasing public awareness about good breast health. For more information, visit [www.brcfure.org](http://www.brcfure.org).

# STREAMLIGHT LIGHTS FOR A CAUSE

**SUPPORTING THE THINGS THAT MATTER TO YOU.**

## PROTAC HL®

One of the brightest tactical personal carry lights of its size. Far-reaching beam. TEN-TAP® programming lets you choose the order of operating modes (high, low, strobe). IPX7-rated waterproof to 1 meter/30 minutes. 1 meter impact-resistance tested.

### PROTAC HL

**BATTERY:** (2) 3V "CR123A" lithium

**SIZE:** 5.4" x 1.375" x 1.0"  
 (13.72 x 3.49 x 2.54 cm)

**WEIGHT:** 5.6 oz (158 g)

**COLOR:** Pink

88044 with lithium batteries and holster. Pink.



For every pink ProTac® HL sold, Streamlight will donate \$3 to the Breast Cancer Research Foundation.®



Nylon Holster

**HL** **C4 LED** With **(STROBE)**  
 Double tap switch to activate.

	HIGH	LOW
<b>LUMENS:</b>	600	33
<b>CANDELA:</b>	16,000	800
<b>DISTANCE:</b>	253m	57m
<b>RUN TIME:</b>	1h 15m	18h

Strobe runs 2h 30m

## VANTAGE®

The solution to firefighters' hands-free lighting needs. Attaches easily to helmets and hard hats, and rotates 360°. Fits snugly against helmet to prevent snags. Includes a bright blue tail light so you can be seen from behind even in heavy smoke. Easy to operate with gloves. Fits both traditional and modern helmets.

### VANTAGE

**BATTERY:** (2) 3V "CR123A" lithium

**SIZE:** 3.26" x 1.47" x 2.56"  
 (8.28 x 3.73 x 6.5 cm)

**WEIGHT:** 5.14 oz (145.7 g)

**COLOR:** Red

69157 Vantage LED Tactical Helmet Light. Red.

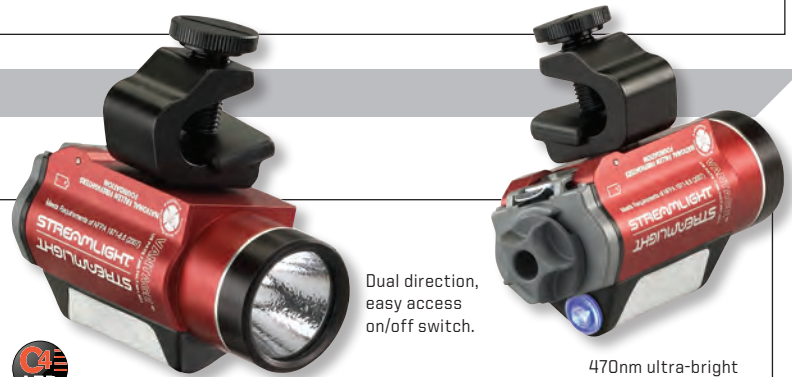

Dual direction, easy access on/off switch.

470nm ultra-bright blue tail light LED.



<b>LUMENS:</b>	115
<b>CANDELA:</b>	7,000
<b>DISTANCE:</b>	167m
<b>RUN TIME:</b>	6h



For every red Vantage sold, Streamlight will donate \$3 to National Fallen Firefighter Foundation.

**NFPA** Meets requirements of NFPA 1971-8.6 (2007); 500° heat resistance test

**CE** Meets applicable European Community Directives



# NANO LIGHT®

This tiny, weatherproof light has a non-rotating snap hook for easy one-handed operation when attached to a keychain.

## NANO

**BATTERY:** (4) alkaline button cell

**SIZE:** 1.47" x .51" x .43"  
(3.73 x 1.3 x 1.09 cm)

**WEIGHT:** .36 oz (10 g)

**COLOR:** Black, Blue, Pink, Red, Orange or Coyote

For each color Nano Light sale (except for the black Nano), we donate \$1 to the organization associated with that light. Look below for information about each cause.

**LUMENS:** 10  
**RUN TIME:** 8h



73001	Black with White LED
73002	COPS/Blue with White LED
73003	BCRF/Pink with White LED
73005	NFFF/Red with White LED
73006	BADF/Orange with White LED
73007	TMF/Coyote with White LED
73008	ADA/Red with White LED
61205	4 pack coin cell Nano Light Batteries

## STREAMLIGHT CARES: THE PRODUCT THAT ALLOWS YOU TO SUPPORT CAUSES THAT MATTER.



By purchasing this product you are helping to make a difference in the rebuilding of the lives of surviving families and affected co-workers of law enforcement officers killed in the line of duty. In addition to rebuilding lives, C.O.P.S. provides training to law enforcement agencies on survivor victimization issues and educates the public of the need to support the law enforcement profession and its survivors. For more information, visit [www.nationalcops.org](http://www.nationalcops.org).



The Breast Cancer Research Foundation® is an independent 501 (c) (3) not-for-profit organization whose mission is to achieve prevention and a cure for breast cancer in our lifetime by providing critical funding for innovative clinical and genetic research at leading medical centers worldwide, and increasing public awareness about good breast health. For more information, visit [www.bcrf.org](http://www.bcrf.org).



Congress created the National Fallen Firefighters Foundation to lead a nationwide effort to honor America's fallen firefighters. Since 1992, the non-profit foundation has developed and expanded programs that fulfill that mandate. Their mission is to honor and remember America's fallen fire heroes and to provide resources to assist their survivors in rebuilding their lives. For more information, visit [www.firehero.org](http://www.firehero.org).



The Buckmasters American Deer Foundation, (BADF), founded by Jackie Bushman was born from the desire to give back to the hunting community, starting with programs such as Project Venison and Hunters of Tomorrow. Buckmasters Chapters from across the country continue to give to those in need. For more information, visit [www.buckmasters.com/resources/badf.aspx](http://www.buckmasters.com/resources/badf.aspx).



The Travis Manion Foundation honors and assists our nation's veterans, first responders, and the families of fallen heroes through various grants, scholarships, races, and The annual 9/11 Heroes Run. For more information, visit [www.travismanion.org](http://www.travismanion.org).



By purchasing this product, you are helping to make a difference in lives of those affected by diabetes. The mission of The American Diabetes Association is to prevent and cure diabetes and improve the lives of all people affected by diabetes. To learn more, please visit [www.diabetes.org](http://www.diabetes.org).

FOR EVERY CUSTOM NANO LIGHT® SOLD, STREAMLIGHT WILL DONATE \$1 TO THEIR RESPECTIVE ORGANIZATION.





**LIGHTING THE WAY SINCE 1973**

// STAY CONNECTED WITH US:





**STREAMLIGHT®**  
Heroes Trust Streamlight®

Streamlight, Inc.  
30 Eagleville Road  
Eagleville, PA U.S.A 19403-3996

www.streamlight.com // www.streamlightgear.com  
(800) 523-7488 Toll-Free  
(800) 220-7007 Fax  
(610) 631-0600  
(610) 631-0712 Fax

**Ваш поставщик:**  
ООО "КОМПАНИЯ ОПТУЛС"  
Москва, ул.Иловайская, д.3  
Телефон: +7 (495) 646-00-96  
Эл. почта: sale@opttools.ru  
<https://www.opttools.ru>

