

Weidmüller terminal - SAK-series- are proved in millions of applications for more than 50 years.

Available for the two rail systems TS32 and TS35, the SAK terminals are useable for every application and for all cross-sections. SAK terminals fulfill the requirements of EN 60 947-7-1.

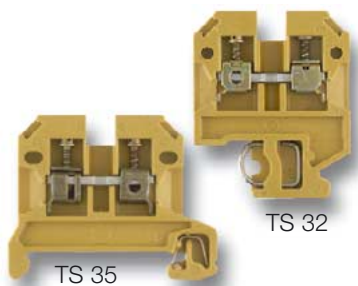

Thermosetting plastic or Thermoplastic

Terminal of thermosetting plastic are normally used in applications where high continuous service temperature and high flammability level are necessary. The Weidmüller thermosetting plastic KRG is very resistant against infection through mould and micro-organisms.

The thermoplastic material Polyamide 66 has very good electrical and mechanical properties upto 100°C. PA66 is flexible and unsusceptible to fracture, even with low temperatures.

Polyamid 66 has improved fire resistance and is self-extinguishing with flammability level V2 according to UL 94.

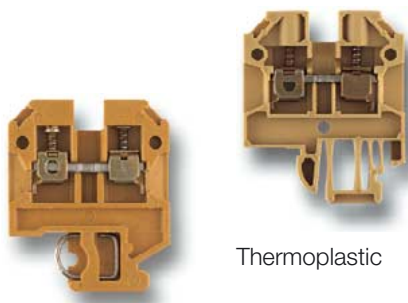

Thermosetting plastic

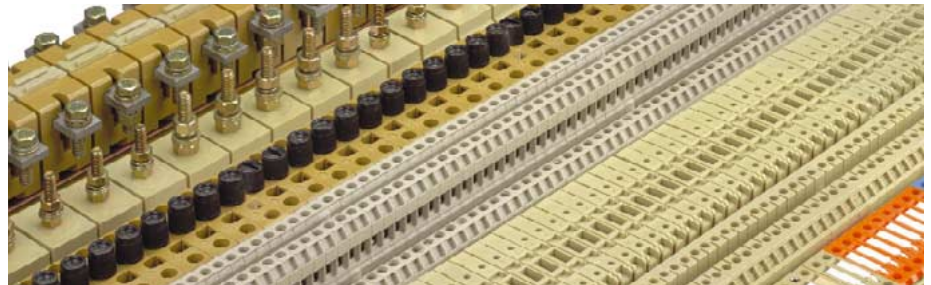

Cross-connection systems

40% of all terminals are cross-connected for potential branching.

Weidmüller distinguishes between the following cross-connection units for SAK-series:

- type Q pre-assembled cross-connections
- type QL permanent cross-connections
- type VL removeable cross-connection straps
- type QS removeable cross-connection plugs

Cross-connection systems from the SAK and AKZ series, type Q, QL or VL or other freely accessible live components, must be protected with appropriate covers ADP 1 or 4 or TSK 31.5 as long as they are to be inserted safe from contact.

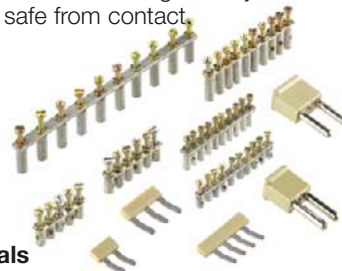

Approvals

The following approvals apply to SAK terminals:

- UL-USA
- CSA-Canada
- GOST-Russia
- SEV-Switzerland
- KEMA-Netherlands
- Lloyds Register of Shipping
- Germanischer Lloyd
- Det Norske Veritas

SAK portfolio

- Feed-through terminals
- Protective conductor terminals
- Fuse terminals
- Disconnect-test terminals
- Feed-through terminals with tab, solder, WireWrap and Termi Point connections
- Initiator terminals, Actuator terminals
- Stud terminals

Accessories

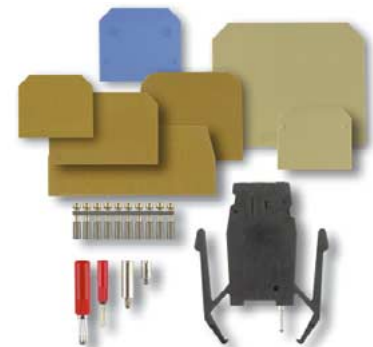

An extensive assortment of accessories is available for Weidmüller SAK terminals:

- Partitions
- Cover plates
- Small partitions
- Test plugs
- Test adapters
- Marking material
- Cross-connections and
- Covers

Positioning of end plates or partitions between cross-connections

Operating voltage	Terminal width (in mm)					
	≤ 6	≤ 8	10	12	18	22
125 V ~	AP	-	-	-	-	-
250 V ~	AP	-	-	-	-	-
380 V ~	AP	AP	-	-	-	-
440 V ~	TW	AP	AP	AP	AP	-
500 V ~	TW	TW	AP	AP	AP	-
660 V ~	TW	TW	TW	TW	TW	AP
750 V ~	TW	TW	TW	TW	TW	AP

In PA terminals small partitions (TSch) have to be used up to 380 V.

Feed-through terminals

SAKD 2.5 N SAKD 2.5/10/35



Width/length/height (mm) with TS 32	5/32.5/43.5
Width/length/height (mm) with TS 35 x 7.5	5/44/38
Insulation stripping length/clamping screw/screwdriver blade	10/M 2.5/3.5 x 0.6
Rated data according to IEC 60 947-7-1	
Rated voltage/current/cross-section	500 V/24 A/2.5 mm ²
Rated impulse voltage/pollution severity	6 kV/3
Further technical data	
Tightening torque range Nm	0.4...0.6
Torque setting with electric screwdriver type DMS 2	1

SAK 2.5/35 SAK 2.5/10/35



Width/length/height (mm)	6/45/40
Insulation stripping length/clamping screw/screwdriver blade	10/M 2.5/3.5 x 0.6
Rated data according to IEC 60 947-7-1	
Rated voltage/current/cross-section	800 V/24 A/2.5 mm ²
Rated impulse voltage/pollution severity	8 kV/3
Further technical data	
Tightening torque range Nm	0.4...0.6
Torque setting with electric screwdriver type DMS 2	1

SAK 2.5 SAK 2.5/10



Width/length/height (mm)	6/36.5/46.5
Insulation stripping length/clamping screw/screwdriver blade	10/M 2.5/3.5 x 0.6
Rated data according to IEC 60 947-7-1	
Rated voltage/current/cross-section	800 V/24 A/2.5 mm ² ³⁾
Rated impulse voltage/pollution severity	8 kV/3
Further technical data	
Tightening torque range Nm	0.4...0.6
Torque setting with electric screwdriver type DMS 2	1

SAK 4/35 SAK 4/10/35



Width/length/height (mm)	6.5/40/51.5
Insulation stripping length/clamping screw/screwdriver blade	12/M 3/3.5 x 0.6
Rated data according to IEC 60 947-7-1	
Rated voltage/current/cross-section	800 V/32 A/4 mm ²
Rated impulse voltage/pollution severity	8 kV/3
Further technical data	
Tightening torque range Nm	0.5...1.0
Torque setting with electric screwdriver type DMS 2	2

Dimensions/approvals

Width/length/height (mm)	with TS 32
Width/length/height (mm)	with TS 35 x 7.5
Insulation stripping length/clamping screw/screwdriver blade	

Rated data according to IEC 60 947-7-1

Rated voltage/current/cross-section	
Rated impulse voltage/pollution severity	

Further technical data

Tightening torque range Nm	
Torque setting with electric screwdriver type DMS 2	

Clampable conductor

Solid H07V-U	mm ²	0.5...4
Stranded H07V-R	mm ²	0.5...2.5
Flexible H07V-K	mm ²	0.5...4
Flexible H07V-K and ferrule according to DIN 46 228/1	mm ²	0.5...2.5
Plug gauge according to 60 947-7-1	Size	A 2
Continuous current of terminal for conductor size		30 A/4 mm ²
Continuous current rating of cross-connection 2...5-pole	A	24
Continuous current rating of cross-connection 6...10-pole	A	24

Rated data according to UL/CSA

Voltage/current/conductor size	UL	300 V/20 A/28...12 AWG
Voltage/current/conductor size	CSA	300 V/20 A/22...12 AWG

Ordering data

Version	Qty.	Qty.
KrG		
Blue KrG		
KrS		
PA		
Blue PA		
Orange PA		
Terminal block with marking PA		
Terminal block without marking PA		

End plate (thickness mm)

Type	Cat. No.	Qty.
KrG		
Blue KrG		
KrS		
PA	AP (1.5) 0150960000	20
Blue PA	AP (1.5) 0150980000	20
PA		
Blue PA		

Partition (thickness mm)

Type	Cat. No.	Qty.
KrG		
Blue KrG		
KrS		
PA	TW (1.5) 0191860000	20
Blue PA	TW (1.5) 0191880000	20
HP	TW (1.5) 0307500000	20

Small partition

TSch 1		
TSch 3	0366860000	100

Cross-connection

Q 4	2-pole	Q 2	0367800000	50
	3-pole	Q 3	0367900000	50
	4-pole	Q 4	0368000000	50
	10-pole	Q 10	0368100000	20

Cover plates

AD 4	0303400000	50
BSKM3x22	0128900000	100

Switchable cross-connection link

VL 2		
BS		
VH		

Marking tags

	1	2	3	4	5	6	DEK	Standard	
	DEK 5	see "Accessories"						DEK 6	see "Accessories"
	DEK 6	see "Accessories"						DEK 6.5	see "Accessories"

Mounting rails, end brackets, further marking material see "Accessories"

¹⁾ Contact-proof with ADP 4 cover profile (see section "Accessories")
²⁾ Not suitable for SST 3 safety pin

³⁾ Cat. No. **0279660000**, **0279680000**, **0380460000** and **0380480000**, 41 A for 6 mm²

Feed-through terminals

SAK-series

SAK 4 SAK 4/10

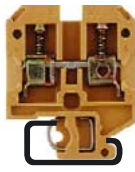

DK 4 Q* DKB4 Q*/10*



DK 4 DK4/35

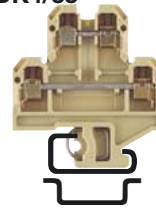

Dimensions/approvals

Width/length/height (mm)	with TS 32	
Width/length/height (mm)	with TS 35 x 7.5	
Insulation stripping length/clamping screw/screwdriver blade		

Rated data according to IEC 60 947-7-1

Rated voltage/current/cross-section	800 V/32 A/4 mm ²
Rated impulse voltage/pollution severity	8 kV/3

Further technical data

Tightening torque range	Nm	0.5...1.0
Torque setting with electric screwdriver type DMS 2		2

Clampable conductor

Solid H07V-U	mm ²	0.5...6
Stranded H07V-R	mm ²	0.5...4
Flexible H07V-K	mm ²	0.5...4
Flexible H07V-K and ferrule according to DIN 46 228/1	mm ²	
With/without plastic insulating collar	mm ²	0.5...4
Plug gauge according to 60 947-7-1	Size	A 4
Continuous current of terminal for conductor size		41 A/6 mm ²
Continuous current rating of cross-connection 2...5-pole	A	36
Continuous current rating of cross-connection 6...10-pole	A	

Technical data

Voltage/current/conductor size	UL	600 V/20 A/22...12 AWG
Voltage/current/conductor size	CSA	600 V/36 A/26...10 AWG

Ordering data

Version	Cat. No.	Qty.
KrG	0128320000	100
Blue KrG	0128370000	100
KrS	0128330000	100
PA	0128360000 ¹⁾²⁾	100
Blue PA	0128380000 ¹⁾²⁾	100
Orange PA	0105060000 ¹⁾²⁾	100
Terminal block with marking PA	0322660000 ¹⁾²⁾	10
Terminal block without marking PA	0308860000 ¹⁾²⁾	10

End plate (thickness mm)

Type	Cat. No.	Qty.
KrG	AP (1.5) 0117920000	20
Blue KrG	AP (1.5) 0117970000	20
KrS	AP (1.5) 0117930000	20
PA	AP (1.5) 0117960000	20
Blue PA	AP (1.5) 0117980000	20
PA		
Blue PA		

Partition (thickness mm)

Type	Cat. No.	Qty.
KrG	TW (2.5) 0130120000	20
Blue KrG	TW (2.5) 0103170000	20
KrS	TW (2.5) 0130130000	20
PA	TW (1.5) 0130160000	20
Blue PA	TW (1.5) 0130180000	20
HP	TW (1.0) 0197100000	20

Small partition

TSch 6	TSch 1	0319160000	100
--------	--------	-------------------	-----

Cross-connection

Type	Cat. No.	Qty.
Q 2	0336700000	50
Q 3	0336800000	50
Q 4	0336900000	50
Q 10	0368800000	20
QB 2	0482700000 **	100
QB 3	0482800000 **	50
QB 4	0482900000 **	50

Switchable cross-connection link

VL 2	VL 2	0197000000	100
BS	VH	0285100000	50
	BS	0292500000	100

Marking tags

DEK	Standard	DEK6.5	see "Accessories"
-----	----------	--------	-------------------

Mounting rails, end brackets, further marking material see "Accessories"

* Accepts LS 2.8 shield lugs Cat. No. **1056400000**

** 2.5 mm² conductor connection when using QB

Dimensions/approvals

Width/length/height (mm)	6/54/60
Width/length/height (mm)	6/54/60.5
Insulation stripping length/clamping screw/screwdriver blade	9/M 3/3.5 x 0.6

Rated data according to IEC 60 947-7-1

Rated voltage/current/cross-section	500 V/2 x 32 A/4 mm ²
Rated impulse voltage/pollution severity	6 kV/3

Further technical data

Tightening torque range	Nm	0.5...1.0
Torque setting with electric screwdriver type DMS 2		2

Clampable conductor

Solid H07V-U	mm ²	0.5...4
Stranded H07V-R	mm ²	0.5...4
Flexible H07V-K	mm ²	0.5...4
Flexible H07V-K and ferrule according to DIN 46 228/1	mm ²	
With/without plastic insulating collar	mm ²	0.5...4
Plug gauge according to 60 947-7-1	Size	A 3
Continuous current of terminal for conductor size		32 A/4 mm ²
Continuous current rating of cross-connection 2...5-pole	A	32
Continuous current rating of cross-connection 6...10-pole	A	32

Technical data

Voltage/current/conductor size	UL	300 V/27 A/22...12 AWG
Voltage/current/conductor size	CSA	300 V/10 A/26...12 AWG

Version	Cat. No.	Qty.
KrG	0590060000 ¹⁾¹⁰⁰	0590160000 ¹⁾¹⁰⁰
Blue KrG	0590080000 ¹⁾¹⁰⁰	0590180000 ¹⁾¹⁰⁰
KrS	1323860000 ¹⁾¹⁰	

End plate (thickness mm)

Type	Cat. No.	Qty.
KrG	AP (1.5) 1397160000	20
Blue KrG	AP (1.5) 1397180000	20
KrS		
PA		
Blue PA		

Partition (thickness mm)

Type	Cat. No.	Qty.
KrG	TW (2.5) 0130120000	20
Blue KrG	TW (2.5) 0103170000	20
KrS	TW (2.5) 0130130000	20
PA	TW (1.5) 0130160000	20
Blue PA	TW (1.5) 0130180000	20
HP	TW (1.0) 0197100000	20

Small partition

TSch 6	0190260000	100
--------	-------------------	-----

Cross-connection

Type	Cat. No.	Qty.
Q 2	0336400000	50
Q 3	0336500000	50
Q 4	0336600000	50
Q 10	0368600000	20
QB 2	0482700000 **	100
QB 3	0482800000 **	50
QB 4	0482900000 **	50

Switchable cross-connection link

VL 2	VL 2	0446700000	50
BS	VH	1056500000	100
	BS	0343100000	100

Marking tags

DEK	Standard	DEK6	see "Accessories"
-----	----------	------	-------------------

1) Contact-proof cross-connec. with ADP 4 over profile (see "Accessories")

2) Not suitable for fuse pin SST 3

Feed-through terminals

DK4 QV* DK4 QV/35*



Width/length/height (mm) with TS 32	6/54/60
Width/length/height (mm) with TS 35 x 7.5	6/54/60.5
Insulation stripping length/clamping screw/screwdriver blade	9 mm/M 3/3.5 x 0.6
Rated data according to IEC 60 947-7-1	
Rated voltage/current/cross-section	500 V/32 A/4 mm ²
Rated impulse voltage/pollution severity	6 kV/3
Further technical data	
Tightening torque range	Nm 0.5...1.0
Torque setting with electric screwdriver type DMS 2	2
Clampable conductor	
Solid H07V-U	mm ² 0.5...4
Stranded H07V-R	mm ² 0.5...4
Flexible H07V-K	mm ² 0.5...4
Flexible H07V-K and ferrule according to DIN 46 228/1	mm ²
With/without plastic insulating collar	mm ² 0.5...4
Plug gauge according to 60 947-7-1	Size A 3
Continuous current of terminal for conductor size	32 A/4 mm ²
Continuous current rating of cross-connection 2...5-pole	A 32
Continuous current rating of cross-connection 6...10-pole	A 32

Dimensions/approvals

Width/length/height (mm)	with TS 32	6/54/60
Width/length/height (mm)	with TS 35 x 7.5	6/54/60.5
Insulation stripping length/clamping screw/screwdriver blade		9 mm/M 3/3.5 x 0.6

Rated data according to IEC 60 947-7-1

Rated voltage/current/cross-section	500 V/32 A/4 mm ²
Rated impulse voltage/pollution severity	6 kV/3

Further technical data

Tightening torque range	Nm 0.5...1.0
Torque setting with electric screwdriver type DMS 2	2

Clampable conductor

Solid H07V-U	mm ² 0.5...4
Stranded H07V-R	mm ² 0.5...4
Flexible H07V-K	mm ² 0.5...4
Flexible H07V-K and ferrule according to DIN 46 228/1	mm ²
With/without plastic insulating collar	mm ² 0.5...4
Plug gauge according to 60 947-7-1	Size A 3
Continuous current of terminal for conductor size	32 A/4 mm ²
Continuous current rating of cross-connection 2...5-pole	A 32
Continuous current rating of cross-connection 6...10-pole	A 32

Rated data according to UL/CSA

Voltage/current/conductor size	UL 300 V/27 A/22...12 AWG
Voltage/current/conductor size	CSA 300 V/10 A/26...12 AWG

Ordering data

Version	Type	Cat. No.	Qty.
KrG	AP	1397160000	20
Blue KrG	AP	1397180000	20
KrS	AP	1397160000	20
PA	AP	1397180000	20
Blue PA	AP	1397180000	20
Orange PA	AP	1397180000	20
Terminal block with marking	TSch 6	0190260000	100
Terminal block without marking	TSch 6	0190260000	100

SAK 6 N SAK 6/10/35

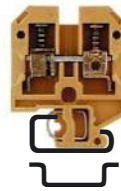

Width/length/height (mm)	8/40/51.5
Width/length/height (mm)	8/45/44
Insulation stripping length/clamping screw/screwdriver blade	12 mm/M 3.5/4.0 x 0.8
Rated data according to IEC 60 947-7-1	
Rated voltage/current/cross-section	800 V/41 A/6 mm ²
Rated impulse voltage/pollution severity	8 kV/3
Further technical data	
Tightening torque range	Nm 0.8...1.6
Torque setting with electric screwdriver type DMS 2	3
Clampable conductor	
Solid H07V-U	mm ² 0.5...10
Stranded H07V-R	mm ² 0.5...6
Flexible H07V-K	mm ² 0.5...10
Flexible H07V-K and ferrule according to DIN 46 228/1	mm ²
With/without plastic insulating collar	mm ² 0.5...6
Plug gauge according to 60 947-7-1	Size A 5
Continuous current of terminal for conductor size	41
Continuous current rating of cross-connection 2...5-pole	41
Continuous current rating of cross-connection 6...10-pole	41

SAK 10 SAK 10/10/35

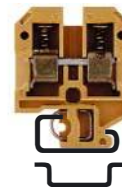

Width/length/height (mm)	10/40/51.5
Width/length/height (mm)	10/45/44
Insulation stripping length/clamping screw/screwdriver blade	12 mm/M 4/5.5 x 1.0
Rated data according to IEC 60 947-7-1	
Rated voltage/current/cross-section	800 V/57 A/10 mm ²
Rated impulse voltage/pollution severity	8 kV/3
Further technical data	
Tightening torque range	Nm 1.2...2.0 ³⁾
Torque setting with electric screwdriver type DMS 2	4
Clampable conductor	
Solid H07V-U	mm ² 1.5...10
Stranded H07V-R	mm ² 2.5...16
Flexible H07V-K	mm ² 1.5...10
Flexible H07V-K and ferrule according to DIN 46 228/1	mm ²
With/without plastic insulating collar	mm ² 1.5...10
Plug gauge according to 60 947-7-1	Size B 6
Continuous current of terminal for conductor size	76 A/16 mm ²
Continuous current rating of cross-connection 2...5-pole	57
Continuous current rating of cross-connection 6...10-pole	57

SAK 16 SAK 16/35



Width/length/height (mm)	12/50/57.5
Width/length/height (mm)	12/50/50
Insulation stripping length/clamping screw/screwdriver blade	15 mm/M 4/5.5 x 1.0
Rated data according to IEC 60 947-7-1	
Rated voltage/current/cross-section	1000 V/76 A/16 mm ²
Rated impulse voltage/pollution severity	8 kV/3
Further technical data	
Tightening torque range	Nm 1.2...2.4
Torque setting with electric screwdriver type DMS 2	4
Clampable conductor	
Solid H07V-U	mm ² 2.5...10
Stranded H07V-R	mm ² 4...16 ²⁾
Flexible H07V-K	mm ² 4...16
Flexible H07V-K and ferrule according to DIN 46 228/1	mm ²
With/without plastic insulating collar	mm ² 4...16
Plug gauge according to 60 947-7-1	Size B 6
Continuous current of terminal for conductor size	76
Continuous current rating of cross-connection 2...5-pole	76
Continuous current rating of cross-connection 6...10-pole	76

End plate (thickness mm)

Type	Cat. No.	Qty.
AP	1397160000	20
Blue AP	1397180000	20
KrG	1397160000	20
Blue KrG	1397180000	20
KrS	1397160000	20
PA	1397180000	20
Blue PA	1397180000	20

Partition (thickness mm)

Type	Cat. No.	Qty.
TW	0130120000	20
WTW	1058800000	20
Small partition	0607000000	20
TSch 6	0190260000	100

Cross-connection

Type	Cat. No.	Qty.
Q 2	0336400000	50
Q 3	0336500000	50
Q 4	0336600000	50
Q 10	0368600000	20
QB 2	0482700000**	100
QB 3	0482800000**	50
QB 4	0482900000**	50

Cover

Type	Cat. No.	Qty.
AD 4	0303400000	50
BSKM 2.5 x18	0303300000	100

Switchable cross-connection link

Type	Cat. No.	Qty.
VL 2	0446700000	50
VH	1056500000	100
BS	0343100000	100

Marking tags

Type	Cat. No.	Qty.
DEK 6	see "Accessories"	

Mounting rails, end brackets, further marking material see "Accessories"

* Accepts LS 2.8 shield lugs Cat. No. 1056400000
** 2.5 mm² conductor connection when using QB

1) Contact-proof with ADP 4 cover profile (see section "Accessories")

2) Tightening torque for 16 mm² stranded: 2 Nm

3) Tightening torque for 16 mm² and AWG6: 2 Nm

Feed-through terminals

SAK 35 N SAK 35 N/35



UL CE LR DNV

Dimensions/approvals
Width/length/height (mm) with TS 32 16/58/67.5
Width/length/height (mm) with TS 35 x 7.5 16/63/60
Insulation stripping length/clamping screw/screwdriver blade 18 mm/M 6/6.5 x 1.2

Rated data according to IEC 60 947-7-1
Rated voltage/current/cross-section 1000 V/125 A/35 mm²
Rated impulse voltage/pollution severity 8 kV/3

Further technical data
Tightening torque range Nm 4.0...5.0/4.0...6.0***
Torque setting with electric screwdriver type DMS 2

Clampable conductor
Solid H07V-U mm² 2.5...16
Stranded H07V-R mm² 2.5...50
Flexible H07V-K mm² 2.5...35
Flexible H07V-K and ferrule according to DIN 46 228/1 mm² 2.5...35
Plug gauge according to 60 947-7-1 Size B 8
Continuous current of terminal for conductor size 125 A/35 mm²
Continuous current rating of cross-connection 2...5-pole A 65
Continuous current rating of cross-connection 6...10-pole A 65

Rated data according to UL/CSA
Voltage/current/conductor size UL 600 V/100 A/12...2 AWG
Voltage/current/conductor size CSA 600 V/120 A/12...2 AWG

Ordering data

Version	Qty.	Qty.
KrG	0550620000 20	0608220000 20
Hexagon socket KrG	0555720000 20	0608320000 20
Hexagon socket Blue KrG		0608370000 20
KrS	0550630000 20	
Hexagon socket KrS	0555730000 20	
PA	0550660000 20	0608260000 20
Hexagon socket PA	0555760000 20	0608360000 20
Blue PA		

End plate (thickness mm)

Type	Cat. No.	Qty.
KrG	AP (3.0) 0303620000	10
Blue KrG	AP (3.0) 0303670000	10
KrS	AP (3.0) 0303630000	10
PA	AP (1.5) 0303660000	10
Blue PA	AP (3.0) 0303680000	10
Orange PA		

Partition (thickness mm)

Type	Cat. No.	Qty.
KrG	TW (3.0) 0304320000	10
Blue KrG		
KrS	TW (3.0) 0304330000	10
PA	TW (1.5) 0304360000	10
Blue PA		

Cross-connection

QL 3	VH	BS	SS	2-pole	Cat. No.	Qty.
					0564900000	50
				3-pole	0565000000	50
				4-pole	0565100000	50
				10-pole	0565200000	20
					0267000000	50
					0267100000	50
					0136400000	100

Switchable cross-connection link

VL 2	BS	VH	Cat. No.	Qty.
			0124000000	50
			0298700000	50
			0298900000	50

Cover / test plug

AD 4	BSKM 4x32	PS 4	Cat. No.	Qty.
			0576700000	50
			0129100000	50
			0299600000	20

Marking tags

DEK	Standard	Cat. No.	Qty.
1 2 3 4 5 6	DEK	Standard	
		DEK 5	see "Accessories"

Mounting rails, end brackets, further marking material see "Accessories"

SAK 35 SAK 35/35



UL CE KEMA LR DNV

18/58/67.5
18/58/60
20 mm/M 6/6.5 x 1.2

800 V/125 A/35 mm²
8 kV/3

4.0...5.0/4.0...6.0***

6...16
16...50
10...35
10...35
B 9
125 A/35 mm²
99
99

600 V/100 A/6...2 AWG
600 V/145 A/6...2 AWG

Ordering data

Version	Qty.	Qty.
KrG	0303520000 20	
Hexagon socket KrG	0476520000 20	
KrS	0303530000 20	
Hexagon socket KrS		
PA	0303560000 20	0380760000 20
Hexagon socket PA	0476560000 20	0582460000 20
Blue PA	0303580000 20	0380780000 20

End plate (thickness mm)

Type	Cat. No.	Qty.
KrG	AP (3.0) 0303620000	10
Blue KrG	AP (3.0) 0303670000	10
KrS	AP (3.0) 0303630000	10
PA	AP (1.5) 0303660000	10
Blue PA	AP (3.0) 0303680000	10

Partition (thickness mm)

Type	Cat. No.	Qty.
KrG	TW (3.0) 0304320000	10
Blue KrG		
KrS	TW (3.0) 0304330000	10
PA	TW (1.5) 0304360000	10
Blue PA		

Cross-connection

QL 2	QL 3	QL 4	QL 10	VH 17	BS M 4x30	SS M 4	Cat. No.	Qty.
							0123600000	20
							0123700000	20
							0123800000	20
							0338600000	20
							0267000000	50
							0267100000	50
							0136400000	100

Switchable cross-connection link

VL 2	VH 24.5	BS M 4x35	Cat. No.	Qty.
			0124000000	50
			0298700000	50
			0298900000	50

Cover / test plug

AD 4	BSKM 4x32	PS 4	Cat. No.	Qty.
			0178700000	20
			0129100000	50
			0299600000	20

Marking tags

DEK	Standard	Cat. No.	Qty.
		DEK 5	see "Accessories"

1) 12 Nm for 70 mm²
2) 20 Nm for 95 mm² and 120 mm²

SAK 70 SAK 70/35

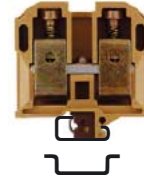

UL CE LR DNV

22/75/79.5
22/75/87
24 mm/M 8/S 6 D911

1000 V/192 A/70 mm²
8 kV/3

6.0...12.0

Strips
16 3x9x0.8
16...70 1) 6x9x0.8
16...70 1) 6x13x0.5
16...35
B 11
192 A/70 mm²
180

600 V/145 A/4...2/0 AWG
600 V/150 A/4...2/0 AWG

Ordering data

Version	Qty.	Qty.
KrG	0340820000 10	
Hexagon socket KrG	0340870000 10	
KrS	0340830000 10	
Hexagon socket KrS		
PA		
Hexagon socket PA		
Blue PA		

End plate (thickness mm)

Type	Cat. No.	Qty.
KrG	AP (4.0) 0340920000	10
Blue KrG		
KrS	AP (4.0) 0340930000	10
PA	AP (2.0) 0340960000	10
Blue PA		

Partition (thickness mm)

Type	Cat. No.	Qty.
KrG		
Blue KrG		
KrS		
PA		
Blue PA		

Cross-connection

QL 2	QL 3	VH 30.5	BS M 5x45	SS M 5	Cat. No.	Qty.
					0345300000	20
					0167000000	20
					0345500000	20
					0345600000	20
					0346100000	100

Switchable cross-connection link

VL 2	VH 35	BS M 5x50	Cat. No.	Qty.
			0551200000	10
			0407600000	10
			0407700000	10

Cover / test plug

AD 3	BSKM 5x45	PS 4	Cat. No.	Qty.
			0344300000	10
			0344400000	50
			0299600000	20

Marking tags

DEK	Standard	Cat. No.	Qty.
		DEK 5	see "Accessories"

Mounting rails, end brackets, further marking material see "Accessories"

SAK 95 SAK 95/35



UL CE DNV

28/83.5/100.5
28/83.5/96.5
30 mm/M 10/S 8 D6911

1000 V/232 A/95 mm²
8 kV/3

10.0...20.0

Strips
10...16 3x9x0.8
10...120 2) 6x9x0.8
10...95 2) 6x13x0.5
10...35 6x16x0.8
B 12
232 A/95 mm²
180

600 V/190 A/6...3/0 AWG
600 V/260 A/6...3/0 AWG

Ordering data

Version	Qty.	Qty.
KrG	0550520000 10	0662220000 10

End plate (thickness mm)

Type	Cat. No.	Qty.
KrG	AP (3.0) 0550920000	10
Blue KrG	AP (3.0) 0550970000	10

Partition (thickness mm)

Type	Cat. No.	Qty.
KrG		
Blue KrG		
KrS		
PA		
Blue PA		

Cross-connection

QL 2	QL 3	QL 4	VH 35	BS M 5x50	Cat. No.	Qty.
					0551200000	10
					0407600000	10
					0407700000	10

Switchable cross-connection link

VL 2	VH 35	BS M 5x50	Cat. No.	Qty.
			0485400000	20

Cover / test plug

ADP 3	PS 4	Cat. No.	Qty.
		0299600000	20

Marking tags

DEK	Standard	Cat. No.	Qty.
		DEK 5	see "Accessories"

Mounting rails, end brackets, further marking material see "Accessories"

Feed-through terminals (spring-loaded)

RSF 3 RSF 3/35



RSF 1



RSF 2

Disconnect test terminal

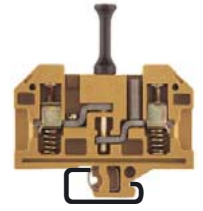

Dimensions/approvals		⊗	⊗	⊗	⊗						
Width/length/height (mm)	with TS 32	8/50/60	11/50/60		11/77/72.5						
Width/length/height (mm)	with TS 35 x 7.5	8/50/53									
Insulation stripping length/clamping screw/screwdriver blade		12 mm	12 mm		12 mm						
Rated data											
Rated voltage/-current		630 V/32 A	500 V/57 A		500/41 A						
Rated cross-section	mm ²	4	10		6						
Rated impulse voltage VDE 0110/1.89/pollution severity		6 kV/3	6 kV /3		6 kV/3						
Further technical data											
Tightening torque range	Nm	0.5...1.0									
Torque setting with electric screwdriver type DMS 2		2									
Clampable conductor											
Solid H07V-U	mm ²	0.5...4	0.5...10		0.75...16						
Stranded H07V-R	mm ²	0.5...4	0.5...10		0.75...10						
Rated data according to UL/CSA											
Voltage/current/conductor size	UL										
Voltage/current/conductor size	CSA										
Ordering data		Version	⊗ Qty.	⊗ Qty.	⊗ Qty.						
		PA	0497560000 50	9501160000 50							
		KrG	0497520000 50	0270320000 50	0623320000*200623120000**20						
End plate/partition/small partition		Type	Cat. No.	Qty.	Type	Cat. No.	Qty.				
AP	TW	TSch 1	PA	AP (3)	0270460000	10	AP (3.0)	0301420000	10		
			KrG	TW (1.5)	3877960000	10					
			PA	TW (2)	3833500000	20					
			HP	TW (0.5)	0474700000	20					
			PA	TSch 1	0319160000	100					
Cross-connection		QL	VH	SS	2-pole	QL 2	0194300000	50	QL 2	0267400000	50
					3-pole	QL 3	0194400000	50	QL 3	0194400000	50
					4-pole	QL 4	0194500000	50	QL 4	0194500000	50
					10-pole	QL 10	0338300000	10	QL 10	0338300000	10
						VH 13.5	0248500000	100	VH 17.5	0285200000	50
						BS M 3x20	0303000000	100	BS M 3x25	0292500000	100
						SS	0164400000	50	SS	0164400000	50
						QS 4	0369760000	10	QS 4	0369760000	10
Switchable cross-connection link		VH 21	VH 27	BS M 3x25	SS	VH 2	0194700000	50	VH 2	0528400000	50
						VH 21	0309600000	100	VH 27	0309400000	50
						BS M 3x20	0296200000	50	BS M 3x25	0309800000	50
						SS	0164400000	50	SS	0164400000	50
Dummy plug		made from plastic, to keep the place of an extracted plug									
Test plug/socket		PS 2.3	0180400000	50	PS 2.4	0299600000	20				
			StB 14	0168600000	50	StB 18	0286500000	20	PS 4	0299600000	20
									StB 17	0147100000	50
Cover plate		ADP 2	0485300000	1	ADP 2	0485300000	1				
Marking tags		Standard									
			DEK	see "Accessories"	DEK	see "Accessories"					

* with disconnecter (73 mm height)

** Disconnecter with handle (86 mm height)

Feed-through terminals for thermocouples

Busbars made from thermocouple materials according to DIN IEC 584

SAK 2.5 TC

DK 4 Q/TC



Weidmüller's **thermocouple-terminals** are specially designed for transmitting the smallest voltages in temperature measuring circuits. Special busbars ensure that no false signals occur in the terminal when temperature differences exist in the positive and negative path.

This high measuring precision is necessary for, e.g. test beds, air craft engines, for complicated chemical processes, controls, etc.

I. Configuration of a temperature measuring circuit

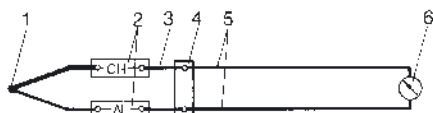

- 1 Thermocouple (sensor)
- 2 Thermocouple terminals
- 3 Compensation conductor
- 4 Reference point
- 5 Supply conductors (to and from)
- 6 Measuring device

The thermocouple terminals displayed in this measurement circuit are used to thermoelectrically transmit thermal e.m.f. of the thermocouple to the reference point and indicating device via the thermocouple.

II. Symbols Thermocouples according to IEC 584 DIN 43710

Terminal	Busbar material trade name
a) Type J	
Fe (positive leg)	Iron
CuNi (negative leg)	Constantan
b) Type T	
Cu (positive leg)	Copper
CuNi (negative leg)	Constantan
c) Type K	
NiCr (positive leg)	Chromel
Ni (negative leg)	Alumel

Dimensions/approvals	SAK 2.5 TC	DK 4 Q/TC
Width/length/height (mm) with TS 32	6/36.5/49.5	6/54/59.5
Width/length/height (mm) with TS 35 x 7.5		6/54/60.5
Insulation stripping length/clamping screw/screwdriver blade	10 mm/M 2.5/3.5 x 0.6	9 mm/M 3/3.5 x 0.6

Technical data/VDE	SAK 2.5 TC	DK 4 Q/TC
Rated voltage/current/cross-section	-/-/2.5 mm ²	-/-/4 mm ²

Tightening torque range	SAK 2.5 TC	DK 4 Q/TC
	Nm 0.4...0.6	0.5...1

Ordering data	Version	Type	Cat. No.	Qty.
	NiCr		0107260000	100
	Ni		0107160000	100
	CuNi		0189860000	100
	Fe		0190060000	100
	Cu		0189960000	100
	NiCr/Ni	K	1284160000	1338260000
	Cu/CuNi	T	1285660000	1338160000
	Fe/CuNi	J	1284060000	1338060000

End plate (thickness mm)	Type	Cat. No.	Qty.
	PA	AP (1.5) 0279560000	20
	Blue PA	AP (1.5) 1397160000	20

Partition (thickness mm)	Type	Cat. No.	Qty.
	WEM	TW (1.5) 0302860000	20

Marking tags	Print
	DEK Standard DEK 6 see "Accessories"

Mounting rails, end brackets, further marking material see "Accessories"

SAK-series

Feed-through terminals

Terminals/Accessories

SAKG 28 I

SAKG 28 II



The Weidmüller SAKG range offers the following connection variants:

- clamping yoke/flat lug as a combination, Version I.
- flat lug, Version II.
Two types of threading are provided here.
a) screw set with lock nut
b) with thread in busbar
- clamping yoke connection, Version III.
The stripped conductor can be connected without further preparation.

Versions

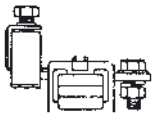

Version I

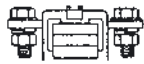

Version II
without thread



Version II G
with thread

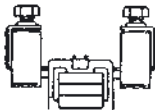

Version III

Cables with cable lugs are connected to SAKG terminals of Version I and to SS stud terminals.

Fitting instructions for SAKG terminals

When tightening the clamping screw, it is recommended that the conductor be held against the direction of tightening to prevent deformation of the mounting rail and so as not to place the terminal foot under undue torsional forces.

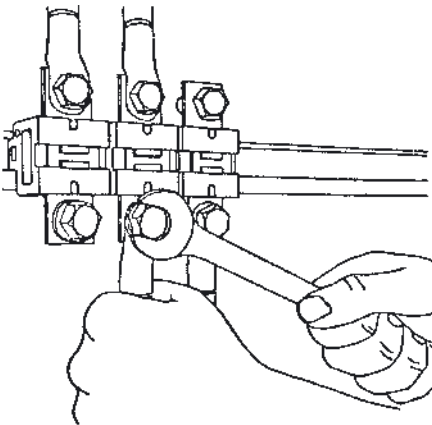

Cover

To ensure shock protection following connections of **conductors**, AH covers can be clipped onto the terminal.

Dimensions/approvals

Width/length/height (mm)	with TS 32	
Width/length/height (mm)	with TS 35	
Insulation stripping length/clamping screw/screwdriver blade		

Rated data according to IEC 60 947-7-1

Rated voltage/current/cross-section	1000 V*/125 A/35 mm ²
Rated impulse voltage/pollution severity	8 kV/3

Further technical data

Tightening torque range	Nm	3...6
Torque setting with electric screwdriver type DMS 2		

Clampable conductor

Solid H07V-U	mm ²	6...35
Stranded H07V-R	mm ²	6...35
Flexible H07V-K	mm ²	10...35
Flexible H07V-K and ferrule according to DIN 46 228/1	mm ²	6...35
Plug gauge according to 60 947-7-1	Size	B 9
Continuous current of terminal for conductor size		125 A/35 mm ²
Continuous current rating of cross-connection 2...5-pole	A	(QL 2) 125
Continuous current rating of cross-connection 6...10-pole	A	(QL 2) 125

Rated data according to UL/CSA

Voltage/current/conductor size	UL	600 V/95 A/2 AWG
Voltage/current/conductor size	CSA	600 V/110 A/6...1 AWG

Ordering data

Type		Cat. No.	Qty.
KrG		0170020000	10

UL @

28/70/63.5

15 mm/M 6/-

1000 V*/125 A/35 mm²

8 kV/3

3...6

6...35

6...35

10...35

6...35

B 9

125 A/35 mm²

(QL 2) 125

600 V/95 A/2 AWG

600 V/110 A/6...1 AWG

Cat. No. Qty.

0170020000 10

UL @ DNV

28/70/53

-/M 6/-

1000 V*/125 A/35 mm²

8 kV/3

3...6

125 A/35 mm²

(QL 2) 125

600 V/115 A/2 AWG

600 V/110 A/6...1 AWG

Cat. No. Qty.

0170320000 10

End plate, hard paper

	Cat. No.	Qty.
	EP 1 (2)	0205100000 10
	EP 1 (2)	0205200000 10



0205100000
0205200000

tropic-proof

Partition, hard paper (thickness in mm)

	Cat. No.	Qty.
	0180700000, 0205300000	
	0180800000, 0205400000	tropic-proof



0180700000, 0205300000

0180800000, 0205400000

tropic-proof

Partition, hard paper (thickness in mm)

	Cat. No.	Qty.
	TW 1 (2)	0151400000 10
	TW 1 (2)	0164600000 10



0151400000

0164600000

tropic-proof

Partition, hard paper (thickness in mm)

	Cat. No.	B/L/H (incl. TS 32) mm	2/120/75.5
	Cat. No.	B/L/H (incl. TS 35) mm	2/120/75.5



0177100000 B/L/H (incl. TS 32) mm

0179900000 B/L/H (incl. TS 35) mm

2/120/75.5

2/120/75.5

Cross-connection

	2-pole	QL 2	0193900000 5
	3-pole	QL 3	0407600000 5
	4-pole	QL 4	0407700000 5



QL 2

QL 3

QL 4

QL 2 **0193900000** 5

QL 3 **0407600000** 5

QL 4 **0407700000** 5

Cover

	AH 28	0326660000 5
--	-------	---------------------



AH 28

0326660000 5

AH 28 **0326660000** 5

Marking tags

	1	2	3	4	5	6	DEK	Standard
--	---	---	---	---	---	---	-----	----------

DEK 5 see "Accessories"

Print

DEK 5 see "Accessories"

Mounting rails, end brackets, further marking material see "Accessories"

During conductor connection, observe clearance and creepage distances. Insert partitions if necessary.

Feed-through terminals

SAKG 28 II G



28/70/53
-/M 6/-
1000 V*/125 A/35 mm ²
8 kV/3
3...6
125 A/35 mm ²
(QL 2) 125

600 V/110 A/6...1 AWG
Cat. No. Qty.
0185020000 10

EP 1 (2)	Cat. No.	Qty.
EP 1 (2)	0205100000	10
EP 1 (2)	0205200000	10

Cat. No.	Qty.
----------	------

TW 1 (2)	Cat. No.	Qty.
TW 1 (2)	0151400000	10
TW 1 (2)	0164600000	10

2/120/75.5

QL 2	0193900000	5
QL 3	0407600000	5
QL 4	0407700000	5

AH 28	0326660000	5
-------	-------------------	---

DEK 5	see "Accessories"
-------	-------------------

SAKG 28 III



28/70/63.5
15 mm/M 6/-
1000 V*/125 A/35 mm ²
8 kV/3
3...6
6...35
6...35
10...35
6...35
B 9
600 V/95 A/2 AWG
600 V/135 A/8...2 AWG

600 V/135 A/8...2 AWG
Cat. No. Qty.
0170820000 10

EP 1 (2)	Cat. No.	Qty.
EP 1 (2)	0205100000	10
EP 1 (2)	0205200000	10

Cat. No.	Qty.
----------	------

TW 1 (2)	Cat. No.	Qty.
TW 1 (2)	0151400000	10
TW 1 (2)	0164600000	10

2/120/75.5

QL 2	0194000000	5
QL 3	0441500000	5
QL 4	0441600000	5

AH 28	0326660000	5
-------	-------------------	---

DEK 5	see "Accessories"
-------	-------------------

SAKG 32 I SAKG 32/35 I



32/87/84
32/87/84.5
26 mm/M 8/-
1000 V*/150 A/50 mm ²
8 kV/3
6...12
10...70
10...70
10...70
10...35
B 11
150 A/50 mm ²
(QL 2) 150

600 V/165 A/3 AWG
600 V/170 A/1...2/0 AWG
Cat. No. Qty.
0286620000 0637120000 10

EP 1 (2)	Cat. No.	Qty.
EP 1 (2)	0205300000	10
EP 1 (2)	0205400000	10

EP 2/35 (2)	Cat. No.	Qty.
EP 2/35 (2)	0180700000	10
EP 2/35 (2)	0180800000	10

TW 2 (2)	Cat. No.	Qty.
TW 2 (2)	0177100000	10
TW 2 (2)	0179900000	10

2/160/90.5
2/160/90.5

QL 2	0194000000	5
QL 3	0441500000	5
QL 4	0441600000	5

AH 32	0326760000	5
-------	-------------------	---

DEK 5	see "Accessories"
-------	-------------------

SAKG 32 II SAKG 32/35 II



32/80/53
32/80/51
-/M 8/-
1000 V*/150 A/50 mm ²
8 kV/3
6...12
150 A/50 mm ²
(QL 2) 150

600 V/200 A/3 AWG
600 V/170 A/1...2/0 AWG
Cat. No. Qty.
0170420000 0637320000 10

EP 1 (2)	Cat. No.	Qty.
EP 1 (2)	0205100000	10
EP 1 (2)	0205200000	10

EP 1/35 (2)	Cat. No.	Qty.
EP 1/35 (2)	0180700000	10
EP 1/35 (2)	0180600000	10

TW 1 (2)	Cat. No.	Qty.
TW 1 (2)	0151400000	10
TW 1 (2)	0164600000	10

2/120**/75.5
2/120**/75.5

QL 2	0194000000	5
QL 3	0441500000	5
QL 4	0441600000	5

AH 32	0326760000	5
-------	-------------------	---

DEK 5	see "Accessories"
-------	-------------------

SAKG 32 II G SAKG 32/35 II G



32/80/53
32/80/53
-/M 8/-
1000 V*/150 A/50 mm ²
8 kV/3
6...12
150 A/50 mm ²
(QL 2) 150

600 V/170 A/1...2/0 AWG
Cat. No. Qty.
0185120000 0637420000 10

EP 1 (2)	Cat. No.	Qty.
EP 1 (2)	0205100000	10
EP 1 (2)	0205200000	10

EP 1/35 (2)	Cat. No.	Qty.
EP 1/35 (2)	0180700000	10
EP 1/35 (2)	0180600000	10

TW 1 (2)	Cat. No.	Qty.
TW 1 (2)	0151400000	10
TW 1 (2)	0164600000	10

2/120**/75.5
2/120**/75.5

QL 2	0194000000	5
QL 3	0441500000	5
QL 4	0441600000	5

AH 32	0326760000	5
-------	-------------------	---

DEK 5	see "Accessories"
-------	-------------------

SAKG 32 III SAKG 32/35 III

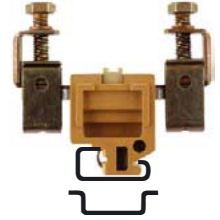

32/94/84
32/94/84.5
26 mm/M 8/-
1000 V*/150 A/50 mm ²
8 kV/3
6...12
10...70
10...70
10...70
10...35
B 11
150 A/50 mm ²

600 V/165 A/3 AWG
600 V/185 A/1...2/0 AWG
Cat. No. Qty.
0286720000 0637220000 10

EP 2 (2)	Cat. No.	Qty.
EP 2 (2)	0205300000	10
EP 2 (2)	0205400000	10

EP 2/35 (2)	Cat. No.	Qty.
EP 2/35 (2)	0180700000	10
EP 2/35 (2)	0180800000	10

TW 2 (2)	Cat. No.	Qty.
TW 2 (2)	0177100000	10
TW 2 (2)	0179900000	10

2/160/90.5
2/160/90.5

QL 2	0194000000	5
QL 3	0441500000	5
QL 4	0441600000	5

AH 32	0326760000	5
-------	-------------------	---

DEK 5	see "Accessories"
-------	-------------------

* During conductor connection, observe clearance and creepage distances. Insert partitions if necessary
 ** For Cat. No. **0180600000** and **0180700000**: length = 160 mm.

Feed-through terminals

SAKG 70 II G SAKG 70/35 II G



Ⓢ Ⓡ Ⓝ DNV

Width/length/height (mm) with TS 32	32/84/54
Width/length/height (mm) with TS 35 x 7.5	32/84/53
Insulation stripping length/clamping screw/screwdriver blade	-/M 8/-

Dimensions/approvals

Width/length/height (mm) with TS 32	32/84/54
Width/length/height (mm) with TS 35 x 7.5	32/84/53
Insulation stripping length/clamping screw/screwdriver blade	-/M 8/-

Rated data according to IEC 60 947-7-1

Rated voltage/current/cross-section	1000 V*/192 A/70 mm ²
Rated impulse voltage/pollution severity	8 kV/3

Further technical data

Tightening torque range	Nm 6...12
Torque setting with electric screwdriver type DMS 2	

Clampable conductor

Solid H07V-U	mm ²	
Stranded H07V-R	mm ²	10...95
Flexible H07V-K	mm ²	10...95
Flexible H07V-K and ferrule according to DIN 46 228/1	mm ²	10...35
Plug gauge according to 60 947-7-1	Size	B 12
Continuous current of terminal for conductor size		192 A/90 mm ²
Continuous current rating of cross-connection 2...5-pole	A	(QL 2) 192
Continuous current rating of cross-connection 6...10-pole	A	

Rated data according to UL/CSA

Voltage/current/conductor size	UL	600 V/195 A/4/0 AWG
Voltage/current/conductor size	CSA	600 V/200 A/2/0...4/0 AWG

Ordering data

Version	KrG	Qty.	Qty.
		⏏	⏏
		0150420000 10	0636620000 10

SAKG 40 I SAKG 40/35 I

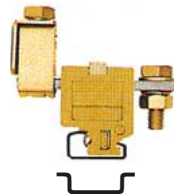

Ⓢ Ⓡ Ⓝ Ⓢ

Width/length/height (mm)	40/95/84
Width/length/height (mm)	46/95/85.5
Insulation stripping length/clamping screw/screwdriver blade	27 mm/M 10/-

SAKG 40 II SAKG 40/35 II



Ⓢ Ⓡ Ⓝ Ⓢ DNV

Width/length/height (mm)	40/90/53
Width/length/height (mm)	46/90/53
Insulation stripping length/clamping screw/screwdriver blade	-/M 10/-

SAKG 40 II G SAKG 40/35 II G



Ⓢ Ⓡ Ⓝ

Width/length/height (mm)	40/90/55
Width/length/height (mm)	46/90/55
Insulation stripping length/clamping screw/screwdriver blade	-/M 10/-

Rated voltage/current/cross-section	1000 V*/232 A/95 mm ²
Rated impulse voltage/pollution severity	8 kV/3

Tightening torque range	Nm 10...20
Torque setting with electric screwdriver type DMS 2	

Solid H07V-U	mm ²	
Stranded H07V-R	mm ²	10...95
Flexible H07V-K	mm ²	10...95
Flexible H07V-K and ferrule according to DIN 46 228/1	mm ²	10...35
Plug gauge according to 60 947-7-1	Size	B 12
Continuous current of terminal for conductor size		232 A/95 mm ²
Continuous current rating of cross-connection 2...5-pole	A	(QL 2) 232
Continuous current rating of cross-connection 6...10-pole	A	

Voltage/current/conductor size	UL	600 V/230 A/4/0 AWG
Voltage/current/conductor size	CSA	600 V/250 A/2/0...4/0 AWG

Version	KrG	Qty.	Qty.
		⏏	⏏
		0170520000 10	0637720000 5

End plate, hard paper (thickness mm)

0205100000, 0180500000		Cat. No.	Qty.
0205200000, 0180600000	tropic-proof	EP 1 (2)	0205100000 10
		EP 1 (2)	0205200000 10

0180700000, 0205300000		Cat. No.	Qty.
0180800000, 0205400000	tropic-proof	EP 1/35 (2)	0180500000 10
		EP 1/35 (2)	0180600000 10

Partition, hard paper (thickness mm)

0151400000		Cat. No.	Qty.
0164600000	tropic-proof	TW 1 (2)	0151400000 10
		TW 1 (2)	0164600000 10

0177100000	B/L/H (incl. TS 32) mm	2/120/75.5	
0179900000	B/L/H (incl. TS 35) mm	2/120/75.5	

Cross-connection

2-pole, QL 2	Qty.	Qty.	Qty.	Qty.
3-pole, QL 3	0194000000 10	0194100000 10	0211400000 10	0194100000 10
4-pole, QL 4	0441500000 10	0263500000 10	0444900000 10	0263500000 10
	0441600000 10	0409800000 10	0445000000 10	0409800000 10

Cover

AH 32	0326760000	5	AH 40	0326860000	5	AH 40	0326860000	5	AH 40	0326860000	5
-------	------------	---	-------	------------	---	-------	------------	---	-------	------------	---

Marking tags

1 2 3 4 5 6	DEK	Standard	DEK 5	see "Accessories"	DEK 5	see "Accessories"	DEK 5	see "Accessories"	DEK 5	see "Accessories"
-------------	-----	----------	-------	-------------------	-------	-------------------	-------	-------------------	-------	-------------------

Mounting rails, end brackets, further marking material see "Accessories"

*During conductor connection, observe clearance and creepage distances. Insert partitions if necessary.

Feed-through terminals

SAKG 40 III SAKG 40/35 III



UL @ 3 4
40/100/84
46/100/85.5
27 mm/M 10/-
1000 V*/232 A/95 mm ²
8 kV/3
10...20
10...95
10...95
10...95
10...35
B 12
232 A/95 mm ²

600 V/195 A/4/0 AWG
600 V/230 A/2/0...4/0 AWG
Qty. Qty.
0286920000 10 0637620000 5

EP 2 (2)	Cat. No.	Qty.
EP 2 (2)	0205300000	10
EP 2 (2)	0205400000	10

EP 2/35 (2)	Cat. No.	Qty.
EP 2/35 (2)	0180700000	10
EP 2/35 (2)	0180800000	10

TW 2 (2)	Cat. No.	Qty.
TW 2 (2)	0177100000	10
TW 2 (2)	0179900000	10

2/160/90.5
2/160/90.5

QL 2	0247000000	5
QL 3	0444400000	5
QL 4	0444500000	5

AH 40	0326860000	5
-------	------------	---

DEK 5	see "Accessories"
-------	-------------------

SAKG 46 II SAKG 46/35 II



UL @ 3 4
46/106/55
46/106/54.5
-/M 12/-
1000 V*/309 A/150 mm ²
8 kV/3
14...31
309 A/150 mm ²

600 V/285 A/4/0 AWG
600 V/365 A/300 MCM
Qty. Qty.
0170620000 10 0637920000 5

EP 2 (2)	Cat. No.	Qty.
EP 2 (2)	0205300000	10
EP 2 (2)	0205400000	10

EP 2/35 (2)	Cat. No.	Qty.
EP 2/35 (2)	0180700000	10
EP 2/35 (2)	0180800000	10

TW 2 (2)	Cat. No.	Qty.
TW 2 (2)	0177100000	10
TW 2 (2)	0179900000	10

2/160/90.5
2/160/90.5

QL 2	0247000000	5
QL 3	0444400000	5
QL 4	0444500000	5

AH 46	0326960000	5
-------	------------	---

DEK 5	see "Accessories"
-------	-------------------

SAKG 46 II G SAKG 46/35 II G



@ 3 4 DNV
46/106/57.5
46/106/57
-/M 12/-
1000 V*/309 A/150 mm ²
8 kV/3
14...31
309 A/150 mm ² (QL 2) 309

600 V/285 A/4/0 AWG
600 V/365 A/300 MCM
Qty. Qty.
0185320000 10 0638020000 5

EP 2 (2)	Cat. No.	Qty.
EP 2 (2)	0205300000	10
EP 2 (2)	0205400000	10

EP 2/35 (2)	Cat. No.	Qty.
EP 2/35 (2)	0180700000	10
EP 2/35 (2)	0180800000	10

TW 2 (2)	Cat. No.	Qty.
TW 2 (2)	0177100000	10
TW 2 (2)	0179900000	10

2/160/90.5
2/160/90.5

QL 2	0247000000	5
QL 3	0444400000	5
QL 4	0444500000	5

AH 46	0326960000	5
-------	------------	---

DEK 5	see "Accessories"
-------	-------------------

SAKG 54 II SAKG 54/35 II

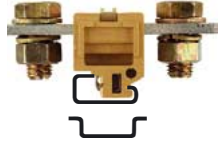

UL @ 3 4
54/122/57
54/122/57
-/M 16/-
1000 V*/415 A/240 mm ²
8 kV/3
25...60
415 A/240 mm ² (QL 2) 415

600 V/380 A/500 MCM
600 V/600 A/300...500 MCM
Qty. Qty.
0170720000 10 0638120000 5

EP 2 (2)	Cat. No.	Qty.
EP 2 (2)	0205300000	10
EP 2 (2)	0205400000	10

EP 2/35 (2)	Cat. No.	Qty.
EP 2/35 (2)	0180700000	10
EP 2/35 (2)	0180800000	10

TW 2 (2)	Cat. No.	Qty.
TW 2 (2)	0177100000	10
TW 2 (2)	0179900000	10

2/160/90.5
2/160/90.5

QL 2	0264400000	5
QL 3	0408000000	5
QL 4	0247400000	5

DEK 5	see "Accessories"
-------	-------------------

SAKG 54 II G SAKG 54/35 II G

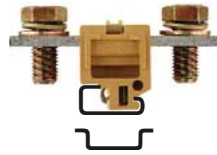

UL @ 3 4 DNV
54/122/60
54/122/60
-/M 16/-
1000 V*/415 A/240 mm ²
8 kV/3
25...60
415 A/240 mm ² (QL 2) 415

600 V/380 A/500 MCM
600 V/600 A/300...500 MCM
Qty. Qty.
0185420000 10 0638220000 5

EP 2 (2)	Cat. No.	Qty.
EP 2 (2)	0205300000	10
EP 2 (2)	0205400000	10

EP 2/35 (2)	Cat. No.	Qty.
EP 2/35 (2)	0180700000	10
EP 2/35 (2)	0180800000	10

TW 2 (2)	Cat. No.	Qty.
TW 2 (2)	0177100000	10
TW 2 (2)	0179900000	10

2/160/90.5
2/160/90.5

QL 2	0264400000	5
QL 3	0408000000	5
QL 4	0247400000	5

DEK 5	see "Accessories"
-------	-------------------

SAKG 46/I AL SAKG 46/II AL



46/112/74
23 mm/M 12/M 14/-
1000 V*/309 A/150 mm ²
8 kV/3
14...31/25...40
50...240
35...185

Qty. Qty.
1287920000** 5

EP 2 (2)	Cat. No.	Qty.
EP 2 (2)	0205300000	10
EP 2 (2)	0205400000	10

EP 2/35 (2)	Cat. No.	Qty.
-------------	----------	------

TW 2 (2)	Cat. No.	Qty.
TW 2 (2)	0177100000	10
TW 2 (2)	0179900000	10

2/160/90.5
2/160/90.5

QL 2	0194000000	5
QL 3	0441500000	5
QL 4	0441600000	5

AH 46	0326960000	5
-------	------------	---

DEK 5	see "Accessories"
-------	-------------------

SAK-series

* During conductor connection, observe clearance and creepage distances. Insert partitions if necessary.
** Suitable for connection of 1 aluminium conductor of max 185 mm²

*** Suitable for connection of 2 aluminium conductors of max. 185 mm²

Stud terminals

SS 6 SS 6/35

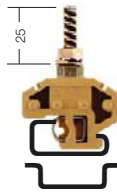

KST 5 KST 5/35



KST 6 KST 6/35

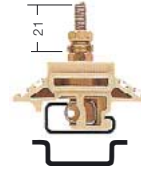

KST 8 KST 8/35

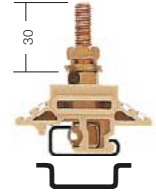

Dimensions/approvals

Width/length/height (mm)	with TS 32	
Width/length/height (mm)	with TS 35 x 7.5	
Insulation stripping length/clamping screw/screwdriver blade		

Rated data

Rated voltage/current/cross-section		
Rated impulse voltage/pollution severity		

Further technical data

Tightening torque range	Nm	
Torque setting with electric screwdriver type DMS 2		

Clampable conductor

Solid H07V-U	mm ²	
Stranded H07V-R	mm ²	
Flexible H07V-K	mm ²	
Flexible H07V-K and ferrule according to DIN 46 228/1	mm ²	
Plug gauge according to 60 947-7-1	Size	
Continuous current of terminal for conductor size		
Continuous current rating of cross-connection 2...5-pole	A	
Continuous current rating of cross-connection 6...10-pole	A	

Rated data according to UL/CSA

Voltage/current/conductor size	UL	
Voltage/current/conductor size	CSA	

Ordering data

Version		Qty.	
KrG			
PA			
PPO			
KrG			
for TS 35 x 7.5	PA		
for TS 35 x 15/2.3	PA		

18/40/62
18/49.5/54.5
-/M 6/-

24/60/55
24/62.5/49.5
-/M 5/-

24/60/62
24/62.5/54.5
-/M 6/-

24/60/72
24/62.5/64.5
-/M 8/-

1000 V ¹⁾ /76 A/16 mm ²
6 kV/3

1000 V ¹⁾ /57 A/10 mm ²
8 kV/3

1000 V ¹⁾ /76 A/16 mm ²
8 kV/3

1000 V ¹⁾ /125 A/35 mm ²
8 kV/3

3...6

2...4

3...6

6...12

82 A/16 mm ²

65 A/10 mm ²

82 A/16 mm ²

135 A/35 mm ²

--

--

200

200

Partition, (thickness mm)

PA		
Hard paper		
HM		
HM		

Width/length/height (incl. TS 32) mm	
Width/length/height (incl. TS 35) mm	

Cross-connection

2-pole	QL 2	
3-pole	QL 3	

Marking tags

1	2	3	4	5	6
---	---	---	---	---	---

Print

DEK 5	see "Accessories"
-------	-------------------

DEK 5	see "Accessories"
-------	-------------------

DEK 5	see "Accessories"
-------	-------------------

DEK 5	see "Accessories"
-------	-------------------

Mounting rails, end brackets, further marking material see "Accessories"

^{*} Depends on cable lug

¹⁾ with partition

²⁾ Left AP is required only once at beginning of terminal strip

Stud terminals

KST 10
KST 10/35



34/60/82			34/60/82		
34/62.5/74.5			34/62.5/74.5		
-/M 10/-			-/M 12/-		
1000 V ¹⁾ /192 A/70 mm ²			1000 V ¹⁾ /232 A/95 mm ²		
8 kV/3			8 kV/3		
10...20			14...31		
207 A/70 mm ²			250 A/95 mm ²		
200			200		
600 V/175 A/12...2/0			600 V/200 A/12...3/0		
	Qty.		Qty.		Qty.
9501330000	20				
9506960000	20	9506970000	20		
9528330000	20	9528340000	20		
	+		+		
TW right	1718530000	10	TW right	1718530000	10
TW left	1752800000	10	TW left	1752800000	10
2/160/83.5			2/160/83.5		
2/160/78.5			2/160/78.5		
QL 2	9501370000	1	QL 2	9501380000	1
DEK 5	see "Accessories"		DEK 5	see "Accessories"	

PE terminals

EK 2.5 N EK 2.5/35



EK 4 EK 4/35



EK 6/35



EK 10 EK 10/35



Dimensions/approvals

Width/length/height (mm)	with TS 32	6/36.5/49.5	8/40/51.5	8/56/44	10/40/51.5
Width/length/height (mm)	with TS 35 x 7.5	6/56/40	6.5/56/44	12 mm/M 3.5/4.0/0.8	10/56/44
Insulation stripping length/clamping screw/screwdriver blade		10 mm/M 2.5/3.5 x 0.6	12 mm/M 3/3.5 x 0.6		12 mm/M 4/5.5 x 1.0
Rated data according to IEC 60 947-7-2					
Rated voltage/current with PEN/cross-section		-/-/2.5 mm ²	-/-/4 mm ²	-/-/6 mm ²	-/-/10 mm ²
Rated voltage/rated impulse voltage acc. to VDE 0110/1.89/ pollution severity					

Further technical data

Tightening torque range	Nm	0.4...0.8/0.5...1.0*	0.5...1.0/0.5...1.0*	1.2...1.6/0.5...1.0*	1.2...2.4/0.5...1.0*
-------------------------	----	----------------------	----------------------	----------------------	----------------------

Clampable conductor

Solid H07V-U	mm ²	0.5...4	0.5...6	0.5...10	0.5...10
Stranded H07V-R	mm ²	0.5...2.5	0.5...4	1.5...6	1.5...6
Flexible H07V-K	mm ²	0.5...4	0.5...4	0.5...10	0.5...10
Flexible H07V-K and ferrule DIN 46 228/1	mm ²	0.5...2.5	0.5...4	0.5...6	0.5...10
Cable AWG	Nr.	22...14	22...10	20...8	20...8
Plug gauge according to 60 947-7-1	Size	A 3	A 4	A 5	B 6

Ordering data

Version		Qty.		Qty.		Qty.		Qty.
Green/yellow PA		100		100		100		100
Blank								
Two clamping yokes blank								
Hexagon socket blank								

Support block



For insulation of mounting rails
in insulated-earth installations

Type	Cat. No.	Qty.	Type	Cat. No.	Qty.	Type	Cat. No.	Qty.	Type	Cat. No.	Qty.
SH 2	0494920000	10	SH 2	0494920000	10	SH 2	0494920000	10	SH 2	0494920000	10

SK - key, 8mm

Marking tags

	Print										
	1 2 3 4 5 6	DEK	Standard	DEK 6	see "Accessories"	DEK 6.5	see "Accessories"	DEK 8	see "Accessories"	DEK 5	see "Accessories"

Mounting rails, end brackets, further marking material see "Accessories"

* For centre screw

PE terminals

EK 16
EK 16/35



UL	CS
12/50/57.5	
12/56/50	
16 mm/M 4/5.5 x 1.0	
-/-/16 mm ²	

1.2...2.4/0.8...1.0*

2.5...16
2.5...16
2.5...16
4...16
12...6
B 6

Qty.	Qty.
0374660000 50	0190160000 50

Type	Cat. No.	Qty.
SH 2	0494920000	10

DEK 5 see "Accessories"

EK 35**
EK 35/35



UL	CS
18/58/67.5	
16/58/60	
20 mm/M 6/6.5 x 1.2	
-/-/35 mm ²	

2.5...5.0/ **

6...16
16...50
10...35
10...35
10...2
B 9

Qty.	Qty.
0354760000 20	0661460000 20

Type	Cat. No.	Qty.
SH 2	0494920000	10

DEK 5 see "Accessories"

EK 2



CS
10/52/38
14 mm/M 4/-
-/-/10

1.2...2.4/2.0...4.0*

1.5...10
1.5...10
1.5...10
1.5...10
16...8
B 6

Qty.
0323100000 20

Type	Cat. No.	Qty.
------	----------	------

SAKE 35



CS
14/46/39
16 mm/M 6/-
-/-/35 mm ²

2.5...5.0/2.0...4.0*

6...35
6...35
6...16
10...35
8...2
B 8

Qty.	Qty.
0144400000 20	

Type	Cat. No.	Qty.
SH 2	0494920000	10

SAKE 70

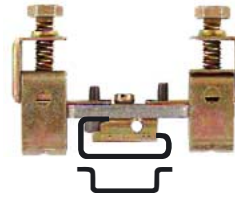

CS
18/94/59.5
25 mm/M 8/-
-/-/70 mm ²

6.0...12/2.0...4.0*

10...70
10...70
10...70
10...70
6...0
B 10

Qty.	Qty.
0213200000 20	1338300000 10

Type	Cat. No.	Qty.
SH 2	0494920000	10

EK 95/35



25/76/100/92
25/76/100/92
27 mm/M 10/-
-/-/95 mm ²

10.0...20.0/1.2...2.4*

10...120
10...95
10...95
10...95
6...4/0
B 12

Qty.
0535300000 10
0535400000 10

Type	Cat. No.	Qty.
------	----------	------

0235000000

SAK-series

** ADm f. EK 35/35 = 1.2 - 2.4 Nm
ADm f. EK 35 = 0.8 - 1.6 Nm

Fuse terminals

ASK 1¹⁾ ASK 1/35¹⁾

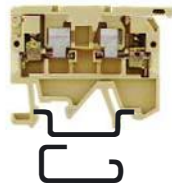

Dimensions/approvals	
Width/length/height (mm)	with TS 32 8/58/45,5
Width/length/height (mm)	with TS 35 x 7.5 8/58/44
Insulation stripping length/clamping screw/screwdriver blade	9 mm/M 3/3.5 x 0.6
Rated data/feed through-terminal base	
Rated voltage/current/cross-section	500 V/6.3 A ²⁾ /4 mm ²
Rated impulse voltage/pollution severity	6 kV/3
Further technical data	
Tightening torque range	Nm 0.5...1.0
Torque setting with electric screwdriver type DMS 2	2
Clampable conductor	
Solid H07V-U	mm ² 0.5...4
Stranded H07V-R	mm ² 1.5...4
Flexible H07V-K	mm ² 0.5...4
Flexible H07V-K and ferrule according to DIN 46 228/1	mm ² 0.5...4
Plug gauge according to 60 947-7-1	Size A 3
Continuous current rating of cross-connection 2...5-pole	A (QB 2...4) 10
Continuous current rating of cross-connection 6...10-pole	A

KDKS 1¹⁾ KDKS 1/35¹⁾



Dimensions/approvals	
Width/length/height (mm)	8/73.5/59,8
Width/length/height (mm)	8/73.5/55,7
Insulation stripping length/clamping screw/screwdriver blade	9 mm/M 3/3.5 x 0.6
Rated data/feed through-terminal base	
Rated voltage/current/cross-section	500 V/6.3 A/4 mm ²
Rated impulse voltage/pollution severity	6 kV/3
Further technical data	
Tightening torque range	Nm 0.5...1.0
Torque setting with electric screwdriver type DMS 2	2
Clampable conductor	
Solid H07V-U	mm ² 0.5...4
Stranded H07V-R	mm ² 1.5...4
Flexible H07V-K	mm ² 0.5...4
Flexible H07V-K and ferrule according to DIN 46 228/1	mm ² 0.5...4
Plug gauge according to 60 947-7-1	Size A 4
Continuous current rating of cross-connection 2...5-pole	(QB 2...4) 10
Continuous current rating of cross-connection 6...10-pole	A

SAKS 1 SAKS 1/35



Dimensions/approvals	
Width/length/height (mm)	13/54/61
Width/length/height (mm)	13/54/54
Insulation stripping length/clamping screw/screwdriver blade	12 mm/M 4/5.5 x 1.0
Rated data/feed through-terminal base	
Rated voltage/current/cross-section	500 V/6.3 A ³⁾ /10 mm ²
Rated impulse voltage/pollution severity	6 kV/3
Further technical data	
Tightening torque range	Nm 1.2...2.4
Torque setting with electric screwdriver type DMS 2	4
Clampable conductor	
Solid H07V-U	mm ² 0.5...16
Stranded H07V-R	mm ² 1.5...10
Flexible H07V-K	mm ² 0.5...10
Flexible H07V-K and ferrule according to DIN 46 228/1	mm ² 0.5...10
Plug gauge according to 60 947-7-1	Size B 6
Continuous current rating of cross-connection 2...5-pole	(QL 2...5) 47
Continuous current rating of cross-connection 6...10-pole	(QL 6...10) 36

SAKS 1/G25 SAKS 1/35/G25



Dimensions/approvals	
Width/length/height (mm)	13/54/61
Width/length/height (mm)	13/54/54
Insulation stripping length/clamping screw/screwdriver blade	12 mm/M 4/5.5 x 1.0
Rated data/feed through-terminal base	
Rated voltage/current/cross-section	500 V/6.3 A ³⁾ /10 mm ²
Rated impulse voltage/pollution severity	6 kV/3
Further technical data	
Tightening torque range	Nm 1.2...2.4
Torque setting with electric screwdriver type DMS 2	4
Clampable conductor	
Solid H07V-U	mm ² 0.5...16
Stranded H07V-R	mm ² 1.5...10
Flexible H07V-K	mm ² 0.5...10
Flexible H07V-K and ferrule according to DIN 46 228/1	mm ² 0.5...10
Plug gauge according to 60 947-7-1	Size B 6
Continuous current rating of cross-connection 2...5-pole	(QL 2...5) 47
Continuous current rating of cross-connection 6...10-pole	(QL 6...10) 36

Rated data according to UL/CSA

Voltage/current/conductor size	UL	300 V/6.3 A/12 max. AWG
Voltage/current/conductor size	CSA	300 V/6.3 A/26...12 AWG
Ordering data		
Version		Cat.No. Qty.
PA		0474560000 100
KrG		9503300000 50 9503310000 50
Beige Wemid		0191220000 20 0501620000 20

Version		Cat.No. Qty.
PA		0474560000 100
KrG		9503300000 50 9503310000 50
Beige Wemid		0191220000 20 0501620000 20

Version		Cat.No. Qty.
PA		0474560000 100
KrG		9503300000 50 9503310000 50
Beige Wemid		0191220000 20 0501620000 20

Version		Cat.No. Qty.
PA		0474560000 100
KrG		9503300000 50 9503310000 50
Beige Wemid		0191220000 20 0501620000 20

Version		Cat.No. Qty.
PA		0474560000 100
KrG		9503300000 50 9503310000 50
Beige Wemid		0191220000 20 0501620000 20

End plate/partition (thickness mm)



Type	Cat. No.	Qty.
AP (1.5)	0380360000	20

Type	Cat. No.	Qty.
AP 1 KDKS	9503330000	25
Wemid	9532470000	25
for TW (2.0)	0607000000	20

Type	Cat. No.	Qty.
AP (2.5)	0191320000	20
Wemid beige	0191300000	20
for TW (2.0)	0607000000	20

Type	Cat. No.	Qty.
AP (2.5)	0191320000	20
Wemid-beige	0191300000	20
for TW (2.0)	0607000000	20

G-fuse inserts

Acc. to IEC 60127-2 (VDE 0820 T.2 BI 1) rated current (A):	0.10 fast	0430300000	10
Rated voltage 250 V	0.20 fast	0430400000	10
Fast switching capacity 1500 A	0.25 fast	0430500000	10
(at 250 V, 50 Hz, cos φ = 0.7)	0.50 fast	0430600000	10
	1.0 fast	0430700000	10
	1.6 fast	0430800000	10
	2.0 fast	0430900000	10
	2.5 fast	0431000000	10
	3.15 fast		
	4.0 fast		
	5.0 fast		
	6.3 fast		

Acc. to IEC 60127-2 (VDE 0820 T.2 BI 1) rated current (A):	0.10 fast	0430300000	10
Rated voltage 250 V	0.20 fast	0430400000	10
Fast switching capacity 1500 A	0.25 fast	0430500000	10
(at 250 V, 50 Hz, cos φ = 0.7)	0.50 fast	0430600000	10
	1.0 fast	0430700000	10
	1.6 fast	0430800000	10
	2.0 fast	0430900000	10
	2.5 fast	0431000000	10
	3.15 fast		
	4.0 fast		
	5.0 fast		
	6.3 fast		

Acc. to IEC 60127-2 (VDE 0820 T.2 BI 1) rated current (A):	0.10 fast	0430300000	10
Rated voltage 250 V	0.20 fast	0430400000	10
Fast switching capacity 1500 A	0.25 fast	0430500000	10
(at 250 V, 50 Hz, cos φ = 0.7)	0.50 fast	0430600000	10
	1.0 fast	0430700000	10
	1.6 fast	0430800000	10
	2.0 fast	0430900000	10
	2.5 fast	0431000000	10
	3.15 fast		
	4.0 fast		
	5.0 fast		
	6.3 fast		

Acc. to IEC 60127-2 (VDE 0820 T.2 BI 1) rated current (A):	0.10 fast	0430300000	10
Rated voltage 250 V	0.20 fast	0430400000	10
Fast switching capacity 1500 A	0.25 fast	0430500000	10
(at 250 V, 50 Hz, cos φ = 0.7)	0.50 fast	0430600000	10
	1.0 fast	0430700000	10
	1.6 fast	0430800000	10
	2.0 fast	0430900000	10
	2.5 fast	0431000000	10
	3.15 fast		
	4.0 fast		
	5.0 fast		
	6.3 fast		

Contact sleeve	0553300000	100
Screw cap/disconnector lever (spare)		

Contact sleeve	0553300000	100
Screw cap/disconnector lever (spare)		

Contact sleeve	0553300000	100
Screw cap/disconnector lever (spare)		

Contact sleeve	0553300000	100
Screw cap/disconnector lever (spare)		

Marking tags

Red pull lever	TH 0377060000 100
	SIHA 1593020000 100

Marking tags

Red pull lever	TH 0377060000 100
	SIHA 1593020000 100

Marking tags

Red pull lever	SK (5 x 20) 0282100000 20
	SK (5 x 25) 0282000000 20

Marking tags

Red pull lever	SK (5 x 20) 0282100000 20
	SK (5 x 25) 0282000000 20

Mounting rails, end brackets, further marking material see "Accessories"

DEK	Standard	DEK 8	see "Accessories"
-----	----------	-------	-------------------

Mounting rails, end brackets, further marking material see "Accessories"

DEK	Standard	DEK 8	see "Accessories"
-----	----------	-------	-------------------

Mounting rails, end brackets, further marking material see "Accessories"

DEK	Standard	DEK 5	see "Accessories"
-----	----------	-------	-------------------

Mounting rails, end brackets, further marking material see "Accessories"

DEK	Standard	DEK 5	see "Accessories"
-----	----------	-------	-------------------

¹⁾ Multipole interruptable with group marking carrier
Sch2 2-pole Cat. No. **1359500000**, 1000 mm Cat. No. **0337400000**

Fuse terminals

KSKM 1 KSKM 1/35

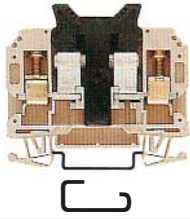

13/69/62
13/69/63
12 mm/-/-

250 V/6.3 A¹⁾/10 mm²

0.5...16

0.5...10

B 6

600 V/10 A/22...8 AWG

Qty. Qty.

9509570000 20 9509600000 20

Type	Cat. No.	Qty.
AP (3)	9509630000	20

5 x 20 mm

0.10 (f)	0430300000	10
0.20 (f)	0430400000	10
0.25 (f)	0430500000	10
0.50 (f)	0430600000	10
1.00 (f)	0430700000	10
1.60 (f)	0430800000	10
2.00 (f)	0430900000	10
2.50 (f)	0431000000	10
3.15 fast	0431100000	10
4.0 fast	0431200000	10
5.0 fast	0431300000	10
6.3 fast	0431400000	10

5 x 20 SBL 0446100000 40

DEK 5 see "Accessories"

KSKM 2 KSKM 2/35

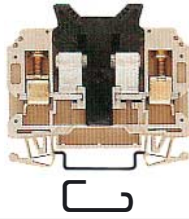

13/69/62
13/69/63
12 mm/-/-

250 V/13 A²⁾/10 mm²

0.5...16

0.5...10

B 6

600 V/15 A/22...8 AWG

Qty. Qty.

9509580000 20 9509610000 20

Type	Cat. No.	Qty.
AP (3)	9509630000	20

1 x 1/4"

1 x 1/4" SBL 0446200000 40

DEK 5 see "Accessories"

KSKM 3 KSKM 3/35

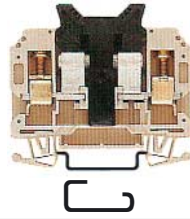

13/69/62
13/69/63
12 mm/-/-

440 V/10 A/10 mm²

0.5...16

0.5...10

B 6

600 V/15 A/22...8 AWG

Qty. Qty.

9509620000 20

Type	Cat. No.	Qty.
AP (3)	9509630000	20

1 1/4 x 1/4"

E 2 A	0294500000	10
E 3 A	0295700000	10
E 5 A	0294600000	10
E 7 A	0295800000	10
E 10 A	0293900000	10

1 1/4 x 1/4" SBL 0446300000 40

DEK 5 see "Accessories"

¹⁾ Max. fuse rating according to DIN 41 660, IEC 127 CEE4 Type 1
²⁾ Fuse according to BS 1362

Fuse terminals

SAKS 3 SAKS 3/35

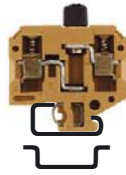

Width/length/height (mm) with TS 32	13/54/61
Width/length/height (mm) with TS 35 x 7.5	13/54/55
Insulation stripping length/clamping screw/screwdriver blade	12 mm/M 4/5.5 x 1
Rated data/feed through-terminal base	
Rated voltage/current/cross-section	500 V/10 A/10 mm ²
Rated impulse voltage/pollution severity	6 kV/3
Further technical data	
Tightening torque range	Nm 1.2...2.4
Torque setting with electric screwdriver type DMS 2	4
Clampable conductor	
Solid H07V-U	mm ² 0.5...16
Stranded H07V-R	mm ² 1.5...10
Flexible H07V-K	mm ² 0.5...10
Flexible H07V-K and ferrule according to DIN 46 228/1	mm ² 0.5...10
Plug gauge according to 60 947-7-1	Size B 6
Continuous current rating of cross-connection 2...5-pole	A (QL 2...5) 47
Continuous current rating of cross-connection 6...10-pole	A (QL 6...10) 36

SAKS 4 SAKS 4/35



Width/length/height (mm)	24/75/73
Width/length/height (mm)	24/75/66
Insulation stripping length/clamping screw/screwdriver blade	14 mm/M 4/5.5 x 1
Rated data/feed through-terminal base	
Rated voltage/current/cross-section	400 V**/16 A/10 mm ²
Rated impulse voltage/pollution severity	6 kV/3
Further technical data	
Tightening torque range	Nm 1.2...2.4
Torque setting with electric screwdriver type DMS 2	4
Clampable conductor	
Solid H07V-U	mm ² 0.5...16
Stranded H07V-R	mm ² 1.5...10
Flexible H07V-K	mm ² 0.5...10
Flexible H07V-K and ferrule according to DIN 46 228/1	mm ² 0.5...10
Plug gauge according to 60 947-7-1	Size B 6
Continuous current rating of cross-connection 2...5-pole	A (QL 2...5) 47
Continuous current rating of cross-connection 6...10-pole	A (QL 6...10) 36

SAKS 5 SAKS 5/35

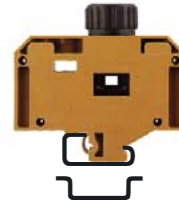

Width/length/height (mm)	28/80/80.5
Width/length/height (mm)	28/80/66
Insulation stripping length/clamping screw/screwdriver blade	13 mm/M 4/5.5 x 1
Rated data/feed through-terminal base	
Rated voltage/current/cross-section	400 V/63 A***/16 mm ²
Rated impulse voltage/pollution severity	6 kV/3
Further technical data	
Tightening torque range	Nm 1.2...2.4
Torque setting with electric screwdriver type DMS 2	4
Clampable conductor	
Solid H07V-U	mm ² 1.5...16
Stranded H07V-R	mm ² 1.5...16
Flexible H07V-K	mm ² 1.5...16
Flexible H07V-K and ferrule according to DIN 46 228/1	mm ² 1.5...16
Plug gauge according to 60 947-7-1	Size B 7
Continuous current rating of cross-connection 2...5-pole	A (QL 2...5) 47
Continuous current rating of cross-connection 6...10-pole	A (QL 6...10) 36

SAKS 2 SAKS 2/35



Width/length/height (mm)	28/80/81.5
Width/length/height (mm)	28/80/75
Insulation stripping length/clamping screw/screwdriver blade	12 mm/M 4/5.5 x 1
Rated data/feed through-terminal base	
Rated voltage/current/cross-section	500 V/10 (25) A***/10 mm ²
Rated impulse voltage/pollution severity	6 kV/3
Further technical data	
Tightening torque range	Nm 1.2...2.4
Torque setting with electric screwdriver type DMS 2	4
Clampable conductor	
Solid H07V-U	mm ² 0.5...16
Stranded H07V-R	mm ² 0.5...10
Flexible H07V-K	mm ² 0.5...10
Flexible H07V-K and ferrule according to DIN 46 228/1	mm ² 0.5...10
Plug gauge according to 60 947-7-1	Size B 6
Continuous current rating of cross-connection 2...5-pole	A (QL 2...5) 47
Continuous current rating of cross-connection 6...10-pole	A (QL 6...10) 36

Dimensions/approvals

Width/length/height (mm)	with TS 32	
Width/length/height (mm)	with TS 35 x 7.5	
Insulation stripping length/clamping screw/screwdriver blade		

Rated data/feed through-terminal base

Rated voltage/current/cross-section	500 V/10 A/10 mm ²
Rated impulse voltage/pollution severity	6 kV/3

Further technical data

Tightening torque range	Nm 1.2...2.4
Torque setting with electric screwdriver type DMS 2	4

Clampable conductor

Solid H07V-U	mm ² 0.5...16
Stranded H07V-R	mm ² 1.5...10
Flexible H07V-K	mm ² 0.5...10
Flexible H07V-K and ferrule according to DIN 46 228/1	mm ² 0.5...10
Plug gauge according to 60 947-7-1	Size B 6
Continuous current rating of cross-connection 2...5-pole	A (QL 2...5) 47
Continuous current rating of cross-connection 6...10-pole	A (QL 6...10) 36

Rated data according to UL/CSA

Voltage/current/conductor size	UL	300 V/10 A/22...10 AWG
Voltage/current/conductor size	CSA	600 V/10 A/22...10 AWG

Ordering data

Version		Qty.		Qty.
KrG	0248920000 ³⁾ 20	0667520000 ³⁾ 20		
KrG	0297520000 ⁴⁾ 20	0328920000 ⁴⁾ 20		

Neozed D 01

Type	Cat. No.	Qty.
AP (2.5)	0191320000	
HP for		
TW (2.0)	0607000000	

Neozed D 02

Type	Cat. No.	Qty.
TW HP (2.0)	0607000000 ²⁾	20

Diazed E 16

Type	Cat. No.	Qty.
TW HP (2.0)	0607000000 ²⁾	20

End plate/partition (thickness mm)

PA	Type	Cat. No.	Qty.
HP	AP (2.5)	0191320000	
	HP for		
	TW (2.0)	0607000000	

Cross-connection

QL	
SS	

Fixing screws for cross-connections

Fuse inserts

1 1/4" x 1/4"	Nominal current (A):	Fuse insert
	0.5 fast	E 0.5 A 0533800000
	1.0 fast	E 1 A 0525500000
	2.0 fast	E 2 A 0294500000
	3.0 fast	E 3 A 0295700000
	5.0 fast	E 5 A 0294600000
	7.0 fast	E 7 A 0295800000
	10.0 fast	E 10 A 0293900000

G fuse inserts 5 x 30 mm

(500 V~/0.032...6.3 A).

Available from Wickmann-Werke GmbH,

Annstr. 113, 58453 Witten, Germany, Phone ++492302/6620

D fuse inserts

Rated voltage 400 V	
E 14/2	0137400000 10
E 14/4	0137500000 10
E 14/6	0328300000 10
E 14/10	0328400000 10
E 14/16	0328500000 10

Rated voltage 400 V	
E 18/20	0361300000 10
E 18/25	0361400000 10
E 18/35	0361500000 10
E 18/50	0361600000 10
E 18/63	0361700000 10

Rated voltage 500 V	
E 10 A	0208500000 25
E 16 A	0208600000 25
E 20 A	0208700000 25
E 25 A	0208800000 25

Screw cap (spare)

red	SK (5 x 30)	0282000000 20
black	SK (1/4"x1 1/4")	0428900000 20

SK	0339410000 20
----	---------------

SK	0359310000 20
----	---------------

SK	0284110000 20
----	---------------

Marking tags

	DEK	Standard
--	-----	----------

DEK 5	see "Accessories"
-------	-------------------

DEK 5	see "Accessories"
-------	-------------------

DEK 5	see "Accessories"
-------	-------------------

Mounting rails, end brackets, further marking material see "Accessories"

¹⁾ only for TS 32

²⁾ Also for 440 V- with neozed marina fuse

³⁾ Current for overload up to 10 A, for short circuit up to 25 A

³⁾ For fuse inserts 1 1/4 x 1/4" DEF 63

⁴⁾ For fuse inserts 5 x 30

Fuse terminals

SAKS 4 USA



UL		
24/75/73		
24/75/66		
14 mm/M 4/5.5 x 1		
400 V/30 A/10 mm ²		
6 kV/3		
1.2...2.4		
4		
0.5...16		
1.5...10		
0.5...10		
0.5...10		
B 6		
(QL 2...5) 47		
(QL 6...10) 36		
600 V/30 A/20...8 AWG		
600 V/30 A/22...8 AWG		
	Qty.	
0162220000 20 0178220000 20		
10.3 x 38,1		
Type	Cat. No.	Qty.
TW HP (2.0)	0607000000	20
QL 2	0328000000	20
QL 3	0328100000	20
QL 4	0328200000	20
QL 10	0339000000	20
SS M 4	0136400000	100
BS M 4 x 9	0103300000	100
SK (w. spring)	0161730000	20
DEK 5	see "Accessories"	

Fuse terminals with fault indicator



Dimensions/approvals	
Terminal width (+ 0.2 assembly tolerance)	mm 8
Insulation stripping length	mm 9
Connection data	
Screw connection, solid	
Screw connection, flexible/ferrule with/without plastic collar	
Conductor cross-section	
VDE rated data	
Current	6.3 A
Voltage	24...230 V (depending on terminal)
LED-current (24...60 V)	≤ 2 mA
LED-current (115...230 V)	≤ 2 mA
LED-current (24...230 V)	
Incandescent lamp-current	
Neon lamp-current	
Cross-section	4 mm ²
Ordering data	
	24 V- ASK 1 LD 8050810000 25
	24 V- ASK 1 LD 0222760000 25
	48 V- ASK 1 LD 0225260000 25
	60 V- ASK 1 LD 0226460000 25
	115 V- ASK 1 LD 0225460000 25
	230 V- ASK 1 LD 0225660000 25
	24 V- ASK 1 LD 0222860000 25
	48 V- ASK 1 LD 0225360000 25
	60 V- ASK 1 LD 0226360000 25
	115 V- ASK 1 LD 0225560000 25
	230 V- ASK 1 LD 0225760000 25
Mountable on TS 32 and TS 35	
Accessories	
Mounting rail	TS 32 0122800000 TS 35x7.5 0383400000 TS 35x15 0498000000
End brackets (thickness mm)	for TS 32 0206160000 50 for TS 35 0383560000 50
End plate/End plate (thickness mm)	AP PA (1.5) 0380360000 20
Cross-connections	
Type 'QL'	
Cross-connection	QB 2 ¹⁾ 0461100000 100
Type 'QB'	QB 3 ¹⁾ 0461200000 50 QB 4 ¹⁾ 0461300000 50
Fixing screw (fits QL)	straight angled
Disconnect lever (spare)	TH (spare) 0377060000 100
Mounting rails, end brackets, further marking material see "Accessories"	

ASK 1 LD

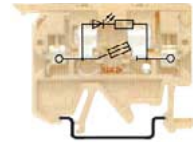

Warning:
In the event of a faulty fuse, the connection system is live!

UL		
8		
9		
0.5...4 mm ²		
0.5...4 mm ²		
AWG 22...12		
6.3 A		
24...230 V (depending on terminal)		
≤ 2 mA		
≤ 2 mA		
4 mm ²		
Type	Cat. No.	Qty.
ASK 1 LD	8050810000	25
ASK 1 LD	0222760000	25
ASK 1 LD	0225260000	25
ASK 1 LD	0226460000	25
ASK 1 LD	0225460000	25
ASK 1 LD	0225660000	25
ASK 1 LD	0222860000	25
ASK 1 LD	0225360000	25
ASK 1 LD	0226360000	25
ASK 1 LD	0225560000	25
ASK 1 LD	0225760000	25
Mountable on TS 32 and TS 35		
Accessories		
Mounting rail	TS 32 0122800000 TS 35x7.5 0383400000 TS 35x15 0498000000	
End brackets (thickness mm)	for TS 32 0206160000 50 for TS 35 0383560000 50	
End plate/End plate (thickness mm)	AP PA (1.5) 0380360000 20	
Cross-connections		
Type 'QL'		
Cross-connection	QB 2 ¹⁾ 0461100000 100	
Type 'QB'	QB 3 ¹⁾ 0461200000 50 QB 4 ¹⁾ 0461300000 50	
Fixing screw (fits QL)	straight angled	
Disconnect lever (spare)	TH (spare) 0377060000 100	
Mounting rails, end brackets, further marking material see "Accessories"		

KDKS 1

Fuse insert 5x20

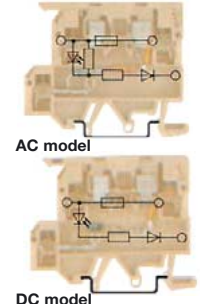

Warning:
In the event of a faulty fuse, the connection system is live!

UL		
8		
9		
0.5...4 mm ²		
0.5...4 mm ²		
AWG 22...12		
6.3 A		
24...230 V (depending on terminal)		
≤ 2 mA		
≤ 2 mA		
4 mm ²		
Type	Cat. No.	Qty.
KDKS 1	8146450000	25
KDKS 1	8148930000	25
KDKS 1	8148920000	25
KDKS 1	8142840000	25
KDKS 1	8148910000	25
Mountable on TS 32 and TS 35		
Accessories		
Mounting rail	TS 32 0122800000 TS 35x7.5 0383400000 TS 35x15 0498000000	
End brackets (thickness mm)	for TS 32 0206160000 50 for TS 35 0383560000 50	
End plate/End plate (thickness mm)	AP PA (1.5) 0380360000 20	
Cross-connections		
Type 'QL'		
Cross-connection	QB 2 ¹⁾ 0461100000 100	
Type 'QB'	QB 3 ¹⁾ 0461200000 50 QB 4 ¹⁾ 0461300000 50 QB 58 ¹⁾ 0545400000 QB 58 ¹⁾ 0545300000	
Fixing screw (fits QL)	straight angled	
Disconnect lever (spare)	TH (spare) 0377060000 100	
Mounting rails, end brackets, further marking material see "Accessories"		

SAK-series

¹⁾When using QB, the rated cross-current reduces to max. 2.5 mm²

Fuse terminals

with fault indicator

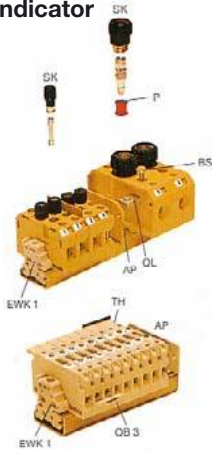

Dimensions/approvals	
Width/length/height (mm)	with TS 32
Width/length/height (mm)	with TS 35 x 7.5
Terminal width (+ 0.2 assembly tolerance)	mm
Insulation stripping length/clamping screw/screwdriver blade	
Connection data	
Screw connection, solid	
Screw connection, flexible	
Conductor cross-section	
Further technical data	
Tightening torque range	Nm
Torque setting with electric screwdriver type DMS 2	
VDE rated data	
Voltage/current	
LED-current (24...60 V)	
LED-current (115...230 V)	
Incandescent lamp-current	
Neon lamp-current	
Cross-section	

Ordering data		Voltage		Qty.	Qty.
Fuse insert					
5 x 20	LED	24 V~			
Acc. to IEC 60127-2 (VDE 0820 T.2 BI 1)					
without indicator					
		48 V~			
		48 V~			
	Incandescent lamp	24 V=			
		48 V=			
	Neon lamp	115 V=			
		230 V=			
Fuse insert					
5 x 25	LED	24 V~			
Acc. to DIN 41576					
without indicator					
	Incandescent lamp	48 V=			
	Neon lamp	115 V=			
		230 V=			

Accessories		Type	Cat. No.	Qty.
Mounting rail				
		TS 32	0122800000	
		TS 35x7.5	0383400000	
		TS 35x15	0498000000	
End brackets (thickness mm)	for TS 32	EWK 1 (8.5)	0206160000	50
	for TS 35	EW 35 (8.5)	0383560000	50
End plate (thickness mm)		AP KrG (3)	0191320000	20
Cross-connection				
Type 'QL'				
Cross-connection				
Type 'QB'				
Fixing screw (fits QL)				
Screw cap (spare)		SK (5 x 20)	0282100000	20
		SK (5 x 25)	0282000000	100
Neon lamp				

SAKS 1

Fuse insert 5x20/5x25

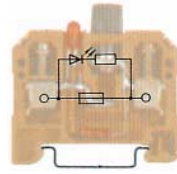

Warning:
In the event of a faulty fuse, the connection system is live!

Dimensions/approvals	
Width/length/height (mm)	
Terminal width (+ 0.2 assembly tolerance)	mm
Insulation stripping length/clamping screw/screwdriver blade	
Connection data	
Screw connection, solid	
Screw connection, flexible	
Conductor cross-section	
Further technical data	
Tightening torque range	Nm
Torque setting with electric screwdriver type DMS 2	
VDE rated data	
Voltage/current	
LED-current (24...60 V)	
LED-current (115...230 V)	
Incandescent lamp-current	
Neon lamp-current	
Cross-section	

Type	Cat. No.	Qty.
SAKS 1 LD		
	0371420000	10
	0225820000	10
1111220000		
	10 1111320000	10
	0214020000	10
SAKS 1 GL		
	0173220000	10
	0378920000	10
SAKS 1 GL		
	0385320000	10
	8068330000	10
	0306120000	10
	0199920000	10
SAK 1 LD		
	on demand	
SAKS GL		
	on demand	
SAKS 1 GL		
	0309320000	10
	0198620000	10

SAKS 4

Fuse insert E14/D 01
(e.g. Neozed D 01)

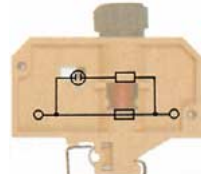

Warning:
In the event of a faulty fuse, the connection system is live!

Dimensions/approvals	
Width/length/height (mm)	
Terminal width (+ 0.2 assembly tolerance)	mm
Insulation stripping length/clamping screw/screwdriver blade	
Connection data	
Screw connection, solid	
Screw connection, flexible	
Conductor cross-section	
Further technical data	
Tightening torque range	Nm
Torque setting with electric screwdriver type DMS 2	
VDE rated data	
Voltage/current	
LED-current (24...60 V)	
LED-current (115...230 V)	
Incandescent lamp-current	
Neon lamp-current	
Cross-section	

Type	Cat. No.	Qty.
SAKS 4		
TS 32 Neon lamp		
Voltage		
115 V=	0101820000	10
480 V=	0102120000	10

SAKS 6

Fuse insert 11/4" x 1/4"
acc. to DEF 63

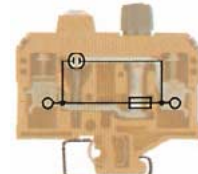

Warning:
In the event of a faulty fuse, the connection system is live!

Dimensions/approvals	
Width/length/height (mm)	
Terminal width (+ 0.2 assembly tolerance)	mm
Insulation stripping length/clamping screw/screwdriver blade	
Connection data	
Screw connection, solid	
Screw connection, flexible	
Conductor cross-section	
Further technical data	
Tightening torque range	Nm
Torque setting with electric screwdriver type DMS 2	
VDE rated data	
Voltage/current	
LED-current (24...60 V)	
LED-current (115...230 V)	
Incandescent lamp-current	
Neon lamp-current	
Cross-section	

Type	Cat. No.	Qty.
SAKS 6 KrG		
	0531820000	40
for 1 1/4" x 1/4" acc. to DEF 63		
exchangable neon lamps (please order separately)		

SAKS 7

Fuse insert 5x20/5x25

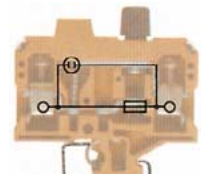

Warning:
In the event of a faulty fuse, the connection system is live!

Dimensions/approvals	
Width/length/height (mm)	
Terminal width (+ 0.2 assembly tolerance)	mm
Insulation stripping length/clamping screw/screwdriver blade	
Connection data	
Screw connection, solid	
Screw connection, flexible	
Conductor cross-section	
Further technical data	
Tightening torque range	Nm
Torque setting with electric screwdriver type DMS 2	
VDE rated data	
Voltage/current	
LED-current (24...60 V)	
LED-current (115...230 V)	
Incandescent lamp-current	
Neon lamp-current	
Cross-section	

Type	Cat. No.	Qty.
SAKS 7 KrG		
	0576120000	40
for 5 x 25		
SAKS 7 KrG		
	0573120000	40
for 5 x 20		
exchangable neon lamps (please order separately)		

Fuse inserts and gauge rings for Weidmüller fuse terminals



Fuse inserts

for terminal type	Size (mm)	Rated voltage (V)	Rated current (A)	Type	Cat. No.	Qty.			
G fuse inserts 5 x 20 without indicator acc. to IEC 60127-2 (VDE 0820 T.2 Bl 1)									
SAKS 1	5 x 20 Breaking capacity 1500 A (at 250 V, 50 Hz, cos φ = 0.7)	250	0.1 (F)	G 20/0.10A/F	0430300000	10			
SAKS 7			0.2 (F)	G 20/0.20A/F	0430400000	10			
ASK 1			0.25 (F)	G 20/0.25A/F	0430500000	10			
WSI 6 			0.5 (F)	G 20/0.50A/F	0430600000	10			
			0.63 (F)	G 20/0.63A/F	0430900000	10			
			1.0 (F)	G 20/1.00A/F	0430700000	10			
			1.6 (F)	G 20/1.60A/F	0430800000	10			
			2.0 (F)	G 20/2.00A/F	0430900000	10			
			2.5 (F)	G 20/2.50A/F	0431000000	10			
			3.15 (F)	G 20/3.15A/F	0431100000	10			
			4.0 (F)	G 20/4.00A/F	0431200000	10			
			5.0 (F)	G 20/5.00A/F	0431300000	10			
			6.3 (F)	G 20/6.30A/F	0431400000	10			
G fuse inserts 5 x 25 with indicator acc. to DIN 41576¹⁾									
SAKS 1	5 x 25 m. K.1) Breaking capacity 80 A (at 250 V, 50 Hz, cos φ = 1)	250	0.25 (M)	G 25/0.25A/M	0546900000	10			
SAKS 7			0.5 (M)	G 25/0.50A/M	0510300000	10			
WSI 6 			0.8 (M)	G 25/0.80A/M	0646400000	10			
			1 (M)	G 25/1.00A/M	0265800000	10			
			10 (M) ⁵⁾	G 25/10.0A/M	0193100000	10			
			2 (F)	G 25/2.00A/F	0192700000	10			
			4 (F)	G 25/4.00A/F	0192800000	10			
			6.3 (F)	G 25/6.30A/F	0192900000	10			
			Fuse inserts 1 1/4" x 1/4" without indicator acc. to BS 88						
			SAKS 3 ²⁾	33 kA Breaking capacity 33 kA fast	440	E 0.5 A	GZ 0.5A/F	0533800000	10
SAKS 6 	E 1 A	GZ 1.0A/F	0525500000			10			
	E 2 A	GZ 2.0A	0294500000			10			
	E 3 A	GZ 3.0A	0295700000			10			
	E 5 A	GZ 5.0A	0294600000			10			
	E 7 A	GZ 7.0A	0295800000			10			
	E 10 A	GZ 10.0A	0293900000			10			
D fuse inserts E 16 with indicator acc. to DIN 49360 (diazed)									
SAKS 2 	E 10 A E 16 A E 20 A E 25 A	500	10	E 16/10A RT	0208500000	25			
			16	E 16/16A GR	0208600000	25			
			20	E 16/20A BL	0208700000	25			
			25	E 16/25A GE	0208800000	25			
D fuse inserts E 14 Size D 01 and E 18 size D 02 with indicator acc. to DIN 49522 (neozed)³⁾									
SAKS 4 ⁴⁾ 	E 14/2 E 14/4 E 14/6 E 14/10 E 14/16 E 18/20	400	2	E 14/2A RS	0137400000	10			
			4	E 14/4A BR	0137500000	10			
			6	E 14/6A GN	0328300000	10			
			10	E 14/10A RT	0328400000	10			
			16	E 14/16A GR	0328500000	10			
			20	E 18/20A BL	0361300000	10			
SAKS 5 	E 18/25 E 18/35 E 18/50 E 18/63	400	25	E 18/25A GE	0361400000	10			
			35	E 18/35A SW	0361500000	10			
			50	E 18/50A WS	0361600000	10			
			63	E 18/63A KU	0361700000	10			

(F) = fast
(M) = medium-delayed action

- Note:**
- 1) The SIBA company also supplies 5 x 25 G fuse inserts with indicators in a shipbuilding model for 450 V AC.
 - 2) 5 x 30 (500 V AC) fuse inserts for SAKS 3 are available from the WICKMANN company
 - 3) The LINDNER company also supplies neozed fuse cartridges in an additional shipbuilding mode for 440 V AC.
 - 4) Fuse cartridges with the dimensions 1"x1/4" ≅ 25.4x6.35 mm and 13/32"x1 1/8" ≅ 10.3x38.1 mm are not included in product line.
 - 5) Only for SAKS 1 and SAKS 7.

Gauge rings

For terminal type	Gauge ring type	Amp.	Colour	Type	Cat. No.	Qty.
SAKS 4 and 4/35 	P 14/2	2	Pink	P 14/2D01 RS	0138000000	50
	P 14/4	4	Brown	P 14/4D01 BR	0138100000	50
	P 14/6	6	Green	P 14/6D01 GN	0328600000	50
	P 14/1	10	Red	P 14/10D01 RT	0328700000	50
SAKS 5 and 5/35 	P 18/20	20	Blue	P 18/20D02 BL	0361800000	50
	P 18/25	25	Yellow	P 18/25D02 GE	0361900000	50
	P 18/35	35	Black	P 18/35D02 SW	0362000000	50
	P 18/50	50	White	P 18/50D02 WS	0362100000	50
SAKS 2 and 2/35 	P 16/10	10	Red	P 16/10 RT	0208900000	100
	P 16/16	16	Grey	P 16/16 GR	0209000000	100
	P 16/20	20	Blue	P 16/20 BL	0209100000	100

Disconnect test terminals

SAKR SAKR/35



UL	6.5/42/40.5/54.5 (opened)
6.5/46/38/52	8 mm/M 3/3.5 x 0.6

SAKR-D SAKR-D/35

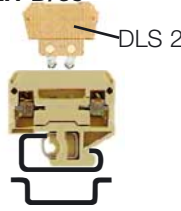

6.5/42/40.5/57 (with DLS 2)	8 mm/M 3/3.5 x 0.6
-----------------------------	--------------------

DKT 4 DKT 4/35

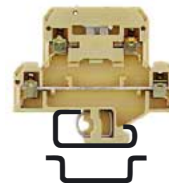

6/65/56.5/70 (opened)	9 mm/M 3/3.5 x 0.6
-----------------------	--------------------

DKT 4 V DKT 4 V/35

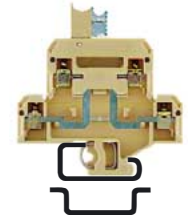

6/65/56.5/70 (opened)	9 mm/M 3/3.5 x 0.6
-----------------------	--------------------

Dimensions/approvals

Width/length/height (mm)	with TS 32	6.5/42/40.5/54.5 (opened)
Width/length/height (mm)	with TS 35 x 7.5	6.5/46/38/52
Insulation stripping length/clamping screw/screwdriver blade		8 mm/M 3/3.5 x 0.6

Rated data

Rated voltage/current/cross-section	400 V ⁶⁾ /10 A/4 mm ²
Rated impulse voltage/pollution severity	6 kV/3

Further technical data

Tightening torque range	Nm	0.5...1.0/0.5 StB
Torque setting with electric screwdriver type DMS 2		2/1

Clampable conductor

Solid H07V-U	mm ²	0.5...4
Stranded H07V-R	mm ²	1.5...4
Flexible H07V-K	mm ²	0.5...4
Flexible H07V-K and ferrule according to DIN 46 228/1	mm ²	0.5...4
With/without plastic insulating collar	mm ²	0.5...4
Plug gauge according to 60 947-7-1	Size	A 3
Continuous current rating of cross-connection 2...5-pole	A	(QB 2...25) 10
Continuous current rating of cross-connection 6...10-pole	A	(QB 2...25) 10

Rated data according to UL/CSA

Voltage/current/conductor size	UL	300 V/10 A/26...12 AWG
Voltage/current/conductor size	CSA	300 V/10 A/26...12 AWG

Ordering data

Type	Qty.	Qty.
KrG	0412120000	100
PA	0412160000	100
Without diode PA	0172160000	100
With diode PA		
Blue PA	0412180000	100
Orange PA	1461960000	100
KrG	0412220000	100
PA	0412260000	100
without diode PA	0183360000	100
Blue	0412280000	100
0183380000	100	

Type	Qty.	Qty.
0412960000 ¹⁾	100	0299960000 ²⁾
0413060000 ³⁾	50	0185760000 ³⁾
0263660000 ³⁾	50	0299560000 ³⁾
0546460000 ¹⁾	100	
0413160000 ²⁾	50	

Type	Qty.	Qty.
0687360000	50	0687460000
0327860000	50	0327960000

Type	Qty.	Qty.
300 V/10 A/22...12 AWG	300 V/10 A/26...12 AWG	
300 V/10 A/26...12 AWG	300 V/10 A/26...12 AWG	
1304860000	50	1304960000

End plate (thickness mm)

Type	Cat. No.	Qty.
KrG	AP (1.5)	0211320000
PA	AP (1.5)	0211360000
Blue PA	AP (1.5)	0211380000

Type	Cat. No.	Qty.
AP (1.5)	0211360000	20

Type	Cat. No.	Qty.
AP (1.5)	0687560000	20

Type	Cat. No.	Qty.
AP (1.5)	0687560000	20

Partition (thickness mm)

Type	Cat. No.	Qty.
TW HP (1.0)	0297100000	20

Type	Cat. No.	Qty.
TW HP (1.0)	0297100000	20

Type	Cat. No.	Qty.
TW HP (2.0)	0607000000	20

Type	Cat. No.	Qty.
TW HP (2.0)	0607000000	20

Cross-connection

QB 4	Type	Cat. No.	Qty.
2-pole	QB 2 ⁴⁾	0482700000	100
3-pole	QB 3 ⁴⁾	0482800000	50
4-pole	QB 4 ⁴⁾	0482900000	50
25-pole	QB 25 blank ⁴⁾	0134000000	20

QB 4	Type	Cat. No.	Qty.
2-pole	QB 2 ⁴⁾	0482700000	100
3-pole	QB 3 ⁴⁾	0482800000	50
4-pole	QB 4 ⁴⁾	0482900000	50
25-pole	QB 25 blank ⁴⁾	0134000000	20

QB 4	Type	Cat. No.	Qty.
2-pole	QB 2 ⁴⁾	0482700000	100
3-pole	QB 3 ⁴⁾	0482800000	50
4-pole	QB 4 ⁴⁾	0482900000	50

QB 4	Type	Cat. No.	Qty.
2-pole	QB 2 ⁴⁾	0482700000	100
3-pole	QB 3 ⁴⁾	0482800000	50
4-pole	QB 4 ⁴⁾	0482900000	50

Contact sleeve (spare)



Test plug



Type	Cat. No.	Qty.
PS 2.3	0180400000	20
without diode		
with diode 1N4007	DLS 2	0321060000
with diode 1N4007	DLS 2 + \rightarrow	0630160000
with diode 1N4007	DLS 2 - \leftarrow	0547760000
with jumper	DLS 2	0547660000

Type	Cat. No.	Qty.
PS 2.3	0180400000	20
DLS 2	0321060000	50
DLS 2 + \rightarrow	0630160000	50
DLS 2 - \leftarrow	0547760000	50
DLS 2	0547660000	25

Type	Cat. No.	Qty.
PS 2.3	0180400000	20

Type	Cat. No.	Qty.
PS 2.3	0180400000	20

Marking tags

Print	DEK	Standard	DEK 6.5	see "Accessories"
1 2 3 4 5 6	DEK	Standard	DEK 6.5	see "Accessories"

Print	DEK	Standard	DEK 6.5	see "Accessories"
1 2 3 4 5 6	DEK	Standard	DEK 6.5	see "Accessories"

Print	DEK	Standard	DEK 6	see "Accessories"
1 2 3 4 5 6	DEK	Standard	DEK 6	see "Accessories"

Print	DEK	Standard	DEK 6	see "Accessories"
1 2 3 4 5 6	DEK	Standard	DEK 6	see "Accessories"

Mounting rails, end brackets, further marking material see "Accessories"

¹⁾ without DLS
²⁾ with DLS empty

³⁾ with DLS 1N4007
⁴⁾ When using QB the rated cross-current reduces to max. 2.5 mm²

⁵⁾ With DKT 4 only on upper terminal level
⁶⁾ As disconnect test terminal rated voltage 250 V

Disconnect test terminals

ASK 1 ASK 1/35

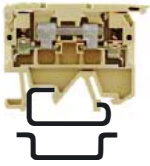

RU @

8/58/49

8/58/44

9 mm/M 3/3.5 x 0.6

500 V/19 A/4 mm²

6 kV/3

0.5...1.0

2

0.5...4

1.5...4

0.5...4

0.5...4

A 3

(QB 2...4) 10

300 V/15 A/12 max. AWG

300 V/6.3 A/26...12 AWG

Qty.

0456360000 100

0105260000 100

Type	Cat. No.	Qty.
------	----------	------

AP (1.5)	0380360000	20
----------	-------------------	----

TW HP (2.0)	0607000000	20
-------------	-------------------	----

QB 2 ⁴)	0461100000	100
---------------------	-------------------	-----

QB 3 ⁴)	0461200000	50
---------------------	-------------------	----

QB 4 ⁴)	0461300000	50
---------------------	-------------------	----

multipole interruptable with group marking carrier SchS 2; 2-pole (Cat. No. **1359500000**) 1000 mm (Cat. No. **0337400000**)

K sleeve	0553300000	100
----------	-------------------	-----

DEK 5 FW	see "Accessories"	
----------	-------------------	--

Feed-through terminals with tab connection

AST 1 AST1/35

6.3
2.8

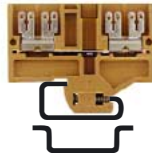

UL @ DNV

AST 3 AST 3/35

6.3
2.8



UL @ DNV

AST 4 AST 4/35

6.3
2.8



UL @

AST 5 AST 5/35

6.3
2.8



UL @ DNV

Dimensions/approvals

Width/length/height (mm)	with TS 32	6.5/58/53.5
Width/length/height (mm)	with TS 35 x 7.5	6.5/58/46
Insulation stripping length/clamping screw/screwdriver blade		

Rated data

Rated voltage/-current	500 V ¹⁾ /-
Rated cross-section for clamping yokes	-
Rated cross-section tab	6.3/2.8 mm
Rated Voltage VDE 0110/1.89/pollution severity	6 kV/3

Further technical data

Tightening torque range	Nm
Torque setting with electric screwdriver type DMS 2	

Clampable conductor

Solid H07V-U	mm ²
Stranded H07V-R	mm ²
Flexible H07V-K	mm ²
Flexible H07V-K and ferrule according to DIN 46 228/1	mm ²
Plug gauge according to 60 947-7-1	Size

Continuous current of terminal for conductor size	
Continuous current rating of cross-connection 2...5-pole	A
Continuous current rating of cross-connection 6...10-pole	A

Rated data according to UL/CSA

Voltage/current/conductor size	UL
Voltage/current/conductor size	CSA

Ordering data

Version	Qty.	Qty.
Slotted KrG	0478220000	50
Slotted blue KrG		
Slotted PA	0478260000 ²⁾ 50	0699660000 ²⁾ 50
Unslotted KrG	0266320000	50
Unslotted blue KrG		
Unslotted PA	0266360000 ²⁾ 50	0664860000 ²⁾ 50

UL @ DNV	6.5/40/47.5
UL @ DNV	6.5/44/40
UL @	6.5/40/47.5
UL @	6.5/44/40
UL @	9 mm/M 2.5/3.5 x 0.6
UL @ DNV	6.5/58/53.5
UL @ DNV	6.5/58/46
UL @ DNV	12 mm/M 3/3.5 x 0.6

UL @ DNV	500 V ¹⁾ /-
UL @ DNV	-
UL @ DNV	2.5/1.0 mm ²
UL @ DNV	6 kV/3

UL @	500 V ¹⁾ /-
UL @	2.5 mm ²
UL @	2.5/1.0 mm ²
UL @	6 kV/3
UL @	0.4...0.7
UL @	1
UL @	0.5...4
UL @	1.5...2.5
UL @	0.5...2.5
UL @	0.5...2.5
UL @	A 3
UL @	(QL 2...10) 20

UL @ DNV	500 V ¹⁾ /-
UL @ DNV	4 mm ²
UL @ DNV	2.5/1.0 mm ²
UL @ DNV	6 kV/3
UL @ DNV	0.5...1.0
UL @ DNV	2
UL @ DNV	0.5...6
UL @ DNV	1.5...4
UL @ DNV	0.5...4
UL @ DNV	0.5...4
UL @ DNV	A 4
UL @ DNV	(QL 2...10) 20

End plate/partition/small partition (thickness mm)

Type	Cat. No.	Qty.
AP (3.0)	0266420000	20
AP (1.5)	0266460000	20
PA		
PA		
HP	TW (0.5)	0474700000
HP	TW (2.0)	0607000000
HP	TSch 1	0319160000



Type	Cat. No.	Qty.
AP (3.0)	0298120000	20
AP (1.5)	0460560000	20
TW (1.5)	0130160000	20
TW (1.0)	0297100000	20
TSch 1	0319160000	100

Type	Cat. No.	Qty.
AP (3.0)	0298120000	20
AP (1.5)	0460560000	20
TW (1.5)	0130160000	20
TW (1.0)	0297100000	20
TSch 1	0319160000	100

Type	Cat. No.	Qty.
AP (3.0)	0298120000	20
AP (1.5)	0460560000	20
TW (1.5)	0130160000	20
TW (1.0)	0297100000	20
TSch 1	0319160000	100

Type	Cat. No.	Qty.
AP (3.0)	0266420000	20
AP (1.5)	0266460000	20
TW (1.0)	0474700000	20
TW (2.0)	0607000000	20
TSch 1	0319160000	100

Cross-connection

Q4	2-pole	Q 2	0336700000	50
	3-pole	Q 3	0336800000	50
	4-pole	Q 4	0336900000	50
	10-pole	Q 10	0368800000	20
	25-pole			



Q 2	0336700000	50
Q 3	0336800000	50
Q 4	0336900000	50
Q 10	0368800000	20

Q 2	0336700000	50
Q 3	0336800000	50
Q 4	0336900000	50
Q 10	0368800000	20

Q 2	0336700000	50
Q 3	0336800000	50
Q 4	0336900000	50
Q 10	0368800000	20

Q 2	0336700000	50
Q 3	0336800000	50
Q 4	0336900000	50
Q 10	0368800000	20

Plug adapter

2-pole	STA 2.5/2	0165860000	100
3-pole	STA 2.5/3	0165960000	50
4-pole	STA 2.5/4	0190360000	50
5-pole	STA 2.5/5	0166060000	50
8-pole	STA 2.5/8	0166160000	50



Clips into PA version of AST3 and AST4 only

STA 2.5/2	0165860000	100
STA 2.5/3	0165960000	50
STA 2.5/4	0190360000	50
STA 2.5/5	0166060000	50
STA 2.5/8	0166160000	50

STA 2.5/2	0165860000	100
STA 2.5/3	0165960000	50
STA 2.5/4	0190360000	50
STA 2.5/5	0166060000	50
STA 2.5/8	0166160000	50

STA 2.5/2	0165860000	100
STA 2.5/3	0165960000	50
STA 2.5/4	0190360000	50
STA 2.5/5	0166060000	50
STA 2.5/8	0166160000	50

STA 2.5/2	0165860000	100
STA 2.5/3	0165960000	50
STA 2.5/4	0190360000	50
STA 2.5/5	0166060000	50
STA 2.5/8	0166160000	50

Test plug/socket

Plug-test socket without using QL for TS 32	StB 14	0168600000	50
PS	PS 2.3	0180400000	20
StB			



StB 14	0168600000	50
PS 2.3	0180400000	20

StB 14	0168600000	50
PS 2.3	0180400000	20

StB 14	0168600000	50
PS 2.3	0180400000	20

StB 14	0168600000	50
PS 2.3	0180400000	20

Insulation sleeve

IH 2.8	0386060000	100
IH 6.3	0386260000	100



IH 2.8	0386060000	100
IH 6.3	0386260000	100

IH 2.8	0386060000	100
IH 6.3	0386260000	100

IH 2.8	0386060000	100
IH 6.3	0386260000	100

IH 2.8	0386060000	100
IH 6.3	0386260000	100

Marking tags

1	2	3	4	5	6	DEK	Standard
---	---	---	---	---	---	-----	----------

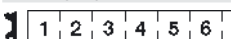

DEK 6.5	see "Accessories"
---------	-------------------

DEK 6	see "Accessories"
-------	-------------------

DEK 6	see "Accessories"
-------	-------------------

DEK 6.5	see "Accessories"
---------	-------------------

Mounting rails, end brackets, further marking material see "Accessories"

¹⁾ with insulation sleeve
²⁾ shock proof with ADP 4 cover profiles ADP4 (see section "Accessories")

Feed-through terminals with tab connection

SAK 4 S SAK 4 S/35

6.3
2.8



6.5/40/51.5
6.5/40/49.5
12 mm/M 3/3.5 x 0.6

SAK 4 SS SAK 4 SS/35

6.3
2.8



6.5/40/51.5
6.5/40/49.5

SAKR F SAKR F/35

2.8



6.5/42/40.5/54.5 (opened)
6.5/42/40.5/32.5
8 mm/M 3/3.5 x 0.6

Dimensions/approvals

Width/length/height (mm) with TS 32 6.5/40/51.5
Width/length/height (mm) with TS 35 x 7.5 6.5/40/49.5
Insulation stripping length/clamping screw/screwdriver blade 12 mm/M 3/3.5 x 0.6

Rated data

Rated voltage/-current 500 V¹⁾/16 A
Rated cross-section for clamping yokes 4 mm²
Rated cross-section tab 6.3/2.8 mm 2.5/1.0 mm²
Rated Voltage VDE 0110/1.89/pollution severity 6 kV/3

Further technical data

Tightening torque range Nm 0.5...1.0
Torque setting with electric screwdriver type DMS 2 2

Clampable conductor

Solid H07V-U mm² 0.33...6
Stranded H07V-R mm² 1.5...4
Flexible H07V-K mm² 0.5...4
Flexible H07V-K and ferrule according to DIN 46 228/1 mm² 0.5...4
Plug gauge according to 60 947-7-1 Size A 4
Continuous current of terminal for conductor size
Continuous current rating of cross-connection 2 pole A (QL 2...10) 36 A at 6 mm²
Continuous current rating of cross-connection multipole A (QL 2...10) 36 A at 6 mm²

Rated data according to UL/CSA

Voltage/current/conductor size UL 300 V/13 A/26...12 AWG
Voltage/current/conductor size CSA 300 V/13 A/26...12 AWG

Ordering data

Version
Slotted KrG
Slotted blue KrG
Slotted PA
Unslotted KrG

Qty. Qty.
0401220000 100
0401260000 100 **0630360000** 100

Qty. Qty.
0479620000 10
0479660000 100 **0630460000** 100
0352920000 10

Qty. Qty.
0663660000 100 **6382870000** 100
with 1 StB 6

End plate/partition/small partition (thickness mm)

AP KrG
TW Blue KrG
TSch 1 PA
HP PA



Type Cat. No. Qty.
AP (1.5) **0117920000** 20
AP (1.5) **0117960000** 20
AP (1.5) **0130160000** 20
TW (1.0) **0297100000** 20

Type Cat. No. Qty.
AP (1.5) **0117920000** 20
AP (1.5) **0117970000** 20
AP (1.5) **0117960000** 20
TW (1.5) **0130160000** 20
TW (1.0) **0297100000** 20

Type Cat. No. Qty.
AP (1.5) **0211360000** 20
TW (1.0) **0297100000** 20

Cross-connection

QL 2-pole
3-pole
4-pole
10-pole
25-pole



QL 2 **0130600000** 100
QL 3 **0130700000** 100
QL 4 **0130800000** 50
QL 10 **0338200000** 20

QL 2 **0130600000** 100
QL 3 **0130700000** 100
QL 4 **0130800000** 50
QL 10 **0338200000** 20

QB 2* **0482700000** 100
QB 3* **0482800000** 50
QB 4* **0482900000** 50

BS M 3 x 4.5



BS M 3 x 24



BS M 3x4.5 **1593210000** 100

BS M 3x4.5 **1593210000** 100

Test plug/socket



PS

PS 2.3 **0180400000** 20

Insulation sleeve



IH 2.8 **0386060000** 100
IH 6.3 **0386260000** 100

IH 2.8 **0386060000** 100
IH 6.3 **0386260000** 100

IH 2.8 **0386060000** 200

Marking tags

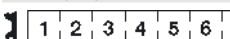

DEK Standard

DEK 6.5 see "Accessories"

DEK 6.5 see "Accessories"

DEK 6.5 see "Accessories"

Mounting rails, end brackets, further marking material see "Accessories"

1) With insulation sleeve

*The conductor cross-section for the screw connection is reduced to 2.5 mm² when QB is used

Feed-through terminals with tab connection

DK 4 SS/35



DK 4 SS/35 only 2.8



DK 4 S DK 4 S/35

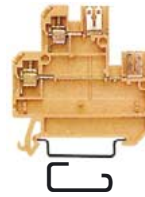

DK 4 S only 2.8 DK 4 S/35 only 2.8



Dimensions/approvals

Width/length/height (mm)	with TS 32	
Width/length/height (mm)	with TS 35 x 7.5	
Insulation stripping length/clamping screw/screwdriver blade		

Rated data

Rated voltage/-current	400 V ¹ /2 x 16 A
Rated cross-section for clamping yokes	-
Rated cross-section tab	6.3/2.8 mm
Rated Voltage VDE 0110/1.89/pollution severity	8 kV/3

Further technical data

Tightening torque range	Nm
Torque setting with electric screwdriver type DMS 2	

Clampable conductor

Solid H07V-U	mm ²
Stranded H07V-R	mm ²
Flexible H07V-K	mm ²
Flexible H07V-K and ferrule according to DIN 46 228/1	mm ²
With/without plastic insulation collar	
Plug gauge according to 60 947-7-1	Size
Continuous current of terminal for conductor size	
Continuous current rating of cross-connection 2 pole	A
Continuous current rating of cross-connection multipole	A

Rated data according to UL/CSA

Voltage/current/conductor size	UL	300 V/10 A/22...12 AWG
Voltage/current/conductor size	CSA	300 V/10 A/22...12 AWG

Ordering data

Version	PA
---------	----

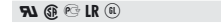

6/54/60.5



6/54/60.5

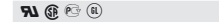

6/54/59.5
6/54/60.5
9 mm/M 3/3.5 x 0.6

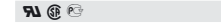

6/54/59.5
6/54/60.5
9 mm/M 3/3.5 x 0.6

End plate (thickness mm)



PA

Type	Cat. No.	Qty.
AP (1.5)	0631360000	20

Type	Cat. No.	Qty.
AP (1.5)	0631360000	20

Type	Cat. No.	Qty.
AP (1.5)	0631360000	20

Type	Cat. No.	Qty.
AP (1.5)	0631360000	20

Partition



for TS 32 HP

Type	Cat. No.	Qty.
TW HP (2.0)	0607000000	20

Type	Cat. No.	Qty.
TW HP (2.0)	0607000000	20

Type	Cat. No.	Qty.
TW HP (2.0)	0607000000	20

Type	Cat. No.	Qty.
TW HP (2.0)	0607000000	20

Small partition



TSch 6

Type	Cat. No.	Qty.
TSch 6	0190260000	100

Type	Cat. No.	Qty.
TSch 6	0190260000	100

Type	Cat. No.	Qty.
TSch 6	0190260000	100

Type	Cat. No.	Qty.
TSch 6	0190260000	100

Cross-connection



Q 3

2-pole	Q 2	0336400000	50
3-pole	Q 3	0336500000	50
4-pole	Q 4	0336600000	50
10-pole	Q 10	0368600000	20

2-pole	Q 2	0336400000	50
3-pole	Q 3	0336500000	50
4-pole	Q 4	0336600000	50
10-pole	Q 10	0368600000	20

2-pole	Q 2	0336400000	50
3-pole	Q 3	0336500000	50
4-pole	Q 4	0336600000	50
10-pole	Q 10	0368600000	20

2-pole	Q 2	0336400000	50
3-pole	Q 3	0336500000	50
4-pole	Q 4	0336600000	50
10-pole	Q 10	0368600000	20

Test plug/socket



StB

Plug test socket without using QL
Plug test socket for use with QL

StB 8.5	0215700000	50
---------	-------------------	----

StB 8.5	0215700000	50
---------	-------------------	----

StB 8.5	0215700000	50
---------	-------------------	----

StB 8.5	0215700000	50
---------	-------------------	----

Insulation sleeve

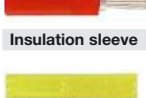

PS

PS 2.3	0180400000	20
IH 2.8	0386060000	100
IH 6.3	0386260000	100

PS 2.3	0180400000	20
IH 2.8	0386060000	100
IH 6.3	0386260000	100

PS 2.3	0180400000	20
IH 2.8	0386060000	100
IH 6.3	0386260000	100

PS 2.3	0180400000	20
IH 2.8	0386060000	100
IH 6.3	0386260000	100

Marking tags

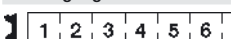

DEK

Print

Standard

DEK 6	see "Accessories"
-------	-------------------

DEK 6	see "Accessories"
-------	-------------------

DEK 6	see "Accessories"
-------	-------------------

DEK 6	see "Accessories"
-------	-------------------

Mounting rails, end brackets, further marking material see "Accessories"

¹) With insulation sleeve

Feed-through terminals for wrap termination

DIN 41 611, Part 2 and
for spring-clip termination
DIN 41 611, Part 4

SAK 2.5 T

Pin 1 x 1



SAK 2.5 T

Pin 0.8 x 1.6



SAK 2.5 T

Pin 0.8 x 2.4



Dimensions/approvals		☉	☉	☉
Width/length/height (mm)	with TS 32	6/36.5/47.5/67	6/36.5/47.5/62	6/36.5/47.5/69
Insulation stripping length/clamping screw/screwdriver blade		12 mm/M 2.5/3.5 x 0.6	12 mm/M 2.5/3.5 x 0.6	12 mm/M 2.5/3.5 x 0.6
Rated data				
Rated voltage/current/cross-section		250 V/8 A/2.5 mm ²	250 V/10 A/2.5 mm ²	250 V/10 A/2.5 mm ²
Rated impulse voltage VDE 0110/1.89/pollution severity		4 kV/3	4 kV/3	4 kV/3
Further technical data				
Tightening torque range	Nm	0.4...0.7	0.4...0.7	0.4...0.7
Torque setting with electric screwdriver type DMS 2		1	1	1
Clampable conductor				
Solid H07V-U	mm ²	0.5...6	0.5...6	0.5...6
Stranded H07V-R	mm ²	0.5...2.5	0.5...2.5	0.5...2.5
Flexible H07V-K	mm ²	0.5...4	0.5...4	0.5...4
Flexible H07V-K and ferrule according to DIN 46 228/1	mm ²	0.5...2.5	0.5...2.5	0.5...2.5
Plug gauge according to IEC 60 947-1	Size	A 3	A 3	A 3
Continuous current of terminal for conductor size				
Continuous current rating of cross-connection 2-pole	A	(Q 2...10) 24	(Q 2...10) 24	(Q 2...10) 24
Continuous current rating of cross-connection multipole	A			
Rated data according to UL/CSA				
Voltage/current/conductor size	UL			
Voltage/current/conductor size	CSA	300 V/10 A/22...12 AWG	300 V/10 A/22...12 AWG	300 V/10 A/22...12 AWG
Ordering data		Pin	Version	
 Horizontal assembly	 Vertical assembly	Right	KrG	0108520000 100
		Horizontal right	KrG	0485920000 100
		Vertical left	KrG	0478820000 100
		Vertical right	KrG	0371020000 100
		2x vertical	KrG	0485020000 100
		Right	PA	0108560000 ¹⁾ 100
End plate (thickness mm)		Type	Cat. No.	Qty.
	KrG	AP (1.5)	0279520000	20
	PA	AP (1.5)	0279560000	20
	KrG	TW (2.5)	0302820000	20
	PA	TW (1.5)	0302860000	20
	HP	TW (0.5)	0197100000	20
	HP	TW (2.0)	0607000000	20
Small partition		TSch 1	0319160000	100
Cross-connection				
	2-pole	Q 2	0337000000	50
	3-pole	Q 3	0337100000	50
	4-pole	Q 4	0337200000	50
	10-pole	Q 10	0368700000	20
Test plug/socket				
	Plug-test socket without using QL	StB 8.5 (ø 2.3)	0280600000	50
	PS	PS 2.3	0180400000	20
	StB	PS 2.3	0180400000	20
Marking tags				
	DEK	DEK 6	see "Accessories"	
	Print	DEK 6	see "Accessories"	
Mounting rails, end brackets, further marking material see "Accessories"				

¹⁾ Shock-proof with ADP4 cover profile (see section "Accessories")

** Not for Type 2 x vertical"

Feed-through terminals

Disconnect terminals for wrap connection acc. to DIN 41 611, Part 2 and for spring-clip connection acc. to DIN 41 611, Part 4

DK 4 T
Pin 1 x 1



DK 4 T
Pin 0.8 x 1.6



DK 4 T
Pin 0.8 x 2.4



SAKRT
Pin 1 x 1/0.8 x 2.4 and 0.8 x 1.6



Dimensions

Width/length/height (mm) with TS 32
Insulation stripping length/clamping screw/screwdriver blade

6/50/58.5/75.5
9 mm/M 3/3.5 x 0.6

6/50/60.5/77.5
9 mm/M 3/3.5 x 0.6

6/50/67.5/84.5
9 mm/M 3/3.5 x 0.6

6/42/40.5/54.5
8 mm/M 3/3.5 x 0.6

Rated data

Rated voltage/current/cross-section
Rated impulse voltage VDE 0110/1.89/pollution severity

250 V/8 A/4 mm²
4 kV/3

250 V/10 A/4 mm²
4 kV/3

250 V/10 A/4 mm²
4 kV/3

250 V/6/8 A/4 mm²
4 kV/3

Further technical data

Tightening torque range Nm
Torque setting with electric screwdriver type DMS 2

0.5...1.0
1

0.5...1.0
1

0.5...1.0
1

0.5...1.0
2

Clampable conductor

Solid H07V-U mm²
Stranded H07V-R mm²
Flexible H07V-K mm²
Flexible H07V-K and ferrule according to DIN 46 228/1
With/without plastic insulating collar mm²
Plug gauge according to IEC 60 947-1 Size

0.5...4
1.5...4
0.5...4
0.5...4
A3

0.5...4
1.5...4
0.5...4
0.5...4
A3

0.5...4
1.5...4
0.5...4
0.5...4
A3

0.5...4
1.5...4
0.5...4
0.5...4
A3

Continuous current of terminal block for conductor size
Continuous current rating of cross-connection 2-pole
Continuous current rating of cross-connection multipole

(Q 2...10) 32
(Q 2...10) 32

(Q 2...10) 32
(Q 2...10) 32

(Q 2...10) 32
(Q 2...10) 32

(QB 2...10) 10
(QB 2...10) 10

Rated data according to UL/CSA

Voltage/current/conductor size UL
Voltage/current/conductor size CSA

—
—

—
—

—
—

—
—

Ordering data

Pin	Type	Cat. No.	Qty.
Right	PA	0536560000	50
Links	PA		
Horizontal right	PA		
Horizontal assembly	Vertical right		
Vertical assembly	Vertical right		
	Vertical		
	Vertical right		
	Vertical left		

Type	Cat. No.	Qty.
Right	0536560000	50
Links		
Horizontal right		
Horizontal assembly		
Vertical assembly		

Type	Cat. No.	Qty.
Right		
Links		
Horizontal right	0370460000 ¹⁾	50
Horizontal assembly		
Vertical assembly		

Type	Cat. No.	Qty.
Right		
Links		
Horizontal right		
Horizontal assembly		
Vertical assembly		

Type	Cat. No.	Qty.
Right		
Links		
Horizontal right		
Horizontal assembly		
Vertical assembly		

DK 4 QT

bridgeable on both levels Right PA

1398460000¹⁾ 50

End plate/partition (thickness mm)

Type	Cat. No.	Qty.
PA	AP (1.5) 0359260000	20
	AP (DK4 QT) 1397160000	20
Blue PA	AP (1.5) 0359280000	20
	TW (2.0) 0607000000	20

Type	Cat. No.	Qty.
PA	AP (1.5) 0359260000	20
Blue PA	AP (1.5) 0359280000	20
	TW (2.0) 0607000000	20

Type	Cat. No.	Qty.
PA	AP (1.5) 0359260000	20
Blue PA	AP (1.5) 0359280000	20
	TW (2.0) 0607000000	20

Type	Cat. No.	Qty.
PA	AP (1.5) 0359260000	20
Blue PA	AP (1.5) 0359280000	20
	TW (2.0) 0607000000	20

Type	Cat. No.	Qty.
PA	AP (1.5) 0211360000	20
Blue PA	AP (1.5) 0359280000	20
	TW (2.0) 0607000000	20

Small partition

Type	Cat. No.	Qty.
TSch 4	TSch 4 0363360000	100

Type	Cat. No.	Qty.
TSch 4	TSch 4 0363360000	100

Type	Cat. No.	Qty.
TSch 4	TSch 4 0363360000	100

Type	Cat. No.	Qty.
TSch 4	TSch 4 0363360000	100

Cross-connection/covers

Type	Cat. No.	Qty.
Q 3	Q 2 0336400000	50
	Q 3 0336500000	50
	Q 4 0336600000	50
	Q 10 0368600000	20
	QB 2* 0482700000	100
	QB 3* 0482800000	50
	QB 4* 0482900000	50
25-pole		

Type	Cat. No.	Qty.
Q 3	Q 2 0336400000	50
	Q 3 0336500000	50
	Q 4 0336600000	50
	Q 10 0368600000	20
	QB 2* 0482700000	100
	QB 3* 0482800000	50
	QB 4* 0482900000	50

Type	Cat. No.	Qty.
Q 3	Q 2 0336400000	50
	Q 3 0336500000	50
	Q 4 0336600000	50
	Q 10 0368600000	20
	QB 2* 0482700000	100
	QB 3* 0482800000	50
	QB 4* 0482900000	50

Type	Cat. No.	Qty.
Q 3	Q 2 0336400000	50
	Q 3 0336500000	50
	Q 4 0336600000	50
	Q 10 0368600000	20
	QB 2* 0482700000	100
	QB 3* 0482800000	50
	QB 4* 0482900000	50

Type	Cat. No.	Qty.
Q 3	Q 2 0336400000	50
	Q 3 0336500000	50
	Q 4 0336600000	50
	Q 10 0368600000	20
	QB 2* 0482700000	100
	QB 3* 0482800000	50
	QB 4* 0482900000	50
	QB 25 blank* 0134000000	20

Test plug/socket

Type	Cat. No.	Qty.
StB	StB 8.5 (ø23) 0215700000	50
PS	PS 2.3 0180400000	20

Type	Cat. No.	Qty.
StB	StB 8.5 (ø23) 0215700000	50
PS	PS 2.3 0180400000	20

Type	Cat. No.	Qty.
StB	StB 8.5 (ø23) 0215700000	50
PS	PS 2.3 0180400000	20

Type	Cat. No.	Qty.
StB	StB 8.5 (ø2.3) 0215700000	50
PS	PS 2.3 0180400000	20

Type	Cat. No.	Qty.
FW/FS	dekafix 6 see "Accessories"	

Type	Cat. No.	Qty.
FW/FS	dekafix 6 see "Accessories"	

Type	Cat. No.	Qty.
FW/FS	dekafix 6 see "Accessories"	

Type	Cat. No.	Qty.
FW/FS	dekafix 6 see "Accessories"	

Mounting rails, end brackets, further marking material see "Accessories"

* The conductor cross-section for the screw connection is reduced to 2.5 mm² when QB is used.
** Only to be used with PA-version

¹⁾ Shock-proof with ADP4 cover profile (see section "Accessories")

Feed-through terminals and disconnect test terminals

with solder connection

SAK 2.5/M.LS

With screen lug

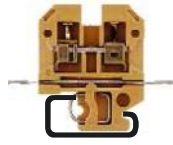

SAK 2.5 L SAK 2.5 L/35

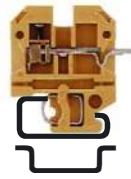

SAK 2.5 LL SAK 2.5 LL/35

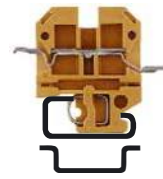

SAKR L SAKR L/35

Disconnect terminal



Dimensions/approvals

Width/length/height (mm)	with TS 32	
Width/length/height (mm)	with TS 35 x 7.5	
Insulation stripping length/clamping screw/screwdriver blade		

Rated data

Rated voltage/current/cross-section	250 V/20 A/2.5/1.5 mm ²
Rated impulse voltage VDE 0110/1.89/pollution severity	4 kV/3

Further technical data

Tightening torque range	Nm	0.4...0.7
Torque setting with electric screwdriver type DMS 2		1

Clampable conductor

Solid H07V-U	mm ²	0.5...6
Stranded H07V-R	mm ²	0.5...2.5
Flexible H07V-K	mm ²	0.5...4
Flexible H07V-K and ferrule according to DIN 46 228/1	mm ²	0.5...2.5
Plug gauge according to 60 947-7-1	Size	A 3

Continuous current of terminal block for conductor size		
Continuous current rating of cross-connection 2-pole	A	(Q 2...10) 24
Continuous current rating of cross-connection multipole	A	

Rated data according to UL/CSA

Voltage/current/conductor size	UL	300 V/10 A/22...12 AWG
Voltage/current/conductor size	CSA	300 V/10 A/22...12 AWG

Ordering data

Type	Cat. No.	Qty.
KrG	0309120000	100
Blue KrG	0351470000	100
KrS		
PA		
Blue PA		
KrG		
PA		
Blue PA		

Type	Cat. No.	Qty.
KrG	0351420000	100
Blue KrG	0351470000	100
KrS		
PA		
Blue PA		
KrG		
PA		
Blue PA		

Type	Cat. No.	Qty.
KrG	0323620000	100
Blue KrG	0323670000	100
KrS		
PA		
Blue PA		
KrG		
PA		
Blue PA		

Type	Cat. No.	Qty.
KrG	0412360000	100
Blue KrG	0412380000	100
KrS		
PA		
Blue PA		
KrG		
PA		
Blue PA		

Type	Cat. No.	Qty.
KrG	0412360000	100
Blue KrG	0412380000	100
KrS		
PA		
Blue PA		
KrG		
PA		
Blue PA		

End plate/partition (thickness mm)

Type	Cat. No.	Qty.
AP (1.5)	0309220000	20
Blue AP (1.5)	0309270000	20
PA		
Blue PA		
PA	0302860000	20
HP	0297100000	20
HP	0607000000	20



Type	Cat. No.	Qty.
AP (1.5)	0309220000	20
Blue AP (1.5)	0309270000	20
PA		
Blue PA		
PA	0302860000	20
HP	0297100000	20
HP	0607000000	20

Type	Cat. No.	Qty.
AP (1.5)	0309220000	20
Blue AP (1.5)	0309270000	20
PA		
Blue PA		
PA	0302860000	20
HP	0297100000	20
HP	0607000000	20

Type	Cat. No.	Qty.
AP (1.5)	0309220000	20
Blue AP (1.5)	0309270000	20
PA		
Blue PA		
PA	0302860000	20
HP	0297100000	20
HP	0607020000	20

Type	Cat. No.	Qty.
AP (1.5)	0211360000 ¹⁾	20
Blue AP (1.5)	0211380000	20
PA		
Blue PA		
PA	0412460000 [*]	100
HP	0412480000 [*]	100

Small partition

TSch 1	0319160000	100
--------	-------------------	-----

Cross-connection

Type	Cat. No.	Qty.
Q 2	0337000000	50
Q 3	0337100000	50
Q 4	0337200000	50
Q 10	0368700000	20
25-pole		



Type	Cat. No.	Qty.
Q 2	0337000000	50
Q 3	0337100000	50
Q 4	0337200000	50
Q 10	0368700000	20

Type	Cat. No.	Qty.
Q 2	0337000000	50
Q 3	0337100000	50
Q 4	0337200000	50
Q 10	0368700000	20

Type	Cat. No.	Qty.
Q 2	0337000000	50
Q 3	0337100000	50
Q 4	0337200000	50
Q 10	0368700000	20

Type	Cat. No.	Qty.
QB 2**	0482700000	100
QB 3**	0482800000	50
QB 4**	0482900000	50
QB 25 blank**	0134000000	20

Test plug/socket

StB	Plug-test socket without using QL
PS	Plug-test-socket for use with QL

AD 4	0303400000	50
BSK M3x22	0128900000	100

StB 8.5(ø23)	0280600000	50
StB 29.5(ø4)	0133400000	50
PS 2.3	0180400000	20
PS 4	0299600000	20

StB 8.5(ø23)	0280600000	50
StB 29.5(ø4)	0133400000	50
PS 2.3	0180400000	20
PS 4	0299600000	20

AD 4	0303400000	50
BSK M3x22	0128900000	100

PS 2.3	0180400000	20
--------	-------------------	----

Marking tags

DEK	Standard	DEK 6	see "Accessories"
-----	----------	-------	-------------------

DEK 6	see "Accessories"
-------	-------------------

DEK 6	see "Accessories"
-------	-------------------

DEK 6	see "Accessories"
-------	-------------------

DEK 6.5	see "Accessories"
---------	-------------------

Mounting rails, end brackets, further marking material see "Accessories"

* Soldering lug on left-hand side

** The conductor cross-section for the screw connection is reduced to 2.5 mm² when QB is used.

¹⁾ For TS 32 and TS 35

²⁾ Contact-proof cross-connection with ADP 4 cover profile (see "Accessories")

Disconnect test terminals with solder connections

SAKR L

With 2 StB 6



SAKR LL

SAKR LL

With 2 StB 6

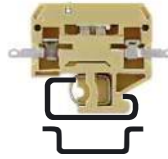

Dimensions/approvals

Width/length/height (mm)	with TS 32
Width/length/height (mm)	with TS 35 x 7.5
Insulation stripping length/clamping screw/screwdriver blade	

Rated data

Rated voltage/current/cross-section	250 V/10 A/4/1.5 mm ²
Rated impulse voltage VDE 0110/1.89/pollution severity	4 kV/3

Further technical data

Tightening torque range	Nm	0.5...1.0
Torque setting with electric screwdriver type DMS 2		1

Clampable conductor

Solid H07V-U	mm ²	0.5...4
Stranded H07V-R	mm ²	1.5...4
Flexible H07V-K	mm ²	0.5...4
Flexible H07V-K and ferrule according to DIN 46228/1		
With/without plastic insulating collar	mm ²	0.5...4
Plug gauge according to 60 947-7-1	Size	A 3

Continuous current of terminal block for conductor size		
Continuous current rating of cross-connection 2 pole	A	(QB 2...25) 10
Continuous current rating of cross-connection multipole	A	

Rated data according to UL/CSA

Voltage/current/conductor size	UL
Voltage/current/conductor size	CSA

Ordering data

Type	Qty.	Qty.
KrG		
Blue KrG		
KrS		
PA	0518160000	100
Blue PA		
KrG		
KrS		
PA	0572660000	100
Blue PA		

6.5/50/40.5/54.5 (opened)

8 mm/M 3/3.5 x 0.6

250 V/10 A/4/1.5 mm²

4 kV/3

0.5...1.0

1

0.5...4

1.5...4

0.5...4

0.5...4

A 3

(QB 2...25) 10

A



6.5/58/40.5/54.5 (opened)

250 V/10 A/1.5 mm²

4 kV/3

300 V/10 A/22...12 AWG

Qty.

6.5/58/40.5/54.5 (opened)

250 V/10 A/1.5 mm²

4 kV/3

Qty.

End plate/partition (thickness mm)

Type	Cat. No.	Qty.
KrG		
Blue KrG		
PA	AP (1.5) 0211360000	20
Blue PA	AP (1.5) 0211380000	20
PA		
HP	TW (0.5) 0474700000	20
HP	TW (2.0) 0607000000	20



Type Cat. No. Qty.

Type Cat. No. Qty.

Type Cat. No. Qty.

AP (1.5)

Blue KrG

PA

Blue PA

PA

HP

HP

Small partition



Cross-connection



QB 3

QB 4

2-pole

3-pole

4-pole

10-pole

25-pole

QB 2** **0482700000** 100

QB 3** **0482800000** 50

QB 4** **0482900000** 50

QB 25 blank** **0134000000** 20

Test plug/socket



PS

PS 2.3 **0180400000** 20

PS 2.3 **0180400000** 20

Marking tags

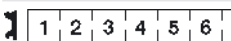

DEK

Print

DEK 6.5 see "Accessories"

DEK 6.5 see "Accessories"

DEK 6.5 see "Accessories"

Mounting rails, end brackets, further marking material see "Accessories"

* Soldering lug on left-hand side

** The conductor cross-section for the screw connection is reduced to 2.5 mm² when QB is used.

Disconnect test terminals with solder connections

TAL
2 solder connections

TAL
4 solder connections

SAKK 4 **SAKK 10**
Ceramic feed-through terminals for use in high temperature ranges up to max. 210°C



Dimensions/approvals

Width/length/height (mm) with TS 32 with TS 35 x 7.5
Insulation stripping length/clamping screw/screwdriver blade

4/48/36/50 (opened)

4/54/36/50 (opened)

8/40/53

11.5/40/53

Rated data

Rated voltage/current/cross-section
Rated impulse voltage VDE 0110/1.89/pollution severity

63 V/10 A/1.5 mm²
1.5 kV/3

63 V/10 A/1.5 mm²
1.5 kV/3

IEC 60 947-7-1
800 V/32 A/4 mm²

IEC 60 947-7-1
800 V/57 A/10 mm²

Further technical data

Tightening torque range Nm
Torque setting with electric screwdriver type DMS 2

Nm

0.5...1

1.2...2

Clampable conductor

Solid H07V-U mm²
Stranded H07V-R mm²
Flexible H07V-K mm²
Flexible H07V-K and ferrule according to DIN 46 228/1 mm²
Plug gauge according to 60 947-7-1 Size

0.5...6 mm²

2.5...16 mm²

0.5...4 mm²

2.5...10 mm²

A 4

B 6

35 A/6 mm²

63 A/16 mm²

36

47

36

36

Rated data according to UL/CSA

Voltage/current/conductor size UL
Voltage/current/conductor size CSA

Ordering data

Type Cat. No. Qty.
KrG
Blue KrG
KrS
PA **0212060000** 100
Blue PA
KrG
KrS
PA
Blue PA
Ceramic

Type Cat. No. Qty.
0304960000 100

Type Cat. No. Qty.
1598080000 50

Type Cat. No. Qty.
1598090000 50

End plate/partition (thickness mm)

AP TW

KrG
Blue KrG
PA
Blue PA
PA

Type Cat. No. Qty.
AP (1.5) **0212260000** 20

Type Cat. No. Qty.
AP (1.5) **0212260000** 20

SAKK 4 **1598080000** 50
AP/SAKK 4/10 **9502630000** 10

SAKK 10 **1598090000** 50
AP/SAKK 4/10 **9502630000** 10

Small partition

Cross-connection

Q 3 QB 4

2-pole
3-pole
4-pole
10-pole
25-pole

Type Cat. No. Qty.
QL 2 **9509420000** 100
QL 3 **9509430000** 100
QL 4 **9509440000** 50
QL 10 **9509450000** 20
VH 13.5 **0248500000** 100
BS (M3 X 20) **0303000000** 100

Type Cat. No. Qty.
QL 2 **9509470000** 100
QL 3 **9509480000** 50
QL 4 **9509490000** 50
QL 10 **9509500000** 20
VH 12.5 **9509510000** 50
BS (M3 X 20) **0303000000** 100

Additional accessories

SST **0152700000**
MEW 1/32 **0445600000**
EK 2 **0323100000**

SST **0152700000**
MEW 1/32 **0445600000**
EK 2 **0323100000**

Marking tags

DEK Standard On demand

On demand

Mounting rails, end brackets, further marking material see "Accessories"

Feed-through terminals for initiators and actuators

DLI 2.5

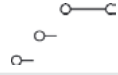

UL	6/65/49
Insulation stripping length/clamping screw/screwdriver blade	7 mm/M 2.5/3.5 x 0.6

DLI 2.5 LD PNP

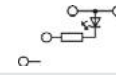

UL	6/65/49
Insulation stripping length/clamping screw/screwdriver blade	7 mm/M 2.5/3.5 x 0.6

DLI 2.5 LD NPN

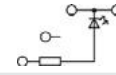

UL	6/65/49
Insulation stripping length/clamping screw/screwdriver blade	7 mm/M 2.5/3.5 x 0.6

DLD 2.5



UL	6/82/49
Insulation stripping length/clamping screw/screwdriver blade	7 mm/M 2.5/3.5 x 0.6

Dimensions/approvals

Width/length/height (mm)	with TS 35 x 7.5
Insulation stripping length/clamping screw/screwdriver blade	

Rated data according to IEC 60 947-7-1

Rated voltage/current/cross-section	250 V/20 A/2.5 mm ²
Rated impulse voltage/pollution severity	4 kV/3

Further technical data

Tightening torque range	Nm	0.4...0.6
Torque setting with electric screwdriver type DMS 2		1

Clampable conductor

Solid H07V-U	mm ²	0.5...4
Stranded H07V-R	mm ²	0.5...2.5
Flexible H07V-K	mm ²	0.5...4
Flexible H07V-K and ferrule according to DIN 46228/1	mm ²	0.5...2.5
Plug gauge according to 60 947-7-1	Size	A 3
Continuous current of terminal for conductor size		20 A/2.5 mm ²
Continuous current rating of cross-connection 2...5-pole	A	(Q 2...10) 20
Continuous current rating of cross-connection 6...10-pole	A	(Q 2...10) 20

Rated data according to UL/CSA

Voltage/current/conductor size	UL	300 V/10 A/26...12 AWG
Voltage/current/conductor size	CSA	300 V/10 A/26...12 AWG

Ordering data

Type	Cat. No.	Qty.
Standard	1313360000	100
with diode 1N4007		
with LED red (5...30 V)	1578510000	100
with LED green (5...30 V)	1578520000	100
with LED and diode 1N4007		
with LED and diode 1N4007		
Block of 10 ¹⁾	(w/o) 1411360000	10
Block of 10 ¹⁾	(with dekafix) 1579070000	10
Fuse inserts		

End plate/Small partition

Type	Cat. No.	Qty.
AP-DLI	1313260000	20
AP-DLD	1313260000	20
Part-AP	1313260000	20
TSch 1	0319160000	100

Test plug/plug socket

StB 8.5 (ø23)	0215700000	50
PS 2.3	0180400000	20

Cross-connection

Type	Cat. No.	Qty.
Q 2	1312500000	50
Q 3	1312600000	50
Q 4	1312700000	50
Q 10	1313100000	20
Q 20	1399800000	20

VQB

VH 4.2	1345800000	100
VQB15/50BL	1633280000	5
VQB15/50RT	1633290000	5
VQB15/50SW	1635120000	5

For cross-connections for more than 20 terminals, replace VH with VH 4.2 (134580) without internal thread

Group marking

WT 4	1341060000	100
SF 10	0332400000	1000
SG 10	0332500000	1000

Cover

ADP	0485400000	20
HP 4	0485860000	20

Marking tags

DEK	Standard	DEK 6	see "Accessories"
-----	----------	-------	-------------------

Mounting rails, end brackets, further marking material see "Accessories"

1) DLI 2.5/35/10 = Block of 10 with built-in cross-connections * only in upper busbar

Feed-through terminals for initiators and actuators

DLA 2.5

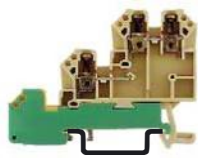

UL
6/65/49
7 mm/M 2.5/3.5 x 0.6

250 V**/17.5 A/2.5 mm ²
4 kV/3
0.4...0.6
1
0.5...4
0.5...2.5
0.5...4
0.5...2.5
A 3
20 A/2.5 mm ²
(Q 2...20) 20

300 V/10 A/26...12 AWG
300 V/10 A/26...12 AWG
Cat. No. Qty.
1565970000 100

(w. dekafix) 1578380000 10
(w/o dekafix) 1578390000 10

Type	Cat. No.	Qty.
AP	1313260000	20

TSch 1	0319160000	100
--------	-------------------	-----

StB8.5*(ø23) 0215700000 50
PS 2.3 0180400000 20

Q 2 1312500000 50
Q 3 1312600000 50
Q 4 1312700000 50
Q 10 1313100000 20
Q 20 1399800000 20

QL 2 0297200000 100
VH 4.2 1345800000 100
VQB1.5/50 BL 1633280000 5
VQB1.5/50 RT 1633290000 5
VQB1.5/50 SW 1635120000 5

WT 4 1341060000 100
SF 10 0332400000 1000
SG 10 0332500000 1000
ADP 0485400000 20
HP 4 0485860000 20

DEK 6	see "Accessories"
-------	-------------------

DLA 2.5/D

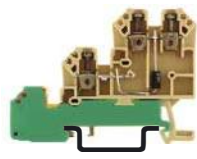

UL
6/65/49
7 mm/M 2.5/3.5 x 0.6

250 V**/17.5 A/2.5 mm ²
4 kV/3
0.4...0.6
1
0.5...4
0.5...2.5
0.5...4
0.5...2.5
A 3
20 A/2.5 mm ²
(Q 2...20) 20

300 V/10 A/26...12 AWG
300 V/10 A/26...12 AWG
Cat. No. Qty.
1578400000 100

Type	Cat. No.	Qty.
AP	1313260000	20

TSch 1	0319160000	100
--------	-------------------	-----

Q 2 1312500000 50
Q 3 1312600000 50
Q 4 1312700000 50
Q 10 1313100000 20
Q 20 1399800000 20

QL 2 0297200000 100
VH 4.2 1345800000 100
VQB1.5/50 BL 1633280000 5
VQB1.5/50 RT 1633290000 5
VQB1.5/50 SW 1635120000 5

WT 4 1341060000 100
SF 10 0332400000 1000
SG 10 0332500000 1000
ADP 0485400000 20
HP 4 0485860000 20

DEK 6	see "Accessories"
-------	-------------------

DLA 2.5/LD



UL
6/65/49
7 mm/M 2.5/3.5 x 0.6

5-30 V/17.5 A/2.5 mm ²
0.8 kV/3
0.4...0.6
1
0.5...4
0.5...2.5
0.5...4
0.5...2.5
A 3
20 A/2.5 mm ²
(Q 2...20) 20

300 V/10 A/26...12 AWG
5-30 V/10 A/26...12 AWG
Cat. No. Qty.
1578430000 100
1578440000 100

Type	Cat. No.	Qty.
AP	1313260000	20

TSch 1	0319160000	100
--------	-------------------	-----

Q 2 1312500000 50
Q 3 1312600000 50
Q 4 1312700000 50
Q 10 1313100000 20
Q 20 1399800000 20

QL 2 0297200000 100
VH 4.2 1345800000 100
VQB1.5/50 BL 1633280000 5
VQB1.5/50 RT 1633290000 5
VQB1.5/50 SW 1635120000 5

WT 4 1341060000 100
SF 10 0332400000 1000
SG 10 0332500000 1000
ADP 0485400000 20
HP 4 0485860000 20

DEK 6	see "Accessories"
-------	-------------------

DLA 2.5/LD/D



UL
6/65/49
7 mm/M 2.5/3.5 x 0.6

5-30 V/17.5 A/2.5 mm ²
0.8 kV/3
0.4...0.6
1
0.5...4
0.5...2.5
0.5...4
0.5...2.5
A 3
20 A/2.5 mm ²
(Q 2...20) 20

300 V/10 A/26...12 AWG
5-30 V/10 A/26...12 AWG
Cat. No. Qty.
(LED red) 1578470000 100
(LED green) 1578480000 100
(LED red) 1578490000 10
(LED green) 1578500000 10

Type	Cat. No.	Qty.
AP	1313260000	20

TSch 1	0319160000	100
--------	-------------------	-----

Q 2 1312500000 50
Q 3 1312600000 50
Q 4 1312700000 50
Q 10 1313100000 20
Q 20 1399800000 20

QL 2 0297200000 100
VH 4.2 1345800000 100
VQB1.5/50 BL 1633280000 5
VQB1.5/50 RT 1633290000 5
VQB1.5/50 SW 1635120000 5

WT 4 1341060000 100
SF 10 0332400000 1000
SG 10 0332500000 1000
ADP 0485400000 20
HP 4 0485860000 20

DEK 6	see "Accessories"
-------	-------------------

DLD 2.5/PE



UL
6/74.5/49
7 mm/M 2.5/3.5 x 0.6

250 V**/17.5 A/2.5 mm ²
4 kV/3
0.4...0.6
1
0.5...4
0.5...2.5
0.5...4
0.5...2.5
A 3
20 A/2.5 mm ²
(Q 2...20) 20

300 V/10 A/26...12 AWG
300 V/10 A/26...12 AWG
Cat. No. Qty.
1595950000 100

Type	Cat. No.	Qty.
AP	1595960000	20

TSch 1	0319160000	100
--------	-------------------	-----

StB8.5*(ø23) 0215700000 50
PS 2.3 0180400000 20

Q 2 1312500000 50
Q 3 1312600000 50
Q 4 1312700000 50
Q 10 1313100000 20
Q 20 1399800000 20

QL 2 0297200000 100
VH 4.2 1345800000 100
VQB1.5/50 BL 1633280000 5
VQB1.5/50 RT 1633290000 5
VQB1.5/50 SW 1635120000 5

WT 4 1341060000 100
SF 10 0332400000 1000
SG 10 0332500000 1000
ADP 0485400000 20
HP 4 0485860000 20

DEK 6	see "Accessories"
-------	-------------------

KDKS1/PE

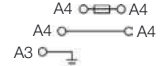
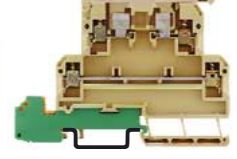

UL
8/91/65
8 mm/M 3 ² /M 2.5 ³ /3.5 x 0.6

500 V/6.3 A/4 mm ²
6 kV/3
0.5...1 ² /0.4...0.7 ³
2/1 ^{***}
0.5...4
0.5...4
0.5...4
0.5...4
A 4 ² / A 3 ³

-/22...12 AWG
Cat. No. Qty.
9528110000 50

not combine with
DLI / DLA
Wemid **9532450000** 50

5 x 20 without core indicator		
Type	Cat. No.	Qty.
AP	9503330000	50
AP Wemid	9532470000	50

** If the cross-connection runs via the PE connection of the DLA, or if a pole is generally skipped, the rated voltage is reduced to 30 V-
²) A4 clamping position = max 4 mm² ... ³) A3 clamping position = max 2.5 mm² ... ferrule with/without plastic insulating collar

Feed-through terminals for initiators and motors

VLI 1.5

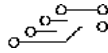

UL	6/79/64
Insulation stripping length/clamping screw/screwdriver blade	8 mm/M 2.5/3.5 x 0.6

VLI 1.5PE

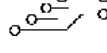

UL	6/69/63
Insulation stripping length/clamping screw/screwdriver blade	8 mm/M 2.5/3.5 x 0.6

MAK 2.5

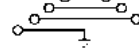

UL	6/88/64
Insulation stripping length/clamping screw/screwdriver blade	8 mm/M 2.5/3.5 x 0.6

Dimensions/approvals

Width/length/height (mm)	with TS 35 x 7.5
Insulation stripping length/clamping screw/screwdriver blade	

Rated data according to IEC 60 947-7-1

Rated voltage/current/cross-section	250 V/17.5 A/1.5 mm ²	250 V/17.5 A/1.5 mm ²	500 V (L-L)/250 V (L-PE) 24 A/2.5 mm ²
Rated impulse voltage/pollution severity	4 kV/3	4 kV/3	6 kV/3

Further technical data

Tightening torque range	Nm	0.4...0.6**	0.4...0.6	0.4...0.6
Torque setting with electric screwdriver type DMS 2		1	1	1

Clampable conductor

Solid H07V-U	mm ²	0.5...4.0	0.5...4.0	0.5...4.0
Stranded H07V-R	mm ²	0.5...2.5	0.5...2.5	0.5...2.5
Flexible H07V-K	mm ²	0.5...4	0.5...4	1.5...4
Flexible H07V-K and ferrule DIN 46 228/1	mm ²	0.5...2.5	0.5...2.5	0.5...2.5
Flexible H07V-K and ferrule with plastic insul. collar	mm ²	0.5...2.5	0.5...2.5	0.5...2.5
Plug gauge according to 60 947-7-1	Size	A3	A3	A3
Continuous current of terminal for conductor size		24 A/2.5 mm ²	24 A/2.5 mm ²	24 A/4 mm ²
Continuous current rating of cross-connection, multipole	A	24	24	24

Rated data according to UL/CSA

Voltage/current/conductor size	UL	300 V/10 A/26...12 AWG	300 V/10 A/26...12 AWG	300 V/10 A/26...12 AWG
Voltage/current/conductor size	CSA	300 V/10 A/26...12 AWG	300 V/10 A/26...12 AWG	300 V/10 A/26...12 AWG

Ordering data

Version	Cat. No.	Qty.	Cat. No.	Qty.	Cat. No.	Qty.
PA	1633250000	50	1633310000	50	1615270000	50
					1631650000	50

End plate/partition

Type	Cat. No.	Qty.	Type	Cat. No.	Qty.	Type	Cat. No.	Qty.	
End plate	AP VLI1.5	1633260000	20	APVLI1.5/PE	1633320000	20	AP MAK2.5	1615280000	20
Partial end plate for VLI1.5 – MAK2.5 combination	TEAP2 MAK2.5	1633330000	20	TEAP VLI1.5	1633270000	20	TEAP2 MAK2.5	1633330000	20
Partial end plate for VLI1.5 – VLI1.5PE combination	TEAP VLI1.5	1633270000	20	TEAP1 MAK2.5	1633340000	20	TEAP1 MAK2.5	1633340000	20
Partial end plate for VLI1.5PE – MAK2.5 combination									

Cross-connection

VQB 50-pole, snap-fit, external cross-connection	VQB1.5/50BL*	1633280000	5	VQB1.5/50BL*	1633280000	5	VQB1.5/50BL*	1633280000	5
	VQB1.5/50RT*	1633290000	5	VQB1.5/50RT*	1633290000	5	VQB1.5/50RT*	1633290000	5
	VQB1.5/50SW*	1635120000	5	VQB1.5/50SW*	1635120000	5	VQB1.5/50SW*	1635120000	5
							QB 25 SW*	0520000000	20
							QB 25 RT*	0520060000	20
							QB 25 BL*	0520080000	20



QB 25-pole external cross-connection

Group marking

T 5	0348500000	100	T 5	0348500000	100	T 5	0348500000	100
SF 10	0332400000	1000	SF 10	0332400000	1000	SF 10	0332400000	1000
SG 10	0332500000	1000	SG 10	0332500000	1000	SG 10	0332500000	1000

Marking tags

DEK	Standard	DEK 5	see "Accessories"	DEK 5	see "Accessories"	DEK 5	see "Accessories"
-----	----------	-------	-------------------	-------	-------------------	-------	-------------------

Mounting rails, end brackets, further marking material see "Accessories"

* When using cross-connection bridges, the connected cross-section is reduced by one level
 ** 0.4...0.45 for lower connection level

Disconnect test terminal against induced high voltage

PPT/35



SAKH 6



Measures to minimize risks of electric voltage peaks in control systems of power plants and transforming stations:

- Insulation between installation and control cable by pulling disconnect plugs.
- Grounding of control cable is possible on an appropriate location of the workplace.
- Easy connection of electric isolation of counting, control and communication circuits.

Electricity Supply Industry Standard ESI 12-4 1973

The Electricity Supply Industry Standard ESI 12-4 1973 defines a detailed specification of control and protection equipment. The main functions of these installations are as follows:

- Insulation of the control cables located in front of ground or installation lines with increased potential, which is required to prevent unintentional contact of service staff with live parts.
- Separation of control cables from local control circuits.
- Application also includes test connections for auxiliary control circuits and / or local control circuits.
- Grounding of control cables and / or auxiliary control circuits.
- Bundled disconnection of all auxiliary control circuits from potential earth.
- A test voltage can be applied using the screening connection of the control cable, which is normally routed on the enclosure, with the help of an appropriate separation. This permits to check whether the screening line is correctly functioning. For this test, an insulated feed-through plate is required.

ESI 12-4:

"Terminating Equipment for Pilot Cables subject to Induced Transient Voltages exceeding 650 V rms".

Dimensions/approvals		PPT/35		SAKH 6	
Width/length/height (mm)	with TS 35 x 7.5	15/138/79			
Insulation stripping length/clamping screw/screwdriver blade		12 mm			12 mm
Rated data according to IEC 60 947-7-1		PPT/35		SAKH 6	
Rated voltage/current		15 kV ac (ESI 12-4)**/30 A			1 kV ac / 1.5 kV dc / 47 A
Rated impulse voltage/pollution severity					>15 kV (from terminal to terminal)
Clampable conductor		PPT/35		SAKH 6	
Solid H07V-U	mm ²	0.5...10			0.5... 6
Stranded H07V-R	mm ²	0.5...10*			0.5... 6
Ordering data		PPT/35		SAKH 6	
Version	EP	Cat. No.	Qty.	Cat. No.	Qty.
		PPT/35	3835020000 10	SAKH 6	0126600000 50
		incl. disconnect plug and displacement tool (if min. 10 items are ordered)			
End plate		PPT/35		SAKH 6	
Version	EP	AP/PPT (3)	3835120000 10	AP	0131700000 20
Disconnect plug		PPT/35		SAKH 6	
		TST/PPT	3835360000 10		
Displacement tool		PPT/35		SAKH 6	
Version	PA	PH/PPT	3835260000 10		
		The disconnect plug may only be removed with the displacement tool.			
Test plug/socket		PPT/35		SAKH 6	
		PS (4)	0299600000 20		
		StB 17	0147100000 50		
Insulated mounting rail		PPT/35		SAKH 6	
	PVC 35 x 1.5 mm	TSK 35	0514300000 1		
Marking tags		PPT/35		SAKH 6	
	DEK Standard	DEK 5	see "Accessories"	DEK 5	see "Accessories"

DEK Standard

DEK 5 see "Accessories"

DEK 5 see "Accessories"

Mounting rails, end brackets, further marking material see "Accessories"

* Also two push-on tabs are possible
** mounted on an insulated mounting rail

Rail mounting TS 15

Feed-through terminals
Protective conductor terminals
Fuse terminals
Disconnect test terminals

AKZ 1.5 AKZ 1.5/10



AKZ 2.5



AKZ 4 AKZ 4/10 AKZ 4 Wemid



AKZ 4 for test adapter AKZ 4/10 for test adapter



Max. technical data

Dimensions/approvals		AKZ 1.5	AKZ 2.5	AKZ 4	AKZ 4 for test adapter
Width/length/height (mm)	with TS 15	5/25/25	5/25/28	6/27/30	60/27/30

Insulation stripping length/clamping screw/screwdriver blade		AKZ 1.5	AKZ 2.5	AKZ 4	AKZ 4 for test adapter
Rated data VDE 0611 Part 1/8.92/IEC 60 947-7-1		7 mm/M 2.5/3.0 x 0.5	7 mm/M 2.5/3.0 x 0.5	8 mm/M 3/3.5 x 0.6	9 mm/M 3/3.5 x 0.6

Rated data VDE 0611 Part 1/8.92/IEC 60 947-7-1		AKZ 1.5	AKZ 2.5	AKZ 4	AKZ 4 for test adapter
Rated voltage/current/cross-section		250 V/17.5 A/1.5 mm ²	250 V/24 A/2.5 mm ²	400 V/32 A/4 mm ²	500 V/32 A/4 mm ²
Rated impulse voltage / pollution severity		4 kV/3	4 kV/3	6 kV/3	6 kV/3

Further technical data		AKZ 1.5	AKZ 2.5	AKZ 4	AKZ 4 for test adapter
Tightening torque range	Nm	0.4...0.6	0.4...0.6	0.5...1.0	0.5...1.0
Torque setting with electric screwdriver type DMS 2		1	1	2	2

Clampable conductor		AKZ 1.5	AKZ 2.5	AKZ 4	AKZ 4 for test adapter
Solid H07V-U	mm ²	0.5...2.5	0.5...4	0.5...6	0.5...6
Stranded H07V-R	mm ²	1.5	1.5...2.5	1.5...4	1.5...4
Flexible H07V-K	mm ²	0.5...1.5	0.5...4	0.5...4	0.5...4
Flexible H07V-K and ferrule DIN 46 228/1	mm ²	0.5...1.5	0.5...2.5	0.5...4	0.5...4
Flexible H07V-K and ferrule with plastic insul. collar	mm ²	0.5...1.5	0.5...2.5	0.5...4	0.5...4
Max. clamping range in mm ² /plug gauge acc. to IEC 60 947-1	Size	0.2...2.5 / A 1	0.13...4.0 / A 3	0.2...6.0 / A 3	0.2...6.0 / A 3

Continuous current rating of cross-connection 2-pole		AKZ 1.5	AKZ 2.5	AKZ 4	AKZ 4 for test adapter
Continuous current rating of cross-connection multipole	A	24	24	32	32

Rated data according to UL/CSA		AKZ 1.5	AKZ 2.5	AKZ 4	AKZ 4 for test adapter
Voltage/current/conductor size	UL	150 V/15 A/22...14 AWG	300 V/10 A/26...12 AWG	300 V/27A/22...12 AWG	300V/27 A/22...12 AWG
Voltage/current/conductor size	CSA	300 V/10 A/24...16 AWG	300 V/10 A/26...12 AWG	300 V/10 A/24...12 AWG	300 V/10 A/24...12 AWG

Ordering data		AKZ 1.5	AKZ 2.5	AKZ 4	AKZ 4 for test adapter
Type	TS 15 Cat. No. Qty.				
KrG				0294320000 100	
PA		0340460000 100	(with pin) 0697160000 100	0294360000 100	for test adapter 1538260000 100
Blue PA		0340480000 100	(with pin) 0697180000 100	0294380000 100	
PA		(10pol./no.mk.) 0358060000 10	(without pin) 0175960000 100	(10pol./no.mk.) 0359560000 10	w.mk./t.test ad. 1489360000 10
PA		(10pol./w.mk.) 0358160000 10	AKZ 2.5 w. AP 0385860000 50	(10pol./w.mk.) 0359660000 10	
				AKZ 4 Wemid 9537110000 100	ATA1,10-pole 1633240000 5

End plate (thickness mm)		AKZ 1.5	AKZ 2.5	AKZ 4	AKZ 4 for test adapter
Type	Cat. No. Qty.				
KrG				AP (1.5) 0294420000 20	
Wemid				AP (1.5) 9537910000 20	
PA		AP (1.5) 0340560000 50	AP (2.5) 0697360000 50	AP (1.5) 0294460000 20	AP (1.5) 0294460000 20
Blue PA			AP (2.5) 0697380000 50	AP (1.5) 0294480000 20	

Partition (thickness mm)		AKZ 1.5	AKZ 2.5	AKZ 4	AKZ 4 for test adapter
Type	Cat. No. Qty.				
KrG				TW (2.0) 0118900000 20	
PA			TW (1.5) 0318560000 20	TW (0.5) 0348260000 50	TW (0.5) 0348260000 50
Blue PA			TW (1.5) 0318580000 20		

Small partition		AKZ 1.5	AKZ 2.5	AKZ 4	AKZ 4 for test adapter
Type	Cat. No. Qty.				
PA				TSch 4 0363360000 100	TSch 4 0363360000 100

Cross-connection		AKZ 1.5	AKZ 2.5	AKZ 4	AKZ 4 for test adapter
Type	Cat. No. Qty.				
Q 2		0368200000 50	0368200000 50	0336400000 50	0336400000 50
Q 3		0368300000 50	0368300000 50	0336500000 50	0336500000 50
Q 4		0368400000 50	0368400000 50	0336600000 50	0336600000 50
Q 5		0660300000 20	0660300000 20		
Q 10		0368500000 20	0368500000 20	0368600000 20	0368600000 20

Switchable cross-connection link		AKZ 1.5	AKZ 2.5	AKZ 4	AKZ 4 for test adapter
Type	Cat. No. Qty.				
VL 2				0446700000 50	0446700000 50
VH 10				0446600000 50	0446600000 50
BS M 2.5x14				0266800000 100	0266800000 100

Cover/Profiled material for covers for finger-safety*		AKZ 1.5	AKZ 2.5	AKZ 4	AKZ 4 for test adapter
Type	Cat. No. Qty.				
AD 4			Marking tags can be snapped on via cross-connection	0303400000 50	0303400000 50
BSKM 25x18				0303300000 100	0303300000 100
ADP 4 ¹⁾				1378160000 10	1378160000 10

Test plug/socket		AKZ 1.5	AKZ 2.5	AKZ 4	AKZ 4 for test adapter
Type	Cat. No. Qty.				
StB	Plug test socket can be used without QL	StB 8.5 0215700000 50	StB 8.5 0215700000 50	StB 8.5 0215700000 50	StB 8.5 0215700000 50
PS					
K sleeve		PS 2.3 0180400000 20	PS 2.3 0180400000 20	PS 2.3 0180400000 20	PS 2.3 0180400000 20

Marking tags		AKZ 1.5	AKZ 2.5	AKZ 4	AKZ 4 for test adapter
Type	Cat. No. Qty.				
DEK	Standard	DEK 5 see "Accessories"	DEK 5 see "Accessories"	DEK 6 see "Accessories"	DEK 6 see "Accessories"

Mounting rails, end brackets, further marking material see "Accessories"
* not for terminals made from PA

¹⁾ Length: 300 mm

Rail mounting TS 15

AK 4 AK 4/10



38.5 A / 6 mm²

UL **CE**
60/32/34

9 mm/M 3/3.5 x 0.6

690 V/32 A/4 mm²
8 kV/3

0.5...1.0

2

0.5...6

1.5...4

0.5...4

0.5...4

0.5...4

0.2...6.0 / A 3

20

20

TS 15 Cat. No. Qty.
0489560000 100

(10pol./no.mk.) **0366560000** 10
(10pol./w.mk.) **0469560000** 10

Type Cat. No. Qty.

BB 3 (8.0) **0366660000** 50
combined AP + end brackets

TW/AP (1.5) **1331760000** 20

TSch 4 **0363360000** 100

Q 2 **0369000000** 50

Q 3 **0369100000** 50

Q 4 **0369200000** 50

Q 10 **0369300000** 20

AD 4 **0303400000** 50

BSKM 25x18 **0303300000** 100

StB 8.5 **0215700000** 50

PS 2.3 **0180400000** 20

DEK 6 see "Accessories"

AKE 2.5



UL **CE**

5/28/27

7 mm/M 2.5/3.0 x 0.5

IEC 60 947-7-2

-/-/2.5 mm²
4 kV/3

0.4...0.6

1

0.5...4

1.5...2.5

0.5...4

0.5...2.5

0.5...2.5

0.13...4.0 / A 3

TS 15 Cat. No. Qty.
1303360000 100
(green/yellow)

-/-/26...12 AWG
-/-/26...12 AWG

Type Cat. No. Qty.

AKE 4



UL **CE**

7/32/34

9 mm/M 3/3.5 x 0.6

IEC 60 947-7-2

-/-/4 mm²
8 kV/3

0.5...1.0

2

0.5...6

1.5...4

0.5...4

0.5...2.5

0.5...2.5

0.13...4.0 / A 3

TS 15 Cat. No. Qty.
0380260000 100
(green/yellow)

-/-/22...12 AWG
-/-/26...12 AWG

Type Cat. No. Qty.

AKE 4 MS



CE

7/27.5/30

9 mm/M 3/3.5 x 0.6

-/-/4 mm²

0.8...1.6

3

0.5...4

1.5...4

0.5...4

0.5...4

0.5...4

0.5...4.0 / A 3

TS 15 Cat. No. Qty.
0211200000 50

-/-/22...14 AWG

Type Cat. No. Qty.

ASK 1

Fuse terminal



UL **CE**

8/58/34

9 mm/M 3/3.5 x 0.6

500 V/6.3 A¹/4 mm²
6 kV/3

0.5...1.0

2

0.5...4

1.5...4

0.5...4

0.5...2.5

0.5...2.5

0.13...4.0 / A 3

(QB 2...4) 10

TS 15 Cat. No. Qty.
0376860000 100

300 V/10 A/22...12 AWG
300 V/6.3 A/26...12 AWG

Type Cat. No. Qty.

AP (1.5) **0380360000** 20

5 x 20 without indicator

QB 2¹) insul. **0461100000** 50

QB 3¹) insul. **0461200000** 50

QB 4¹) insul. **0461300000** 50

3-pole ganging with tag bar
SchS 2, snapped onto three
disconnect levers
(Cat. No. **0337400000**)

K sleeve **0553300000** 100

DEK 6.5 see "Accessories"

SAKR

Isolating blade terminal with 2 sockets or with 2 clamping screws



6.5/42/45

8 mm/M 3/3.5 x 0.6

400 V²/10 A/4 mm²
6 kV/3

0.5...1.0

2

0.5...4

1.5...4

0.5...4

0.5...4

0.13...4.0 / A 3

(QB 2...4) 10

TS 15 Cat. No. Qty.
with 2 StB **0412860000** 100

w. clamp.screw **0412760000** 100

Type Cat. No. Qty.

AP (1.5) **0211360000** 20

QB 2¹) insul. **0482700000** 50

QB 3¹) insul. **0482800000** 50

QB 4¹) insul. **0482900000** 50

QB 25¹) blank **0134000000** 20

PS 2.3 **0180400000** 20

DEK 6.5 see "Accessories"

¹) The conductor cross-section is * With contact sleeve 19 A reduced to max. 2.5 mm² when QB is used.

²) As disconnect test terminal: rated voltage 250 V

Feed-through terminals for TS 15

Tab connection
Solder connection

AKZ 4 SS

AKZ 4 SS

AKZ 4 S

AKZ 4 SF



Dimensions/approvals	AKZ 4 SS	AKZ 4 SS	AKZ 4 S	AKZ 4 SF
Width/length/height (mm)	6/28.5/30.5	6/28.5/30.5	6/27/30	6/27/30
Insulation stripping length/clamping screw/screwdriver blade			9 mm/M 3/3.5 x 0.6	9 mm/M 3/3.5 x 0.6
Rated data				
Rated voltage*/current/cross-section	400 V/8 A/2.5/1 mm ²	400 V/8 A/1 mm ²	400 V/8 A/4/1 mm ²	400 V/8 A/4/1 mm ²
Rated impulse voltage VDE 0110/1.89/pollution severity	6 kV/3	6 kV/3	6 kV/3	6 kV/3
Further technical data				
Tightening torque range	Nm		0.5...1.0	0.5...1.0
Torque setting with electric screwdriver type DMS 2			2	2
Clampable conductor				
Solid H07V-U	mm ²		0.5...4	0.5...4
Stranded H07V-R	mm ²		1.5...4	1.5...4
Flexible H07V-K	mm ²	Tab connec. 6.3 and 2.8 mm	0.5...4	0.5...4
Flexible H07V-K and ferrule DIN 46 228/1	mm ²		0.5...4	0.5...4
Flexible H07V-K and ferrule with plastic insul. collar	mm ²		0.5...4	0.5...4
Max. clamping range in mm ² /plug gauge acc. to IEC 60 947-1 Size			0.2...4/A 3	0.2...4/A 3
Continuous current rating of cross-connection 2-pole	A	20	20	20
Continuous current rating of cross-connection multipole	A	20	20	20
Rated data according to UL/CSA				
Voltage/current/conductor size	UL	150 V/10 A/22...12 AWG	150 V/20 A/22...12 AWG	
Voltage/current/conductor size	CSA	300 V/10 A/24...12 AWG	300 V/10 A/24...12 AWG	300 V/10 A/24...12 AWG
Ordering data	Type	TS 15 Cat. No. Qty.	TS 15 Cat. No. Qty.	TS 15 Cat. No. Qty.
	KrG			
	PA	0324560000 100	0362460000 100	0324460000 100
	Blue PA			0158760000 100
	PA			
End plate (thickness mm)	Type	Cat. No. Qty.	Type	Cat. No. Qty.
	PA	AP (1.5) 0294460000 20	PA	AP (1.5) 0294460000 20
	PA			
	Blue PA			
	HP			
	HP			
	BB			
Partition (thickness mm)	Type	Cat. No. Qty.	Type	Cat. No. Qty.
	PA	TW (0.5) 0348260000 50	PA	TW (0.5) 0348260000 50
	HP			
	HP			
Small partition				
Cross-connection				
	Q 2	0369000000 50	Q 2	0369000000 50
	Q 3	0369100000 50	Q 3	0369100000 50
	Q 4	0369200000 50	Q 4	0369200000 50
	Q 10	0369300000 20	Q 10	0369300000 20
Switchable cross-connection link				
	VL 2	0446700000 50	VL 2	0446700000 50
	VH 10	0446600000 50	VH 10	0446600000 50
	BS M 2.5x14	0266800000 100	BS M 2.5x14	0266800000 100
Test plug/socket				
	StB	Plug test socket ø 2.3	StB 8.5	0215700000 50
	PS		PS 2.3	0180400000 20
Cover				
Insulation sleeves				
	IH 2.8	0386060000 100	IH 2.8	0386060000 100
	IH 6.3	0386260000 100	IH 6.3	0386260000 100
Marking tags	Print			
	DEK	Standard	DEK 6	see "Accessories"
	DEK 6	see "Accessories"	DEK 6	see "Accessories"
	DEK 6	see "Accessories"	DEK 6	see "Accessories"
	DEK 6	see "Accessories"	DEK 6	see "Accessories"

* Insulation sleeves are to be used for tab connections to maintain the rated voltage.

Feed-through terminals for TS 15

AL 1



6.5/32/21
400 V/16 A/1 mm ²
6 kV/3
0.5...1
0.5...1
24
24
150 V/10 A/24...16 AWG
TS 15 Cat. No. Qty. 0137320000 100
Type Cat. No. Qty.
AP (1.5) 0294420000 20
AP (1.5) 0294460000 20
AP (1.5) 0294480000 20
EP (1.0) 0164100000 100
EP (1.0) 0164500000 100
TW (0.5) 0166800000 50
TSch 4 0363360000 100
Q 2 0368200000 50
Q 3 0368300000 50
Q 4 0368400000 50
Q 10 0368500000 20
VL 2 0446700000 50
VH 10 0446600000 50
BSM 2.5 x 14 0266800000 100
StB 8.5 0215700000 50
PS 2.3 0180400000 20
AD 4 0303400000 50
BSKM 25x18 0303300000 100
DEK 6.5 see "Accessories"

AKZ 1.5 L



5/34.5/25
7 mm / M 2.5 / 3.0 x 0.5
250 V/16 A/1.5 mm ²
4 kV/3
0.4...0.7
1
0.5...2.5
1.5
0.5...1.5
0.5...1.5
0.5...1.5
0.2...2.5 / A 1
24
24
150 V/10 A/24...16 AWG
TS 15 Cat. No. Qty. 0340160000 100
Type Cat. No. Qty.
AP (1.5) 0294420000 20
AP (1.5) 0294460000 20
AP (1.5) 0294480000 20
EP (1.0) 0164100000 100
EP (1.0) 0164500000 100
TW (0.5) 0166800000 50
TSch 4 0363360000 100
Q 2 0368200000 50
Q 3 0368300000 50
Q 4 0368400000 50
Q 10 0368500000 20
VL 2 0446700000 50
VH 10 0446600000 50
BSM 2.5 x 14 0266800000 100
StB 8.5 0215700000 50
PS 2.3 0180400000 20
AD 4 0303400000 50
BSKM 25x18 0303300000 100
DEK 5 see "Accessories"

AKZ 4 L



6/35.5/30
9 mm / M 3 / 3.5 x 0.6
250 V/16 A/4/1.5 mm ²
4 kV/3
0.5...1.0
2
0.5...4
1.5...4
0.5...4
0.5...4
0.5...4
0.2...4.0 / A 3
20
20
300 V/20 A/22...12 AWG
300 V/10 A/24...12 AWG
TS 15 Cat. No. Qty. 0334820000 100
0334860000 100
Type Cat. No. Qty.
AP (1.5) 0294420000 20
AP (1.5) 0294460000 20
AP (1.5) 0294480000 20
TW (0.5) 0348260000 50
TSch 4 0363360000 100
Q 2 0336400000 50
Q 3 0336500000 50
Q 4 0336600000 50
Q 10 0368600000 20
VL 2 0446700000 50
VH 10 0446600000 50
BSM 2.5 x 14 0266800000 100
StB 8.5 0215700000 50
PS 2.3 0180400000 20
AD 4 0303400000 50
BSKM 25x18 0303300000 100
DEK 6 see "Accessories"

AKZ 4 LL



6/44/30
250 V/16 A/1.5 mm ²
4 kV/3
0.5...1.5
1.5
0.5...1.5
0.2...2.5 / -
20
20
300 V/20 A/22...12 AWG
300 V/10 A/24...12 AWG
TS 15 Cat. No. Qty. 0346460000 100
Type Cat. No. Qty.
AP (1.5) 0294460000 20
TW (0.5) 0348260000 50
TSch 4 0363360000 100
Q 2 0336400000 50
Q 3 0336500000 50
Q 4 0336600000 50
Q 10 0368600000 20
VL 2 0446700000 50
VH 10 0446600000 50
BSM 2.5 x 14 0266800000 100
StB 8.5 0215700000 50
PS 2.3 0180400000 20
AD 4 0303400000 50
BSKM 25x18 0303300000 100
DEK 6 see "Accessories"

Feed-through terminals for TS 15

Solder connection
Spring-clip connection
 acc. to DIN 41611 Part 4
Wrap connection
 acc. to DIN/IEC 352 Part 1

AKZ 1.5 T



AKZ 1.5 T



* 035786 = 45 mm

AKZ 1.5 T



AKZ 2.5 K



Dimensions/approvals		UL	UL	UL	UL									
Width/length/height (mm)	with TS 15	5/25/45	5/25/39.5	5/28/44	5/26/46.7									
Pin size		0.8 x 1.6	1 x 1	0.8 x 1.6	0.8 x 1.6									
Insulation stripping length/clamping screw/screwdriver blade		7 mm/M 2.5/3.0 x 0.5	7 mm/M 2.5/3.0 x 0.5	7 mm/M 2.5/3.0 x 0.5	7 mm/M 2.5/3.0 x 0.5									
Rated data														
Rated voltage/current/cross-section		125 V/8 A/1.5 mm ²	125 V/8 A/1.5 mm ²	125 V/8 A/1.5 mm ²	125 V/10 A/2.5 mm ²									
Rated impulse voltage VDE 0110/1.89/pollution severity		2.5 kV/3	2.5 kV/3	2.5 kV/3	2.5 kV/3									
Further technical data														
Tightening torque range	Nm	0.4...0.7	0.4...0.7	0.4...0.7	0.4...0.6									
Torque setting with electric screwdriver type DMS 2		1	1	1	1									
Clampable conductor														
Solid H07V-U	mm ²	0.5...2.5	0.5...2.5	0.5...2.5	0.5...4									
Stranded H07V-R	mm ²	1.5	1.5	1.5	1.5...2.5									
Flexible H07V-K	mm ²	0.5...1.5	0.5...1.5	0.5...1.5	0.5...2.5									
Flexible H07V-K and ferrule DIN 46 228/1	mm ²	0.5...1.5	0.5...1.5	0.5...1.5	0.5...2.5									
Flexible H07V-K and ferrule with plastic insul. collar	mm ²	0.5...1.5	0.5...1.5	0.5...1.5	0.5...2.5									
Max. clamping range in mm ² /plug gauge acc. to IEC 60 947-1	Size	0.13...2.5 / A1	0.13...2.5 / A1	0.13...2.5 / A1	0.13...4.0 / A3									
Continuous current rating of cross-connection 2-pole	A	24	24	24	24									
Continuous current rating of cross-connection multipole	A	24	24	24	24									
Rated data according to UL/CSA														
Voltage/current/conductor size	UL	300 V/10 A/26...14 AWG	300 V/10 A/26...14 AWG	300 V/10 A/26...14 AWG	300 V/10 A/26...14 AWG									
Voltage/current/conductor size	CSA	300 V/10 A/24...16 AWG	300 V/10 A/24...16 AWG	300 V/10 A/24...16 AWG	300 V/10 A/26...10 AWG									
Ordering data		Pin versions			Pin versions			Pin versions						
	0.6 x 0.6	Type	Cat. No.	Qty.	Type	Cat. No.	Qty.	Type	Cat. No.	Qty.				
	1.0 x 1.0	AKZ 1.5 T	0442560000	100	AKZ 1.5 T	0483660000	100	AKZ 1.5 T	0400460000	100				
	0.8 x 1.6 horizont.	AKZ 1.5 T	0357960000	100	AKZ 1.5 T	0357860000	100	AKZ 1.5 T	0400360000	100				
	0.8 x 1.6 vertical	AKZ 1.5 W	0329460000	100										
	0.8 x 2.4 horizontal													
0.8 x 2.4 vertical														
Mounting, horizontal	Mounting, vertical													
End plate (thickness mm)		PA	AP (1.5)	0340560000	50	AP (1.5)	0340560000	50	AP (1.5)	0340560000	50	AP (2.5)	0697260000	50
Partition (thickness mm)		PA										TW (1.5)	0318560000	20
Small partition														
Cross-connection														
	2-pole	Q 2	0368200000	50	Q 2	0368200000	50	Q 2	0368200000	50	Q 2	0368200000	50	
	3-pole	Q 3	0368300000	50	Q 3	0368300000	50	Q 3	0368300000	50	Q 3	0368300000	50	
	4-pole	Q 4	0368400000	50	Q 4	0368400000	50	Q 4	0368400000	50	Q 4	0368400000	50	
	10-pole	Q 10	0368500000	20	Q 10	0368500000	20	Q 10	0368500000	20	Q 10	0368500000	20	
Switchable cross-connection link														
	VL													
	BS													
	VH													
Test plug/socket														
	StB	Plug test socket ø 2.3	StB 8.5	0215700000	50	StB 8.5	0215700000	50	StB 8.5	0215700000	50	StB 8.5	0215700000	50
	PS		PS 2.3	0180400000	20	PS 2.3	0180400000	20	PS 2.3	0180400000	20	PS 2.3	0180400000	20
Marking tags		Print												
	DEK	Standard	DEK 5	see "Accessories"	DEK 5	see "Accessories"	DEK 5	see "Accessories"	DEK 5	see "Accessories"	DEK 5	see "Accessories"	DEK 5	see "Accessories"
Mounting rails, end brackets, further marking material see "Accessories"														

Feed-through terminals for TS 15

AKZ 2.5 K



AKZ 2.5 K



AKZ 4 T



AKZ 4 T



AKZ 4 T



AKZ 4 ST



AKZ 2.5 K			AKZ 2.5 K			AKZ 4 T			AKZ 4 T			AKZ 4 T			AKZ 4 ST		
5/26/46.7			5/47.5/27			6/27/48.5			6/27/50.5			6/27/57.8			6/27/50.2		
0.8 x 1.6			0.8 x 1.6			1 x 1			0.8 x 1.6			0.8 x 2.4			0.8 x 1.6		
7 mm/M 2.5/3.0 x 0.5			7 mm/M 2.5/3.0 x 0.5			9 mm/M 3/3.5 x 0.6			9 mm/M 3/3.5 x 0.6			9 mm/M 3/3.5 x 0.6			-		
250 V/8 A/2.5 mm ²			250 V/8 A/2.5 mm ²			250 V/10 A/4 mm ²			250 V/10 A/4 mm ²			250 V/10 A/4 mm ²			250 V/10 A/2.5 mm ²		
4 kV/3			4 kV/3			4 kV/3			4 kV/3			4 kV/3			4 kV/3		
0.4...0.6			0.4...0.6			0.5...1.0			0.5...1.0			0.5...1.0					
1			1			2			2			2					
0.5...4			0.5...4			0.5...4			0.5...4			0.5...4					
1.5...2.5			1.5...2.5			1.5...4			1.5...4			1.5...4					
0.5...2.5			0.5...2.5			0.5...4			0.5...4			0.5...4					
0.5...2.5			0.5...2.5			0.5...4			0.5...4			0.5...4					
0.5...2.5			0.5...2.5			0.5...4			0.5...4			0.5...4					
0.13...4.0 / A3			0.13...4.0 / A3			0.13...4.0 / A3			0.13...4.0 / A3			0.13...4.0 / A3			0.5...2.5 / -		
24			24			20			20			20			20		
24			24			20			20			20			20		
300 V/10 A/26...14 AWG			300 V/10 A/26...14 AWG			300 V/10 A/26...14 AWG			300 V/10 A/26...14 AWG			300 V/10 A/26...14 AWG			300 V/10 A/26...14 AWG		
300 V/10 A/26...10 AWG			300 V/10 A/26...10 AWG			300 V/10 A/24...12 AWG			300 V/10 A/24...12 AWG			300 V/10 A/24...12 AWG			300 V/10 A/24...12 AWG		
Type	Cat. No.	Qty.	Type	Cat. No.	Qty.	Type	Cat. No.	Qty.	Type	Cat. No.	Qty.	Type	Cat. No.	Qty.	Type	Cat. No.	Qty.
AKZ 2.5 K	0695460000	100	AKZ 2.5 K	0695960000	100	AKZ 4 T	0445860000	100	AKZ 4 T	0344160000	100				AKZ 4 ST	0439260000	100
AKZ 2.5 K	0695660000	100	AKZ 2.5 K	0696160000	100				AKZ 4 T	0344060000	100						
												AKZ 4 T	0366460000	100			
												AKZ 4 T	0461660000	100			
AP (2.5)	0697260000	50	AP (2.5)	0697260000	50	AP (1.5)	0294460000	20	AP (1.5)	0294460000	20	AP (1.5)	0294460000	20	AP (1.5)	0294460000	20
TW (1.5)	0318560000	20	TW (1.5)	0318560000	20	TW (1.5)	0348260000	50	TW (1.5)	0348260000	50	TW (1.5)	0348260000	50	TW (1.5)	0348260000	50
						TSch 4	0363360000	100	TSch 4	0363360000	100	TSch 4	0363360000	100			
Q 2	0368200000	50	Q 2	0368200000	50	Q 2	0336400000	50	Q 2	0336400000	50	Q 2	0336400000	50	Q 2	0369000000	50
Q 3	0368300000	50	Q 3	0368300000	50	Q 3	0336500000	50	Q 3	0336500000	50	Q 3	0336500000	50	Q 3	0369100000	50
Q 4	0368400000	50	Q 4	0368400000	50	Q 4	0336600000	50	Q 4	0336600000	50	Q 4	0336600000	50	Q 4	0369200000	50
Q 10	0368500000	20	Q 10	0368500000	20	Q 10	0368600000	20	Q 10	0368600000	20	Q 10	0368600000	20	Q 10	0369300000	20
						VL 2	0446700000	50	VL 2	0446700000	50	VL 2	0446700000	50			
						VH 10	0446600000	50	VH 10	0446600000	50	VH 10	0446600000	50			
						BSM 2.5x14	0266800000	100	BSM 2.5x14	0266800000	100	BSM 2.5x14	0266800000	100			
StB 8.5	0215700000	50	StB 8.5	0215700000	50	StB 8.5	0215700000	50	StB 8.5	0215700000	50	StB 8.5	0215700000	50	StB 8.5	0215700000	50
PS 2.3	0180400000	20	PS 2.3	0180400000	20	PS 2.3	0180400000	20	PS 2.3	0180400000	20	PS 2.3	0180400000	20	PS 2.3	0180400000	20
DEK 5	see "Accessories"		DEK 5	see "Accessories"		DEK 6	see "Accessories"		DEK 6	see "Accessories"		DEK 6	see "Accessories"		DEK 6	see "Accessories"	

SAK-series

Feed-through terminals for TS 15

for temperature measuring circuits

AKZ 4/TC



Weidmüller's thermocouple terminals are specially designed for transmitting the smallest voltages in temperature measuring circuits. Special busbars ensure that no false signals occur in the terminal when temperature differences exist in the positive and negative path. This high measuring precision is necessary for, e.g. test beds for aircraft engines, for complicated chemical processes, control systems, etc.

- Busbar material corresponds to thermal and compensating conductors
- Clear thermocouple marking
- 2-pole blocks per thermocouple
- Row width 14 mm, incl. end plate

Configuration of a temperature measuring circuit

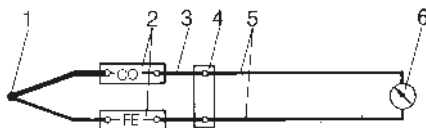

- 1 Thermocouple (sensor)
- 2 Thermocouple terminals
- 3 Compensating conductor
- 4 Reference point
- 5 Supply conductors (to and from)
- 6 Measuring device

The thermocouple terminals displayed in this measurement circuit are used to thermo-electrically transmit thermal e.m.f. of the thermocouple to the reference point and indicating device. Thermocouple terminals are required for the construction of temperature measuring circuits.

Dimensions		
Width/length/height (mm)	with TS 15	14/27/30
Insulation stripping length/clamping screw/screwdriver blade		9 mm/M 3/3.5 x 0.6
Rated data		
Rated voltage/current/cross-section		-/~/4 mm ²
Further technical data		
Tightening torque range	Nm	0.5...1
Torque setting with electric screwdriver type DMS 2		2
Clampable conductor		
Solid H07V-U	mm ²	0.5...4
Stranded H07V-R	mm ²	1.5...4
Flexible H07V-K	mm ²	0.5...4
Flexible H07V-K and ferrule DIN 46 228/1	mm ²	0.5...2.5
Flexible H07V-K and ferrule with plastic insul. collar	mm ²	0.5...2.5
Plug gauge acc. to IEC 60 947-1	Size	A 3
Continuous current of terminal for conductor size		
Continuous current rating of cross-connection 2-pole	A	
Continuous current rating of cross-connection multipole	A	
Ordering data		
Version		TS 15
for thermocouples	Type J	Cat. No.
Acc. to IEC 584	Type T	Qty.
(DIN 43710)	Type K	1627010000 20
	Type E	on demand
		1677130000 20
		on demand

End plate		Cat. No.	Qty.
AP (thickness 1.5 mm)	PA	0294460000	20
Partition		Cat. No.	Qty.
TW (thickness 0.5 mm)	PA	0348260000	50

Thermocouple, type J	
Thermocouple acc. to IEC 584 (DIN 43 710)	Busbar
	Constantan (CuNi)
	Iron (Fe)



Marking tags		Print
1	2	Material VO
3	4	
5	6	

DEK 5/6	1789590000 500
---------	-----------------------

Mounting rails, end brackets, further marking material see "Accessories"

Multipole terminal blocks

Screw/tab connection

MK 5/2

KS 2...10

BK 2...12

MK 6/2...6/6

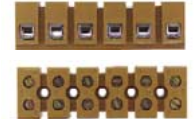

Dimensions/approvals

Width/length/height (mm)	40/18/15.5	see table below	see table below	see table below
--------------------------	------------	-----------------	-----------------	-----------------

Insulation stripping length/clamping screw/screwdriver blade	5 mm/M 2.5/3.5 x 0.6	8 mm/M 3/4.0 x 0.8	8 mm/M 3/4.0 x 0.8	9 mm/M 4/4.0 x 0.8
--	----------------------	--------------------	--------------------	--------------------

Rated data according to IEC 60 947-7-1

Rated voltage/current/cross-section	500 V/24 A/2.5 mm ²	500 V/24 A/2.5 mm ²	400 V/32 A/4 mm ²	690 V/41 A/6 mm ²
Rated impulse voltage VDE 0110/1.89/pollution severity	6 kV/3	6 kV/3	6 kV/3	8 kV/3

Further technical data

Tightening torque range	Nm 0.4...0.45	0.5...0.7	0.5...0.7	1.2...2.0
Torque setting with electric screwdriver type DMS 2	1	2	2	4

Clampable conductor

Solid H07V-U	mm ² 0.5...4	0.5...4	0.5...4	0.5...6
Stranded H07V-R	mm ² 1.5...2.5	1.5...2.5	1.5...4	1.5...6
Flexible H07V-K	mm ² 0.5...2.5	0.5...2.5	0.5...4	0.5...6
Flexible H07V-K and ferrule DIN 46 228/1	mm ² 0.5...1.5	0.5...1.5	0.5...4	0.5...4
Flexible H07V-K and ferrule with plastic insul. collar	mm ² 0.5...1.5	0.5...1.2	0.5...4	0.5...4
Max. clamping range in mm ² /plug gauge acc. to IEC 60 947-1	Size 0.2...4.0 / A 2	0.2...4.0 / A 2	0.33...4.0 / A 3	0.33...6.0 / A 3

Rated data according to UL/CSA

Voltage/current/conductor size	UL	300 V/20 A/22...12 AWG	300 V/10 A/22...12 AWG	300 V/30 A/22...10 AWG
Voltage/current/conductor size	CSA	300 V/25 A/24...12 AWG	300 V/10 A/22...12 AWG	300 V/40 A/22...10 AWG

Ordering data

Versions

Type	Cat. No.	Qty.	Type	Cat. No.	Qty.	Type	Cat. No.	Qty.	Type	Cat. No.	Qty.	
2-pole	MK 5/2 KrG	0243820000	100	KS 2 KrG ²⁾	0134420000	100	BK 2 KrG	0624720000	50	MK 6/2 KrG	0620420000	50
3-pole				KS 4 KrG ²⁾	0140320000	50	BK 3 KrG	0624920000	50	MK 6/3 KrG	0620320000	50
4-pole							BK 4 KrG	0625120000	50	MK 6/4 KrG	0620220000	20
4-pole												
6-pole				KS 6 KrG ²⁾	0140620000	50	BK 6 KrG	0625220000	50	MK 6/6 KrG	0620120000	20
6-pole												
8-pole												
8-pole												
10-pole				KS 10 KrG ²⁾	0141620000	20						
12-pole	Cover			Cover			BK 12 KrG	0625320000	50			
12-pole	D2 (for MK 5/2)	0244060000	50	D 2 (for KS 2)	0134500000	100						
				D 4 (for KS 4)	0140500000	50						
				D 6 (for KS 6)	0140800000	50						
				D 10 (for KS 10)	0141800000	20						



Cover D 2
(for MK 5/2)



Cover D 4
(for KS 4)

Cover

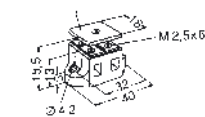

Marking tag cover

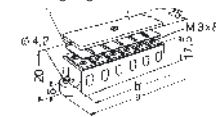

Dimensions

Type	a	b
KS 2	42	32
KS 4	66	56
KS 6	90	80
KS 10	138	128

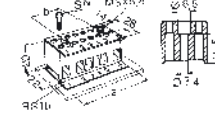

Dimensions

Type	a	b
BK 2	20	-
BK 3	31	11
BK 4	38	18
BK 6	52	32
BK 12	92	72.5

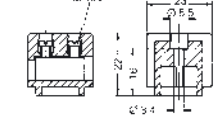

Dimens. Length/attach.dim.

Type	KRG
MK 6/2	23.5
MK 6/3	36.5
MK 6/4	49.5
MK 6/6	75.5

Expansion rivet

Marking strips

printed
1 ...

unprinted

ELSb 2	0143200000	50
ELSb 4	0143300000	50
ELSb 6	0143400000	50
ELSb 10	0143500000	50
ELSo 2	0142800000	50
ELSo 4	0142900000	50
ELSo 6	0143000000	50
ELSo 10	0143100000	50

BSTb 2B/2	0203600000	50
BSTb 2B/3	0203800000	50
BSTb 2B/4	0197300000	50
BSTb 2B/6	0197500000	50
BSTb 2B/12	0198800000	50
BSTo 2B/2	0203500000	50
BSTo 2B/3	0203700000	50
BSTo 2B/4	0197200000	50
BSTo 2B/6	0197400000	50
BSTo 2B/12	0198700000	50

BSTb 17/6 0304600000 50

Mounting rails, end brackets, further marking material see "Accessories"

1) Projecting length = 1 mm. To be considered for the last terminal in a row!
Printed on top on request

2) Please order cover and marking strips separately.

Multipole terminal blocks

MF 1/6...1/12

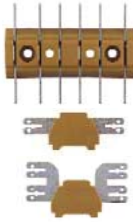

UL see below

SLS 2/2



SLS 2/4

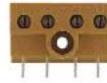

UL see below

Max. technical data

Dimensions/approvals

Width/length/height (mm)

Insulation stripping length/clamping screw/screwdriver blade

Rated data according to IEC 60 947-7-1

Rated voltage²⁾/current/cross-section

Rated impulse voltage VDE 0110/1.89/pollution severity

Further technical data

Tightening torque range

Nm

Torque setting with electric screwdriver type DMS 2

Clampable conductor

Solid H07V-U

mm²

Stranded H07V-R

mm²

Flexible H07V-K

mm²

Flexible H07V-K and ferrule DIN 46 228/1

mm²

Flexible H07V-K and ferrule with plastic insul. collar

mm²

Max. clamping range in mm²/plug gauge acc. to IEC 60 947-1 Size

Rated data according to UL/CSA

Voltage/current/conductor size

UL

Voltage/current/conductor size

CSA

Ordering data

PA

300 V/10 A/24...12 AWG

300 V/10 A/22...10 AWG

Type Cat. No. Qty.

MF 1/6 KrG²⁾ **0479720000** 100

MF 1/6 KrG³⁾ **0480020000** 100

MF 1/8 KrG²⁾ **0479820000** 50

MF 1/8 KrG³⁾ **0480120000** 50

MF 1/12 KrG²⁾ **0479920000** 50

MF 1/12 KrG³⁾ **0480220000** 50

8 mm/M 3.5/4.0 x 0.8

400 V²⁾/16 A/4 mm²

6 kV/3

0.8...1.6

3

0.5...4

1.5...4

0.5...4

0.5...4

0.33...4.0 / A 3

300 V/10 A/22...10 AWG

Type Cat. No. Qty.

SLS 2/2 KrG **0213420000** 100

SLS 2/4 KrG **0240420000** 50

SLS 2/4 KrG **0480320000** 50

Slotted



Dimensions

Type	a	b	c	d
MF 1/6	52	34	9.5	6.5
MF 1/8	68	50	9.5	6.5
MF 1/12 113 ^{+0.5}	102	8		7.5

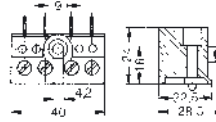
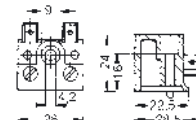

Expansion rivet/insulation sleeve

IH

IH 2.8 **0386060000** 100

IH 6.3 **0386260000** 100

SN **0200100000** 500

IH 2.8 **0386060000** 100

IH 6.3 **0386260000** 100

Cover/marking strips

BSTb 10/6 **0240900000** 50

BSTb 10/8 **0241100000** 50

BSTb 10/12 **0209500000** 50

BSTo 10/6 **0240800000** 50

BSTo 10/8 **0241000000** 50

BSTo 10/12 **0209400000** 100

Mounting rails, end brackets, further marking material see "Accessories"

²⁾ Insulation sleeves are to be used for tab connections to maintain the rated voltage.

²⁾ Single tab
³⁾ Double tab

Multipole terminal blocks

Screw, solder, tab connection

MKL 2/12

MF 2/12

MKL 3/12

MKL 4/16

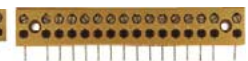

0241860000

0243620000

0262020000

0241760000

0249920000

0244320000

Dimensions/approvals

Width/length/height (mm)	88/23/15	75/24/6	110/23/16	103/24/16.5
--------------------------	----------	---------	-----------	-------------

Insulation stripping length/clamping screw/screwdriver blade

	5 mm/M 2.5/3.5 x 0.6	5 mm	5mm/M 2.5/3.5 x 0.6	5mm/M 2.5/3.5 x 0.6
--	----------------------	------	---------------------	---------------------

Rated data

Rated voltage*/current/cross-section	125 V/20 A/2.5/1.5/1 mm ²	63 V/17.5 A/1.5/1 mm ²	400 V*/20 A/2.5/1.5/1 mm ²	400 V/20 A/2.5/1.5/1 mm ²
Rated impulse voltage VDE 0110/1.89/pollution severity	2.5 kV/3	1.5 kV/3	6 kV/3	6 kV/3

Further technical data

Tightening torque range	Nm 0.4...0.45		0.4...0.45	0.4...0.45
Torque setting with electric screwdriver type DMS 2	1		1	1

Clampable conductor

Solid H07V-U	mm ² 0.5...2.5		0.5...4	0.5...4
Stranded H07V-R	mm ² 1.5...2.5		1.5...2.5	1.5...2.5
Flexible H07V-K	mm ² 0.5...2.5		0.5...2.5	0.5...2.5
Flexible H07V-K and ferrule DIN 46 228/1	mm ² 0.5...2.5		0.5...1.5	0.5...1.5
Flexible H07V-K and ferrule with plastic insul. collar	mm ² 0.5...2.5		0.5...1.5	0.5...1.5
Max. clamping range in mm ² /plug gauge acc. to IEC 60 947-1	Size 0.2...2.5 / A 2		0.33...4.0 / A 2	0.33...4.0 / A 2

Rated data according to UL/CSA

Voltage/current/conductor size	UL		300 V/25 A/22...12 AWG	300 V/25 A/22...12 AWG
Voltage/current/conductor size	CSA		300 V/25 A/22...12 AWG	150 V/15 A/22...12 AWG

Ordering data

	Versions	Type	Cat. No.	Qty.	Type	Cat. No.	Qty.	Type	Cat. No.	Qty.	Type	Cat. No.	Qty.
Horizontal	2-pole							MKL 3/2 KrG	0274920000**	100			
Other number of poles on demand	4-pole							MKL 3/4 KrG	0275120000**	100			
	6-pole							MKL 3/6 KrG	0275320000**	50			
	12-pole	MKL 2/12 PA	0241360000	50				MKL 3/12 KrG	0243620000**	20			
	16-pole										MKL 4/16 KrG	0262020000	20
Vertical	2-pole							MKL 3/2 KrG	0276020000*	100			
Other number of poles on demand	4-pole												
	6-pole							MKL 3/6 KrG	0276420000*	50			
	12-pole							MKL 3/12 KrG	0249920000*	20			
	16-pole										MKL 4/16 KrG	0244320000	20

double-sided 2.8 x 0.8
single-sided 0.8 x 1.6/2.8 x 0.8

MF 2/12 PA 0241860000 50
MF 2/12 PA 0241760000 50

* For terminals directly mounted next to each other, the rated voltage is reduced to 250 V.

** Rated voltage 250 V. For terminals directly mounted next to each other, the rated voltage is reduced to 125 V.

Expansion rivet/insulation sleeve

	SN	0200100000	500										
IH	IH 2.8	0386060000	100										

Marking strips

printed	1 ...	BSTb 28/12	0245700000	50				BSTb 28/4	0289800000	50	BSTb 28/16	0262200000	50
		bottom						BSTb 28/6	0290000000	50	bottom		
		top		0278500000	50			BSTb 28/12	0245900000	50	top		
unprinted		BSTo 28/12	0245600000	50				BSTo 28/4	0289300000	50	BSTo 28/16	0262100000	50
								BSTo 28/6	0289500000	50			
								BSTo 28/12	0245800000	50			

Mounting rails, end brackets, further marking material see "Accessories"

* Insulation sleeves are to be used for tab connections to maintain the rated voltage.

1) Rated voltage 250 V

Multipole terminal blocks

Screw, solder, tab
connection
Modular design

AKB 4

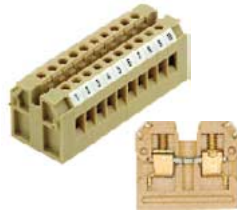

AKZ 2.5

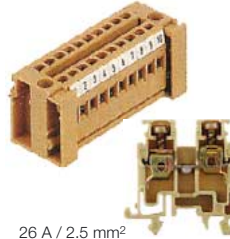

ASK 1



Max. technical data

Dimensions/approvals	AKB 4	AKZ 2.5	ASK 1
Width/length/height (mm)	6/27/23	5/25.5/26.5	8/58/30.5
Insulation stripping length/clamping screw/screwdriver blade	9 mm/M 3/3.5 x 0.6	7 mm/M 2.5/3 x 0.5	9 mm/M 3/3.5 x 0.6
Rated data according to IEC 60 947-7-1			
Rated voltage/current/cross-section	400 V/32 A/4 mm ²	250 V/24 A/2.5 mm ²	500 V/6.3 A/4 mm ²
Rated impulse voltage VDE 0110/1.89/pollution severity	6 kV/3	4 kV/3	6 kV/3
Further technical data			
Tightening torque range Nm	0.5...1.0	0.4...0.6	0.5...1.0
Torque setting with electric screwdriver type DMS 2	2	1	2
Clampable conductor			
Solid H07V-U mm ²	0.5...6	0.5...4	0.5...4
Stranded H07V-R mm ²	1.5...4	1.5...2.5	1.5...4
Flexible H07V-K mm ²	0.5...4	0.5...2.5	0.5...4
Flexible H07V-K and ferrule DIN 46 228/1 mm ²	0.5...4	0.5...2.5	0.5...2.5
Flexible H07V-K and ferrule with plastic insul. collar mm ²	0.5...4	0.5...2.5	0.5...2.5
Max. clamping range in mm ² /plug gauge acc. to IEC 60 947-1 Size	0.33...4.0 / A3	0.13...4.0 / A3	0.13...4.0 / A3
Continuous current rating of cross-connection 2-pole A	32	24	(QB 2...4) 10
Continuous current rating of cross-connection multipole A	32	24	
Rated data according to UL/CSA			
Voltage/current/conductor size UL	300/250 V/27 A/22...12 AWG	300 V/10 A/22...12 AWG	300 V/10 A/22...12 AWG
Voltage/current/conductor size CSA	300 V/10 A/22...12 AWG	300 V/10 A/26...10 AWG	300 V/6.3 A/26...12 AWG
Ordering data	Type Cat. No. Qty.	Type Cat. No. Qty.	Type Cat. No. Qty.
PA	AKB 4 PA 0321560000 100	AKZ 2.5 0697160000 100	ASK 1 PA 0376960000 100
Blue PA	0321580000 100	AKZ 2.5 0697180000 100	
Direct mounting with BB 1 please order separately		Direct mounting with BB 4 please order separately	(for G fuse inserts 5x 20 without indicator)
End plate/attachment bracket (thickness mm)			
AP	BB 1 (7) 0320560000 50	BB 4 (7.5) 0697560000 50	
Blue PA	BS M 3 x 15 0359000000 100		
		AP (2.5) 0697360000 50	AP (1.5) 0380360000 20
		AP (2.5) 0697380000 50	
Partition (thickness mm)			
	TW PA (0.5) 0348260000 50		
Small partition			
	TSch 4 0363360000 100		
Cross-connection			
Q 3 QB 4	Q 2 0336400000 50	Q 2 0368200000 50	QB 2 ¹⁾ 0461100000 50
	Q 3 0336500000 50	Q 3 0368300000 50	QB 3 ¹⁾ 0461200000 50
	Q 4 0336600000 50	Q 4 0368400000 50	QB 4 ¹⁾ 0461300000 50
	Q 10 0368600000 20	Q 10 0368500000 20	
Switchable cross-connection link			
VL BS VH	VL 2 0446700000 50		
	VH 10 0446600000 50		
	BS M 2.5x14 0266800000 100		
Test plug/socket			
PS StB	StB 8.5 0215700000 50	StB 8.5 0215700000 50	
	PS 2.3 0180400000 20	PS 2.3 0180400000 20	
Cover/contact sleeve			
K sleeve	AD 4 0303400000 50		
	BSKM2.5x18 0303300000 100		K sleeve 0553300000 100
Marking tags	Print		
DEK Standard	DEK 6 see "Accessories"	DEK 5 see "Accessories"	DEK 6.5 see "Accessories"
1 2 3 4 5 6			
Mounting rails, end brackets, further marking material see "Accessories"			

¹⁾ The conductor cross-section is reduced to max. 2.5 mm² when QB is used.

* With contact sleeve 19 A

Feed-through terminals

Screw connection
Solder connection
Tab connection
Spring-clip connection
 acc. to DIN 41 611 Part 4
Wrap connection
 acc. to DIN/IEC 352 Part 1

AKA 2.5



ADK 1



ADK 1 F ADK 3 F



ADK 1 S



Dimensions/approvals		UL ®	UL ®	UL ®	UL ®
Width/length/height with Pins (mm)		6/20/31	6/22/36.5	6/22/36.5	6/22/36.5
Length solder tag/pin (mm)		7,8	8,4	8,5/7,5	8,4
Insulation stripping length/clamping screw/screwdriver blade		9 mm/M 2.5/3.5 x 0.6	9 mm/M 3.5/3.5 x 0.6	11 mm/M 2.5/3.5 x 0.6	-
Rated data					
Rated voltage*/current/cross-section		400 V/20 A/2.5/1.5 mm ²	400 V/16 A/4/1.5 mm ²	400 V/20 A/2.5/1.5 mm ²	400 V/16 A/2.5/1.5/1 mm ²
Rated impulse voltage VDE 0110/1.89/pollution severity		6 kV/3	6 kV/3	6 kV/3	6 kV/3
Further technical data					
Tightening torque range Nm		0.4	0.5...1.0	0.4...0.6	-
Torque setting with electric screwdriver type DMS 2		1	2	1	-
Clampable conductor					
Solid H07V-U mm ²		0.5...2.5	0.5...4	0.5...2.5	
Stranded H07V-R mm ²		1.5...2.5	1.5...4	1.5...2.5	
Flexible H07V-K mm ²		0.5...2.5	0.5...4	0.5...2.5	
Flexible H07V-K and ferrule DIN 46 228/1 mm ²		0.5...1.5	0.5...2.5	0.5...1.5	
Flexible H07V-K and ferrule with plastic insul. collar mm ²		0.5...1.5	0.5...2.5	0.5...1.5	
Max. clamping range in mm ² /plug gauge acc. to IEC 60 947-1 Size		0.13...2.5 / A2	0.13...2.5 / A3	0.13...2.5 / A2	0.5...2.5 / -
Continuous current rating of cross-connection 2-pole A					
Continuous current rating of cross-connection multipole A		10	10		
Rated data according to UL/CSA					
Voltage/current/conductor size UL		300 V/20 A/26...12 AWG	300 V/10 A/26...12 AWG	300 V/20 A/26...14 AWG	300 V/18 A/12 AWG max.
Voltage/current/conductor size CSA		300 V/10 A/24...12 AWG	300 V/15 A/26...12 AWG	300 V/15 A/22...14 AWG	300 V/3 A/-
Ordering data					
Version for plate thckn. mm		Cat. No. 1.5 Qty.	1.5 Qty. 2.5 Qty.	1.5 Qty. 2.5 Qty.	1.5 Qty. 2.5 Qty.
PA					
KrG		0300720000 100	0303860000 100 0301060000 100	0476060000 100 0478660000 100	
Pin 1.0x1.0					
Pin 0.8x1.6					
FS 1x6.3 slotted/0.8x2.8					0476160000 100 0478560000 100
12-pole PA					
End plate (thickness mm)		Type Cat. No. Qty.	Type Cat. No. Qty.	Type Cat. No. Qty.	Type Cat. No. Qty.
KrG		AP (3) 0162520000 100			
PA			AP (3) 0476260000 50	AP (3) 0476260000 50	AP (3) 0476260000 50
EP				AP (3) 0360000000 20	
Spacer (thickness mm)					
KrG		ZP (1.5) 0240720000 50			
KrG		ZP (2.5) 0288520000 20			
Partition (thickness mm)					
TW			TW (0.5) 0442300000 50	TW (0.5) 0442300000 50	TW (0.5) 0442300000 50
Test plug/socket					
StB Plug test socket ø 2.3			PS 2.3 0180400000 20		
PS					
Fuse pin/insulation sleeve/expansion rivet					
SST 1.2		0306600000	SST 1.2 0306600000	SST 1.2 0306600000	SST 1.2 030660
IH			IH 2.8 0386060000 100	IH 2.8 0386060000 100	IH 2.8 0386060000 100
					IH 6.3 0386260000 100
Marking tags					
Print					
1 2 3 4 5 6 DEK Standard		DEK 6 see "Accessories"	DEK 6 see "Accessories"	DEK 6 see "Accessories"	DEK 6 see "Accessories"
Mounting rails, end brackets, further marking material see "Accessories"					

* Insulation sleeves are to be used for tab connections to maintain the rated voltage.

Feed-through terminals

ADK 1 T



6/22/50.5
19.5...21.9
9 mm/M 3/3.5 x 0.6
400 V/8 A/4 mm ²
6 kV/3
0.5...1.0
2
0.5...4
1.5...4
0.5...4
0.5...2.5
0.5...2.5
0.13...4.0 / A3
10
300/250 V/10 A/26...12 AWG
300 V/15 A/26...12 AWG
1.5 Qty. 2.5 Qty.
0372260000 100
0366360000 100

Type	Cat. No.	Qty.
AP (3)	0476260000	50

TW (0.5)	0442300000	50
----------	-------------------	----

PS 2.3	0180400000	20
--------	-------------------	----

SST 1.2	0306600000	
---------	-------------------	--

DEK 6	see "Accessories"	
-------	-------------------	--

AKZ 2.5 K

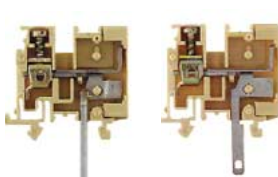

0109160000 solder tag

5/26/45.5
22.4...23.6
7 mm/M 2.5/3.0 x 0.5
250 V/8 A/2.5 mm ²
4 kV/3
0.4...0.6
1
0.5...2.5
1.5...2.5
0.5...2.5
0.5...2.5
0.5...2.5
0.13...2.5 / A2
10
300/250 V/10 A/22...12 AWG
300 V/10 A/26...10 AWG
Cat. No. Qty.
0109160000 solder tag 100
0108960000 100

Type	Cat. No.	Qty.
AP (3)	0697260000	50

TW (1.5)	0318560000	20
----------	-------------------	----

PS 2.3	0180400000	20
StB 8.5	0215700000	50

IH 2.8	0386060000	100
--------	-------------------	-----

DEK 5	see "Accessories"	
-------	-------------------	--

ADK 1 FT



6/22/52
24
11 mm/M 2.5/3.5 x 0.6
250 V/10 A/2.5 mm ²
4 kV/3
0.4...0.6
1
0.5...2.5
1.5...2.5
0.5...2.5
0.5...1.5
0.5...1.5
0.33...2.5 / A2
10
300 V/3 A/22...14 AWG
Cat. No. 1.5 Qty.
0176960000 100

Type	Cat. No.	Qty.
AP (3)	0476260000	50

TW (0.5)	0442300000	50
----------	-------------------	----

SST 1.2	0306600000	
---------	-------------------	--

DEK 6	see "Accessories"	
-------	-------------------	--

MK 2/12

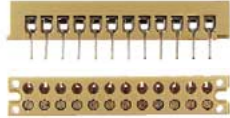

86/15/23
8
5
63 V/20 A/2.5/1.5 mm ²
1.5 kV/3
0.4...0.45
1
0.5...2.5
1.5...2.5
0.5...2.5
0.5...2.5
0.5...2.5
0.2...2.5 / A2
10
300 V/10 A/24...12 AWG
300 V/10 A/24...12 AWG
Cat. No. Qty.
0241460000 50

Type	Cat. No.	Qty.
AP (3)	0476260000	50

TW (0.5)	0442300000	50
----------	-------------------	----

SN	0200100000	500
----	-------------------	-----

BSTb 28/12	024570...	50
BSTo 28/12	024560...	50

Rack-mounted interface systems

TOP 1.5 F/32



SP 10 FF²⁾ SP 10 LF³⁾



SP 60 FF²⁾ SP 60 LF³⁾



SP 90 FF²⁾ SP 90 LF³⁾

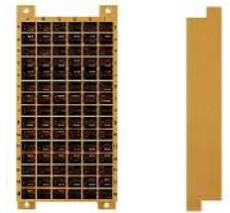

Dimensions		TOP 1.5 F/32	SP 10 FF ²⁾ SP 10 LF ³⁾	SP 60 FF ²⁾ SP 60 LF ³⁾	SP 90 FF ²⁾ SP 90 LF ³⁾									
Width/length/height (mm)		40.2/110.6/29.5	42/46.5/170/28	40/45.5/162.5/110	40/45.5/228.5/110									
Hole spacing/mounting dimensions	mm	101.6/20.3	147	151/90	217/90									
Insulation stripping length/clamping screw/screwdriver blade		10 mm/M 2.5/3.5 x 0.6												
Rated data														
Rated voltage*/current/cross-section		250* V/6 A/1.5/1 mm ²	1000* V/16 A/2.5/1.5 mm ²	400* V/16 A/2.5/1.5 mm ²	400* V/16 A/2.5/1.5 mm ²									
Rated impulse voltage VDE 0110/1.89/pollution severity		4 kV/3	6 kV/3	6 kV/3	6 kV/3									
Further technical data														
Tightening torque range	Nm	0.4...0.7												
Torque setting with electric screwdriver type DMS 2		1												
Clampable conductor														
Solid H07V-U	mm ²	0.5...2.5												
Stranded H07V-R	mm ²	1.5												
Flexible H07V-K	mm ²	0.5...1.5												
Flexible H07V-K and ferrule DIN 46 228/1	mm ²	0.5...1.5												
Flexible H07V-K and ferrule with plastic insul. collar	mm ²	0.5...1.5												
Plug gauge acc. to IEC 60 947-1	Size	A1												
Ordering data		Version	Type	Cat. No.	Qty.	Type	Cat. No.	Qty.	Type	Cat. No.	Qty.	Type	Cat. No.	Qty.
Pin 1.0 x 1.0		PA	TOP1.5F/32	0443160000 ¹⁾	5									
Pin 0.8 x 2.8 (push-on), unprinted		PA												
Pin 0.8 x 2.8 (push-on), printed, 1...32		PA												
Pin 0.8 x 2.8 (push-on), printed, 1...32, blue		PA												
6 x plug (6.3 x 0.8)		KrG				SP 10 FF	0456220000	10	SP 60 FF ⁴⁾	0340320000	1	SP 90 FF**	0248120000	1
6 x plug (6.3 x 0.8), blue		KrG							SP 60 FF ⁴⁾	0340370000	1			
6 x plug (6.3 x 0.8), bzw. 12 x 2.8 x 0.8 slotted		KrG										SP 90 FF**	0608920000	1
6 x plug (6.3 x 0.8), bzw. 12 x 2.8 x 0.8 slotted, blue		KrG												
3 x plug (6.3 x 0.8) / 1 x solder per pole		KrG							SP 60 LF ⁴⁾	0343720000	1	SP 90 LF**	0248220000	1
3 x plug (6.3 x 0.8) / 1 x solder per pole, blue		KrG							SP 60 LF ⁴⁾	0343770000	1			
3 x plug (6.3 x 0.8 bzw. 6 x 2.8 x 0.8) / 1 x solder		KrG							SP 60 LF ⁵⁾	0124520000	1			
3 x plug (6.3 x 0.8 bzw. 6 x 2.8 x 0.8) / 1 x solder, blue		KrG							SP 60 LF ⁵⁾	0124570000	1			
2 x direct connection, 1 x Pin 0.8 x 1.6		PA										printed:		
												** A...F / 1...15		
									printed:					
									⁴⁾ A...F / 1...10					
									⁵⁾ 00...50 / 1...10					
Insulation sleeves		Type	Cat. No.	Qty.	Type	Cat. No.	Qty.	Type	Cat. No.	Qty.	Type	Cat. No.	Qty.	
		IH 2.8	0386060000	100	IH 2.8	0386060000	100	IH 2.8	0386060000	100	IH 2.8	0386060000	100	
					IH 6.3	0386260000	100	IH 6.3	0386260000	100	IH 6.3	0386260000	100	
Marking tags		Print												
dekafix		for group markers			FW 5	see "Accessories"								
Mounting rails, end brackets, further marking material see "Accessories"														

* Insulation sleeves are to be used for tab connections to maintain the rated voltage.

¹⁾ Rated voltage 125 V

²⁾ FF = Tab-Tab
³⁾ LF = Solder-Tab

Rack-mounted interface systems

RV 8/8 long



RV 8/8 short



RV 8/9 long

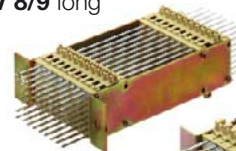

RV 8/9 short



Technical data acc. to VDE

Pin versions (intern)

0.8 x 2.4/1 x 1
0.8 x 2.4/0.8 x 2.4

Plug adapter



1-pole

for connection of solid and flexible conductors from 0.75 to 1.5 mm² directly on to the pins of the interface system.

125 V/-/-			125 V/-/-		
Type	Cat. No.	Qty.	Type	Cat. No.	Qty.
	0468860000	1		0467160000	1
	0468960000	1		0467260000	1
Type	Cat. No.	Qty.	Type	Cat. No.	Qty.
DSA 1	0576060000	50	DSA 1	0576060000	50

105 V/-/-			125 V/-/-		
Type	Cat. No.	Qty.	Type	Cat. No.	Qty.
	0498960000	1		0444060000	1
	0499060000	1		0545960000	1
with shield pins			with shield pins		
Type	Cat. No.	Qty.	Type	Cat. No.	Qty.
DSA 1	0576060000	50	DSA 1	0576060000	50

RV 8/20 short



RV 8/56 short



Technical data acc. to VDE

Pin versions (internal)

0.8 x 2.4/1 x 1
0.8 x 2.4/0.8 x 2.4

Additional versions on request

125 V/-/-		
Cat. No.	Qty.	
0544460000	1	

125 V/-/-		
Cat. No.	Qty.	
0462260000	1	
0533060000	4	

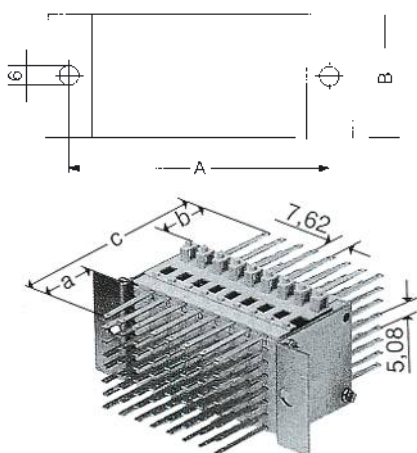

Type	Size A	Size B
	in mm	in mm
RV 8/8 K	81	40.64
RV 8/9 K	89	40.64
RV 8/8 L	93	40.64
RV 8/9 L	100	40.64
RV 8/20 K	187,62/31.5	63
RV 8/56 K	460/31.5	63

(K = short/L = long)

Cat. No.	RV	a	b	c
0468860000	8/8 L	26	20	200
0468960000	8/8 L	26	26	206
0467160000	8/8 K	26	20	84
0467260000	8/8 K	26	26	89
0119360000	8/20 K	26	20	84
0544460000	8/20 K	26	26	89
0462260000	8/56 K	26	20	84
0533060000	8/56 K	26	26	89

Где купить:
ООО "КОМПАНИЯ
ОПТУЛС"
г.Москва, ул.Иловайская, д.3,
стр.2
Tel.: +7 (495) 646-00-96
E-Mail: sale@opttools.ru
Internet: www.opttools.ru

Mounting rails, end brackets, further marking material see "Accessories"