



Protecting
bystanders
around the
work spot

Catalogue
2020





CEPRO - PROTECTING PEOPLE AT WORK

CEPRO develops safe setups for welding and grinding sites, to effectively protect people and the surrounding area from danger. Site safety is an indispensable part of solid operational management. In addition, we share our extensive expertise in the field of legal safety requirements with our business relations.

International market leader

We combine all the knowledge and expertise found in today's sector in our products, services and processes. We treat every request with due care and attention and work to tailor our solutions to the individual requirements of the client or end user. At CEPRO, we consistently invest in knowledge, training and relationships. This allows us to guarantee consistent and dependable quality and solid service in safety that complies with international regulations. It's what has made CEPRO the global market leader in its sector.

Loyal and highly motivated employees

We don't just go for gold when it comes to safety and satisfied clients. We want the best for our own employees too. And as a result, they tend to be very happy in their jobs. This expresses itself through strong loyalty towards both CEPRO and our business partners, leading to long-term and constructive relationships. Thanks to fixed contacts, our clients and suppliers always know who they are dealing with within our firm – and are very positive about the experience.

In addition, CEPRO's employees are distinguished by their high level of flexibility. This allows them to consistently adapt to new developments in our dynamic society and develop the best possible solutions for the changing needs and wishes of our clients. What's more, these aspects – flexibility, commitment and job satisfaction – can all lead to further cost savings for our clients!

CEPRO delivers on its promise of dependable quality and service in safety

We do so on the basis of our 6 Ps: Products, People, Protection, Profit, Pure and Planet.

- **Products:** We offer an extensive range of products, training programmes and services that consistently deliver the dependable quality required to set up safe welding and grinding sites in compliance with international legislation.
- **People:** Our employees work to gain an in-depth understanding of our clients' specific requirements, processes and wishes – and enjoy doing so.
- **Protection:** We offer employees optimal protection against welding light, noise and heat. This leads to less absence due to illness, reduced risk of fire and potential production loss as a result of damage.
- **Profit:** For honest business dealings, you need to be able to rely on each other and talk on an equal footing. That's why we work to honour our agreements and remain transparent at all times.
- **Pure:** Coordinating with the client is an integral part of each of our processes. The result? Clear communication.
- **Planet:** And as a firm, it's only logical that we treat the built-up environment in which we use this technology with due care and responsibility. That's why we have drawn up rules on how to behave and set them down in our Code of Conduct. We only work with companies that also attach strong importance to corporate social responsibility and sustainability.



TABLE OF CONTENTS

Welding light

| | |
|------------------------------------|---------|
| Welding light product information | page 6 |
| Welding curtains | page 8 |
| Protection curtains | page 11 |
| Welding strips | page 12 |
| Suspension clips & mounting strips | page 13 |
| Accordion folding strip system | page 15 |
| Welding sheet | page 16 |
| Impact plate | page 17 |

Welding sparks and spatter

| | |
|--|---------|
| Sparks and spatter product information | page 18 |
| Premium welding blankets | page 20 |
| Basic welding blankets | page 22 |
| Economy welding blankets | page 24 |
| Carbon felt blankets | page 25 |
| Special blankets | page 26 |
| Blanket accessories | page 27 |
| Insulation products | page 28 |
| Grinding curtains | page 29 |
| Grinding strips | page 30 |

Welding screens

| | |
|-------------------------------------|---------|
| Welding screens product information | page 32 |
| Robusto welding screen | page 34 |
| Omnium welding screen | page 38 |
| Sprint welding screen | page 42 |
| Gazelle welding screen | page 43 |

TABLE OF CONTENTS

Welding and grinding booths

| | |
|----------------------------------|---------|
| Booths product information | page 44 |
| Welding booths | page 46 |
| Grinding booths | page 48 |
| Workplace separation | page 49 |
| Diamond plate system information | page 50 |
| Diamond plate system | page 51 |
| Welding tables | page 52 |

Outdoor welding

| | |
|-------------------------------------|---------|
| Outdoor welding product information | page 53 |
| Welding tent | page 54 |
| Welding umbrella | page 55 |

Construction

| | |
|----------------------------------|---------|
| Construction product information | page 56 |
| Swivel arms | page 58 |
| Poles | page 63 |
| Rail system | page 64 |
| Tube system | page 68 |
| Cable reel | page 71 |

WELDING LIGHT

The main dangers of unprotected exposure to welding light are: actinic conjunctivitis (during short-term exposure), cataract (by prolonged exposure) and skin burn. The latter can also lead to skin cancer. The welder protects himself by wearing a welding mask and protective clothing but bystanders are exposed to the same dangers. This is why it is important to protect bystanders in the work place to prevent long-term illness.

When protecting the welding area, it is important not to isolate it from other work areas which is one of the reasons why a welding curtain should be made of transparent material. This not only helps to keep an overview of the work progress, but also allows for a quick response in the case of emergencies. It also prevents the welder from suffering from claustrophobia.

CEPRO offers a large range of welding light filtration products which all filter harmful welding light.

Certification

All CEPRO products have been approved according to the European EN ISO 25980 standard and are regularly retested and re-certified. Therefore customers are always assured of obtaining a safe product. The standard establishes requirements with regard to:

- Filtration of harmful ultraviolet (UV) and still visible blue light radiation.
- UV stability. This feature allows an approved CEPRO product to offer long term filtration properties.
- Flame extinction; if a CEPRO curtain catches fire, the material will extinguish automatically after the seat of the fire has been extinguished.

CEPRO products offer protection. They prevent actinic conjunctivitis, cataract, burnt skin, create a safe environment for bystanders and considerably reduce medical costs.

Available colours

CEPRO supplies transparent welding curtains and strips in three different colours: CEPRO Orange-CE, CEPRO Bronze-CE and Cepro Green-6. These colours provide excellent filters against harmful welding light and also offer protection against irritating (not harmful) welding light.

CEPRO also supplies a Green-9 colour. Separations of this material are opaque and extremely suitable for the shielding of several separate welding work areas without causing any nuisance to other welders.

Available products

The CEPRO range includes a large variety of products such as:

- Welding curtains for the shielding of large surfaces.
- Welding strips (2 of 3mm thick) for situations where mechanical load-bearing capacity is required.
- Suspension and mounting parts for mounting strips
- Welding sheets (1mm thick) for larger surfaces.
- Impact plate, a hard impact resistant material made of polycarbonate.

Each of these CEPRO products has been developed for use in specific working conditions for the optimal fit-out of a workplace.



CEPRO WELDING CURTAINS 140CM WIDE

- Approved in accordance with EN ISO 25980
- Standard width 140cm
- Fully seamed all-around
- 7 eyelets every on one side measuring 140cm
- Snap-fasteners on both sides
- Including 7 free steel suspension rings

CEPRO ORANGE-CE WELDING CURTAIN 140CM WIDE

| | | | | |
|---------------------------------|-----------------|-------------------|---------------|---------------|
| H. 160cm x 140cm | 16.15.16 | H. 160 cm x 140cm | per 10 | 16.15.16.0010 |
| H. 180cm x 140cm | 16.15.18 | H. 180 cm x 140cm | per 10 | 16.15.18.0010 |
| H. 200cm x 140cm | 16.15.20 | H. 200 cm x 140cm | per 10 | 16.15.20.0010 |
| H. 220cm x 140cm | 16.15.22 | | | |
| H. 240cm x 140cm | 16.15.24 | | | |
| H. 260cm x 140cm | 16.15.26 | | | |
| H. 280cm x 140cm | 16.15.28 | | | |
| H. 300cm x 140cm | 16.15.30 | | | |
| Custom-made* < 10m ² | 16.15.99 | | | |
| Custom-made* > 10m ² | 16.15.99 | | | |

**EN ISO 25980
APPROVED**



*For conditions custom-made curtains see page 9

CEPRO GREEN-9 WELDING CURTAIN 140CM WIDE

| | | | | | |
|---------------------------------|-----------------|-------------------|---------------|---------------|-----|
| H. 160cm x 140cm | 16.19.16 | H. 160 cm x 140cm | per 10 | 16.19.16.0010 | box |
| H. 180cm x 140cm | 16.19.18 | H. 180 cm x 140cm | per 10 | 16.19.18.0010 | box |
| H. 200cm x 140cm | 16.19.20 | H. 200 cm x 140cm | per 10 | 16.19.20.0010 | box |
| H. 220cm x 140cm | 16.19.22 | | | | |
| H. 240cm x 140cm | 16.19.24 | | | | |
| H. 260cm x 140cm | 16.19.26 | | | | |
| H. 280cm x 140cm | 16.19.28 | | | | |
| H. 300cm x 140cm | 16.19.30 | | | | |
| Custom-made* < 10m ² | 16.19.99 | | | | |
| Custom-made* > 10m ² | 16.19.99 | | | | |

**EN ISO 25980
APPROVED**



*For conditions custom-made curtains see page 9

CEPRO GREEN-6 WELDING CURTAIN 140CM WIDE

| | | | | | |
|---------------------------------|-----------------|-------------------|---------------|---------------|-----|
| H. 160cm x 140cm | 16.16.16 | H. 160 cm x 140cm | per 10 | 16.16.16.0010 | box |
| H. 180cm x 140cm | 16.16.18 | H. 180 cm x 140cm | per 10 | 16.16.18.0010 | box |
| H. 200cm x 140cm | 16.16.20 | H. 200 cm x 140cm | per 10 | 16.16.20.0010 | box |
| H. 220cm x 140cm | 16.16.22 | | | | |
| H. 240cm x 140cm | 16.16.24 | | | | |
| H. 260cm x 140cm | 16.16.26 | | | | |
| H. 280cm x 140cm | 16.16.28 | | | | |
| H. 300cm x 140cm | 16.16.30 | | | | |
| Custom-made* < 10m ² | 16.16.99 | | | | |
| Custom-made* > 10m ² | 16.16.99 | | | | |

**EN ISO 25980
APPROVED**



*For conditions custom-made curtains see page 9

CEPRO BRONZE-CE WELDING CURTAIN 140CM WIDE

| | | | | | |
|---------------------------------|-----------------|-------------------|---------------|---------------|-----|
| H. 160cm x 140cm | 16.17.16 | H. 160 cm x 140cm | per 10 | 16.17.16.0010 | box |
| H. 180cm x 140cm | 16.17.18 | H. 180 cm x 140cm | per 10 | 16.17.18.0010 | box |
| H. 200cm x 140cm | 16.17.20 | H. 200 cm x 140cm | per 10 | 16.17.20.0010 | box |
| H. 220cm x 140cm | 16.17.22 | | | | |
| H. 240cm x 140cm | 16.17.24 | | | | |
| H. 260cm x 140cm | 16.17.26 | | | | |
| H. 280cm x 140cm | 16.17.28 | | | | |
| H. 300cm x 140cm | 16.17.30 | | | | |
| Custom-made* < 10m ² | 16.17.99 | | | | |
| Custom-made* > 10m ² | 16.17.99 | | | | |

**EN ISO 25980
APPROVED**



*For conditions custom-made curtains see page 9

CONDITIONS CUSTOM-MADE CURTAINS

- PVC suspension eyelets every 22.5cm
- 5cm seam all-around
- Snap-fasteners on both vertical sides
- Minimum size supplied is 1m²
- Minimum length supplied per side is 100cm
- Due to the elasticity of the PVC material, 2 % tolerance should be taken into account on the measurements provided
- The maximum size per curtain is approx. 24m² (connectable for larger areas)
- Custom-made curtains are not returnable

CEPRO WELDING CURTAINS 220CM WIDE

- Approved in accordance with EN ISO 25980
- Standard width 220cm
- Fully seamed all-around
- 11 eyelets on one side measuring 220cm
- Snap-fasteners on both sides
- Including free steel suspension rings

CEPRO ORANGE-CE WELDING CURTAIN 220CM WIDE

| | |
|------------------|----------|
| H. 160cm x 220cm | 18.15.16 |
| H. 180cm x 220cm | 18.15.18 |

**EN ISO 25980
APPROVED**



CEPRO GREEN-9 WELDING CURTAIN 220CM WIDE

| | |
|------------------|----------|
| H. 160cm x 220cm | 18.19.16 |
| H. 180cm x 220cm | 18.19.18 |

**EN ISO 25980
APPROVED**



CEPRO GREEN-6 WELDING CURTAIN 220CM WIDE

| | |
|------------------|----------|
| H. 160cm x 220cm | 18.16.16 |
| H. 180cm x 220cm | 18.16.18 |

**EN ISO 25980
APPROVED**



CEPRO BRONZE-CE WELDING CURTAIN 220CM WIDE

| | |
|------------------|----------|
| H. 160cm x 220cm | 18.17.16 |
| H. 180cm x 220cm | 18.17.18 |

**EN ISO 25980
APPROVED**



► **CEPRO WELDING CURTAINS EYELETS ALL AROUND**

- Approved in accordance with EN ISO 25980
- Standard height 180cm
- Fully seamed all-around
- Suspension eyelets all around
- Including free steel suspension rings

► **CEPRO ORANGE-CE WELDING CURTAIN 180CM HIGH**

| | |
|--------------------------|----------|
| H. 180cm x 120cm (6'x4') | 14.15.04 |
| H. 180cm x 180cm (6'x6') | 14.15.06 |
| H. 180cm x 240cm (6'x8') | 14.15.08 |

**EN ISO 25980
APPROVED**



► **CEPRO GREEN-9 WELDING CURTAIN 180CM HIGH**

| | |
|--------------------------|----------|
| H. 180cm x 120cm (6'x4') | 14.19.04 |
| H. 180cm x 180cm (6'x6') | 14.19.06 |
| H. 180cm x 240cm (6'x8') | 14.19.08 |

**EN ISO 25980
APPROVED**



► **CEPRO GREEN-6 WELDING CURTAIN 180CM HIGH**

| | |
|--------------------------|----------|
| H. 180cm x 120cm (6'x4') | 14.16.04 |
| H. 180cm x 180cm (6'x6') | 14.16.06 |
| H. 180cm x 240cm (6'x8') | 14.16.08 |

**EN ISO 25980
APPROVED**



► **CEPRO BRONZE-CE WELDING CURTAIN 180CM HIGH**

| | |
|--------------------------|----------|
| H. 180cm x 120cm (6'x4') | 14.17.04 |
| H. 180cm x 180cm (6'x6') | 14.17.06 |
| H. 180cm x 240cm (6'x8') | 14.17.08 |

**EN ISO 25980
APPROVED**



► **CEPRO WELDING CURTAINS MIXED COLOURS**

- Approved in accordance with EN ISO 25980
- Standard width 150cm
- Seamed at the top and the bottom
- 7 suspension eyelets on the side measuring 150cm
- Snap-fasteners on both sides
- Including 7 free steel suspension rings
- Colour coverage from the bottom to the top: 40cm CEPRO Orange-CE, 120cm CEPRO Green-9, remainder CEPRO Orange-CE.

► **CEPRO WELDING CURTAIN MIXED COLOURS**

| | |
|------------------|----------|
| H. 160cm x 150cm | 19.91.16 |
| H. 180cm x 150cm | 19.91.18 |
| H. 200cm x 150cm | 19.91.20 |

**EN ISO 25980
APPROVED**



► **CEPRO PROTECTION CURTAINS 140CM WIDE**

- CEPRO Yellow only provide protection against exposure to UV radiation
- Standard 140cm wide
- Fully seamed all-around
- 7 eyelets every on one side measuring 140cm
- Snap-fasteners on both sides
- Including 7 free steel suspension rings

► **CEPRO YELLOW UV-CURTAIN 140CM WIDE**

| | |
|------------------|----------|
| H. 160cm x 140cm | 16.11.16 |
| H. 180cm x 140cm | 16.11.18 |
| H. 200cm x 140cm | 16.11.20 |



► **CEPRO GRINDING CURTAIN 140CM WIDE - B2 QUALITY**

| | |
|--------------------------------|----------|
| H. 160cm x 140cm | 16.10.16 |
| H. 180cm x 140cm | 16.10.18 |
| H. 200cm x 140cm | 16.10.20 |
| H. 220cm x 140cm | 16.10.22 |
| H. 240cm x 140cm | 16.10.24 |
| H. 260cm x 140cm | 16.10.26 |
| H. 280cm x 140cm | 16.10.28 |
| H. 300cm x 140cm | 16.10.30 |
| Custom-made < 10m ² | 16.10.99 |
| Custom-made > 10m ² | 16.10.99 |

**DIN 4102 - B2
APPROVED**



► **CEPRO GRINDING CURTAIN 140CM WIDE - B1 QUALITY**

| | |
|--------------------------------|----------|
| H. 160cm x 140cm | 16.30.16 |
| H. 180cm x 140cm | 16.30.18 |
| H. 200cm x 140cm | 16.30.20 |
| H. 220cm x 140cm | 16.30.22 |
| H. 240cm x 140cm | 16.30.24 |
| H. 260cm x 140cm | 16.30.26 |
| H. 280cm x 140cm | 16.30.28 |
| H. 300cm x 140cm | 16.30.30 |
| Custom-made < 10m ² | 16.30.99 |
| Custom-made > 10m ² | 16.30.99 |

**DIN 4102 - B1
APPROVED**



CEPRO WELDING STRIPS

- Approved in accordance with EN ISO 25980
- Standard 300mm wide
- 2mm and 3mm thickness
- Full roll 50 meters
- Available cut and punched
- Plastic suspension clips

CEPRO ORANGE-CE WELDING STRIPS

| | |
|-------------------------------|---------------|
| 300 x 2mm uncut per meter | 26.25.02 |
| 300 x 3mm uncut per meter | 26.25.03 |
| 300 x 2mm uncut per full roll | 26.25.02.0050 |
| 300 x 3mm uncut per full roll | 26.25.03.0050 |

| | |
|---|-------------|
| 300 x 2mm cut to size and punched according to the CEPRO pattern minimum length 150cm | 26.25.02.91 |
| 300 x 3mm cut to size and punched according to the CEPRO pattern minimum length 150cm | 26.25.03.91 |

EN ISO 25980
APPROVED



CEPRO GREEN-9 WELDING STRIPS

| | |
|-------------------------------|---------------|
| 300 x 2mm uncut per meter | 26.29.02 |
| 300 x 3mm uncut per meter | 26.29.03 |
| 300 x 2mm uncut per full roll | 26.29.02.0050 |
| 300 x 3mm uncut per full roll | 26.29.03.0050 |

| | |
|---|-------------|
| 300 x 2mm cut to size and punched according to the CEPRO pattern minimum length 150cm | 26.29.02.91 |
| 300 x 3mm cut to size and punched according to the CEPRO pattern minimum length 150cm | 26.29.03.91 |

EN ISO 25980
APPROVED

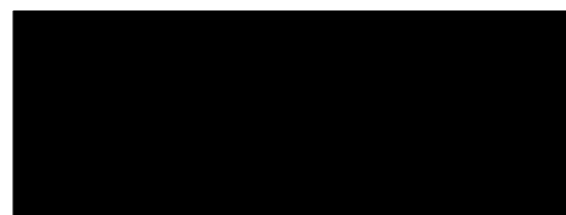

CEPRO GREEN-6 WELDING STRIPS

| | |
|-------------------------------|---------------|
| 300 x 2mm uncut per meter | 26.26.02 |
| 300 x 2mm uncut per full roll | 26.26.02.0050 |

| | |
|---|-------------|
| 300 x 2mm cut to size and punched according to the CEPRO pattern minimum length 150cm | 26.26.02.91 |
|---|-------------|

EN ISO 25980
APPROVED



CEPRO BRONZE-CE WELDING STRIPS

| | |
|-------------------------------|---------------|
| 300 x 2mm uncut per meter | 26.27.02 |
| 300 x 2mm uncut per full roll | 26.27.02.0050 |

| | |
|---|-------------|
| 300 x 2mm cut to size and punched according to the CEPRO pattern minimum length 150cm | 26.27.02.91 |
|---|-------------|

EN ISO 25980
APPROVED



CEPRO SUSPENSION CLIPS

- Easy assembly of welding strips on a tube Ø 33.7mm
- Suitable for overlap of 5 and 10cm
- Easy to open and close on the folding line

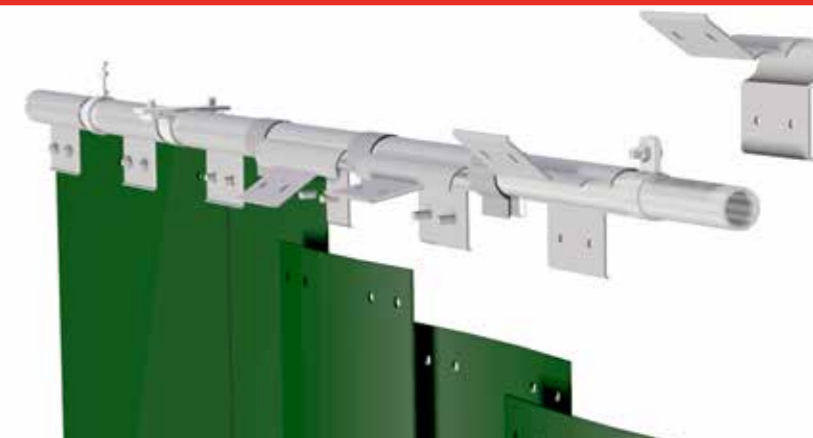

CEPRO STANDARD SUSPENSION CLIP 20CM

Standard clip 20cm 20.11.01

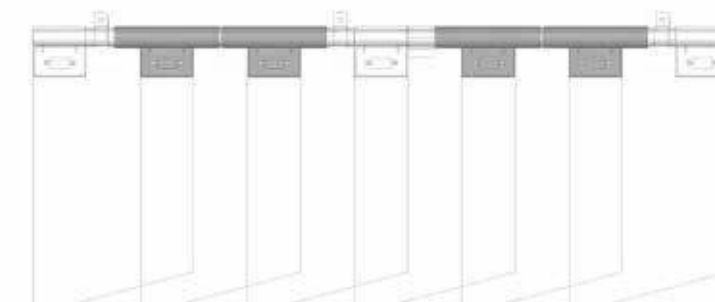

10 cm / 66% overlap (2 holes overlap)

CEPRO SQUARE SUSPENSION CLIP 10CM

Square clip 10cm 20.11.09

Suspension clip to be used as initial clip in a separation or next to a support.

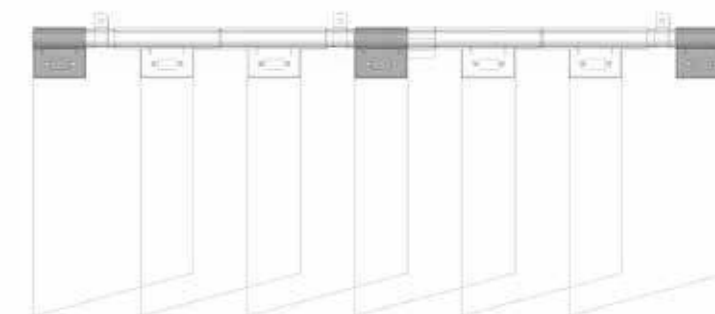

10 cm / 66% overlap (2 holes overlap)

CEPRO FILLING PIECE 5CM

Filling piece 5cm 20.11.90

Filling piece, for overlap of 5cm or next to a support in combination with a square clip.

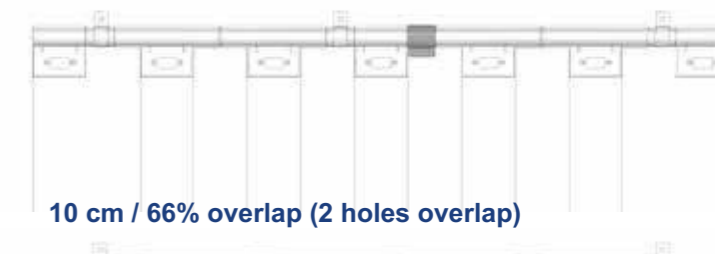

10 cm / 66% overlap (2 holes overlap)

5 cm / 33% overlap (1 hole overlap)

► **10cm / 66% overlap**
(2 holes overlap)

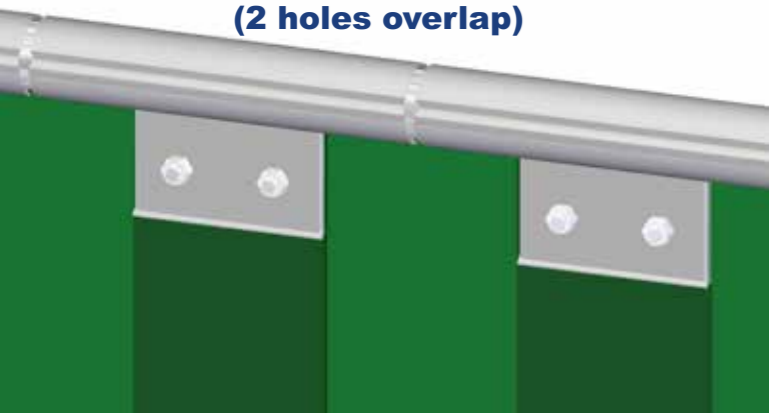

► **5cm / 33% overlap**
(1 hole overlap)

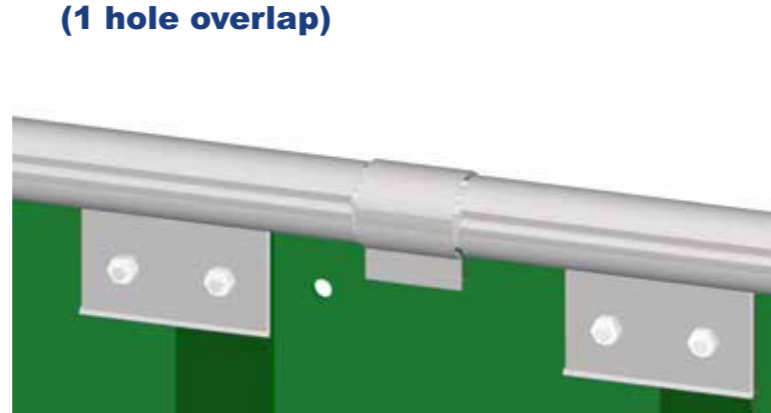

1 Open the clip on the folding line.



2 Press the clip onto the tube.



3 Push the bolts through both of the round holes in the middle of the clip.



4 Slide the overlapping strips over the bolts. Alternately assemble the strips concavely and convexly. For a 10cm overlap use both pre-punched holes and for a 5cm overlap only use the outer holes.



5 Close the clips and tighten the nuts and bolts.



6 If you have used a 5cm overlap then you can use the filling pieces in the openings between the clips.

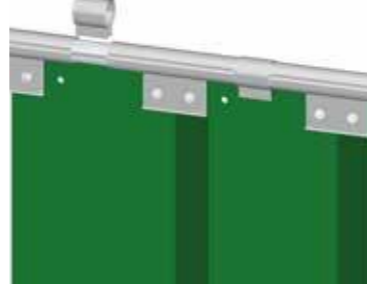

Calculation diagram for strip separations with an overlap of 100 mm (66%)

| | | | | | | | | | | | | | | | | | | | | | | | | | | | | | |
|-----------------------|-----|------|------|------|------|------|------|------|------|------|------|------|------|------|------|------|------|------|------|------|------|------|------|------|------|------|------|------|------|
| Width separation (mm) | 900 | 1100 | 1300 | 1500 | 1700 | 1900 | 2100 | 2300 | 2500 | 2700 | 2900 | 3100 | 3300 | 3500 | 3700 | 3900 | 4100 | 4300 | 4500 | 4700 | 4900 | 5100 | 5300 | 5500 | 5700 | 5900 | 6100 | 6300 | 6500 |
| Number strips | 4 | 5 | 6 | 7 | 8 | 9 | 10 | 11 | 12 | 13 | 14 | 15 | 16 | 17 | 18 | 19 | 20 | 21 | 22 | 23 | 24 | 25 | 26 | 27 | 28 | 29 | 30 | 31 | 32 |
| Number standard clips | 3 | 4 | 5 | 6 | 7 | 7 | 8 | 9 | 10 | 11 | 12 | 12 | 13 | 14 | 15 | 16 | 16 | 17 | 18 | 19 | 20 | 20 | 21 | 22 | 23 | 24 | 24 | 25 | 26 |
| Number square clips | 2 | 2 | 2 | 2 | 2 | 3 | 3 | 3 | 3 | 3 | 3 | 4 | 4 | 4 | 4 | 4 | 5 | 5 | 5 | 5 | 5 | 6 | 6 | 6 | 6 | 6 | 7 | 7 | 7 |
| Number filling pieces | 2 | 2 | 2 | 2 | 2 | 4 | 4 | 4 | 4 | 4 | 4 | 6 | 6 | 6 | 6 | 6 | 8 | 8 | 8 | 8 | 8 | 10 | 10 | 10 | 10 | 10 | 12 | 12 | 12 |

Calculation diagram for strip separations with an overlap of 50 mm (33%)

| | | | | | | | | | | | | | | | | | | | | | | | | | | | | | |
|-----------------------|-----|------|------|------|------|------|------|------|------|------|------|------|------|------|------|------|------|------|------|------|------|------|------|------|------|------|------|------|------|
| Width separation (mm) | 800 | 1050 | 1300 | 1550 | 1800 | 2050 | 2300 | 2550 | 2800 | 3050 | 3300 | 3550 | 3800 | 4050 | 4300 | 4550 | 4800 | 5050 | 5300 | 5550 | 5800 | 6050 | 6300 | 6550 | 6800 | 7050 | 7300 | 7550 | 7800 |
| Number strips | 3 | 4 | 5 | 6 | 7 | 8 | 9 | 10 | 11 | 12 | 13 | 14 | 15 | 16 | 17 | 18 | 19 | 20 | 21 | 22 | 23 | 24 | 25 | 26 | 27 | 28 | 29 | 30 | 31 |
| Number standard clips | 2 | 3 | 4 | 5 | 6 | 7 | 8 | 9 | 10 | 11 | 12 | 13 | 14 | 15 | 16 | 17 | 18 | 19 | 20 | 21 | 22 | 23 | 24 | 25 | 26 | 27 | 28 | 29 | 30 |
| Number square clips | 2 | 2 | 2 | 2 | 2 | 2 | 2 | 2 | 2 | 2 | 2 | 2 | 2 | 2 | 2 | 2 | 2 | 2 | 2 | 2 | 2 | 2 | 2 | 2 | 2 | 2 | 2 | 2 | 2 |
| Number filling pieces | 4 | 5 | 6 | 7 | 8 | 9 | 10 | 11 | 12 | 13 | 14 | 15 | 16 | 17 | 18 | 19 | 20 | 21 | 22 | 23 | 24 | 25 | 26 | 27 | 28 | 29 | 30 | 31 | 32 |

► **CEPRO ACCORDION FOLDING STRIP SYSTEM**

- Minimum amount of space
- Easy to operate
- Flexible in dividing the workspace



CEPRO SUSPENSION FOLDING STRIP SYSTEM

Complete mounting set for folding strips system, per running meter. Including all supports for mounting the system under a ceiling.

Cepro folding strip mounting system 20.95.95

Minimum width : 130cm
Maximum width : 1.000cm



► **CEPRO STRIPS FOLDING STRIP SYSTEM**

Complete strip set for accordion folding strip system per square meter.
Thickness strips 2mm. Maximum strip height 350cm.

- Cepro Orange-CE folding strip 300x2 mm system 27.55.32.10
- Cepro Green-9 folding strip 300x2 mm system 27.59.32.10
- Cepro Bronze-CE folding strip 300x2 mm system 27.57.32.10
- Cepro Green-6 folding strip 300x2 mm system 27.56.32.10

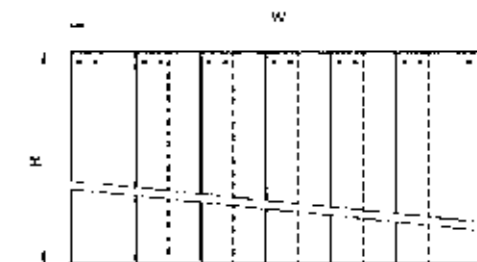

► **CEPRO STRIPS FOLDING STRIP SYSTEM**

Complete strip set for accordion folding strip system per square meter.
Thickness strips 3mm. Maximum strip height 250cm.

- Cepro Orange-CE folding strip 300x3 mm system 27.55.33.10
- Cepro Green-9 folding strip 300x3 mm system 27.59.33.10

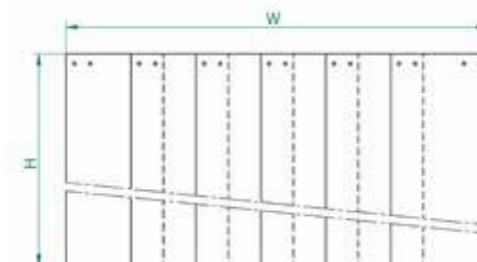

CEPRO WELDING SHEET 1MM

- Approved in accordance with EN ISO 25980
- Standard 570mm wide
- 1mm thickness
- Full roll 50 meters
- 4 eyelets every on one side measuring 570mm
- Metal suspension rings included
- Packed 4 per box, working width per box 2 meters
- Supplied rolled in paper

CEPRO ORANGE-CE WELDING SHEET 1MM

570 x 1mm, roll 50 meter length 22.15.01

Working width per box 200 cm.

570 x 1 x 1.600mm, per 4 pieces 22.15.16.0004
 570 x 1 x 1.800mm, per 4 pieces 22.15.18.0004
 570 x 1 x 2.000mm, per 4 pieces 22.15.20.0004
 570 x 1 x 2.200mm, per 4 pieces 22.15.22.0004

**EN ISO 25980
APPROVED**



CEPRO IMPACT PLATE 3MM

- Approved in accordance with EN ISO 25980
- Hard impact resistant material
- 3mm thickness
- Polycarbonate
- Available in custom measurements

CEPRO IMPACT BRONZE

2050 x 1250mm, thickness 3mm 28.27.01
 1025 x 1250mm, thickness 3mm 28.27.05

Impact cut to size 20.95.28.0001

**EN ISO 25980
APPROVED**



CEPRO GREEN-9 WELDING SHEET 1MM

570 x 1mm, roll 50 meter length 22.19.01

Working width per box 200 cm.

570 x 1 x 1.600mm, per 4 pieces 22.19.16.0004
 570 x 1 x 1.800mm, per 4 pieces 22.19.18.0004
 570 x 1 x 2.000mm, per 4 pieces 22.19.20.0004
 570 x 1 x 2.200mm, per 4 pieces 22.19.22.0004

**EN ISO 25980
APPROVED**



CEPRO IMPACT GREEN

2050 x 1250mm, thickness 3mm 28.29.01
 1025 x 1250mm, thickness 3mm 28.29.05

Impact cut to size 20.95.28.0001

**EN ISO 25980
APPROVED**



CEPRO GREEN-6 WELDING SHEET 1MM

570 x 1mm, roll 50 meter length 22.16.01

Working width per box 200 cm.

570 x 1 x 1.600mm, per 4 pieces 22.16.16.0004
 570 x 1 x 1.800mm, per 4 pieces 22.16.18.0004
 570 x 1 x 2.000mm, per 4 pieces 22.16.20.0004
 570 x 1 x 2.200mm, per 4 pieces 22.16.22.0004

**EN ISO 25980
APPROVED**



CONDITIONS CUSTOM-CUT IMPACT

- Minimum calculated dimension 0,25m²
- Minimum length calculated is 50cm
- Custom cut Impact is not returnable

CEPRO BRONZE-CE WELDING SHEET 1MM

570 x 1mm, roll 50 meter length 22.17.01

Working width per box 200 cm.

570 x 1 x 1.600mm, per 4 pieces 22.17.16.0004
 570 x 1 x 1.800mm, per 4 pieces 22.17.18.0004
 570 x 1 x 2.000mm, per 4 pieces 22.17.20.0004
 570 x 1 x 2.200mm, per 4 pieces 22.17.22.0004

**EN ISO 25980
APPROVED**



CEPRO IMPACT PLATE SPECIALS

CEPRO Impact material is also available in the colour Clear.

For more information, feel free to ask our sales department for a quotation.



▶ SPARKS AND SPATTER

Welding and grinding sparks are a significant issue and pose hazards for welders and co-workers in the welding and grinding workplace. Not only can sparks cause burns and thus serious personal injury to workers, but they can also cause a significant potential loss to the production process which can have a negative influence on the work of other personnel.

One of the major costs of inadequately protecting the working environment from sparks and welding spatters is damage during production which affects quality. Sparks and welding spatters pose a serious fire risk. It is not without reason that many insurers set demands for covering and shielding of flammable and / or costly materials in the vicinity of welding and grinding worksites.

Effective protection of products from welding spatter requires the use of non-combustible materials. This needs careful consideration. Specific applications and work situations often require unique solutions and customized products. Only tested and approved products should be chosen for maximum security against liability. CEPRO can provide these quality products.

CEPRO offers an extensive product package to provide shielding against sparks and welding spatters. The choice depends on the type of risk, the frequency of use, the proximity of the spark source and the different environmental factors. Products can be supplied for horizontal applications (welding blankets) or vertical solutions (curtains). Often it is also necessary and possible to supply custom made products.

▶ Certification

The European standard EN 13501-1 provides the reaction to fire classification procedure for all products and building elements. According to this standard, reaction to fire is the response of a product in contributing by its own decomposition to a fire to which it is exposed, under specified conditions (not to be confused with the fire resistance).

All CEPRO welding blankets comply with the most stringent requirements for each quality. We hereby guarantee our clients a high-quality product, which will ensure a safe workplace, at all times.

For the best possible guarantee against liability, one must select products that are tested and approved according to the above mentioned standard.

▶ Available products

- The CEPRO range includes a large variety of products such as:
- Premium welding blankets, produced from high quality raw material.
 - Basic welding blankets, all-round blankets with an excellent price - quality ratio.
 - Economy welding blankets, combine quality with a competitive price.
 - Carbon felt welding blankets, light weight, scratch free and flexible.
 - Specials, door sleeves, protection covers, fire blankets
 - Insulation products, welding cushions, insulation blankets and sleeves.
 - Clear grinding strips and curtains.

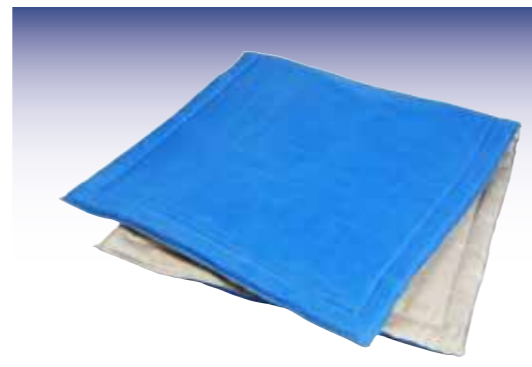
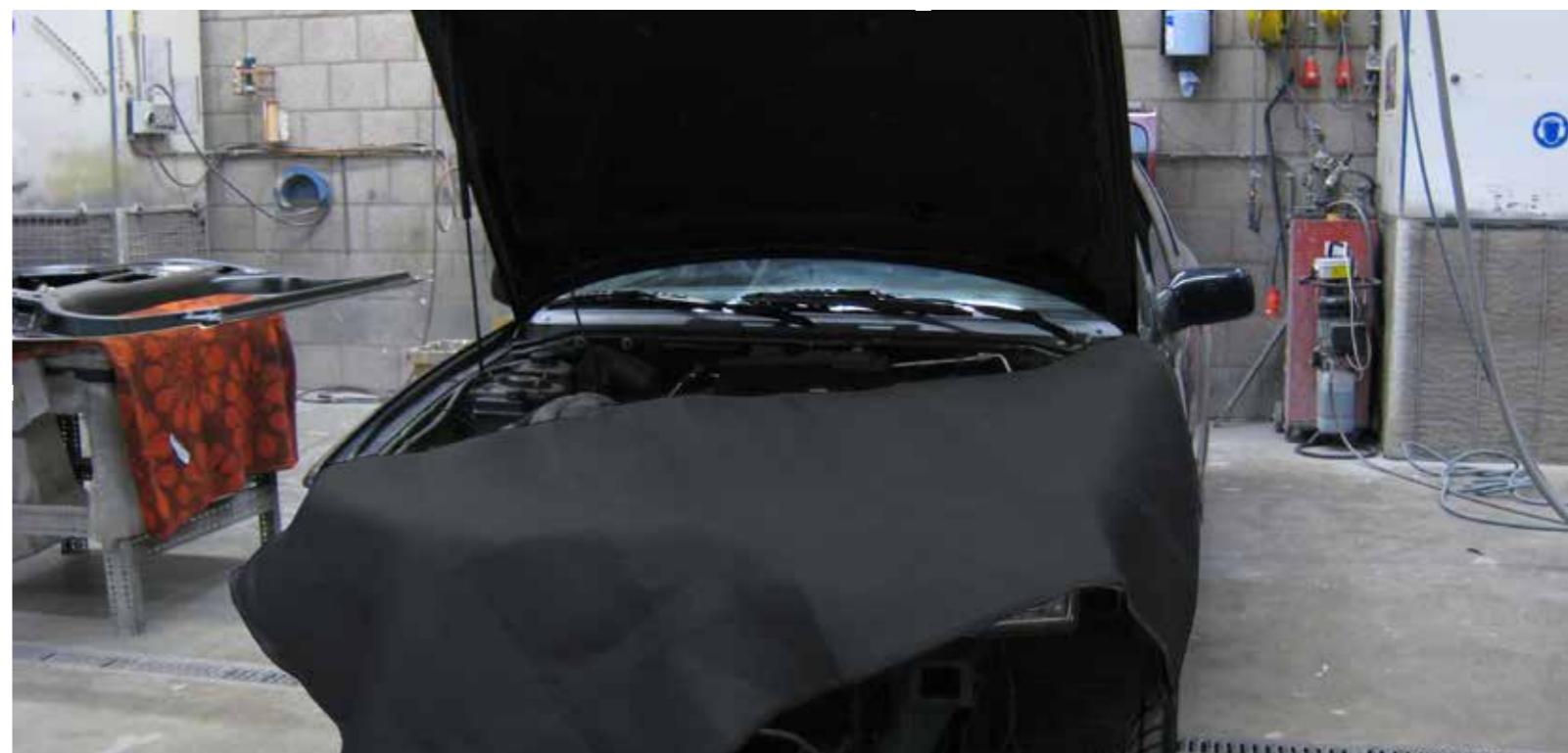
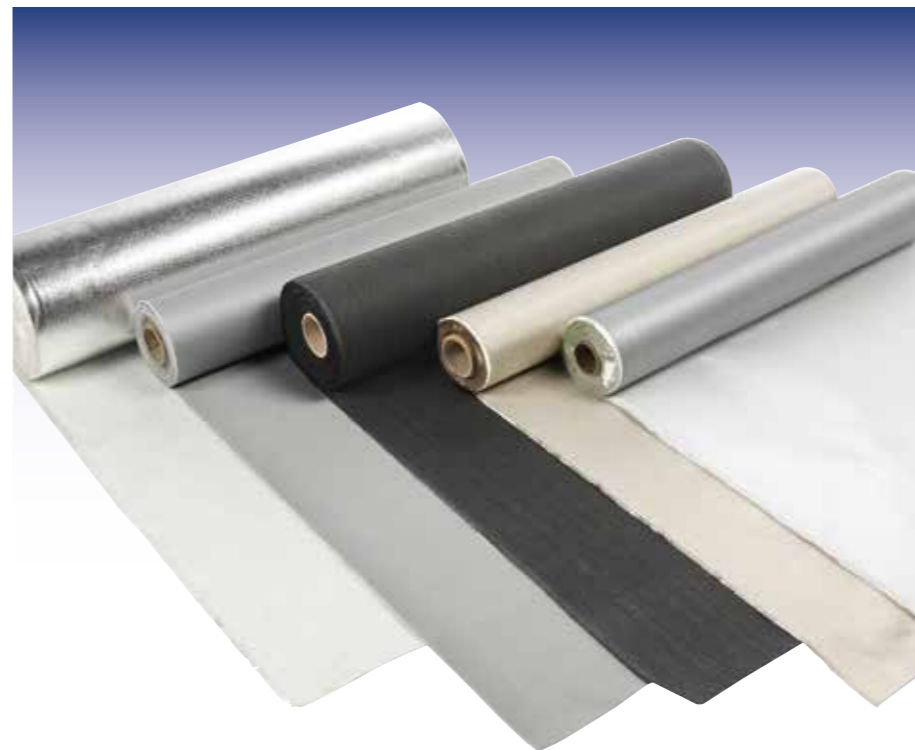
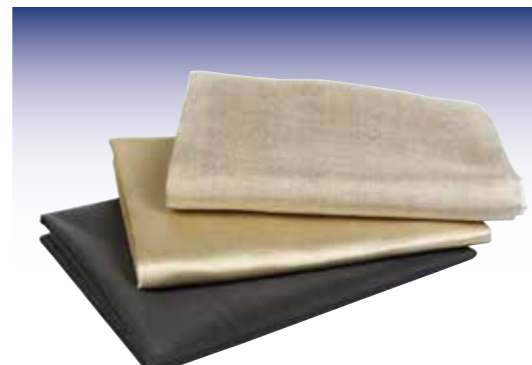

CEPRO PREMIUM WELDING BLANKETS

- Approved according to the highest applicable classification within the EN 13501-1 standard
- Suitable for horizontal and vertical use
- Produced from high-quality materials
- Suitable for high to extremely high temperatures

OLYMPUS WELDING BLANKET

| | |
|--|---------------|
| Olympus welding blanket 100 x 90cm | 56.50.91 |
| Olympus welding blanket 200 x 90cm | 56.50.92 |
| Olympus welding blanket 200 x 180cm | 56.50.95 |
| Olympus welding blanket 300 x 180cm | 56.50.96 |
| Olympus welding blanket 300 x 270cm | 56.50.97 |
| Olympus welding blanket 400 x 360cm | 56.50.99 |
| Olympus welding blanket 600 x 360cm | 56.50.992 |
| | |
| Olympus width 90cm, part of a rol | 56.50.09.0900 |
| Olympus width 90cm, full rol 50 m ¹ | 56.50.09.0950 |
| Olympus made to size, seamed | 56.50.90 |

A1 - EN 13501-1 approved non-flammable

- Silica fabric (filament)
- High temperatures up to 1000 °C
- Peak temperature approx. 1300°C
- Extreme circumstances
- Suitable for horizontal use
- Material weight 1,100 gram/m²

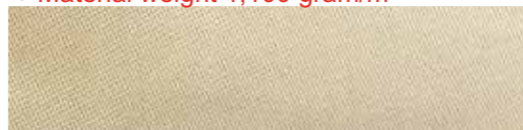

HERCULES WELDING BLANKET

| | |
|--|---------------|
| Hercules welding blanket 100 x 100cm | 56.50.71 |
| Hercules welding blanket 200 x 100cm | 56.50.72 |
| Hercules welding blanket 200 x 200cm | 56.50.75 |
| Hercules welding blanket 300 x 200cm | 56.50.76 |
| Hercules welding blanket 300 x 300cm | 56.50.77 |
| Hercules welding blanket 400 x 300cm | 56.50.78 |
| Hercules welding blanket 400 x 400cm | 56.50.79 |
| | |
| Hercules width 100cm, part of a rol | 56.50.07.1000 |
| Hercules width 100cm, full rol 25 m ¹ | 56.50.07.1025 |
| Hercules made to size, lock stiched | 56.50.70 |

A2, s1, d0 EN 13501-1 approved non-flammable

- Fibreglass cloth (texturized)
- 2-sided PU coating
- Temperature resistance 750°C
- Peak temperature approx. 900°C
- Suitable for horizontal use
- Material weight 1,220 gram/m²



SIRIUS WELDING BLANKET

| | |
|--|---------------|
| Sirius welding blanket 100 x 100cm | 56.53.21 |
| Sirius welding blanket 200 x 100cm | 56.53.22 |
| Sirius welding blanket 200 x 200cm | 56.53.25 |
| Sirius welding blanket 300 x 200cm | 56.53.26 |
| Sirius welding blanket 300 x 300cm | 56.53.27 |
| Sirius welding blanket 400 x 400cm | 56.53.29 |
| | |
| Sirius width 100cm, part of a rol | 56.53.02.1000 |
| Sirius width 100cm, full rol 25 m ¹ | 56.53.02.1025 |
| Sirius made to size, seamed | 56.53.20 |

A1 - EN 13501-1 approved non-flammable

- Fibreglass cloth (texturized)
- 2-sided HT coating
- Flame protection till approx. 700 °C
- Peak temperature approx. 1000°C
- Suitable for horizontal use
- Material weight 1,035 gram/m²



THETIS WELDING BLANKET

| | |
|--|---------------|
| Thetis welding blanket 200 x 100cm | 56.53.82 |
| Thetis welding blanket 200 x 200cm | 56.53.85 |
| Thetis welding blanket 300 x 200cm | 56.53.86 |
| Thetis welding blanket 300 x 300cm | 56.53.87 |
| Thetis welding blanket 400 x 300cm | 56.53.88 |
| Thetis welding blanket 400 x 400cm | 56.53.89 |
| Thetis welding blanket 600 x 400cm | 56.53.892 |
| | |
| Thetis width 100cm, part of a rol | 56.53.08.1000 |
| Thetis width 100cm, full rol 25 m ¹ | 56.53.08.1025 |
| Thetis made to size, lock stiched | 56.53.80 |

A2, s2, d0 EN 13501-1 approved non-flammable

- Fibreglass cloth (texturized)
- 2-sided black graphite coating
- Temperature resistance 700°C
- Peak temperature 900°C
- Suitable for horizontal use
- Material weight 1,100 gram/m²



CEPRO PREMIUM WELDING BLANKETS

- Approved according to the highest applicable classification within the EN 13501-1 standard
- Suitable for horizontal and vertical use
- Produced from high-quality materials
- Suitable for high to extremely high temperatures

ATHOS WELDING BLANKET

| | |
|---|---------------|
| Athos welding blanket 200 x 200cm | 56.55.15 |
| Athos welding blanket 300 x 200cm | 56.55.16 |
| Athos welding blanket 400 x 300cm | 56.55.18 |
| Athos welding blanket 400 x 400cm | 56.55.19 |
| | |
| Athos width 100cm, part of a rol | 56.55.10.1000 |
| Athos width 100cm, full rol 25 m ¹ | 56.55.10.1025 |

A2, s1, d0 EN 13501-1 approved non-flammable

- Fibreglass cloth (texturized)
- 2-sided PU coating
- Temperature resistance 550°C
- Peak temperature approx. 900°C
- Material weight 1,120 gram/m²



ARES WELDING BLANKET

| | |
|--|---------------|
| Ares width 100cm, part of a rol | 56.51.01.1000 |
| Ares width 100cm, full rol 50 m ¹ | 56.51.01.1050 |

A2, s1, d0 EN 13501-1 approved non-flammable

- Fibreglass cloth (texturized)
- 1 sided aluminium foil
- Temperature resistance 550°C
- Radiation temperature 1.000°C
- Protection against radiation heat
- Material weight 1,060 gram/m²



CONDITIONS CUSTOM-MADE WELDING BLANKETS

The specifications for custom-made welding blankets are:

- Sewn on the cut edges
- Minimum size available is 1m²
- Maximum size available is 15m²
- The minimum length per side is 100cm
- Welding blankets are made with tolerance of 2% with a maximum of 5cm on the provided measurements
- Custom-made welding blankets are not returnable



PRODUCT FACT SHEETS

i For all materials product fact sheets are available with information about composition, tests etc.

Please visit our website or contact our sales department for more information.



CEPRO BASIC WELDING BLANKETS

- Approved according to the highest applicable classification within the EN 13501-1 standard
- Suitable for vertical use
- Excellent price-quality ratio
- All-round welding blankets

LETO WELDING BLANKET

| | |
|---|---------------|
| Leto welding blanket 100 x 90cm | 56.51.91 |
| Leto welding blanket 200 x 90cm | 56.51.92 |
| Leto welding blanket 200 x 180cm | 56.51.95 |
| Leto welding blanket 300 x 180cm | 56.51.96 |
| Leto welding blanket 300 x 270cm | 56.51.97 |
| | |
| Leto width 90cm, part of a rol | 56.51.09.0900 |
| Leto width 90cm, full rol 50 m ¹ | 56.51.09.0950 |
| Leto made to size, seamed | 56.51.90 |

A1 - EN 13501-1 approved non-flammable

- Silica fabric (filament)
- High temperatures up to 1000 °C
- Peak temperature approx. 1300°C
- Extreme circumstances
- Suitable for horizontal use
- Material weight 600 gram/m²



CEPRO BASIC WELDING BLANKETS

- Approved according to the highest applicable classification within the EN 13501-1 standard
- Suitable for vertical use
- Excellent price-quality ratio
- All-round welding blankets

KRONOS WELDING BLANKET

| | |
|--|---------------|
| Kronos welding blanket 200 x 100cm | 56.50.62 |
| Kronos welding blanket 200 x 200cm | 56.50.65 |
| Kronos welding blanket 300 x 200cm | 56.50.66 |
| Kronos welding blanket 300 x 300cm | 56.50.67 |
| Kronos welding blanket 400 x 300cm | 56.50.68 |
| Kronos welding blanket 400 x 400cm | 56.50.69 |
| Kronos welding blanket 600 x 400cm | 56.50.692 |
| Kronos width 100cm, part of a rol | 56.50.06.1000 |
| Kronos width 100cm, full rol 25 m ¹ | 56.50.06.1025 |
| Kronos width 150cm, part of a rol | 56.50.06.1500 |
| Kronos width 150cm, full rol 50 m ¹ | 56.50.06.1550 |
| Kronos made to size, seamed | 56.50.60 |

A2, s1, d0 EN 13501-1 approved non-flammable

- Fibreglass cloth (filament)
- 1-sided PU-coating
- Temperature resistance 550°C
- Peak temperature approx. 600°C
- Light welding and grinding work
- Material weight 690 gram/m²



PALLAS WELDING BLANKET

| | |
|--|---------------|
| Pallas welding blanket 100 x 100cm | 56.50.41 |
| Pallas welding blanket 200 x 100cm | 56.50.42 |
| Pallas welding blanket 200 x 200cm | 56.50.45 |
| Pallas welding blanket 300 x 200cm | 56.50.46 |
| Pallas welding blanket 300 x 300cm | 56.50.47 |
| Pallas welding blanket 400 x 300cm | 56.50.48 |
| Pallas welding blanket 400 x 400cm | 56.50.49 |
| | |
| Pallas width 100cm, part of a rol | 56.50.04.1000 |
| Pallas width 100cm, full rol 25 m ¹ | 56.50.04.1025 |
| Pallas made to size, seamed | 56.50.40 |

A1 - EN 13501-1 approved non-flammable

- Fibreglass cloth (filament)
- 2-sided inorganic HT coating
- Temperature resistance 700°C
- Peak temperature approx. 750°C
- Suitable for welding and grinding
- Material weight 700 gram/m²

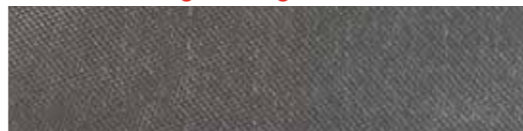

ARGES WELDING BLANKET

| | |
|---|---------------|
| Arges width 100cm, full rol 50 m ¹ | 56.59.14.1050 |
|---|---------------|

- Fibreglass cloth (filament)
- 2-sided neoprene rubber coating
- Temperature resistance 550°C
- Peak temperature approx. 600°C
- Oil, grease and acid resistant
- Material weight 550 gram/m²

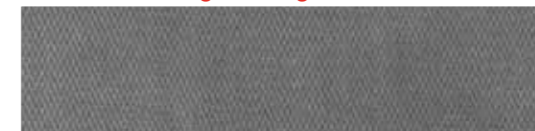

ASTERIA WELDING BLANKET

| | |
|---|---------------|
| Asteria welding blanket 200 x 100cm | 56.53.72 |
| Asteria welding blanket 200 x 200cm | 56.53.75 |
| Asteria welding blanket 300 x 200cm | 56.53.76 |
| | |
| Asteria width 100cm, part of a rol | 56.53.07.1000 |
| Asteria width 100cm, full rol 25 m ¹ | 56.53.07.1025 |
| Asteria made to size, seamed | 56.53.70 |

A1 - EN 13501-1 approved non-flammable

- Fibreglass cloth (texturized)
- 2-sided heat treated
- Temperature resistance 550°C
- Peak temperature approx. 600°C
- Light welding and grinding work
- Material weight 580 gram/m²



CONDITIONS CUSTOM-MADE WELDING BLANKETS

The specifications for custom-made welding blankets are:

- Sewn on the cut edges
- Minimum size available is 1m²
- Maximum size available is 15m²
- The minimum length per side is 100cm
- Welding blankets are made with 5cm tolerance on the provided measurements
- Custom-made welding blankets are not returnable

ATLAS WELDING BLANKET

| | |
|---|---------------|
| Atlas welding blanket 200 x 100cm | 56.50.12 |
| Atlas welding blanket 200 x 200cm | 56.50.15 |
| Atlas welding blanket 300 x 200cm | 56.50.16 |
| Atlas welding blanket 300 x 300cm | 56.50.17 |
| Atlas welding blanket 400 x 300cm | 56.50.18 |
| Atlas welding blanket 400 x 400cm | 56.50.19 |
| | |
| Atlas width 100cm, part of a rol | 56.50.05.1000 |
| Atlas width 100cm, full rol 25 m ¹ | 56.50.05.1025 |
| Atlas width 150cm, part of a rol | 56.50.05.1500 |
| Atlas width 150cm, full rol 50 m ¹ | 56.50.05.1550 |
| Atlas made to size, lock stiched | 56.50.10 |

A2, s1, d0 EN 13501-1 approved non-flammable

- Fibreglass cloth (filament)
- 2-sided PU-coating
- Temperature resistance 550 °C
- Peak temperature approx. 600°C
- Light welding and grinding work
- Material weight 720 gram/m²



BIGGER QUANTITIES



If you have any demand for bigger quantities in blankets or rolls, please contact our sales department for a quotation.



CEPRO ECONOMY WELDING BLANKETS

- Approved according to the highest applicable classification within the EN 13501-1 standard
- Suitable for vertical use
- CEPRO quality at a competitive price
- Suitable for light welding and grinding work

ATHENA WELDING BLANKET

| | |
|--|---------------|
| Athena welding blanket 100 x 100cm | 56.52.21 |
| Athena welding blanket 200 x 100cm | 56.52.22 |
| Athena welding blanket 200 x 200cm | 56.52.25 |
| Athena welding blanket 300 x 200cm | 56.52.26 |
| Athena welding blanket 300 x 300cm | 56.52.27 |
| Athena welding blanket 400 x 400cm | 56.52.29 |
| Athena welding blanket 600 x 400cm | 56.52.292 |
| Athena width 100cm, part of a rol | 56.52.02.1000 |
| Athena width 100cm, full rol 25 m ¹ | 56.52.02.1025 |
| Athena width 100cm, full rol 50 m ¹ | 56.52.02.1050 |
| Athena made to size, seamed | 56.52.20 |

A2, s1, d0 EN 13501-1 approved non-flammable

- Fibreglass cloth (filament)
- 2-sided PU-coating
- Temperature resistance 550°C
- Peak temperature approx. 600°C
- Light welding and grinding work
- Material weight 470 gram/m²



APOLLO WELDING BLANKET

| | |
|--|---------------|
| Apollo width 100cm, full rol 50 m ¹ | 56.50.02.1050 |
|--|---------------|

A2, s1, d0 EN 13501-1 approved non-flammable

- Fibreglass cloth (filament)
- 1 sided PU-coating
- Temperature resistance 550°C
- Peak temperature approx. 600°C
- Light welding and grinding work
- Material weight 460 gram/m²

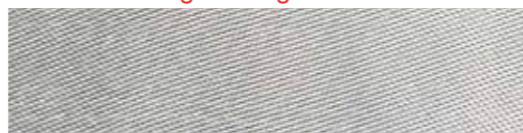

CETO 2 WELDING BLANKET

| | |
|--|---------------|
| Ceto width 100cm, full rol 50 m ¹ | 56.52.06.1050 |
|--|---------------|

- Fibreglass cloth (filament)
- 2-sided silicone rubber coating
- Temperature resistance 550°C
- Peak temperature approx. 600°C
- Oil, grease and acid resistant
- Material weight 590 gram/m²



CEPRO SATURN WELDING BLANKETS

- Made from non-woven carbon felt
- Suitable for high temperatures
- Very flexible
- Scratch-free
- Light-weight
- Not suitable as cooling down blanket

Saturn is perfect to be put to use as an all round welding blanket, for example in the field of :

- Machine building and maintenance.
- Cutting and grinding work
- Ship maintenance
- Automotive industries

Saturn welding blankets have a very high peak temperature (1300 °C) and are relatively light-weight. Furthermore, Saturn welding blankets are very flexible and can be used in small spaces and in odd corners.

SATURN 420 WELDING BLANKET

| | |
|--|----------|
| Saturn 420 welding blanket 200 x 100cm | 56.57.12 |
| Saturn 420 welding blanket 200 x 200cm | 56.57.15 |
| Saturn 420 welding blanket 300 x 200cm | 56.57.16 |

| | |
|--|---------------|
| Saturn 420 width 200cm, roll length 50 m | 56.57.01.2050 |
| Saturn 420 width 200cm, roll length 10 m | 56.57.01.2010 |
| Saturn 420 width 200cm, part of a rol | 56.57.01.2000 |

- Carbon felt
- Temperature resistance 1300°C
- Suitable for welding and grinding
- Very flexible
- Scratch-free
- Material weight 420 gram/m²



SATURN 200 WELDING BLANKET

| | |
|--|----------|
| Saturn 200 welding blanket 200 x 100cm | 56.57.92 |
| Saturn 200 welding blanket 200 x 200cm | 56.57.95 |
| Saturn 200 welding blanket 300 x 200cm | 56.57.96 |

| | |
|--|---------------|
| Saturn 200 width 200cm, roll length 50 m | 56.57.00.2050 |
| Saturn 200 width 200cm, roll length 10 m | 56.57.00.2010 |
| Saturn 200 width 200cm, part of a rol | 56.57.00.2000 |

- Carbon felt
- Temperature resistance 1300°C
- Suitable for welding and grinding
- Very flexible
- Scratch-free
- Material weight 200 gram/m²



CONDITIONS CUSTOM-MADE WELDING BLANKETS

The specifications for custom-made welding blankets are:

- Sewn on the cut edges
- Minimum size available is 1m²
- Maximum size available is 15m²
- The minimum length per side is 100cm
- Welding blankets are made with 5cm tolerance on the provided measurements
- Custom-made welding blankets are not returnable



CEPRO SATURN WELDING BLANKETS



Saturn blankets are very suitable for use in the automotive industry.



► **CEPRO SPECIAL BLANKETS**

► **BLANKET ACCESSORIES**

► **FIRE BLANKET**

| | |
|---------------------------------------|----------|
| Fire blanket in container 120 x 120cm | 53.21.12 |
| Fire blanket in container 180 x 120cm | 53.21.14 |
| Fire blanket in container 180 x 150cm | 53.21.15 |
| Fire blanket in container 180 x 180cm | 53.21.16 |

EN 1869 APPROVED

- Approved according to EN-1869
- Stowed away in a red container
- Fitted with an eyelet for hanging



► **BRASS EYELETS Ø 12MM**

| | |
|--|----------|
| Brass eyelets, pressed into the fabric | 50.01.10 |
|--|----------|



► **PROTECTION COVERS**

| | |
|---|---------------|
| Protection cover 200 x 200cm incl. 10 magnets, 690 gram/m ² | 59.06.00.0007 |
| Protection cover 180 x 200cm 1,100 gram/m ² | 56.50.95 |

- Suitable for maintenance to cars and trucks



► **VELCRO, WIDTH 25MM**

| | |
|---|---------------|
| Velcro, hook part, stitched with Kevlar | 50.05.20.9910 |
| Velcro, hook part, self adhesive | 50.05.20.0010 |
| Velcro, loop part, stitched with Kevlar | 50.05.20.9920 |
| Velcro, loop part, self adhesive | 50.05.20.0020 |



► **DOOR SLEEVE**

| | |
|--|---------------|
| Door sleeve 150 x 125cm 690 gram/m ² | 59.06.00.0001 |
|--|---------------|

- Suitable for cars and trucks
- Glass fibre (filament)
- 1 side PU coating
- Temperature resistance 550 °C
- Material weight 690 gram/m²



► **MAGNETS Ø 45MM**

| | |
|--|---------------|
| Magnets, seamed into fabric Ø 45 mm, thickness 9 mm | 50.10.09.0045 |
|--|---------------|



CEPRO INSULATION PRODUCTS

- Controlled cooling of hot objects to improve quality of the weld
- Prevention of injuries due to contact with hot objects
- Made from high-quality materials

CEPRO WELDING CUSHION

50 x 50cm, thickness 8cm,
filled with glass needle mats 57.51.10.05

100 x 100cm, thickness 8cm,
filled with glass needle mats 57.51.10.10



CEPRO INSULATION SLEEVES

100 x 50cm, for pipe diameters
from 15 to max. 28cm 57.50.10.11

150 x 50cm, for pipe diameters
from 29 to max. 44cm 57.50.10.12

200 x 50cm, for pipe diameters
from 45 to max. 61cm 57.50.10.13



CEPRO INSULATION BLANKETS

200 x 100cm, thickness 3cm 57.50.23.10

200 x 200cm, thickness 3cm 57.50.23.20

200 x 100cm, thickness 6cm 57.50.26.10

200 x 200cm, thickness 6cm 57.50.26.20



CEPRO GRINDING CURTAINS 140CM WIDE

- Standard width 140cm
- Fully seamed all-around
- 7 eyelets on one side measuring 140cm
- Snap-fasteners on both sides
- Including 7 free steel suspension rings

CEPRO CLEAR GRINDING CURTAINS 140CM WIDE - B2 QUALITY

| | |
|--------------------------------|----------|
| H. 160 cm x 140cm | 16.10.16 |
| H. 180 cm x 140cm | 16.10.18 |
| H. 200 cm x 140cm | 16.10.20 |
| H. 220 cm x 140cm | 16.10.22 |
| H. 240 cm x 140cm | 16.10.24 |
| H. 260 cm x 140cm | 16.10.26 |
| H. 280 cm x 140cm | 16.10.28 |
| H. 300 cm x 140cm | 16.10.30 |
| Custom-made > 10m ² | 16.10.99 |
| Custom-made < 10m ² | 16.10.99 |

**DIN 4102 - B2
APPROVED**



CEPRO CLEAR GRINDING CURTAINS 140CM WIDE - B1 QUALITY

| | |
|--------------------------------|----------|
| H. 160 cm x 140cm | 16.30.16 |
| H. 180 cm x 140cm | 16.30.18 |
| H. 200 cm x 140cm | 16.30.20 |
| H. 220 cm x 140cm | 16.30.22 |
| H. 240 cm x 140cm | 16.30.24 |
| H. 260 cm x 140cm | 16.30.26 |
| H. 280 cm x 140cm | 16.30.28 |
| H. 300 cm x 140cm | 16.30.30 |
| Custom-made > 10m ² | 16.30.99 |
| Custom-made < 10m ² | 16.30.99 |

**DIN 4102 - B1
APPROVED**



CEPRO INDUSTRIAL CURTAINS



CEPRO Industrial curtains provide excellent protection against all kinds of industrial nuisance. They are available in various colours and with or without a see through window .

Please contact our sales department for more information about our industrial protection items .



► **CEPRO GRINDING STRIPS**

- Widths 200, 300 and 400mm wide
- Thicknesses 2, 3 and 4mm
- Full roll 50 metres
- Available cut and punched
- Suspension with plastic suspension clip

► **CEPRO GRINDING STRIPS**

| | |
|---------------------------|----------|
| 200 x 2mm uncut per meter | 26.20.22 |
| 300 x 2mm uncut per meter | 26.20.02 |
| 300 x 3mm uncut per meter | 26.20.03 |
| 400 x 4mm uncut per meter | 26.20.44 |

| | |
|---|-------------|
| 300 x 2mm cut to size and punched according to the CEPRO pattern minimum length 150cm | 26.20.02.91 |
| 300 x 3mm cut to size and punched according to the CEPRO pattern minimum length 150cm | 26.20.03.91 |



► **CEPRO GRINDING STRIPS FULL ROLLS - B2 QUALITY**

| | |
|--------------------------------|---------------|
| 200 x 2mm per full roll of 50m | 26.20.22.0050 |
| 300 x 2mm per full roll of 50m | 26.20.02.0050 |
| 300 x 3mm per full roll of 50m | 26.20.03.0050 |
| 400 x 4mm per full roll of 50m | 26.20.44.0050 |

DIN 4102 - B2 APPROVED



► **CEPRO GRINDING STRIPS FULL ROLLS - B1 QUALITY**

| | |
|--------------------------------|---------------|
| 200 x 2mm per full roll of 50m | 26.30.22.0050 |
| 300 x 2mm per full roll of 50m | 26.30.02.0050 |
| 300 x 3mm per full roll of 50m | 26.30.03.0050 |
| 400 x 4mm per full roll of 50m | 26.30.44.0050 |

DIN 4102 - B1 APPROVED



CEPRO CLEAR STRIPS



CEPRO Clear colourless transparent strips can also be used as protection from all kinds of external factors such as draughts, moisture, dust, cold, air, noise etc.

Please contact our sales department for a quotation.



► **CEPRO SUSPENSION CLIPS**

- Easy assembly of welding strips
- Suitable for overlap of 5 and 10 cm

► **CEPRO STANDARD SUSPENSION CLIP 20CM**

Standard clip 20cm 20.11.01

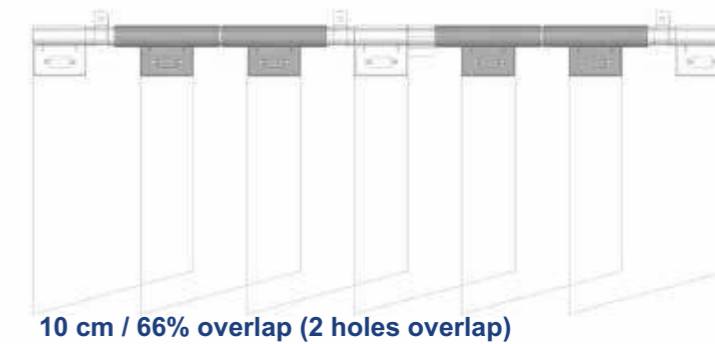

► **CEPRO SQUARE SUSPENSION CLIP 10CM**

Square clip 10cm 20.11.09

Suspension clip to be used as initial clip in a separation or next to a support.

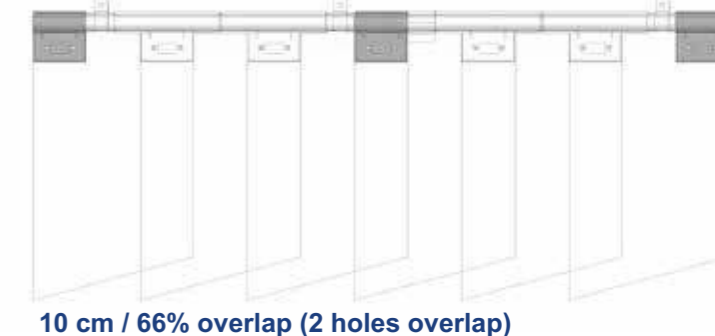

► **CEPRO FILLING PIECE 5CM**

Filling piece 5cm 20.11.90

Filling piece, for overlap of 5cm or next to a support in combination with a square clip.



MOUNTING STRIPS



For mounting instructions for Cepro strip separation, please see page 14.

If you have any questions or if you are in need of a quotation please contact our sales department.



WELDING SCREENS

The main dangers of unprotected exposure to welding light are: arc eye (during short-term exposure), cataract (by prolonged exposure) and skin burn. The latter can also lead to skin cancer. The welder protects himself by wearing a welding mask and protective clothing but bystanders are exposed to the same dangers. This is why it is important to protect bystanders in the work place to prevent long-term illness.

When protecting the welding area, it is important not to isolate it from other work areas which is one of the reasons why a welding curtain should be made of transparent material. This not only helps to keep an overview of the work progress, but also allows for a quick response in the case of emergencies. It also prevents the welder from suffering from claustrophobia.

In addition to a wide-range of other products, CEPRO can also provide the necessary materials to construct a welding booth as a non-permanent fixture.

We can also supply a mobile welding booth which is suitable and easier to move to different locations. Not only do these booths provide protection but they also offer flexibility for organizing workspace. They provide an optimal solution because they can be quickly dismantled and removed from the work floor when welding work is not being carried out.

Certification

All CEPRO products used in our welding screens have been approved according to the European EN ISO 25980 standard and are regularly retested and re-certified. Therefore customers are always assured of obtaining a safe product.

Available products

The CEPRO welding screens programme is divided into 4 product groups which are suitable for various applications.

- **CEPRO Robusto welding screens**
Very high quality screens. Because they are solidly built they can be used in even the most demanding working conditions.
- **CEPRO Omnium welding screens**
Sturdy and stylish screens. The CEPRO Omnium welding screen is an all-round welding screen and often used in difficult working conditions.
- **CEPRO Sprint welding screens**
Are quality-made screens. The CEPRO Sprint welding screen can be used in diverse working conditions.
- **CEPRO Gazelle welding screens**
Ideal for use in smaller workspaces and infrequent use. They are very lightweight and can be easily moved by hand.

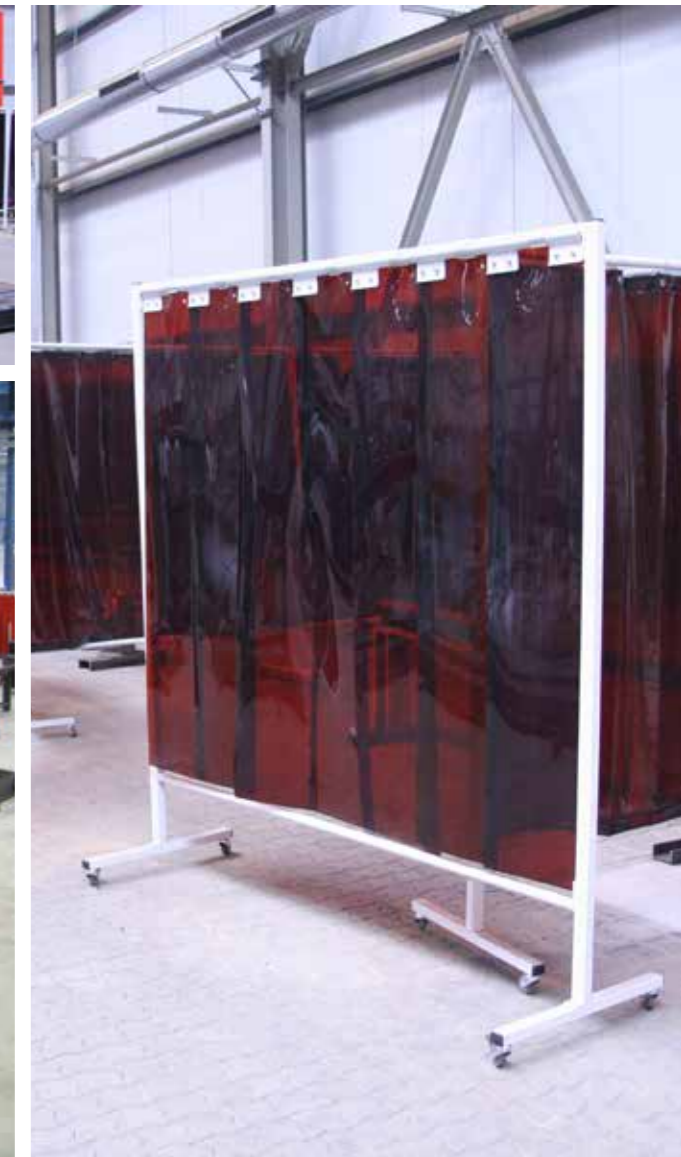
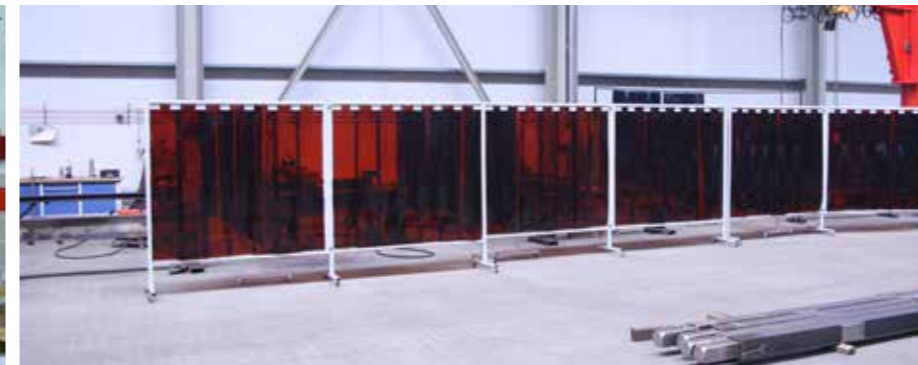

▶ CEPRO ROBUSTO WELDING SCREEN 215CM

- Height 210 cm
- Width central section 215cm
- Standard 4 swivel castors Ø 75mm
- 2 swivel castors with brake and 2 without
- RAL 7035 powder coating finish
- Round 35 x 2.5mm tube
- Rectangular 50 x 30 x 2mm tube

▶ CEPRO ROBUSTO TRIPTYCH WELDING SCREEN 355CM

- Height 210 cm
- Width central section 215cm
- 2 swivel arms each 70cm
- Standard 4 swivel castors Ø 75mm
- 2 swivel castors with brake and 2 without
- RAL 7035 powder coating finish
- Round 35 x 2.5mm tube
- Rectangular 50 x 30 x 2mm tube

▶ CEPRO ROBUSTO WELDING SCREEN 215CM - WITH WELDING CURTAIN

| | |
|-----------------|----------|
| Cepro Orange-CE | 36.32.15 |
| Cepro Green-9 | 36.32.19 |
| Cepro Green-6 | 36.32.16 |
| Cepro Bronze-CE | 36.32.17 |

- Curtain height 180cm
- Plastic suspension rings
- Curtains EN ISO 25980 approved

**EN ISO 25980
APPROVED**



▶ CEPRO ROBUSTO TRIPTYCH WELDING SCREEN 355CM - WITH WELDING CURTAINS

| | |
|-----------------|----------|
| Cepro Orange-CE | 36.31.15 |
| Cepro Green-9 | 36.31.19 |
| Cepro Green-6 | 36.31.16 |
| Cepro Bronze-CE | 36.31.17 |

- Curtain height 180cm
- Plastic suspension rings
- Curtains EN ISO 25980 approved

**EN ISO 25980
APPROVED**



▶ CEPRO ROBUSTO WELDING SCREEN 215CM - WITH WELDING STRIPS

| | |
|-----------------|----------|
| Cepro Orange-CE | 36.32.25 |
| Cepro Green-9 | 36.32.29 |
| Cepro Green-6 | 36.32.26 |
| Cepro Bronze-CE | 36.32.27 |

- Strips height 180cm
- Strips 300 x 2mm
- Overlap strips 10cm
- Plastic suspension clips
- Strips EN ISO 25980 approved

**EN ISO 25980
APPROVED**

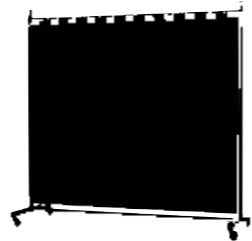

▶ CEPRO ROBUSTO TRIPTYCH WELDING SCREEN 355CM - WITH WELDING STRIPS

| | |
|-----------------|----------|
| Cepro Orange-CE | 36.31.25 |
| Cepro Green-9 | 36.31.29 |
| Cepro Green-6 | 36.31.26 |
| Cepro Bronze-CE | 36.31.27 |

- Strips height 180cm
- Strips 300 x 2mm
- Overlap strips 10cm
- Plastic suspension clips
- Strips EN ISO 25980 approved

**EN ISO 25980
APPROVED**

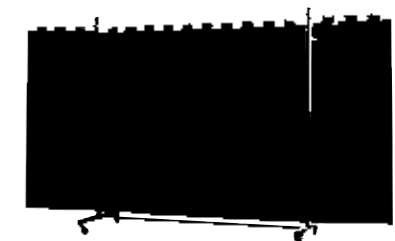

▶ CEPRO ROBUSTO WELDING SCREEN 215CM - SPECIALS

| | |
|---|----------|
| Cepro Atlas heat resistant curtain | 36.32.31 |
| With Cepro Sonic sound absorbing curtain | 36.32.45 |

- Curtain height 180cm
- Atlas curtain 550 °C - A2 - EN 13501-1 approved
- Sonic curtain Rw= 14 dB



▶ CEPRO ROBUSTO TRIPTYCH WELDING SCREEN 355CM - SPECIALS

| | |
|--|----------|
| Cepro Atlas heat resistant curtain | 36.31.31 |
| Cepro Sonic sound absorbing curtain | 36.31.45 |

- Curtain height 180cm
- Atlas curtain 550 °C - A2 - EN 13501-1 approved
- Sonic curtain Rw= 14 dB

**EN ISO 25980
APPROVED**



▶ REPLACEMENT FILLING FOR CEPRO ROBUSTO SINGLE SCREEN 215CM

| | | | |
|--|---------------|---------------------------------------|---------------|
| Cepro Orange-CE replacement curtain | 18.15.18 | Cepro Orange-CE replacement strips | 29.05.18.0010 |
| Cepro Green-9 replacement curtain | 18.19.18 | Cepro Green-9 replacement strips | 29.09.18.0010 |
| Cepro Green-6 replacement curtain | 18.16.18 | Cepro Green-6 replacement strips | 29.06.18.0010 |
| Cepro Bronze-CE replacement curtain | 18.17.18 | Cepro Bronze-CE replacement strips | 29.07.18.0010 |
| Cepro Atlas replacement curtain | 59.01.10.0003 | Cepro Sonic replacement curtain | 92.15.01 |

▶ REPLACEMENT FILLING FOR CEPRO ROBUSTO TRIPTYCH SCREEN 355CM

| | | | |
|--|---------------|---------------------------------------|---------------|
| Cepro Orange-CE replacement curtain | 18.15.18.0001 | Cepro Orange-CE replacement strips | 29.05.18.0016 |
| Cepro Green-9 replacement curtain | 18.19.18.0001 | Cepro Green-9 replacement strips | 29.09.18.0016 |
| Cepro Green-6 replacement curtain | 18.16.18.0001 | Cepro Green-6 replacement strips | 29.06.18.0016 |
| Cepro Bronze-CE replacement curtain | 18.17.18.0001 | Cepro Bronze-CE replacement strips | 29.07.18.0016 |
| Cepro Atlas replacement curtain | 59.01.10.0004 | Cepro Sonic replacement curtain | 92.15.01 |

► **CEPRO ROBUSTO TRIPTYCH XL WELDING SCREEN 435CM**

- Height 210 cm
- Width central section 215cm
- 2 swivel arms each 110cm
- Standard 4 swivel castors Ø 75mm
- 2 swivel castors with brake and 2 without
- RAL 7035 powder coating finish
- Round 35 x 2.5mm tube
- Rectangular 50 x 30 x 2mm tube

► **CEPRO ROBUSTO TRIPTYCH XL WELDING SCREEN 435CM - WITH WELDING CURTAINS**

| | |
|-----------------|----------|
| Cepro Orange-CE | 36.31.65 |
| Cepro Green-9 | 36.31.69 |
| Cepro Green-6 | 36.31.66 |
| Cepro Bronze-CE | 36.31.67 |

- Curtain height 180cm
- Plastic suspension rings
- Curtains EN ISO 25980 approved

**EN ISO 25980
APPROVED**



► **CEPRO ROBUSTO TRIPTYCH XL WELDING SCREEN 435CM - WITH WELDING STRIPS**

| | |
|-----------------|----------|
| Cepro Orange-CE | 36.31.75 |
| Cepro Green-9 | 36.31.79 |
| Cepro Green-6 | 36.31.76 |
| Cepro Bronze-CE | 36.31.77 |

- Strips height 180cm
- Strips 300 x 2mm
- Overlap strips 10cm
- Plastic suspension clips
- Strips EN ISO 25980 approved

**EN ISO 25980
APPROVED**



► **CEPRO ROBUSTO TRIPTYCH XL WELDING SCREEN 435CM - SPECIALS**

| | |
|--|----------|
| Cepro Atlas heat resistant curtain | 36.31.81 |
| Cepro Sonic sound absorbing curtain | 36.31.95 |

- Curtain height 180cm
- Atlas curtain 550 °C - A2 - EN 13501-1 approved
- Sonic curtain Rw= 14 dB



► **REPLACEMENT FILLING FOR CEPRO ROBUSTO TRIPTYCH XL WELDING SCREEN**

| | | | |
|--|---------------|---------------------------------------|---------------|
| Cepro Orange-CE replacement curtain | 18.15.18.0002 | Cepro Orange-CE replacement strips | 29.05.18.0020 |
| Cepro Green-9 replacement curtain | 18.19.18.0002 | Cepro Green-9 replacement strips | 29.09.18.0020 |
| Cepro Green-6 replacement curtain | 18.16.18.0002 | Cepro Green-6 replacement strips | 29.06.18.0020 |
| Cepro Bronze-CE replacement curtain | 18.17.18.0002 | Cepro Bronze-CE replacement strips | 29.07.18.0020 |
| Cepro Atlas replacement curtain | 59.01.10.0005 | Cepro Sonic replacement curtain | 92.15.01 |

► **CEPRO ROBUSTO ACCESSORIES**

- Parts for Robusto screen
- Castors Ø 75 mm
- Round 35 x 2,5mm tube

► **CEPRO ROBUSTO CASTORS**

Castors for Robusto screen
with brake Ø 75 mm 30.04.32.01

Castors for Robusto screen
without brake Ø 75 mm 30.04.32.00



► **CEPRO ROBUSTO SWIVEL ARM 70CM**

| | |
|----------------------------|---------------|
| Without curtains/strips | 30.01.32.07 |
| Cepro Orange-CE curtain | 30.01.32.0715 |
| Cepro Green-9 curtain | 30.01.32.0719 |
| Cepro Green-6 curtain | 30.01.32.0716 |
| Cepro Bronze-CE curtain | 30.01.32.0717 |

| | |
|---------------------------|---------------|
| Without curtains/strips | 30.01.32.07 |
| Cepro Orange-CE strips | 30.01.32.0725 |
| Cepro Green-9 strips | 30.01.32.0729 |
| Cepro Green-6 strips | 30.01.32.0726 |
| Cepro Bronze-CE strips | 30.01.32.0727 |

► **CEPRO ROBUSTO SWIVEL ARM 110CM**

| | |
|----------------------------|---------------|
| Without curtains/strips | 30.01.32.11 |
| Cepro Orange-CE curtain | 30.01.32.1115 |
| Cepro Green-9 curtain | 30.01.32.1119 |
| Cepro Green-6 curtain | 30.01.32.1116 |
| Cepro Bronze-CE curtain | 30.01.32.1117 |

| | |
|---------------------------|---------------|
| Without curtains/strips | 30.01.32.11 |
| Cepro Orange-CE strips | 30.01.32.1125 |
| Cepro Green-9 strips | 30.01.32.1129 |
| Cepro Green-6 strips | 30.01.32.1126 |
| Cepro Bronze-CE strips | 30.01.32.1127 |

► **CEPRO ROBUSTO SPECIAL HINGE FOR SWIVEL ARM**

Special additional hinge-point for Robusto screen
30.01.32

- Suitable for positioning swivel arm parallel to the screen.

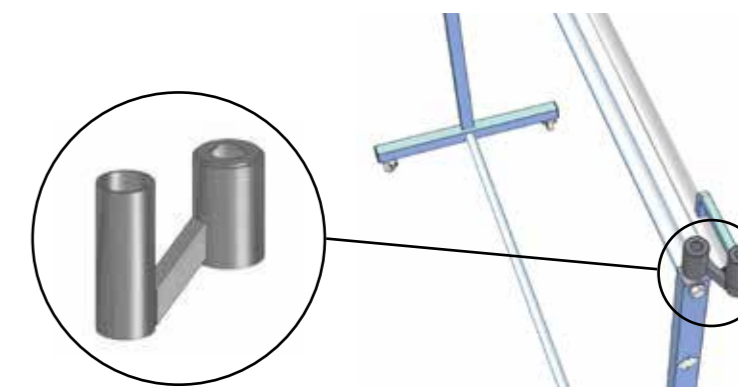

▶ CEPRO OMNIUM WELDING SCREEN 215CM

- Height 200 cm
- Width central section 215cm
- Standard 4 swivel castors Ø 50mm
- 2 swivel castors with brake and 2 without
- RAL 7035 powder coating finish
- Round 30 x 2mm tube
- Rectangular 40 x 30 x 2mm tube

▶ CEPRO OMNIUM TRIPTYCH WELDING SCREEN 375CM

- Height 200 cm
- Width central section 215cm
- 2 swivel arms each 80cm
- Standard 4 swivel castors Ø 50mm
- 2 swivel castors with brake and 2 without
- RAL 7035 powder coating finish
- Round 30 x 2mm tube
- Rectangular 40 x 30 x 2mm tube

▶ CEPRO OMNIUM WELDING SCREEN 215CM - WITH WELDING CURTAIN

| | | |
|-----------------|----------|--|
| Cepro Orange-CE | 36.34.15 | <ul style="list-style-type: none"> • Curtain height 160cm • Plastic suspension rings • Curtains EN ISO 25980 approved |
| Cepro Green-9 | 36.34.19 | |
| Cepro Green-6 | 36.34.16 | |
| Cepro Bronze-CE | 36.34.17 | |

EN ISO 25980 APPROVED



▶ CEPRO OMNIUM TRIPTYCH WELDING SCREEN 375CM - WITH WELDING CURTAINS

| | | |
|-----------------|----------|--|
| Cepro Orange-CE | 36.36.15 | <ul style="list-style-type: none"> • Curtain height 160cm • Plastic suspension rings • Curtains EN ISO 25980 approved |
| Cepro Green-9 | 36.36.19 | |
| Cepro Green-6 | 36.36.16 | |
| Cepro Bronze-CE | 36.36.17 | |

EN ISO 25980 APPROVED



▶ CEPRO OMNIUM WELDING SCREEN 215CM - WITH WELDING STRIPS

| | | |
|-----------------|----------|--|
| Cepro Orange-CE | 36.34.25 | <ul style="list-style-type: none"> • Strip height 160cm • Strips 300 x 2mm • Overlap strips 5cm • Plastic suspension clips • Strips EN ISO 25980 approved |
| Cepro Green-9 | 36.34.29 | |
| Cepro Green-6 | 36.34.26 | |
| Cepro Bronze-CE | 36.34.27 | |

EN ISO 25980 APPROVED



▶ CEPRO OMNIUM TRIPTYCH WELDING SCREEN 375CM - WITH WELDING STRIPS

| | | |
|-----------------|----------|---|
| Cepro Orange-CE | 36.36.25 | <ul style="list-style-type: none"> • Strips height 160cm • Strips 300 x 2mm • Overlap strips 5cm • Plastic suspension clips • Strips EN ISO 25980 approved |
| Cepro Green-9 | 36.36.29 | |
| Cepro Green-6 | 36.36.26 | |
| Cepro Bronze-CE | 36.36.27 | |

EN ISO 25980 APPROVED

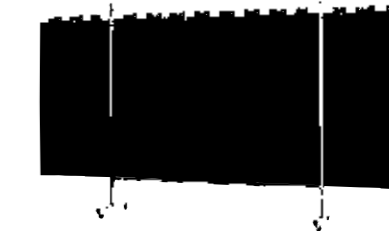

▶ CEPRO OMNIUM WELDING SCREEN 215CM - WITH WELDING SHEET

| | | |
|-----------------|----------|--|
| Cepro Orange-CE | 36.34.05 | <ul style="list-style-type: none"> • Sheet height 160cm • Sheets 570 x 1mm • Metal tube clamps • Sheet EN ISO 25980 approved |
| Cepro Green-9 | 36.34.09 | |
| Cepro Green-6 | 36.34.06 | |
| Cepro Bronze-CE | 36.34.07 | |

EN ISO 25980 APPROVED



▶ CEPRO OMNIUM TRIPTYCH WELDING SCREEN 375CM - WITH WELDING SHEET

| | | |
|-----------------|----------|--|
| Cepro Orange-CE | 36.36.05 | <ul style="list-style-type: none"> • Sheet height 160cm • Sheets 570 x 1mm • Metal tube clamps • Sheet EN ISO 25980 approved |
| Cepro Green-9 | 36.36.09 | |
| Cepro Green-6 | 36.36.06 | |
| Cepro Bronze-CE | 36.36.07 | |

EN ISO 25980 APPROVED

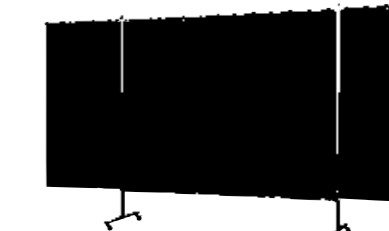

▶ REPLACEMENT FILLING FOR CEPRO OMNIUM SINGLE SCREEN 215CM

| | | |
|--|--|---|
| Cepro Orange-CE replacement curtain 18.15.16 | Cepro Orange-CE replacement strips 29.05.16.0008 | Cepro Orange-CE replacement sheet 22.15.16.0004 |
| Cepro Green-9 replacement curtain 18.19.16 | Cepro Green-9 replacement strips 29.09.16.0008 | Cepro Green-9 replacement sheet 22.19.16.0004 |
| Cepro Green-6 replacement curtain 18.16.16 | Cepro Green-6 replacement strips 29.06.16.0008 | Cepro Green-6 replacement sheet 22.16.16.0004 |
| Cepro Bronze-CE replacement curtain 18.17.16 | Cepro Bronze-CE replacement strips 29.07.16.0008 | Cepro Bronze-CE replacement sheet 22.17.16.0004 |

▶ REPLACEMENT FILLING FOR CEPRO OMNIUM TRIPTYCH SCREEN 375CM

| | | |
|---|--|---|
| Cepro Orange-CE replacement curtain 18.15.16.0001 | Cepro Orange-CE replacement strips 29.05.16.0014 | Cepro Orange-CE replacement sheet 2 x 22.15.16.0004 |
| Cepro Green-9 replacement curtain 18.19.16.0001 | Cepro Green-9 replacement strips 29.09.16.0014 | Cepro Green-9 replacement sheet 2 x 22.19.16.0004 |
| Cepro Green-6 replacement curtain 18.16.16.0001 | Cepro Green-6 replacement strips 29.06.16.0014 | Cepro Green-6 replacement sheet 2 x 22.16.16.0004 |
| Cepro Bronze-CE replacement curtain 18.17.16.0001 | Cepro Bronze-CE replacement strips 29.07.16.0014 | Cepro Bronze-CE replacement sheet 2 x 22.17.16.0004 |

► **CEPRO OMNIUM TRIPTYCH XL WELDING SCREEN 435CM**

- Height 200 cm
- Width central section 215cm
- 2 swivel arms each 110cm
- Standard 4 swivel castors Ø 50mm
- 2 swivel castors with brake and 2 without
- RAL 7035 powder coating finish
- Round 30 x 2mm tube
- Rectangular 40 x 30 x 2mm tube

► **CEPRO OMNIUM TRIPTYCH XL WELDING SCREEN 435CM - WITH WELDING CURTAINS**

| | |
|-----------------|----------|
| Cepro Orange-CE | 36.36.65 |
| Cepro Green-9 | 36.36.69 |
| Cepro Green-6 | 36.36.66 |
| Cepro Bronze-CE | 36.36.67 |

- Curtain height 160cm
- Plastic suspension rings
- Curtains EN ISO 25980 approved

**EN ISO 25980
APPROVED**



► **REPLACEMENT CURTAIN FOR CEPRO OMNIUM TRIPTYCH XL SCREEN 435CM**

| | |
|-----------------|---------------|
| Cepro Orange-CE | 18.15.16.0002 |
| Cepro Green-9 | 18.19.16.0002 |
| Cepro Green-6 | 18.16.16.0002 |
| Cepro Bronze-CE | 18.17.16.0002 |

- Curtain height 160cm
- Curtains EN ISO 25980 approved

**EN ISO 25980
APPROVED**



► **CEPRO OMNIUM ACCESSOIRES**

- Parts for Omnium screen
- Castors Ø 50mm
- Round 30 x 2mm tube

► **CEPRO OMNIUM CASTORS**

Castors for Omnium screen with brake Ø 50mm 30.04.34.01

Castors for Omnium screen without brake Ø 50mm 30.04.34.00

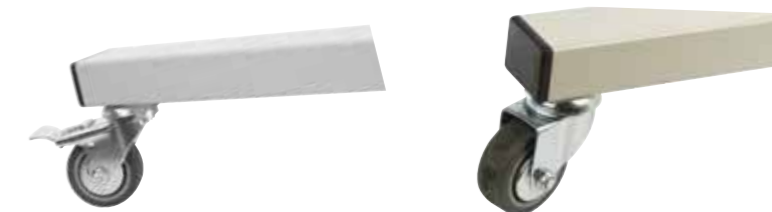

► **CEPRO OMNIUM SWIVEL ARM 80CM**

Without curtains/strips 30.01.34.08

Cepro Orange-CE curtain 30.01.34.0815

Cepro Green-9 curtain 30.01.34.0819

Cepro Green-6 curtain 30.01.34.0816

Cepro Bronze-CE curtain 30.01.34.0817

Without curtains/strips 30.01.34.08

Cepro Orange-CE strips 30.01.34.0825

Cepro Green-9 strips 30.01.34.0829

Cepro Green-6 strips 30.01.34.0826

Cepro Bronze-CE strips 30.01.34.0827

► **CEPRO OMNIUM SWIVEL ARM 110CM**

Without curtains 30.01.32.11

Cepro Orange-CE curtain 30.01.34.1115

Cepro Green-9 curtain 30.01.34.1119

Cepro Green-6 curtain 30.01.34.1116

Cepro Bronze-CE curtain 30.01.34.1117

► **CEPRO OMNIUM SPECIAL HINGE FOR SWIVEL ARM**

Special additional hinge-point for Omnium screen 30.01.32

- Suitable for positioning swivel arm parallel to the screen.

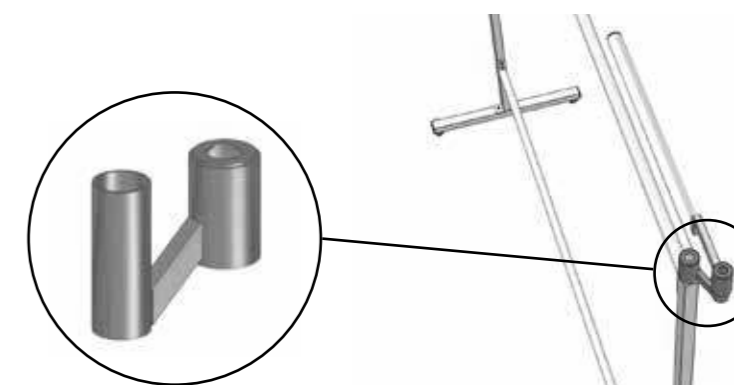

PRODUCT FACT SHEETS

i For all welding screens product fact sheets are available with information about dimensions, mounting etc.

Please visit our website or contact our sales department for more information.



CEPRO SPRINT WELDING SCREEN

- Height 193cm
- Width 192cm
- Without castors (optional)
- RAL 9005 powder coating finish
- Round galvanized 22 x 1mm tube
- Square 30 x 30 x 2mm tube

CEPRO SPRINT WELDING SCREEN - WITH WELDING CURTAINS

| | |
|-----------------|----------|
| Cepro Orange-CE | 36.38.15 |
| Cepro Green-9 | 36.38.19 |
| Cepro Green-6 | 36.38.16 |
| Cepro Bronze-CE | 36.38.17 |

- Curtain height 160cm
- Steel suspension rings
- Curtains EN ISO 25980 approved



CEPRO SPRINT WELDING SCREEN - WITH WELDING SHEET

| | |
|-----------------|----------|
| Cepro Orange-CE | 36.38.05 |
| Cepro Green-9 | 36.38.09 |
| Cepro Green-6 | 36.38.06 |
| Cepro Bronze-CE | 36.38.07 |

- Sheet height 160cm
- Sheets 570 x 1mm
- Metal tube clamps
- Sheet EN ISO 25980 approved



CEPRO SPRINT CASTORS

Set castors for Sprint screen
2 with brake and 2 without 30.06.34

Castors for Sprint screen
with brake Ø 50mm 30.04.34.01

Castors for Sprint screen
without brake Ø 50mm 30.04.34.00



REPLACEMENT FILLING FOR CEPRO SPRINT WELDING SCREEN

| | | | |
|--|----------|--------------------------------------|---------------|
| Cepro Orange-CE replacement curtain | 18.15.16 | Cepro Orange-CE replacement sheet | 22.15.16.0004 |
| Cepro Green-9 replacement curtain | 18.19.16 | Cepro Green-9 replacement sheet | 22.19.16.0004 |
| Cepro Green-6 replacement curtain | 18.16.16 | Cepro Green-6 replacement sheet | 22.16.16.0004 |
| Cepro Bronze-CE replacement curtain | 18.17.16 | Cepro Bronze-CE replacement sheet | 22.17.16.0004 |

CEPRO GAZELLE WELDING SCREEN

- Height 200 cm
- Width 200cm / 140cm
- Without castors
- Galvanized frame
- Round 25 x 1mm tube
- Fitted with a curtain with an open seam on the top and bottom

CEPRO GAZELLE WELDING SCREEN 140CM

| | |
|-----------------|----------|
| Cepro Orange-CE | 36.39.15 |
| Cepro Green-9 | 36.39.19 |
| Cepro Green-6 | 36.39.16 |
| Cepro Bronze-CE | 36.39.17 |

- Curtain height 176cm
- Fitted curtain with an open seam at the top and bottom
- Curtain EN ISO 25980 approved

**EN ISO 25980
APPROVED**



CEPRO GAZELLE WELDING SCREEN 200CM

| | |
|-----------------|----------|
| Cepro Orange-CE | 36.39.25 |
| Cepro Green-9 | 36.39.29 |
| Cepro Green-6 | 36.39.26 |
| Cepro Bronze-CE | 36.39.27 |

- Curtain height 176cm
- Fitted curtain with an open seam at the top and bottom
- Curtain EN ISO 25980 approved

**EN ISO 25980
APPROVED**



REPLACEMENT CURTAINS FOR CEPRO GAZELLE WELDING SCREEN

| | | | |
|-------------------------------|-------------|-------------------------------|-------------|
| Cepro Orange-CE 140cm wide | 13.15.04.14 | Cepro Orange-CE 200cm wide | 13.15.04.20 |
| Cepro Green-9 140cm wide | 13.19.04.14 | Cepro Green-9 200cm wide | 13.19.04.20 |
| Cepro Green-6 140cm wide | 13.16.04.14 | Cepro Green-6 200cm wide | 13.16.04.20 |
| Cepro Bronze-CE 140cm wide | 13.17.04.14 | Cepro Bronze-CE 200cm wide | 13.17.04.20 |



CEPRO GAZELLE WELDING SCREEN

The Gazelle welding screen is designed for use in small workplaces or when the use is not very frequent. When work needs to be regularly done in different places or when flexibility in the organization of the working space is required, protection with movable screens can offer a better alternative.



▶ SONIC CLASSIC

Welding and grinding operations are one of the most important noise sources in industrial working environments. Prolonged exposure to high noise concentrations can damage ear drums and cause noise-related deafness. Besides personal suffering, this often means long term absences through illness or high costs as a result of permanent disability. In less serious cases, too much noise is often the cause of loss of concentration and consequently loss of quality and lower production volumes.

The unique, compact construction of the CEPRO SONIC wall system with built-in soundproof elements not only produces sound attenuation but also effective noise reduction in the rest of the working environment. The modular system can be easily and quickly assembled (and is therefore cost-reducing), moved, expanded or changed into another configuration. The CEPRO SONIC wall system exceeds the quality and effectiveness of all other branded systems of its competitors.

▶ Certification

All CEPRO soundproof SONIC products were extensively tested by internationally reputed testing organisations. Measurement statistics of all tests are available. The flame extinction properties of these products were also tested where necessary.

▶ Available models

- CEPRO Sonic Classic wall elements for building up a welding booth
- CEPRO Sonic Classic accessories, for further expanding your welding booth
- CEPRO Sonic Classic supports, to complete your welding booth
- CEPRO Sonic Classic grinding booths, fitted with sound absorbing roof.

▶ Made to size

CEPRO can also offer you tailor made and constructed installations. This goes for dimensions, design and colour scheme. You can count on receiving professional advice from one of our advisors. Please contact our sales department to make an appointment.

▶ Projects

CEPRO is a specialist in solutions for specific problems which occur in the welding and grinding work area. Sometimes these problems are isolated problems but mostly they are combinations and are part of an overall safety policy. CEPRO knows more than anybody else how to optimally combine the properties of its different products with those of others into a pleasant workplace which meets all safety and efficiency requirements. During the optimisation of a workplace we are in many cases also confronted with other issues which are important such as concerns about the evacuation of harmful welding gases, the supply of gas and oxygen, air conditioning, communication systems or even the most efficient way of supplying electricity to the workplace.

Many entrepreneurs therefore consider the involvement of CEPRO an ideal opportunity to optimise workplaces, straighten out logistics and workflow and upgrade general and technical aspects.

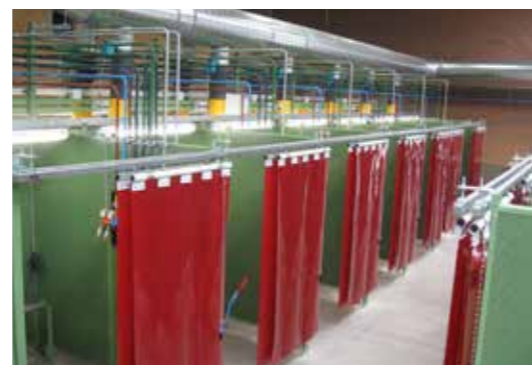

► **CEPRO SONIC CLASSIC WALL ELEMENTS**

- Height 2.220mm
- Width 1.012 or 512mm
- Thickness 50mm
- Standard ± 180mm free space at the bottom
- Finish in powdercoating

► **CEPRO SONIC SOUND INSULATING WALL ELEMENT**

Sonic Classic wall element 1.012mm
Width 1.012mm
Height 2.220mm
Thickness 50mm

In green RAL 6011 45.00.00.2010
In grey RAL 7035 45.00.10.2010

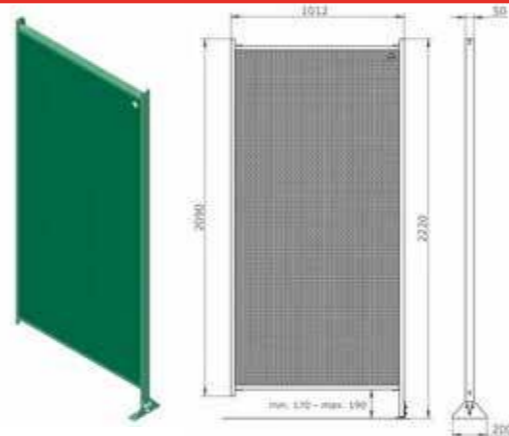

► **CEPRO SONIC SOUND INSULATING WALL ELEMENT**

Sonic Classic wall element 512mm
Width 512mm
Height 2.220mm
Thickness 50mm

In green RAL 6011 45.00.00.2005
In grey RAL 7035 45.00.10.2005

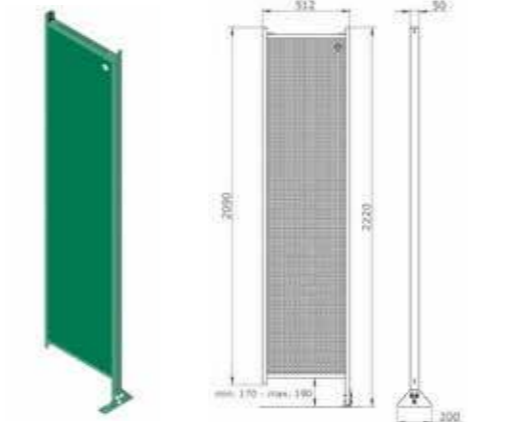

► **CEPRO SONIC SOUND INSULATING WALL ELEMENT**

Sonic Classic wall element with Impact Bronze window
Width 1.012mm
Height 2.220mm
Thickness 50mm

In green RAL 6011 45.00.03.2010
In grey RAL 7035 45.00.13.2010

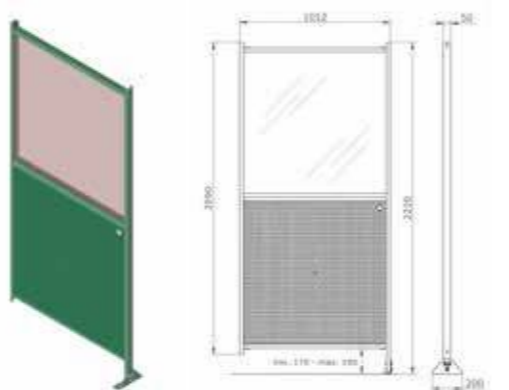

► **CEPRO SONIC CONNECTING POLES**

Sonic joining pole height 2.090mm
For connecting Sonic wall elements in an angle of 90° or as a cross bond. Made from square tube 50 x 50mm,
In green RAL 6011 45.20.01
In grey RAL 7035 45.20.11

Sonic joining pole extra long, for mounting fume extraction arm.
45.30.15.0001

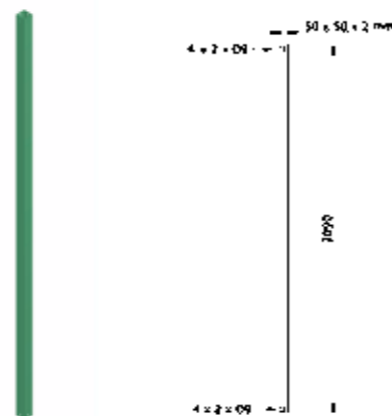

► **CEPRO SONIC CLASSIC ACCESSORIES**

SONIC FOOT

Sonic adjustable foot for floor mounting.

In green RAL 6011 45.10.00
In grey RAL 7035 45.10.10

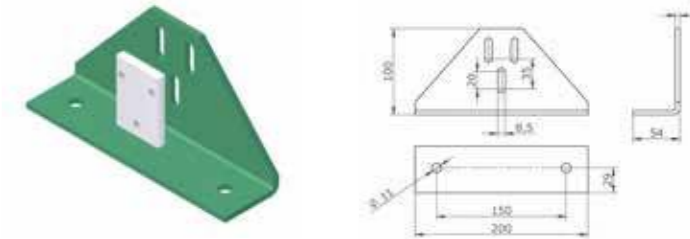

ADJUSTABLE FOOT SPECIAL VERSION

For mounting a Sonic wall element directly along a wall.

RAL 6011, left version 45.10.02
RAL 6011, right version 45.10.03
RAL 7035, left version 45.10.12
RAL 7035, right version 45.10.13

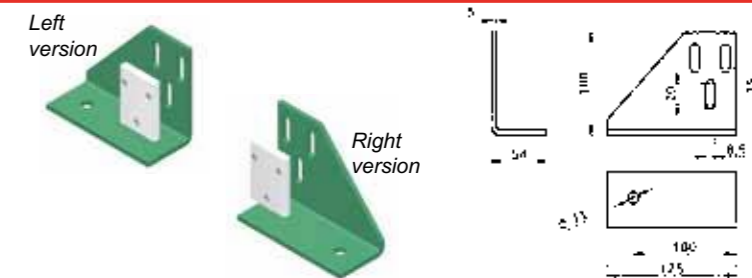

EXTENSION ADJUSTABLE FOOT

Extension for fitting an extra foot to a Sonic wall element.

The extension is galvanized.

45.35.20

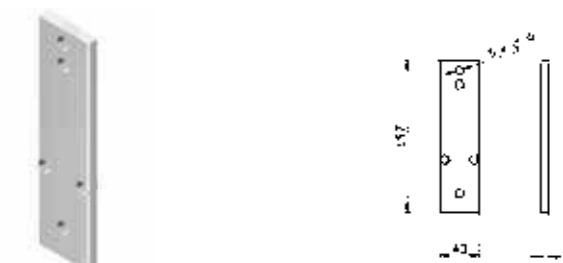

SUPPORT

Support for fixing rail or tube support.

This support is galvanized.

80.10.01

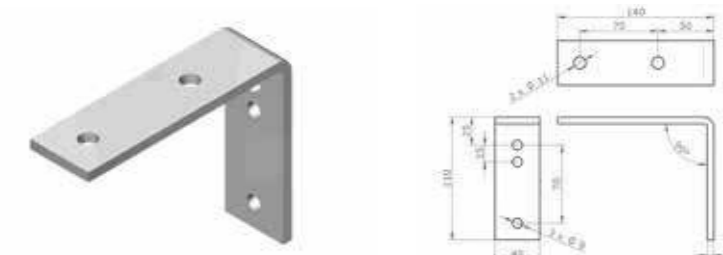

SUPPORT, SPECIAL VERSION

Support for fixing rail or tube support to the side of a Sonic wall element.

This support is galvanized.

Left version 45.35.02
Right version 45.35.03

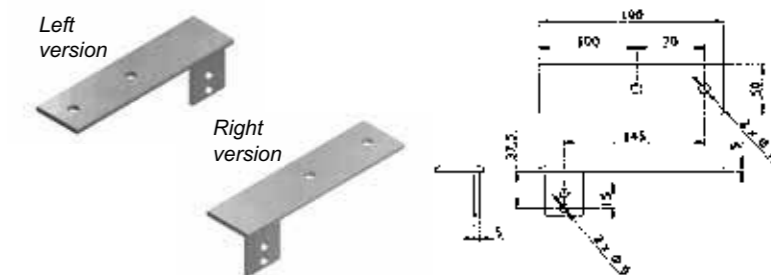

SUPPORT EXTRA LONG

Support for fixing rail or tube support, extra long version

This support is galvanized.

45.35.05

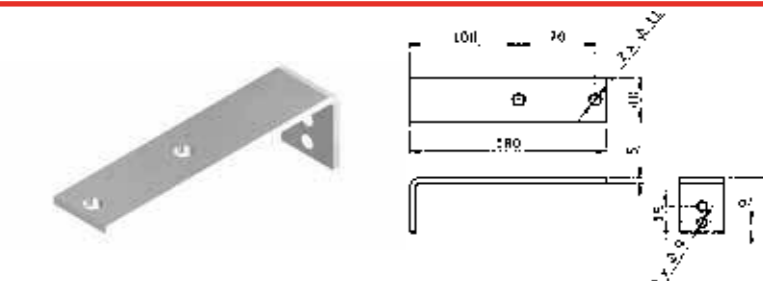

► **CEPRO SONIC CLASSIC GRINDING BOOTHS**

- Height 2500mm
- Walls are perforated on the inside only
- Thickness 50mm
- RAL 6011 powder coated
- Fitted with floor profiles
- Door fitted with an anti-panic closing

► **CEPRO SONIC CLASSIC GRINDING BOOTH**

Width 2.124mm
Depth 2.124mm
Height 2.552mm

The elements are perforated on the inside only. The booth is fitted with a sound insulating door, which is provided with an anti-panic closing on the inside and a door catch on the outside.

CEPRO grinding booths are standard finished in powder coating, colour green RAL 6011. The color of the door is RAL 9006.

46.05.22

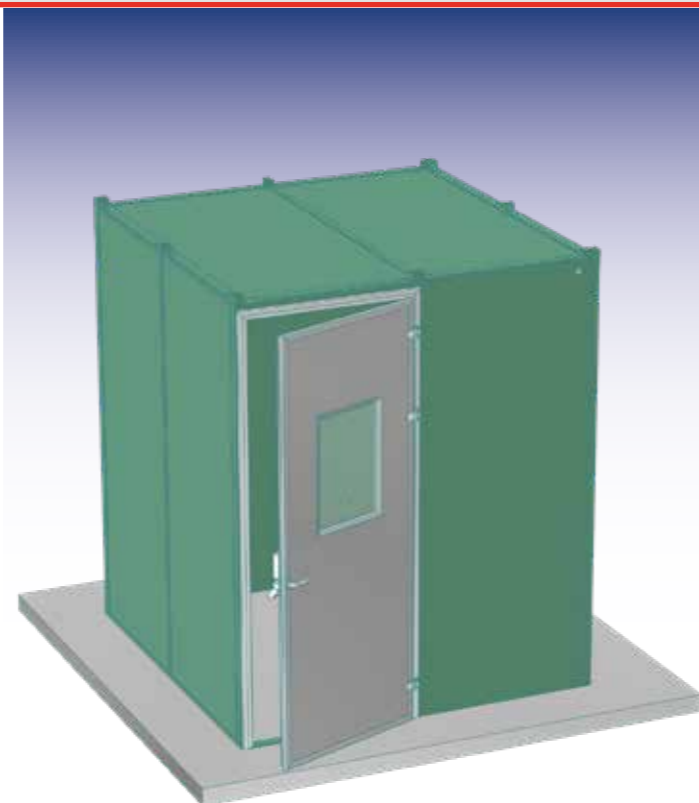

► **CEPRO WORKPLACE SEPARATION**

► **SONIC SOUND INSULATING SCREEN**

Height 2.208mm
Width 2.124mm
Thickness 50mm

This screen is made of two Sonic elements which are placed in a movable frame. In this way you will have utmost flexibility in shielding the source of noise in your workplace.

Movable on four heavy duty castors (100mm Ø) with brake, finished in powder coating green RAL 6011.

46.30.00.2221

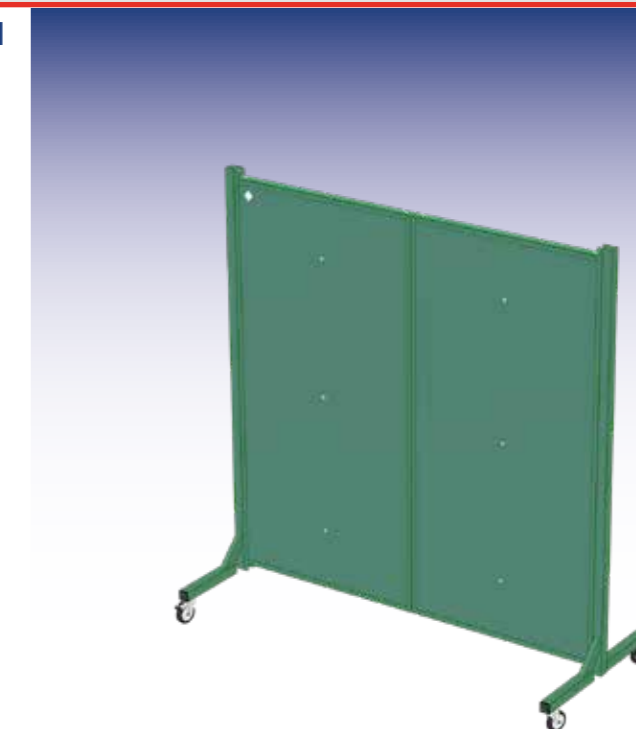

► **CEPRO SONIC CLASSIC GRINDING BOOTH**

Width 3.136mm
Depth 2.124mm
Height 2.552mm

The elements are perforated on the inside only. The booth is fitted with a sound insulating door, which is provided with an anti-panic closing on the inside and a door catch on the outside.

CEPRO grinding booths are standard finished in powder coating, colour green RAL 6011. The color of the door is RAL 9006.

46.05.23

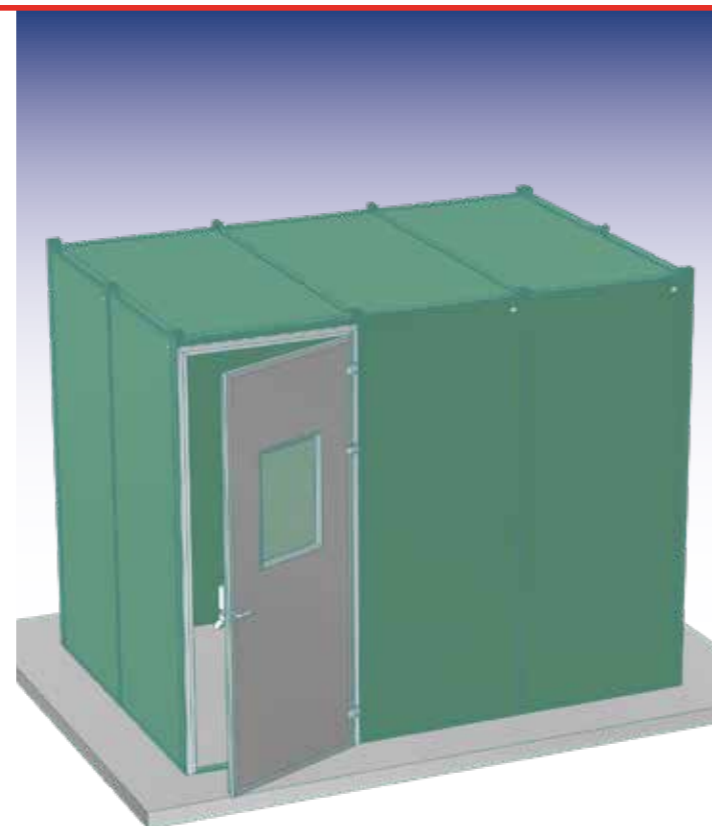

► **SONIC SOUND ABSORBING CURTAIN**

A sound absorbing curtain which offers protection against noise nuisance. Fitted on the top side with metal eyelets.

Only available as a custom curtain. Maximum width 150cm, separate curtains to be connected with a Velcro closure. One side mesh and one side PVC coated fabric. Per square meter.

92.15.01



(fitted in Cepro Robusto screen)

DIAMOND RIGID SHEET SYSTEM

CEPRO diamond rigid sheets are developed to separate the workplace in general. For example, they can be used to shield parts of the workplace from view. You can also create a physical barrier between a production area and the rest of the workplace.

Available models

- CEPRO Diamond rigid sheet wall elements for building up a booth or separation
- CEPRO Diamond rigid sheet accessories, for further expanding your booth or separation
- CEPRO Diamond rigid sheet supports, to complete your booth or separation

Technical information

- CEPRO Diamond rigid sheet products are meant for use indoors
- The nuts and bolts used to connect the frame should be checked regularly
- CEPRO Diamond rigid sheet booths and separations are delivered with a clear mounting instruction

Made to size

CEPRO can also offer you tailor made and constructed installations. This goes for dimensions, design and colour scheme. You can count on receiving professional advice from one of our advisors. Please contact our sales department to make an appointment.

Projects

CEPRO is a specialist in solutions for specific problems which occur in the welding and grinding work area. Sometimes these problems are isolated problems but mostly they are combinations and are part of an overall safety policy. CEPRO knows more than anybody else how to optimally combine the properties of its different products with those of others into a pleasant workplace which meets all safety and efficiency requirements. During the optimisation of a workplace we are in many cases also confronted with other issues which are important such as concerns about the evacuation of harmful welding gases, the supply of gas and oxygen, air conditioning, communication systems or even the most efficient way of supplying electricity to the workplace.

Many entrepreneurs therefore consider the involvement of CEPRO an ideal opportunity to optimise workplaces, straighten out logistics and workflow and upgrade general and technical aspects.



CEPRO DIAMOND RIGID SHEET SYSTEM

- Height 2.000mm
- Width 940 or 440mm
- Thickness 30mm
- Standard ± 150mm free space at the bottom
- RAL 7035 powder coated

CEPRO DIAMOND PLATE WALL ELEMENT

Diamond plate wall element
Width 940mm
Height 2.000mm
Thickness 30mm

45.70.01.2010

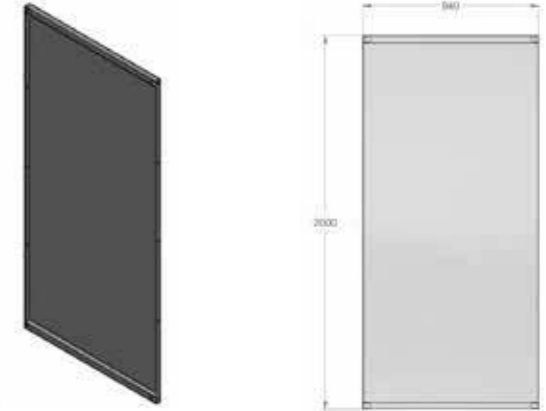

CEPRO DIAMOND PLATE WALL ELEMENT

Diamond plate wall element
Width 440mm
Height 2.000mm
Thickness 30mm

45.70.01.2005

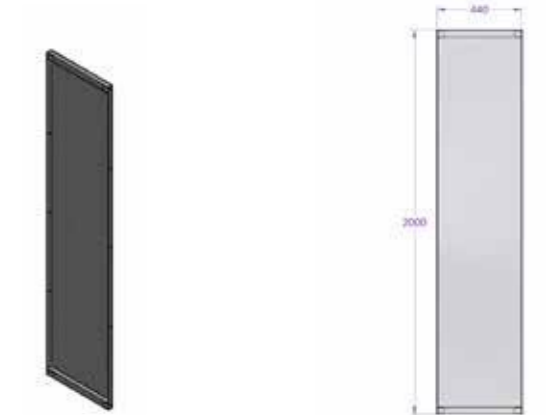

CEPRO DIAMOND PLATE WALL ELEMENT

Diamond plate wall element with Impact window
Width 940mm
Height 2.000mm
Thickness 30mm

45.70.03.2010

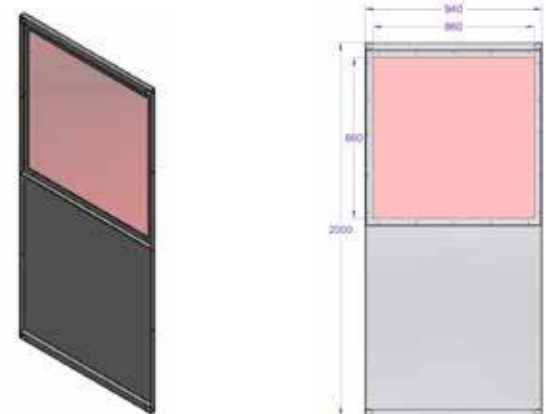

CEPRO DIAMOND PLATE ACCESORIES

Joining pole height 2.160mm
For connecting Diamond plate elements together. You must start and end each element with a support.
Made from square tube 40x40x2mm.
45.70.20.2160

Joining pole height 2.160mm
For use at the end of a sequence of Diamond plate elements to give more stability. Made from square tube 100x40x2mm,
45.70.21.2160

Diamond plate foot support, to be mounted on 2 sides of each support
45.70.10

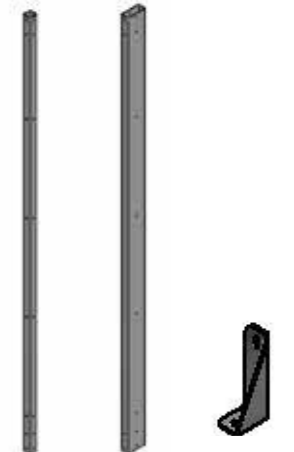

For all Diamond plate products special conditions apply.
The freight charges will be calculated and invoiced separately on each order.

CEPRO WELDING TABLES

- Height 80cm
- Made from profiles 40 x 40mm
- Available with grill top and/or bricks
- RAL 6011 powder coated

WELDING TABLE WITH GRILL TOP AND BRICKS

Welding table with grill top and bricks
width 85cm 45.41.01.6385

- Height 80cm
- Depth 63cm
- Bare metal grill top
- Fire proof bricks

Welding table with grill top and bricks
width 110cm 45.41.01.6311



WELDING TABLE WITH GRILL TOP

Welding table with grill top
width 60cm 45.41.02.6360

- Height 80cm
- Depth 63cm
- Bare metal grill top

Welding table with grill top
width 85cm 45.41.02.6385

Welding table with grill top
width 110cm 45.41.02.6311



ACCESORIES WELDING TABLE WITH GRILL TOP AND BRICKS

Fire proof bricks 45.49.01.0001

Support plate for bricks 45.49.01.0002

Grill top (bare metal) 620 x 590 mm
for welding table with grill and bricks 63 x 85 cm
for welding table with grill 63 x 60 cm
45.49.02.6259

Grill top (bare metal) 620 x 840 mm
for welding table with grill and bricks 63 x 110 cm
for welding table with grill 63 x 85 cm
45.49.02.6284

Grill top (bare metal) 620 x 1190 mm
for welding table with grill 63 x 110 cm
45.49.02.6209

Support for fixing objects to welding table
45.49.50.0001



OUTDOOR WELDING

When welding in the open air it is important to be protected from all kinds of weather, such as rain, wind, sun, etc. Working conditions are noticeably improved if a welding tent or welding umbrella is used. This level of protection for the welder has proved to contribute to a reduction in sick leave.

Available products

The CEPRO outdoor welding program is divided into 2 product groups which are suitable for various applications.

CEPRO welding tents

Our welding tents are extremely suitable for work in the open air. Work can be continued for longer periods and due to the improvement of working conditions, sick leave will be greatly reduced.

CEPRO welding umbrellas

Our welding umbrellas are specially designed for working outdoors. They provide reliable temporary protection of the work site from sun or rain.



CEPRO WELDING TENTS

- Approved to the M-1 standard
- PVC fabric 570 gr/m²
- Protection skirt 200mm all-around
- Front and back can be closed with a rope-lock

CEPRO WELDING TENT CUBE MODEL

Welding tent cube model
200 x 190cm 91.20.11

- Width 190cm
- Depth 200cm
- Height 200cm

Cover welding tent cube model
200 x 190cm 90.20.11

Frame welding tent cube model
200 x 190cm 90.20.02



- Ridge height 220cm
- Frame Ø 25mm galvanized
- Packing suitable for parcel service

CEPRO WELDING TENT CUBE MODEL XL

Welding tent cube model XL
300 x 190cm 91.20.19

- Width 190cm
- Depth 300cm
- Height 200cm

Cover welding tent cube model XL
300 x 190cm 90.20.19

Extension for standard frame welding tent cube model
300 x 190cm 90.20.09
Only available in combination with article 90.20.02



- Ridge height 220cm
- Frame Ø 25mm galvanized
- Packing suitable for parcel service

CEPRO WELDING TENT HEAVY DUTY MODEL XL

Welding tent heavy duty XL model
300 x 200cm 91.20.20.3020

- Width 200cm
- Depth 300cm
- Height 200cm

Cover welding tent heavy duty XL model
300 x 200cm 90.20.20.3020

Frame welding tent heavy duty XL model
300 x 200cm **on request**



- Ridge height 220cm
- Frame Ø 33.7mm galvanized
- Including hoisting loops

CEPRO WELDING TENT HEAVY DUTY MODEL XXL

Welding tent heavy duty XXL model
300 x 300cm 91.20.20.3030

- Width 300cm
- Depth 300cm
- Height 200cm

Cover welding tent heavy duty XXL model
300 x 300cm 90.20.20.3030

Frame welding tent heavy duty XXL model
300 x 300cm **on request**



- Ridge height 220cm
- Frame Ø 33.7mm galvanized
- Including hoisting loops

CEPRO WELDING UMBRELLAS

- Flame retardant and water repellent canvas
- Canvas fabric 280 gr/m²
- Colour green
- Carrying bag included
- Windbreaker on the top side

WELDING UMBRELLA MEDIUM DUTY

Welding umbrella medium duty
Ø 220cm 93.21.20

- Ø 220cm
- With tilt mechanism
- 10 ribs, length 110cm

- Mast Ø 28mm
- Mast in 2 parts, total height 220cm
- Ends of the ribs are fitted with caps



WELDING UMBRELLA HEAVY DUTY

Welding umbrella heavy duty
Ø 300cm 93.71.20

- Ø 300cm
- Fitted with crank system
- 8 ribs, length 150cm
- Mast Ø 38mm

- Mast in 2 parts, total height 220cm
- Ends of the ribs are fitted with metal caps
- Groundpin included



CONSTRUCTION

CEPRO offers an extensive range of swivel arms, columns and poles and construction parts making it possible to combine a wide variety of protection items and booths. CEPRO swivel arms, columns and poles and construction parts are characterized by their excellent quality and ease of use. You can find the appropriate arm, column or pole and its related supports and mounting parts for each application. We are ready to meet your special requirements. Please consult our sales department.

Available products

The CEPRO range includes a large variety of products such as:

- Pipe swivel arm
- Modular swivel arm
- Swivel heavy duty arm
- Swivel joint arm
- Poles and columns
- Rail and tube system parts
- Cable reel

Each of these CEPRO products has been developed for use in specific working conditions for the optimal fit-out of a workplace.

Made to size

CEPRO can also offer you tailor made and constructed installations. This goes for dimensions, design and colour scheme. You can count on receiving professional advice from one of our advisors. Please contact our sales department to make an appointment.

Projects

CEPRO is a specialist in solutions for specific problems which occur in the welding and grinding work area. Sometimes these problems are isolated problems but mostly they are combinations and are part of an overall safety policy. CEPRO knows more than anybody else how to optimally combine the properties of its different products with those of others into a pleasant workplace which meets all safety and efficiency requirements. During the optimisation of a workplace we are in many cases also confronted with other issues which are important such as concerns about the evacuation of harmful welding gases, the supply of gas and oxygen, air conditioning, communication systems or even the most efficient way of supplying electricity to the workplace.

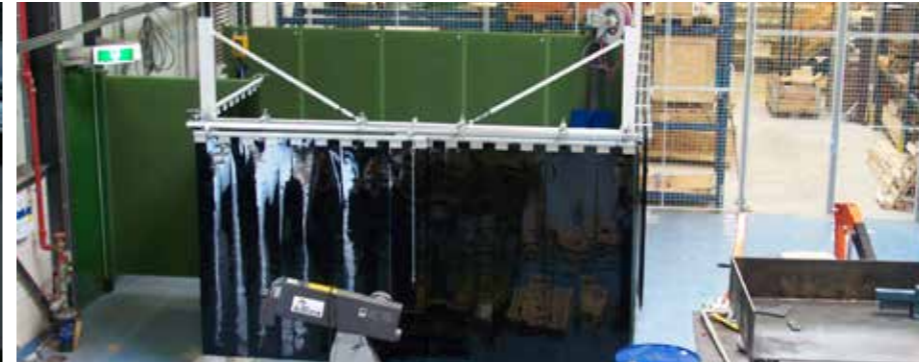

CEPRO SWIVEL ARMS

CEPRO PIPE SWIVEL ARM 200CM

Maximum length 2 meter, produced from tube of 35mm Ø. This product is finished with a grey (RAL 7035) powder-coating. Fitted with a mechanical hinge and an assembly plate for fixing the arm against a wall or column.

82.10.15



1. Choose the type of separation; curtains or strip (2 or 3 mm)
2. Choose the required height of the separation
3. Then you will find the suitable pole for this arm and separation. Details on page 63.

| 82.10.15 Swivel arm length 200cm | Curtain | | | Strips 300 x 2 mm | | | Strips 300 x 3 mm | | |
|----------------------------------|--|--|--|--|--|--|--|--|------------|
| | Height under beam | | | Height under beam | | | Height under beam | | |
| | 1,85 mtr | 2,10 mtr | 2,60 mtr | 1,85 mtr | 2,10 mtr | 2,60 mtr | 1,85 mtr | 2,10 mtr | 2,60 mtr |
| | 83.10.01.0225 50x50x2mm H=2,25 mtr | 83.10.01.0250 50x50x2mm H=2,50 mtr | 83.10.01.0300 50x50x2mm H=3,00 mtr | 83.10.01.0225 50x50x2mm H=2,25 mtr | 83.10.02.0250 80x80x3mm H=2,50 mtr | 83.10.02.0300 80x80x3mm H=3,00 mtr | 83.10.02.0225 80x80x3mm H=2,25 mtr | 83.10.02.0250 80x80x3mm H=2,50 mtr | on request |

CEPRO SWIVEL ARM 200CM

Maximum length 2 meter, produced from rectangular tube of 50 x 50mm. This product is finished with a grey (RAL 7035) powder-coating. Fitted with a mechanical hinge and an assembly plate for fixing the arm against a wall or column.

82.10.36.0200



1. Choose the type of separation; curtains or strip (2 or 3 mm)
2. Choose the required height of the separation
3. Then you will find the suitable pole for this arm and separation. Details on page 63.

| 82.10.36 Swivel arm length 200cm | Curtain | | | Strips 300 x 2 mm | | | Strips 300 x 3 mm | | |
|----------------------------------|--|--|--|--|--|--|--|--|--|
| | Height under beam | | | Height under beam | | | Height under beam | | |
| | 2,15 mtr | 2,30 mtr | 2,80 mtr | 2,15 mtr | 2,30 mtr | 2,80 mtr | 2,15 mtr | 2,30 mtr | 2,80 mtr |
| | 83.10.02.0225 80x80x3mm H=2,25 mtr | 83.10.02.0250 80x80x3mm H=2,50 mtr | 83.10.02.0300 80x80x3mm H=3,00 mtr | 83.10.02.0225 80x80x3mm H=2,25 mtr | 83.10.02.0250 80x80x3mm H=2,50 mtr | 83.10.02.0300 80x80x3mm H=3,00 mtr | 83.20.02.0225 100x100x4mm H=2,25 mtr | 83.20.01.0250 100x100x4mm H=2,50 mtr | 83.20.01.0300 100x100x4mm H=3,00 mtr |

CEPRO SWIVEL ARMS

CEPRO MODULAR SWIVEL ARM

Produced from a rectangular tube 50 x 50mm. This product is finished with a grey (RAL 7035) powder-coating. The swivel arm is fitted with a brake system and an assembly plate for fixing the arm against a wall or column.

200cm version 82.10.30.0200
300cm version 82.10.30.0300
400cm version 82.10.30.0400
500cm version 82.10.30.0500



1. Choose the type of separation; curtains or strip (2 or 3 mm)
2. Choose the required height of the separation
3. Then you will find the suitable pole for this arm and separation.

| | Curtain | | | Strips 300 x 2 mm | | | Strips 300 x 3 mm | | |
|--|--|--|--|--|--|--|--|--|--|
| | Height under beam | | | Height under beam | | | Height under beam | | |
| | 2,20 mtr | 2,70 mtr | 3,20 mtr | 2,20 mtr | 2,70 mtr | 3,20 mtr | 2,20 mtr | 2,70 mtr | 3,20 mtr |
| 82.10.30.0200 swivel arm length 200cm | 83.10.02.0300 80x80x3mm H=3,00 mtr | 83.10.02.0350 80x80x3mm H=3,50 mtr | 83.10.02.0400 80x80x3mm H=4,00 mtr | 83.10.02.0300 80x80x3mm H=3,00 mtr | 83.10.02.0350 80x80x3mm H=3,50 mtr | 83.20.01.0400 100x100x4mm H=4,00 mtr | 83.20.01.0300 100x100x4mm H=3,00 mtr | 83.20.01.0350 100x100x4mm H=3,50 mtr | 83.20.01.0400 100x100x4mm H=4,00 mtr |
| 82.10.30.0300 swivel arm length 300cm | 83.10.02.0300 80x80x3mm H=3,00 mtr | 83.10.02.0350 80x80x3mm H=3,50 mtr | 83.10.02.0400 80x80x3mm H=4,00 mtr | 83.20.01.0300 100x100x4mm H=3,00 mtr | 83.20.01.0350 100x100x4mm H=3,50 mtr | 83.20.02.0400 120x120x5mm H=4,00 mtr | 83.20.02.0300 120x120x5mm H=3,00 mtr | 83.20.02.0350 120x120x5mm H=3,50 mtr | 83.20.02.0400 120x120x5mm H=4,00 mtr |
| 82.10.30.0400 swivel arm length 400cm | 83.10.02.0300 80x80x3mm H=3,00 mtr | 83.10.02.0350 80x80x3mm H=3,50 mtr | 83.10.02.0400 80x80x3mm H=4,00 mtr | 83.20.02.0300 120x120x5mm H=3,00 mtr | 83.20.02.0350 120x120x5mm H=3,50 mtr | 83.20.02.0400 120x120x5mm H=4,00 mtr | 83.20.02.0300 120x120x5mm H=3,00 mtr | on request | op aanvraag |
| 82.10.30.0500 swivel arm length 500cm | 83.20.01.0300 100x100x4mm H=3,00 mtr | 83.20.01.0350 100x100x4mm H=3,50 mtr | 83.20.01.0400 100x100x4mm H=4,00 mtr | 83.20.02.0300 120x120x5mm H=3,00 mtr | 83.20.02.0350 120x120x5mm H=3,50 mtr | on request | on request | on request | on request |

CEPRO SWIVEL ARM HEAVY DUTY 600CM

Swivel arm, maximum length 6 meter, girder made from rectangular tube 50 x 50mm. This arm is fitted with a hinge in a block bearing with and a mechanical lock. An assembly plate for fixing the arm to a column or pole is included.

82.10.45.0600



1. Choose the type of separation; curtains or strip (2 or 3 mm)
2. Choose the required height of the separation
3. Then you will find the suitable pole for this arm and separation. Details on page 63.

| 82.10.45 Swivel arm length 600cm | Curtain | | | Strips 300 x 2 mm | | | Strips 300 x 3 mm | | |
|----------------------------------|--|--|--|--|--|--|-------------------|------------|------------|
| | Height under beam | | | Height under beam | | | Height under beam | | |
| | 2,05 mtr | 2,55 mtr | 3,05 mtr | 2,05 mtr | 2,55 mtr | 3,05 mtr | 2,05 mtr | 2,55 mtr | 3,05 mtr |
| | 83.20.02.0300 120x120x5mm H=3,00 mtr | 83.20.02.0350 120x120x5mm H=3,50 mtr | 83.20.02.0400 120x120x5mm H=4,00 mtr | 83.20.03.0300 160x160x6mm H=3,00 mtr | 83.20.03.0350 160x160x6mm H=3,50 mtr | 83.20.03.0400 160x160x6mm H=4,00 mtr | on request | on request | on request |

CEPRO SWIVEL ARMS

CEPRO SWIVEL ARMS

CEPRO SWIVEL ARM HEAVY DUTY HINGED 600CM

Swivel arm, 6 meter (4 + 2 meters), made with a double girder 50 x 50 mm. This first part swivels in a block bearing and has a mechanical lock. The second part has an adjustable brake system. This part has a maximum radius of 2 x 112°. An assembly plate for fixing the arm to a column or pole is included.

82.10.50.0600



1. Choose the type of separation; curtains or strip (2 or 3 mm)
2. Choose the required height of the separation
3. Then you will find the suitable pole for this arm and separation. Details on page 63.

| 82.10.50 Swivel arm length 600cm | Curtain | | | Strips 300 x 2 mm | | | Strips 300 x 3 mm | | |
|---|--|--|--|--|------------|------------|-------------------|------------|------------|
| | Heigth under beam | | | Heigth under beam | | | Heigth under beam | | |
| | 2,05 mtr | 2,55 mtr | 3,05 mtr | 2,05 mtr | 2,55 mtr | 3,05 mtr | 2,05 mtr | 2,55 mtr | 3,05 mtr |
| | 83.20.02.0300 120x120x5mm H=3,00 mtr | 83.20.03.0350 160x160x6mm H=3,50 mtr | 83.20.03.0400 160x160x6mm H=4,00 mtr | 83.20.03.0300 160x160x6mm H=3,00 mtr | on request | on request | on request | on request | on request |

CEPRO SWIVEL ARM HEAVY DUTY 400CM

Swivel arm, maximum length 4 meter, double girder made from rectangular tube 50 x 50mm. This arm is fitted with a hinge in a block bearing with and a mechanical lock. An assembly plate for fixing the arm to a column or pole is included.

82.10.51.0400

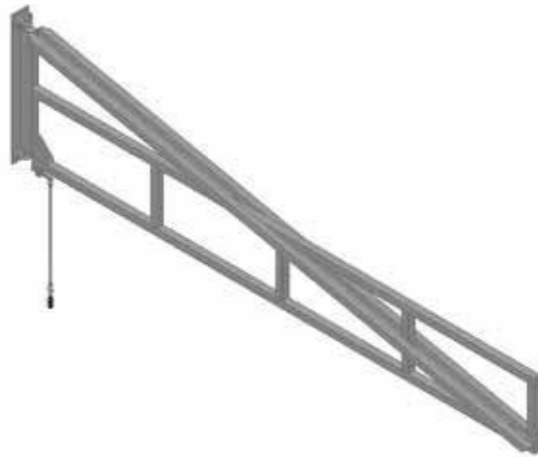

1. Choose the type of separation; curtains or strip (2 or 3 mm)
2. Choose the required height of the separation
3. Then you will find the suitable pole for this arm and separation. Details on page 63.

| 82.10.51 Swivel arm length 400cm | Curtain | | | Strips 300 x 2 mm | | | Strips 300 x 3 mm | | |
|---|--|--|--|--|--|--|--|--|------------|
| | Heigth under beam | | | Heigth under beam | | | Heigth under beam | | |
| | 2,05 mtr | 2,55 mtr | 3,05 mtr | 2,05 mtr | 2,55 mtr | 3,05 mtr | 2,05 mtr | 2,55 mtr | 3,05 mtr |
| | 83.20.02.0300 120x120x5mm H=3,00 mtr | 83.20.02.0350 120x120x5mm H=3,50 mtr | 83.20.02.0400 120x120x5mm H=4,00 mtr | 83.20.03.0300 160x160x6mm H=3,00 mtr | 83.20.03.0350 160x160x6mm H=3,50 mtr | 83.20.03.0400 160x160x6mm H=4,00 mtr | 83.20.03.0300 160x160x6mm H=3,00 mtr | 83.20.03.0350 160x160x6mm H=3,50 mtr | on request |

CEPRO TELESCOPIC SWIVEL ARM

This swivel arm is fitted with a telescope. The hinge of the arm is fitted with an adjustable brake. The swivel arm can be used with both strips and curtains, but is not suitable for heavy loads like a wire-box.

- 200cm version 82.10.25.2000
- 250cm version 82.10.25.2500
- 300cm version 82.10.25.3000
- 350cm version 82.10.25.3500
- 400cm version 82.10.25.4000



1. Choose the type of separation; curtains or strip (2 or 3 mm)
2. Choose the required height of the separation
3. Then you will find the suitable pole for this arm and separation.

| | Curtain | | | Strips 300 x 2 mm | | | Strips 300 x 3 mm | | |
|---|--|--|--|--|--|--|--|--|--|
| | Heigth under beam | | | Heigth under beam | | | Heigth under beam | | |
| | 2,80 mtr | 3,30 mtr | 3,80 mtr | 2,80 mtr | 3,30 mtr | 3,80 mtr | 2,80 mtr | 3,30 mtr | 3,80 mtr |
| 82.10.25.0200 swivel arm length 200cm | 83.10.02.0300 80x80x3mm H=3,00 mtr | 83.10.02.0350 80x80x3mm H=3,50 mtr | 83.10.02.0400 80x80x3mm H=4,00 mtr | 83.10.02.0300 80x80x3mm H=3,00 mtr | 83.10.02.0350 80x80x3mm H=3,50 mtr | 83.20.01.0400 100x100x4mm H=4,00 mtr | 83.20.01.0300 100x100x4mm H=3,00 mtr | 83.20.01.0350 100x100x4mm H=3,50 mtr | 83.20.02.0400 120x120x5mm H=4,00 mtr |
| 82.10.25.0300 swivel arm length 300cm | 83.10.02.0300 80x80x3mm H=3,00 mtr | 83.10.02.0350 80x80x3mm H=3,50 mtr | 83.10.02.0400 80x80x3mm H=4,00 mtr | 83.20.01.0300 100x100x4mm H=3,00 mtr | 83.20.02.0350 120x120x5mm H=3,50 mtr | 83.20.02.0400 120x120x5mm H=4,00 mtr | 83.20.02.0300 120x120x5mm H=3,00 mtr | 83.20.02.0350 120x120x5mm H=3,50 mtr | 83.20.02.0400 120x120x5mm H=4,00 mtr |
| 82.10.25.0400 swivel arm length 400cm | 83.20.01.0300 100x100x4mm H=3,00 mtr | 83.20.01.0350 100x100x4mm H=3,50 mtr | 83.10.01.0400 100x100x4mm H=4,00 mtr | 83.20.02.0300 100x100x4mm H=3,00 mtr | 83.20.02.0350 120x120x5mm H=3,50 mtr | 83.20.02.0400 120x120x5mm H=4,00 mtr | on request | on request | on request |

CEPRO SWIVEL JOINT ARM - BASIC PART

Foldable swivel arm, with 2 joints. The first part has a adjustable brake system. This swivel arm can be extended with parts of 60cm, with a maximum length of 211cm. This product is finished with a grey (RAL 7035) powdercoating.

- 82.10.30.9005 Mounting plate piece
- 82.10.17.02 Basic part piece
- 82.10.17.03 Extention part piece
- 82.10.17.04 Z-support for swivel arm piece
- 82.10.15 Tube swivel arm piece

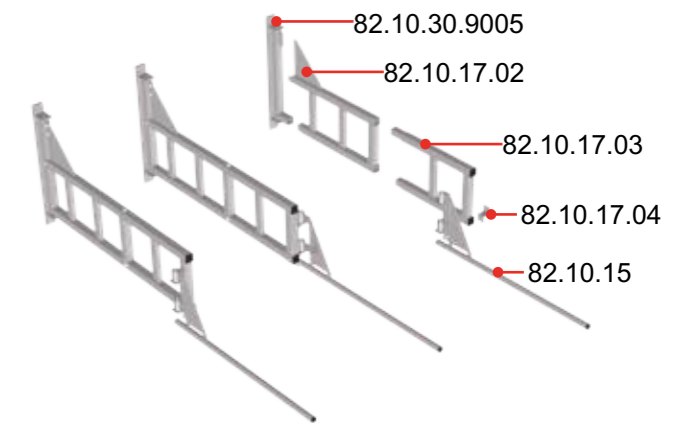

1. Choose the type of separation; curtains or strip (2 or 3 mm)
2. Choose the required height of the separation
3. Then you will find the suitable pole for this arm and separation. Details on page 63.

| | Curtain | | | Strips 300 x 2 mm | | | Strips 300 x 3 mm | | |
|---|--|--|--|--|--|--|--|--|--|
| | Heigth under beam | | | Heigth under beam | | | Heigth under beam | | |
| | 2,20 mtr | 2,70 mtr | 3,20 mtr | 2,20 mtr | 2,70 mtr | 3,20 mtr | 2,20 mtr | 2,70 mtr | 3,20 mtr |
| 82.10.17.0921 swivel arm length 300cm | 83.10.02.0300 80x80x3mm H=3,00 mtr | 83.10.02.0350 80x80x3mm H=3,50 mtr | 83.10.02.0400 80x80x3mm H=4,00 mtr | 83.20.01.0300 100x100x4mm H=3,00 mtr | 83.20.01.0350 100x100x4mm H=3,50 mtr | 83.20.02.0400 120x120x5mm H=4,00 mtr | 83.20.02.0300 120x120x5mm H=3,00 mtr | 83.20.02.0350 120x120x5mm H=3,50 mtr | 83.20.02.0400 120x120x5mm H=4,00 mtr |
| 82.10.17.1521 swivel arm length 350cm | 83.10.02.0300 80x80x3mm H=3,00 mtr | 83.10.02.0350 80x80x3mm H=3,50 mtr | 83.20.01.0400 100x100x4mm H=4,00 mtr | 83.20.02.0300 120x120x5mm H=3,00 mtr | 83.20.02.0350 120x120x5mm H=3,50 mtr | 83.20.02.0400 120x120x5mm H=4,00 mtr | 83.20.02.0300 120x120x5mm H=3,00 mtr | 83.20.02.0350 120x120x5mm H=3,50 mtr | on request |
| 82.10.17.2121 swivel arm length 400cm | 83.20.01.0300 100x100x4mm H=3,00 mtr | 83.20.01.0350 100x100x4mm H=3,50 mtr | 83.20.01.0400 100x100x4mm H=4,00 mtr | 83.20.02.0300 120x120x5mm H=3,00 mtr | 83.20.02.0350 120x120x5mm H=3,50 mtr | 83.20.02.0400 120x120x5mm H=4,00 mtr | 83.20.02.0300 120x120x5mm H=3,00 mtr | on request | on request |

► **CEPRO POLES & COLUMNS**

► **SET FOR FIXING RAIL UNDER SWIVEL ARM**

Standard set for fixing a tube 33.7mm Ø under a swivel arm
82.10.30 + 82.10.17

80.15.02

Standard set for fixing a tube 33.7mm Ø under a swivel arm
82.10.36 + 82.10.45 + 82.10.50 + 82.10.51

80.15.01

Supports are galvanized.

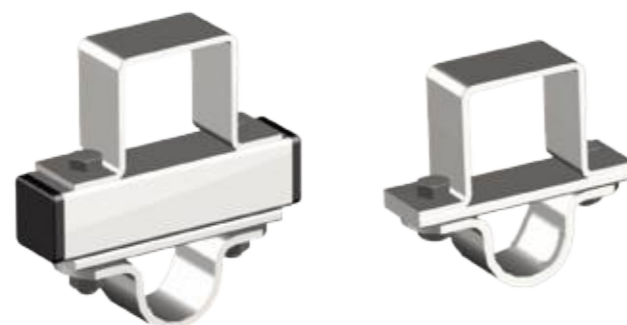

80.15.02

80.15.01

► **SET FOR FIXING RAIL UNDER SWIVEL ARM**

Standard set for fitting rail 30 x 35mm under a swivel arm
82.10.30 + 82.10.17

80.15.03

Standard set for fixing a rail 30 x 35mm under a swivel arm
82.10.45 + 82.10.50 + 82.10.51

80.15.10

Supports are galvanized.

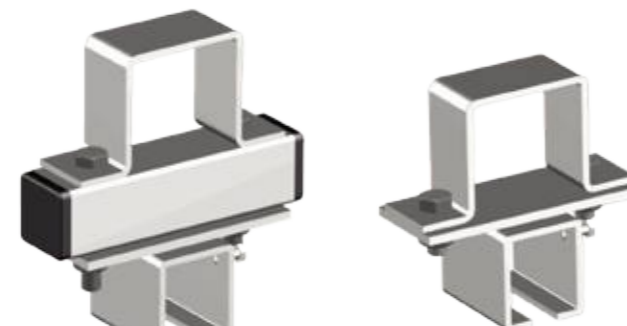

80.15.03

80.15.10

► **TAG WITH RUNNER**

Tag with swivel for fitting hoses into rail system, including runner and snaphook. Tag is made from nylon.

80.10.05



► **FIXING SET FOR WIRE-BOX**

Set for fitting wire-box under a swivel arm, incl. runners, heavy-duty hook and chain with grip maximum load 25kg.

82.01.02



► **CEPRO POLES & COLUMNS**

► **CEPRO POLE - 50X50X2MM**

Pole, with a steel pole 50 x 50 x 2mm and a footplate 110 x 110 x 8mm.

This product is finished with a grey (RAL 7035) powder coating.

| | |
|--------------|---------------|
| Height 225cm | 83.10.01.0225 |
| Height 250cm | 83.10.01.0250 |
| Height 300cm | 83.10.01.0300 |

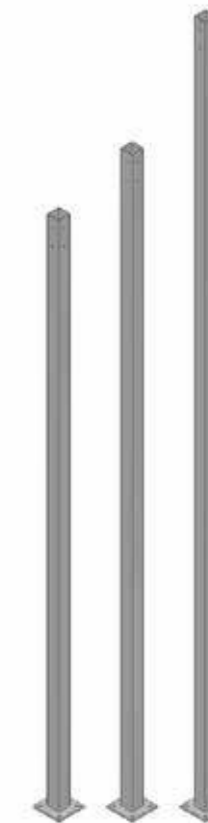

► **CEPRO POLE 300CM**

Poles. Finished with a grey (RAL 7035) powder coating.

Profile 80x80x3mm, footplate 300x300x10mm

| | |
|--------------|---------------|
| Height 225cm | 83.10.02.0225 |
| Height 250cm | 83.10.02.0250 |
| Height 300cm | 83.10.02.0300 |
| Height 350cm | 83.10.02.0350 |
| Height 400cm | 83.10.02.0400 |

Profile 100x100x4mm, footplate 500x500x15mm

| | |
|--------------|---------------|
| Height 300cm | 83.20.01.0300 |
| Height 350cm | 83.20.01.0350 |
| Height 400cm | 83.20.01.0400 |

Profile 120x120x5mm, footplate 500x500x15mm

| | |
|--------------|---------------|
| Height 300cm | 83.20.02.0300 |
| Height 350cm | 83.20.02.0350 |
| Height 400cm | 83.20.02.0400 |

Profile 160x160x6mm, footplate 500x500x15mm

| | |
|--------------|---------------|
| Height 300cm | 83.20.03.0300 |
| Height 350cm | 83.20.03.0350 |
| Height 400cm | 83.20.03.0400 |

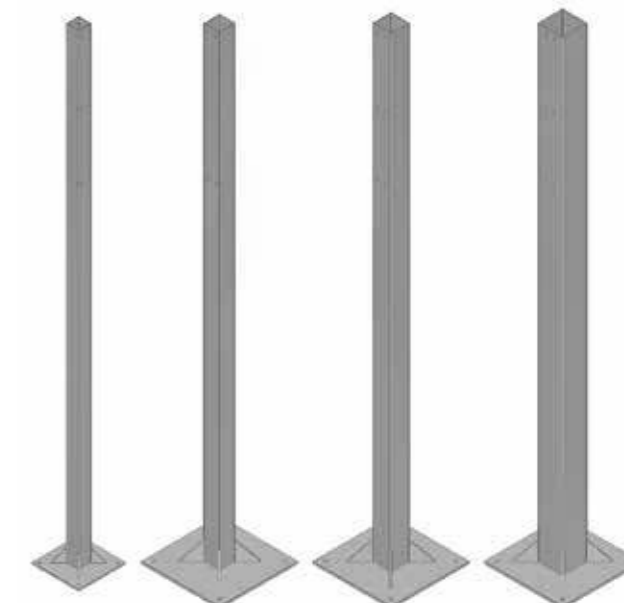

► **CEPRO RAIL SYSTEM**

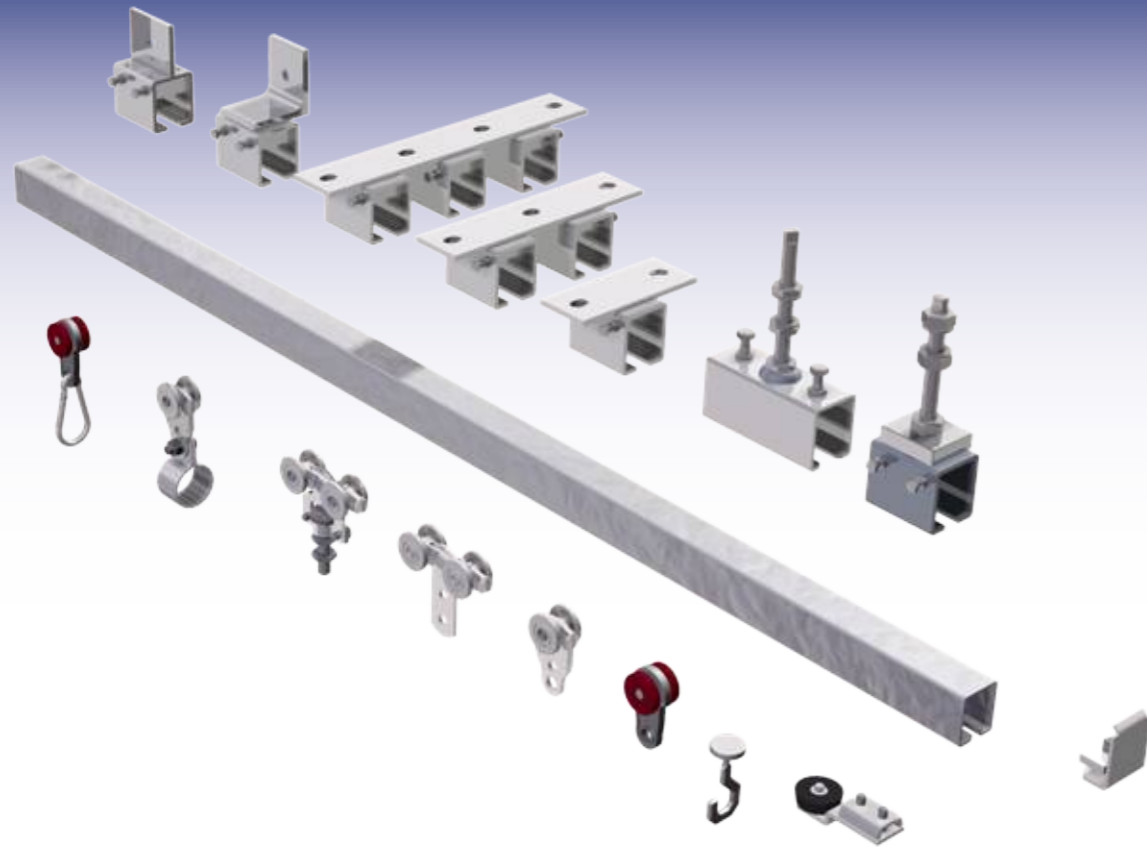

RAIL SUPPORT

Rail support with long bolt M10 for rail 30 x 35mm

86.10.02

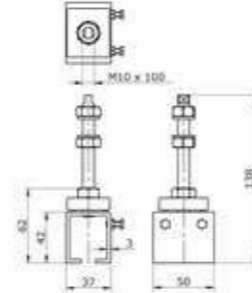

RAIL CONNECTOR

Rail connector with long bolt M10. For rail 30 x 35mm

86.10.03

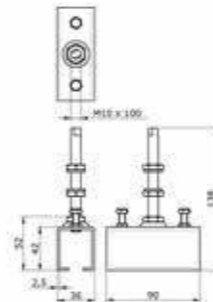

CEILING CONNECTOR

Ceiling rail connector for single rail 30 x 35mm

86.10.20

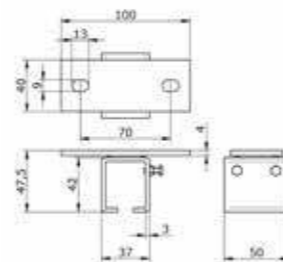

► **CEPRO RAIL SYSTEM**

CEILING CONNECTOR

Ceiling rail connector for double rail 30 x 35mm

86.10.21

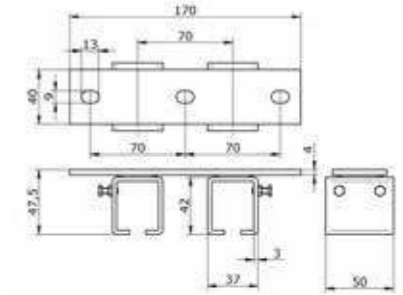

CEILING CONNECTOR

Ceiling rail connector for triple rail 30 x 35mm

86.10.22

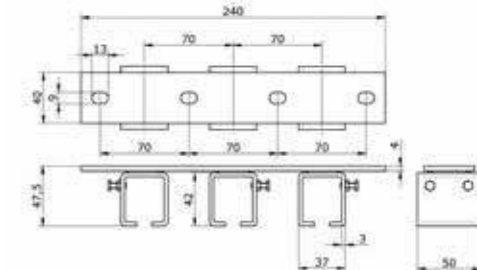

WALL CONNECTOR

Wall rail connector for rail 30 x 35mm

86.10.15

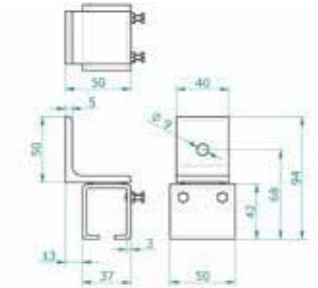

RAIL SUPPORT

Rail support for strengthening rail with metal strip.

86.10.25

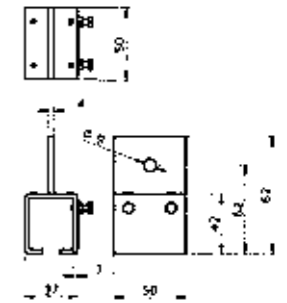

RAIL 30X35 MM

Rail 30 x 35mm per running meter, maximum length 6 meter.

86.10.00

For logistical reasons we advise the shipment of rail in bundles or in maximum length of 3 meters.

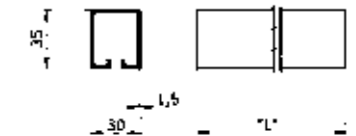

RAILBEND

Rail 90° elbow, radius 500mm, for rail 30 x 35mm

86.10.01

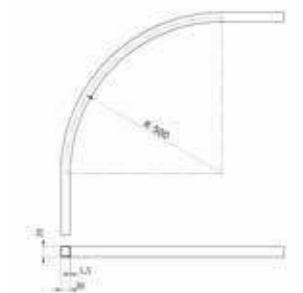

► **CEPRO TUBE SYSTEM**

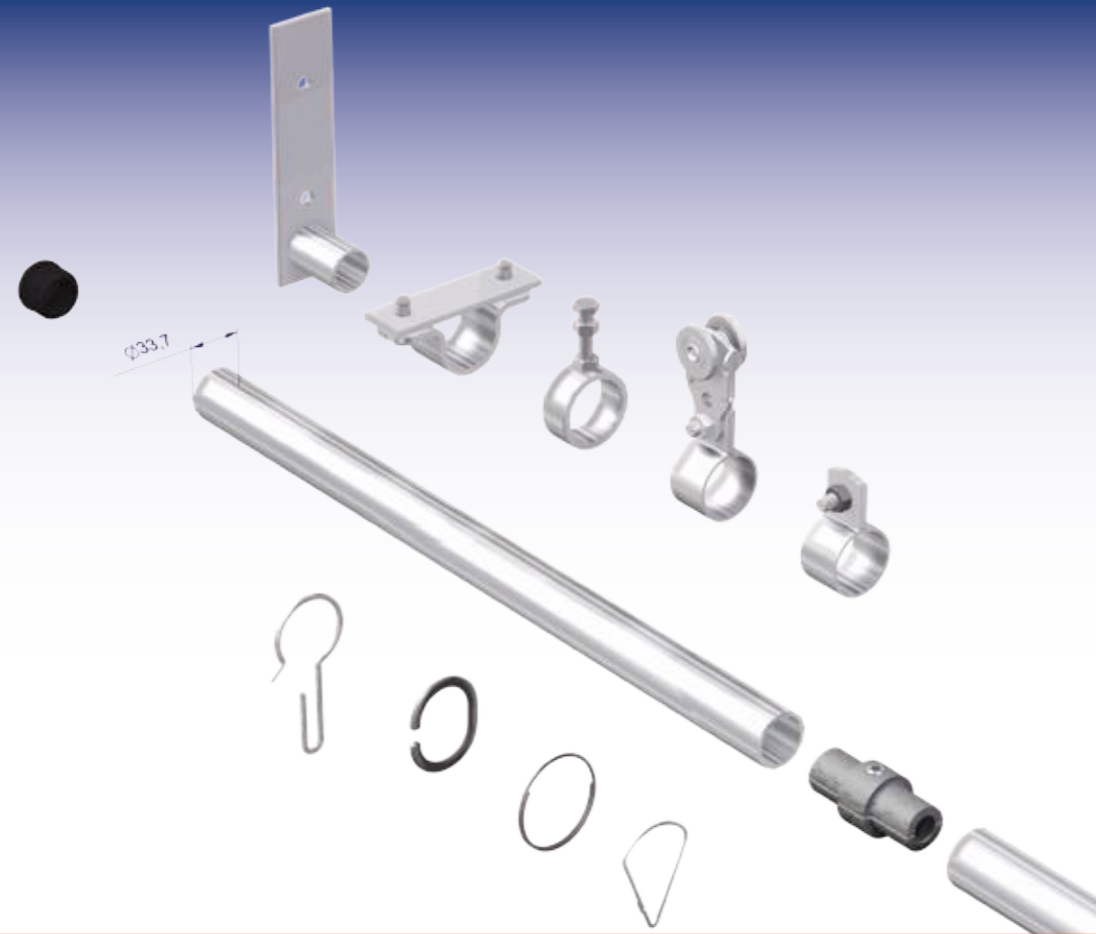

CEILING SUPPORT

Ceiling support, for connecting pipe max 33.7mm Ø to the wall or ceiling

86.40.10

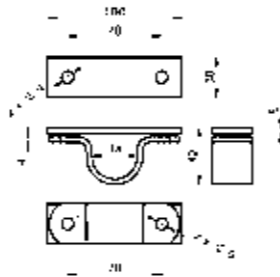

FLANGE

Flange, for connecting pipe (33.7mm Ø, 2.9mm wall thickness) to a wall or column

86.40.41

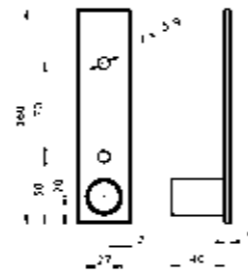

PIPE SUPPORT

Pipe support with bolt (M8 x 40mm) for pipe max 33.7mm Ø.

86.40.50

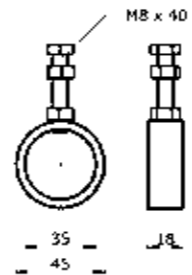

► **CEPRO TUBE SYSTEM**

TUBE

Pipe 33.7mm Ø, 2.5mm wall thickness per running meter, maximum length 6 meter

86.40.00

For logistical reasons we advise the shipment of tube in bundles or in maximum length of 3 meters.

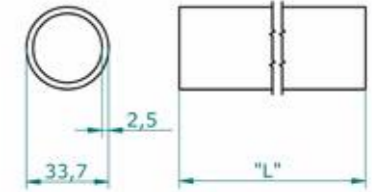

TUBE CONNECTOR

Pipe connector for pipe 33.7mm Ø. Only suitable for use next to a support

86.40.30

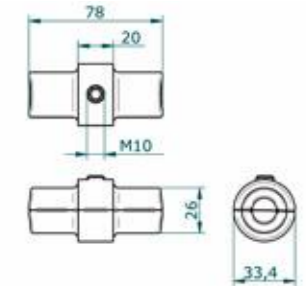

SUSPENSION RING

Suspension ring, steel, for pipe max 33.7mm Ø (packed per set of 7 pieces)

10.48.50.0007

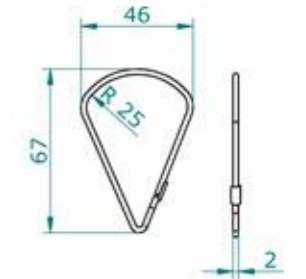

SUSPENSION RING

Suspension ring, plastic, for pipe max 33.7mm Ø.

10.48.40

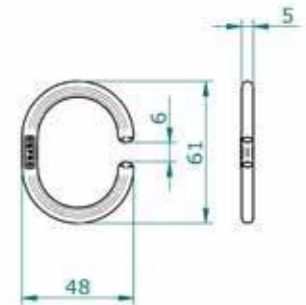

SUSPENSION HOOK

Suspension ring, metal, extra large for heavy duty purposes. For pipe max :

Ø 34 mm 10.48.55

Ø 50 mm 10.48.58

Ø 70 mm 10.48.56

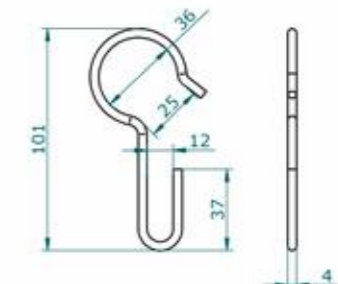

SUSPENSION RING

Stainless steel suspension ring. Ø 58 mm.

10.48.52



CEPRO International B.V.

Postal address:
Parallelweg 38
5121 LD Rijen, Netherlands

Visiting address:
Parallelweg 38
5121 LD Rijen, Netherlands

Warehouse address:
Parallelweg 40
5121 LD Rijen, Netherlands

CEPRO[®]
LEADING IN WELDING SAFETY

www.cepro.eu

Version 19.02.EN

Protecting people

We protect people and the surrounding area from danger by setting up safe welding and grinding sites.

Solid operational management also means working to protect your employees and the surrounding area from danger. At CEPRO, we believe sharing knowledge about legal safety requirements forms the cornerstone of a productive business relationships and long-term partnership.

Reliable quality and service in safety

This allows us to combine all the knowledge and expertise found in today's sector in our products, services and processes. We treat every request with due care and attention and work to tailor our solutions to the individual requirements of the client or end user. And throughout, we leave nothing to chance. Working together with our client, and together with our partners. We believe that continuously investing in knowledge, training and relationships is the best guarantee for consistent and dependable quality and solid service in safety that complies with international regulations. It's what has made CEPRO the global market leader in its sector.

Happy in your job

When it comes to safety and job satisfaction, only the best is good enough for our own people too. After all, whether or not you are happy in your job depends to a large extent on how secure and satisfied you feel as an employee. When our employees feel happy, this contributes to their personal health and productivity. And this in turn has a positive impact on customer satisfaction.

Где купить:

ООО "КОМПАНИЯ ОПТУЛС"

г.Москва, ул.Бирюлёвская, д.53, корп. 2, офис 113

Tel.: +7 (495) 646-00-96

E-Mail: sale@opttools.ru

Internet: www.opttools.ru