

MAGIC 21

PREMIUM TOOLS / QUALITY MADE BY GEDORE



CAPTURE LITE
0,25-350Nm

PLIER WRENCH

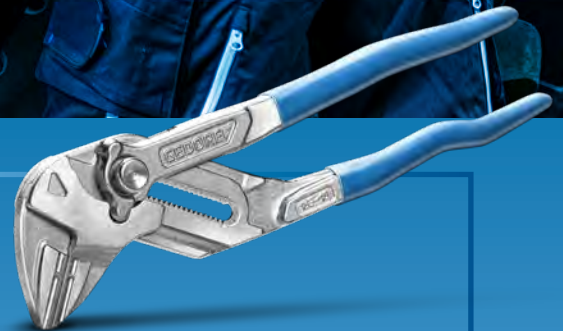

TORCOFIX TF-K
20-850 Nm

NEW

VDE 183 10
VDE-PLIER WRENCH

103



NEW

183 10 TC
PLIER WRENCH

94



TF
TORCOFIX SE/K

NEW

30



CL 350
CAPTURE LITE















38



HIGHLIGHTS
2021



CONTENTS

	SPANNERS	04 – 08
	SOCKETS AND ACCESSORIES	09 – 29
	TORQUE TOOLS	30 – 40
	SCREWDRIVERS	41 – 45
	WORKSHOP EQUIPMENT	46 – 59
	TOOL ASSORTMENTS	60 – 62
	MODULE	63 – 74
	MOBILE TOOL STORAGE	74 – 78
	PULLERS	79 – 86
	HAMMERS / STRIKING TOOLS	87 – 91
	PLIERS	92 – 103
	VDE INSULATED SAFETY TOOLS	103 – 111
	WORKSHOP SUPPLIES	112 – 117
	BENDING SYSTEMS	117 – 119
	INSTALLATION TOOLS	119

UNIVERSAL RATCHET WRENCH

Whether in industrial use, trade or when tightening screws and bolts on vehicles, the combination ratchet wrench from GEDORE is perfect for precise and quick work on common fittings.

wave-shaped profile ensures an even distribution of pressure under the highest loads and equally prevents the screw or bolt from turning round. Alternatively, the 5-piece compact version is available in a plastic box with foam insert.

The open-ended ring ratchet spanner from GEDORE combines an open-ended spanner and a ring spanner with ratchet mechanism in one tool. Available as a set in a robust sheet steel case in 12 different sizes. From spanner size 8-19mm, the set contains the right tool for a wide range of applications. The torsion-resistant design of the spanners ensures maximum torque transmission. The Unit Drive profile ensures a secure connection between the open-ended ring ratchet spanner and the screw connection. The even transmission of force via the



7 UR-012 COMBINATION RATCHET SPANNER SET

reversible, 12 pieces

- > For ratchet unscrewing and rapid tightening of screws and nuts
- > Ring 13° offset from shaft, reversible
- > Extremely protective UD profile ensures a uniform distribution of pressure when maximum force is applied
- > Sheet metal spanner box with plastic insert



Code	No.	Contents	Length mm	Pieces	Weight kg
2297418	7 UR-012	7 UR 8 9 10 11 12 13 14 15 16 17 18 19	320	12	2,84

1

THE UD PROFILE (NO. 7)

- The corrugated shape of the profile provides a secure hold, even with screws and bolts whose dimensions lie outside the tolerance range. Uniform pressure distribution allows maximum use of force

2

THE GUN (U-20)

- Extremely compact and powerful. The proven U-20 ratchet technology enables quick, fast ratcheting work

3

ANTI GLARE OPTICS WITH GRIP (NO. 6 7)

- The anti-glare appearance is achieved by matt chrome plating - the GEDORE surface finish is both good in the hand and very useful - good grip even with oily hands

4

THE MOUTH (NO. 6)

- The precision fit guarantees a secure fit, a longer service life of the screw and spanner ratchet and is therefore the most important prerequisite for easy safe working.



A PERFECT
TOOL

„With the 7 UR-012 open-end ratchet spanner set, you always have the most important sizes of the practical GEDORE classic to hand.“



7 UR-005

COMBINATION RATCHET SPANNER SET

reversible, 5 pieces

- › For ratchet unscrewing and rapid tightening of screws and nuts
- › High torque transfer due to the warp-resistant geometry with double T-girder effect
- › Ring 13° offset from shaft, reversible
- › Extremely protective UD profile ensures a uniform distribution of pressure when maximum force is applied
- › Plastic scanner case with foam insert

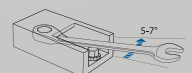

Code	No.	Contents
2327651	7 UR-005	8 10 13 17 19 mm

Length mm	Pieces	Weight kg
275	5	0,93

1B COMBINATION SPANNER SET

metric

- › Practical combination of combination spanners with the same width across flats
- › The offset ring ensures a better grip on deep-seated or inset nuts or bolts
- › Ring offset and 10° angled, with UD profile for smooth power transfer
- › Slim ribbed open end for added strength guarantees maximum torques



Code	No.	Contents	Pieces	Weight kg
6011870	1B-08	10 12 13 14 17 19 22 24 mm	8	2,6
6012680	1B-017	6 7 8 9 10 11 12 13 14 15 16 17 18 19 20 21 22 mm	17	2,3

7 COMBINATION SPANNER SET

metric

- › Practical combination of combination spanners with the same width across flats
- › Ring 15° angled, with UD profile for smooth power transfer
- › Secure grip thanks to hollow shaft - very ergonomic and handy
- › Slim jaws and slender jaw walls make the spanner lighter overall



Code	No.	Contents	Pieces	Weight kg
6092770	7-08	10 12 13 14 17 19 22 24 mm	8	0,973
6093580	7-017	6 7 8 9 10 11 12 13 14 15 16 17 18 19 20 21 22 mm	17	1,465

2-10 DOUBLE ENDED RING SPANNER SET

10 pieces

- › Most common sizes in the set, for extremely deep-set or recessed nuts
- › Hot drop forged and professionally processed
- › Ring: thin-walled, 5° deep offset from shaft, with UD profile for gentle transmission of force



Code	No.	Contents
6030740	2-10	6x7 8x9 10x11 12x13 14x15 16x17 18x19 20x22 21x23 24x27 mm

Pieces	Weight kg
10	2,225

i GEDORE UNIT-DRIVE Profile

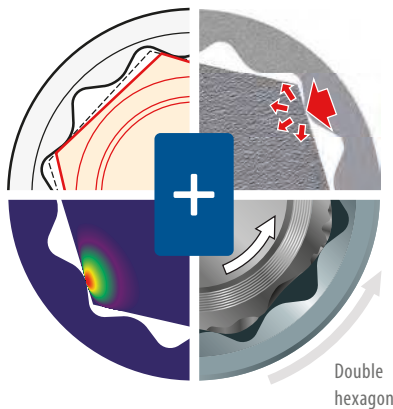

1

A large contact surface provides a secure force closure even for those bolts whose sizes lie outside of the tolerances.

2

Uniform distribution of the force on the bolt flanks. The resulting reduced notching effect stops the bolt from turning round and round.

3

Gentle torque transfer enables even worn bolts to be unscrewed with every certainty - no slipping of the tool at all.

4

Thanks to the optimally distributed force up to 20 % higher torques can be transferred.



7 XL-0111 COMBINATION SPANNER SET

extra long, 11 pieces

- › Practical combination of combination spanners with the same width across flats
- › Extra long shaft for deep range of use and more torque
- › Ring 15° angled, with UD profile for smooth power transfer
- › Secure grip thanks to hollow shaft - very ergonomic and handy
- › High-quality industrial grade for heavy-duty continuous use, glowing, drop-forged



Code	No.	Contents
6104960	7XL-0111	8 10 11 12 13 14 16 17 18 19 22 mm

Pieces	Weight kg
11	1,794

KD 26 R-120 TUBULAR BOX SPANNER SET

12 pieces

- › Practical assembly of double socket wrenches with rotary pins
- › Acc. to DIN 896, Form B, ISO 2236, ISO 1085
- › With hollow shaft, in tubular steel, DIN 2391 seamless, hardened, made from material C35, chrome-plated



Code	No.	Contents	Pieces	Weight kg
6218890	KD 26 R-120	Double socket wrench, hexagon No. 26 R 6x7 8x9 10x11 12x13 14x15 16x17 18x19 20x22 21x23 24x27 25x28 30x32 Stepped turning pin No. 26 RS 1 2 3	12	2,895

60 S SINGLE OPEN ENDED SPANNER

adjustable 0-30 mm

- › With hardened and milled clamping jaws it serves as a practically adjustable wrench. The wheel mechanism allows quick and precise adjustment of the correct size. They are ideal for effective work
- › The protected mechanism and additional striking face allow light blows to be applied without impairing the function of the wrench
- › Swedish pattern, roller with left hand thread
- › With adjusting scale
- › Jaw set at 15°
- › Design C = nickel and chrome plated, head ground



Code	No.	Size	Total length mm	Span mm	Scale division	Weight kg
1966316	60 S 8 C	8"	206,5	25	0-25	0,34
2170973	60 S 10 C	10"	254,5	30	0-30	0,48
2668890	60 S 12 C	12"	305	36	0-36	0,78

666-032-J
BIT-BOX INDUSTRY

32 pieces

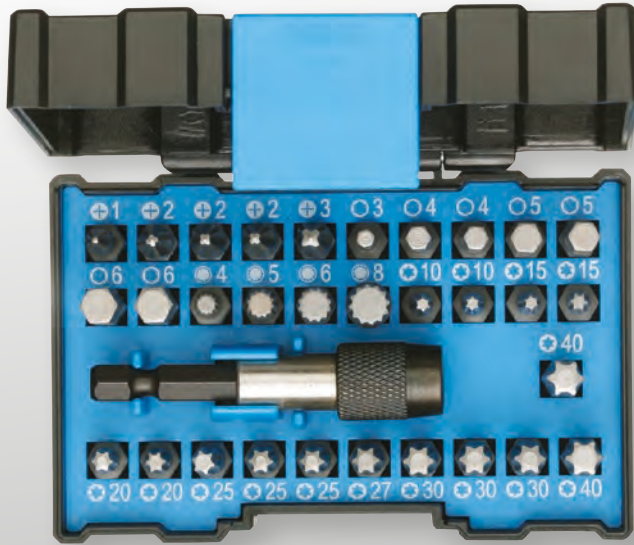

- › Tailored for use in modern industrial plants, but also offers the most common bits for the do-it-yourselfer
- › Bit holder with quick clamping system, magnet and machine holder
- › Bit box made of plastic with a transparent lid for quick check of completeness after work



Code	No.	Contents	Length mm	Width mm	Depth mm	Pieces	Weight kg
2993228	666-032-J	Cross recess PH 1 (1x) PH 2 (3x) PH 3 (1x) Inside TX T10 (2x) T15 (2x) T20 (2x) T25 (3x) T27 (1x) T30 (3x) T40 (2x) Internal hexagon 3 (1x) 4 (2x) 5 (2x) 6 (2x) Multi-tooth XZN M4 (1x) M5 (1x) M6 (1x) M8 (1x) 1/4"-1/4" adapter	107	143	42	32	0,26

666-032-A
BIT-BOX ALLROUND

32 pieces

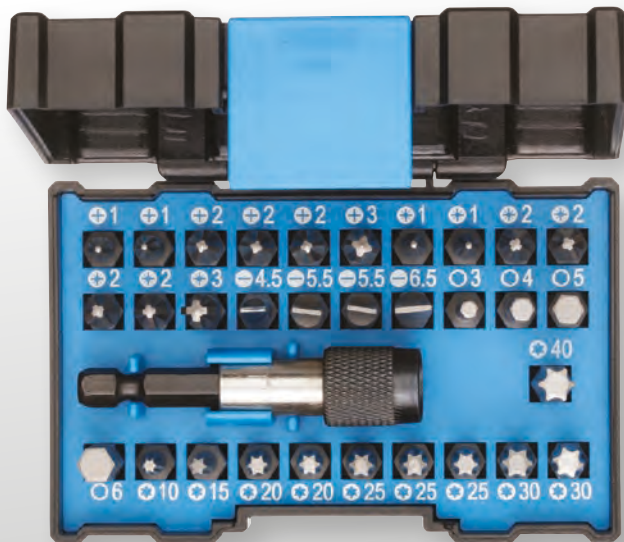

- › Practical bit compilation for industry, trade and the ambitious do-it-yourselfer
- › Bit holder with quick clamping system, magnet and machine holder
- › Bit box made of plastic with a transparent lid for quick check of completeness after work



Code	No.	Contents	Length mm	Width mm	Depth mm	Pieces	Weight kg
2993236	666-032-A	Slot 4.5 (1x) 5.5 (2x) 6.5 (1x) Cross recess PH 1 (2x) PH 2 (3x) PH 3 (1x) Cross recess PZ 1 (2x) PZ 2 (4x) PZ 3 (1x) Inside TX T10 (1x) T15 (1x) T20 (2x) T25 (3x) T30 (2x) T40 (1x) Internal hexagon 3 (1x) 4 (1x) 5 (1x) 6 (1x) 1/4"-1/4" adapter	107	143	42	32	0,246

WEAR RESISTANT AND SAFE

The 42-piece torsion bit set is a compact solution for diverse screw connections in industry and trade.

The 42-piece set, 666-042 from GEDORE with torsion bits and sockets, adapters, as well as bit holders is especially designed for machine-operated use. The torsion zone acts like a shock absorber, optimally cushioning stress and gently absorbing torque peaks. The bits are protected, which increases the service life enormously. The bits are therefore suitable for soft and hard screwdriving applications.

The universal composition of the torsion bit set includes bits with common profiles and dimensions in three different lengths, linked with a colour coding system, as well as two drive adapters for 1/4" and 3/8" drive. Three magnetic sockets with machine mount extend the range of applications.



666-042
TORSIONS BIT SET
42 pieces



- > Torsionszone to protect bits under load. Peak torques are gently cushioned, which increases the lifetime
- > For soft and hard bolting tasks
- > Suitable for use in Impact sockets



Code	No.	Contents	Length mm	Width mm	Depth mm	Pieces	Weight kg
3100316	666-042	1/4" bits, 25mm:1/4" slot 5.5, 6.5 mm 1/4" cross recess PR 21/4" cross recess PH 1 2 2 3 1/4" cross recess PZ 1 2 2 3 1/4" TX T10 T15 T20 T25 T30 T40 1/4" bits, 50mm 1/4":hexagon 3 4 5 mm 1/4" cross recess PH 1 2 2 3 1/4" cross recess PZ 1 2 2 3 1/4" TX T10 T15 T20 T25 T30 1/4" bits, 88.9mm:1/4" slot 5,5 mm 1/4" cross recess PH 21/4" cross recess PZ 21/4" TX T25 Drive adapter 1/4" hexagonal x 1/4" square, L. 50mm Drive adapter 1/4" hexagonal x 3/8" square, L. 50mm Socket wrench insert, magnetic, with 1/4" hex drive SW 8mm, L.67mm Socket wrench insert, magnetic, with 1/4" hex drive SW 10mm, L.67mm Socket wrench insert, magnetic, with 1/4" hex drive SW 13mm, L.67mm Bit-Holder 1/4" One-touch Slim Lock, L.66,5mm	190	120	45	42	0,67

1

SAFE EASY WORKING

- Extremely slim and self-locking magnetic bit holder with quick-change function

2

EXTENSIVE BASIC EQUIPMENT

- 42 parts for screw connections for industry and trade

3

LONGER SERVICE LIFE

- Torsion zone to protect the bits under load, torque peaks are gently cushioned and thus the service life is increased

4

CLEAR COLOUR CODING

- Color-coded bits identify the different profiles for the most diverse applications



PROFESSIONALS
TOOL



„The high quality ensures maximum service life even at high torques.“

666-006

BIT BOX SOCKET MACHINE MOUNT

6 pieces

- › Socket wrench inserts with magnet for damage-free insertion and removal of hexagon head screws
- › Especially suitable for self-drilling screws
- › Plastic box with a transparent lid for quick check of completeness after work



6,3 $\frac{1}{4}$ mm

Code	No.	Contents	Length mm	Width mm	Depth mm	Pieces	Weight kg
2993244	666-006	Socket wrench machine mount 1/4" 7 8 10 12 13 mm and 3/8"	107	143	42	6	0,24

INNOVATION

With the magazine screwdriver with ratchet function you can easily replace 12x conventional screwdrivers!

The 2169-012 magazine screwdriver from GEDORE with its precise and innovative mechanics. Particularly when used in confined spaces, it demonstrates its ability with a return angle of almost 0°. The magazine screwdriver has integrated clockwise and anti-clockwise rotation, including centre lock, which ensures that the ratchet function is locked. Due to the small outer diameter, the bit holder is also suitable for screw connections that are difficult to reach.

The strong permanent magnet fixes the bits securely in the holder to prevent them from falling out. The bits can also be easily removed from the integrated bit magazine in the handle.

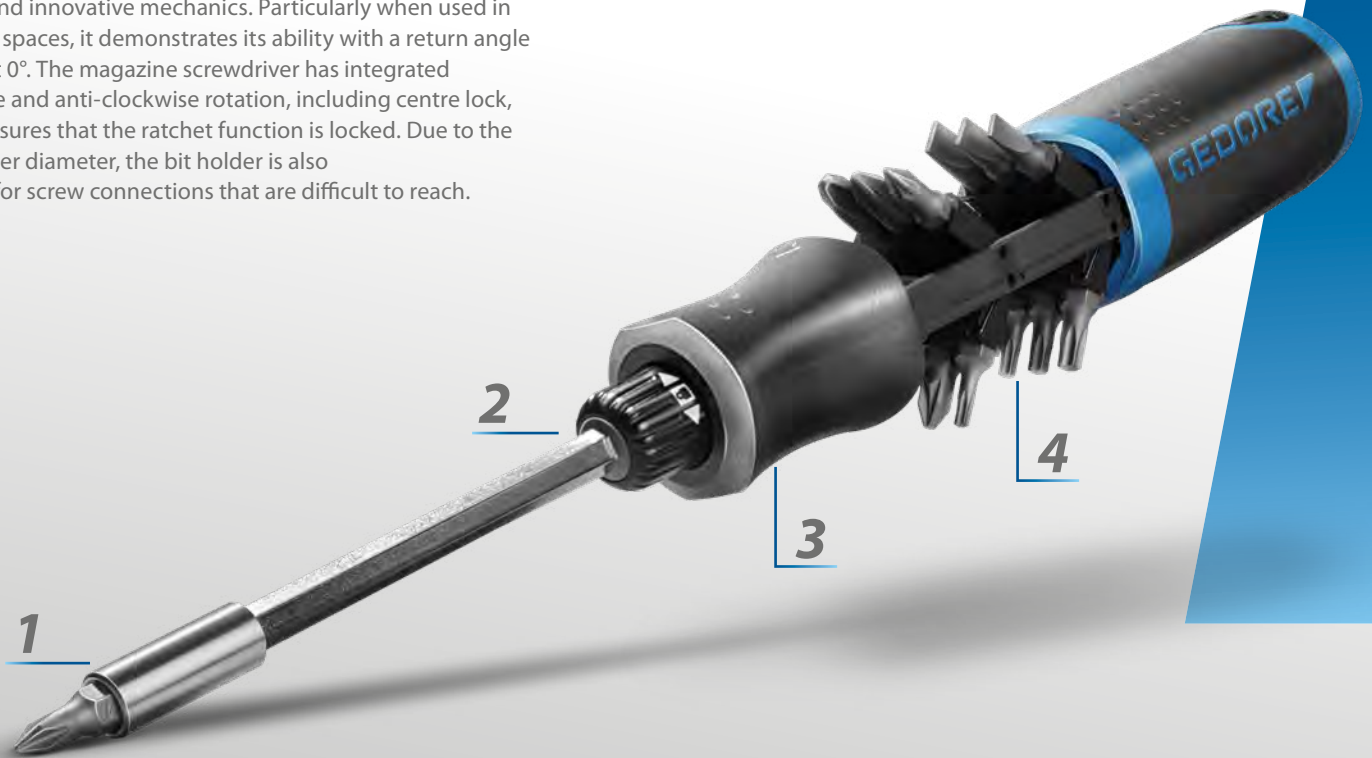

2169-012 MAGAZINE HANDLE SCREWDRIVER WITH RATCHET FUNCTION SILENTGEAR 1/4"

- > Loaded magazine screwdriver with ratchet function
- > For precision working in confined spaces
- > Very small return angle, practically 0°
(not measurable with mechanical measuring equipment)
- > Rotating ring for clockwise/anticlockwise rotation adjustment, screw tightening also without ratchet function thanks to neutral central position with ratchet lock
- > Almost noiseless working due to SilentGear
- > Integrated bit magazine holds up to 12 bits 1/4"

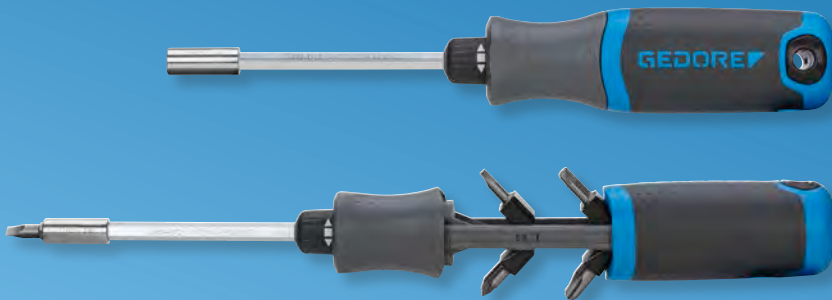

Code	No.	Drive mount, Hexagonal inch	Drive mount, Hexagonal- metric	Length mm	Blade length	Handle width mm	Content	Weight kg
3031691	2169-012	1/4"	6.3	250	125	38,6	Slot 0.8x4.5 1.0x5.5 1.2x6.5 Cross slot PH 1 2 3 Cross slot PZ 1 2 TX T10 T15 T20 T25	0,235

1

FIRM HOLD

- Due to the strong magnet the bits are firmly fixed

2

EASY OPERATION

- The rotating ring for clockwise and anticlockwise rotation as well as middle position can be easily switched with one hand

3

NO NOTICEABLE RETURN ANGLE

- 4 times less rotation necessary compared to conventional solutions due to a return angle of almost 0°.

4

INTEGRATED BIT MAGAZINE

- Flexibility through integrated bit holder with different profiles for various screwdriving applications



FLEXIBLE
WORKING

„The GEDORE magazine screwdriver is an innovative and useful aid for various screwdriving applications.“



2675 RATCHET SCREWDRIVER SILENTGEAR 1/4" BIT HOLDER

- › Highly compact ratchet screwdriver
- › For precision working in confined spaces
- › Very small return angle, practically 0° (not measurable with mechanical measuring equipment)
- › Rotating ring for clockwise/anticlockwise rotation adjustment, screw tightening also without ratchet function thanks to neutral central position with ratchet lock

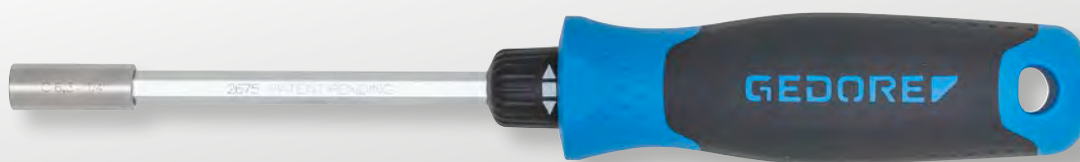

Code	No.	Drive square inch	Drive square mm	Weight kg
3031918	2675	1/4"	6,3	0,14

QUALITY RATCHET WITH MATCHING ACCESSORIES

The compact bit socket box is the ideal solution for industry, crafts and the ambitious DIYer.

The bit socket box with ratchet 1/4" 666-U-20 from GEDORE is suitable for machine and hand-operated use and includes, in addition to the reversible ratchet, a 1/4" cardan extension 50 mm, two 1/4" bit adapters (internal square and hex), extra-thin-walled

1/4" sockets from 4-13 mm and 1/4" screwdriver bits. The reversible ratchet comes up trumps with a low reverse angle of 6°. The foam check tool insert with marking ensures quick access.



1

PREMIUM QUALITY RATCHETS FOR GENTLE WORK

- with low swing back angle of 6° in difficult to access working areas with little space

2

POWERFUL SOCKETS

- The sockets are designed for machine and hand-operated use and are extremely thin-walled

3

UNIVERSAL IN USE

- The set contains 35 tools and accessories for the most common wrench sizes and profiles

4

LIGHTWEIGHT

- Compact box with hard foam insert and transparent lid for easy viewing of the tools



"The set is ideal for use on the road. The transparent cover makes it possible to see the contents of the set at first glance."

666-U-20 BIT SOCKET WRENCH BOX WITH RATCHET 1/4"

35 pieces



- > Practical composition: Bit sockets and ratchet for industry, trade and the ambitious do-it-yourselfer
- > Reversible ratchet with integrated clockwise/anticlockwise operation
- > The release button ensures a secure socket insertion
- > Socket wrench sockets hexagonal particularly thin-walled for manual and machine use: SW 4-13
- > Bit socket wrench box made of plastic with hard foam inlay and a transparent lid for quick check of completeness after work



Code	No.	Contents	Length mm	Width mm	Depth mm	Pieces	Weight kg
2998211	666-U-20	Power screwdriver bit 1/4" hexagon 4.5 5.5 6.7 8.9 10 11 12 13 mm Screwdriver bit 1/4" hexagon 4.5 6 8 mm, Screwdriver bit 1/4" TX T10 T15 T20 T25 T27 T30 T40 Screwdriver bit 1/4" cross recess PH1 PH2 PH3 PH3 PZ1 PZ2 PZ3, Screwdriver bit 1/4" slot 4.5 5.5 6.5 mm Cardan extension 1/4" 50 mm, Bit adapter 1/4" 4ct - 1/4" 6ct, Adapter 1/4" 6kt male - 1/4" 4kt male, GEDORE reversible ratchet 1/4" No. 2093 U-20	107	143	42	35	0,57

20 EMU-10 SOCKET SET 1/4"

16 pieces



- > With hand-operated hexagon sockets
- > With operating tools
- > With fine toothed, dial change ratchet
- > In plastic case



Code	No.	Contents	Width mm	Depth mm	Pieces	Weight kg
6162220	20 EMU-10	Ratchet 2093 U-10, Inserts 20 4 4.5 5 5.5 6.7 8.9 10 11 13 Accessories Cross handle with slide 2087 1/4" extension 2090-4, Cardan joint 2095, 1/4" square plug-in handle 2098	200	38	16	0,79

20 LMU-10 SOCKET SET 1/4"

49 pieces



- > For the manual loosening and tightening of screws and nuts
- > With operating tools
- > In plastic case



Code	No.	Contents	Width mm	Depth mm	Pieces	Weight kg
1815687	20 LMU-10	Ratchet 2093 U-10, Inserts Unit-Drive D 20 4 5 6 7 8.9 10 11 12 13 Hexagon 20 L 4.4 5 5.6 7 8.9 10 12 13 680 4 6,5 685 3 4 5 6 8 685 X 5 6 8 687 TX T10 T15 T20 T25 T27 T30 T40 690 1 2 690 PZD 1 2 3 Accessories 620 1/4" multi handle 676699, 1/4" extension 2090-2-6, Cardan joint 2095	275	42	49	1,262

30 GMU-10 SOCKET SET 3/8"

17 pieces

- > With hand-operated hexagonal UD profile sockets
- > With operating tools
- > Set U-10 with reversible lever change ratchet
- > In GEDORE blue sheet steel case

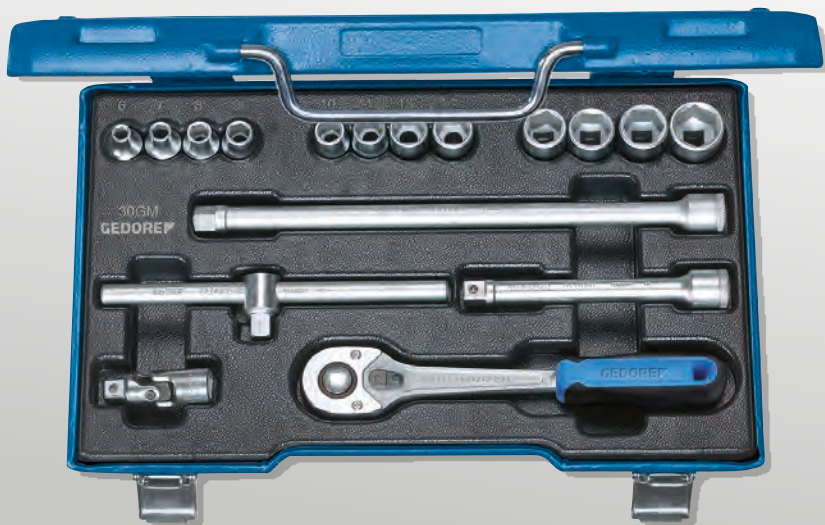

10 3/8 mm

Code	No.	Contents
6235710	30 GMU-10	Ratchet 3093 U-10 Inserts 30 6 7 8 9 10 1113 14 15 16 17 19 Accessories 3/8" cross handle with sliding block 3087 3/8" extension 3090-5-10 3/8" universal joint 3095

Width mm	Depth mm	Pieces	Weight kg
320	55	17	2,6

D 30 HMU-10 SOCKET SET 3/8"

22 pieces

- > With manually operated 12-point UD profile sockets
- > With operating tools
- > Set U-10 with reversible lever change ratchet
- > In GEDORE blue sheet steel case



10 3/8 mm

Code	No.	Contents
6239700	D 30 HMU-10	Ratchet 3093 U-10 Inserts D 30 6 7 8 9 10 1112 13 14 15 16 1718 19 20 21 22 Accessories 3/8" cross handle with sliding block 3087 3/8" extension 3090-5-10 3/8" universal joint 3095

Width mm	Depth mm	Pieces	Weight kg
320	55	22	3,1

D 30 TX20 U-20 SOCKET SET 3/8" + 1/4"

50 pieces



- > Tool set for general industrial and automotive applications
- > Inserts 3/8" and 1/4" for inside and outside TX screws
- > With robust lever-change reversible ratchets, with push-button release
- > In GEDORE blue sheet steel case with Check-Tool insert

10 3/8 6,3 1/4 6,3 1/4



Code	No.	Contents	Width mm	Depth mm	Pieces	Weight kg
2075695	D 30 TX20 U-20	Ratchet 3093 U-20/2093 U-20 Inserts 3/8" D 30 10 11 12 13 14 15 16 17 18 19 21 22 3/8" TX 30 E11 E12 E14, 3/8" ITX 30 T45 T50 1/4" D 20 4 5 5,5 6 7 8 9 10 12 13, 1/4" TX 20 E5 E6 E7 E8 E10 1/4" 687 TX T10 T15 T20 T25 T27 T30 T40 Accessories 3/8" extension 3090 KR-3, 3/8" extension 3090-5 3/8" extension 2090 KR-5, 1/4" extension 2090-6620673 6,3 10676699	320	55	50	3,2

IN 30 LKM SCREWDRIVER SET 3/8"

10 pieces



- > For hexagon socket screws, short and long
- > In plastic case

3/8 mm

Code	No.	Contents	Width mm	Depth mm	Pieces	Weight kg
1509918	IN 30 LKM	IN 30 4 5 6 8 10, IN 30 L 4 5 6 8 10	200	38	10	0,761

ITX 30 TX-015 SCREWDRIVER SET 3/8"

15 pieces



- > For protruding and recessed TX screws
- > In plastic case

10 3/8

Code	No.	Contents	Width mm	Depth mm	Pieces	Weight kg
1509942	ITX 30 TX-015	ITX 30 T20 T25 T27 T30 T40 T45 T50, TX 30 E5 E6 E7 E8 E10 E11 E12 E14	200	38	1	0,801

INTELLIGENT SOLUTION FOR DEMANDING SCREW CONNECTIONS

The combination of a particularly low overall height and special inserts for threaded and bolted connections makes this set a real problem solver.

The practical socket wrench set 19 SKU-20 is suitable for 1/2" screwing on threaded rods, tie rods, torsion bars, shock absorber nuts and for pulley assembly on alternators in SW 10-24 mm. The GEDORE reversible ratchet has a compact hexagonal system that is hollow on the inside, making it possible to screw on threaded rods or protruding bolts. The internal mounting of the inserts also ensures a comparatively low overall height of the inserts with ratchet compared with conventional solutions on the market.

In addition, the ratchet's low swing-back angle of 6° provides additional support in tight installation spaces. Ideal power transmission of the sockets is provided by the wave shape of the UD profile. The check tool insert stores the inserts in the wrench sizes 10-24mm safely and clearly in the robust sheet steel case.



19 SKU-20 SOCKET SET 1/2"

14 pieces

- > Through hole socket wrench set for long bolts or threaded rods
- > With hand-operated sockets No. 19 SK with external hexagon drive
- > With robust lever-change reversible ratchet with in-hex drive
- > Fine toothed, return angle 6°
- > In GEDORE blue sheet steel case



Code	No.	Contents	Length mm	Width mm	Depth mm	Pieces	Weight kg
2521563	19 SKU-20	Ratchet 1993 U-20 SK Inserts 19 SK 10 11 12 13 14 15 16 17 18 19 21 22 24	330	320	55	14	1,7

1

PREMIUM QUALITY RATCHET FOR PRECISE WORK

- with low swing back angle of 6° in difficult to access working areas with little space

2

LOW OVERALL HEIGHT

- The internal hexagonal mounting of the inserts results in an exceptionally low overall height, which is also suitable for screw connections in the tight spaces.

3

SPECIAL INSERTS 2 IN 1

- The special inserts are suitable for conventional screw connections as well as for screw connections on threaded rods or protruding bolts.

4

FLEXIBLE IN USE

- The set contains 13x different inserts with the most common wrench sizes



WHERE OTHERS
GIVE UP!

"When conventional ratchets can't help, the 1993 U-20 SK comes into its own, loosening through-bolts with ease."



19 IMU-10 SOCKET SET 1/2"

27 pieces

- > With hand-operated hexagonal UD profile sockets
- > With operating tools
- > With robust lever-change reversible ratchet, with push-button release
- > In GEDORE blue sheet steel case



12,5 1/2 1/2 mm

Code	No.	Contents	Length mm	Width mm	Depth mm	Pieces	Weight kg
6139750	19 IMU-10	Ratchet 1993 U-10 T Inserts 19 10 11 12 13 14 15 17 19 22 24 27 30 IN 19 5 6 7 8 10 12 14 IS 19 8 10, ICS 19 2 3 Accessories 1/2" extension 1990-5-10, Cardan joint 1995	277	425	55	27	6,9

19 DMU-20 SOCKET SET 1/2"

15 pieces



- › With hand-operated hexagonal UD profile sockets
- › With operating tools
- › With robust lever-change reversible ratchet, with push-button release
- › With universal extension, is able to pivot up to 15°



Code	No.	Contents	Length mm	Width mm	Pieces	Weight kg
3014347	19 DMU-20	Ratchet 1993 U-20, Inserts 19 10 12 13 15 16 17 18 19 22 24 27 30 32 Accessories 1/2" extension 1990 KR-10	380	187	15	5,142

IN 19-009 SCREWDRIVER SET 1/2"

9 pieces

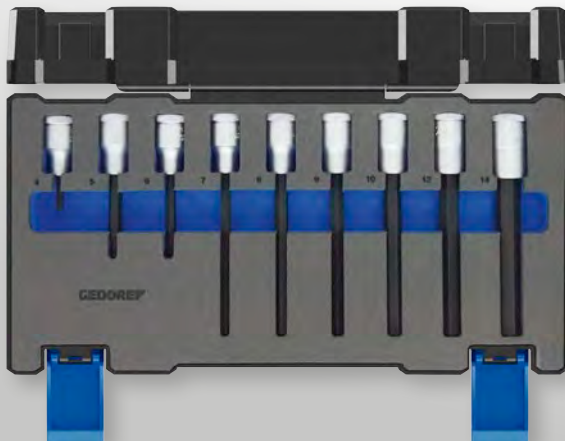

- › Screwdriver set 1/2" for hexagon socket screws in sizes 4 - 14 mm
- › In a practical, robust plastic case



Code	No.	Contents	Length mm	Width mm	Depth mm	Pieces	Weight kg
3014444	IN 19-009	IN 19 4 IN 19 L 5-90 6-90 7-140 8-140 9-140 10-140 12-140 14-140	360	190	70	9	1,9

ITX 19 PM SCREWDRIVER SET 1/2"

9 pieces



- › For internal TX screws
- › In GEDORE blue sheet steel case



Code	No.	Contents	Width mm	Depth mm	Pieces	Weight kg
6158970	ITX 19 PM	T20 T25 T27 T30 T40 T45 T50 T55 T60	281	35	9	1,2

D 19 L-015
SOCKET SET 1/2"
 15 pieces

- › Extensive range of accessories with forged, tempered, hand-operated 12-point UD profile sockets
- › In the robust GEDORE blue sheet steel case



Code	No.	Contents
2190214	D 19 L-015	10 12 13 14 15 16 17 18 19 21 22 24 27 30 32 mm

Width mm	Depth mm	Pieces	Weight kg
320	55	15	4,3

19 V20U-10
SOCKET SET 1/4"+1/2"
 50 pieces

- › For the controlled and manual unscrewing and tightening of screws and nuts
- › Compiled from everyday jobs for industry and mechanics
- › Small 6° return angle from a fine-toothed, 50 teeth reversible ratchet
- › The release button ensures a secure socket insertion
- › With forged, tempered, manually operated double hex sockets
- › With accessories made from GEDORE vanadium steel 31CrV3
- › Resilient, long-lasting blue GEDORE sheet steel case



Code	No.	Contents
6157490	19 V20 U-10	Ratchet 1/2" 1993 U-10T, 1/4" 2093 U-3 Inserts 1/2" 19 10 11 12 13 14 15 17 19 22 24 27 30 IN 19 7 8 10 12 14 IS 19 8 10 ICS 19 3 1/4" 20 4 4,5 5 5,5 6 7 8 9 10 11 13 IN 20 3 4 5 6 IS 20 4 5,5 6,5 ICS 20 1 2 Accessories 1/2" extension 1990-5-10, 1/2" universal joint 1995 1/4" square plug-in handle 2098, 1/4" extension 2090-2-4 1/4" cross handle with sliding piece 2087, 1/4" universal joint 2095

Length mm	Width mm	Depth mm	Pieces	Weight kg
277	425	55	50	6,2

SIMPLE SORTING



19 BMC 20 SOCKET SET 1/4"+1/2"

69 pieces

- › The GEDORE plastic ratchet box is suitable for industry, the automotive sector and for do-it-yourselfers and hobby screwdrivers
- › It is equipped with a black/blue foam check tool insert, which makes the absence of the tools more visible
- › The droplet-like head of the reversible ratchets make this set ideal for the tightest of bolting positions
- › 1/4" and 1/2" socket wrench hexagon set with all metric sizes from 4-32 mm and bit set for the most popular drives, such as slot, PH, PZ, TX XZN & in-hex
- › The reversible ratchets feature a dual material handle, lever change and press-button release for easy, rapid and safe working
- › Depending on the width across flats, the sockets can be extended up to 375 mm in the drive depth



Code	No.	Contents	Length mm	Width mm	Depth mm	Pieces	Weight kg
3108902	19 BMC 20	Ratchets 1/4" + 1/2, Reversible ratchets 1/4" 2093 U-20 reversible ratchets 1/2" 1993 U-20, Socket wrench inserts 1/4" + 1/2 Hexagonal inserts 1/4" SW 4 4,5 5,5 6 7 8 9 10 11 12 13 14 mm Hexagonal inserts 1/2" SW 15 16 17 18 19 21 22 24 27 30 32 mm Hexagonal inserts long 1/2" SW 10 13 17 19 mm Bits 1/4 Hexagon socket 2 3 4 5 6 8 mm TX, with bore T10 T15 T20 T25 T27 T30 T40, Slot 4 5 5 6 5 8 mm Cross recess PH 1 2 3, Cross recess PZ 1 2 3, Multi-tooth XZN M4 M5 M6 M8 Accessories 1/4" + 1/2, Extension 1/4" 50 100 mm, Adaptor 1/4" x 1/4" Bit-Holder 1/4". T-handle 1/4", Cardan joint 1/4 Extension 1/2" 125 250 mm, Cardan joint 1/2, T-Handle 1/2"	459	350	87	69	5,7

32 FMU-2 SOCKET SET 3/4"

16 pieces



- › For unscrewing and tightening screws and nuts involving large sizes
- › Ideal for daily fixed or mobile use in the utility vehicle garage or in industry
- › Socket wrench inserts with screw-protecting hexagonal UD profile
- › Resilient, long-lasting GEDORE blue sheet steel case

20 3/4" mm

Code	No.	Contents
6281150	32 FMU-2	Ratchet 3293 U-2, Inserts 32 22 24 27 30 3236 38 41 46 50 55 60 Accessories Cross handle with sliding piece 3287, 3/4" extension 3290-8-16

Width mm	Depth mm	Pieces	Weight kg
555	80	16	15,8

D 32 EMU-2 SOCKET SET 3/4"

14 pieces



- › For unscrewing and tightening screws and nuts involving large sizes
- › Ideal for daily fixed or mobile use in the utility vehicle garage or in industry
- › Socket wrench inserts with screw-protecting 12-edge UD profile
- › Resilient, long-lasting GEDORE blue sheet steel case

20 3/4" mm

Code	No.	Contents
6280420	D 32 EMU-2	Ratchet 3293 U-2, Inserts D 32 22 24 27 30 3236 38 41 46 50 Accessories Cross handle with sliding piece 3287, 3/4" extension 3290-8-16

Width mm	Depth mm	Pieces	Weight kg
525	73	14	11,09

D 21 EMU-10 SOCKET SET 1"

15 pieces



- › With manually operated 12-point UD profile sockets
- › With operating tools
- › With robust lever-change reversible ratchet
- › Resilient, long-lasting GEDORE blue sheet steel case

25 1" mm

Code	No.	Contents	Length mm	Width mm	Depth mm	Pieces	Weight kg
6181600	D 21 EMU-10	Ratchet K 2193 U-10 K, Inserts D 21 36 41 46 5055 60 65 70 75 80 Accessories 1" extension 2190-8-16, 1" cross handle 2187 G2187 K	289	765	105	15	32,8

CONNECTING SMALL WITH THE BIG

The adapter set is often a saviour in an emergency, if you do not have all the different drive sizes available.

The 4-piece adapter set SB S 1932-04 from GEDORE is suitable for using tools in several drive sizes. The robust reducers, manufactured to the highest standard, enable 1/2" square drives to be used together with 3/8" sockets and 3/4" to 1/2". The enlarger from 1/2" square drive to 3/4" sockets is another possible combination. The pin or ball lock ensures highly reliable fixing of the inserts and holds them securely

while working. The 1/2" cardan extension is used to make work easier in hard-to-reach screw cases and impresses with its double functionality, with up to 15° swivel option and 230 N-m max. load capacity and straight fixed as a normal extension according to DIN loadable.

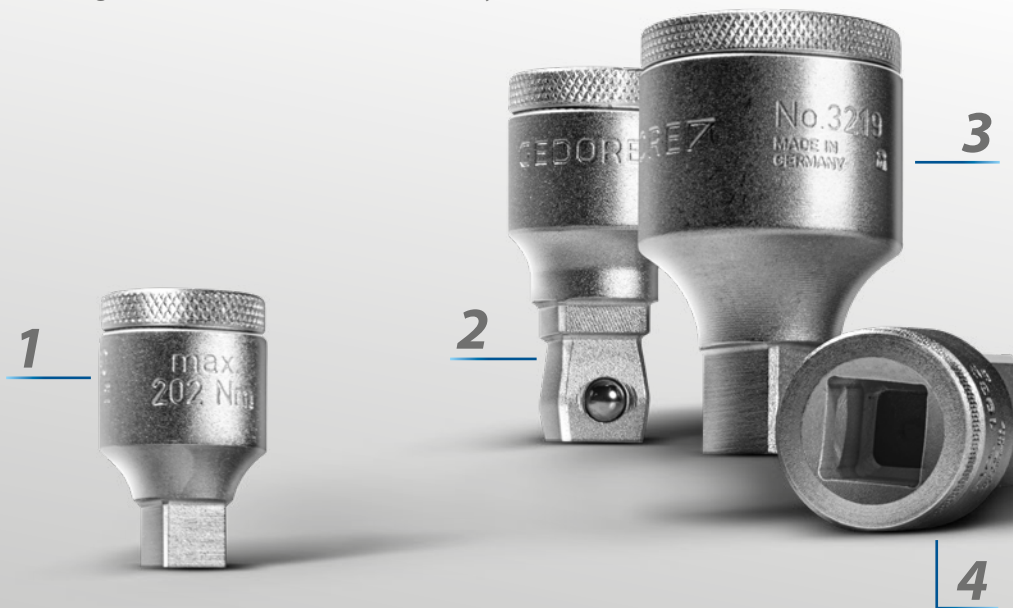

SB S 1932-04 ADAPTOR-SET

4 pieces



- > For hand-operated sockets and accessories with square drive as per DIN 3120, ISO 1174, ball locking device
- > Cardan extension 1/2" with ball head
- > The extension is able to pivot up to 15°
- > Cardan with 230 N-m and fixed as nominal extension according to DIN loadable
- > Fixation is achieved by completely pushing the insert up to the locking square on the extension

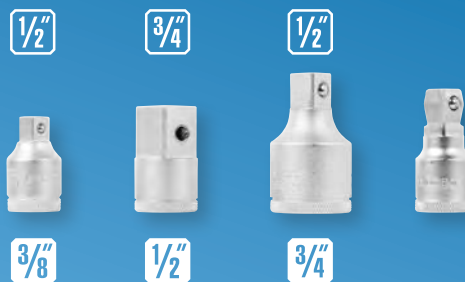

Code	No.	Contents	Length mm	Pieces	Weight kg
3100189	SB S 1932-04	Enlarging piece 1/2" - 3/4" No. 1932 Reducer 1/2" - 3/8" No. 1930 Reducer 3/4" - 1/2" No. 3219 Cardan extension 1/2" No. 1990 KR-2	120	4	0,458

1

POWERFUL REDUCER

- from 3/8" to 1/2" due to highest processing quality, whereby high torques are possible

2

CLEVER GIMBAL EXTENSION 2 IN 1

- Up to 15° swivel option and 230 N-m max. load capacity, as well as straight fixation by repositioning possible and as normal extension and loadable according to DIN

3

RELIABLE SECURE FIXATION

- the reduction from 3/4" with integrated pin lock to 1/2" with ball lock

4

ROBUST ENLARGER

- Allows 3/4" sockets to be used on 1/2" square drive power tools

THE UNIVERSAL ADAPTERS



"With the adapter set, a professional or hobbyist are prepared for any application."

S 2032-05

ADAPTOR SET 1/4" - 3/4"

5 pieces



- › With reduction and enlargement pieces from 1/4" to 3/4"
- › Reducers 1930, 3020
- › Enlargement pieces 2030, 3019, 1932
- › Please observe the maximum load capacities of the outer square edge according to DIN 3123, ISO 3316

6,3	1/4"	10	3/8"
12,5	1/2"	20	3/4"

Code	No.	Contents	Pieces	Weight kg
1729071	S 2032-05	Enlarger 2030 1/4" - 3/8" (max. 62 Nm) Enlarger 3019 3/8" - 1/2" (max. 202 Nm) Enlarger 1932 1/2" - 3/4" (max. 512 Nm) Reducer 3020 3/8" - 1/4" (max. 62 Nm) Reducer 1930 1/2" - 3/8" (max. 202 Nm)	5	0,34

1990 KR UNIVERSAL EXTENSION 1/2"

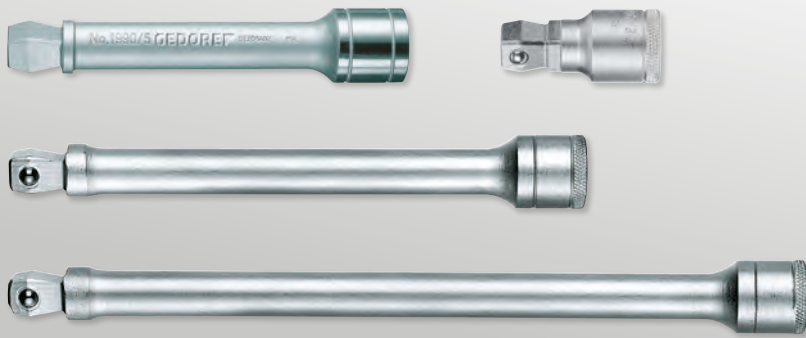

- › For manually operated sockets with square drive 1/2"
- › Especially for difficult to access screwdriving applications a work relief
- › 2 functions: Cardan with 230 N-m and fixed as nominal extension according to DIN loadable
- › Fixation is achieved by completely pushing the insert up to the locking square on the extension

1/2" 1/2"

Code	No.	Drive square inch	Drive square metric	Length mm	Weight kg
3128180	1990 KR-2	1/2"	12,5	50	0,08
6173180	1990 KR-5	1/2"	12,5	125	0,18
6225590	1990 KR-7	1/2"	12,5	180	0,255
6366570	1990 KR-10	1/2"	12,5	250	0,345

SL 20 / SL 19 CONNECTOR STRIP, MAGNETIC empty



6,3 1/4" 6,3 1/4" SL 2013



12,5 1/2" 12,5 1/2" SL 1916

- › Outer square edge suitable for sockets
- › 2 inner square adaptors for ratchets, sliding handles, extensions etc.
- › A strong magnet securely holds the socket rail to ferrous metals
- › Additional holes are provided for wall mounting the socket rail or attaching to non-ferrous materials
- › The inserts are securely locked in place by the ball on the square by rotating them through 90°.
- › By turning 90° in the opposite direction the inserts are released and can be removed



Code	No.	Total length mm	Total width mm	Weight kg
1761080	SL 2013	380	33	0,355
1761102	SL 1916	580	33	0,522

1990 M EXTENSION 1/2" with holding magnet



- › The holding magnet securely fixes the screws or nuts in the socket
- › One-hand operation, the screw or nut can be screwed in immediately with the socket wrench
- › The magnetic field holds nuts and bolts centered in the socket without direct contact
- › The strong permanent magnet holds even large screws



1/2" 

Code	No.	Drive square inch	Drive square metric	Length mm	Weight kg
2697920	1990 M	1/2"	12,5	81,5	0,11

3090 M
EXTENSION 3/8"
 with holding magnet



- > The holding magnet securely fixes the screws or nuts in the socket
- > One-hand operation, the screw or nut can be screwed in immediately with the socket wrench
- > The magnetic field holds nuts and bolts centered in the socket without direct contact
- > The strong permanent magnet holds even large screws



Code	No.	Drive square inch	Drive square metric	Length mm	Weight kg
2960060	3090 M	3/8"	10	65	0,065

K 19-028
IMPACT SOCKET SET 1/2"
 5 pieces



- > 5 power screwdriver sockets suitable for all common compressed air, cordless and electric screwdrivers
- > With square drive as per DIN 3121 - G 12,5, ISO 1174
- > In plastic case



Code	No.	Contents	Pieces	Weight kg
1646923	K 19-028	10 13 17 19 24 mm	5	0,749

K 19 LS-004
IMPACT SOCKET SET 1/2"
 4 pieces



- > 4 Impact socket sets with protective sleeve, hexagon, long form
- > Machine-operated, suitable for all standard electric and air tools
- > With square drive as per DIN 3121 - G 12,5, ISO 1174
- > Plastic coated to protect the aluminium rims
- > GEDORE special steel, manganese-phosphated



Code	No.	Contents	Length mm	Pieces	Weight kg
2790831	K 19 LS-004	K 19 LS 17 19 21 22	81	4	0,98

FROM SMALL TO LARGE

According to the motto: "The locksmith's strength is mighty when he uses the long lever!"

The 1993 TU-10 telescopic reversible ratchet from GEDORE is an indispensable tool for bolting challenges in industry, the trades and on commercial vehicles. The telescopic shaft provides good support for torques of up to 600 N·m and at the same time reduces the amount of force required thanks to the optimised leverage. The length of the shaft is easily adjustable in 8 detents up to 600 mm via the adjustment ring on the handle. The push-button release on the ratchet head locks the 1/2" sockets securely onto the square drive. The right-hand and left-hand rotation can be switched smoothly via the recessed switch

lever. In addition, the telescopic ratchet has a middle position, which allows the mechanism to be locked. The ergonomic 2-component handle ensures a secure and comfortable grip.

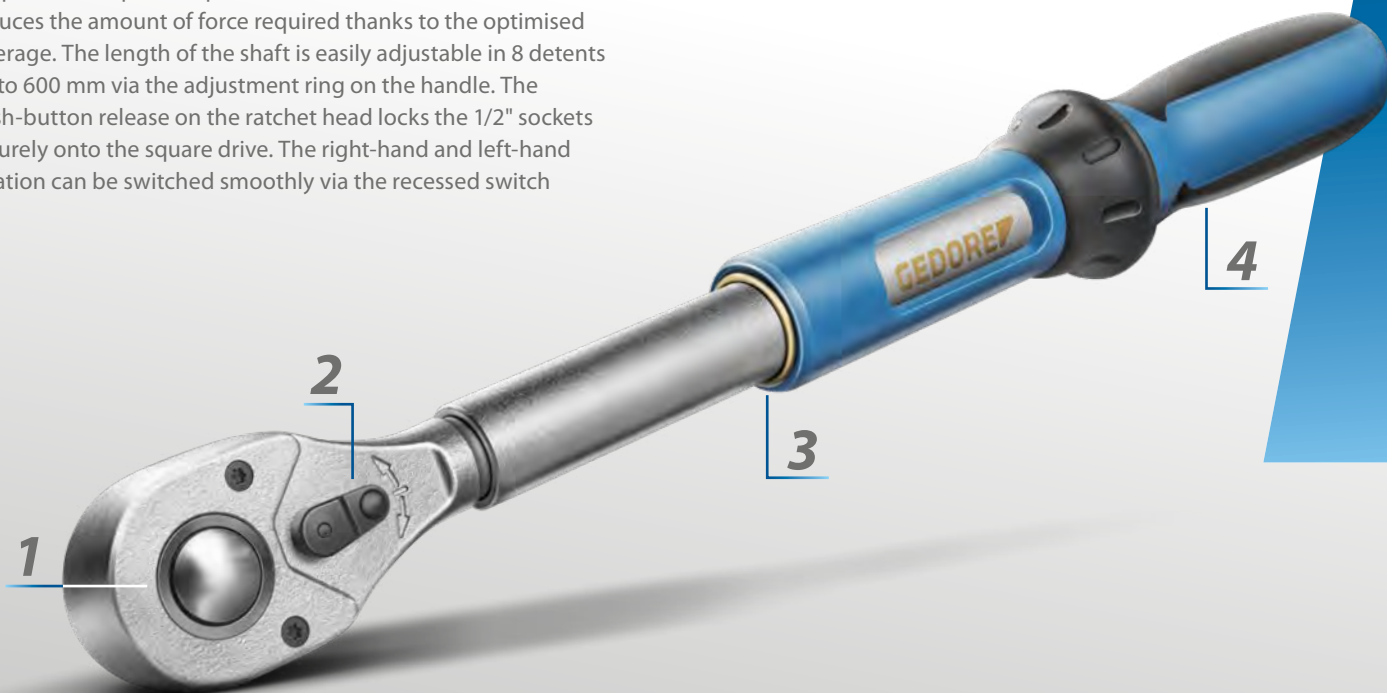

1993 TU-10 TELESCOPIC REVERSIBLE RATCHET 1/2"

- > Telescopic ratchet for loosening seized screws, ideal for changing tyres - Particularly in conjunction with GEDORE torque wrenches and sockets
- > Clockwise/anticlockwise rotation switchable by lever, telescopic shaft lockable in 8 positions - For high torque with less effort and a compact size for stowage when needed
- > Practical push-button release prevents the sockets from being lost, ergonomic 2-component handle for gentle power transmission
- > Maximum load capacity: 600 N·m (meets the requirements of DIN 3122:2017-04), matt chrome-plated surface



Code	No.	Square drive inch	Square drive mm	variable length	Return angle	Weight kg
3041859	1993 TU-10	1/2"	12,5	400-600	7,5°	1,31

1

LOSS PREVENTION

- The push-button release locks the inserts quickly and securely onto the ratchet and ensures a firm grip

2

PRECISE WORK

- The ratchet has 48 teeth and therefore a low swivel angle for precise work.

3

MORE POWER

- The telescopic ratchet can be extended in eight stages to a maximum of 600 mm, resulting in extended leverage. This means that less force has to be applied to tight screws

4

REDUCES OPERATOR FATIGUE

- The non-slip and ergonomic 2-component handle fits comfortably in the hand and enables safe, precise and fatigue-free work.



FOR EVEN
MORE POWER



"Not only is the ratchet handy because of its telescopic feature, but in addition it fits in any workshop trolley and smaller toolboxes."

1993 U-20 G

REVERSIBLE RATCHET 1/2"

with offset handle

- > Universal use in industry and automotive, even in confined spaces, for manually operated sockets and connecting parts with square drive according to DIN 3120 - C 12.5, ISO 1174, with ball locking device
- > Handle offset for barely accessible places
- > Reduces the risk of injury to the fingers when working on flat surfaces
- > Small, drop shaped head for confined areas
- > Fine-toothed (60 teeth), with lever change and push-button release

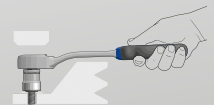
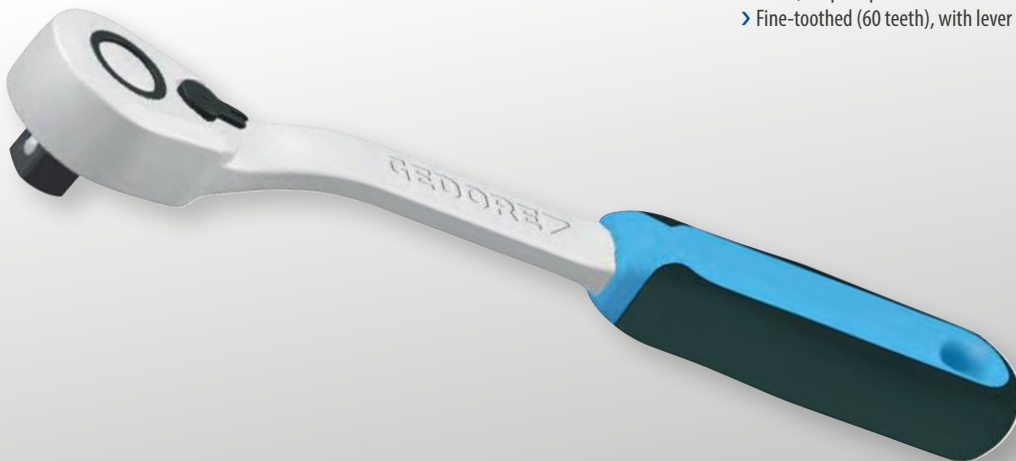

Code	No.	Square drive inch	Square drive mm	Return angle	Length mm	Ratchet head height mm	Number of teeth	Weight kg
2746786	1993 U-20 G	1/2"	12,5	6°	270	37,5	60	0,54

PRECISE IN SHAPE AND TORQUE

The GEDORE TORCOFIX is a torque wrench that allows the user almost intuitive operation.

The Torcofix TF-K torque wrench from GEDORE is ideally suited for repair and maintenance work. The ergonomic handle shape centres the hand in the middle of the handle, which is the optimum position for applying force. Thanks to the fixing recesses on the scale frame, there is optimum counter-holding when adjusting the torque. The scale has been optimised by colouring and central positioning of the scale components, which serves to improve the readability and setting of the

torque values. With a release accuracy of $\pm 3\%$ tolerance from the set scale value, the Torcofix exceeds the DIN EN IS 6789-2:2017 requirements of $\pm 4\%$. Due to the durable 1-component handle, the trigger signal can be felt very well. For work in confined spaces, the new Torcofix is also available as an SE variant.

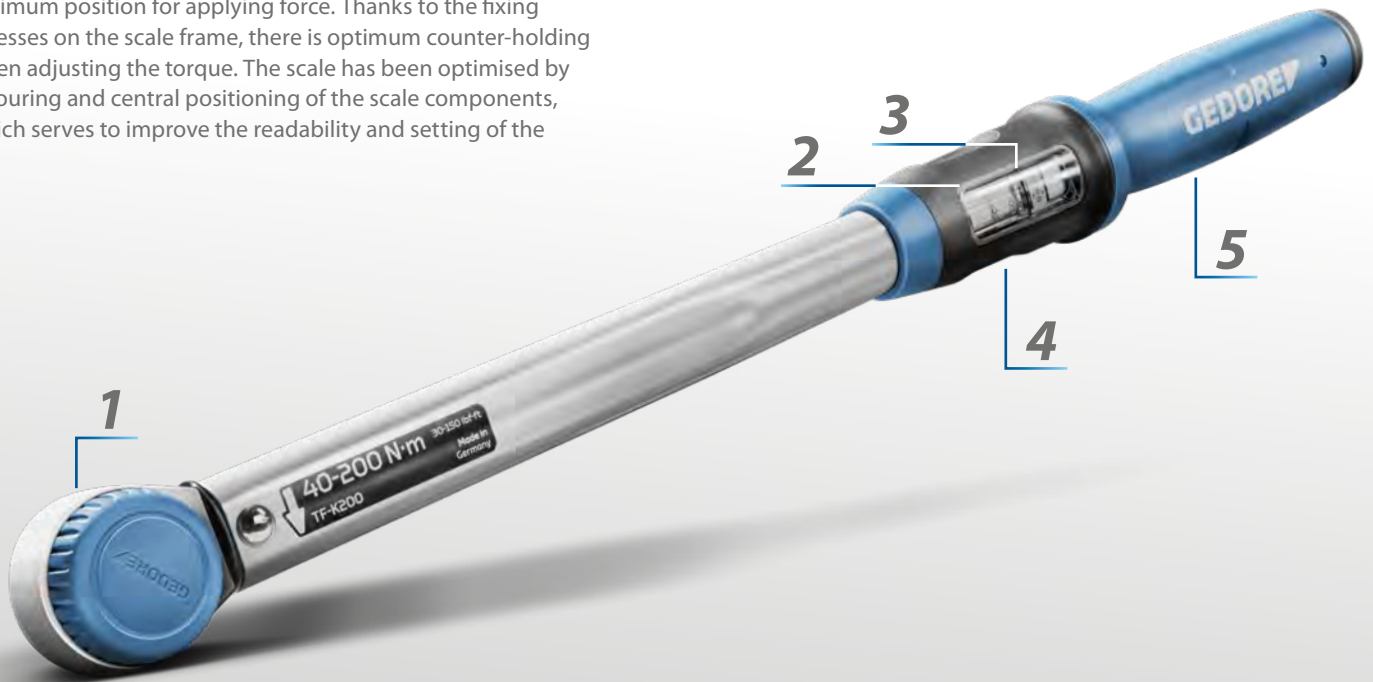

1

CONTROLLED

- Controlled and precise screw tightening from 20-850 N-m
- Deviation of $\pm 3\%$ and thus more precise than the $\pm 4\%$ required by the standard
- Including test certificate according to DIN EN ISO 6789-2:2017

2

IMPROVED READABILITY

- The optimised double scale, the colouring as well as the central alignment of the main scale and vernier ensure better readability of the setting values

3

EASILY READABLE

- Scaling and labeling placed protected under viewing window

4

EASIER TORQUE ADJUSTMENT

- Thanks to the fixing recesses on the scale frame, there is optimum counter-holding during torque adjustment

5

INTUITIVE, ERGONOMIC APPLICATION

- The ergonomic handle shape centers the hand in the middle of the handle.
- Clearly audible and perceptible torque release



"Prescribed tightening torques for almost all screw connections - from stem, to brakes, to drive - can be precisely adhered to with the Torcofix. For the highest bolting quality."

TF-K TORQUE WRENCH TORCOFIX TF-K

20-850 N·m / 15-630 lbf·ft

**Use:**

- > Controlled screw tightening in the most common range of 20 - 850 N·m / 15 - 630 lbf·ft
- > Adjustable, releasing and sturdy tubular torque wrench with integrated ratchet and with square drive for industry and the trades

Features:

- > Classified as per DIN EN ISO 6789-2:2017 Type II Class A; adjusted to a maximum permissible +/-3% deviation and thus with a greater precision than the standard-stipulated +/-4%
- > incl. traceable test certificate (DIN EN ISO 6789-2:2017)
- > For controlled bi-directional tightening
- > 1/2" mushroom head square with ball lock. From 3/4" with square socket and pin retention
- > Robust, matt powder-coated tubular steel construction, with galvanized ratchet and high-quality plastic parts
- > New ergonomic handle, shaped according to the natural grip position of the hand
- > clearly recognisable and tactile hand centring aid and calibration aid in the middle of the handle
- > Double scale N·m / lbf·ft and vernier are protected from abrasion and contamination by an enlarged viewing window
- > With vernier scale for N·m main scale for setting intermediate scale values; lbf·ft setting only via main scale
- > Vertical alignment of the scale, torque adjustment therefore suitable for left and right handers
- > Scale line positioned directly above the scale prevents reading errors (parallax errors)
- > Unit labeling integrated in the scale frame and also protected by viewing windows,
- > Precise jump-off mechanism generates a clearly perceptible and audible trigger signal when the set torque value is reached
- > incl. roll away protection, prevents rolling away when the tool is put down

Code	No.	Drive square inch	Drive square metric	N·m	Scale division	Scale ring	Length mm	Weight kg
3278379	TF-K100	1/2"	12,5	20-100	5 N·m	0,5 N·m	313,3	0,97
3278387	TF-K200	1/2"	12,5	40-200	10 N·m	1 N·m	404,3	1,18
3278395	TF-K300	1/2"	12,5	60-300	10 N·m	1 N·m	495,3	1,37
3278409	TF-K400	3/4"	20	80-400	10 N·m	1 N·m	593,3	1,93
3278492	TF-K550	3/4"	20	110-550	10 N·m	1 N·m	863,8	3,6
3278514	TF-K850	3/4"	20	250-850	10 N·m	1 N·m	1285,8	4,8

TF-SE TORQUE WRENCH TORCOFIX SE

20-400 N·m / 15-300 lbf·ft

Use:

- > Controlled screw tightening in the most common range of 20 - 400 N·m / 15 - 300 lbf·ft
- > Adjustable, releasing and sturdy tubular torque wrench with rectangular cavity for industry and the trades

Features:

- > Classified as per DIN EN ISO 6789-2:2017 Type II Class A; adjusted to a maximum permissible +/-3% deviation and thus with a greater precision than the standard-stipulated +/-4%
- > incl. traceable test certificate (DIN EN ISO 6789-2:2017)
- > For controlled right- and left-hand tightening (change insertion tool for changing direction)
- > Rectangular receptacle incl. ejection aid in the versions 9x12 mm and 14x18 mm
- > Robust, matt powder-coated tubular steel construction, with galvanized ratchet and high-quality plastic parts



378 - 657 mm

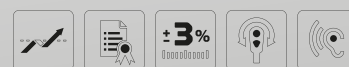
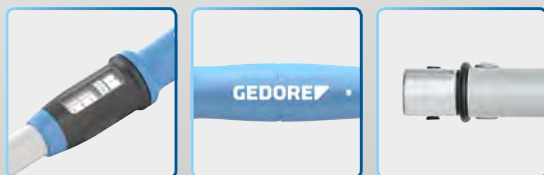

Code	No.	Drive mount, Rectangular	N·m	Scale division N·m	Scale ring	Total length mm	Calibration length	Stitch gauge mm	Weight kg
3278522	TF-SE100	9 x 12 mm	20-100	5	0,5 N·m	378	310,3	17,5	0,77
3278530	TF-SE150	9 x 12 mm	30-150	10	1 N·m	469	401,3	17,5	0,93
3278549	TF-SE200	14 x 18 mm	40-200	10	1 N·m	479	411,3	25,0	1,01
3278557	TF-SE300	14 x 18 mm	60-300	10	1 N·m	570	502,3	25,0	1,19
3278565	TF-SE400	14 x 18 mm	80-400	10	1 N·m	657	589,3	25,0	1,62

3549 UK
TORQUE WRENCH
TORCOFLEX UK
 1-50 N·m

- › Proven torque wrench in the tightening range 1-50 N-m with test certificate
- › Controlled clockwise tightening; bi-directional reversible ratchet
- › Classified as per DIN EN ISO 6789-2:2017; adjusted to a maximum permissible +/-3% deviation and thus with a greater precision than the standard-stipulated +/-4%
- › For controlled directional tightening



225 - 348 mm

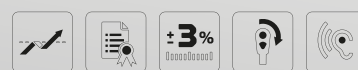

Code	No.	Type	Square drive inch	Square drive metric mm	N-m	Height mm	Distance Housing - Square centre mm	Length mm	Head width mm	Head height mm	Weight kg
2958007	3549-00 UK	Reversible ratchet	1/4"	6,3	1-5	34	12,5	225	25,0	15	0,61
2958015	3549-02 UK	Reversible ratchet	1/4"	6,3	5-25	34	12,5	286	25,0	21,5	0,67
2958023	3549-05 UK	Reversible ratchet	3/8"	10	10-50	34	17,5	348	35,0	19,1	0,825

3550-UK-LS4
TORQUE WRENCH
TORCOFLEX UK SET 1/2"
 5 pieces



- › Tried-and-tested torque wrench in the 40-200 N-m tightening range with test certificate
- › Controlled clockwise tightening; bi-directional reversible ratchet; 1/2" output drive
- › Classified as per DIN EN ISO 6789-2:2017; adjusted to a maximum permissible +/-3% deviation and thus with a greater precision than the standard-stipulated +/-4%
- › Highly suited for car tyre changing given its 1/2" extension and impact sockets with protective sleeve in the 17, 19 and 21 mm sizes



Code	No.	Type	Square drive inch	Square drive metric mm	Contents	N-m	Height mm	Housing - square centre spacing mm	Length mm	Head width mm	Head height mm	Weight kg
3107027	3550-UK-LS4	Reversible ratchet	1/2"	12,5	Torque wrench TORCOFLEX 40-200 Nm No. 3550-20 UK Extension No 1990-5 Power screwdriver set 1/2", 3 pieces	40-200	44	21,3	499	42,5	22	2,398

ALWAYS THE RIGHT TORQUE

TT3KH 350 ELECTRONIC TORQUE WRENCH TORCOTRONIC III

70-350 N·m / 51,6-258,2 lbf·ft



- › For everyday requirements in assembly or torque control in all production and development areas
- › Microprocessor-controlled, electronic torque wrench
- › For controlled bi-directional tightening
- › Robust workshop construction
- › Wide measuring range in N·m, can be switched to cN·m, lbf·ft or lbf·in
- › With 1/2" reversible ratchet, by exchanging the ratchet it is possible to work with a 14x18 mm rectangular holder
- › Torque and torque angle measure
- › 4 different measuring modes
- › 5 parameters storable
- › USB interface for data exchange
- › 2000 storage places
- › Measurement accuracy torque +/- 1 %, +/- 1 digit
- › Measurement accuracy torque angle +/- 1 %, but min. +/- 1° on 360° with min. 4°/sec
- › Different depth gauges for end fittings programmable
- › Simple to operate with easy to understand icon-menu navigation and 4 functional keys
- › Clearly readable, illuminated LCD display
- › Resolution torque: 0.1 N·m
- › Resolution torque angle: 0.1°
- › PC-software easy to operate for uncomplicated programming and documentation of data
- › Data can be transferred to MS Excel®
- › Key lock
- › Operation with standard Mignon AA or optional with rechargeable-battery (NiMH)
- › Visual signal: 3x LED (yellow, green, red)
- › Acoustic signal: buzzer
- › Acc. to DIN EN ISO 6789, traceable to national standards
- › TÜV SÜD approved, CE and RoHS



Code	No.	Type	Square drive inch	Square drive metric mm	N·m	Length mm	Weight kg
2648644	TT3KH 350	Single square	1/2"	12,5	70-350	900	1,2

THE ORIGINAL - THE DREMOMETER

Controlled bolt tightening is increasingly required in a wide variety of trades to ensure safety or compliance with standards and regulations.

The GEDORE DREMOMETER 8563-01 ensures controlled and safe screw tightening in virtually every assembly situation. And it does so with an accuracy of +/- 3% of the set scale value. This means that it exceeds the standard of +/- 4% specified in accordance with DIN EN ISO 6789:2017. This is guaranteed by the test certificate with which every GEDORE DREMOMETER is supplied. No matter where you apply the force, whether in the

centre of the handle or elsewhere on the DREMOMETER, whether ambidextrous or with an extension tube, the set torque is always achieved exactly - without any shift in values. For those who need to apply more force, the DREMOMETER comes in a set with an aluminium extension tube.



8563-01 TORQUE WRENCH DREMOMETER DR 155-760 N·m / 115-560 lbf·ft

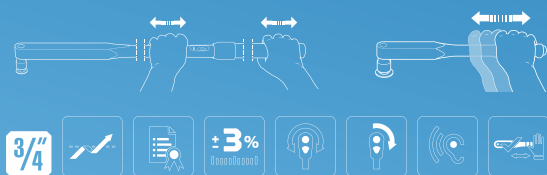

- > With the single and double square for controlled right or left-handed tightening in almost all industrial production areas
- > Controlled screw tightening in the most common range of 155 - 760 N·m / 115 - 560 lbf·ft
- > Automatic short-path actuation with tactile impulse and audible signal
- > Dual scale with a scale graduation of 10 N·m and 10 lbf·ft
- > Classified according to DIN EN ISO 6789-2:2017 Type II Class A, incl. traceable test certificate, calibrated to a maximum permissible deviation of +/- 3% and thus more precise than the +/- 4% required by the standard
- > Lightweight yet robust (as the housing is made of an aluminium alloy) and resilient, very workshop-friendly
- > Length-independent = No value shifts and no influence on accuracy due to two-handed operation or operation outside the handle (as with conventional torque wrenches)
- > Both drive square and pivot point are in one axis, thus high application safety, extendable to reduce the workload of the user
- > Extremely low wear due to force reduction (lever mechanism)
- > Forged lever chain from our group own quality forge
- > Maximum precision even when subjected to extreme continuous use
- > Long life cycles and tool lives
- > Easy operation - fast and safe torque tightening
- > Comfortable adjustment through practical, captive adjustment knob at the end of the handle
- > 3/4" square drive with pin-locking mechanism DIN 3120 - B 20, ISO 1174

Code	No.	Type	Square drive inch	Square drive metric mm	Contents	N·m	Height mm	Housing - square centre spacing mm	Length mm	Head width mm	Head height mm	Weight kg
7670180	8563-01	Single square	3/4"	20	ALU extension tube No. 8571-80	155-760	60	22,5	812	45,0	35	5

1

TESTED QUALITY

- Certified according to DIN EN ISO 6789-2:2017
- Test certificate included
- Robust and lightweight all-metal construction
- German manufacturer

2

APPLIES TORQUE INDEPENDENT OF LENGTH - MORE ACCURACY

- Error-free operation due to length independence
- No value shifting due to handle position or extension tube

3

FATIGUE-FREE, SAFE TIGHTENING

- due to aluminium extension tube for more power
- Clamping sleeve ensures a secure connection

4

PRECISE WORK

- Deviation of +/-3% and therefore more precise than the +/-4% required by the standard.
- Easy to read dual scale in N-m and lb-ft



**THE ORIGINAL
SETS STANDARDS!**



"Often copied, never equalled: with the legendary aluminium DREMOMETER, the first automatically releasing torque wrench with a light alloy/aluminium housing, GEDORE has for decades set benchmarks and standards in the field of mechanical torque wrenches in terms of accuracy, precision and robustness. And to this day, the DREMOMETER is unrivalled."

754

RATCHET HEAD DREMOMETER



3/4"



1"

- > Enables controlled torque tightening in combination with a DREMOMETER torque wrench
- > Fine-pitched, sturdy ratchet head
- > With 3/4" and 1" square drive
- > Made of chrome-vanadium steel
- > Single packed in poly-bag
- > *Max. continuous load of ratchet according to DIN EN ISO 6789-2017 and/or maximum load of cavity



3/4" 1"

Code	No.	Drive mount, Square inch	Drive square inch	Head height mm	Head Ø mm	Swing back angle	Use	Version/ Execution	Continuous load	Weight kg
7680730	754-04	3/4"	3/4"	56	65	10	CD, DS, D, DR, DX	Clockwise	3/4" = 1000 N-m	1
7680810	754-06	1"	1"	62	73	10	E / EK	Clockwise	1" = 2000 N-m	1,8



INSENSITIVE AND ROBUST

8581-01
**TORQUE WRENCH
 DREMOMETER EK**
 600-1500 N-m

- › The high-quality all-metal construction makes the torque wrench particularly insensitive to dirt and rough use on construction sites, in truck and commercial vehicle workshops and in industry
- › Independent of length due to the special design, two-handed operation or operation outside the handle has no influence on the accuracy (as with conventional hand-held screwdriving tools). Extensions to reduce the workload of the user are possible with this wrench
- › Clearly arranged single scale with a scale division of 25 N-m allows an exact adjustment of the measuring range. The torque is adjusted by means of the captive angle wrench in the end of the handle
- › Robust, adjustable torque wrench with 1" single square (25 mm) with pin retention (DIN 3120 - B 25, ISO 1174) for controlled right-hand tightening. The measuring device triggers tactile and audible automatically
- › Classified according to DIN EN ISO 6789-2:2017 Type II Class A, incl. traceable test certificate, calibrated to a maximum permissible deviation of +/- 3% and thus more precise than the +/- 4% required by the standard
- › Aluminium extension tube (8564-92) is ideal for extending the lever arm and achieving high torque values. The anodized clamping nut allows a secure connection with the DREMOMETER

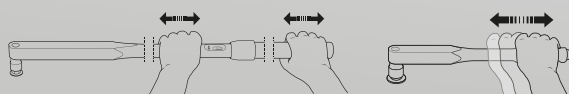

1"

Code	No.	Type	Square drive inch	Square drive metric mm	Contents	N-m	Height mm	Housing - square centre spacing mm	Length mm	Head width mm	Head height mm	Weight kg
2311267	8581-01	Single square	1"	25	Extension tube No. 8564-92	600-1500	71	30	932	60,0	40	10,8

DVV-13Z TORQUE MULTIPLIER DREMOPLUS ALU

1300 N·m / 950 lbf·ft



- › Mechanical, manually operated torque multiplier, with single-stage planetary gear and a housing made of high-performance aluminium, for controlled screw tightening and loosening of screwed connections
- › Particularly suitable for use in industry, construction sites, commercial vehicle and car workshops, agricultural engineering, bridge, ship, aircraft and railway construction, refineries, mechanical and plant engineering and maintenance
- › To be used in conjunction with a torque wrench when precise torque tightening is required. The accuracy of the torque multiplier is better than +/-3
- › With Z-form, offset reaction arm of chrome-vanadium steel
- › Also available as set (No. DVV-13ZG) with three different Impact sockets SW 27, 30, 32 mm
- › Output square with hole for Impact sockets with locking pin and ring
- › The delivery takes place in a stable transport case with foam inlay including a factory test certificate and setting table



Code	No.	Output torque (max.) [N·m]	Output torque (max.) [lbf·ft]	Drive mount, Square inch	Output square	Weight kg
2653370	DVV-13Z	1300	950	1/2"	3/4"	1,3

DVV-40ZRS TORQUE MULTIPLIER DREMOPLUS ALU

4000 N·m / 2930 lbf·ft



- › Mechanical, manually operated torque multiplier, with two-stage planetary gear and a housing made of high-performance aluminium, for controlled screw tightening and loosening of screwed connections
- › Particularly suitable for applications in mechanical and plant engineering, cable cars, lifts and masts, heavy industry, construction sites, bridge building, ship, aircraft and railway construction, refineries, plastics industry and power plants of all kinds
- › To be used in conjunction with a torque wrench when precise torque tightening is required. The accuracy of the torque multiplier is better than +/-3
- › With non-destructive overload protection „slipping clutch“ to protect the gearbox, right and left hand
- › Output square with hole for Impact sockets with locking pin and ring
- › The delivery takes place in a stable transport case with foam inlay including a factory test certificate and setting table



Code	No.	Output torque (max.) [N·m]	Output torque (max.) [lbf·ft]	Drive mount, Square inch	Output square	Weight kg
2653109	DVV-40ZRS	2390	4000	1/2"	1"	4,2

MOBILE TORQUE TESTING

When reliable work with your torque wrench is due, you can calibrate and check your torque wrench yourself in no time.

The Capture Lite CL from GEDORE can be used to check torque wrenches in the workshop, industry and quality assurance. Thanks to a one-touch operation, handling is made a lot easier during the selection of the measuring method and the measuring unit. When the torque wrench is inserted, the tester starts automatically and switches to an auto-sleep mode when not in use. The Capture Lite's well-lit, high-contrast OLED display ensures good and

reliable readability of the measured values. In addition, the torque tester comes up trumps with 3 different measurement modes, the peak value measurement (Peak), buckling point detection (1st Peak) and the analogue display (Track). The selectable units consist of N-m, lbf-in, lbf-ft.



CL ELECTRONIC TEST DEVICE CAPTURE LITE

0,02-350 N·m / 0,015 lbf·ft - 260 lbf·ft

- > Digital torque tester for testing torque spanners and torque screwdrivers.
- > 3 measuring modes: sliding value display (track), buckling point detection (first peak), peak value measurement (peak)
- > In sturdy plastic case with insert



Code	No.	N-m	lbf-ft	Drive socket, Hexagon mm	Drive mount, Square-[metric]	Drive mount, Square-[inch]	Resolution	Adaptor
3119319	CL 10	0,25 N-m - 10 N-m	0,19 lbf-ft - 7,4 lbf-ft	6,3	6,3 mm	1/4"	0,001	1/4" Hexagon socket - 1/4" square socket
3297926	CL 350	10 N-m - 350 N-m	7,4 lbf-ft - 260 lbf-ft		12,5 mm	1/2"	0,01	3/8"

1

EASIER HANDLING

- by push-button operation for selecting the measuring method and the measuring unit Autostart function when a torque tool is plugged in

2

VERSATILE MEASUREMENT MODES

- The Capture Lite impresses with its 3 measurement modes, analog, peak, 1st peak measurement.
- Selectable units: N-m, lbf-in, lbf-ft

3

IMPROVED READABILITY WITH OLED SCREEN

- thanks to the well illuminated OLED display and high-contrast display

4

HIGH ACCURACY

- The measurement deviations are $\pm 1\%$.



HIGH ACCURACY



"This torque tester makes calibrating mechanical torque wrenches quick and easy."

8612-1000

ELECTRONIC TORQUE TESTER DREMOTEST E

90-1100 N-m / 66 lbf-in - 811 lbf-ft

- > For checking or adjusting right-hand torque wrenches and torque screwdrivers, ideal for checking fixed torque wrenches on the line
- > High measurement accuracy: +/- 1% tolerance of reading, +/- 1 digit
- > 1. peak value detection (first peak / breakpoint detection)
- > Can be switched from N-m to lbf-ft and lbf-in



Code	No.	N-m	lbf-ft	Drive mount, Hexagonal mm	Resolution	Adaptor	Weight kg
1947702	8612-1000	90 N-m - 1100 N-m	66 lbf-ft - 811 lbf-ft	36	1,0	1/2", 3/4"	10 kg

QSN600 FH ADJUSTABLE TORQUE SCREWDRIVER - WITH MICROMETER SCALE

1,2-6 N·m



- › Controlled error proof screw tightening in the range of 1.2 - 6 N·m for fast, controlled tightening in the electrical, electronics and apparatus engineering industries and industrial production or quality control - GEDORE Slipping technology
- › Adjustable torque screwdriver - with micrometer scale and additional cross handle for easier working
- › With 1/4" female hexagon drive for use with 1/4" hexagon bits as per DIN 3126 - C 6.3
- › With adaptor also suitable for 1/4" square drive sockets as per DIN 3124
- › Working accuracy: +/- 6 % tolerance of set torque - Exceeds the +/-6% standard accuracy
- › Precision radial ball clutch and cam design for controlled bi-directional tightening
- › Acc. to DIN EN ISO 6789, traceable to national standards
- › Precision mechanism slips very noticeably when the pre-set value is achieved
- › Automatic resetting to the starting position
- › „Positive-Lock" system automatically fixes the set value preventing it from wrong setting
- › Micrometer scale division: 0.1 N·m
- › EPA-conformant (Electrostatic Protected Area), for use in sensitive electrostatic applications - EPA/ESD
- › With additional cross handle for easier working
- › Test certificate acc. to DIN EN ISO 6789



Code	No.	Drive mount inch	Drive mount metric mm	Output piece inch	Output piece metric mm	N·m	Total length mm	Weight kg
1400169	QSN600 FH	1/4"	6	1/4"	6,3	1,2-6	196	0,335

QS9 FH BLUE TORQUE SCREWDRIVER TYPE S

4-9 N·m



- › Controlled screw tightening in the range of 4 - 9 N·m for fast, controlled tightening in the electrical, electronics and apparatus engineering industries and industrial production or quality control
- › Adjustable torque screwdriver - with scale
- › With 1/4" female hexagon drive for use with 1/4" hexagon bits as per DIN 3126 - C 6.3
- › With adaptor also suitable for 1/4" square drive sockets as per DIN 3124
- › Working accuracy: +/- 6 % tolerance of set torque
- › Acc. to DIN EN ISO 6789, traceable to national standards
- › Precision radial ball clutch and cam design for controlled bi-directional tightening
- › Precision mechanism slips very noticeably when the pre-set value is achieved
- › Automatic resetting to the starting position
- › Micrometer scale division: 0.1 N·m
- › Lightweight construction by virtue of anodised aluminium handgrips
- › With additional cross handle for easier working
- › Test certificate acc. to DIN EN ISO 6789
- › Delivery in sturdy cardboard packaging



Code	No.	Drive mounting inch	Drive mount metric mm	N·m	Total length mm	Weight kg
7718210	QS9 FH BLUE	1/4"	6,3 mm	4-9	184	0,335

C 2150-60 PH-06 CENTURY SCREWDRIVER SET

6 pieces

- › High-quality 3C-screwdriver set for tightening and loosening cross and slotted screws, ideal for do-it-yourselfers and professionals
- › Type of drive and size marked at end of the handle
- › Voltage tester
- › Ergonomic handle design enables precise and fatigue-free working
- › Positive-fit joint of handle and blade for optimum transmission of force
- › Screwdriver blade from GEDORE molybdenum-vanadium-Plus tempered steel



Code	No.	Contents	Length mm	Pieces	Weight kg
3106411	C 2150-60 PH-06	3C-Screwdriver slotted No. 2150 5,5 6,5 8 3C-Screwdriver Cross-recess No. 2160 PH 1 2, Phase tester No. 4615 3,5	120	6	0,545

2150-2160 PZ-06 3C-SCREWDRIVER SET

6 pieces

- › High-quality 3C-screwdriver set for tightening and loosening cross and slotted screws, ideal for do-it-yourselfers and professionals
- › Type of drive and size marked at end of the handle
- › Fatigue-free and comfortable working due to 3-component handles with practical hanging hole
- › Positive-fit joint of handle and blade for optimum transmission of force
- › High-quality and durable thanks to tempered blades made of GEDORE molybdenum-vanadium-plus steel



Code	No.	Contents	Pieces	Weight kg
1482300	2150-2160 PZ-06	3C-Screwdriver slot No. 2150 4 5,5 6,5 8, 3C-Screwdriver Cross-recess No. 2160 PZ 1 2	6	0,67

SK 2154 PH-06 3C-SCREWDRIVER SET WITH STRIKING CAP

6 pieces

- › High-quality 3C-screwdriver set for tightening and loosening cross and slotted screws, ideal for do-it-yourselfers and professionals
- › Optimal for loosening tight and rusted screws thanks to impact caps and blade with additional drive hexagon
- › Fatigue-free and comfortable working due to 3-component handles
- › Positive-fit joint of handle and blade for optimum transmission of force
- › High-quality and durable thanks to tempered blades made of GEDORE molybdenum-vanadium-plus steel



Code	No.	Contents	Pieces	Weight kg
1878743	SK 2154 PH-06	Screwdriver with striking cap slot No. 2154SK 4.5 5.5 6.5 8 Screwdriver with striking cap Phillips No. 2160SK PH 1 2	6	0,88

2163 TX-05 3C-SCREWDRIVER SET

5 pieces

- › All-rounder for work in wood, plastic and metal for internal TX screws
- › Type of drive marked at end of the handle
- › Ergonomic handle design enables precise and fatigue-free working
- › Positive-fit joint of handle and blade for optimum transmission of force
- › High-quality and durable thanks to tempered blades made of GEDORE molybdenum-vanadium-plus steel



Code	No.	Contents	Pieces	Weight kg
1482327	2163 TX-05	T10 T15 T20 T25 T30	5	0,435

2163 TXB-05 3C-SCREWDRIVER SET

5 pieces



- › All-rounder for working in wood, plastic and metal for internal TX screws with pin
- › Type of drive marked at end of the handle
- › Ergonomic handle design enables precise and fatigue-free working
- › Positive-fit joint of handle and blade for optimum transmission of force
- › High-quality and durable thanks to tempered blades made of GEDORE molybdenum-vanadium-plus steel



Code	No.	Contents	Pieces	Weight kg
1616617	2163 TXB-05	T10 T15 T20 T25 T30	5	0,44

DT 2142-008 HEXAGON ALLEN KEY SET

8 pieces



- › For in-hex screws
- › With two hexagons, same size each end
- › Long blade with ball end
- › 2-component wing grip for high torque when loosening or tightening
- › Extended wing provides optimal support for the ball of the hand

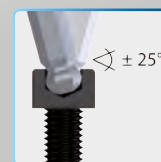

Code	No.	Contents	Length mm	Width mm	Depth mm	Pieces	Weight kg
3037371	DT 2142-008	2 2,5 3 4 5 6 8 10 mm	325	320	45	8	0,97

DT 2143 KTX-007 HEXAGON SOCKET KEY SET TX

7 pieces



- › For inside TX screws
- › With ball end, working angle approx. 25°
- › 2-component wing grip for high torque when loosening or tightening
- › Extended wing provides optimal support for the ball of the hand



Code	No.	Contents	Length mm	Width mm	Depth mm	Pieces	Weight kg
3037398	DT 2143 KTX-007	T10 T15 T20 T25 T27 T30 T40	325	320	45	7	0,71

TWO BRIGHT MINDS!

The added value of the 8-piece offset screwdriver set is on or in the hand.

The compact angle screwdriver set with ball heads on both sides is an intelligent and safe helper for particularly demanding screws. The additional swivel angle of +/- 25° massively facilitates access to installed screws. Due to the additional flexibility of the swivel angle and an extra short

angle side, the challenges in confined installation spaces can be mastered skilfully. In addition, the swivel angle protects against an increased risk of injury to the knuckles and fingertips, as well as the back of the hand. The set consists of the most common offset screwdrivers in sizes 2-10 mm.

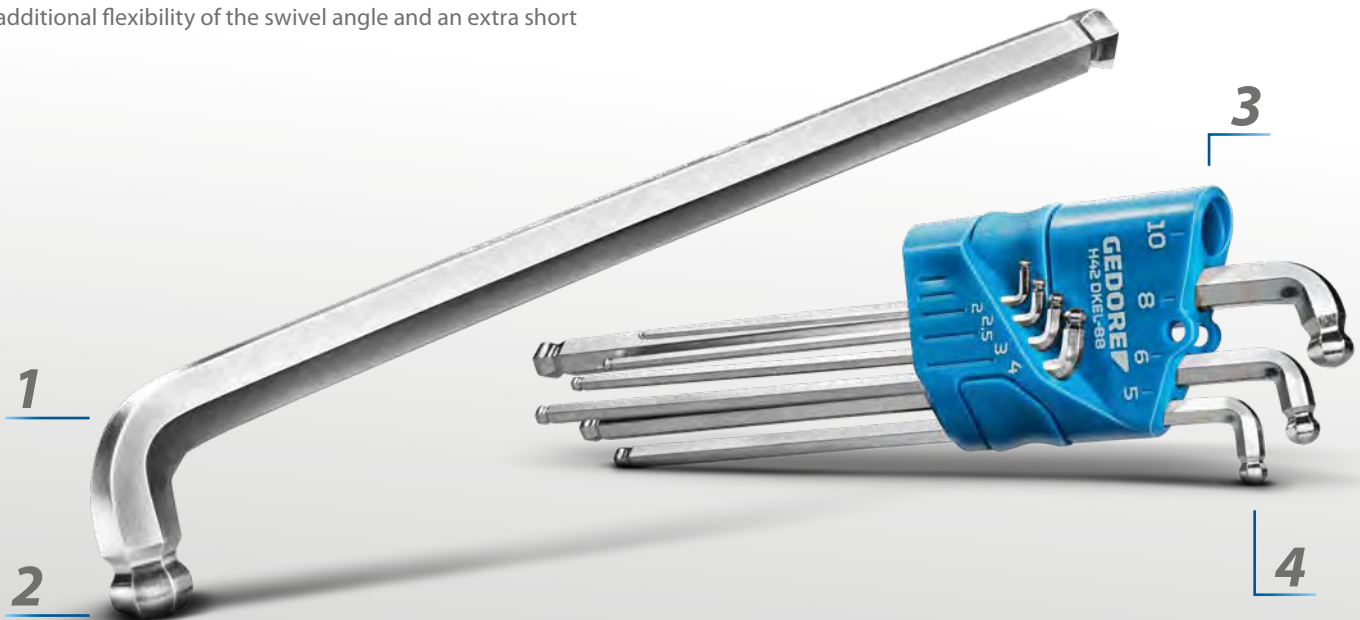

1

EFFECTIVE PROBLEM SOLVER

- The extra short angled side improves accessibility in particularly tight spaces

2

SIMPLE EASY WORKING

- The ball heads on both sides with a swivel angle of up to +/- 25° facilitate accessibility to hard-to-reach places

3

EASY HANDLING

- The compact tool holder facilitates the removal of the individual offset screwdrivers of the 8-piece set

4

REDUCES OPERATOR FATIGUE AND RISK

- The risk of injury to the hands is significantly reduced by the 25° swivel angle

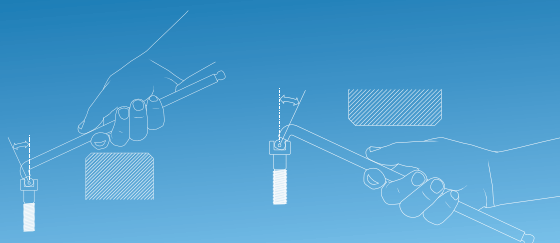

"The offset screwdrivers with double ball head from GEDORE make it easier to access hard-to-reach screws and also protect your hands."

H 42 DKEL-88 HEXAGON ALLEN KEY SET

for hexagon socket screws, extra long, with double ball head, 8 pieces

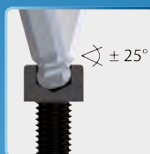

- › For loosening and tightening hexagon socket screws
- › 2 ball heads and extra short angle side for optimum working in confined spaces
- › Better accessibility and low overall height allow screwing without problems where normal offset screwdrivers fail
- › Rapid progress in work since the two ball ends allow protrusions to be gone round
- › Reduces the risk of injury to the fingers when working on flat surfaces



Code	No.	Contents	Length mm	Pieces	Weight kg
2797186	H 42 DKEL-88	2 2,5 3 4 5 6 8 10 mm	230	8	0,4

H 42 CKEL-09 HEXAGON ALLEN KEY SET

color-coded, 9 pieces

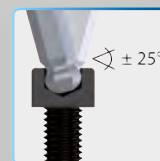

- › For loosening and tightening hexagon socket screws
- › Ball head enables screwing in places that are difficult to access
- › Colour coding simplifies the assignment of the correct key width
- › Key easily removable
- › Abrasion-resistant powder-coated



Code	No.	Contents	Length mm	Pieces	Weight kg
3297470	H 42 CKEL-09	1,5 2 2,5 3 4 5 6 8 10 mm	120	9	0,36

H 43 KTX-07 HEXAGON ALLEN KEY SET

for inside TX screws, 7 pieces

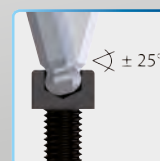

- › For loosening and tightening internal TX screws
- › Ball head enables screwing in places that are difficult to access



Code	No.	Contents	Pieces	Weight kg
1531441	H 43 KTX-07	T10 T15 T20 T25 T27 T30 T40	7	0,169

2004 0620 TOOL TROLLEY



- As basic equipment for the workshop: compact tool trolley with ABS plastic shelf with 3 small parts compartments, 2 can trays, 8 screwdriver trays
- Total load capacity: 1000 kg static, 500 kg dynamic
- Ample storage space with eight drawers, load capacity per drawer 40 kg, lower heavy-duty drawer 60 kg
- Thanks to ball-bearing guide rails with full telescopic extension, the entire drawer can be accessed
- Easy steering and turning thanks to the swivel handle, two GEDORE high-performance wheels with roller bearings (fixed castors Ø 200 mm) and two GEDORE smooth-running wheels with ball bearings (swivel castors Ø 125 mm) with total brake
- Heel and impact protection for your safety
- Front side with Euro perforation 10 x 38 mm to fix hooks and tools
- Wide drawers (W 480 x D 400 mm) with central locking and cylinder lock
- Sheet steel, corrosion resistant and scratch-proof powder-coated
- Can be individually equipped with lengthwise and crosswise dividers (can be ordered individually)

Options:

- Can be equipped with GEDORE tool modules (1500 ES/1500 CT)
- Optionally extendable with GEDORE tool chests, rear panels and tool holders
- Further drawer combinations on request



Code	No.	RAL	Height mm	Width mm	Depth mm	Drawers	Max. load-bearing capacity kg	Number of drawers	Crosswise divider	Lengthwise divider	Weight kg
1640720	2004 0620	RAL 5017	985	875	606	6x Type 1, H = 67 mm 2x Type 2, H = 137 mm	1000	8	2	10	88

1500 ES-02-2004 TOOL TROLLEY WITH TOOL ASSORTMENT

207 pieces



- High-performance tool trolleys in proven GEDORE industrial quality with basic equipment for the commercial sector or the ambitious do-it-yourselfer
- Heel protection bend and ram protection ensure safety
- Tools in metric sizes
- Proven GEDORE ES tool modules in ABS plastic
- Resistant to oils and greases
- In tool trolley No. 2004 0620

Detailed listing of the range contents from page 60 onwards

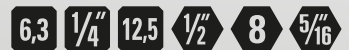

Code	No.	Contents	Length mm	Width mm	Depth mm	Pieces	Weight kg
2657708	1500 ES-02-2004	Combination wrench set in 2/3 ES-module No. 1500 ES-1 B, Double open ended wrench set in 1/3 ES-module No. 1500 ES-6, 1/2" set of socket wrench inserts in 1/3 ES-module No. 1500 ES-19 IS, 1/2" set of screwdriver inserts in 1/3 ES module No. 1500 ES-ITX 19 LKP, 1/2" set of screwdriver inserts in 1/3 ES module No. 1500 ES-IN 19 LKM, 1/2" accessories for socket wrench inserts in 1/3 ES module No. 1500 ES-1993 U-20, 1/4" socket wrench assortment in 1/3 ES module No. 1500 ES-20, Socket wrench set in 1/3 ES module No. 1500 ES-2133, Set of open-end wrenches with ring ratchet in 1/3 ES-module No. 1500 ES-7 R, Pliers assortment in 1/3 ES module No. 1500 ES-145, Chisel assortment in 1/3 ES module No. 1500 ES-350, Measuring assortment in 1/3 ES module No. 1500 ES-711, Screwdriver set in 1/3 ES module No. 1500 ES-2150 PH, 1/2" screwdriver assortment in 1/3 ES module No. 1500 ES-K 1900, Set of mounting pliers in 1/3 ES module No. 1500 ES-8000, Distance module empty No.1500 ED-70 K, 475x77x40 mm [6x].+ Tool trolley with 8 drawers No. 2004 0620	475	775	985	207	117,1

1500 ES-03-2004 TOOL TROLLEY WITH TOOL ASSORTMENT

325 pieces



- > High-performance tool trolleys in proven GEDORE industrial quality with extensive industrial range for the professional
- > Heel protection bend and ram protection ensure safety
- > Tools in metric sizes
- > Proven GEDORE ES tool modules in ABS plastic
- > In tool trolley No. 2004 0810

> Detailed listing of the range contents from page 60 onwards



6,3 1/4 12,5 1/2 6,3 1/4 8 5/16

Code	No.	Contents	Length mm	Width mm	Depth mm	Pieces	Weight kg
2657716	1500 ES-03-2004	<p>Puller set in 1/3 ES module No. 1500 ES-1.07</p> <p>Combination wrench set in 2/3 ES-module No. 1500 ES-1 B</p> <p>1/2" set of socket wrench inserts in 1/3 ES-module No. 1500 ES-19 IS</p> <p>1/2" accessories for socket wrench inserts in 1/3 ES module No. 1500 ES-1993 U-20</p> <p>Double-end box wrench set in 1/3 ES module No. 1500 ES-2</p> <p>1/4" socket wrench assortment in 1/3 ES module No. 1500 ES-20</p> <p>1/4" socket wrench assortment in CT module No. 1500 CTD-20 BIT</p> <p>Socket wrench set in 1/3 ES module No. 1500 ES-2133</p> <p>Screwdriver set in 1/3 ES module No. 1500 ES-2150 PH</p> <p>Screwdriver set in 1/3 ES module No. 1500 ES-2163 TX</p> <p>Double jointed key set in 1/3 ES module No. 1500 ES-34</p> <p>Chisel assortment in 1/3 ES module No. 1500 ES-350</p> <p>Double ended ring wrench set in 1/3 ES module No. 1500 ES-400, open</p> <p>Double open ended wrench set in 1/3 ES-module No. 1500 ES-6</p> <p>Set of open-end wrenches with ring ratchet in 1/3 ES-module No. 1500 ES-7 R</p> <p>Measuring assortment in 1/3 ES module No. 1500 ES-711</p> <p>Set of mounting pliers in 1/3 ES module No. 1500 ES-8000</p> <p>Offset screwdriver set in 2/3 ES module No. 1500 ES-DT 2142</p> <p>1/2" set screwdriver inserts hexagon in 1/3 ES-module No. 1500 ES-IN 19 LKM</p> <p>1/2" set of screwdriver inserts in 1/3 ES module No. 1500 ES-ITX 19 LKP</p> <p>1/2" screwdriver assortment in 1/3 ES module No. 1500 ES-K 1900</p> <p>VDE pliers assortment in 1/3 ES module No. 1500 ES-VDE 145</p> <p>VDE Screwdriver set in 1/3 ES module No. 1500 ES-VDE 2170 PZ</p> <p>Screw extractor set No. 8551-55, M3-M18</p> <p>Offset screwdriver set No. H 42 KEL-88, hexagon SW 2 2.5 3 4 5 6 8 10 mm, ball end</p> <p>Offset screwdriver set TX No. H 43 KTX-07, SW TX T10 T15 T20 T25 T27 T30 T40</p> <p>Warding file set No. 8728 Flat file, 3-sided, square, half-round, round file</p> <p>Adjustable open-end wrench No. 60 P 810" Grip Pliers No. 137 10</p> <p>Voltage Detector Slot No. 4615 3, 220-250 V, 3mm</p> <p>Cable knife No. 0513-09, 195 mm 1/2" fast turntable No. 1940</p> <p>Distance module empty No. 1500 ED-70 K, 475x77x40 mm [7x].</p> <p>+ Tool trolley with 9 drawers No. 2004 0810</p>	475	775	985	325	125,8

2005-TS-147

TOOL TROLLEY WITH TOOL ASSORTMENT

147 pieces



- › Perfect tool combination in check tool modules for industry, trade and automotive
- › GEDORE Check-Tool-System: 2-colour foam insert to check that the set is complete
- › Non-slip, with recessed grip
- › Resistant to oils and greases
- › Tools in metric sizes
- › In tool trolley No. 2005 0511

Detailed listing of the range contents from page 60 onwards



Code	No.	Contents	Length mm	Width mm	Depth mm	Pieces	Weight kg
2980282	2005-TS-147	1/4"+1/2" socket key assortment in CT module No. TS CT2-D19-D20, 81 pcs Combination spanner set in CT module No. TS CT2-7, 24 pcs Tool assortment in CT module No. TS CT2-2154SK-119, 14 pcs Pliers set in CT module No. TS CT2-142, 28 pcs + trolley with 7 drawers No. 2005 0511	475	775	985	147	104,3

2005-TS-190

TOOL TROLLEY WITH TOOL ASSORTMENT

190 pieces



- › Perfect tool combination in check tool modules for industry, trade and automotive
- › GEDORE Check-Tool-System: 2-colour foam insert to check that the set is complete
- › Non-slip, with recessed grip
- › Resistant to oils and greases
- › Tools in metric sizes
- › In tool trolley No. 2005 0511

Detailed listing of the range contents from page 60 onwards



Code	No.	Contents	Length mm	Width mm	Depth mm	Pieces	Weight kg
2980290	2005-TS-190	1/4"+1/2" socket wrench assortment in CT module No. TS CT2-D19-D20, 81 pcs Combination wrench set in CT module No. TS CT2-7, 24 pcs Tool assortment in CT module No. TS CT2-2154SK-119, 14 pcs. Pliers assortment in CT module No. TS CT2-142, 28 pcs. Tool assortment in 2/4 CT module No. TS CT2-6-8000, 15 pcs. 1/2" set of screwdriver sockets in 2/4 CT module No. TS CT2-ITX19, 28 pcs + Tool trolley with 7 drawers No. 2005 0511	475	775	985	190	109,6

HUGE ASSORTMENT

2005-TS-308 TOOL TROLLEY WITH TOOL ASSORTMENT

308 pieces

- › Perfect tool combination in check tool modules for industry, trade and automotive
- › GEDORE Check-Tool-System: 2-colour foam insert to check that the set is complete
- › Non-slip, with recessed grip
- › Resistant to oils and greases
- › Tools in metric sizes
- › In tool trolley No. 2005 0511

Detailed listing of the range contents from page 60 onwards

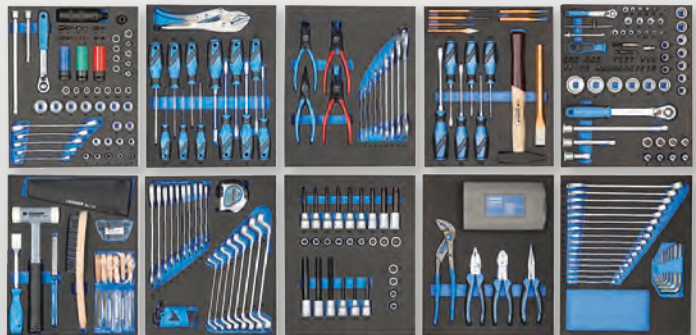

Code	No.	Contents	Length mm	Width mm	Depth mm	Pieces	Weight kg
2980304	2005-TS-308	1/4"+1/2" socket wrench assortment in CT module No. TS CT2-D19-D20, 81 pcs Combination wrench set in CT module No. TS CT2-7, 24 pcs Tool assortment in CT module No. TS CT2-2154SK-119, 14 pcs. Pliers assortment in CT module No. TS CT2-142, 28 pcs. Tool assortment in 2/4 CT module No. TS CT2-6-8000, 15 pcs. 1/2" set of screwdriver sockets in 2/4 CT module No. TS CT2-ITX19, 28 pcs Tool assortment in 2/4 CT module No. TS CT2-2133-2163TX, 13 pcs Wrench set in 2/4 CT module No. TS CT2-7R-2, 28 pcs Tool assortment in 2/4 CT module No. TS CT2-D30, 59 pcs Tool assortment in 2/4 CT module No. TS CT2-710, 17 pcs Hacksaw No. 407+ Tool trolley with 7 drawers No. 2005 0511	475	775	985	308	121,6

2005 0810 TOOL TROLLEY



- › For safer, orderly and mobile storage of tools and equipment
- › Total load capacity 1000 kg static, 500 kg dynamic
- › Working platform in ABS, with 3 compartments for small parts
- › Both side walls with square perforation for attaching torque wrenches or other long tools or small parts
- › Central locking with cylinder lock
- › Wide drawers (W 640 x D 400 mm) fully extendable, removable
- › Each drawer with safety locking, single-hand operation
- › Ball-bearing guide rails
- › Load capacity per drawer 40 kg, lower heavy-duty drawer 60 kg
- › GEDORE trapezoidal axle design ensures smooth running, manoeuvrability and directional stability
- › Can be equipped with GEDORE tool modules (1500 ES/1500 CT or 2005 CT)
- › Optionally extendable with GEDORE tool chests, rear panels and tool holders
- › Further drawer combinations on request

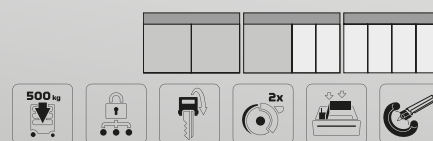

Code	No.	RAL	Height mm	Width mm	Depth mm	Drawers	Max. load-bearing capacity kg	Number of drawers	Crosswise divider	Lengthwise divider	Weight kg
2003562	2005 0810	GEDORE blue, RAL 5017	985	875	606	8x Type 1, H = 67 mm 1x Type 2, H = 137 mm	1000	9	3	15	93

WSL-M6 TOOL TROLLEY WORKSTER SMARTLINE with 6 drawers



- › For safer, orderly and mobile storage of tools and equipment
- › Ample storage space with six drawers, 20 kg load-bearing capacity per drawer
- › High degree of security from individual locking device / individual extraction lock stopping more than one drawer being opened
- › Easy steering and turning thanks to the manoeuvring handle and two Ø 125 mm swivel castors with thread guard, one with total brake
- › Thanks to ball-bearing guide rails with full telescopic extension, the entire drawer can be accessed
- › Drawers with central locking and cylinder lock
- › Side walls with Euro perforation 10 x 38 mm to fix hooks and tools
- › Sides rounded off to minimize abutting edges
- › Working platform with PP top with front flattening and anti-roll safety edge
- › Sheet steel - welded, corrosion resistant and scratch-proof powder-coated
- › One-hand operation of the drawers to make work easier

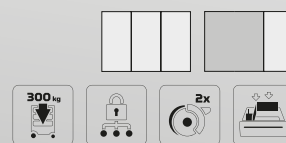

Code	No.	RAL	Height mm	Width mm	Depth mm	Drawers	Max. load-bearing capacity kg	Number of drawers	Weight kg
3100707	WSL-M6	GEDORE blue, RAL 5017	903	629	510	5x Type 1, H = 80 mm 1x Type 2, H = 160 mm	300	6	48

PRACTICAL HIGHLIGHTS



WSL-L7 TOOL TROLLEY WORKSTER SMARTLINE with 7 drawers



- › For safer, orderly and mobile storage of tools and equipment
- › Total load capacity 400 kg
- › Ample storage space with seven drawers, load capacity per drawer 20 kg
- › High degree of security from individual locking device / individual extraction lock stopping more than one drawer being opened
- › Easy steering and turning thanks to the manoeuvring handle and two Ø 125 mm swivel castors with thread guard, one with total brake
- › Thanks to ball-bearing guide rails with full telescopic extension, the entire drawer can be accessed
- › Wide drawers (W 640 x D 400 mm) with central locking and cylinder lock
- › Side walls with Euro perforation 10 x 38 mm to fix hooks and tools
- › Sides rounded off to minimize abutting edges
- › Work platform with ABS plastic cover with frontal flattening and roll protection edge
- › Sheet steel - welded, corrosion resistant and scratch-proof powder-coated
- › One-hand operation of the drawers to make work easier
- › Sheet steel, corrosion resistant and scratch-proof powder-coated

Options:

- › Can be equipped with GEDORE tool modules (No. 1500 ES, 1500 CT, 2005 CT, TS-147, TS-190, TS-308)
- › Can be individually equipped with lengthwise and crosswise dividers



Code	No.	RAL	Height mm	Width mm	Depth mm	Drawers	Max. load-bearing capacity kg	Number of drawers	Crosswise divider	Lengthwise divider	Weight kg
2977311	WSL-L7	RAL 5017	1.045	785	510	5x Type 1, H = 80 mm 2x Type 2, H = 162,5 mm	400	7	optionally available	optionally available	85

PREMIUM HELPER

The Workster highline lives up to its name.

The WHL-L7 tool trolley from GEDORE scores with flexibility and ample space for all the tools and accessories that professionals need for easy, productive work. Even under full load, it can be manoeuvred smoothly thanks to its drive and steering handle - and in the tightest of spaces. The maximum load of up to 500 kg can be distributed over seven large and easy-to-operate drawers, as well as a shelf with additional screwdriver holders and shelves for small parts.

The drawers can be fully pulled out via one-hand operation and loaded with 40 kg each. Secure locking is provided by a central lock. Individual pull-out stops prevent the workshop trolley from tipping over and thus ensure more safety at the workplace.



WHL-L7 TOOL TROLLEY WORKSTER with 7 drawers



- > Work platform with PP plastic cover with front flattening and roll protection edge, as well as small additional storage compartments
- > Side walls with Euro perforation 10 x 38 mm
- > Sides rounded off – a minimum of abutting edges
- > Individual blocking only one drawer can be open at a time, single-hand operation
- > Central locking with cylinder lock
- > 7 wide drawers (W 640x D 400 mm) fully extending
- > Load capacity per drawer 20 kg
- > Total load capacity 400 kg

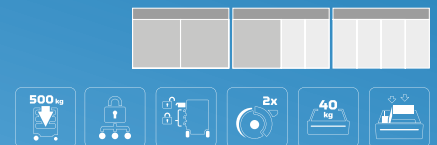

Code	No.	RAL	Height mm	Width mm	Depth mm	Drawers	Max. load-bearing capacity kg	Number of drawers	Weight kg
3033708	WHL-L7	GEDORE blue, RAL 5017	1.045	785	510	5x Type 1, H = 80 mm 2x Type 2, H = 160 mm	500	7	84

1

HIGH QUALITY WORKMANSHIP

- The total load capacity of 500 kg is due to the high-quality workmanship using spot welding technology

2

DOUBLE SECURITY

- The individual pull-out stop per drawer prevents tipping over even with max. load. The impact protection protects other components or vehicles from damage.

3

GENEROUS STORAGE SPACE

- A total of 7 XL drawers with full extension provide the ideal storage space even for extensive range of tools

4

HIGH QUALITY DRAWERS

- The ball bearing guide rails ensure safe and easy running even with a maximum load of 40kg. The full extension provides a complete view into the drawer



FULLY EQUIPPED!

"However, should this professional workshop trolley ever bump into something, the new edge impact protection reliably prevents impact edges and injuries. Its high-quality workmanship and scratch-resistant, corrosion-protecting powder coating also make it fit for rough everyday workshop use."



1578 TOOL TROLLEY



- > Ideal for beginners and basic users or for small workshops with little floor space
- > Total load capacity 200 kg
- > Working platform in ABS, with 3 compartments for small parts
- > Ample storage space with six drawers, 20 kg load-bearing capacity per drawer
- > All drawers extendable on both sides, 4 wide drawers (W 480 x D 325 x H 75 mm), 1 wide drawer (W 480 x D 325 x H 120 mm) and 1 wide drawer (W 480 x D 325 x H 210 mm) with central locking with cylinder lock
- > The GEDORE trapezoidal axle construction secures smooth running, manoeuvrability and track-trueness even in case of maximum loads
- > Easy steering and turning thanks to the swivel handle, two GEDORE high-performance wheels with roller bearings (fixed castors Ø 200 mm) and two GEDORE smooth-running wheels with ball bearings (swivel castors Ø 125 mm) with total brake
- > Safety through heel protection
- > Sheet steel, corrosion resistant and scratch-proof powder-coated, GEDORE blue

Options:

- > Can be equipped with GEDORE tool modules (1500 ES/1500 CT)



Code	No.	RAL	Height mm	Width mm	Depth mm	Drawers	Max. load-bearing capacity kg	Number of drawers	Crosswise divider	Lengthwise divider	Weight kg
9018140	1578	GEDORE blue, RAL 5017	930	605	375	4x Type 1, H = 75 mm 1x Type 2, H = 120 mm 1x Type 3, H = 210 mm	200	6	2	6	43

2430 TOOL CHEST

with 3 drawers



- › Exclusively suitable as attachment for the tool trolleys 2004, 2005
- › Work platform with ABS plastic cover with 3 small parts compartments
- › With three individually partitionable drawers, 6 lengthwise and 2 crosswise dividers included
- › Drawers suitable for 4 each 1/3 modules No. 1500 ES / 1500 CT
- › Drawers fully extendible, removable
- › One-hand operation with safety lock
- › Load capacity per drawer 40 kg
- › Central locking with cylinder lock



Code	No.	Height mm	Width mm	Depth mm	Lengthwise divider	Crosswise divider	Weight kg
1888927	2430	345	775	475	6	2	34

RT 2004 L REAR PANEL BOARD



- › Can be attached to 2004 and 2005 (as well as old models 2002 and 2003)
- › Square perforation 10 x 38 mm for tool hooks and holders No. 1500 H

Code	No.	Length mm	Height mm	Width mm	Weight kg
2663104	RT 2004 L	30	715	765	11

1500 H 25 SPRAY CAN HOLDER

for 8 spray cans



- › Compatible with standard Euro square perforation 10 x 38 mm
- › Can also be used as transport box due to removable dividers
- › powder-coated
- › With carrying handle
- › Interior dimensions compatible with GEDORE 1500 CT modules
- › Front square perforation for additional hooks (not included)
- › Delivery without tools and accessories

Code	No.	Length mm	Height mm	Width mm	Weight kg
3127907	1500 H 25-8	99	99	99	2,05

1500 H 40 PAPER ROLL HOLDER



- › For paper rolls up to diameter 320 mm and width 320 mm
- › Lateral perforation for additional hooks (not included in delivery)
- › Made of sheet steel
- › Colour RAL 9005 black
- › Suitable for all tool trolleys/benches with Euro perforation 10 x 38 mm
- › Delivery without tools and accessories

Code	No.	Length mm	Width mm	Weight kg
2997754	1500 H 40	200	350	1,1

411-150 PARALLEL VICE



- › Serrated jaws ensure that the workpieces are held securely
- › Sturdy forged design, extremely resilient
- › Jaws and anvil plate induction hardened
- › Precise and durable due to adjustable guide
- › Internal vice spindle protected against dirt and damage

Code	No.	Jaw width mm	Clamping depth usable mm	Weight kg
6501290	411-150	150	200	18,474

1504 0810 MOBILE WORKBENCH with 9 drawers



- › For safer, orderly and mobile storage of tools and equipment
- › 30 mm thick multiplex beech plywood board, surface additionally protected by linseed oil varnish
- › Ample storage space with nine removable and wide drawers (W 480 x D 400 mm)
- › Thanks to ball-bearing guide rails with full telescopic extension, the entire drawer can be accessed
- › The GEDORE trapezoidal axle construction secures smooth running, manoeuvrability and track-trueness even in case of maximum loads
- › Large storage space with shelf and lockable door
- › Heel protection for personal safety
- › Central locking with cylinder lock, simultaneous closure of drawers and door
- › Load capacity per drawer 40 kg, bottom heavy-duty drawer 60 kg
- › GEDORE heavy-duty chassis, two roller-bearing GEDORE heavy-duty wheels (fixed castors Ø 200 mm) and two ball-bearing GEDORE smooth running wheels (swivel castors Ø 125 mm) complete with two total brakes
- › Total load capacity 1000 kg static and 750 kg dynamic
- › Optimum equipment thanks to GEDORE tool modules
- › Sheet steel - welded, corrosion resistant and scratch-proof powder-coated

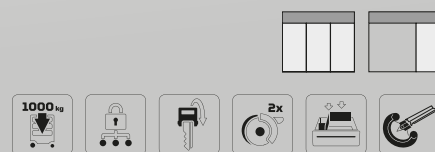

Code	No.	Length mm	Width mm	Height mm	Worktop thickness mm	Drawers	Number of drawers	Weight kg
1814923	1504 0810	550	1.100	985	30	8x Type 1, H = 67 mm 1x Type 2, H = 137 mm	9	111

R 1504 L REAR PANEL

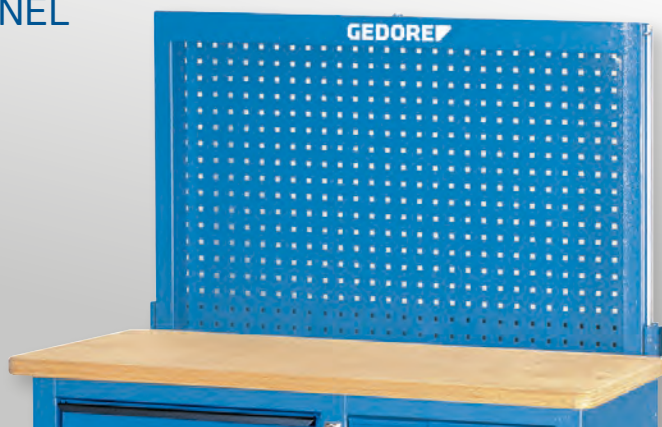

- › Can be attached to workbenches 1504 and 1505
- › Automatically liftable with 2 gas pressure springs, lockable with cylinder lock
- › Neat arrangement of tools
- › Square perforation 10 x 38 mm for tool hooks and holders No. 1500 H

Code	No.	Length mm	Height mm	Width mm	Weight kg
6623800	R 1504 L	70	640	1.000	27

1504 XL MOBILE WORKBENCH EXTRA WIDTH

with 7 drawers



- › For safer, orderly and mobile storage of tools and equipment
- › 4 drawers with ample storage space, as well as an XL drawer, six wide removable drawers
- › Thanks to ball-bearing guide rails with full telescopic extension, the entire drawer can be accessed
- › The GEDORE trapezoidal axle construction secures smooth running, manoeuvrability and track-trueness even in case of maximum loads
- › Large storage space with shelf and lockable door
- › Heel protection for personal safety
- › Central locking with cylinder lock, simultaneous closure of drawers and door
- › Load capacity per drawer 40 kg, bottom heavy-duty drawer 60 kg
- › GEDORE heavy-duty chassis, two roller-bearing GEDORE heavy-duty wheels (fixed castors Ø 200 mm) and two ball-bearing GEDORE smooth running wheels (swivel castors Ø 125 mm) complete with two total brakes
- › Sheet steel - welded, corrosion resistant and scratch-proof powder-coated

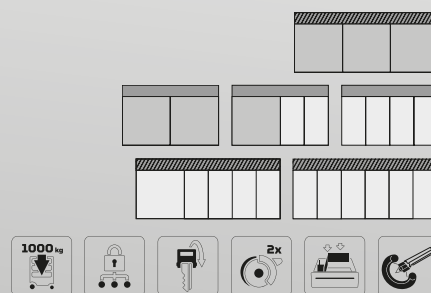

Code	No.	Length mm	Width mm	Height mm	Worktop thickness mm	Drawers	Number of drawers	Weight kg
1988468	1504 XL	550	1.250	985	30	1x Type 1, H. = 67 mm extra wide 4x Type 2, H. = 67 mm 1x Type 3, H. = 137 mm 1x Type 4, H. = 207 mm	7	124

R 1504 XL-L REAR PANEL

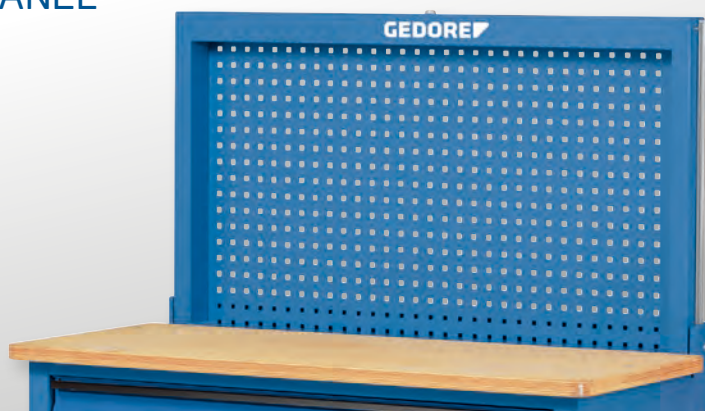

- › Can be attached to workbenches 1504 XL and 1506 XL
- › Neat arrangement of tools
- › Square perforation 10 x 38 mm for tool hooks and holders No. 1500 H

Code	No.	Length mm	Height mm	Width mm	Weight kg
2251787	R 1504 XL-L	70	640	1.190	29

1505 MOBILE WORKBENCH



- › For safer, orderly and mobile storage of tools and equipment
- › Sheet steel, corrosion resistant and scratch-proof powder-coated, GEDORE blue
- › 40 mm thick multiplex beech plywood board, surface additionally protected by linseed oil varnish
- › Large storage space with shelf and lockable door
- › Easy, safe movement with pull handle
- › Heel protection for personal safety
- › Central locking with cylinder lock, simultaneous closure of drawers and door
- › 5 wide drawers (W 480 x D 550 mm) with partial extension (505 mm), removable
- › Each drawer with safety locking, single-hand operation
- › Ball-bearing guide rails
- › Can be individually equipped with lengthwise and crosswise dividers (can be ordered individually)
- › Load capacity per drawer 40 kg
- › Total load capacity 2000 kg, 500 kg when mobile
- › 4 GEDORE rollers with roller bearings with independent wheel suspension
- › Absolutely stable standing when lowered
- › Mobile due to hydraulic raising mechanism, just lift the pull handle
- › High floor clearance
- › Can be equipped with GEDORE tool modules (1500 ES/1500 CT)
- › Rear panel no. R 1504 L can be added
- › Special colours and designs available on request
- › Delivery without tools and accessories

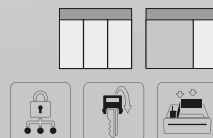

Code	No.	Length mm	Width mm	Height mm	Worktop thickness mm	Drawers	Number of drawers	Weight kg
6621780	1505	652	1.100	900	40	3x Type 1, H = 79 mm 1x Type 2, H = 160 mm 1x Type 3, H = 180 mm	5	139

MORE MOBILE WORKSPACE, MORE STORAGE SPACE!

The GEDORE 1507 XL 40200 mobile workbench was developed to meet the demand for more mobile work surface and sufficient storage space for good workplace organisation.

The extra wide rolling workbench from GEDORE is perfectly equipped with six drawers and a worktop made of 30 mm multiplex laminated beech wood. The high-performance chassis with trapezoidal axle construction guarantees optimum mobility despite maximum loads of up to 750 kg. Statically, the workbench can even be loaded up to max. 1000 kg. The central locking system allows all drawers to be locked simultaneously. The four flat and two high drawers run on ball-bearing guide rails and can be pulled out completely for a good overview. In addition, the drawers are equipped with a soft self-closing mechanism.



1

HIGH QUALITY WORKMANSHIP

- The total load capacity of 1000 kg (static) and 750 kg (dynamic) is due to the high-quality workmanship using spot welding technology, which makes the workbench above-average in terms of load capacity.

2

DOUBLE SECURITY

- The combination of a high-performance chassis and the individual pull-out lock per drawer guarantees a high degree of stability even when the workbench is loaded to the max.

3

MAXIMUM STORAGE SPACE

- A total of 6 XXL drawers with full extension offer the ideal storage space even for extensive assortments or large tools.

4

HIGH QUALITY DRAWERS

- The ball bearing guide rails ensure safe and easy running even with a maximum load of 70kg. A soft self-closing mechanism is also integrated per drawer. The full extension provides a complete view into the drawer



"The rolling workbench is a real work-horse! The robust and generous work surface can be easily supplemented with a vice and the worktop extended to the rear provides a flush finish against a wall. In combination with the XXL drawers, a dream for any workshop."

1507 XL 40200

MOBILE WORKBENCH EXTRA-WIDE DRAWERS



- > For safer, orderly and mobile storage of tools and equipment
- > 30 mm thick multiplex beech plywood board, surface additionally protected by linseed oil varnish
- > Worktop set back to park flush against the wall
- > One drawer unit in trolley width
- > With handle for easy pushing, pulling and turning
- > Side walls with Euro perforation 10 x 38 mm to fix hooks and tools
- > Ready to take up tool holder KL-5501-20 for installation of spring compressor KL-5501
- > Heel protection for personal safety
- > Central locking with cylinder lock
- > Wide drawers (W 998 x D 474 mm) fully extendable, removable
- > Individual drawer stopping stops more than one drawer being opened, one-handed operation
- > Ball-bearing guide rails
- > Load capacity per drawer 70 kg
- > Total load capacity 1000 kg, 750 kg when mobile
- > 2 GEDORE high-performance wheels with roller bearings (fixed castors Ø 200 mm), 2 GEDORE smooth-running wheels with ball bearings (swivel castors Ø 125 mm), both with total brake
- > The GEDORE trapezoidal axle construction secures smooth running, manoeuvrability and track-keeping also in case of maximum loads
- > Ideal for equipping with GEDORE tool modules (1500 ES/1500 CT) maximum 9 pieces 1/3 modules possible per drawer
- > Further drawer combinations on request
- > Special colours and designs available on request
- > Delivery without tools and accessories

Code	No.	Length mm	Width mm	Height mm	Worktop thickness mm	Drawers	Number of drawers	Weight kg
3127796	1507 XL 40200	635	1.200	985	30	4x Type 1, H = 75 mm 2x Type 3, H = 155 mm	6	136

1506 XL 2511

MOBILE WORKBENCH EXTRA WIDTH



- > For safer, orderly and mobile storage of tools and equipment
- > 30 mm thick multiplex beech wood worktop, surface additionally protected by linseed oil varnish
- > With 2 similar drawer blocks
- > Heel protection for personal safety
- > Central locking with cylinder lock per drawer unit, keyed alike
- > Wide drawers (W 480 x D 400 mm) fully extendable, removable
- > Each drawer with safety locking, single-hand operation
- > Ball-bearing guide rails
- > Can be individually equipped with lengthwise and crosswise dividers (can be ordered individually)
- > Load capacity per drawer 40 kg, bottom heavy-duty drawer 60 kg
- > Total load capacity 1000 kg, 750 kg when mobile
- > 2 GEDORE high-performance wheels with roller bearings (fixed castors Ø 200 mm), 2 GEDORE smooth-running wheels with ball bearings (swivel castors Ø 125 mm), both with total brake
- > The GEDORE trapezoidal axle construction secures smooth running, manoeuvrability and track-keeping also in case of maximum loads
- > 4 distance modules No. 1500 ED-70 K
- > Length- (LT) and crosswise (QT) dividers from zinc-plated sheet steel (can be ordered individually)
- > Can be equipped with GEDORE tool modules (1500 ES/1500 CT)
- > Rear panel R 1504 XL-L can be added
- > different locks on request
- > Further drawer combinations on request
- > Special colours and designs available on request
- > Delivery without tools and accessories



Code	No.	Length mm	Width mm	Height mm	Worktop thickness mm	Drawers	Number of drawers	Weight kg
2528088	1506 XL 2511	550	1.250	985	30	10x Type 1, H = 67 mm 2x Type 2, H = 137 mm 2x Type 3, H = 207 mm	14	141

S 1500 ES-01 MODULE ASSORTMENT SMALL

104 pieces



- › General basic assortment for beginners of all professions
- › Tools in metric sizes
- › Proven GEDORE ES tool modules in ABS plastic
- › For tool trolley No. WSL-L7 (workster) and workbench No. 1506 XL Version 2511 and 2810

6,3 1/4" 12,5 1/2"

Code	No.	Contents	Pieces	Weight kg
2319845	S 1500 ES-01	Combination wrench set in 2/3 ES-module No. 1500 ES-1 B 1/2" set of socket wrench inserts in 1/3 ES-module No. 1500 ES-19, hexagon 1/2" accessories for socket wrench inserts in 1/3 ES module No. 1500 ES-1993 U-20 1/4" socket wrench assortment in 1/3 ES module No. 1500 ES-20 Pliers assortment in 1/3 ES module No. 1500 ES-145 Chisel assortment in 1/3 ES module No. 1500 ES-350 Screwdriver set in 1/3 ES module No. 1500 ES-2150 PH	104	14,02

S 1500 ES-02 MODULE ASSORTMENT MIDDLE

207 pieces



- › Basic equipment for the commercial sector or ambitious do-it-yourselfers
- › Tools in metric sizes
- › Proven GEDORE ES tool modules in ABS plastic
- › Suitable for mounting in GEDORE tool trolley No. WSL-L7 (workster)
- › For workbench No. 1504 Variant 0701, 0810, 1000, No. 1506 XL Variant 2511 and 2810

6,3 1/4" 12,5 1/2" 8 5/16"

Code	No.	Contents	Pieces	Weight kg
2319853	S 1500 ES-02	Combination spanner set in 2/3 ES module No. 1500 ES-1 B Double open ended spanner set in 1/3 ES module No. 1500 ES-6 1/2" set of socket wrench inserts in 1/3 ES module No. 1500 ES-19 IS 1/2" set screwdriver inserts in 1/3 ES module No. 1500 ES-ITX 19 LKP 1/2" set screwdriver inserts in 1/3 ES module No. 1500 ES-IN 19 LKM 1/2" accessories for socket wrench inserts in 1/3 ES module No. 1500 ES-1993 U-20 1/4" socket wrench assortment in 1/3 ES module No. 1500 ES-20 Socket wrench set in 1/3 ES module No. 1500 ES-2133 Set of open-end wrenches with ring ratchet in 1/3 ES module No. 1500 ES-7 R Pliers assortment in 1/3 ES module No. 1500 ES-145 Chisel assortment in 1/3 ES module No. 1500 ES-350 Measuring assortment in 1/3 ES module No. 1500 ES-711 Screwdriver set in 1/3 ES module No. 1500 ES-2150 PH 1/2" ES-2150 PH Screwdriver assortment in 1/3 ES module No. 1500 ES-K 1900 Set of mounting pliers in 1/3 ES module No. 1500 ES-8000 Distance module empty No.1500 ED-70 K, 475x77x40 mm [6x].	207	28,3

S 1500 ES-03 MODULE ASSORTMENT LARGE

325 pieces

- › Extensive industrial range for professionals
- › Tools in metric sizes
- › Proven GEDORE ES tool modules in ABS plastic
- › For tool trolley no. 2005 variant 0810, no. 2004 variant 0810, 1000
- › For workbench No. 1504 Version 0810, 1000, No. 1504 XL, No. 1506 XL Version 2511, 2810, No. 1507 XL



6,3 1/4" 12,5 1/2" 6,3 1/4" 8 5/16"

Code	No.	Contents	Pieces	Weight kg
2319861	S 1500 ES-03	<p>Puller set in 1/3 ES module No. 1500 ES-1.07</p> <p>Combination wrench set in 2/3 ES-module No. 1500 ES-1 B</p> <p>1/2" set of socket wrench inserts in 1/3 ES-module No. 1500 ES-19 IS</p> <p>1/2" accessories for socket wrench inserts in 1/3 ES module No. 1500 ES-1993 U-20</p> <p>Double-end box wrench set in 1/3 ES module No. 1500 ES-2</p> <p>1/4" socket wrench assortment in 1/3 ES module No. 1500 ES-20</p> <p>1/4" socket wrench assortment in CT module No. 1500 CTD-20 BIT, Socket wrench set in 1/3 ES module No. 1500 ES-2133</p> <p>Screwdriver set in 1/3 ES module No. 1500 ES-2150 PH, Screwdriver set in 1/3 ES module No. 1500 ES-2163 TX</p> <p>Double jointed key set in 1/3 ES module No. 1500 ES-34, Chisel assortment in 1/3 ES module No. 1500 ES-350</p> <p>Double ended ring wrench set in 1/3 ES module No. 1500 ES-400, open</p> <p>Double open ended wrench set in 1/3 ES-module No. 1500 ES-6</p> <p>Set of open-end wrenches with ring ratchet in 1/3 ES-module No. 1500 ES-7 R, Measuring assortment in 1/3 ES module No. 1500 ES-711</p> <p>Set of mounting pliers in 1/3 ES module No. 1500 ES-8000, Offset screwdriver set in 2/3 ES module No. 1500 ES-DT 2142</p> <p>1/2" set of screwdriver inserts in 1/3 ES module No. 1500 ES-IN 19 LKM</p> <p>1/2" set of screwdriver inserts in 1/3 ES module No. 1500 ES-ITX 19 LKP</p> <p>1/2" screwdriver assortment in 1/3 ES module No. 1500 ES-K 1900, VDE pliers assortment in 1/3 ES module, No. 1500 ES-VDE 145</p> <p>VDE Screwdriver set in 1/3 ES module No. 1500 ES-VDE 2170 PZ, Screw extractor set No. 8551-55, M3-M18</p> <p>Offset screwdriver set No. H 42 KEL-88, SW 2 2.5 3 4 5 6 8 10 mm, ball head</p> <p>Offset screwdriver set No. H 43 KTX-07, SW TX T10 T15 T20 T25 T27 T30 T40</p> <p>Warding file set No. 8728 Flat file, triangular, square, half-round, round file</p> <p>Adjustable open-end wrench No. 60 P 810" Grip Pliers No. 137 10, Voltage Detector No. 4615 3, 220-250 V, 3mm</p> <p>Cable knife No. 0513-09, 195 mm, 1/2" fast turntable No. 1940, Distance module empty No. 1500 ED-70 K, 475x77x40 mm [7x].</p>	325	38

TS-147 TOOL ASSORTMENT IN CHECK-TOOL-MODULES

147 pieces

- › Tools in metric sizes
- › GEDORE Check-Tool-System: 2-colour foam insert to check that the set is complete
- › Each tool is securely held in its own pocket, grip recesses facilitate removal of the tools
- › Resistant to oils and greases

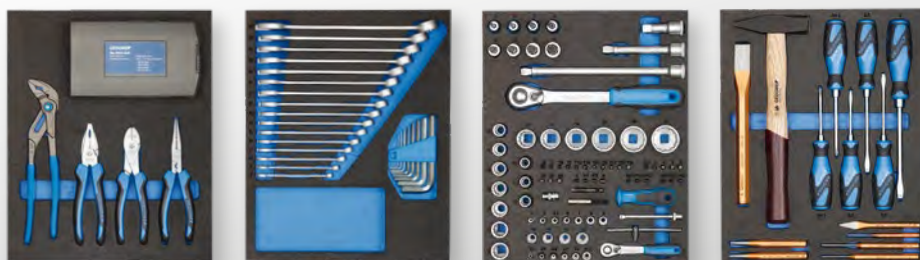

1/4" 1/2"

Code	No.	Contents	Length mm	Pieces	Weight kg
2955997	TS-147	<p>1/4"+1/2" socket range in CT module no. TS CT2-D19-D20, 81 pieces</p> <p>Combination spanner set in CT module no. TS CT2-7, 24 pieces</p> <p>Tool assortment in CT module no. TS CT2-2154SK-119, 14 pieces</p> <p>Pliers range in CT module no. TS CT2-142, 28 pieces</p>	120	147	11,98

TS-190

TOOL ASSORTMENT

in Check-Tool-Modules, 190 parts

- › Tools in metric sizes
- › GEDORE Check-Tool-System: 2-colour foam insert to check that the set is complete
- › Each tool is securely held in its own pocket, grip recesses facilitate removal of the tools
- › Resistant to oil and grease

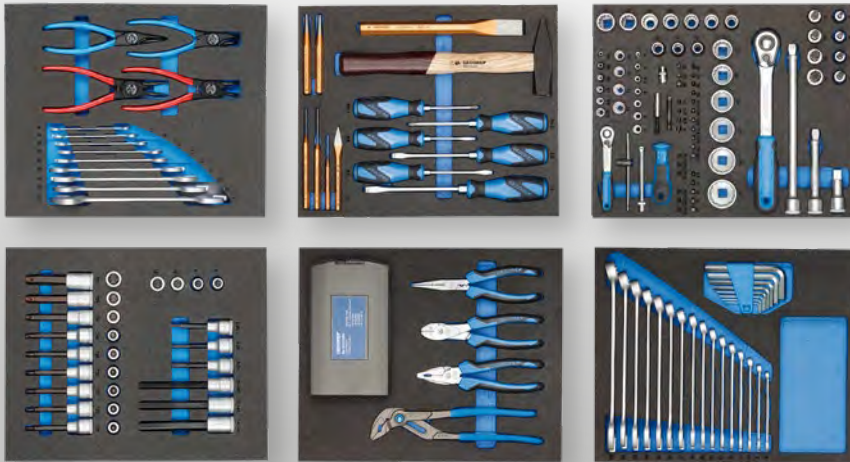

1/4" 1/2"

Code	No.	Contents	Length mm	Pieces	Weight kg
2956527	TS-190	1/4"+1/2" socket range in CT module no. TS CT2-D19-D20, 81 pieces Combination spanner set in CT module no. TS CT2-7, 24 pieces Tool assortment in CT module no. TS CT2-2154SK-119, 14 pieces Pliers range in CT module no. TS CT2-142, 28 pieces Tool assortment in 2/4 CT module no. TS CT2-6-8000, 15 pcs. 1/2" set screwdriver bits in 2/4 CT module no. TS CT2-ITX19, 28 pcs.	120	190	17,08

TS-308

TOOL ASSORTMENT

in Check-Tool-Modules, 308 parts

- › Tools in metric sizes
- › GEDORE Check-Tool-System: 2-colour foam insert to check that the set is complete
- › Each tool is securely held in its own pocket, grip recesses facilitate removal of the tools
- › Resistant to oils and greases

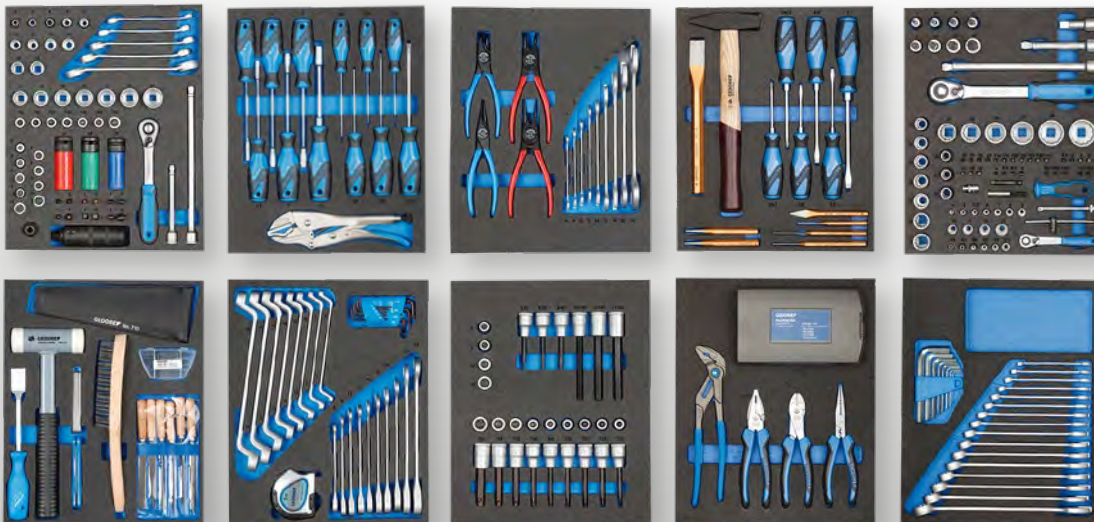

1/4" 1/2"

Code	No.	Contents	Length mm	Pieces	Weight kg
2956535	TS-308	1/4" 1/2" socket wrench assortment in CT module No. TS CT2-D19-D20, 81 pcs Combination spanner set in CT module No. TS CT2-7, 24 pcs Tool assortment in CT module No. TS CT2-2154SK-119, 14 pcs. Pliers assortment in CT module No. TS CT2-142, 28 pcs. Tool assortment in 2/4 CT module No. TS CT2-6-8000, 15 pcs 1/2" set of screwdriver sockets in 2/4 CT module No. TS CT2-ITX19, 28 pcs Tool assortment in 2/4 CT module No. TS CT2-2133-2163TX, 13 pcs Wrench set in 2/4 CT module No. TS CT2-7R-2, 28 pcs Tool assortment in 2/4 CT module No. TS CT2-D30, 59 pcs Tool assortment in 2/4 CT module No. TS CT2-710, 17 pcs Hacksaw No. 407	120	308	30,14

1500 CT1-2150 PH SCREWDRIVER SET

in 1/3 check tool module, 6-part

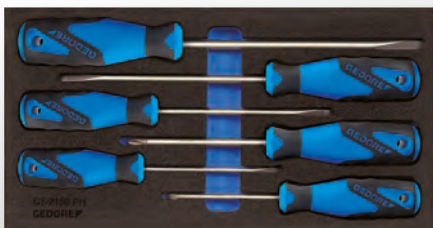

- › Perfect set composition for slotted and cross-head screws PH
- › With check tool insert for quick detection of missing tools
- › Particularly suitable for work in sensitive areas, where it must be ensured that no tools are left behind
- › blue underlay, black top layer, blue indicates missing tool
- › Recessed grips facilitate the removal of the tool



Code	No.	Contents	Length mm	Width mm	Pieces	Weight kg
2309130	1500 CT1-2150 PH	3C-Screwdriver slot No. 2150 4 5.5 6.5 83 C-Screwdriver Cross-recess No. 2160 PH 1 2	310	158	6	0,63

1500 CT1-2150 PZ SCREWDRIVER SET

in 1/3 check tool module, 6-part



- › Perfect set composition for slotted and cross-head screws PZ
- › With Check-Tool insert for quick check of tool completeness
- › Particularly suitable for work in sensitive areas, where it must be ensured that no tools are left behind
- › blue underlay, black top layer, blue indicates missing tool
- › Recessed grips facilitate the removal of the tool



Code	No.	Contents	Length mm	Width mm	Pieces	Weight kg
2309149	1500 CT1-2150 PZ	3C-Screwdriver slot No. 2150 4 5.5 6.5 8 3C-Screwdriver Cross-recess No. 2160 PZ 1 2	310	158	6	0,63

1500 CT1-2163 TX SCREWDRIVER SET

in 1/3 check tool module, 6-part

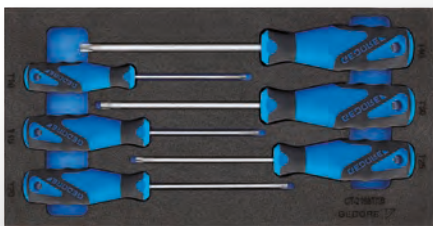

- › Perfect set composition for inside TX screws
- › With check tool insert for quick detection of missing tools
- › Particularly suitable for work in sensitive areas, where it must be ensured that no tools are left behind
- › blue underlay, black top layer, blue indicates missing tool
- › Recessed grips facilitate the removal of the tool



Code	No.	Contents	Length mm	Width mm	Pieces	Weight kg
2309157	1500 CT1-2163 TX	T8 T10 T15 T20 T25 T30	310	158	6	0,4

1500 CT1-2163 TXB SCREWDRIVER SET

in 1/3 check tool module, 6-part

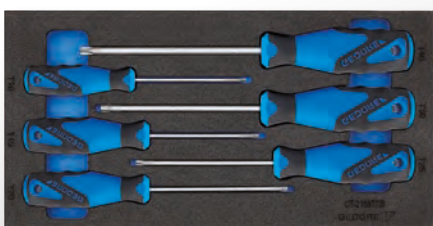

- › Perfect set composition for inside TX screws with pin
- › With check tool insert for quick detection of missing tools
- › Particularly suitable for work in sensitive areas, where it must be ensured that no tools are left behind
- › blue underlay, black top layer, blue indicates missing tool
- › Recessed grips facilitate the removal of the tool



Code	No.	Contents	Length mm	Width mm	Pieces	Weight kg
2309165	1500 CT1-2163 TXB	T10 T15 T20 T25 T30 T40	310	158	6	0,5

1500 CT1-VDE 2170 PZ VDE SCREWDRIVER SET

in 1/3 check tool module, 6-part

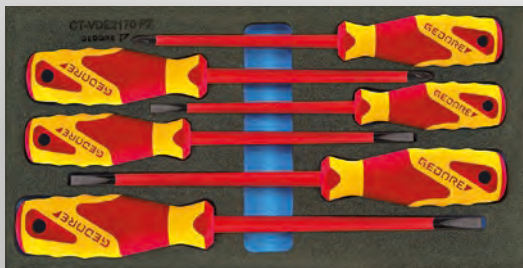

- › Perfect set composition for slotted and cross-head screws PZ in the electronics sector
- › With check tool insert for quick detection of missing tools
- › Particularly suitable for work in sensitive areas, where it must be ensured that no tools are left behind
- › blue underlay, black top layer, blue indicates missing tool
- › Recessed grips facilitate the removal of the tool

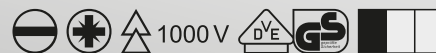

Code	No.	Contents
2309173	1500 CT1-VDE 2170 PZ	VDE Screwdriver slotted no. VDE 2170 4 5.5 6.5 8 VDE Screwdriver cross recess No. VDE 2160 PZ 1 2

Length mm	Width mm	Pieces	Weight kg
310	158	6	0,625

1500 CT1-2133 SOCKET SET

in 1/3 check tool module, 6-part



- › Perfect set composition for easy and quick loosening of screws with hexagonal head and nuts
- › With check tool insert for quick detection of missing tools
- › Particularly suitable for work in sensitive areas, where it must be ensured that no tools are left behind
- › blue underlay, black top layer, blue indicates missing tool
- › Recessed grips facilitate the removal of the tool



Code	No.	Contents
2309122	1500 CT1-2133	Socket wrench with 3C handle No. 2133, SW 5.5 6 7 8 9 10 mm

Length mm	Width mm	Pieces	Weight kg
310	158	6	0,82

1500 CT2-DT 2142 HEXAGON ALLEN KEY SET

9 pieces

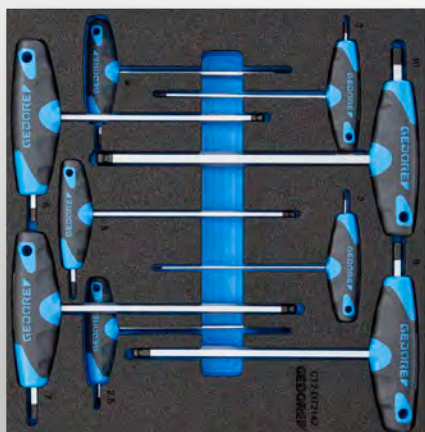

- › Perfect set composition for hexagon socket screws
- › With check tool insert for quick detection of missing tools
- › Particularly suitable for work in sensitive areas, where it must be ensured that no tools are left behind
- › blue underlay, black top layer, blue indicates missing tool
- › Recessed grips facilitate the removal of the tool



Code	No.	Contents
2309009	1500 CT2-DT 2142	Offset screwdriver with 2CT-handle No. DT 2142, SW 2.2 5 3 4 5 6 7 8 10 mm

Length mm	Width mm	Pieces	Weight kg
310	315	9	0,9

1500 CT1-142 PLIERS SET

in 1/3 Check-Tool module, 4-part



- › Practical set composition for a wide range of applications in all trades
- › With check tool insert for quick detection of missing tools
- › Particularly suitable for work in sensitive areas, where it must be ensured that no tools are left behind
- › blue underlay, black top layer, blue indicates missing tool
- › Recessed grips facilitate the removal of the tool



Code	No.	Contents	Length mm	Width mm	Pieces	Weight kg
2309025	1500 CT1-142	Universal Pliers No. 142 10 JC Power combination pliers No. 8250-180 JC Flat-nose pliers No. 8132-160 JC Power side cutter No. 8316-160 JC	310	158	4	1,217

1500 CT1-8000 SET OF CIRCLIP PLIERS

in 1/3 Check-Tool module, 4-part

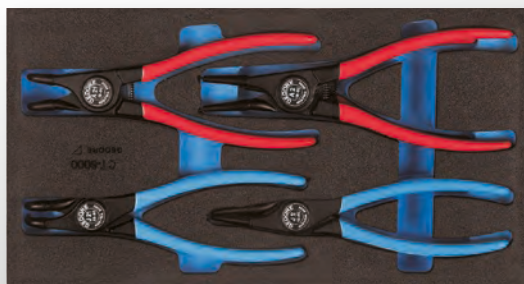

- › Perfect set composition for internal and external retaining rings
- › With check tool insert for quick detection of missing tools
- › Particularly suitable for work in sensitive areas, where it must be ensured that no tools are left behind
- › blue underlay, black top layer, blue indicates missing tool
- › Recessed grips facilitate the removal of the tool



Code	No.	Contents	Length mm	Width mm	Pieces	Weight kg
2309181	1500 CT1-8000	Circlip pliers for external retaining rings No. 8000 A 1 A 2 A 21 Circlip pliers for internal retaining rings No. 8000 J 1 J 2 J 21	310	158	4	1,009

1500 CT1-VDE 142 VDE PLIERS SET

in 1/3 Check-Tool module, 4-part



- › Practical set composition for a wide range of applications in the electronics sector
- › With Check-Tool insert for quick check of tool completeness
- › Particularly suitable for work in sensitive areas, where it must be ensured that no tools are left behind
- › blue underlay, black top layer, blue indicates missing tool
- › Recessed grips facilitate the removal of the tool



Code	No.	Contents	Length mm	Width mm	Pieces	Weight kg
2309033	1500 CT1-VDE 142	Universal Pliers No. 142 10 C, 10" VDE Power combination pliers No. VDE 8250-180 H VDE Flat-nosed Pliers No. VDE 8132-160 H VDE Side cutter No. VDE 8314-160 H	310	158	4	1,158

1500 CT1-20

SOCKET SET 1/4"

in 1/3 check tool module, 37 parts



- > Extensive range of accessories for the most common screw applications
- > With Check-Tool insert for quick check of tool completeness
- > Particularly suitable for work in sensitive areas, where it must be ensured that no tools are left behind
- > blue underlay, black top layer, blue indicates missing tool
- > Recessed grips facilitate the removal of the tool

Code	No.	Contents	Length mm	Width mm	Pieces	Weight kg
2308967	1500 CT1-20	1/4" socket No.20 hex AF 4 5 5.5 6 7 8 9 10 11 12 13 14 mm 1/4" screwdriver bit socket No. IN 20 hex AF 3 4 5 6 8 mm 1/4" screwdriver bit socket No. ITX 20, AF T8 T9 T10 T15 T20 T25 T27 T30 T40 mm 1/4" socket No. TX 20, E4 E5 E6 E7 E8 E10 1/4" sliding T-bar with slider No. 2087, 115 mm 1/4" extension No. 2090-4. 97 mm, 1/4" universal joint No. 2095 1/4" square plug-in handle No. 2098, 2C handle, 1/4" reversible ratchet U-10, 127 mm	310	158	37	0,845

1500 CT1-30

SOCKET SET 3/8"

in 1/3 check tool module, 24-piece



- > Perfect set composition for the most common screw applications
- > With check tool insert for quick detection of missing tools
- > Particularly suitable for work in sensitive areas, where it must be ensured that no tools are left behind
- > blue underlay, black top layer, blue indicates missing tool
- > Recessed grips facilitate the removal of the tool

Code	No.	Contents	Length mm	Width mm	Pieces	Weight kg
2308975	1500 CT1-30	3/8" socket hex No. 30, AF 6 7 8 9 10 11 12 13 14 15 16 17 18 19 3/8" screwdriver bit socket hex, No. IN 30, AF 4 5 6 8 10 mm 3/8" universal joint No. 3095, 51 mm 3/8" sliding T-bar No. 3087 3/8" extension No. 3090 -5 -10, 125 250 mm, 3/8" reversible ratchet No. 3093 U-10, 200 mm	310	158	24	1,67

1500 CT1-19

SOCKET SET 1/2", HEXAGON

in 1/3 check tool module, 26 parts



- > Thanks to low manufacturing tolerances, the socket wrench insert ensures perfect power transmission for all screwing operations
- > With Check-Tool insert for quick check of tool completeness
- > Particularly suitable for work in sensitive areas, where it must be ensured that no tools are left behind
- > blue underlay, black top layer, blue indicates missing tool
- > Recessed grips facilitate the removal of the tool

Code	No.	Contents	Length mm	Width mm	Pieces	Weight kg
2308908	1500 CT1-19	Socket wrench insert No. 19, SW 10 11 12 13 14 15 16 17 18 19 21 22 23 24 26 27 28 30 32 mm Screwdriver bit insert No. IN 19, SW 6 7 8 9 10 12 14 mm	310	158	26	2,79

1500 CT1-ITX 30 SCREWDRIVER BIT SOCKET SET 3/8"

in 1/3 check tool module, 39-piece



- › Perfect set composition for inside TX screws
- › With check tool insert for quick detection of missing tools
- › Particularly suitable for work in sensitive areas, where it must be ensured that no tools are left behind
- › blue underlay, black top layer, blue indicates missing tool
- › Recessed grips facilitate the removal of the tool

Code	No.	Contents	Length mm	Width mm	Pieces	Weight kg
2308983	1500 CT1-ITX 30	Socket wrench insert 3/8" No. TX 30 E5 E6 E7 E8 E10 E11 E12 E14 Screwdriver bit socket 3/8" No. IN 30 L, hexagon SW 4 5 6 7 8 10 mm Screwdriver bit socket 3/8" No. ITX 30 T20 T25 T27 T30 T40 T45 T50 Screwdriver bit socket 3/8" No. ITX 30 L T20 T25 T27 T30 T40 T45 T50 Screwdriver bit socket 3/8" slot No. IS 30, SW 5.5 6.5 8 10 12 mm Screwdriver bit socket 3/8" No. IKS 30 1 2 3 Screwdriver bit socket 3/8" No. IKS 30 PZD 1 2 3	310	158	39	2,175

1500 CT1-1993 T ACCESSORIES FOR SOCKET WRENCHES 1/2"

in 1/3 Check-Tool module, 5-part



- › Perfect set composition for the manual loosening and tightening of screws and nuts
- › With Check-Tool insert for quick check of tool completeness
- › Particularly suitable for work in sensitive areas, where it must be ensured that no tools are left behind
- › blue underlay, black top layer, blue indicates missing tool
- › Recessed grips facilitate the removal of the tool

Code	No.	Contents	Length mm	Width mm	Pieces	Weight kg
2309106	1500 CT1-1993 T	1/2" reversible ratchet No. 1993 U-10 T, 1/2" sliding T-bar No.1987, 292 mm 1/2" universal joint No. 1995, 1/2" extension No. 1990, 125 250 mm	310	158	5	1,765

1500 CT1-D 19 SOCKET SET 1/2", UD-PROFILE

in 1/3 check tool module, 26 parts

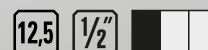
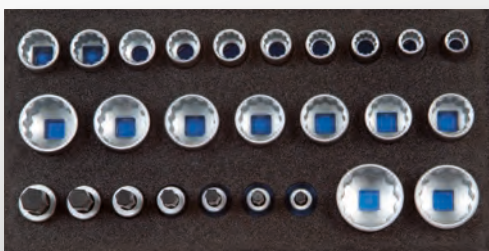

- › Perfect set composition for manually operated screwdriving
- › With Check-Tool insert for quick check of tool completeness
- › Particularly suitable for work in sensitive areas, where it must be ensured that no tools are left behind
- › blue underlay, black top layer, blue indicates missing tool

Code	No.	Contents	Length mm	Width mm	Pieces	Weight kg
2308916	1500 CT1-D 19	Socket wrench insert 1/2" UD profile No. D 19 10 11 12 13 14 15 16 17 18 19 21 22 23 24 26 27 28 30 32 Screwdriver bit socket 1/2" hexagon socket No. IN 19 6 7 8 9 10 12 14	310	158	26	2,68

1500 CT1-IN 19 LKM SCREWDRIVER BIT SOCKET SET 1/2"

in 1/3 Check-Tool module, 15 parts

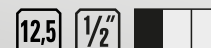

- > Perfect set composition for hexagon socket screws
- > With Check-Tool insert for quick check of tool completeness
- > Particularly suitable for work in sensitive areas, where it must be ensured that no tools are left behind
- > blue underlay, black top layer, blue indicates missing tool

Code	No.	Contents	Length mm	Width mm	Pieces	Weight kg
2308932	1500 CT1-IN 19 LKM	Screwdriver bit socket 1/2" No. IN 19 6 7 8 10 12 14 Screwdriver bit socket 1/2" No. IN 19 L 6-140 7-140 8-140 9-140 10-140 12-140 14-140	310	158	15	1,9

1500 CT1-ITX 19 LKP SCREWDRIVER BIT SOCKET SET 1/2"

in 1/3 check tool module, 19-piece

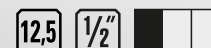

- > Perfect set composition for inside TX screws
- > With check tool insert for quick detection of missing tools
- > Particularly suitable for work in sensitive areas, where it must be ensured that no tools are left behind
- > blue underlay, black top layer, blue indicates missing tool
- > Recessed grips facilitate the removal of the tool

Code	No.	Contents	Length mm	Width mm	Pieces	Weight kg
2308940	1500 CT1-ITX 19 LKP	Screwdriver bit socket 1/2" No. ITX 19 T20 T25 T27 T30 T40 T45 T50 T55 T60 Screwdriver bit socket 1/2" No. ITX 19 L T20-100 T25-100 T27-100 T30-100 T40-100 T45-100 T50-100 T55-100 T60-100 TX Screw Gauge No. 708	310	158	19	1,915

1500 CT2-7 COMBINATION SPANNER SET

in 2/3 Check-Tool module, 25 parts

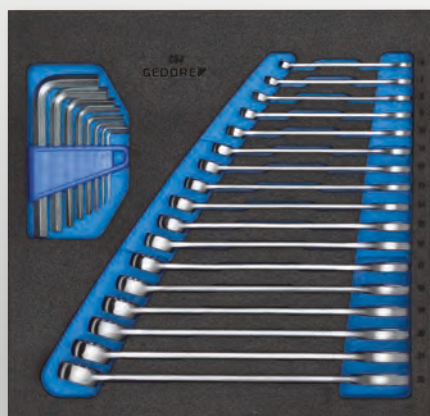

- > Perfect set composition for universal use
- > With Check-Tool insert for quick check of tool completeness
- > Particularly suitable for work in sensitive areas, where it must be ensured that no tools are left behind
- > blue underlay, black top layer, blue indicates missing tool
- > Recessed grips facilitate the removal of the tool

Code	No.	Contents	Length mm	Width mm	Pieces	Weight kg
2308878	1500 CT2-7	Combination wrench No. 7 6 7 8 9 10 11 12 13 14 15 16 17 18 19 20 21 22 Offset screwdriver set No. PH 42-88	310	315	25	1,75

1500 CT2-7-32 COMBINATION SPANNER SET

in 2/3 Check-Tool module, 5-part



- › Perfect set composition for universal use
- › With check tool insert for quick detection of missing tools
- › Particularly suitable for work in sensitive areas, where it must be ensured that no tools are left behind
- › blue underlay, black top layer, blue indicates missing tool
- › Recessed grips facilitate the removal of the tool



Code	No.	Contents	Length mm	Width mm	Pieces	Weight kg
2308886	1500 CT2-7-32	23 24 27 30 32 mm	310	315	5	1,865

1500 CT1-2 DOUBLE ENDED RING SPANNER SET

in 1/3 Check-Tool module, 8 parts

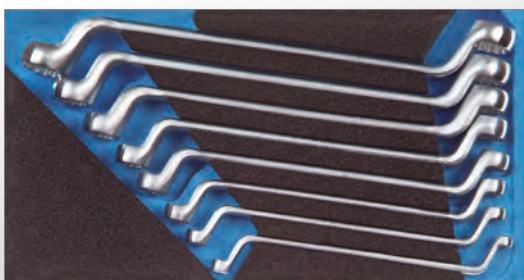

- › Practical set composition for extremely deep-set or recessed nuts
- › With Check-Tool insert for quick check of tool completeness
- › Particularly suitable for work in sensitive areas, where it must be ensured that no tools are left behind
- › blue underlay, black top layer, blue indicates missing tool



Code	No.	Contents	Length mm	Width mm	Pieces	Weight kg
2308827	1500 CT1-2	6x7 8x9 10x11 12x13 14x15 16x17 18x19 20x22 mm	310	158	8	1,36

1500 CT1-6 DOUBLE OPEN ENDED SPANNER SET

in 1/3 Check-Tool module, 10 parts

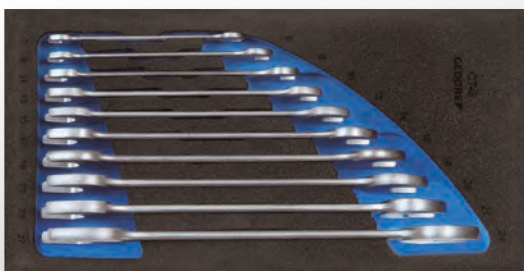

- › Perfect set composition for the application on screws and nuts
- › With Check-Tool insert for quick check of tool completeness
- › Particularly suitable for work in sensitive areas, where it must be ensured that no tools are left behind
- › blue underlay, black top layer, blue indicates missing tool



Code	No.	Contents	Length mm	Width mm	Pieces	Weight kg
2308851	1500 CT1-6	6x7 8x9 10x11 12x13 14x15 16x17 18x19 20x22 21x23 24x27 mm	310	158	10	1,44

1500 CT1-7 R COMBINATION RATCHET SPANNER SET

in 1/3 Check-Tool module, 10 parts

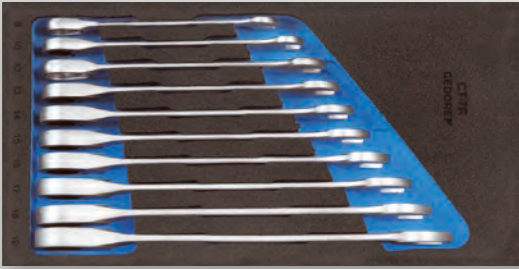

- > Perfect set composition for ratcheting release and quick tightening
- > With Check-Tool insert for quick check of tool completeness
- > Particularly suitable for work in sensitive areas, where it must be ensured that no tools are left behind
- > blue underlay, black top layer, blue indicates missing tool

Code	No.	Contents	Length mm	Width mm	Pieces	Weight kg
2308894	1500 CT1-7 R	8 10 12 13 14 15 16 17 18 19 mm	310	158	10	1,24

1500 CT1-7 UR COMBINATION RATCHET SPANNER SET, REVERSIBLE

in 1/3 Check-Tool module, 10 parts

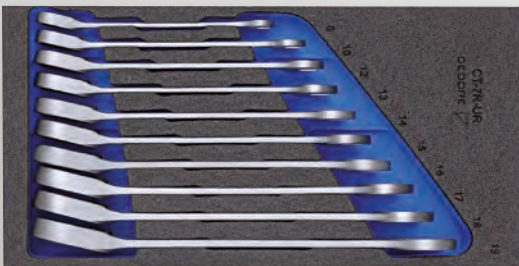

- > Perfect set composition for ratcheting release and quick tightening
- > clockwise and counterclockwise rotation possible by means of change-over lever
- > With Check-Tool insert for quick check of tool completeness
- > Particularly suitable for work in sensitive areas, where it must be ensured that no tools are left behind
- > blue underlay, black top layer, blue indicates missing tool
- > Recessed grips facilitate the removal of the tool

Code	No.	Contents	Length mm	Width mm	Pieces	Weight kg
2309199	1500 CT1-7 UR	8 10 12 13 14 15 16 17 18 19 mm	310	158	10	1,245

1500 CT1-400 DOUBLE ENDED RING SPANNER SET, OPEN

in 1/3 Check-Tool module, 5-part



- > Perfect kit composition for the assembly of pipe fittings
- > With Check-Tool insert for quick check of tool completeness
- > Particularly suitable for work in sensitive areas, where it must be ensured that no tools are left behind
- > blue underlay, black top layer, blue indicates missing tool
- > Recessed grips facilitate the removal of the tool

Code	No.	Contents	Length mm	Width mm	Pieces	Weight kg
2309068	1500 CT1-400	8x10 10x11 12x14 13x15 17x19 mm	310	158	5	0,565

1500 CT1-350 CHISEL SET

in 1/3 Check-Tool module, 8 parts



- › Perfect set composition for the most common stroke applications
- › With check tool insert for quick detection of missing tools
- › Particularly suitable for work in sensitive areas, where it must be ensured that no tools are left behind
- › blue underlay, black top layer, blue indicates missing tool
- › Recessed grips facilitate the removal of the tool



Code	No.	Contents	Length mm	Width mm	Pieces	Weight kg
2309041	1500 CT1-350	Flat Chisel No. 97-250, Cross Chisel No. 98-125 Driver No. 99 12-5 12-8, Grains No. 100-12 Pin punch No. 119-1.5 3 4 Engineer's hammer ROTBAND-PLUS No.600 H-300	310	158	8	1,425

1500 CTD-20 BIT SOCKET ASSORTMENT 1/4"

in CT module, 45 parts



- › Only suitable for tool trolley 2004, and workbenches 1502, 1504, 1505 and 1506 XL
- › For models No. 2005, No. WSL-L7 (workster), No. 2430 and No. 1504 XL order additional distance module No. 1500 ED-70 S



Code	No.	Contents	Length mm	Width mm	Depth mm	Pieces	Weight kg
1733419	1500 CTD-20 BIT	1/4" socket wrench insert No. 20 L, SW 4 4.5 5 6 7 8 9 10 12 13 mm 1/4" screwdriver bit No. 680, SW 4 5.5 6.5 8 mm 1/4" screwdriver bit No. 685, SW 2.5 3 4 5 6 mm 1/4" screwdriver bit No. 685 X 5 6 8 mm 1/4" screwdriver bit No. 687 TX T6 T7 T8 T9 T10 T15 T20 T25 T27 T30 T40 1/4" screwdriver bit No. 690 1 2 3 1/4" screwdriver bit No. 690 PZD 1 2 3 Miniature LED light No.649, Insert holder No. 673 6,3 Bit holder No. 699 1/4" bit adapter No. 620, Multi-handle No. 676, Combination holding tool No. 639	77	475	40	45	0,7

2005 CT3-32 SOCKET ASSORTMENT 3/4"

in 3/4 check tool module, 14-piece



- › Perfect set combination for manually operated sockets and square drive connectors
- › With check tool insert for quick detection of missing tools
- › Particularly suitable for work in sensitive areas, where it must be ensured that no tools are left behind
- › blue underlay, black top layer, blue indicates missing tool
- › Recessed grips facilitate the removal of the tool



Code	No.	Contents	Length mm	Width mm	Pieces	Weight kg
2752727	2005 CT3-32	Socket wrench insert 3/4" hexagon UD profile No. 32 22 24 27 30 32 36 38 41 46 50 Extension 3/4" No. 3290-8 -16, Reversible ratchet 3/4" No. 3293 U-2 Cross handle 3/4" No. 3287	390	472	14	9

2005 CT4-7 XL COMBINATION SPANNER SET

in 4/4 check tool module, 18-piece

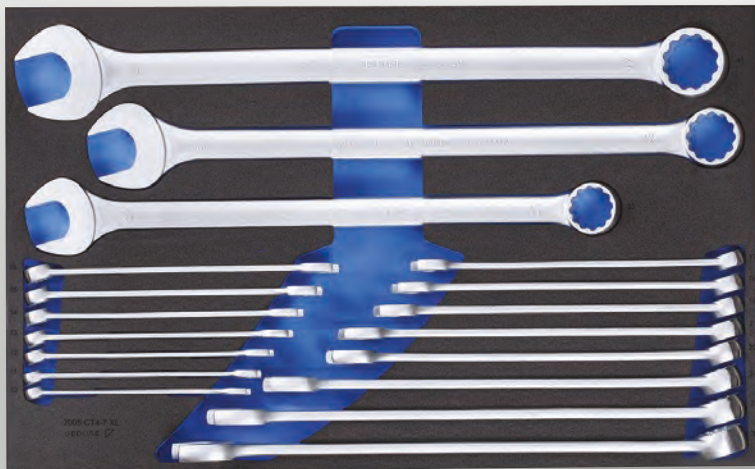

- › Perfect set composition for gentle screw actuation
- › Combination wrench extra long for more torque
- › With check tool insert for quick detection of missing tools
- › Particularly suitable for work in sensitive areas, where it must be ensured that no tools are left behind
- › blue underlay, black top layer, blue indicates missing tool
- › Recessed grips facilitate the removal of the tool



Code	No.	Contents	Length mm	Width mm	Pieces	Weight kg
2704226	2005 CT4-7 XL	10 11 12 13 14 15 16 17 18 19 21 22 24 27 30 32 36 41 mm	390	633	18	8,15

2005 CT4-8000 TOOL ASSORTMENT

in 4/4 check tool module, 13-piece



- › Perfect set composition for universal use
- › With check tool insert for quick detection of missing tools
- › Particularly suitable for work in sensitive areas, where it must be ensured that no tools are left behind
- › blue underlay, black top layer, blue indicates missing tool
- › Recessed grips facilitate the removal of the tool



Code	No.	Contents	Length mm	Width mm	Pieces	Weight kg
2016303	2005 CT4-8000	Engineers' hammer ROTBAND-PLUS No. 600 H-300 -500 Recoilless hammer No. 248 ST-40 Universal pliers No. 142 10 JC Bent nose pliers No. 8132-160 JC Power side cutter No. 8316-160 JC Power combination pliers No. 8250-180 JC Circlip pliers for external retaining rings No. 8000 A 1 2 21 Circlip pliers for internal retaining rings No. 8000 J 1 2 21	390	633	13	4,1

2005 CT4-U-20
SOCKET SET 1/4"-3/8"-1/2"
 in 4/4 check tool module, 91-piece

- › Perfect set composition for universal screw applications
- › With check tool insert for quick detection of missing tools
- › Particularly suitable for work in sensitive areas, where it must be ensured that no tools are left behind
- › blue underlay, black top layer, blue indicates missing tool
- › Recessed grips facilitate the removal of the tool

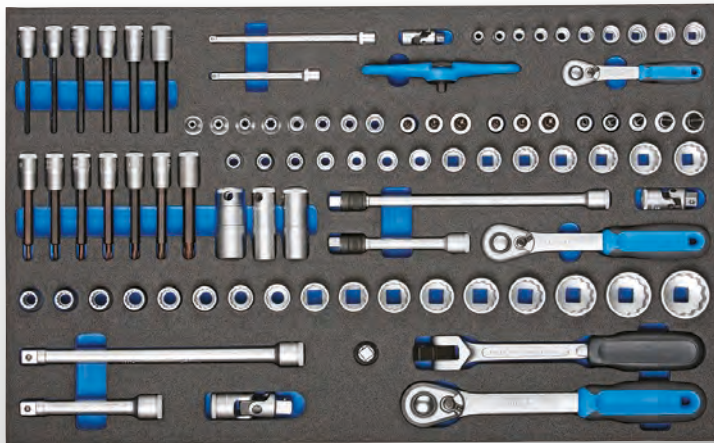

6,3 1/4" 10 3/8" 12,5 1/2"

Code	No.	Contents	Length mm	Width mm	Pieces	Weight kg
2016257	2005 CT4-U-20	1/4" socket wrench insert No. 20, SW 5.5 6 7 8 9 10 11 12 13 14 mm 1/4" reversible ratchet No. 2093 U-20 1/4" cross-handle ratchet No. 2093 U-3 T 1/4" extension No. 2090-4-6, 97 148 mm, 1/4" universal joint No. 20953/8" socket wrench insert No. D 30, SW 8 9 10 11 12 13 14 15 16 17 18 19 21 22 mm 3/8" screwdriver bit socket No. IN 30 L, SW 4 5 6 7 8 10 3/8" screwdriver bit insert No. ITX 30 L, T20 T25 T27 T30 T40 T45 T50 3/8" socket wrench insert No. TX 30, E5 E6 E7 E8 E10 E11 E12 E14 3/8" screwdriver bit socket No. IKS 30, 1 2 3 3/8" screwdriver bit socket No. IKS 30 PZD 1 2 3 3/8" screwdriver bit insert No. IS 30, SW 5.5 6.5 8 10 12 mm 3/8" spark plug insert with retaining spring 20.8 mm 3/8" spark plug insert with retaining spring 16 mm, 3/8" spark plug insert with retention spring 18 mm 3/8" reversible ratchet No. 3093 U-20, 3/8" extension with release no. 3090 A-5 -10 3/8" universal joint No. 3095, 1/2" socket wrench insert No. D 19, SW 10 11 12 13 14 15 16 17 18 19 21 22 23 24 27 30 32 mm, 1/2" reversible ratchet 1/2" No. 1993 U-20 1/2" extension 1/2" No. 1990-5 -10, 125 250 mm, 1/2" reducer 1/2" to 3/8" No. 1930 1/2" universal joint 1/2" No. 1995, 1/2" articulated handle No. 1996, 255 mm	390	633	91	7,64

1500 ED-70 K
DISTANCE MODULE
 empty

- › For balancing and fixing tool modules No. 1500 ES in drawers of depth 400 mm, for tool trolleys No. 2004 and workbenches No. 1502, 1504, 1505 and 1506 XL
- › Made of impact-resistant ABS plastic, black grained



Code	No.	Width mm	Depth mm	Height mm	Weight kg
1618687	1500 ED-70 K	475	77	40	0,12

1500 ED-70 S
DISTANCE MODULE 1/3
 empty

- › For tool trolley No. WSL-L7 (workster) and No. 2005, workbench No. 1504 XL and tool chest No. 2430, suitable as spacer for 1/3 module
- › Module in sheet steel



Code	No.	Width mm	Depth mm	Height mm	Weight kg
1851462	1500 ED-70 S	152	77	40	0,15

1500 ED-70 XL
DISTANCE MODULE EMPTY
 empty

- > Suitable to take torque wrenches and other long hand tools or small pieces
- > For tool trolley No. WSL-L7 (workster) and No. 2005, workbench No. 1504 XL and tool chest No. 2430
- > Module in sheet steel



Code	No.	Width mm	Depth mm	Height mm	Weight kg
1803069	1500 ED-70 XL	625	77	40	0,854

1500 ED-230 CT
DISTANCE MODULE
 empty

- > Spacer insert - suitable for tool trolleys and workbenches
- > Distance module made of two-coloured foam

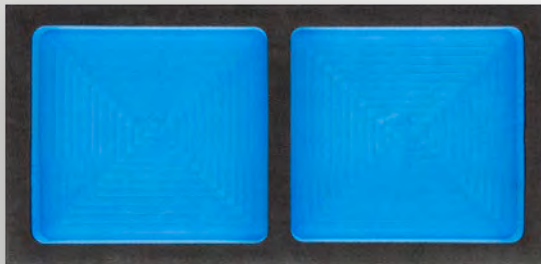

Code	No.	Width mm	Depth mm	Height mm	Weight kg
3036650	1500 ED-230 CT	475	230	35	0,055

WK 1041 L
TOOL CASE LARGE
 empty

- > Robust aluminium frame with bumper protection, shells made of impact-resistant ABS plastic
- > The opened case lid is protected against unintentional closing by the safety lid holder
- > A4 document compartment in the lid
- > Variably divisible bottom tray
- > Lockable with 2 tilting cylinder locks and one combination lock
- > Removable tool board with 22 tool pockets on the front and back in the lid
- > Removable cover plate for bottom tray with 15 tool pockets
- > Hand friendly carrying handle



Code	No.	Length mm	Height mm	Width mm	max. load capacity kg	Weight kg
3065405	WK 1041 L	395	185	490	30	4,9

1041-001 TOOL ASSORTMENT BASIC IN CASE

74 pieces



- Basic equipment for all trades
- A practical assortment for on-site use
- Packed in a strong plastic case made from impact-proof ABS
- Sturdy aluminium frame
- Robust companion - whenever the right tools have always to be at hand



Code	No.	Contents	Length mm	Width mm	Depth mm	Pieces	Weight kg
3082121	1041-001	Combination wrench No. 7, SW 10 13 17 19 22 mm Bit socket wrench box No. 666-U-20, with ratchet 1/4" 35 pcs. Offset screwdriver No. 42, SW 2 2.5 3 4 5 6 8 10 mm, in holder Adjustable open-end wrench No. 60 P 8, 3C-Screwdriver slot No. 2150, 3 4 5.5 6.5 8 mm 3C-Screwdriver Cross-recess No. 2160, PH 0 1 2 Non-return soft-face and engineer's hammer KOMBI-PLUS R No. 247 H-30, head D.30 mm Pocket Caliper No. 710, Steel tape measure No. 4534-3, tape L. 3 m Voltage Detector Slot No. 4615 3, 220-250 V, 3mm Wire stripper No. 8098-160 JC, 160 mm 2C handle Multiple Pliers No. 8133-200 JC, 200 mm 2C handle Power Combination Pliers No. 8250-180 JC, 180 mm 2C-Handle Power side cutter No. 8316-160 JC, 160 mm 2C handle, Universal Pliers No. 142 10 JC, 10". Percussion tool set No. 106, 6 pcs.Cable knife No. 0513-09, blade L.90 mm Wire brush No. 644, 3 rows+ Volume tool case WK 1041 L	395	490	185	74	10,6

1100-BASIC STARTER TOOL KIT

in GEDORE L-BOXX® 136,
23-piece



- Basic tool kit ideal for all trade
- With Check-Tool insert for quick check of tool completeness



Code	No.	Contents	Length mm	Width mm	Depth mm	Pieces	Weight kg
2835983	1100-BASIC	Open-end spanner with ring ratchet No. 7 R, SW 10 12 13 14 15 16 17 18 19 mm Universal cable knife No. 4528, blade L. 50 mm Wooden folding ruler No. 4533-2, 2 m Hobby saw No.406, blade L. 145 mm Flat chisel No. 95-200, 200x23x13 mm Engineer's hammer No. 600 H-500, 500 g Multiple nose pliers No. 8133-180 JC, 180 mm 2C handle Power side cutter No. 8316-180 JC, 180 mm, 2-component handle Universal pliers No. 142 10 TL, 10". 3C-Screwdriver slot No. 2150, 4 5.5 6.5 mm, 3C-Screwdriver Cross-recess No. 2160 PH 1 2 Voltage Detector Slot No. 4615, 3 mm, + L-BOXX® 136 No. 1100 L	358	445	152	23	6,1

1100-02 TOOL CASE ELECTRICIAN

in GEDORE L-BOXX® 136,
36 pieces



- › Especially suitable for professions in electrical engineering
- › A practical assortment for on-site use
- › With Check-Tool insert for quick check of tool completeness
- › GEDORE L-BOXX® 136 with Easy Click connection system

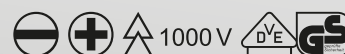

Code	No.	Contents
2658208	1100-02	Bricklayer's chisel No. 110-256, 250x16 mm, Electrician's chisel No. 112-2510, 4kt 250x10x7 mm Engineer's hammer No. 600 H-500, 500 g, Adjustable open-end wrench No. 60 CP 8, 8". Universal Pliers No. 142 10 JC, 10", Wire stripper No. 8097, automatic Multiple Pliers No.8133-180 JC, 180 mm 2C-Handle VDE side cutter No. VDE 8314-160 H, 160 mm VDE Flat nose pliers No. VDE 8132-200 H, 200 mm VDE Flat Nose Pliers No. VDE 8132 AB-200 H, angled 200 mm VDE Wire stripper No. VDE 8098-160 H, 160 mm, VDE cable cutter No. VDE 8094, 200 mm Universal Cable Knife No. 4528, Blade-L. 50 mm, Electrical insulating tape no. 4629, tape L.10 m Spatula No. 0175-06, sheet B. 60 mm, Offset screwdriver No. H 42-10, hexagon SW 1.3 1.5 2 2.5 3 4 5 6 8 10 mm VDE Screwdriver set No. VDE 2170-2160 PH-077, slot 2.5 4 5.5 6.5 mm, cross recess PH 0 1 2 Voltage Detector Slot No. 4615 3, 220-250 V, 3mm Voltage Detector Slot No. VDE 4616.12-1000 V, 3 mm Switch cabinet key ELEKTRO No. 45 E Wooden folding rule No. 4533-2, 2 m+ GEDORE L-BOXX® 136 No. 1100 L

Length mm	Width mm	Depth mm	Pieces	Weight kg
358	445	152	36	7,674

1100-1.04 UNIVERSAL PULLER SET

in GEDORE L-BOXX® 136,
13-piece



- › 12 different pullers can be combined
- › Outside Ø up to 130 mm, inside Ø up to 170 mm with a clamping depth of 200 mm
- › With two- and three-armed traverse
- › With rigid and slim legs and extensions
- › Extra slim Pulling hooks for narrow installation spaces are included for self-installation
- › GEDORE L-BOXX® 136 with Easy Click connection system

Code	No.	Contents
2838362	1100-1.04	Universal puller HIGH POWER No. 1.04/HP1A-B, 2-arm, 130x100 mm Cross-beam No. 107/1A03, 3-arm 180 mm Pulling leg No. 106/A-100-B, all-steel, leg brake3x extension No. 106/A-100-VB with leg brake 100 mm 3x pulling leg No. 106/A-100-S, slim 100 mm, 3x pulling leg No. 106/S101-S, without clamping part Spindle No. 1.1406200, 17 M14x1,5 200 mm+ GEDORE L-BOXX® 136 No. 1100 L

Length mm	Width mm	Depth mm	Pieces	Weight kg
357	442	151	13	6,3

1100-1.04/12A PULLER ASSORTMENT INSIDE/OUTSIDE

in GEDORE L-BOXX® 136, 7-piece



- › For clamping depths up to Ø 200 mm external, Ø 70-260 mm internal, and clamping reach up to 300 mm
- › Quick release hook with self-supporting T-profile for better power transmission
- › With 3 out of 4 spindles the spindle tip (ball/tip) can be turned
- › Max. capacity 3 and 5 t
- › GEDORE L-BOXX® 136 with Easy Click connection system

Code	No.	Contents	Length mm	Width mm	Depth mm	Pieces	Weight kg
2927241	1100-1.04/12A	Universal puller No. 1x 1.04/1A, 2-arm 130x100 mm Universal puller No. 1.04/2A 2-arm 200x150 mm Extension with hook brake no. 106/A-100-VB, 100 mm Extension with hook brake No. 106/B-150-VB, 150 mm Spindle No. 1.1406200 SW 17 M14x1,5 200 mm spindle No. 1.2106350KS, SW 22, G 1/2", 350 mm, with ball point+ GEDORE L-BOXX® 136 No. 1100 L	357	442	151	7	9,6

1100-1.30 INTERNAL EXTRACTOR SET

in GEDORE L-BOXX® 136,
8-piece



- › For inner diameter 12 - 35 mm and extremely tight ball bearings, rings, bushings and Simmerrings®.
- › With slide hammer and counter support
- › No. 1100 CT2-1.04/12A for retrofitting existing L-BOXX®s 136
- › With Check-Tool insert for quick check of tool completeness
- › As tools are fully sunk in the foam, the equipped insert can be stacked
- › Insert can be used in drawers with minimum dimensions 400 x 310 x 90 mm

Code	No.	Contents	Length mm	Width mm	Depth mm	Pieces	Weight kg
2836041	1100-1.30	Internal extractor No. 1.30/2.12-15 mm, Internal extractor No. 1.30/3.15-19 mm Internal extractor No. 1.30/4.19-25 mm, Internal extractor No. 1.30/4A, 25-30 mm Internal extractor No. 1.30/45, 30-35 mm, Counter support No. 1.36/1 for 1.30/0 - 1.30/5 Sliding hammer No. 1.35/2, 500 mm, 1.7 kg+ GEDORE L-BOXX® 136 No. 1100 L	357	442	151	8	7,2

1100 CT2-1.30 INTERNAL EXTRACTOR SET

in 2/2 L-BOXX® 136 Module
7 pieces



- › For inner Ø 12 - 35 mm and extremely tight ball bearings, rings, bushings and Simmerrings®.
- › With sliding hammer 1.7 kg and counter support
- › No. 1100 CT2-1.04/12A for retrofitting existing L-BOXX®s 136
- › With Check-Tool insert for quick check of tool completeness
- › As tools are fully sunk in the foam, the equipped insert can be stacked
- › Insert can be used in drawers with minimum dimensions 400 x 310 x 60 mm

Code	No.	Contents	Length mm	Width mm	Depth mm	Pieces	Weight kg
2836025	1100 CT2-1.30	1.30/21.30/31.30/41.30/4A1.30/51.36/11.35/2	357	310	60	7	5

1100-1.41/2A

SEPARATOR AND PULLER SET

in GEDORE L-BOXX® 136, 22-piece



- › For clamping depths from Ø 22 to 115 mm and clamping reach up to 295 mm
- › Incl. threaded inserts for internal threads M8-M18
- › For loosening and pulling tightly-seated parts e.g. taper roller bearings and inner bearing races
- › The clamping reach can be extended with extension rods 1.38/AV-FV from 195 to 295 mm
- › With Check-Tool insert for quick check of tool completeness
- › No. 1100 CT2-1.04/12A for retrofitting existing L-BOXX®s 136
- › As tools are fully sunk in the foam, the equipped insert can be stacked
- › Insert can be used in drawers with minimum dimensions 400 x 310 x 60 mm

Code	No.	Contents	Length mm	Width mm	Depth mm	Pieces	Weight kg
2927284	1100-1.41/2A	Separator puller No. 1x 1.38/2, 70-215 mm Separator No. 1.40/2, 22-115 mm Set of threaded inserts No. 1.81/20, for 1 and 2-hole applications, M14x1.5 2x extension No. 1.38/CV M14x1.5+ GEDORE L-BOXX® 136 No. 1100 L	357	442	151	22	11,5

1101-1.29/3K

BALL BEARING EXTRACTOR SET

in i-BOXX® 72, 13 pieces



- › Ball bearing extractor set for more than 40 ball bearings
- › For removing ball bearings that are both on a shaft and in a housing
- › Non-destructive removal of deep-groove ball bearings without dismantling the shaft; no necessity to drill open the bearing cage (no chippings)
- › With Check-Tool insert for quick check of tool completeness
- › Insert can be used in drawers with minimum dimensions 340 x 260 x 60 mm

Code	No.	Contents	Length mm	Width mm	Pieces	Weight kg
2964392	1101-1.29/3K	4 Heads with spindle No. 1.29/1 - 1.29/5 7 Heads with spindle No. 1.29/10 - 1.29/45 1 Handle No. 1.29/0	316	367	13	5,78

1.07/AS-2 PULLER-SET with 9 legs



- › Narrow pull-off hooks for narrow and poorly accessible spaces, e.g. for gears in 3 lengths
- › The three-armed cross beam guarantees even load distribution and thus a particularly secure hold on the part to be pulled off
- › Interchangeable hooks for several clamping depths or extensions available
- › Optimum sliding properties through nitrocarburized spindle, oil or grease is no longer necessary

Code	No.	Contents	max. t	Weight kg
1675990	1.07/AS-2	107/2A03 Cross beam 3-arm 260 mm, 106/B-150-S Pull-off hook slim 150 mm (3x) 106/S220 Pull-off hook slim 220 mm (3x), 106/B-300-S Pull-off hook slim 300 mm (3x) 1.2106210 Spindle SW 22, G 1/2", 210 mm	5,0	11,5

1.07/K-1-SE PULLER-SET with 3 legs



- › Narrow quick-release pull-off hooks for narrow and poorly accessible spaces, e.g. in gearboxes
- › 2- and 3-armed set. The three-armed cross beam guarantees even load distribution and thus a particularly secure hold on the part to be pulled off
- › Interchangeable hooks for several clamping depths or extensions available
- › Optimum sliding properties through nitrocarburized spindle, oil or grease is no longer necessary
- › In rugged plastic case

Code	No.	Contents	max. t	Weight kg
1438484	1.07/K-1-SE	E-106/103 Traverse 2-armed 140 mm, E-107/103 Cross beam 3-arm 140 mm 106/A-100-SE Pull-off hook with quick release clamp 100 mm (3x) E-1.1406140 Spindle SW 17, M14x1.5, 140 mm (2x), 107/199-SE Plastic case with foam insert for 1.07/K-1-SE	2,5	2,2

1.07/K-1-SE 200 S PULLER-SET with 6 hooks, 9 pieces



- › 2&3 arm set. The three-armed cross beam guarantees even load distribution and thus particularly secure hold on the part to be pulled off
- › The forged hooked feet are particularly suitable for difficult-to-access places
- › Quick release legs for fast, easy set-up and adjustment
- › Interchangeable hooks for several clamping depths or extensions available
- › Clamping depth 100 mm = hook foot thickness (e) 3.7 mm, max. 2.5 t
- › Clamping depth 200 mm = hook foot thickness (e) 2.0 mm, max. 2.0 t
- › In rugged plastic case

Code	No.	Contents	Pieces	Weight kg
1745158	1.07/K-1-SE 200S	106/203 Cross beam 2-arm 220 mm, 107/203 Cross beam 3-arm 220 mm 106/A-100-SE Pull-off hook with quick release clamping piece 100 mm (3x) 06/S-200-SSE Slim pull-off hook with quick release clamping piece 200 mm (3x) E-1.1406140 Spindle SW 17, M14x1.5, 140 mm (2x) 107/199-SE 200S Plastic case with foam insert for 1.07/K-1-SE 200S	9	4,2

RELEASE TENSIONS

If components are pressed on, the frictional connections can be released with the aid of pullers.

The puller set, 1.04/ST-HP-B from GEDORE includes three pullers with different spans and depths. These can withstand particularly high forces and can be loaded with double the tensile force, as the crossheads are particularly high-quality hardened and tempered. In addition, the traverses and hooks are hot-forged from one piece in the die, which is an added value for durability and safety.

The hook brake prevents unintentional slipping of the hooks on the crosshead, so that the risk of accidents is again minimized. The hooks can be adjusted quickly and evenly via the adjustment scale. This guarantees a centric, force-optimized and, above all, safe pull-off even with the highest pull-off forces.



1.04/ST PULLER-SET

with workshop stand, 3 parts



- > Consisting of 3 pullers in different sizes
- > Cross-beam especially hardened and tempered allows safe application of extremely high pulling forces and doubles the tensile force capability
- > Strong drop forged pattern
- > Pulling legs forged from one piece
- > With leg brake - prevents unintentional leg slipping. The leg can be slid along the cross-beam at the push of a button
- > Can be used as external and internal puller by repositioning the hooks
- > Scale for uniform adjustment of the puller legs. Allows centred pulling, with optimised application of force, even when extremely high pulling forces are required
- > Upgradeable with hydraulic spindle

Code	No.	Contents	Length mm	Pieces	Weight kg
2300044	1.04/ST-HP-B	1.04/HP1A-B Puller HIGH POWER 2-arm 130x100 mm 1.04/HP2A-B Puller HIGH POWER 2-armed 200x150 mm 1.04/HP3A-B Puller HIGH POWER 2-armed 350x200 mm 1.04/97 Stand empty for 1.04 series	125	3	14,4

1

HIGHER TRIGGER TORQUES

- Due to the bending moment reinforcement at the back of the forged crosshead, a higher load capacity and safety is guaranteed.

2

SAFE AND EFFICIENT

- The puller hooks with hook brake guarantee a secure fixation on the crosshead and make a quick adjustment from an external to an internal puller possible

3

MORE FLEXIBILITY

- The interchangeable tips can be easily changed in use, so that the ball or tip can be used

4

MORE SECURITY

- Uniformly aligned hooks thanks to the adjustment scale on the crossbeam provide more safety in use



DOUBLE
TRACTIVE
EFFORT LOADING

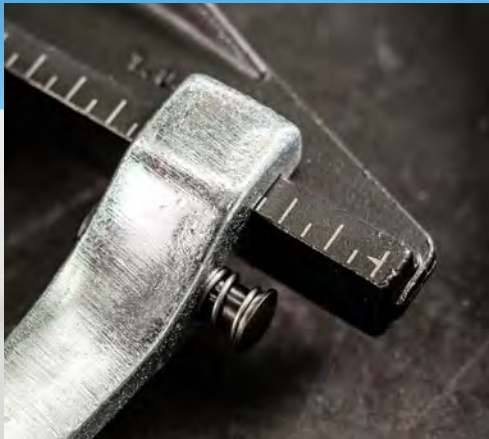

"Drop-forged components means a possible overload by bending, because the fibrous pattern of the material created during forging, allows for some flexibility of the components before fracture occurs - a very "healthy" characteristic."

1.11

PULLER

3-arm pattern



- › Tried and tested, powerful 3-arm puller for even load distribution and thus particularly secure hold on the part to be pulled off
- › The wide or narrow hook ends which can be used on both sides press themselves automatically under load
- › The wide hook ends of the pullers No. 1.11/2 and /4 are provided with 8 mm slots, so that discs or gears can also be pulled off with the aid of 8 mm screws

Code	No.	Clamping width (max.) mm	Clamping depth mm	Tractive force (max.)	Spindle thread size	Width across flats Actuating hexagon	Hydraulic spindle optional	Hook base width mm	Hook base depth mm	Hook base thickness mm	Weight kg
8002950	1.11/1	90	80	3	M 14x1,5 x 125	17	-	17	7	2,0	0,9
8003090	1.11/2	160	130	7,5	M 18x1,5 x 170	19	-	24	13	3,0	2,6
1731912	1.11/4	320	260	12	G 1/2 x 350	22	1.06/HSP1	27	27	6,5	5,8

1.18/1.19 PULLER SET

12 pieces

- › This perforated panel offers place for 12 pullers of the series 1.18 and 1.19
- › For clamping depths from Ø 200 mm and clamping reach up to 200 mm
- › Delivery includes perforated panel



Code	No.	Contents	Pieces	Weight kg
1824007	1.18/1.19	1.18/1 Puller 2-arm 110x110 mm, 1.18/2 Puller 2-arm 160x140 mm 1.18/3 Puller 2-arm 200x200 mm, 1.18/02 Pole terminal remover 2-arm 65x50 mm 1.18/01 Pole terminal remover 2-arm 70x70 mm, 1.18/0 Pole terminal remover 2-arm 80x80 mm 1.19/1 Puller 3-arm 110x110 mm, 1.19/2 Puller 3-arm 160x140 mm 1.19/3 Puller 3-arm 200x200 mm, 1.19/02 Pole terminal remover 3-arm 65x50 mm 1.19/01 Pole terminal remover 3-arm 70x70 mm, 1.19/0 Pole terminal remover 3-arm 80x80 mm 1500 H 1 tool hook inclined hook end d 4 mm (12x) 1500 H 2-13 Tool clamp d 13 mm (6x), 1450 L Tool board empty, 987x493 mm	12	21

2.30 INDUSTRIAL PULLING SET

Modular system, 17 parts

- › For the assembly of the tried and tested 1.06 and 1.07 versions
- › Using this set, you will be able to assemble 12 of the usual versions with high-speed clamping legs, including hydraulic spindle, in seconds
- › 2- and 3-arm set up to a span width of 200 mm and a clamping depth of 150 mm
- › Easy and controlled removal of particularly tight parts with the hydraulic spindle
- › Immediately ready to hand on a perforated wall panel

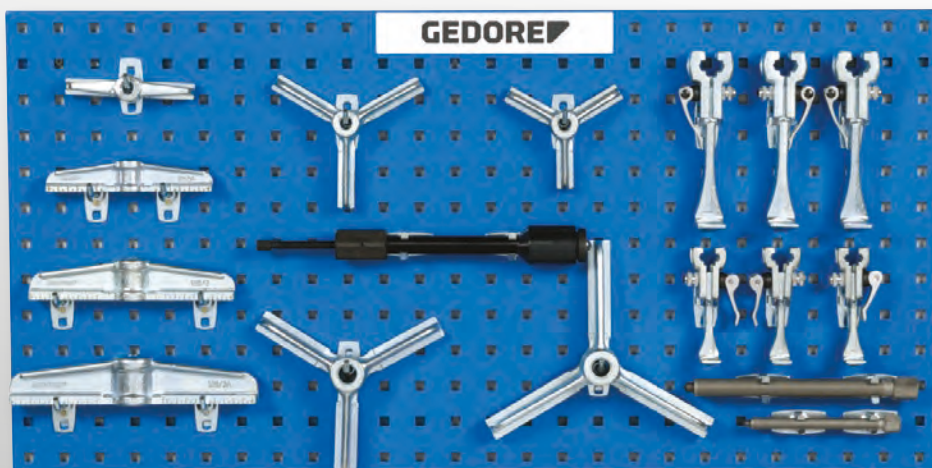

Code	No.	Contents	Pieces	Weight kg
1393014	2.30	1 cross-beam, 2-arm pattern 140 mm, No. 106/103, 1 cross-beam, 2-arm pattern 180 mm, No. 106/1A03 1 cross-beam, 2-arm pattern 220 mm, No. 106/203, 1 cross-beam, 2-arm pattern 260 mm, No. 106/2A03 1 cross-beam, 3-arm pattern 140 mm, No. 107/103, 1 cross-beam, 3-arm pattern 180 mm, No. 107/1A03 1 cross-beam, 3-arm pattern 220 mm, No. 107/203, 1 cross-beam, 3-arm pattern 260 mm, No. 107/2A03 1 spindle 17 mm, M14x1.5, 140 mm, No. 1.1406140, 1 spindle 22 mm, G 1/2", 210 mm, No. 1.2106210 1 hydraulic pressure spindle 10 t, No. 1.06/HSP1, 3 quick-release pulling legs 100 mm, No. 106/A-100-E 3 quick-release pulling legs 150 mm, No. 106/B-150-E	17	19,4

2.40

PULLING SET FOR CONSTRUCTION MACHINES

Modular system, 16 parts



- › For the assembly of the robust and handy strap-pattern pulling tools 1.14 and 1.15
- › With this set, you will be able to assemble 10 of the usual flexible strap-pattern pulling tools from the range 1.14/1.15, including the new hydraulic spindle
- › 2- and 3-arm set up to 280 mm span width and 390 mm clamping depth
- › Immediately ready to hand on a perforated wall panel
- › Optimally suited for recurring clamping ranges
- › Easy and controlled removal of particularly tight parts with the hydraulic spindle

Code	No.	Contents	Pieces	Weight kg
1393030	2.40	1 head 2-arm pattern No. 114/2041 head 2-arm pattern No. 114/304 1 head 3-arm pattern No. 115/2041 head 3-arm pattern No. 115/304 1 spindle 19 mm, M18x1.5, 200 mm, No. 1.1806200 1 spindle 22 mm, G 1/2", 250 mm, No. 1.2106250 1 hydraulic pressure spindle 10 t, No. 1.06/HSP1 3 pulling legs 210 mm, No. 114/201 3 pulling legs 260 mm, No. 114/301, 3 pulling legs 390 mm, No. 114/401 6 straps No. 114/20812 straps No. 114/308	16	24,3

1.13 BATTERY-TERMINAL PULLER

3-arm pattern



- › Ideal for removing small parts such as battery terminals, pulleys, wheels, ball bearings, etc.
- › The legs grip automatically

Code	No.	Clamping width (max.) mm	Clamping depth mm	Tractive force (max.)	Spindle thread size	Hook base width mm	Hook base depth mm	Hook base thickness mm	Weight kg
8004650	1.13/02	60	40	0.75	M 10x1,5 x 60	10	5	2,0	0,2
1628410	1.13/00	70	80	1	M 10x1,5 x 100	14	8	2,0	0,4

1.31/1

INTERNAL EXTRACTOR SET

8 pieces

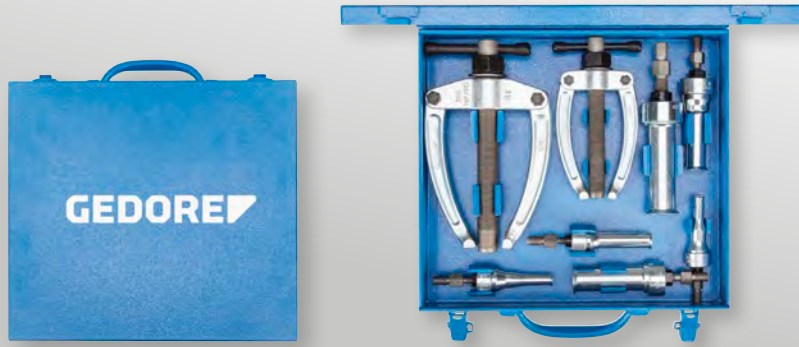

- › Sets comprise the most used extractor sizes for the removal of ball bearings, bearing races, bushings, shaft seals, etc.
- › In robust sheet metal case

Code	No.	Contents	Pieces	Weight kg
8014610	1.31/1	6 Internal extractor 12-46 mm, No. 1.30/2 - 1.30/62 counter supports No. 1.36/1 - 1.36/2	8	6,4

1.32/2

SET OF INTERNAL AND EXTERNAL EXTRACTORS

15 pieces



- › This set is ideally suited for a variety of exterior and interior extraction situations
- › Sets with internal extractors, counter supports, puller chucks, external extractors and stud extractors
- › In robust sheet metal case

Code	No.	Contents	Pieces	Weight kg
8015340	1.32/2	8 internal extractors 12-70 mm No. 1.30/2 - /8, 2 counter-support braces No. 1.36/1 - /2 1 puller with extra slim legs No. 1.19/OXS, 1 battery-terminal puller No. 1.12/02 2 pullers, 2-arm pattern, No. 1.06/1 1.06/2, 1 stud extractor No. 1.28/1	15	19

1.41/2

SEPARATOR AND PULLER SET



- › For Ø 22-115 mm all in one, separating device puller puller extensions in a handy case to take along
- › Optimal for tightly mounted / supported parts
- › By using the flat surfaces of the separating device, sensitive parts are protected
- › Additional extensions 1.38/CV optionally available

Code	No.	Contents	Weight kg
8109910	1.41/2	Puller No. 1.38/2, Extension No. 1.38/CV, Separating device No. 1.40/2	9

1.72 BALL JOINT PULLER



- › For the simple and damage-free removal of ball pins on track rods and push rods
- › Strong, drop-forged design for safe working
- › Direct power transmission

Code	No.	Span outside pull-off (max.) mm	Opening depth mm	Hook base width at of the usable surface mm	Spindle thread size	Width across flats Actuating hexagon	Weight kg
8030490	1.72/2	23	45	50	M 14x1,5 x 50	17 mm	0,4 kg
2183331	1.72/5A	46	100	90	G 3/4 x 160	27 mm	2,78 kg

1.26/K-3 NUT SPLITTER SET

6 pieces



- › For nuts from size 10 mm (M6) to size 36 mm (M24), including spare chisel
- › 3 nut splitters incl. spare chisel in a plastic case in CT inlay
- › Forged pattern
- › Induction hardened chisel with chisel stop

Code	No.	Contents	Length mm	Width mm	Depth mm	Pieces	Weight kg
2017008	1.26/K-3	1 nut splitter 10-17 mm, M6-M10, No. 1.26/1 1 nut splitter 17-24 mm, M10-M16, No. 1.26/2 1 nut splitter 24-36 mm, M16-M24, No. 1.26/3 2 spare chisels for 1.26/1 + 1.26/2, No. 1.26/M1 1 spare chisel for 1.26/3, No. 1.26/M3	229	275	83	6	2,46

1.28/2 STUD EXTRACTOR



- › For removing damaged studs with right-hand or left-hand thread
- › Even suitable for extremely short stud ends
- › Flush overlying

Code	No.	Ø stud bolt	Width across flats mm	Weight kg
8010700	1.28/2	8-19	19	0,3 kg

1.81/20

THREAD ADAPTOR SET

for 1- and 2-hole applications, 2 pieces each, 14 pieces



- > The threaded inserts make the removal of threaded caps, for example, possible, when these possess 1 or 2 threaded holes
- > Can be used either with pulling device 1.38, sliding hammer 1.35 or counter support 1.36
- > No. 1.81/20: For puller No. 1.38/2

Code	No.	Contents	Pieces	Weight kg
1120751	1.81/20	2 Thread inserts M14x1,5 - M8, No. 181/207, 2 Thread inserts M14x1,5 - M10, No. 181/208 2 Thread inserts M14x1,5 - M12, No. 181/209, 2 Thread inserts M14x1,5 - M14, No. 181/210 2 Thread inserts M14x1,5 - M16, No. 181/211, 2 Thread inserts M14x1,5 - M18, No. 181/212 2 Adaptors, No. 181/225	14	1,222

1.81/K-12

THREAD ADAPTOR SET

for 1-hole applications, 11 parts



- > The threaded inserts make the removal of threaded caps, for example, possible, when these possess one threaded hole
- > Can be used either with slide hammer 1.35 or optionally also with counter support 1.36

Code	No.	Contents	Pieces	Weight kg
1936557	1.81/K-12	Sliding hammer No. 1.35/1A, Rod 230 mm, Impact weight 700 g, Adaptor M14x1,5M10 - M4, M10 - M5, M10 - M6, M10 - M8, M10 - M10, M10 - M12 M14x1,5 - M14, M14x1,5 - M16, M14x1,5 - M18	11	1,83

1.85/1

PROFESSIONAL PLASTIC BEARING INSTALLATION SET

37 pieces



- > Using this bearing installation set more than 200 types of bearings may be re-installed effortlessly and without damage
- > The impact-resistant plastic is handily light, but just as robust as the metal variants
- > The impact rings are now secured on the pipe
- > In rugged plastic case

Code	No.	Contents	Length mm	Width mm	Depth mm	Pieces	Weight kg
1120778	1.85/1	33 impact rings, 10-50 mm for external Ø 26-110 mm 3 aluminium impact sleeves 1 recoil-free bodywork hammer with nylon heads (1.2 kg)	360	450	140	37	5,2

106 D
TOOL SET
 6 pieces



- > For chiselling work on steel and other metals and for driving in or out cotter pins, dowel pins, dowel pins or other connecting elements
- > Thoroughly hardened and tempered over the entire length
- > Striking heads inductively tempered
- > Working edge polished and clear varnished



Code	No.	Contents	Pieces	Weight kg
8725710	106 D	97-125 150 98-125 99 12-3 100-10 119-4	6	0,805

113 D
DRIFT PUNCH SET
 6 pieces



- > For driving in or expelling split pins, spring pins, bolts or other connecting elements
- > Carefully hardened and tempered along the full length
- > Beater heads additionally inductively tempered
- > Working edge polished and clear varnished



Code	No.	Contents	Pieces	Weight kg
8754060	113 D	Drift punch 8-edged No. 99 10-1 10-2 10-3 12-4 12-5 Grains No. 100-10	6	0,755

116 D
PIN PUNCH SET
 6 pieces



- > For driving in or expelling split pins, spring pins, bolts or other connecting elements
- > Carefully hardened and tempered along the full length
- > Jamming of the drift pin in the bore is prevented by minus tolerance
- > Beater heads additionally inductively tempered
- > Working edge polished and clear varnished



Code	No.	Contents	Pieces	Weight kg
8758050	116 D	3 4 5 6 7 8 mm	6	0,82

THE STANDARD IN HAMMERS - THE ORIGINAL

Next to the wrench, the hammer is part of the basic equipment of every craftsman - from the professional to the DIYer.

The locksmith's hammer 600 H from GEDORE impresses with its safety and durability. This is ensured by the original ROTBAND-PLUS system, which consists of an additional screw connection and a safety plate compared to conventional

hammers. This guarantees an extremely secure connection between the hammer head and the handle, preventing unintentional loosening of the hammer head. The hardened ROTBAND-PLUS handle protection sleeve additionally protects the handle from damage and gives the hammer head additional support. In combination with an ergonomically shaped handle made of high-quality hickory wood and a hammer head made of quality steel, you get an absolute professional tool.

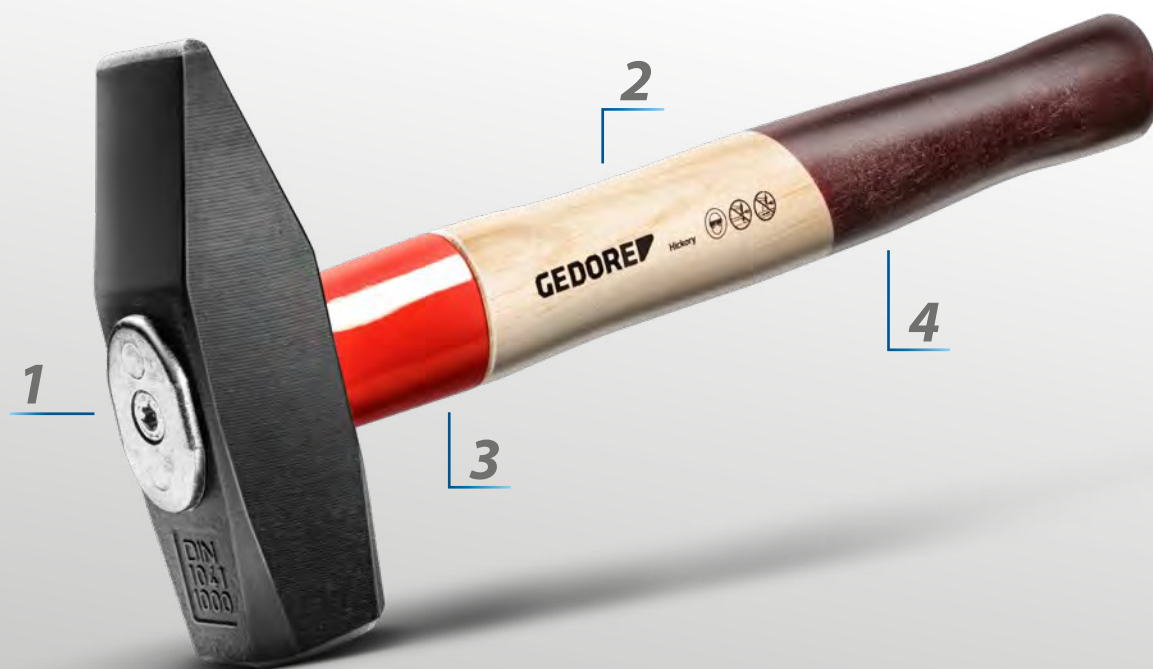

600 H ENGINEERS' HAMMER ROTBAND-PLUS - THE ORIGINAL

- > For universal use in the workshop, on the construction site, in the industrial sector or at home
- > Engineers' hammer with proven safety technology
- > Hardened hammer head and ROTBAND-Plus handle protective steel sleeve
- > Hot-drop forged hammer head, DIN 1041
- > Doubly contoured, long-lasting hickory handle DIN 5111



Code	No.	Head weight g	Stick length mm	Spare handle	Length mm	Weight kg
8583070	600 H-300	300	305	E 600 H-300	300	0,502
8583230	600 H-500	500	320	E 600 H-500	320	0,727
8583580	600 H-800	800	350	E 600 H-800	350	1,135
8583660	600 H-1000	1000	360	E 600 H-1000	360	1,326

1

THE ROTBAND-PLUS SYSTEM

- guarantees a secure connection between the handle and the hammer head by means of fixing elements and prevents the hammer head from coming loose unintentionally

2

INCREASED SAFETY

- More safety in case of stem breakage due to long-fibre hickory wood

3

LONG LIFE

- The service life is considerably increased by the hardened ROTBAND-PLUS handle protective sleeve and the safety plate, which protects the predetermined breaking point on the handle.

4

FIRM GRIP

- The ergonomic shape of the handle and the hand-friendly wood ensure a firm and secure grip.



"A truly compelling and well thought out quality product."

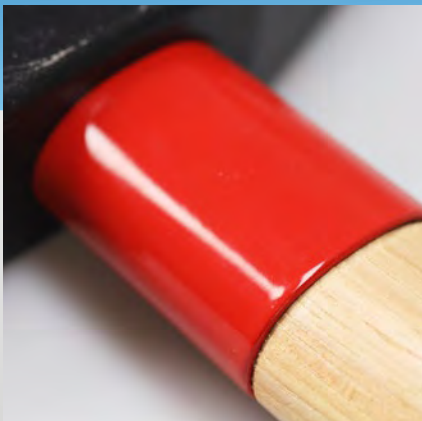

Wooden handle with Rotband-Plus safety device
1000 failures: lighter marks on the paint, no deformations, absolutely tight fit.



Unprotected hammer handle
30 failures: clear damage to the stem - risk of breakage!



620 E-2000 CLUB HAMMER ROTBAND-PLUS



- › For universal use in the workshop, industry, at home or on the construction site
- › Mallet with proven safety technology
- › The sleeve, tapered collar, fixing plate and wood screw bond the hammer head and wood handle into one unit
- › ROTBAND-PLUS handle join, high working safety, long service life, best price-performance ratio
- › Glowing drop-forged sledgehammer head DIN 6475
- › Curved ash handle DIN 5135 with additional long, hardened steel handle protection sleeve



Code	No.	Head weight g	Spare handle	Length mm	Weight kg
8887290	620 E-2000	2000	E 620 E-2000	300	2,291

609 H-5 SLEDGE HAMMER ROTBAND-PLUS - THE ORIGINAL



- › High-quality sledge hammer for everyday use on construction sites, in the garden and in workshops, ideal for professional work and the do-it-yourselfer
- › ROTBAND-PLUS System: Secure connection between handle and hammer head by means of fixing elements, protection against damage due to failure thanks to steel handle protection sleeve
- › Handle made of USA hickory wood: More safety in case of handle breakage due to the long-fibre structure of the wood, vibration damping and break-resistant wood properties
- › Hot forged hammer head according to DIN 1042, high safety and long service life due to materials used



Code	No.	Head weight g	Spare handle	Length mm	Weight kg
8673650	609 H-5	5000	E 609 H-5	800	6,035

248 H RECOILLESS HAMMER



- › Non-return soft-face hammer with polyamide heads, ideal for everyday use on construction sites, in industry, in workshops and around the house
- › Protects tendons and joints thanks to filling the hammer head with small steel balls
- › Gentle to the surface due to its full impact behaviour on sensitive workpieces, exchangeable splinter-free heads made of break and wear-resistant polyamide 75 Shore, tested to -20 degrees Celsius
- › Sturdy hickory handle with handy grip made of USA hickory wood, robust hammer head made of steel with filling of small steel balls

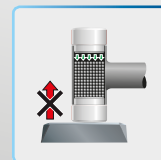

Code	No.	Ø	Length mm	Weight kg
8868230	248 H-30	30	330	0,47
8868580	248 H-40	40	360	0,73
8868740	248 H-50	50	370	1,02

247 H-35 COMBINATION HAMMER KOMBI-PLUS R



- › Two hammers in one due to universal use as combined soft-face and engineer's hammer
- › Universal use for service and assembly work
- › With all the advantages of a recoilless hammer
- › With exchangeable splinter-proof, shatter-proof and wear-resistant polyamide head (E 247), 75 Shore D, tested to -20 °C
- › With USA hickory handle (No. E 247 H)

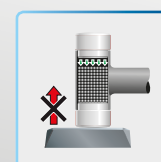

Code	No.	Ø	Length mm	Weight kg
1603396	247 H-35	35	310	0,69

224 E-32 PLASTIC HAMMER



- › Plastic hammer for straightening workpieces and for gentle blows during assembly work, ideal for everyday use on building sites, workshops and around the house
- › Exchangeable heads made of impact-resistant cellulose acetate with a hardness of 65 Shore D
- › handle made of robust ash, replacement heads easily exchangeable



Code	No.	Ø	Spare handle	Length mm	Weight kg
8821430	224 E-32	32	E 224 E-32	280	0,32

226 E-3 RUBBER MALLET

hard



- › For universal use in all trades
- › With 2 flat surfaces
- › With ash handle
- › Robust low-wear material
- › Acc. to DIN 5128-90, 90 Shore A



Code	No.	Ø	Head length mm	Length mm	Weight kg
8825930	226 E-3	75	130	380	0,99

75 STKM CARPENTER'S HAMMER WITH MAGNET

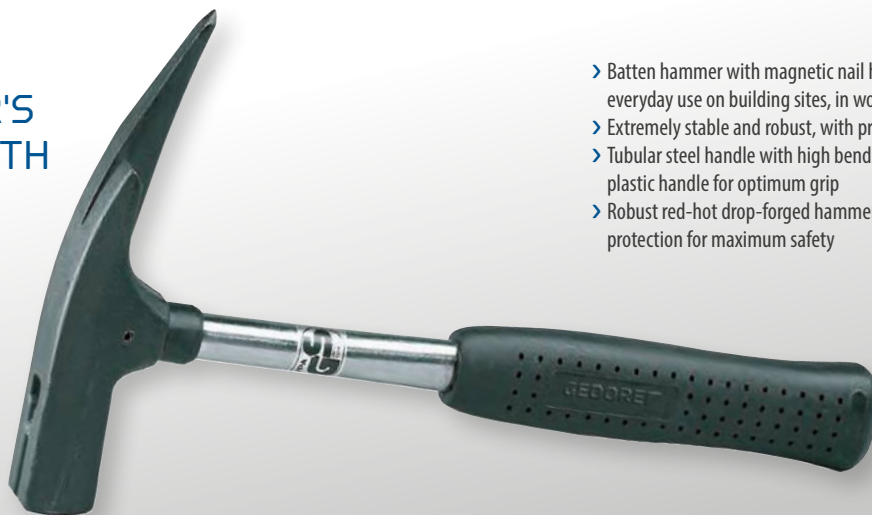

- › Batten hammer with magnetic nail holder for driving nails, ideal for everyday use on building sites, in workshops and around the house
- › Extremely stable and robust, with practical magnetic nail holder
- › Tubular steel handle with high bending strength, comfortable plastic handle for optimum grip
- › Robust red-hot drop-forged hammer head with head protection for maximum safety



Code	No.	Version/Execution	Head weight g	Length mm	Handle length mm	Weight kg
8813090	75 STKM	with magnet	600	317	300	0,847

THE MOTHER OF ALL PIPE WRENCHES

Whether screws, nuts, pipes or round and flat material - the pipe wrench from GEDORE reliably grips any material!

The corner pipe wrench 100 1.1/2 from GEDORE is used as a universal tool in many trades. Thanks to the three-point system, any shape or material is gripped reliably at three points simultaneously. The special geometry of the jaw shape prevents the workpiece from slipping out.

In combination with the additional flame-hardened teeth, this results in a quality product for more safety and durability even under the toughest conditions. The jaw opening can be flexibly adjusted up to max. 60mm via the knurled screw.

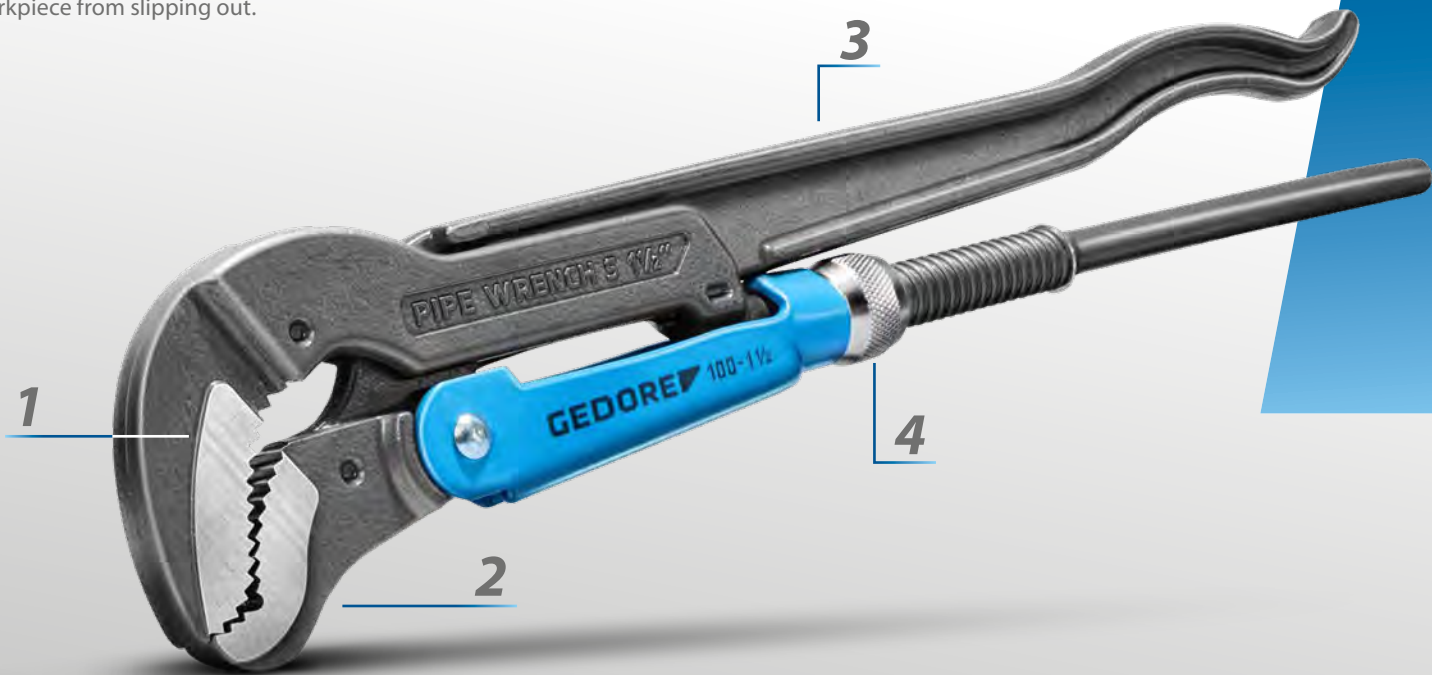

100 1.1/2 ELBOW PIPE WRENCH ECK-SCHWEDE-SNAP® - THE SWEDISH



- > Classical and proven S-mouth pipe wrench for universal use on pipes, nuts and fittings
- > Gripping capacity 60 mm/2.3/8"
- > Self-clamping gripping on round and angular workpieces, pipes and nuts
- > Infinitely variable adjustment due to captive roller
- > Good accessibility due to slim jaws
- > Additional induction hardened teeth with 61 HRC
- > Hot drop forged according to DIN ISO 5234, form C

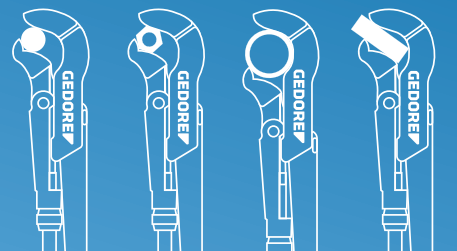

Code	No.	Size	Tube-Ø mm	Length mm	Weight kg
4500220	100 1.1/2	1.1/2	60 mm	420 mm	1,4 kg

1

SECURE HOLD

- The three-point system in combination with the oppositely directed tothing creates a self-clamping effect of the workpieces, which ensures a firm and secure hold.

2

SPECIAL JAW GEOMETRY

- prevents the workpiece from slipping, the workpiece is fixed at three points

3

BEST QUALITY

- The drop-forged tong legs are designed for high loads and torques, ensuring greater safety

4

EFFICIENT WORK

- The knurled screw allows the jaw opening to be quickly adjusted to the workpiece, saving working time



"The GEDORE pipe wrench still sets the standard for all pipe wrenches worldwide."

142 UNIVERSAL PLIERS



142 10 TL



142 12 TL

- › Universal water pump pliers with a wide range of applications in all trades
- › Self-clamping gripping on round and angular workpieces, pipes and nuts
- › Box joint with 17- and 15-fold fine adjustment at the push of a button
- › Effective pinch protection prevents fingers and hands from being crushed
- › Good accessibility in narrow areas due to slim pliers head
- › Induction hardened teeth with 61 HRC
- › Steel grey with blue dipped rough handles
- › Manufactured according to DIN ISO 8976, form D

Code	No.	Length mm	Width mm	Height mm	Span mm	Weight kg
2668211	142 7 TL	180	6,5	40,0	37	0,183
6416180	142 10 TL	255	7,5	48,0	38	0,371
1995413	142 12 TL	309	8,5	55,0	44	0,55

A TRUE ALL-ROUNDER

The pliers wrench from GEDORE is the combination of wrench and pliers in a single tool.

The 183 TC pliers wrench from GEDORE is the ideal tool for countless applications in industry, trade and the hobby screwdriver. The pliers wrench is suitable for holding, pressing, gripping and bending various workpieces, which is only made possible by the interaction of the mechanics and the smooth jaws. Anyone working with the pliers wrench can rely on an enormously high pressing and clamping force: the jaws act on the workpiece with more than ten times the manual force.

The smooth and parallel jaws leave no marks on the materials. High-quality surfaces, materials and screw connections are not damaged. Workpieces up to a maximum of 52 mm or 2" can be machined, which means that a large number of spanners can be replaced.

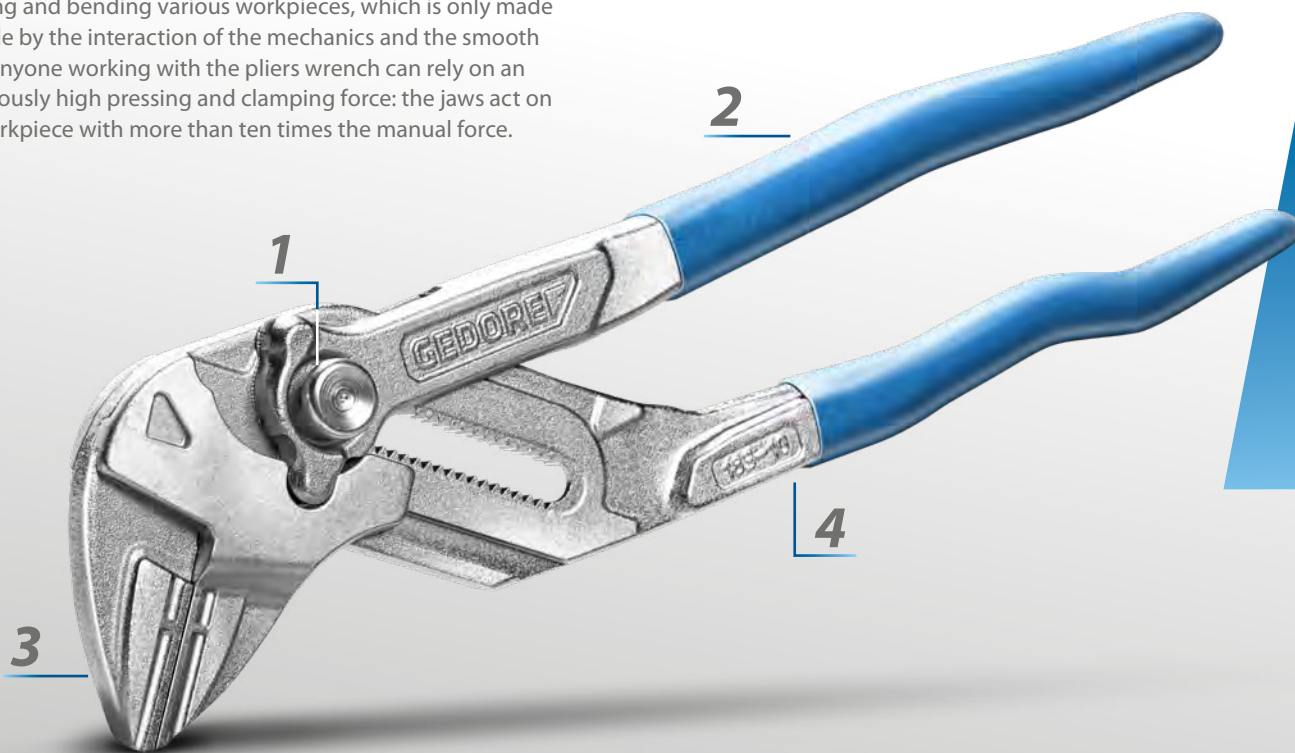

183 PLIER WRENCH



- > Adjustable, universal tool for wrenching work, bending, holding, pressing and gripping
- > Can replace two complete open-ended spanner sets, metric and imperial (0-52 mm or 0-2")
- > Can be used as a ratchet wrench - quick and convenient tightening and loosening of hexagon screws and nuts
- > Gentle assembly of surface-sensitive screw connections (e.g. chrome-plated or plastic fittings)
- > Sliding mechanism may be activated from almost any setting
- > Adjustment of the width across flats by sliding mechanism and parallel guided jaws, practically infinitely variable
- > Optimum ergonomic adjustment of the hand position to the size of the jaw or spanner opening
- > DIN ISO 5743
- > Model TC = chrome-plated, with blue dipped non-slip handles

Code	No.	Size	Clamping reach mm	Length mm	Weight kg
3066029	183 7 TC	7	42	185	0,265
3066037	183 10 TC	10	52	250	0,575

1

PRODUCTIVE AND EFFICIENT WORK

- Adjustment to the workpiece is done at the touch of a button on the quick setting. When working on screwed connections, the stroke between the jaws helps and enables fast screwing using the ratchet principle.

2

THE PERFECT ALL-ROUNDER

- The pliers wrench is suitable for screwing, bending, holding, pressing and gripping due to its mechanics and gripping jaws

3

HIGH QUALITY ASSEMBLY

- The smooth surfaces of the jaws are gentle on surface-sensitive screw connections or fittings

4

HIGH POWER TRANSMISSION

- The excellent pressing and clamping force with tenfold transmission ratio guarantees a firm hold of the workpiece



**STRONG
SAFE GRIP**



"For various applications, the GEDORE pliers wrench is a real universal problem solver. The pliers wrench grips very tightly and with virtually no play."

137 GRIP WRENCH



137 7



137 10

- › Practical grip pliers with toggle lever for secure gripping or clamping of various materials
- › Ideal for carrying out compression and clamping operations thanks to the self-clamping effect and locking screw, with release lever for safe release of the locking pliers, operation with minimum effort
- › Forged, hardened and tempered jaws and special jaws with three-point support, processing of robust vanadium steel (nickel-plated), jaw body made of sheet steel with high strength
- › Durable and very resilient: no expansion under heavy load

Code	No.	Total length mm	Total length inch	Clamping reach mm	Clamping reach inch	Weight kg
6406620	137 7	185	7"	25	1"	0,288
6406700	137 10	230	10"	32	1.1/4"	0,526

8245 JC COMBINATION PLIERS

Euro pattern

- › Universal model with slimline head, ideal for confined spaces
- › For round and flat material and medium hard wire 1.6 mm
- › 2-component handle for tireless working when in constant use
- › Induction-hardened precision cutting edges, hardness 62 - 64 HRC
- › GEDORE special hardened and tempered steel, drop-forged, oil-hardened and annealed
- › Acc. to DIN ISO 5746



Code	No.	Length mm	Jaw length mm	Head width mm	Tip width mm	Head thickness mm	Weight kg
6733150	8245-180 JC	180	38	27,0	6,4	9,8	0,28
6733230	8245-200 JC	200	42	29,5	7,4	10,5	0,363

8250 JC POWER COMBINATION PLIERS

- › For round and flat material and all wires, also hard wire/piano wire, 1.6 mm
- › Roughly toothed gripping surfaces for securely holding screws, pipes etc.
- › For heavy continuous use
- › High leverage for easier work
- › Gentle on the hands during continuous use thanks to the 2-component handle
- › Forceps means 35% less effort
- › Gripping surface with file-cut for a particularly effective hold
- › Induction hardened precision cutting edges, extra long, cutting edge hardness 62 - 64 HRC
- › GEDORE special hardened and tempered steel, drop-forged, oil-hardened and annealed
- › Acc. to DIN ISO 5746



8250-180 JC



8250-200 JC



Code	No.	Length mm	Jaw length mm	Head width mm	Tip width mm	Head thickness mm	Weight kg
6707070	8250-180 JC	180	38	25,6	6,5	11,0	0,282
6707310	8250-200 JC	200	39,5	27,0	6,5	12,4	0,36

8248-160 JC ANGLED COMBINATION PLIERS

- › Specially offset teeth in the gripping surfaces for best grip on tubes and screws as well as on all wires, including hard wire/piano wire, 1.6 mm
- › For heavy continuous use
- › A 60° angled pliers head is gentle on your joints and tendons. In addition, you retain a clear view of the workpiece
- › No forced positioning of the hand
- › Forced holding of the hand is avoided, which enables fatigue-free working over a longer period of time
- › Higher cutting performance and longer tool life thanks to high-quality GEDORE special hardened and tempered steel
- › Induction-hardened precision cutting edges, hardness 61 - 63 HRC
- › Hot-drop forged



Code	No.	Length mm	Jaw length mm	Head width mm	Tip width mm	Head thickness mm	Weight kg
2276585	8248-160 JC	165	46	24,0	6,0	10,0	0,245

8314-160 JC SIDE CUTTERS

Swedish pattern



- › With slim head, ideal for tight spaces when cutting 1.6 mm wire
- › 2-component handle for tireless working when in constant use
- › Induction-hardened precision cutting edges, hardness 61 - 63 HRC
- › GEDORE special hardened and tempered steel, drop-forged, oil-hardened and annealed
- › Acc. to DIN ISO 5749

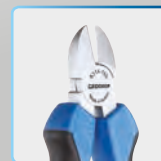

Code	No.	Length mm	Jaw length mm	Jaw width mm	Head thickness mm	Ø	Weight kg
6743380	8314-160 JC	160	19	22,0	10,0 mm	1,6	0,23

8314-180 JC POWER SIDE CUTTER

Swedish pattern



- › With slim head, ideal for narrow spaces for cutting medium hard wire 1.6 mm
- › High force build-up due to curved handle shape - crowned, i.e. slightly rounded surfaces/handles avoid unfavourable punctiform force peaks
- › Fatigue-free work in continuous use thanks to the 2-component handle cover
- › Induction-hardened precision cutting edges, hardness 61 - 63 HRC
- › GEDORE special hardened and tempered steel, drop-forged, oil-hardened and annealed
- › Acc. to DIN ISO 5749

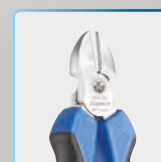

Code	No.	Length mm	Jaw length mm	Jaw width mm	Head thickness mm	Ø	Weight kg
2910934	8314-180 JC	185	25	26,0	11,0 mm	1,6	0,3

8316 JC POWER SIDE CUTTER

American pattern



8316-180 JC



8316-200 JC

- › High leverage for easy cutting of hard wires/piano wires
- › Max. cutting performance 1,4 - 2,0 mm
- › Highest cutting performance with less effort due to the optimum interaction of cutting geometry, eccentric rivet bearing and ergonomic handle design
- › 2-component handle for tireless working when in constant use
- › Induction-hardened cutting edges (63 - 65 HRC) enable consistent cutting performance over a long period of time
- › GEDORE special hardened and tempered steel, drop-forged, oil-hardened and annealed
- › Acc. to DIN ISO 5749

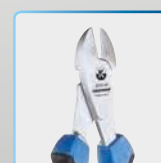

Code	No.	Length mm	Jaw length mm	Jaw width mm	Head thickness mm	Ø	Weight kg
1439588	8316-180 JC	180	22,6	26,0	11,0 mm	1,8	0,265
6745080	8316-200 JC	200	22	28,0	11,0 mm	2,0	0,34

POWERFUL TO THE TOP

3 different applications, 3 different pliers. This problem is solved by the flat round pliers, which combine the applications gripping, cutting and holding.

The flat-round pliers 8132 AB-200 JC from GEDORE are mainly used for installation and assembly work and for adjusting components. Thanks to the 45° angled tips and the flat-round jaws, work in confined spaces is also possible without any problems. This design makes the flat-round pliers suitable for a variety of tasks: for fine, well-controlled gripping and

holding of workpieces as well as for efficient cutting of cables and wires, for which a cutting function is integrated. Thanks to the high-quality 2-component handles with slip guard, the flat-round pliers are safe to work with.



8132 AB-200 JC TELEPHONE PLIER

with cutting edge, serrated, angled pattern

- > Suitable for gripping, bending and holding different materials thanks to serrated gripping surfaces and 45° angled tips for gripping tasks in hard-to-reach areas
- > 2-component handle for tireless working when in constant use
- > Induction-hardened precision cutting edges, hardness 61 - 63 HRC
- > GEDORE special hardened and tempered steel, drop-forged, oil-hardened and annealed
- > According to DIN ISO 5745



Code	No.	Length mm	Jaw length mm	Head width mm	Centre width mm	Head thickness mm	Tip thickness mm	Weight kg
6721300	8132 AB-200 JC	200	70,5	18,5	3,7	9,5	2,8	225 g

1

ANGLED TIP

- Tip angled 45° to enable gripping tasks in hard-to-reach places

2

INDIVIDUAL TOOL

- Suitable for gripping and holding - and for cutting

3

SAFE AND ERGONOMIC WORKING

- thanks to high-quality 2-component handle covers with slip guard



HIGH GRIPPING PERFORMANCE

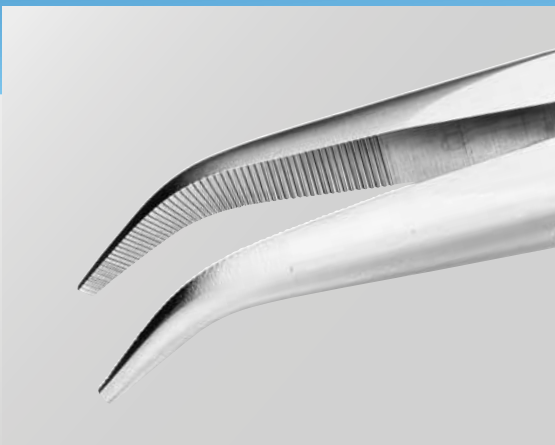

"These flat round pliers are a high-quality tool for professional users, e.g. in the sanitary sector. Those who work with tools on a daily basis expect quality that enables easy and safe work."

8132-200 JC

TELEPHONE PLIER

with cutting edge, serrated, straight pattern

- > For holding, gripping, bending and cutting
- > The cutting edges are additionally induction hardened, cutting edge hardness 61 - 63 HRC. Therefore it is even suitable for cutting hard wire
- > Long, flat-round jaws, straight gripping faces, serrated
- > 2-component handle for tireless working when in constant use
- > GEDORE special hardened and tempered steel, drop-forged, oil-hardened and annealed
- > Acc. to DIN ISO 5745

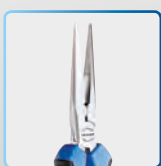

Code	No.	Length mm	Jaw length mm	Head width mm	Centre width mm	Head thickness mm	Tip thickness mm	Weight kg
6719670	8132-200 JC	200	75,7	18,5	3,7	9,5	2,8	225 g

8133-200 JC

MULTIPLE PLIERS

with cutting edge, serrated, straight pattern



- › Multifunctional pliers for the mechanical and electronic fields
- › Suitable for holding, bending, cutting, stripping, crimping and squeezing of various materials
- › For medium-hard wire 1.6 mm
- › Fatigue-free working in continuous use thanks to the ergonomic 2-component handle
- › Additional induction hardened precision cutting edges, cutting edge hardness 62 - 64 HRC
- › GEDORE special hardened and tempered steel, drop-forged, oil-hardened and annealed



Code	No.	Total length mm
2676079	8133-200 JC	200

Weight kg
0,2

8340 Z-200 TL

BOLT CUTTER



- › Compact power bolt cutter with a particularly effective cutting performance
- › Optimum lever action requires less effort
- › Double-sided milling with additional cutting edge, in the area close to the joint, guarantees best leverage for large wire diameters
- › The additional cutting edge serves as a pre-cutter for thick bolts and notches them very deeply
- › In the second step, the main cutting edge cuts through the bolt completely
- › cutting edges additionally induction hardened (63 - 65 HRC)
- › Precision cutting edges for soft wire up to Ø 6.0 mm, hard wire up to Ø 5.5 mm and piano wire up to Ø 3.8 mm
- › TL = steel-grey, with blue dipped non-slip handles

Code	No.	Length mm
2666316	8340 Z-200 TL	200

Weight kg
0,338

8092-160 TL

CABLE SHEARS



- › For precise cutting of multi-core copper and aluminium cables
- › Precision grinding for best cutting results
- › cutting capacity: 50 mm²/AWG 1, D=10 mm
- › cutting edge hardness: 55HRC
- › Special hardened and tempered steel, ground
- › With blue dipped, rough grip sleeves

Code	No.	Cable cross-section mm ²	Cable diameter mm	Total length mm	Total length inch	Weight kg
2878356	8092-160 TL	10/50	10	160	6.1/2"	0,18

8320-200 JC WIRE ROPE CUTTERS



Version JC:

- › Easy-to-change cutting plates
- › Cutting plates of powder metallurgical high-speed steel (HSS).
Manufactured in the MIM process (Metal Injection Molding)
- › Extremely high durability compared to traditional wire rope cutters
- › Soft shear cut reliably prevents splicing of the wire rope
- › Tip: Can be operated with one hand of an average size up to a 5 mm Ø.
Therefore optimally suited as shears in an emergency at sea.

Bake/cut:

- › Specially arched cutting edges
- › Easy to replace cutting plates if worn
- › Hardness 62 - 65 HRC
- › Low effort required due to optimum cutting geometry
- › 2 integrated press profiles for Bowden cable end caps and
Bowden cable sheath end caps

Cutting performance:

- › Wire ropes up to 1800 N/mm² with max. 6 mm Ø
(e.g. stainless steel wire ropes, wire ropes with steel and textile cables,
Bowden cables, shrouds)
- › Wire up to 750 N/mm² with max. 4 mm Ø (e.g. nails/wire pins,
screws, bolts, ceiling hangers)
- › Single and multicore copper and aluminium cables with
max. 6 mm Ø

Joint:

- › Adjustable joint for precise cutting plate guidance
- › Latch to prevent unwanted opening
- › Material/Finish:
› Plier body hot drop-forged
› chrome-plated

Code	No.	Length mm	Weight kg
2788799	8320-200 JC	200	0,48

S 8000 JE SET OF CIRCLIP PLIERS

4 pieces



- › Popular compilation
- › Indented tips made of highly wear-resistant
rolling bearing steel
- › Anti-twist tip geometry
- › Particularly suitable for barely accessible places
- › For internal retaining rings
- › With straight and 90° angled tips
- › Delivery in cardboard box



Code	No.	Contents	Length mm	Width mm	Depth mm	Pieces	Weight kg
3041999	S 8000 JE	Circlip pliers for internal retaining rings, straight Ø 10-25 mm No. 8000 JE 1 Circlip pliers for internal retaining rings, straight Ø 19-60 mm No. 8000 JE 2 Circlip pliers for internal retaining rings, 90° angled Ø 10-25 mm No. 8000 JE 11 Circlip pliers for internal retaining rings, 90° angled Ø 19-60 mm No. 8000 JE 21	315	165	30	4	0,58

POWERFUL ASSEMBLY PLIERS

The assembly of external and internal retaining rings requires a high-quality and precise special pliers - the assembly pliers.

The S 8000 AE assembly pliers set from GEDORE is the right solution for fitting retaining rings. Retaining rings are installed in a wide range of engines, vehicles or machines. Thanks to their inserted tips made from hardened and tempered rolling bearing steel, the GEDORE mounting pliers are significantly more reliable and durable than conventional mounting pliers with turned-on tips. The legs of the pliers, made from GEDORE chrome-vanadium special hardened and tempered steel,

are drop-forged, carefully oil-hardened and tempered. The precision screwed joint is used for adjusting the pliers legs. Thanks to the non-slip grips, the pliers fit comfortably in the hand and offer maximum safety during assembly.

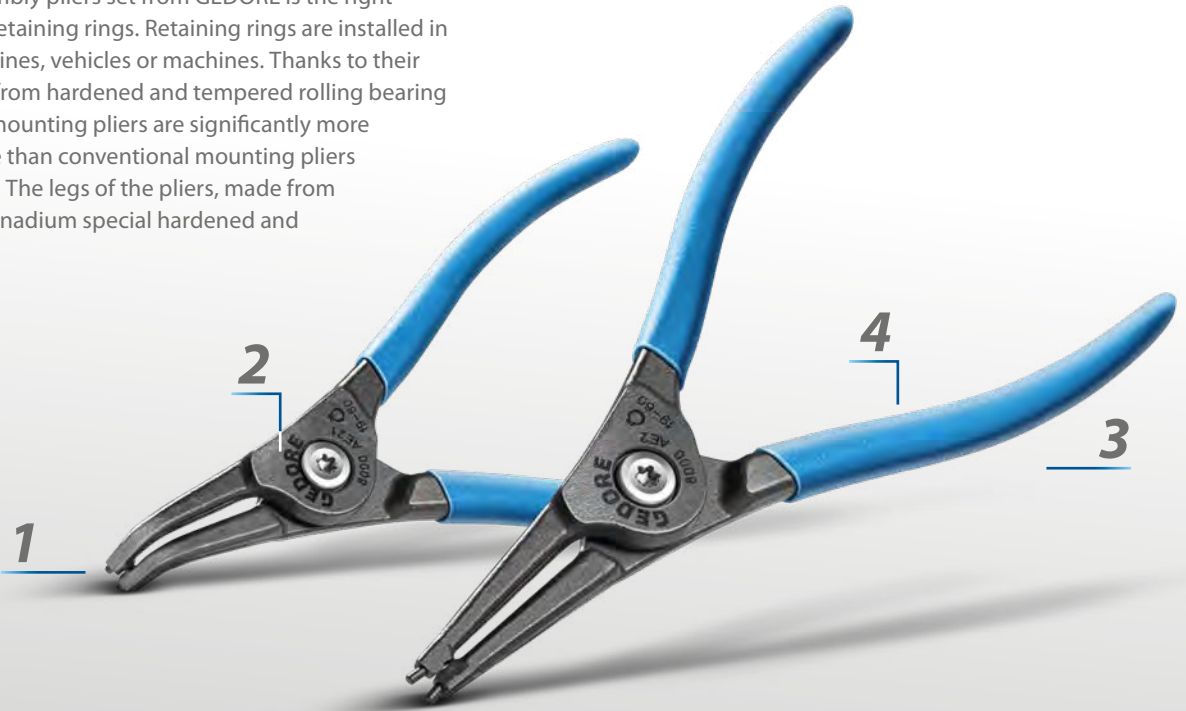

1

BETTER DURABILITY AND LONGER LASTING

- With the help of hardened and tempered and extra inserted tips made of high quality rolling bearing steel, the durability and quality is increased.

2

HIGH PRECISION

- The precise screwed joint allows a quick readjustment of the pliers

3

SAFE WORKING

- The large contact surfaces for the retaining ring also reduce the torsion of the retaining ring, which increases safety when working.

4

FIRM HOLD

- The curved anti-slip handles prevent slipping

TIP - THIS WILL REDUCE THE TORSION OF THE RETAINING RING!

When stowing retaining rings, always ensure that they are installed on the correct side. The "eyes" of retaining rings are punched. Thus, these holes are slightly conical. The narrower side of the eyes

* should rest against the pliers to prevent distortion of the ring.



"The forged specialists for the safe assembly of external and internal retaining rings impress with top GEDORE quality."

S 8000 AE SET OF CIRCLIP PLIERS

4 pieces



- > Popular compilation
- > Indented tips made of highly wear-resistant rolling bearing steel
- > Anti-twist tip geometry
- > Particularly suitable for barely accessible places
- > For external retaining rings
- > With straight and 90° angled tips



Code	No.	Contents	Length mm	Width mm	Depth mm	Pieces	Weight kg
3041980	S 8000 AE	Circlip pliers for external retaining rings, straight Ø 10-25 mm No. 8000 AE 1 Circlip pliers for external retaining rings, straight Ø 19-60 mm No. 8000 AE 2 Circlip pliers for external retaining rings, 90° angled Ø 10-25 mm No. 8000 AE 11 Circlip pliers for external retaining rings, 90° angled Ø 19-60 mm No. 8000 AE 21	315	165	30	4	0,63

VDE 183 10 VDE-PLIER WRENCH



- > Adjustable, universal tool for wrenching work, bending, holding, pressing and gripping
- > Replaces 2 complete wrench sets, metric and imperial (0-50mm and 0-1.7/8") in 21 different SW and pliers
- > Smooth jaws for gentle gripping of surface-sensitive workpieces (e.g. chrome-plated screw connections, bathroom fittings)
- > Function of an open-end ratchet
- > Largest capacity in this class (50mm)
- > Unique functional jaw holder, e.g. for protective jaws
- > 21 setting positions and quick adjustment with automatic engagement function
- > VDE isoliert bis 1000 V, nach EN 60900/IEC 60900, 2-fach Check-Tool-Isolierung
- > DIN ISO 5743/IEC 60900



Code	No.	Size inch	Clamping reach mm	Length mm	Weight kg
3066088	VDE 183 10	10	50	268	0,665

VDE 146 10 VDE UNIVERSAL PLIERS

7 settings



- > Specially tailored to electrical installation requirements
- > With safety box joint and protection against blocking
- > Automatic clamping with offset gripping surfaces
- > teeth additionally inductively hardened
- > GEDORE special chrome-vanadium steel
- > Leg VDE insulated up to 1000 V, according to EN 60900/IEC 60900, immersion insulation: double check tool insulation for safe live working



Code	No.	Length mm	Span mm	Weight kg
6120140	VDE 146 10	250	31	0,485

4 IN 1 - THE GEDORE VDE MULTIPLE PLIERS

VDE-insulated power pack for many tasks: Gripping, cutting, stripping, crimping - and a universal helper for electrical installations.

With their practical multiple function, the VDE 8131 AB-200 H VDE multiple pliers from GEDORE do an excellent job of cutting cables up to \varnothing 12 mm. These pliers allow 1.5 mm² and 2.5 mm² wires to be stripped without any problems. When crimping wire end ferrules, this little powerhouse also shows what it can do. Thanks to its serrated gripping surface, the multifunctional VDE pliers offer a particularly high clamping force.

This means that they can be used very powerfully for installation work, for example. The curved tip of the pliers is easy on the wrists and provides a clear view of the workpiece to be worked on.

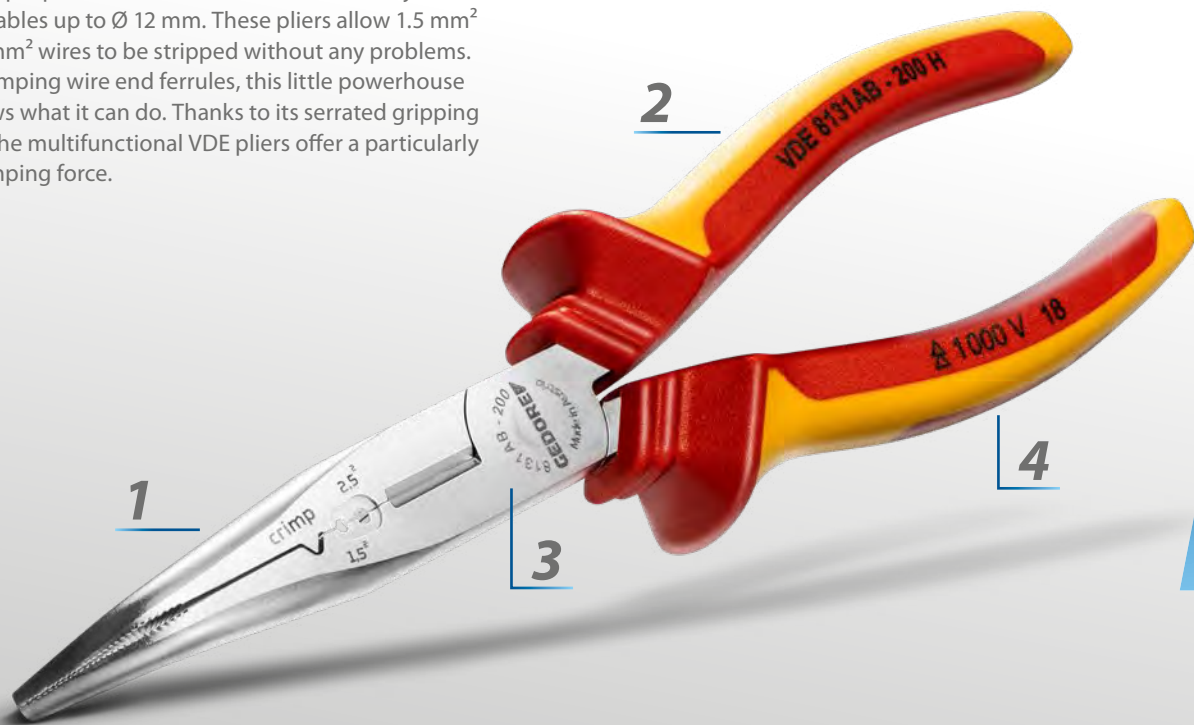

VDE 8131 AB-200 H
VDE MULTIPLE PLIERS
with VDE insulating sleeves, angled pattern

- > Specially tailored to electrical installation requirements
- > Suitable for gripping, bending and holding different materials due to serrated gripping surfaces and angled pliers tip
- > For cutting cables and strands up to 5x2.5 mm² or 12 mm
- > Stripping nests for cables and strands up to 2.5 mm²
- > For crimping conductor end-sleeves
- > For safe and comfortable working under tension due to ergonomic 2-component handles
- > GEDORE special hardened and tempered steel, chrome-plated
- > Insulated up to 1000 V AC acc. to DIN EN/IEC 60900



Code	No.	Total length mm
2910845	VDE 8131 AB-200 H	200

Weight kg
0,217

1

WIDE RANGE OF APPLICATIONS

- The multiple pliers offer the following functions: Cable cutting, stripping, crimping and gripping with the serrated and curved gripping surface

2

SPACE-AVING UNIVERSAL TOOL

- The compact VDE multiple pliers from GEDORE save time, space and weight

3

HIGH INDUSTRIAL QUALITY

- Thanks to GEDORE special hardened and tempered steel, the multiple pliers are suitable for the toughest continuous use

4

MAXIMUM SAFETY

- Thanks to the insulating multi-component handles, you can work comfortably and safely with the VDE multi-purpose pliers.



UNIVERSAL HELPER

"The little GEDORE pliers have done it, they have conquered my heart. Somehow it has now become one of my favourite tools and it's fair to say they not only promise a lot, they deliver. A top product."



VDE 8132-160 H VDE TELEPHONE PLIERS

with sheath insulation, straight

- › Suitable for holding, gripping, bending and cutting work during electrical installation
- › Long, flat-round jaws, straight gripping faces, serrated
- › Induction-hardened precision cutting edges, hardness 61 - 63 HRC
- › Ergonomic 2C handle covers for safe, easy work under voltage
- › GEDORE special hardened and tempered steel, drop-forged, oil-hardened and annealed
- › Handles with VDE insulating sleeves up to 1000 V, acc. to EN 60900/IEC 60900

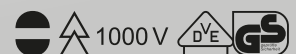
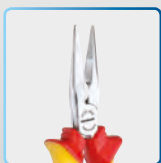

Code	No.	Length mm	Jaw length mm	Head width mm	Centre width mm	Head thickness mm	Tip thickness mm	Weight kg
1552112	VDE 8132-160 H	160	50	16,5	3,2	9,0	2,5	164 g

VDE 8250-180 H
**VDE HEAVY DUTY
 COMBINATION PLIERS,**
 with VDE insulating sleeves



- > For electrical installation work for gripping, holding and bending flat and round material below 1000 V. In addition, the tool is universally applicable for manual and professional craft work
- > With gripping zones for flat and round material, cutting edges for all wires, also piano wire up to 1.6 mm; cutting edge extra hardened, highly resilient, precise pliers jaws, serrated gripping surfaces
- > Good lever action for easy cutting
- > Extra long blades
- > For heavy continuous use
- > For safe and comfortable working under tension due to ergonomic 2-component handles
- > High cutting performance with guaranteed 35% less effort
- > Induction-hardened precision cutting edges, hardness 62 - 64 HRC
- > Inserted joint
- > Leg VDE insulated up to 1000 V, according to EN 60900/IEC 60900
- > GEDORE special hardened and tempered steel, drop-forged, oil-hardened and annealed, chrome-plated

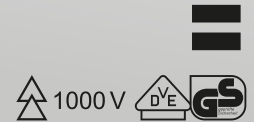

Code	No.	Length mm	Jaw length mm	Head width mm	Tip width mm	Head thickness mm	Weight kg
1550950	VDE 8250-180 H	180	38,5	25,6	6,5	11,0	0,288

VDE 8314-160 H
VDE SIDE CUTTER,
 with VDE insulating sleeves



- > With slim head, ideal for narrow spaces for cutting medium hard wire 1.6 mm and copper/plastic 4 mm
- > Capacity max. 13 mm/5x2.5 mm²
- > Stranded wire up to 16 mm²/AWG5
- > Ergonomic 2C handle covers for safe, easy work under voltage
- > Induction-hardened precision cutting edges, cutting edge hardness 63-65 HRC
- > GEDORE special hardened and tempered steel, chrome-plated
- > Insulated up to 1000V AC according to DIN EN/IEC 60901



Code	No.	Length mm	Jaw length mm	Jaw width mm	Head thickness mm	Ø	Weight kg
1552163	VDE 8314-160 H	160	19	22,0	10,0 mm	1,6	0,231

1102-005 VDE
VDE PLIERS SET
 in L-BOXX® Mini, 3-part



- › Practical set of pliers
- › With Slim PZ screwdriver, VDE multiple nose pliers and VDE Impact diagonal cutter
- › VDE 2162 PZ VDE Screwdriver SLIM DRIVE
- › Ultra-small blade diameter yet with full mechanical and electrical safety
- › VDE 8131 AB VDE Multi-Pliers
- › Cable cutter: enables easy cutting of cables up to 5x2.5 mm² or Ø 12 mm
- › Stripping blades: Stripping option for wires 1.5 mm² and 2.5 mm²
- › Crimping profile: Crimping of ferrules
- › VDE 8314 VDE Side cutters
- › With slender head, ideal for confined spaces
- › In GEDORE L-BOXX® Mini, including one-piece assortment also suitable for storing small items



Code	No.	Contents	Length mm	Width mm	Depth mm	Pieces	Weight kg
2951762	1102-005 VDE	VDE Power side cutters, 180 mm No. VDE 8314-180 H VDE Multi-pliers, 200 mm angled No. VDE 8131 AB-200 JC VDE Screwdriver SLIM DRIVE cross recess No. VDE 2162 PZ 1	157	260	63	3	0,955

VDE 8098-160 H
VDE STRIPPING PLIERS,
 with VDE insulating sleeves



- › V-shaped cutting jaws for stripping the plastic insulation of single- and multi-core conductors
- › Self-opening, with spring and locking screw
- › Easy adjustment to the required wire or strand diameter by means of the set screw and lock nut
- › For wires from 0.8 to 6.0 mm²
- › GEDORE special hardened and tempered steel, drop-forged, oil-hardened and annealed
- › Handles with VDE insulating sleeves up to 1000 V, acc. to EN 60900/IEC 60900



Code	No.	Length mm	Jaw length mm	Head width mm	Head thickness mm	Cable cross-section mm ²	Weight kg
1552074	VDE 8098-160 H	160	43,5	18,5	8,5	0,8-6,0	0,204 kg

EXTRA SLIM BLADE

If a screw is well hidden and cannot be gripped by conventional screwdrivers, the SLIM DRIVE comes into play and impresses with its ultra-slim blade diameter.

The SLIM DRIVE VDE 2162-2172 PZ-06 VDE screwdriver set from GEDORE consists of VDE slotted screwdrivers in sizes 3.5 4 5.5 6.5 and VDE cross-slotted screwdrivers in sizes PZ 1 and 2.

Thanks to the extremely small blade diameter, the screwdrivers in the SLIM Drive series reach screws in deep screw shafts with ease. They are VDE insulated up to 1,000 volts - and meet all the requirements of DIN EN 60900:2013-04 for safe working under

electrical voltage. For precise, fatigue-free work, the SLIM DRIVE screwdrivers are equipped with an ergonomic 3-component Power Grip³. The handle and blade are positively connected to each other, ensuring optimum power transmission.



VDE 2162-2172 PZ-06 VDE SCREWDRIVER SET SLIM DRIVE

6 pieces

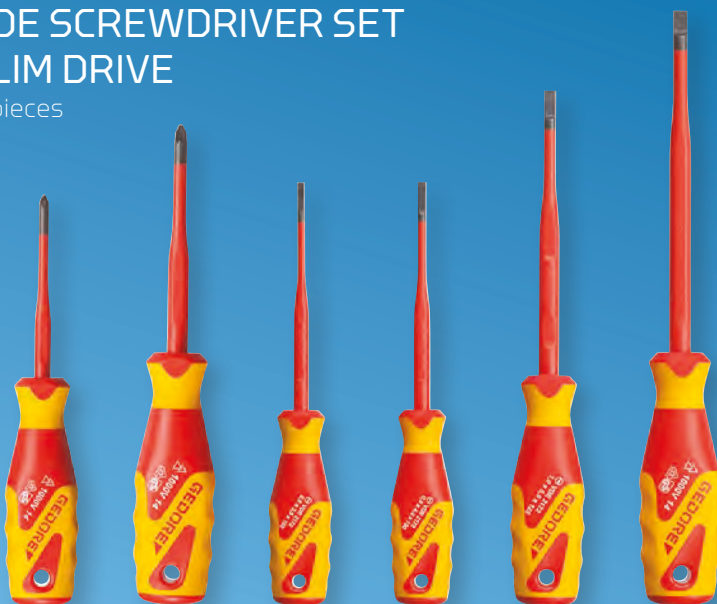

- > Practical set combination of VDE screwdrivers for slotted screws 3.5 4 5.5 6.5, VDE screwdrivers for cross-head screwdrivers PZ 1 and 2
- > SLIM DRIVE: Ultra-small blade diameter with full mechanical and electrical safety
- > No problems in reaching screws deeply embedded in screw shafts
- > Ergonomic handle design enables precise and fatigue-free working
- > Positive-fit joint of handle and blade for optimum transmission of force
- > Insulated up to 1000 V AC, acc. to DIN EN/IEC 60900, fully insulated blade



Code	No.	Contents	Length mm	Pieces	Weight kg
2928728	VDE 2162-2172 PZ-06	VDE Screwdriver SLIM DRIVE slot No. VDE 2172 3,5 4 5,5 6,5 VDE screwdriver SLIM DRIVE cross recess No. VDEVDE 2162 PZ1 2	120	6	0,59

1

INNOVATIVE

- The VDE SLIM DRIVE screwdrivers ensure good and protected access to deep-lying screws thanks to their ultra-small blade diameter.

2

OPTIMAL POWER TRANSMISSION

- The positive connection between the 3-component "Power Grip³" handle and blade ensures high power transmission and torques

3

EXCELLENT ERGONOMICS

- The 3-component handle "Power Grip³" convinces with its perfect ergonomics and ensures an optimal transmission of the hand force.

4

EFFICIENT WORK

- The roll-off protection and the profile symbols at the end of the handle ensure fast and efficient working.

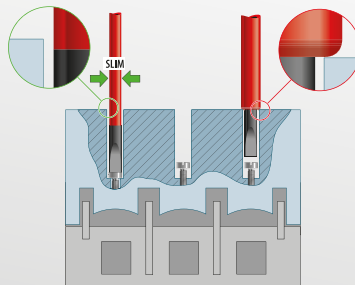

"Accurate fit, sits even if the screw head is not ideal, very good handles with high power transmission."

VDE 2170-2160 PH VDE SCREWDRIVER SET

7 pieces



- › VDE Screwdriver for slotted screws 2.5 4 5.5 6.5, VDE Screwdriver for cross-slotted head screws PH 0 1 2
- › Type of drive and size marked at end of the handle
- › Insulated up to 1000 V AC, acc. to DIN EN/IEC 60900, fully insulated blade
- › Ergonomic handle design enables precise and fatigue-free working
- › Positive-fit joint of handle and blade for optimum transmission of force
- › Blade from GEDORE molybdenum-vanadium-Plus tempered steel

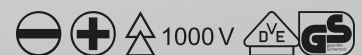

Code	No.	Contents
1616048	VDE 2170-2160 PH-077	VDE Screwdriver slotted no. VDE 2170 2.5 4 5.5 6.5 VDE Screwdriver Cross-recess No. VDE 2160 PH 0 1 2

Pieces	Weight kg
7	0,575

PRECISION UNDER HIGH VOLTAGE

Even under tension, controlled screw tightening is increasingly in demand!

The VDE 4508 VDE torque wrench from GEDORE is perfect for the precise and controlled tightening of screwed connections under tension. The tried-and-tested jump-off system from our Torcofix torque wrenches generates a tactile and audible trigger signal when the set torque value is reached. The mono-scale with N-m graduation enables a 0.10 / 0.25 N-m precise setting of the torque value via the vernier, depending on the model. The accessories such as extensions or inserts are secured against unintentional loosening by a locking button.

The locking knob is easy to operate even with safety gloves. The key comes with a test certificate according to DIN EN ISO 6789-2:2017, exceeding the specification of the standard ($\pm 4\%$) for your safety. The key is VDE insulated up to 1000 V. It meets the requirements according to EN 60900/IEC60900.



1

SECURE LOCKING

- Even when wearing safety gloves, the push-button release prevents unintentional loosening of the socket and is easy to operate.

2

TESTED QUALITY

- The VDE torque wrench is classified according to DIN EN ISO 6789-2:2017 and is supplied with a test certificate. VDE insulated up to 1000 V

3

PRECISE WORKING

- The tolerance of $\pm 3\%$ exceeds the required standard of $\pm 4\%$.

4

SENSIBLE AND AUDIBLE TRIGGER SIGNAL

- Thanks to the high-quality mechanics from the GEDORE Torcofix range, the user receives a tangible and audible signal when the correct torque is triggered.



"VDE torque wrench with proven jump-off system. An ideal and safe helper wherever there is tension."

VDE 4508 VDE TORQUE WRENCH



- > Perfect for electronic technicians, electricians, switch cabinet construction, cable clamping (skilled electricians)
- > Reinforced jump-off system from the Torcofix series generates a tactile and audible trigger signal
- > Scale with an N-m scale division, values can be set to an accuracy of 0.25 N-m
- > Classified according to DIN EN ISO 6789-2:2017 Type II Class A, incl. traceable test certificate, calibrated to a maximum permissible deviation of +/- 3 % and thus more precise than the +/- 4 % required by the standard
- > Recalibration and adjustment without destroying the insulation
- > Fine toothed ratchet with square drive as per DIN 3120, ISO 1174
- > Safety button to protect against accidental release of the insert
- > Large control elements allow adjustment and operation with gloves, ergonomic, durable
- > VDE insulation up to 1000 V, acc. to EN 60900/IEC 60900

Code	No.	Type	Square drive inch	Square drive metric mm	N-m	Height mm	Housing - square centre spacing mm	Length mm	Head width mm	Head height mm	Weight kg
3125335	VDE 4508-02	Rectangular cavity	3/8"	10	5-25	75	24	319	50,0	62	0,714
3079066	VDE 4508-05	Rectangular cavity	1/2"	12,5	10-50	80	24	369	48,0	62	0,825

1100-1094 VDE TOOL ASSORTMENT HYBRID

in GEDORE L-BOXX® 136, 53 pieces

- > The perfect range of tools for repair and maintenance work on hybrid and electric vehicles
- > Suitable for vehicles of all manufacturers
- > All tools insulated according to EN 60900/EC 60900
- > GEDORE L-BOXX® 136 compatible with the Sortimo® in-vehicle equipment in your service mobile



Code	No.	Contents	Length mm	Width mm	Depth mm	Pieces	Weight kg
2979063	1100-1094	3/8" VDE socket wrench insert No. VDE 30, SW 6 8 9 10 11 12 13 14 15 16 17 18 19 20 22 mm 3/8" VDE screwdriver bit socket No. VDE INX 30, SW 8 10 12 mm 3/8" VDE extension No. VDE 3090 -3 -6, 75 150 mm 3/8" VDE reversible ratchet No. VDE 3093 U VDE Screwdriver slot No. VDE 2170, 2.5 3.5 4 5.5 mm VDE Screwdriver Cross-recess No. VDE 2160 PH 1 2 3 VDE Screwdriver TX No. VDE 2163 TX T20 T25 T30 VDE cable cutter No. VDE 8094, 200 mm VDE Universal pliers No. VDE 146 10, 10". VDE Power combination pliers No. VDE 8250-200 H, 200 mm 2-component handle VDE Power side cutter No. VDE 8314-180 H, 180 mm VDE Flat nose pliers No. VDE 8132 AB-200 JC, 200 mm angled 2-component handle VDE Flat nose pliers No. VDE 8120-160 H, 160 mm 2-component handle VDE cable knife No. VDE 4522, 180 mm Counter sleeve No. V 914, size 1 2 3	357	442	151	53	8,28

905 CREEPER



- › The stable assembly/workshop couch is a good helper wherever work has to be done lying down
- › Due to the 6 ball bearing 360° rollers and the low installation height, the workshop couch can easily be rolled into narrow and inaccessible working areas
- › Suitable for repair and maintenance activities under any type of vehicle without having to jack it up, as well as machines in industry, automotive, agriculture or even at home
- › Comfortable lying position due to the ergonomically shaped and pleasantly structured surface of the stable plastic body
- › High-grade and durable castors
- › Practical storage and handle recesses
- › Made of skin-friendly PP (polypropylene) - resistant to oils, greases and brake fluid
- › The ergonomically shaped lying surface prevents back pain and tension and the left and right shelves ensure that tools are always at hand
- › Load capacity 130 kg

Code	No.	Length mm	Height mm	Width mm	Weight kg
1823698	905	1.000	115	480	5

900 20 LAMP LED LI-MH USB CHARGING CONNECTION



- › Versatile deployable LED/UV lamp of a slim design with extra functions
- › In particular for the automotive and industrial fields but also for a variety of uses in leisure-time pursuits
- › Continuously dimmable and switchable in blue-violet from LED to UV light (for tracking leaks.g. in air-conditioners and heat pumps).
- › Swing-out hooks on both sides, strong magnet at the 45° adjustable foot and strong tip mini-magnet for bringing up lost incidental parts where space is at a premium
- › Charging either via the supplied power pack or a USB interface
- › 620 lumen



Code	No.	Length mm	Height mm	Width mm	Weight kg
3108678	900 20	477	40	50	0,295

906 KNEELING BOARD

- › Made of solid foam, blue/black
- › With recessed grip

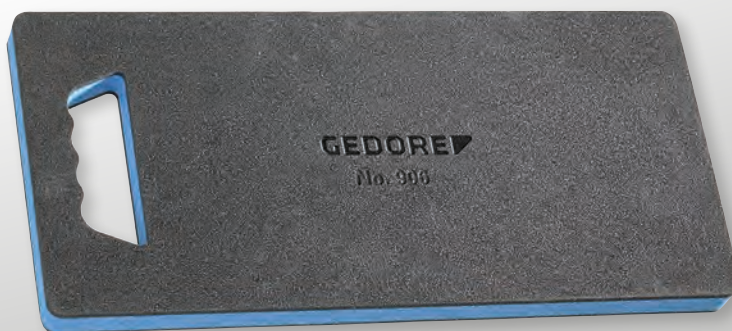

Code	No.	Length mm	Height mm	Width mm	Weight kg
1942948	906	450	30	210	0,11

36 2-200 STRAP WRENCH

- › For round screw connections
- › Strong and non-slip fabric tape for optimum grip
- › Body chrome-plated
- › Spare fabric tape E-36-2-200

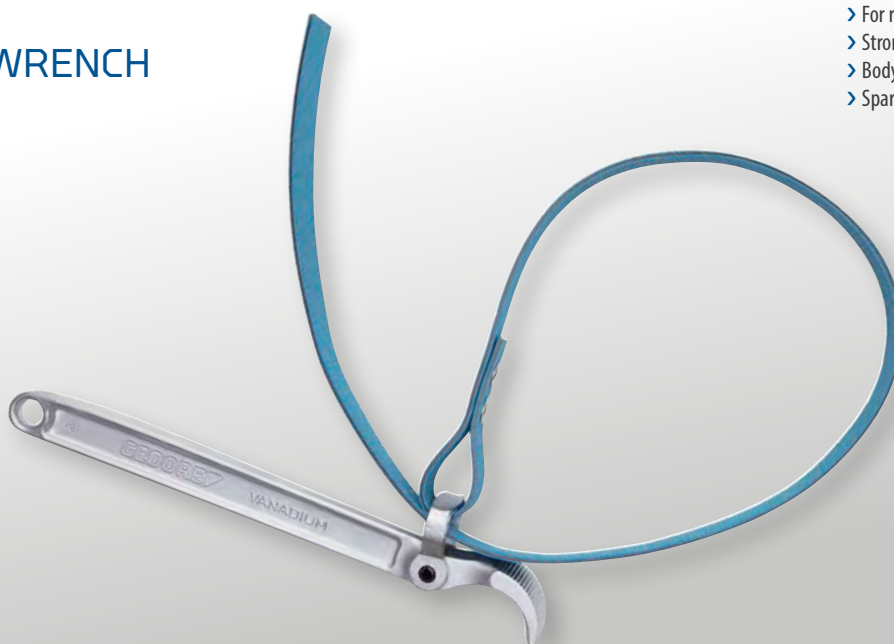

Code	No.	for Ø mm	for Ø inch	Total length mm	Bandwidth mm	Weight kg
6327400	36 2-200	200	8"	285	25	0,578

640-1800 MAGNETIC LIFTER

- › For picking up and holding small magnetic parts
- › Easy handling due to flexible shaft
- › For picking up components in blind holes
- › Easy handling due to flexible shaft
- › For picking up components in blind holes



Code	No.	Total length mm	Magnet diameter	Magnetic lifting force g	Weight kg
6531280	640-1800	520	12,0	1.800	0,23 kg

702 13 M FEELER GAUGE SET, FAN PATTERN



- › Serves to check a gap dimension for small dimensions
- › Spring steel leaf with clear inscription
- › With protective handle, folding, blade length 100 mm
- › Tongue-shaped tapered steel blades, collapsible by rivet joint
- › Handle nickel-plated

Code	No.	Content	Weight kg
6547790	702 13 M	5 10 15 20 25 30 40 50 60 70 80 90 100/100	0,065

133 K GASKET SCRAPER



- › Used for the removal of gasket residues, for example on cylinder head, valve cover and carburettor cover gaskets and many other gaskets
- › 3-component handle Power-Grip³ with hanging hole
- › Ergonomic handle design enables precise and fatigue-free working
- › Tempered blade with high wear resistance

Code	No.	Total length inch	Total length mm	Blade width mm	Weight kg
6535190	133 K	10"	240	22,5	0,154

S 141-3 PRYBAR SET

3 pieces



- › Practical set composition in environmentally-friendly cardboard box
- › Vanadium steel, chromated
- › Carefully hardened along the full length
- › Ergonomic PVC handle
- › Very robust and resilient

Code	No.	Contents	Pieces	Weight kg
1525476	S 141-3	300 390 600 mm	3	1,474

140 THREAD FILE

- › Thread file for internal and external threads, for repairing damaged threads
- › Optimum cutting angle for extremely effective thread machining
- › Chrome-vanadium steel, ISO-nickel coated, high durability/long service life thanks to tempering



Code	No.	for thread pitches mm	Total length mm	Weight kg
6409640	140	0,80 1,00 1,25 1,50 1,75 2,00 2,50 3,00 mm	230 mm	0,125 kg

8719 2-8 TRIANGULAR FILE

- › For filing breakthroughs and deburring
- › The tapered, triangular file with cross cut cut 2 can be used for universal roughing and finishing work
- › With PVC handle
- › Acc. to DIN 7261 Form C

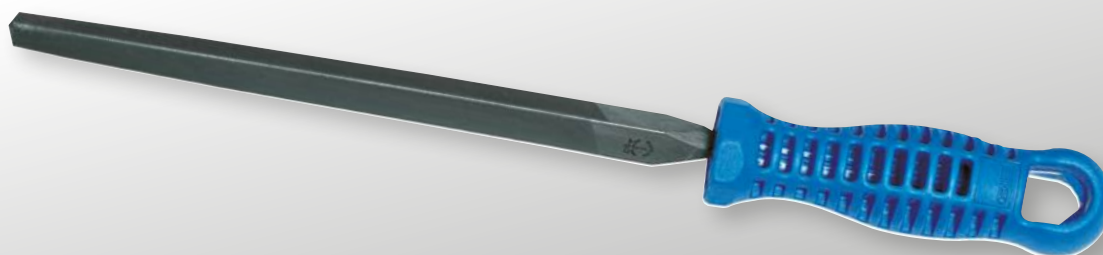

Code	No.	Total length mm	Total length inch	Width mm	Chop	Weight kg
6769340	8719 2-8	200	8"	14	2	0,177

8722 2-8 ROUND FILE

- › The round file is particularly suitable for machining radii, filing breakthroughs and deburring
- › The round file with cross cut stroke stroke 2 can be used for roughing or for rough cutting
- › With PVC handle
- › Acc. to DIN 7261 Form F

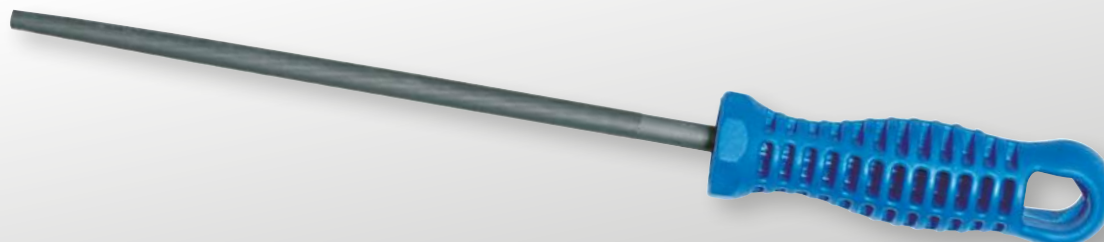

Code	No.	Ø	Total length mm	Total length inch	Chop	Weight kg
6770190	8722 2-8	7,5	200	8"	2	0,112

8725 2-8
**SEMICIRCULAR
 WORKSHOP FILE**

- > The semicircular file is particularly suitable for machining radii, filing breakthroughs and deburring
- > The semicircular file with cross cut cut 2 can be used for universal roughing and finishing work
- > With PVC handle
- > Acc. to DIN 7261 Form E



Code	No.	Total length mm	Total length inch	Width mm	Chop	Weight kg
6770430	8725 2-8	200	8"	20	2	0,17

231000
**MINIATURE PIPE CUTTER
 MINI-QUICK**

- > Particularly suitable for copper, brass, light metal, precision steel and hydraulic pipes in hard-to-reach areas
- > Cutting wheel for stainless steel tubes No. 230411 can be used
- > Zinc die-cast body



Code	No.	Pipe Ø (min./ max.) mm	Wall thickness mm	Total length mm	Weight kg
4504560	231000	4-16	0,7-3,0	50	0,125

8552-025
THREAD EXTRACTOR SET
 25 pieces

- > For extracting broken screws and bolts with threads M5 - M16
- > In handy plastic case, with twist drills, guide sleeves, extractor pins and extractor nuts



Code	No.	Contents	Length mm	Width mm	Depth mm	Pieces	Weight kg
6755550	8552-025	Extracting pins size 1" 2" 3" 4" 5 Drill sleeves size 1" 2" 3" 4" 5" 6" 7" 8" 9" 10" Extraction nuts 10" 11" 13" 14" 17 mm Drill 8.7-11/32" 8-5/16" 6.4-1/4" 4.8-3/16" 3.2-1/8" Drill	120	200	38	25	0,79

241500 PIPE BENDING PLIERS

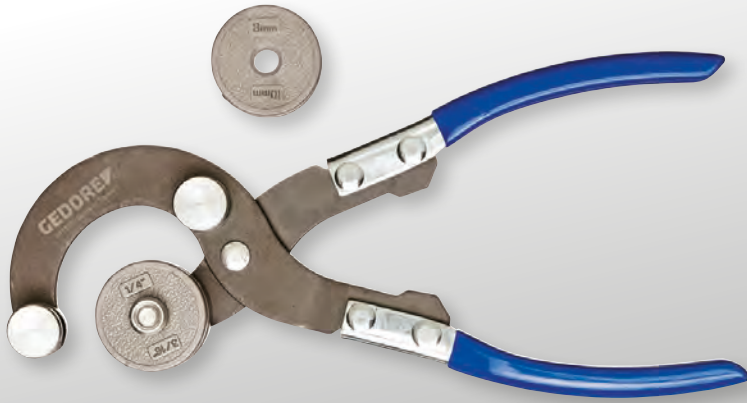

- › Pipe bending pliers for kink-free bending up to 90° of soft copper pipes (DIN EN1057), non-ferrous metal pipes, thin-walled precision pipes and brake line pipes
- › Flexible pliers for automotive, hydraulic and air conditioning applications thanks to four different sizes on 2 interchangeable bending rollers: 3/16" - 1/4" Ø (4.75 - 6 mm Ø) and 8 - 10 mm Ø, easy roller change by screwing on and tightening the nut
- › Precise, dimensionally stable and accurately fitting bending without upsetting or squeezing thanks to precise guidance through the bending roller, easy removal of the workpiece after bending

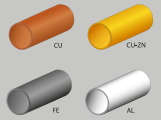

Code	No.	Pipe Ø (min./ max.) mm	Pipe Ø (min./ max.) inch	Total length mm	Weight kg
1442007	241500	4,75-10,0	3/16-3/8"	260	0,58

8551 S-005 BOLT-EXTRACTOR-SET

5 pieces



- › Robust screw extractors for easy removal of broken screws, threaded bolts and pipe ends
- › Alternative to drilling out, ideal in conjunction with separately available tool holder with ratchet from GEDORE (Art. No. 8551 TG)
- › Reduced boring torques due to improved cross-section geometry, reduced drilling depth thanks to optimised thread length
- › High quality chrome vanadium steel with 54-56 HRC, for thread M3-M18, incl. plastic box for safe storage

Code	No.	Contents	Length mm	Pieces	Weight kg
2659336	8551 S-005	M3-M6 M6-M8 M8-M11 M11-M14 M14-M18	230	5	0,125

245610 MANUAL BENDING TOOL SET

hydraulic, 9 parts



- › Ideally suited for soft copper pipes EN 1057 up to 22 mm (also heat-insulated), multi-layer composite pipes up to 20 mm and precision steel pipes EN 10305-3 (DIN 2394) up to 18 x 1.5 mm
- › Hydraulic drive without great effort
- › With 7 bending formers for pipes with Ø 10, 12, 14, 15, 18, 20 and 22 mm and corresponding counter-supports
- › Hydraulic drive without great effort

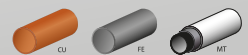

Code	No.	Contents	Pieces	Weight kg
4635230	245610	1 base unit, hydraulic no. 245670 7 bending tools for pipes with Ø 10, 12, 14, 15, 18, 20, 22 mm 1 plastic case no. 245590	9	5,87

407 HACKSAW



- › For severing metals and steel
- › Versatile and robust die-cast aluminium hacksaw with adjustable blade
- › To best serve the intended purpose, the saw blade can be used both vertically and at a 45° angle
- › Practical, tool-free clamping function of the saw blade due to blue clamping element in the handle
- › Captive dowel pins fix the saw blade
- › The combination of lightweight aluminium bracket and a soft angled handle ensure ergonomic working and durability
- › Bimetal saw blade 407 A

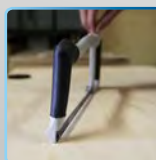

Code	No.	Designation
1879375	407	Hacksaw

Weight kg
0,66

278600 MANUAL BENDING TOOL SET

3 pieces

- › Ideally suited for precision steel tubes EN 10305-3 (DIN 2394), hydraulic tubes EN 10305-1 (DIN 2391) with wall thicknesses of 1.0 - 2.0 mm, multi-layer composite tubes up to 16 mm and bendable stainless steel tubes with wall thicknesses of 1.0 - 1.5 mm
- › For clamping in a vice
- › Painted blue, with black plastic handle



Code	No.	Contents
1589857	278600	1 basic tool body 6-18 mm no. 2786701 bending lever 6-18 mm no. 278681 8 aluminium bending formers for pipes with Ø 6-8, 10-12, 14, 15, 16, 18 mm

Pieces 3
Weight kg 5,26

SB 6952-00 RESCUE KNIFE

- › For assured cutting, severing and dissecting a wide range of materials
- › High-grade, universal jack knife with extra belt cutter and glass shatterer
- › All-purpose helper in the car, at home, in the garden and workshop
- › Tempered blade with partial serration
- › Black blade, blue handle protectors

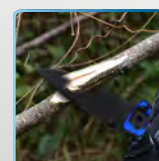

Code	No.	Blade length mm	Total length mm
3100464	SB 6952-00	85	203 mm

Weight kg
0,2

226100 SHEAR SET FOR PLASTIC PIPES



- › To cleanly cut hard and soft plastic pipes, rubber hoses with or without textile reinforcement, and as well as various plastic profiled sections, such as cable ducts, for example
- › Contains 2 form blocks for 16, 19 and 25 mm pipes, 1 prism for profiles and 1 angle stop adjustable up to 45°
- › Delivery in plastic case

Code	No.	Length mm	Width mm	Depth mm	Weight kg
1637983	226100	320	255	60	1,05

2268 3 PIPE SHEARS



- › For the clean cutting of PE, PP, PEX, PPR, MSR, CPVC, PVC, PVDF, PB and VPE pipes
- › Can also be used for hoses
- › Smooth and accurate cutting, one hand operation
- › Cutting blades changeable without tools
- › Body in pressure-cast magnesium

Code	No.	For pipe-Ø	Total length mm	Weight kg
2963892	2268 3	63	280	0,65

2180 PIPE CUTTER



- › Pipe cutter suitable for stainless steel pipes
- › Easy cutting due to ball-bearing pressure rollers and cutting wheels
- › Cutting wheel changeable without tools
- › With retractable deburring tool
- › Cutting wheel with high service life
- › No. 2180 3 and 2180 4 Body in die-cast magnesium, No. 2180 5 Body in die-cast aluminium
- › No. 2180 5 with quick adjustment

Code	No.	Pipe Ø (min./ max.) mm	Wall thickness mm	Total length mm	Weight kg
2964066	2180 3	3-35	0,7-2,5	160	0,365
2964074	2180 4	3-45	0,7-2,5	180	0,39
2964082	2180 5	6-76	0,7-2,5	245	0,94

GEDORE

TOOLS FOR LIFE

GEDORE Werkzeugfabrik GmbH & Co. KG

Remscheider Straße 149
42899 Remscheid · GERMANY
Tel. + 49 (0) 21 91-596-0
Fax + 49 (0) 21 91-596-230
info@gedore.com
www.gedore.com

Vertrieb Deutschland

Tel. + 49 (0) 21 91-596-900
Fax + 49 (0) 21 91-596-999

GEDORE Automotive GmbH

Breslauer Straße 41
78166 Donaueschingen · GERMANY
Tel. +49 771 83223-0
Fax +49 771 83223-90

GEDORE Torque Solutions GmbH

Bertha-Benz-Straße 12
71665 Vaihingen/Enz · GERMANY
T +49 7042 9441-0
F +49 7042 9441-41
info@loesomat.de

GEDORE AUSTRIA GmbH

Gedore-Str. 1
8190 Birkfeld / Stmk. · AUSTRIA
Tel. +43 (0) 3174 / 363 64 00
Fax +43 (0) 3174 / 363 83 20
sales.austria@gedore.com
www.gedore.at

GEDORE Tools S.A. (Pty) Ltd.

103 Qashana Khuzwayo (Shepstone) Road,
New Germany, 3610 - South Africa
PO Box 68, New Germany, 3620
SOUTH AFRICA
Tel. +27 (0) 31 / 705 3587
Fax +27 (0) 31 / 705 32770
general@gedoresa.co.za
www.gedore.co.za

GEDORE IBÉRICA S.L.

c/Arangutxi 12, Poligono Industrial de Júndiz
01015 Vitoria Alava · SPAIN
Tel. +34-945-29 22 62
Fax +34-945-29 21 99
gedore@gedore.es
www.gedore.es

GEDORE UK Limited

Marston Street, SKIPTON BD23 1TF
North Yorkshire · UNITED KINGDOM
Tel. +44 (0) 1756 / 70 67 00
Fax +44 (0) 1756 / 79 80 83
sales@gedoreuk.com
www.gedoreuk.com

GEDORE France SARL

Parc d'activités des Béthunes - La Mare II
10, avenue du Fief - Bât. 12
BP 79144 Saint-Ouen-l'Aumône
F-95074 Cergy Pontoise Cedex · FRANCE
Tél. +33 (0) 1 34 40 16 60
Fax +33 (0) 1 34 40 16 61
jadore@gedore.fr
www.gedore.fr

GEDORE TECHNAG B.V.

Flemingweg 7, 2408 AV
Alphen aan den Rijn · NETHERLANDS
Tel. +31 (0) 172 / 42 73 50
Fax +31 (0) 172 / 42 73 60
technag@gedore.nl
www.gedore.nl

GEDORE (INDIA) Private Limited

148, Sector 3, IMT Manesar
Gurgaon - 122051
Haryana · INDIA
Tel. +91 (0) 124 22910 - 65/66/67
Fax +91 124 2341067
sales@gedoreindia.com
www.gedore.in

GEDORE POLSKA Sp. z o.o.

ul. Żwirki i Wigury 56a
43-190 Mikołów · POLAND
Tel. +48 (0) 32 / 738-40 10
Fax +48 (0) 32 / 738-40 20
gedore@gedore.pl
www.gedore.pl

Ferramentas GEDORE do Brasil S.A.

Rua Vicentina Maria Fidélis, 275 Bairro
Vicentina | Vicentina
São Leopoldo - RS | 93025-340 · BRAZIL
Tel. +55 51-35 89 9200
Fax + 55 51-35 89 9222
export@gedore.com.br
www.gedore.com.br

GEDORE TOOLS, INC.

7187 Bryhawke Circle, Suite 700
NORTH CHARLESTON,
SC 29418 · USA
Tel. +1-843/225 50 15
Fax +1-843/225 50 20
info@gedoretools.com
www.gedoretools.com

GEDORE Tool Trading (Shanghai) Co., Ltd.

1/F., Block 2, 1358 Pingan Road,
Minhang, Shanghai · CHINA 201109
Tel. +86-21-3388 7258
Fax +86-21-3388 7259
Service Hotline: 400 880 1858
info@gedore.cn
www.gedore.cn



Your dealer:

Где купить:

ООО "КОМПАНИЯ ОПТУЛС"

г.Москва, ул.Иловайская, д.3, стр.2

Tel.: +7 (495) 646-00-96

E-Mail: sale@opttools.ru

Internet: www.opttools.ru

Brands of the GEDORE Group

gedore.com · ochsenkopf.com

MAGIC 2021 TOOL PROMOTION valid
from 01/04/2021 until 31/03/2022.
While stocks last.

Delivery without decoration. Technical specifications subject to modifications.
No liability for printing errors. Please ask your local dealer.

gedore.com