



RIMO

**20
25**

CATALOGUE



MORE THAN **95**

YEARS OF HISTORY IS JUST THE BEGINNING

Everything started back in the 30's in a small village in the Basque Country of Northern Spain. We used to manufacture cart axles and mill balls for cement factories. Decade after decade, we forged our innovative heritage by launching tools such as the side nut adjustable wrench, often imitated over the years.

Today, we keep our commitment to continuous improvement adapting to the needs of professionals who appreciate their toolbox.

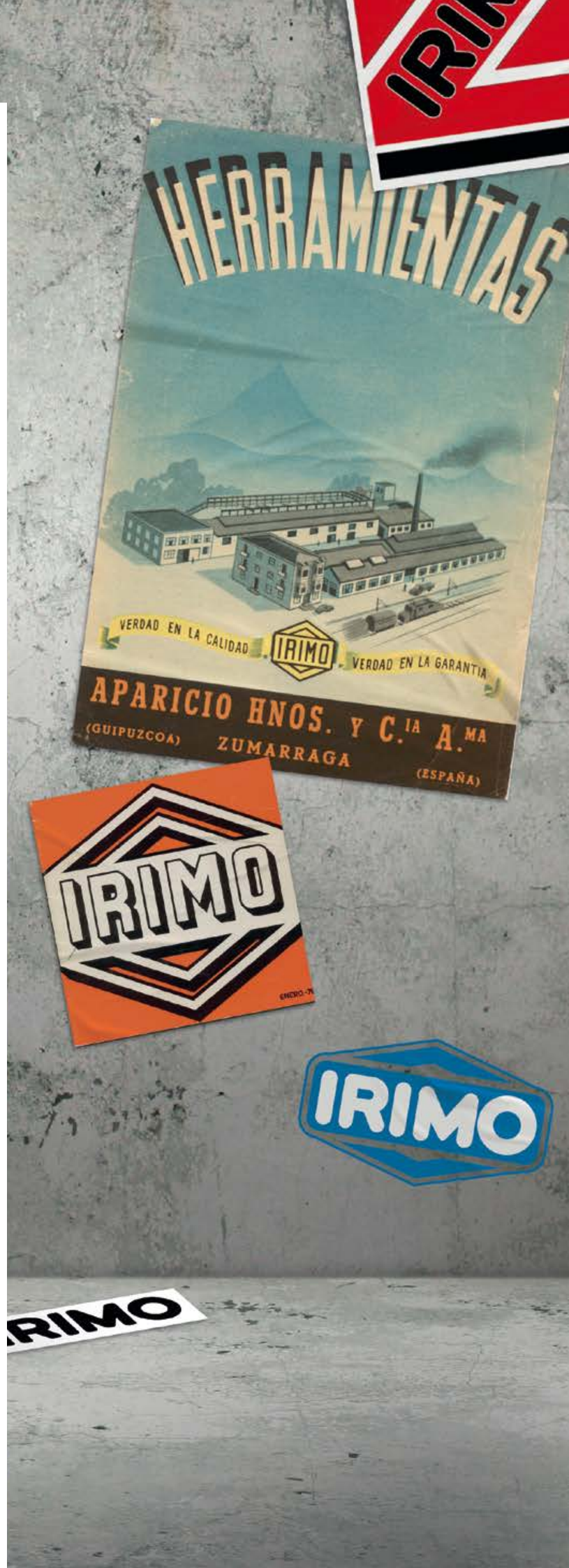

THE ORIGIN IS IMPORTANT DESTINY IS EVEN MORE

WE WANT TO BE WHERE YOU NEED US.
THUS, OUR PRESENCE IS WIDENING EVERYDAY.



 ARGENTINA

 GERMANY

 PORTUGAL

 AUSTRALIA & NZ

 GREECE

 SERBIA

 BELGIUM

 ITALY

 SPAIN

 CHILE

 MEXICO

 SWEDEN

 DENMARK

 NORWAY

 SWITZERLAND

 FINLAND

 PERU

 THE NETHERLANDS

 FRANCE

 POLAND

 TURKEY

VISIT OUR NEW WEBSITE

WWW.IRIMO.COM

- EVERYTHING YOU NEED TO KNOW FROM US ■
- SELF EXPLANATORY PICTURES ■
- COMPLETE INFORMATION ABOUT NEW PRODUCTS ■
- DOWNLOAD PDF OF EACH PRODUCT ■
- SOCIAL MEDIA FEED ■
- WHERE TO BUY ■

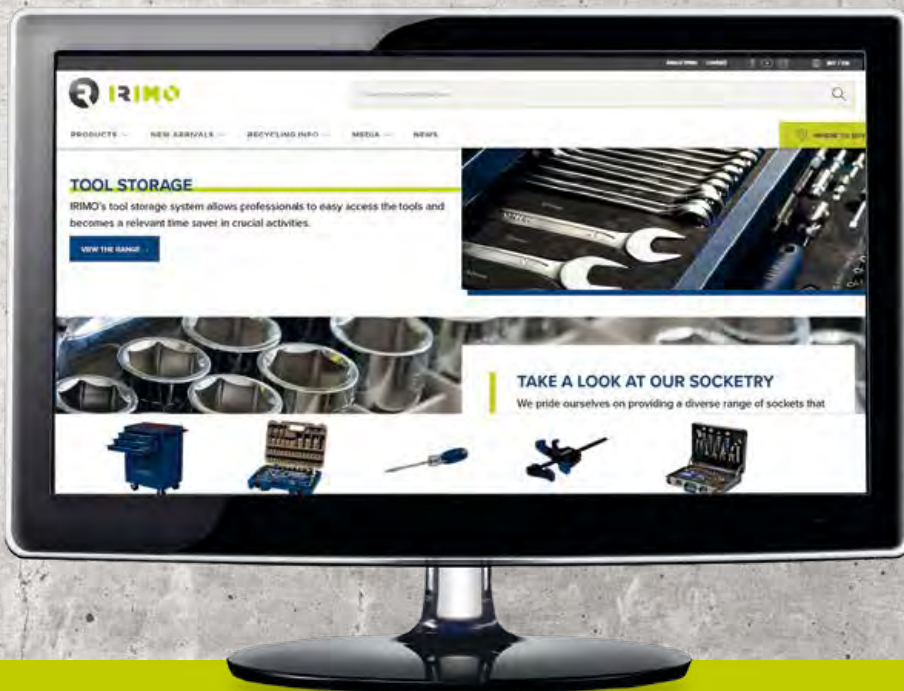

- INDEX 4 - 12
- ALPHANUMERICAL INDEX 194 - 207
- WARRANTY 213

TOOL INDEX

01. TOOL STORAGE

13



02. WRENCHES

35



04. SOCKETRY

55



03. TORQUE TOOLS

51



05. CLAMPING TOOLS

85



06. PIPE TOOLS

93





01. TOOL STORAGE	13-33	02. WRENCHES	35-49
TOOL TROLLEYS	14-17	ADJUSTABLE WRENCHES	36-37
5 DRAWER TOOL TROLLEY	14	HEAVY DUTY ADJUSTABLE WRENCH	36
6 DRAWER TOOL TROLLEY	14	CENTRAL NUT	37
7 DRAWER TOOL TROLLEY	14	PHOSPHATED ADJUSTABLE WRENCH SET	37
4 DRAWER TOP CHEST	14	OPEN END WRENCHES	38-39
TROLLEY 6 DRAWERS WITH FOAM AND TOOLS	15-16	DOUBLE OPEN END WRENCHES	38
TROLLEY 7 DRAWERS WITH FOAM AND TOOLS	17	DOUBLE OPEN END WRENCH SETS	39
TROLLEY FOAMS 3/3 SYSTEM	18-20	COMBINATION WRENCHES	40-41
TROLLEY FOAMS 1/3 SYSTEM	20-23	COMBINATION WRENCHES IN MM	40
TOOL TROLLEYS	24-25	COMBINATION WRENCHES IN INCHES	41
3 TOOL BOXES TOWER ON WHEELS	24	COMBINATION WRENCH SETS	41
TOWER 3 IN 1 WITH FOAM AND TOOLS	24	RATCHETING COMBINATION WRENCHES	42-44
2 TRAYS ROLL CART	25	RATCHETING COMBINATION WRENCHES	42
TRANSPORTERS	25	RATCHETING COMBINATION WRENCH SETS	42
FOLDABLE TRANSPORTER	25	STUBBY RATCHETING COMBINATION WRENCHES	43
TRANSPORTER	25	STUBBY RATCHETING COMBINATION WRENCH SET	43
WORKBENCH	26-27	RATCHETING DOUBLE RING WRENCH SET	43
HEAVY DUTY STEEL WORKBENCH WITH 4-LEG	26	FLEX HEAD RATCHETING COMBINATION WRENCHES	43
FOLDABLE WORKBENCH	27	FLEX HEAD RATCHETING COMBINATION WRENCH SETS	44
METALLIC TOOL BOXES	27-28	FLAT RING WRENCHES	44
TWO HANDLE MODEL	27	DOUBLE RING END WRENCHES	44
ALUMINIUM TOOL CASE WITH TOOLS	28	DOUBLE RING END WRENCHES SETS	44
FABRIC BAGS	29-30	OFFSET RING WRENCHES	45
TOOL BAG WITH TUBULAR HANDLE	29	DOUBLE OFFSET RING WRENCHES	45
TOOL BAG WITH ZIP	29	DOUBLE OFFSET RING WRENCH SETS	45
LAPTOP AND TOOL BACK-PACK	30	L-PIPE DOUBLE SOCKET WRENCHES	46
BACK-PACK WITH WHEELS	30	L-PIPE DOUBLE SOCKET WRENCHES	46
POUCHES, BELTS AND FOLDERS	31-33	L-PIPE DOUBLE SOCKET WRENCH SETS	46
FOLDER – EMPTY	31	TUBULAR SOLID WRENCHES	47
FOLDER – WITH 28 TOOLS	31	DOUBLE HEAD SOCKET WRENCHES	47
HAMMER HOLDER	31	DOUBLE HEAD SOCKET WRENCH SETS	47
STRIKING SET	31	BAR HANDLE FOR SOCKET WRENCH	47
PLIER POUCH	32	SLOGGING RING, OPEN END	48
ELECTRICIAN 4 PIECES SET IN POUCH	32	RING END SLOGGING WRENCH	48
TOOL POUCH	32	OPEN END SLOGGING WRENCH	48
MRO 7 PIECES SET IN POUCH	32	HOOK WRENCHES	49
INSULATED 7 PIECES SET IN POUCH	32	HOOK WRENCH	49
10 POCKETS TOOL POUCH	33	HOOK WRENCH WITH INTERCHANGEABLE PIN	49
MRO 9 PIECES SET IN POUCH	33	SPARE PART - INTERCHANGEABLE PIN	49
ADJUSTABLE BLET	33		

MULTIFITTING KEY	49
7 IN 1 UNIVERSAL KEY	49
9 IN 1 UNIVERSAL KEY	49
03. TORQUE TOOLS	51-53
TORQUE WRENCHES	52-53
ADJUSTABLE CLICK WRENCH WITH FIXED RATCHET HEADS	52
ADJUSTABLE CLICK WRENCH WITH INTERCHANGEABLE HEADS	52
9x12 MM OPEN END INSERTS	52
9x12 MM RING END INSERTS	52
9x12 & 14x18 MM RATCHET HEAD INSERTS	53
14x18 MM OPEN END INSERTS	53
14x18 MM RING END INSERTS	53
04. SOCKETRY	55-84
1/4" SOCKETS	56-61
1/4" HEXAGONAL SOCKETS	56
1/4" DEEP HEXAGONAL SOCKETS	56
1/4" TORX® SOCKETS	56
1/4" BIT DRIVERS	57
1/4" ACCESSORIES	58-59
1/4" SOCKET SETS	60-61
3/8" SOCKETS	61-63
3/8" HEXAGONAL SOCKETS	61
3/8" DEEP HEXAGONAL SOCKETS	61
3/8" ACCESSORIES	62-63
3/8" SOCKET SET	63
1/2" SOCKETS	64-74
1/2" HEXAGONAL SOCKETS	64
1/2" BIHEXAGONAL SOCKETS	64
1/2" HEXAGONAL DEEP SOCKETS	65
1/2" BIHEXAGONAL DEEP SOCKETS	65
1/2" TORX® SOCKETS	65
1/2" BIT DRIVERS	66-67
1/2" ACCESSORIES	67-69
1/2" SOCKET SETS	70-74
3/4" SOCKETS	74-77
3/4" HEXAGONAL SOCKETS	74
3/4" BIHEXAGONAL SOCKETS	75

3/4" ACCESSORIES	75-76
3/4" SOCKET SETS	76-77
3/8" IMPACT SOCKETS	77-78
3/8" IMPACT HEXAGONAL SOCKETS, METRIC	77
3/8" IMPACT HEXAGONAL SOCKETS, LONG SERIES, METRIC	77
3/8" IMPACT ACCESSORIES	78
1/2" IMPACT SOCKETS	79-81
1/2" IMPACT HEXAGONAL SOCKETS, METRIC	79
1/2" IMPACT HEXAGONAL SOCKETS, LONG SERIES, METRIC	79
1/2" IMPACT SOCKET SET	79-80
1/2" IMPACT ACCESSORIES	81
3/4" IMPACT SOCKETS	82-83
3/4" IMPACT HEXAGONAL SOCKETS, METRIC	82
3/4" IMPACT SOCKET SET	82
3/4" IMPACT HEXAGONAL SOCKETS, LONG SERIES, METRIC	82
3/4" IMPACT ACCESSORIES	82-83
1" IMPACT SOCKETS	83-84
1" IMPACT HEXAGONAL SOCKETS, METRIC	83
1" IMPACT SOCKET SET	83
1" IMPACT HEXAGONAL SOCKETS, LONG SERIES, METRIC	84
1" IMPACT ACCESSORIES	84

05. CLAMPING TOOLS	85-91
BENCH VICES	86-87
ROUND GUIDE VICE	86
SQUARE GUIDE VICE	86-87
SPARE PARTS FOR BENCH VICES	87-88
ACCESSORIES FOR BENCH VICES	88-89
TABLE VICE	89
SCREW CLAMPS	90-91
FORGED WOODEN HANDLE F-CLAMP	90
STEEL CLAMP, 90 MM	90
STEEL T-HANDLE CLAMP, 120 MM	90
NON-SLIP BRAKING MECHANISM CLAMP, 150 MM	90
LIGHT SCREW CLAMP, 70 MM	90
FORGED RATCHETING F-CLAMP	91
QUICK CLAMPS	91

**06. PIPE TOOLS 93-97****STILLSON WRENCHES 94**

STILLSON WRENCH 94

ALUMINIUM WRENCH 94

CHAIN PIPE WRENCH 95

CHAIN PIPE WRENCH 95

SPARE CHAIN 95

PIPE WRENCHES SWEDISH MODEL 95

CORNER MOUTH 95

PERPENDICULAR MOUTH 95

CURVED MOUTH 95

PIPE CUTTERS 96

SMALL COPPER PIPE CUTTER 96

MULTIPURPOSE PIPE CUTTER 96

TELESCOPIC COPPER PIPE CUTTER 96

STEEL PIPE CUTTER 96

SPARE WHEELS 96

AUTO RETRACT PLASTIC TUBE CUTTER 96

SPARE BLADE 96

GASKET CUTTERS 97

GASKET CUTTERS SETS 97

GASKET CUTTERS 97

WAD PUNCHES 3 - 30 HANDLE 97

REVOLVER WAD PUNCHES 97

07. SCREWDRIVERS & BITS 99-130**SCREWDRIVERS 100-102**

SLOTTED SCREWDRIVERS FOR ENGINEERINGS 100

SLOTTED SCREWDRIVERS FOR ELECTRICIANS 100

STUBBY SLOTTED SCREWDRIVERS 100

PHILLIPS SCREWDRIVERS 101

STUBBY PHILLIPS SCREWDRIVERS 101

POZIDRIV SCREWDRIVERS 101

STUBBY POZIDRIV SCREWDRIVERS 101

TORX® SCREWDRIVERS 102

NUT DRIVER WITH HANDLE 1/4" 102**MAGNETIC BIT HOLDER FOR 1/4" BITS 102****NUT DRIVER WITH HANDLE, WITH FLEXIBLE BLADE 1/4" 103****RATCHETING BIT HOLDER FOR 1/4" BITS 103**

RATCHETING BIT HOLDER SCREWDRIVER FOR 1/4" BITS 103

RATCHETING BIT HOLDER STUBBY FOR 1/4" BITS 103

INSULATED 1000V SCREWDRIVERS 104-105

SLOTTED INSULATED 1000V SCREWDRIVERS 104

PHILLIPS INSULATED 1000V SCREWDRIVERS 104

POZIDRIV INSULATED 1000V SCREWDRIVERS 105

TORX® INSULATED 1000V SCREWDRIVERS 105

TWIN PACK INSULATED SCREWDRIVERS + TESTER 105

INSULATED SCREWDRIVER SET 105

SCREWDRIVER SETS 106-107**T-HANDLE SCREWDRIVERS 107-108**

T-HANDLE WITH HEXAGONAL TIP 107

T-HANDLE WITH TORX® TIP 108

T-HANDLE WITH HEXAGONAL BALL TIP 108

T-HANDLE SCREWDRIVERS, NUT DRIVER 108

HEX BALL END T HANDLE SET 108

6 IN 1 SCREWDRIVER 109**REVERSIBLE SCREWDRIVER 109****MAGNETISER 109****PRECISION SCREWDRIVER 110**

PRECISION SCREWDRIVER SET 110

POCKET PRECISION SCREWDRIVER 110

VOLTAGE TESTER 110**NICKEL PLATED KEYS FOR HEX SCREWS 111-112**

NICKEL PLATED KEYS, METRIC 111

NICKEL PLATED KEYS, INCHES 111

NICKEL PLATED KEYS SETS 111

OFFSET SCREWDRIVER SET 112

CHROME PLATED KEYS FOR HEX SCREWS, LONG 112**BLACK KEYS FOR HEX SCREWS 112-114**

BLACK KEYS, METRIC 112-113

BLACK KEYS SETS 113

BLACK KEYS, INCHES 114

BLACK KEYS SETS 114

BLACK KEYS FOR HEX SCREWS, LONG 114-115

BLACK KEYS, METRIC LONG 114

LONG BALL END, METRIC 115

BLACK KEYS SETS 115

BLACK KEYS FOR TORX® SCREWS	116
BLACK KEYS FOR TORX® SCREWS	116
BLACK KEY SETS FOR TORX® SCREWS	116
BLACK KEYS FOR TORX® TAMPER RESISTANT SCREWS	117
BLACK KEYS FOR TORX® TAMPER RESISTANT SCREWS	117
BLACK KEY SETS FOR TORX® TAMPER RESISTANT SCREWS	117
1/4" BITS	118-124
1/4" BITS FOR SLOTTED SCREWS	118
1/4" BITS FOR PHILLIPS SCREWS	118-119
1/4" BITS FOR PHILLIPS DRY WALL SCREWS	119
1/4" BITS FOR POZIDRIV SCREWS	119-120
1/4" BITS FOR TORX® SCREWS	120-121
1/4" BITS FOR TORX® TAMPER SCREWS	121
1/4" BITS FOR HEXAGONAL SCREWS	121
TORSION BIT FOR PHILLIPS HEAD SCREWS	122
TORSION BIT FOR POZIDRIV HEAD SCREWS	122
DIAMOND BIT FOR PHILLIPS HEAD SCREWS	122
DIAMOND BIT FOR POZIDRIV HEAD SCREWS	122
1/4" POWER MAGNETIC NUT DRIVER	123
1/4" POWER MAGNETIC NUT DRIVER SET	123
1/4" POWER MAGNETIC NUT DRIVER WITH RETAINING RING	123
ADAPTOR 1/4"	124
UNIVERSAL HOLDER 1/4"	124
QUICK RELEASE BIT HOLDER 1/4"	124
1/4" BITS SETS	125-126
PRECISION SCREWDRIVER SET FOR PRECISION ENGINEERING AND ELECTRONICS APPLICATIONS	126
5/16" BITS	127
5/16" BITS FOR SLOTTED SCREWS	127
5/16" BITS FOR PHILLIPS SCREWS	127
5/16" BITS FOR HEXAGONAL SCREWS	127
5/16" BITS FOR TORX® SCREWS	127
5/16" IMPACT SCREWDRIVER	128
5/16" IMPACT SCREWDRIVER	128
5/16" IMPACT SCREWDRIVER ADAPTOR	128
5/16" IMPACT DRIVER BIT SET	128
10 MM BITS	129-130
10 MM BITS FOR HEXAGONAL SCREWS	129
10 MM BITS FOR TORX® SCREWS	129

1/2" ADAPTOR FOR 10 MM BITS	129
3/8" ADAPTOR FOR 10 MM BITS	129
10 MM BITS FOR TORX® TAMPER SCREWS	130
10 MM BITS FOR XZN SCREWS	130
10 MM SQUARE BITS	130
1/2" SOCKET DRIVERS	130
1/2" SOCKET DRIVERS FOR TORX® TAMPER SCREWS	130

08. STRIKING TOOLS **131-142**

PUNCHES AND CHISELS **132-136**

COLD CHISELS	132
FLAT COLD CHISELS	132
EXTRAFLAT COLD CHISEL	132
FLAT CAPE CHISELS	132
ROUND CENTRE PUNCHES	133
ROUND CENTRE PUNCH SETS	133
OCTAGONAL CENTRE PUNCHES	133
ROUND TAPER PUNCHES	133
OCTAGONAL TAPER PUNCHES	133
ROUND TAPER PUNCH SET	134
OCTAGONAL TAPER PUNCH SETS	134
ROUND PARALLEL PIN PUNCHES	134
OCTAGONAL PARALLEL PIN PUNCHES	134
ROUND PARALLEL PIN PUNCH SET	135
OCTAGONAL PARALLEL PIN PUNCH SETS	135
ROUND PARALLEL PIN PUNCHES, LONG SERIES	135
OCTAGONAL PARALLEL PIN PUNCHES, LONG SERIES	135
ROUND PARALLEL PIN PUNCH SETS, LONG SERIES	135
ELECTRICIAN'S COLD CHISELS	136
SET	136

ENGINEERS SCRIBERS **136**

WRECKING BARS **136**

HAMMERS **137-141**

CURVED CLAW HAMMERS	141
STUBBY CLAW HAMMERS	141
SPANISH TYPE CURVED CLAW HAMMERS	141



JOINER'S HAMMERS	138	INSULATED SNIPE NOSE PLIERS	151
GERMAN DIN HAMMERS	138	INSULATED SNIPE NOSE PLIERS BENT TIP	151
RIVOIR HAMMERS	139	INSULATED SIDE CUTTING PLIERS	151
BALL PEIN HAMMERS	139	INSULATED HEAVY DUTY SIDE CUTTING PLIERS	151
SPANISH STONING HAMMERS	140	INSULATED STRIPPING PLIERS	152
STONING HAMMERS	140	INSULATED SLIP JOINT PLIERS	152
BLACK RUBBER MALLETS	140	INSULATED PLIERS SET	152
ANTI-BOUNCE NYLON FACED HAMMER	141	PINCERS AND FENCING PLIERS	153
NYLON FACED HAMMERS	141	CARPENTER'S PINCERS	153
CHISELS	142	FENCING PLIERS	153
CHISEL SETS	142	FENCING PLIERS WITH PVC DIPPED HANDLES	153
WOOD CARVING SET	142	BOLT CUTTERS	153
		BOLT CUTTERS	153
		SPARE HEAD	153
		CIRCLIP PLIERS	154
		INTERNAL STRAIGHT	154
		INTERNAL BENT	154
		EXTERNAL STRAIGHT	154
		EXTERNAL BENT	154
		CIRCLIP SET	154
		LOCKING PLIERS	155-157
		UNIVERSAL, CURVED JAWS WITH WIRE CUTTER	155
		UNIVERSAL, STRAIGHT JAWS	155
		LONG NOSE	155-157
		WELDING	155
		STEEL CLAMP	155
		STEEL CLAMP, SWIVEL PADS	156
		STEEL CLAMP, SWIVEL PADS, SLIM	156
		TABLE C CLAMP	156
		4 POSITION PLIERS	156
		CURVED JAWS WITH CUTTER	157
		SOFT GRIP PLIERS SET	157
		AUTOMATIC HAND VICES	157
		RIVETING TOOLS	158
		HAND RIVETER	158
		2 ARM RIVETER	158
		NUT RIVETER	158
		HAND RIVETER SET WITH RIVETS	158
		ELECTRICIAN'S SCISSORS AND KNIVES	159-161
		9 MM SNAP OFF KNIFE	159
		18 MM SNAP OFF KNIFE	159
09. PLIERS – SCISSORS AND KNIVES	143-161		
PLIERS	144-146		
COMBINATION PLIERS	144		
SIDE CUTTING PLIERS	145		
SNIPE NOSE PLIERS	145		
SNIPE NOSE PLIERS BENT TIP	145		
FLAT NOSE PLIERS	145		
ROUND NOSE PLIERS	146		
SLIP JOINT PLIERS	146		
QUICK ADJUST SLIP JOINT PLIERS	146		
PLIERS SETS	146		
MINI PLIERS	147-148		
PLIERS FOR ELECTRICIANS	148-151		
STRIPPING PLIERS	148		
COPPER ALUMINIUM WIRE CUTTER	148		
CRIMPING PLIER INSULATED TERMINALS	149		
CRIMPING PLIER NON-INSULATED TERMINALS	149		
CRIMPING PLIER NON-INSULATED FASTON TYPE TERMINALS	149		
CRIMPING PLIER INSULATED TERMINALS SET	149		
INSULATED END SLEEVES AND PLUG CONNECTORS SET	150		
INTERCHANGEABLE JAWS CRIMPING PLIERS SET	150		
INSULATED PLIERS	150-152		
INSULATED COMBINATION PLIERS	150		
INSULATED FLAT NOSE PLIER	150		

SAFETY UTILITY KNIFE	159
GLASS SCRAPER WITH INTERCHANGEABLE BLADES	159
MULTIPURPOSE TRADESMAN KNIVES WITH SHEATH	159
FOLDABLE KNIFE	160
ELECTRICIANS' KNIFE	160
MULTITOOL	160
ELECTRICIANS' SCISSORS	161
HOOKS AND PICKING TOOLS	161
MINI PICK AND HOOK SET	161

10. PULLING TOOLS **163-168**

PULLERS	164-165
UNIVERSAL 2 ARM PULLERS	164
SELF-CENTERING 2 ARMS PULLERS	164
SELF-CENTERING 3 ARMS PULLERS	165
MULTIPLE PULLERS	165
EXTRACTORS	166
STUD EXTRACTORS SET	166
TAP WRENCH	166
NUT SPLITTER	166
PICK-UP TOOLS	166-167
MAGNETIC PICK-UP TOOL	166
CLAW PICK-UP TOOL	167
PRY BARS	167
PRY BAR	167
OFFSET LEVER SET	167
OFFSET LEVER	167
SHEET PUNCHES	168
SHEET METAL PUNCHES	168
SPARE BOLT	168

11. CUTTING TOOLS AND MEASURING **169-182**

BOWSAW FRAMES AND BLADES	170
BOWSAW FRAMES	170
BOWSAW BLADES, GREEN WOOD	170
BOWSAW BLADES, DRY WOOD	170

HACKSAW FRAMES AND BLADES	170-172
TENON SAW	170
GENERAL PURPOSE HANDSAW	170
DOVETAIL FLEX HANDSAW	171
COMPASS SAW	171
ALUMINIUM HACKSAW FRAME	171
HACKSAW FRAME	171
BI-METAL	171
ALUMINIUM HOLDER	172
HACKSAW FRAME	172
HOLESAWS	172
FILES	172-173
FLAT FILES	172
HAND FILES	172
HALF ROUND FILES	173
ROUND FILES	173
THREE SQUARE FILES	173
SQUARE FILES	173
FILE SET	173
SPIRIT LEVELS	174-175
SPIRIT LEVELS	174
MAGNETIC SPIRIT LEVELS	174
SET OF LEVELS	175
TORPEDO LEVEL	175
POCKET SPIRIT LEVEL	175
ALUMINUM LEVEL WITH HOLSTER	175
MEASURING TAPES	176-177
MEASURING TAPES	176
TAPE TWINPACK	176
HIGH VISIBILITY MEASURING TAPES	176
MEASURING TAPE FOR VERTICAL MEASUREMENTS	177
LONG TAPES	177
WOODEN FOLDING RULE	177
SQUARES	178
SQUARES	178
COMBINATION SQUARES	178
GAUGE SETS	178
SCREW PITCH GAUGE SET	178
FEELER GAUGE SETS	178



CALIPERS	179	POINT OF SALE MATERIAL	190-193
VERNIER CALIPER 150 MM	179	METAL WALL 1 SIDE 2 LEGS	191
DIGITAL VERNIER CALIPER 150 MM	179	LIGHTBOX	191
INFRARED THERMOMETER	179	SIGN CARRIER + SIGN IRIMO	191
PAINT SCRAPERS	180	METAL WALL CORNER 1 LEG	191
PAINT SCRAPERS	180	LIGHTBOX CORNER WALL	192
BODY WORK SCRAPER SET	180	DOUBLE SIDE WALL WITH WHEELS	192
FASTENING TOOLS	180-182	TRIANGULAR METAL WALL WITH WHEELS	192
CAULKING GUNS	180	SPARE PARTS FOR METAL WALL	192
ELECTRONIC GLUE GUN SET	180	METHACRYLATE FOR LIGHTBOX	192
HEAT GUN 2000W	181	PVC TOP SIGN FOR SIGN CARRIER	192
HEAT GUN NOZZLES	181	TOP SIGN FOR DOUBLE SIDED WALL	192
HEAVY DUTY STAPLE GUN 4 IN 1	181-182	BANNER FOR METAL WALLS	192
HAMMER TACKER	181-182	ADDITIONAL POS MATERIAL. EMPTY DISPLAYS	193
HEAVY DUTY STAPLES	181-182	GENERIC COUNTER DISPLAY	193
LIGHT DUTY STAPLES	182	COUNTER S DISPLAY	193
BRAD NAILS 15 MM	182	COUNTER L DISPLAY	193
CABLE STAPLES	182	PALLET COVER EUROPALLET	193
		COUNTER DISPLAY FOR PLIERS	193
		STICKERS A4 SHEET	193
		STAND ALONE	193
12. LIGHTING AND POWER TOOLS	183-188		
POCKET LAMPS	184-185		
FLEXIBLE LIGHT	184		
COMPACT LIGHT	184		
SLIM FLEX	184		
MINI FLEXIBLE LIGHT	185		
INSPECTION LAMPS	185		
ALUMINIUM TORCH	185		
WORKING LAMPS	185		
BOOK LIGHT	185		
HEAD LAMPS	186		
HEAD LIGHT	186		
PNEUMATIC TOOLS	187-188		
1/2" IMPACT WRENCH	187		
3/4" IMPACT WRENCH	187		
1/4" RATCHET	188		
1/2" RATCHET	188		
AIR LINE COUPLERS	188		
CORDLESS SCREWDRIVER	188		
3.6V CORDLESS SCREWDRIVER	188		



01.

TOOL STORAGE

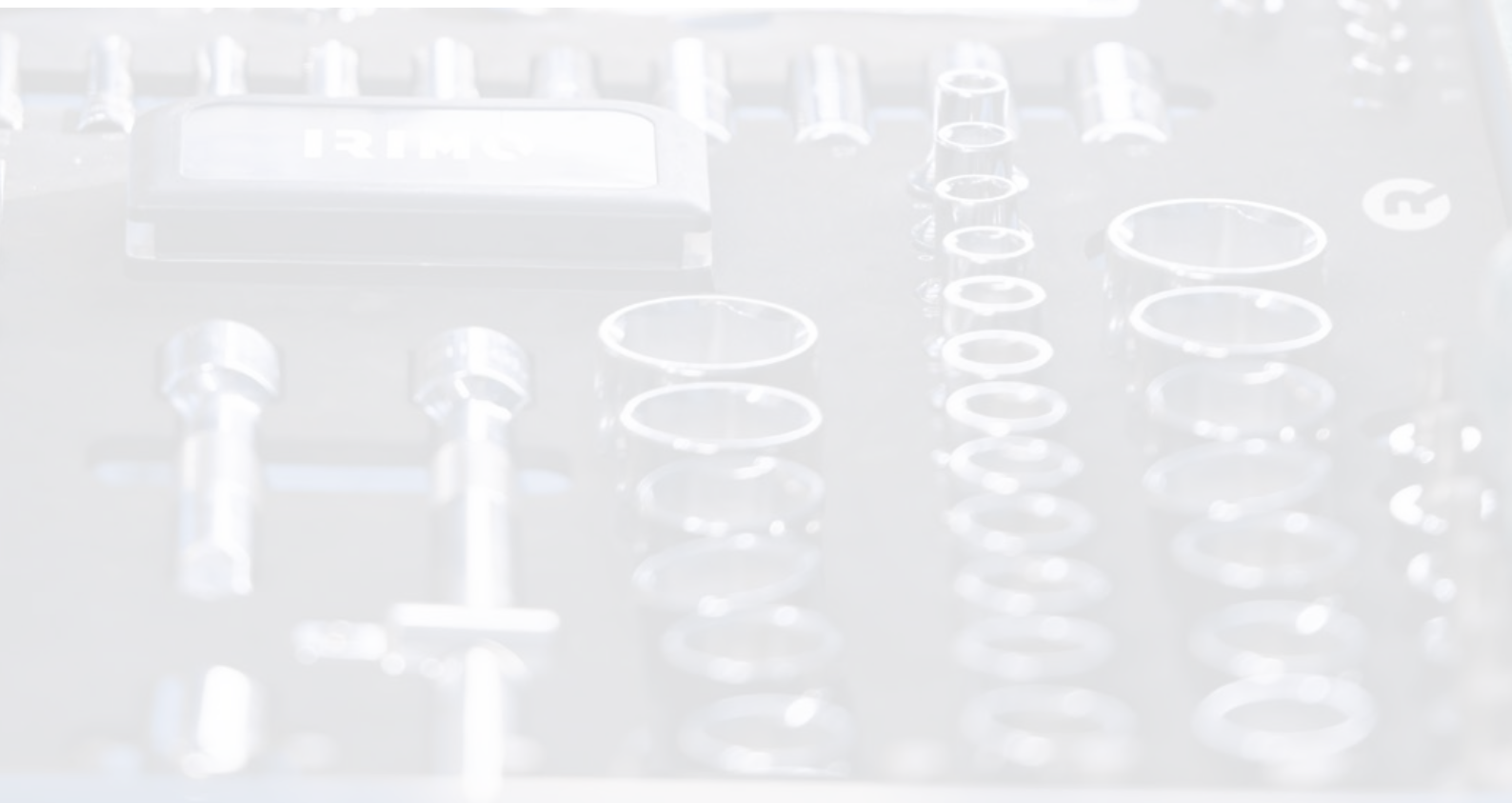

TOOL TROLLEYS

Built to be filled 26" capacity

With a double wall frame, it protects your tools from shocks and crashes, while reinforced areas handle stress at critical points.



ENJOY DURABILITY

PROTECTION & CONVENIENCE
IN YOUR WORKSPACE.



x4 x5 x6 x7

DRAWERS

Easy Mobility

Heavy-duty wheels (125 x 30 mm) with ball bearings and non-marking rubber glide smoothly.

Two fixed wheels provide stability, whilst two swiveled with brakes offer precision control.

Smooth and Steady

- Long ball bearing slides ensure 100% drawer opening
- Click/detent system keeps drawers securely closed
- Central lock adds extra security



9066K-01 • (2x) slides



9066K-02 • (2x) swivel
9066K-03 • (2x) fixed



9066K-05 • handle



9066K-06 • top mat



9066K-01	SP Slides (2x)	30 kg capacity
9066K-02	SP Swivel wheels (2x)	125 x 30 mm
9066K-03	SP Fixed wheels (2x)	125 x 30 mm
9066K-05	SP Handle x 9066K series	
9066K-06	SP Top mat x 26 trolleys	
9064-15	SP Pocket handles (2x)	
9064AC01	SP Drawer liner-7 units set	

9066K5	x5	1	677 x 501 x 954	400	543 x 445 x h	25	125 x 30	48
9066K6	x6	1	677 x 501 x 954	400	543 x 445 x h	25	125 x 30	51
9066K7	x7	1	677 x 501 x 954	400	543 x 445 x h	25	125 x 30	52
9065K4	x4	1	677 x 501 x 420	250	543 x 445 x h	25	—	38

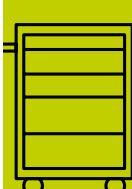

TROLLEY 6 DRAWERS WITH FOAM AND TOOLS, 206 pieces



IFF1A001



IFF1A002



IFF1A003

9066K6FF100
1
677x501x954
kg
80

IFF1A001

045001, 045011, 045021		
101-04-1, 101-045-1, 101-05-1, 101-055-1, 101-06-1, 101-07-1, 101-08-1, 101-09-1, 101-10-1, 101-11-1, 101-12-1, 101-13-1, 101-14-1		
103-04-1, 103-05-1, 103-06-1, 103-07-1, 103-08-1, 103-09-1, 103-10-1, 103-11-1, 103-12-1, 103-13-1		
105-22-1, 105-24-1		
105-40-1		
105-42-1		
105-48-1		
105-50-1		
105-70-1		
106-04-1, 106-05-1, 106-06-1, 106-07-1, 106-08-1		
121-10-1, 121-11-1, 121-12-1, 121-13-1, 121-14-1, 121-15-1, 121-16-1, 121-17-1, 121-18-1, 121-19-1, 121-20-1, 121-21-1, 121-22-1, 121-24-1, 121-27-1, 121-30-1, 121-32-1		
125-23-1, 125-25-1		
125-40-1		
125-42-1		
125-48-1		
125-53-1, 125-54-1		
124-14-1, 124-15-1, 124-17-1, 124-19-1, 124-22-1		
125-70-1		
126-10-1, 126-11-1, 126-12-1, 126-14-1, 126-16-1, 126-18-1, 126-20-1, 126-24-1		
475-4-1, 475-5.5-1, 475-6.5-1		
475-H3-1, 475-H4-1, 475-H5-1, 475-H6-1		
475-PH1-1, 475-PH2-1		
475-PZ1-1, 475-PZ2-1		
475-T8-1, 475-T10-1, 475-T15-1, 475-T20-1, 475-T25-1, 475-T27-1, 475-T30-1		

IFF1A002

529171		
475-61-1		
48-9-H		
511-105-1		
515-002-1, 515-003-1, 515-004-1, 515-005-1, 515-006-1		
5-250C-1		
527-61-2		
601-180-1		
612-160-1		
625-180-1		
634-250-1		
666-156-1		
980-3B-1		

IFF1A003

25-06-2, 25-07-2, 25-08-2, 25-09-2, 25-10-2, 25-11-2, 25-12-2, 25-13-2, 25-14-2, 25-15-2, 25-16-2, 25-17-2, 25-18-2, 25-19-2, 25-21-2, 25-22-2, 25-24-2, 25-27-2, 25-30-2, 25-32-2		
407-4-100, 407-5.5-125, 407-6.5-150, 407-8-175		
409-1-100, 409-2-125, 409-3-150		
9066K6		



TOOL TROLLEYS

TROLLEY 6 DRAWERS WITH FOAM AND TOOLS, 178 pieces



IFF1A004



IFF1A005



IFF1A006

9066K6FF101	1	677 x 501 x 950	80

IFF1A004

101-04-1, 101-045-1, 101-05-1, 101-055-1, 101-06-1, 101-07-1, 101-08-1, 101-09-1, 101-10-1, 101-11-1, 101-12-1, 101-13-1



103-04-1, 103-05-1, 103-06-1, 103-07-1, 103-08-1, 103-09-1, 103-10-1, 103-11-1, 103-12-1, 103-13-1



105-22-1, 105-24-1

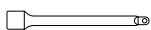

105-40-1



105-42-1



105-48-1



105-50-1

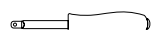

105-70-1



121-10-1, 121-11-1, 121-12-1, 121-13-1, 121-14-1, 121-15-1, 121-17-1, 121-19-1, 121-22-1, 121-24-1, 121-27-1, 121-30-1, 121-32-1



125-23-1, 125-25-1



125-40-1



125-42-1



125-48-1



125-54-1



125-70-1



407-4-100, 407-5.5-125, 407-6.5-150, 407-8-175



408-6.5-25



409-1-100, 409-2-125, 409-3-150



409-2-25



413-1-100, 413-2-125



IFF1A005

529171



527-61-2



475-61-1

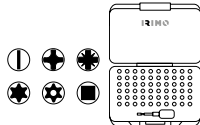

48-9-H

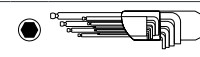

501-250-1



511-105-1



515-002-1, 515-003-1, 515-004-1, 515-005-1, 515-006-1

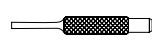

5-150C-1, 5-250C-1



601-180-1



612-160-1



625-180-1



634-250-1



665-200-1



980-3B-1



IFF1A006

25-06-2, 25-07-2, 25-08-2, 25-09-2, 25-10-2, 25-11-2, 25-12-2, 25-13-2, 25-14-2, 25-15-2, 25-16-2, 25-17-2, 25-18-2, 25-19-2, 25-21-2, 25-22-2, 25-24-2, 25-27-2, 25-30-2, 25-32-2

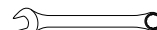

10-0607-1, 10-0809-1, 10-1011-1, 10-1213-1, 10-1415-1, 10-1617-1, 10-1819-1, 10-2022-1, 10-2123-1, 10-2427-1, 10-3032-1

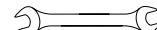

9066K6





TROLLEY 7 DRAWERS WITH FOAM AND TOOLS, 222 pieces



IFF1A004



IFF1A005



IFF1A006



IFF1A007

9066K7FF102	1	677 x 501 x 954	90

IFF1A004	
101-04-1, 101-045-1, 101-05-1, 101-055-1, 101-06-1, 101-07-1, 101-08-1, 101-09-1, 101-10-1, 101-11-1, 101-12-1, 101-13-1	
103-04-1, 103-05-1, 103-06-1, 103-07-1, 103-08-1, 103-09-1, 103-10-1, 103-11-1, 103-12-1, 103-13-1	
105-22-1, 105-24-1	
105-40-1	
105-42-1	
105-48-1	
105-50-1	
105-70-1	
121-10-1, 121-11-1, 121-12-1, 121-13-1, 121-14-1, 121-15-1, 121-17-1, 121-19-1, 121-22-1, 121-24-1, 121-27-1, 121-30-1, 121-32-1	
125-23-1, 125-25-1	
125-40-1	
125-42-1	
125-48-1	
125-54-1	
125-70-1	
407-4-100, 407-5-5-125, 407-6-5-150, 407-8-175	
408-6-5-25	
409-1-100, 409-2-125, 409-3-150	
409-2-25	
413-1-100, 413-2-125	

IFF1A005	
529171	
527-61-2	
475-61-1	
48-9-H	
501-250-1	
511-105-1	
515-002-1, 515-003-1, 515-004-1, 515-005-1, 515-006-1	
5-150C-1, 5-250C-1	
601-180-1	
612-160-1	
625-180-1	
634-250-1	
665-200-1	
980-3B-1	

IFF1A006	
25-06-2, 25-07-2, 25-08-2, 25-09-2, 25-10-2, 25-11-2, 25-12-2, 25-13-2, 25-14-2, 25-15-2, 25-16-2, 25-17-2, 25-18-2, 25-19-2, 25-21-2, 25-22-2, 25-24-2, 25-27-2, 25-30-2, 25-32-2	
10-0607-1, 10-0809-1, 10-1011-1, 10-1213-1, 10-1415-1, 10-1617-1, 10-1819-1, 10-2022-1, 10-2123-1, 10-2427-1, 10-3032-1	
IFF1A007	
534261	
534291	
534321	
534351	
534381	
534411	
180-05-1, 180-06-1, 180-07-1, 180-08-1, 180-10-1, 180-12-1, 180-14-1, 180-17-1	
180-05X-1, 180-06X-1, 180-07X-1, 180-08X-1, 180-10X-1, 180-12X-1	
183-30-1, 183-40-1, 183-45-1, 183-50-1, 183-55-1, 183-60-1	
183-40X-1, 183-45X-1, 183-50X-1, 183-55X-1	
458-8-F	
716-M6-1, 716-M8-1, 716-M11-1, 716-M14-1, 716-M18-1,	
801-145-1	
9066K7	



TROLLEY FOAMS 3/3 SYSTEM

IFF1A001



- 3/3 Foam Inlay Socket sets / ratchet / bits
- 94 pieces

IFF1A001	1	445x543x40

045001, 045011, 045021		
101-04-1, 101-04-5-1, 101-05-1, 101-05-5-1, 101-06-1, 101-07-1, 101-08-1, 101-09-1, 101-10-1, 101-11-1, 101-12-1, 101-13-1, 101-14-1		
103-04-1, 103-05-1, 103-06-1, 103-07-1, 103-08-1, 103-09-1, 103-10-1, 103-11-1, 103-12-1, 103-13-1		
105-22-1, 105-24-1		
105-40-1		
105-42-1		
105-48-1		
105-50-1		
105-70-1		
106-04-1, 106-05-1, 106-06-1, 106-07-1, 106-08-1		
121-10-1, 121-11-1, 121-12-1, 121-13-1, 121-14-1, 121-15-1, 121-16-1, 121-17-1, 121-18-1, 121-19-1, 121-20-1, 121-21-1, 121-22-1, 121-24-1, 121-27-1, 121-30-1, 121-32-1		
125-23-1, 125-25-1		
125-40-1		
125-42-1		
125-48-1		
125-53-1, 125-54-1		
124-14-1, 124-15-1, 124-17-1, 124-19-1, 124-22-1		
125-70-1		
126-10-1, 126-11-1, 126-12-1, 126-14-1, 126-16-1, 126-18-1, 126-20-1, 126-24-1		
475-4-1, 475-5-5-1, 475-6-5-1		
475-H3-1, 475-H4-1, 475-H5-1, 475-H6-1		
475-PH1-1, 475-PH2-1		
475-PZ1-1, 475-PZ2-1		
475-T8-1, 475-T10-1, 475-T15-1, 475-T20-1, 475-T25-1, 475-T27-1, 475-T30-1		

IFF1A002



- 3/3 Foam Inlay Striking tools / Cutting tools / Measuring tape / Pliers
- 85 pieces

IFF1A002	1	445x543x40

529171		
475-61-1		
48-9-H		
511-105-1		
515-002-1, 515-003-1, 515-004-1, 515-005-1, 515-006-1		
5-250C-1		
527-61-2		
601-180-1		
612-160-1		
625-180-1		
634-250-1		
666-156-1		
980-3B-1		

IFF1A003



- 3/3 Foam Inlay Combination wrenches / Screwdrivers
- 27 pieces

IFF1A003	1	445x543x40

25-06-2, 25-07-2, 25-08-2, 25-09-2, 25-10-2, 25-11-2, 25-12-2, 25-13-2, 25-14-2, 25-15-2, 25-16-2, 25-17-2, 25-18-2, 25-19-2, 25-21-2, 25-22-2, 25-24-2, 25-27-2, 25-30-2, 25-32-2		
407-4-100, 407-5-5-125, 407-6-5-150, 407-8-175		
409-1-100, 409-2-125, 409-3-150		



IFF1A004



- 3/3 Foam Inlay Socket set/ Screwdrivers/ Ratchets
- 60 pieces

IFF1A004	1	445 x 543 x 40

101-04-1, 101-045-1, 101-05-1, 101-055-1, 101-06-1, 101-07-1, 101-08-1, 101-09-1, 101-10-1, 101-11-1, 101-12-1, 101-13-1		
103-04-1, 103-05-1, 103-06-1, 103-07-1, 103-08-1, 103-09-1, 103-10-1, 103-11-1, 103-12-1, 103-13-1		
105-22-1, 105-24-1		
105-40-1		
105-42-1		
105-48-1		
105-50-1		
105-70-1		
121-10-1, 121-11-1, 121-12-1, 121-13-1, 121-14-1, 121-15-1, 121-17-1, 121-19-1, 121-22-1, 121-24-1, 121-27-1, 121-30-1, 121-32-1		
125-23-1, 125-25-1		
125-40-1		
125-42-1		
125-48-1		
125-54-1		
125-70-1		
407-4-100, 407-5-5-125, 407-6-5-150, 407-8-175		
408-6-5-25		
409-1-100, 409-2-125, 409-3-150		
409-2-25		
413-1-100, 413-2-125		

IFF1A005



- 3/3 Foam Inlay Striking tools/ Cutting tools/ Pliers
- 87 pieces

IFF1A005	1	445 x 543 x 40

529171	
527-61-2	
475-61-1	
48-9-H	
501-250-1	
511-105-1	
515-002-1, 515-003-1, 515-004-1, 515-005-1, 515-006-1	
5-150C-1, 5-250C-1	
601-180-1	
612-160-1	
625-180-1	
634-250-1	
665-200-1	
980-3B-1	

IFF1A006



- 3/3 Foam Inlay Combination wrenches/ Open end wrenches
- 31 pieces

IFF1A006	1	445 x 543 x 40

25-06-2, 25-07-2, 25-08-2, 25-09-2, 25-10-2, 25-11-2, 25-12-2, 25-13-2, 25-14-2, 25-15-2, 25-16-2, 25-17-2, 25-18-2, 25-19-2, 25-21-2, 25-22-2, 25-24-2, 25-27-2, 25-30-2, 25-32-2	
10-0607-1, 10-0809-1, 10-1011-1, 10-1213-1, 10-1415-1, 10-1617-1, 10-1819-1, 10-2022-1, 10-2123-1, 10-2427-1, 10-3032-1	

2



3



4



5



6



7



8



9



10



11



12



TROLLEY FOAMS 3/3 & 1/3 SYSTEM

IFF1A007



- 3/3 Foam Inlay Socket set / Files / Cutting tools
- 44 pieces

IFF1A007 1 445x543x40

534261		
534291		
534321		
534351		
534381		
534411		
180-05-1, 180-06-1, 180-07-1, 180-08-1, 180-10-1, 180-12-1, 180-14-1, 180-17-1		
180-05X-1, 180-06X-1, 180-07X-1, 180-08X-1, 180-10X-1, 180-12X-1		
183-30-1, 183-40-1, 183-45-1, 183-50-1, 183-55-1, 183-60-1		
183-40X-1, 183-45X-1, 183-50X-1, 183-55X-1		
458-8-F		
716-M6-1, 716-M8-1, 716-M11-1, 716-M14-1, 716-M18-1,		
801-145-1		

IFF1E001



- Double offset ring wrenches
- 8 pieces

IFF1E001 1 445x181x40

- 15-0607-1, 15-0809-1, 15-1011-1, 15-1213-1, 15-1415-1, 15-1617-1, 15-1819-1, 15-2022-1



IFF1E002

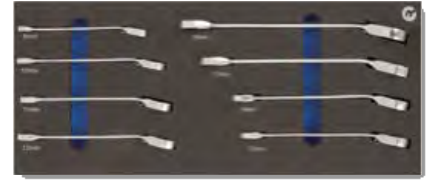

- Ratcheting combination wrenches
- 8 pieces

IFF1E002 1 445x181x40

- 18-08-1, 18-10-1, 18-11-1, 18-12-1, 18-13-1, 18-14-1, 18-17-1, 18-19-1

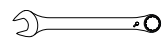

IFF1E003



- Double open end wrenches
- 10 pieces

IFF1E003 1 445x181x40

- 10-0607-1, 10-0809-1, 10-1011-1, 10-1213-1, 10-1415-1, 10-1617-1, 10-1819-1, 10-2022-1, 10-2427-1, 10-3032-1

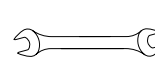

IFF1E004



- Combination wrenches
- 16 pieces

IFF1E004 1 445x181x40

- 25-06-2, 25-07-2, 25-08-2, 25-09-2, 25-10-2, 25-11-2, 25-12-2, 25-13-2, 25-14-2, 25-15-2, 25-16-2, 25-17-2, 25-18-2, 25-19-2, 25-21-2, 25-22-2

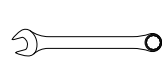

IFF1E005



- Open pipe socket wrench, Hex
- 11 pieces

IFF1E005 1 445x181x40

- 52-08-1, 52-10-1, 52-11-1, 52-12-1, 52-13-1, 52-14-1, 52-15-1, 52-16-1, 52-17-1, 52-18-1, 52-19-1

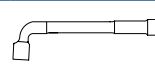

IFF1E006



- TORX® screwdrivers
- 7 pieces

IFF1E006 1 445x181x40

- 414-10-75, 414-15-100, 414-20-100, 414-25-125, 414-27-125, 414-30-150, 414-40-150

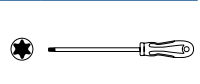

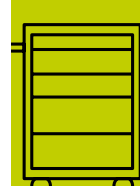

IFF1E007



- Electrician straight and stubby screwdrivers, engineer slotted screwdriver
- 7 pieces

IFF1E007	1	445x181x40

408-3-75, 408-3.5-100, 408-4-100, 408-5.5-125, 408-6.5-150	
407-8-150	
408-5.5-25	

IFF1E008



- Phillips screwdrivers
- 5 pieces

IFF1E008	1	445x181x40

409-0-75, 409-1-100, 409-2-125, 409-3-150	
409-2-25	

IFF1E009



- Pozidriv and Stubby screwdrivers
- 5 pieces

IFF1E009	1	445x181x40

413-0-75, 413-1-100, 413-2-125, 413-3-150	
413-2-25	

IFF1E010

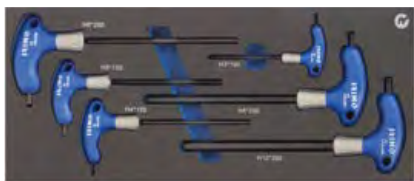

- T-Handle hexagonal screwdrivers
- 6 pieces

IFF1E010	1	445x181x40

42-H3-100, 42-H4-150, 42-H5-150, 42-H6-200, 42-H8-200, 42-H10-200	
---	--

IFF1E011

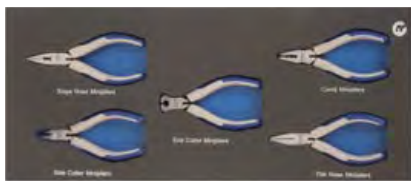

- Minipliers
- 5 pieces

IFF1E011	1	445x181x40

601M-125-1	
612M-125-1	
624M-125-1	
626M-125-1	
604M-125-1	

IFF1E012

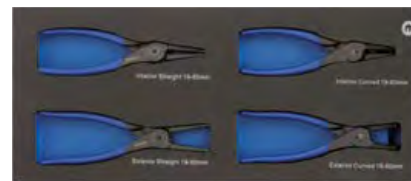

- Circlip pliers exterior and interior
- 4 pieces

IFF1E012	1	445x181x40

621571	
621671	
621771	
621871	



TROLLEY FOAMS 1/3 SYSTEM

IFF1E013



- Pliers
- 4 pieces



IFF1E013 1 445x181x40

601-180-1	
624-160-1	
612-160-1	
634-250-1	

IFF1E014



- Files
- 5 pieces



IFF1E014 1 445x181x40

534411	
534351	
534321	
534291	
534381	

IFF1E015



- Socket set 1/2", sliding T-Handle, ratchet
- 21 pieces



IFF1E015 1 445x181x40

121-10-1, 121-11-1, 121-12-1, 121-13-1, 121-14-1, 121-15-1, 121-16-1, 121-17-1, 121-18-1, 121-19-1, 121-21-1, 121-22-1, 121-23-1, 121-24-1, 121-27-1, 121-30-1, 121-32-1	
125-70-1	
125-42-1	
125-23-1	
125-25-1	

IFF1E016



- Socket set 1/4", T-Handle, extensions, ratchet
- 18 pieces



IFF1E016 1 445x181x40

101-04-1, 101-045-1, 101-05-1, 101-055-1, 101-06-1, 101-07-1, 101-08-1, 101-09-1, 101-10-1, 101-11-1, 101-12-1, 101-13-1, 101-14-1	
105-70-1	
105-42-1	
105-50-1	
105-22-1	
105-24-1	

IFF1E017



- Pin punches and chisel
- 8 pieces



IFF1E017 1 445x181x40

504-200-1	
516-002-1, 516-003-1, 516-004-1, 516-005-1, 516-006-1	
512-010-1, 512-012-1	

IFF1E018



- Striking and cutting tools
- 4 pieces



IFF1E018 1 445x181x40

529171	
527-51-2	
982-TOR-1	
668-150-1	



IFF1E019



- Bit set 1/4", measuring tape, battery
- 72 pieces

IFF1E019	1	445x181x40

475-61-1		
48-9-H		
980-3-1		
L14		

IFF1E024



- Insulated pliers and cutter
- 3 pieces

IFF1E024	1	445x181x40

601V-180-1		
612V-160-1		
624V-160-1		

IFF1E021



- Stud extractor and pullers
- 8 pieces

IFF1E021	1	445x181x40

701-90-1		
702-40-1		
703-40-1		
716-5-1		

IFF1E025



- Insulated 1000V screwdrivers
- 6 pieces

IFF1E025	1	445x181x40

408V-3-100, 408V-4-100, 408V-5.5-125, 408V-6.5-150		
409V-1-150, 409V-2-175		

IFF1E023



- Adjustable central nut and slip joint plier
- 2 pieces

IFF1E023	1	445x181x40

5-250C-1		
634Q-250-1		

2



3



4



5



6



7



8



9



10



11



12



TOOL TROLLEYS

3 TOOL BOXES TOWER ON WHEELS



TOWER 3 IN 1 WITH FOAM AND TOOLS , 98 pieces



- Multiple compartments provide large storage capacity allowing easy organization of tools
- Combination of steel and PP plastic provides robustness but light
- On wheels solution, together with the telescopic handle, makes its driving easy even when very loaded
- Rubber wheels dim: 125 x 35 mm
- Locking bar with padlock for full locking included
- The 3 compartments can be attached and detached easily with the lateral metallic latches
- **Top compartment:**
int dim: 485 x 225 x 210 mm
Can be used as an independent tool box and it can be locked using a padlock
Alu big handle makes its transport easy and comfortable
Retractable side handles help to lift when very loaded
Portable tray included 450 x 185 x 45 mm
- **Medium compartment:**
int dim of 2 drawers: 390 x 215 x 60 mm
2 Drawers with ball bearing sliders and full extension, also padlockable
- **Bottom compartment:**
int dim: 403 x 200 x 265 mm
Drawer pivots giving full access and making the storage hose reels, drills and similar big tools/ accessories easy
- Telescopic handle is permanently attached to the bottom compartment and has 4 positions:
995 mm, 900 mm, 800 mm and 645 mm
- External dim: 520 x 320 x 720 mm

R	Icon	mm	kg
9021FTW520	1	520 x 320 x 720	15

SPARE PARTS

R	Part Name	Dim
9021FTW520-AC1	2 wheels & spindle	125 x 35 mm
9021FTW520-AC2	Lock for tower	
9021FTW520-AC3	4 latches tower	
9021FTW520-AC4	Telescopic handle	
9021FTW520-AC5	Aluminium handle topbox	

R	Icon	mm	kg
9021FTW520FF1	1	520 x 320 x 720	22.5
101-04-1, 101-045-1, 101-05-1, 101-055-1, 101-06-1, 101-07-1, 101-08-1, 101-09-1, 101-10-1, 101-11-1, 101-12-1, 101-13-1, 101-14-1			1/4
121-08-1, 121-10-1, 121-11-1, 121-12-1, 121-13-1, 121-14-1, 121-16-1, 121-17-1, 121-19-1, 121-21-1, 121-22-1			1/2
105-70-1		475-1/4-125	
105-40-1		105-50-1	
105-22-1		105-24-1	
105-42-1		125-70-1	
125-40-1		125-43-1	
125-23-1		125-25-1	
46-8-F		475-32-1	
980-3B-1			
407-5.5-125		409-1-100	
407-6.5-150		409-2-125	
612-160-1		601-180-1	
625-180-1		604-160-1	
5-250C-1		522-31-2	
634-250-1		665-200-1	
25-08-1, 25-09-1, 25-10-1, 25-11-1, 25-12-1, 25-13-1, 25-14-1, 25-17-1, 25-19-1			

9021FTW520

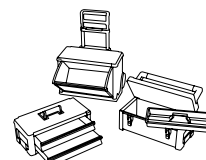



2 TRAYS ROLL CART



- 2 tray set roll cart
- Manufactured and designed for easy and quick assembly
- Wheels of 100x25 mm with ball bearings and non-marking TPR outsurface:
2 fixed and 2 swivel with brake
- Trays internal dimensions:
(2x) 750 x 425 x 77 mm

Code	Qty	Dimensions (mm)	Wheels (mm)	Height (mm)	Weight (kg)
9064K-02	1	759x432x1.025	300	759x432xh	50
9064K-02T	1	757x425x77	50		3.25

TRANSPORTERS

FOLDABLE TRANSPORTER



- Robust
- Elastic bands included to fix the load (safety feature)
- Steel frame
- 250x450 mm aluminum footplate
- 170 mm PP wheels
- Overall size:
480x420x740-1000 mm

Code	Qty	Dimensions (mm)	Wheels (mm)	Height (mm)	Weight (kg)
9063FT90	1	250x450	90	170	4.3

TRANSPORTER



- Strong Steel frame
- Steel plate provide high robustness
- Wheels: 2 fixed and 2 rear swivel for easy maneuverings
- Push/pull handle that folds for easy storage and carriage
- Non-slip platform surface
- Overall size 150 kgs:
– Unfolded: 730 x 470 x 820 mm
– Folded: 730 x 470 x 225 mm
- Overall size 300 kgs:
– Unfolded: 920 x 620 x 870 mm
– Folded: 920 x 620 x 300 mm

Code	Qty	Dimensions (mm)	Wheels (mm)	Height (mm)	Weight (kg)
9063HT150	1	730x470	150	25x100	7.5
9063HT300	1	920x620	300	25x125	15.0



SPARE PARTS

Code	Description	Dimensions (mm)	Weight (kg)
9063HT150FI	(2x) 4" fixed wheels	9063TH150 130x100x30	0.30
9063HT150SW	(2x) 4" swivel wheels	9063TH150 130x100x30	0.35
9063HT300FI	(2x) 5" fixed wheels	9063TH300 157x125x37	0.80
9063HT300SW	(2x) 5" swivel wheels	9063TH300 157x125x37	0.90

WORKBENCH

HEAVY DUTY STEEL WORKBENCH WITH 4-LEG



- Sturdy metallic workbench
- 4 height adjustable legs
- Foot with threaded stud ended with anti-slippery rubber
- 4 optional wheels (9062-CAST-1)
- Two drawers 450 mm for 1.500 mm version
Three drawers 450 mm for 1.800 version
With lock key
- Same plate thickness on top and bottom tray: 2 mm
- Strong anti-scratch paint
- Max load capacity 500 kgs top and 200 kgs on the bottom tray
- Very well protected in a wooden box and super easy to mount

Code	Qty	Dimensions (mm)	Height (mm)	Weight (kg)
9062-1500-1	1	1500 x 640 x 865	500	56.9
9062-1800-1	1	1800 x 640 x 865	500	68.2

TOOL PANEL WITH REINFORCED FRAME FOR 9062 WORKBENCHES

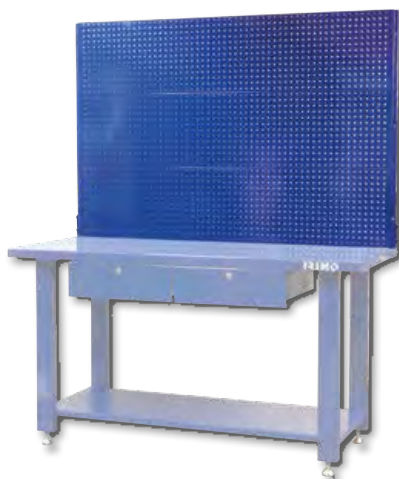

- Metal panels with reinforced frame for 9062 workbenches
- Standard holes rounded diam. 5 mm
- 2.5 mm distance between holes
- Composed by three metal sheets with two supporting poles
- Specific holes made to attach them to wall if the workbench is not needed
- Possibility to attach to the workbench with two fixing parts (9062-FIX-1)

Code	Qty	Dimensions (mm)	Weight (kg)
9062-P1500-1	1	1500 x 990	14.7
9062-P1800-1	1	1800 x 990	17.6

HOOK KIT FOR 9062 CABINET AND PANEL

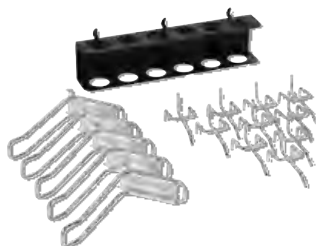

- Kit of three different hooks for rounded hole panels

Code	Qty	Weight (g)
9062-HOOK-1	1	300

PACK OF FOUR WHEELS FOR WORKBENCH



- 2 in 1 wheel for 9062 workbenches
- Convertible into fixed legs by moving the red wheel and the rubber block will go down until making it steady
- Simple threaded stud insertion into the leg will make the process easy to have two options for the workbench

Code	Qty	Dimensions (mm)	Weight (kg)
9062-CAST-1	1	140 x 202 x 90	2.6

TOOL PANEL ADAPTORS FOR WORKBENCH



- Two squares with bolts for fixing the panel into the 9062 workbench

Code	Qty	Weight (g)
9062-FIX-1	1	320

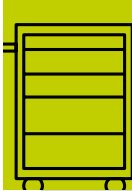

FOLDABLE WORKBENCH



- Foldable workbench supporting up to 160 kg of weight
- Very compact: folds flat for easy transport and storage
- Adjustable pivot pins and jaw retention slots provide clamping versatility and secure material retention
- Double clamping cranks increase clamping strength and versatility
- Anti-slip rubber feet
- Sturdy steel frame construction
- Specially designed for easy installation and cleaning
- Folded size: 150 x 610 x 900 mm

Code	Qty	Dimensions (mm)	Weight (kg)
9062FWB160	1	760x610x605	160

METALLIC TOOL BOXES

TWO HANDLE MODEL



902021 / 902031



902131

- Cantilever style tool box with fixed handles for easy opening
- Tube type handle is user friendly, specially if the box is very loaded
- Fixed dividers in the top trays make the small pieces storage comfortable and easy
- Hinge system allows easy opening of the lids and avoids dust entering the tool box
- The box can be locked by padlock
- All corners are bent or ground to avoid sharp edges
- Made of high degree metal sheet, ensures product performance and longevity

Code	Qty	Dimensions (mm)	Weight (kg)
902021	1	400x210x190	3.4
902031	1	500x210x190	4.1
902131	1	500x210x245	5.4



METALLIC TOOL BOXES

ALUMINIUM TOOL CASE WITH TOOLS, 97 pieces



R	Quantity	Dimensions (mm)	Weight (kg)
9024-1TS1	1	460x115x365	8.8
101-04-1, 101-045-1, 101-05-1, 101-055-1, 101-06-1, 101-07-1, 101-08-1, 101-09-1, 101-10-1, 101-11-1, 101-12-1, 101-13-1, 101-14-1			
121-08-1, 121-10-1, 121-11-1, 121-12-1, 121-13-1, 121-14-1, 121-16-1, 121-17-1, 121-19-1, 121-21-1, 121-22-1			
25-08-2, 25-09-2, 25-10-2, 25-11-2, 25-12-2, 25-13-2, 25-14-2, 25-17-2, 25-19-12			
407-5.5-125		409-1-100	
407-6.5-150		409-2-125	
105-70-1		105-50-1	
105-40-1		105-42-1	
105-22-1		105-24-1	
125-70-1		125-40-1	
125-23-1		125-25-1	
125-43-1			
46-8-F		475-32-1	
5-250C-1		604-160-1	
612-160-1		601-180-1	
625-180-1		634-250-1	
522-31-2		665-200-1	
980-3B-1			

ALUMINIUM TOOL CASE WITH TOOLS, 145 pieces



R	Quantity	Dimensions (mm)	Weight (kg)
9024-1TS145	1	450x115x290	12.5
101-04-1, 101-045-1, 101-05-1, 101-055-1, 101-06-1, 101-07-1, 101-08-1, 101-09-1, 101-10-1, 101-11-1, 101-12-1, 101-13-1, 101-14-1			
121-08-1, 121-10-1, 121-11-1, 121-12-1, 121-13-1, 121-14-1, 121-15-1, 121-16-1, 121-17-1, 121-18-1, 121-19-1, 121-21-1, 121-22-1, 121-24-1, 121-27-1, 121-30-1, 121-32-1			
25-08-2, 25-09-2, 25-10-2, 25-11-2, 25-12-2, 25-13-2, 25-14-2, 25-15-2, 25-16-2, 25-17-2, 25-18-2, 25-19-2			
105-70-1		105-50-1	
105-22-1		105-24-1	
105-40-1		105-42-1	
105-48-1		5-250C-1	
125-23-1		125-25-1	
125-70-1		125-40-1	
125-43-1		125-53-1, 125-54-1	
46-8-F		475-61-1	
801-041-1		980-5-1	
666-156-1		665-200-1	
520-43-2		L-ALUM-1	
634-250-1		632-220-1	
624-160-1		601-180-1	
612-160-1		604-160-1	
984-6D-1		475-5-1	



FABRIC BAGS

TOOL BAG WITH TUBULAR HANDLE



- 17" Open style bag for easy quick view and accessibility
- Soft bottom reinforced with plastic feet
- Hard waterproof bottom
- 11 Different vertical side pouches for better tool organization
- Aluminum handle for strengthening the structure with foam grip
- Detachable shoulder strap with cushion on the adjustable shoulder part for easier transportation
- 600x300 Denier fabric ensures product performance and longevity
- Delivered folded

9022-1-16SB	1	440x210x310	21	15	1.5

TOOL BAG WITH TUBULAR HANDLE



- 19" Open style bag for easy quick view and accessibility
- Soft bottom reinforced with plastic feet
- Hard waterproof bottom
- 12 Different vertical side pouches inside and outside for better tool organization and measuring tape holder
- Internal detachable panel with 10 pouches and elastics for tool holding
- Specific Velcro straps for spirit levels or any other long tool
- Aluminum handle for strengthening the structure with foam grip
- Detachable shoulder strap with cushion on the adjustable shoulder part for easier transportation
- 600x300 Denier fabric ensures product performance and longevity
- Delivered folded

9022-1-19HB	1	490x240x350	32	20	1.5

TOOL BAG WITH ZIP



- 16" Bag with zip closing system for quick view and accessibility
- Hard waterproof bottom
- 10 External divers size pouches and 14 internal vertical pouches for better tool organization
- Some external pouches are covered for better protecting and a measuring tape holder is also included
- Detachable shoulder strap with cushion on the adjustable shoulder part
- 600x300 Denier fabric ensures product performance and longevity

9022-2-16HB	1	420x240x300	24	18	1.2

TOOL BAG WITH ZIP



- 19" Bag with zip closing system for quick view and accessibility
- Hard waterproof bottom
- 17 External divers size pouches and 14 internal vertical pouches for better tool organization
- Some external pouches are covered for better protecting and a measuring tape holder is also included
- Detachable shoulder strap with cushion on the adjustable shoulder part
- 600x300 Denier fabric ensures product performance and longevity

9022-2-19HB	1	490x240x370	35	20	1.5

2



3



4



5



6



7



8



9



10



11



12





FABRIC BAGS

LAPTOP AND TOOL BACK-PACK



* The bag comes without tools

- Large storage capacity thanks to several pouches and a detachable tool organizer
- Foam inserts on the upper and lower back areas for better back protection
- Dedicated laptop compartment
- Side strap for compaction (width adjustment)
- Detachable part: 10 pockets of different sizes and elastic strap for better tool distribution
- Smartphone pocket within front compartment
- 600D fabric ensures product performance and long life
- Bottom part: 4 hard plastic support points for stability and protection against wet surfaces
- Reinforced handle

€					
9022-BP1	1	300x450x175	20	16	1.93

BACK-PACK WITH WHEELS



* The bag comes without tools

- Telescopic handle and two fixed wheels for easy transport
- Large storage capacity thanks to several internal/external pouches and a detachable tool organizer
- Side straps for compaction (width adjustment)
- Detachable organiser with two handles: 51 pockets of different sizes distributed on four sides for better tool distribution
- Large internal compartments, useful for long tools, laptop or documents
- Separate internal pocket with zip for wallet, keys and mobile phone
- Measuring tape holder
- Business card holders
- 600D fabric ensures product performance and long life
- Bottom part: 2 hard plastic support points for stability and protection against wet surfaces

€					
9022-BPW	1	360x440x220	26	20	4



POUCHES, BELTS AND FOLDERS

FOLDER – EMPTY



- Multiple elastics in bottom and lid for better tool distribution
- Double zip
- Rubber soft handle
- Net on the lid for documentation

9022-4-35	1	353x50x310	810

FOLDER – WITH 28 TOOLS



9022-4-35TS1	1	353x50x310	3

475R-1/4-110		46-9-H	
5-200C-1		624-160-1	
601-160-1		520-43-2	
668-150-1		980-5-1	
9022-4-35			

HAMMER HOLDER



9022-3-20	1	170x70x120	120

STRIKING SET



9022-3-20TS1	1	790

9022-3-20		520-43-2	
-----------	--	----------	--

STRIKING SET



9022-3-20TS2	1	790

9022-3-20		520-41-2	
-----------	--	----------	--

2



3



4



5



6



7



8



9



10



11



12



POUCHES, BELTS AND FOLDERS

PLIER POUCH



9022-3-30	1	260x95	40

TOOL POUCH



9022-3-40	1	290x10x150	60

ELECTRICIAN 4 PIECES SET IN POUCH



9022-3-30TS1	1	260x95x30	580

407-4-100		409-1-100	
601-180-1		668-150-1	
9022-3-30			

MRO 7 PIECES SET IN POUCH



9022-3-40TS1	1	290x60x150	1000

407-6.5-150		409-2-125	
624-140-1		601-160-1	
665-200-1		5-150C-1	
9022-3-40		980-3-1	

ELECTRICIAN 4 PIECES SET IN POUCH



9022-3-30TS2	1	260x95x30	550

407-4-100		409-1-100	
624-160-1		668-150-1	
9022-3-30			

INSULATED 7 PIECES SET IN POUCH



9022-3-40TS2	1	290x60x150	1000

408V-4-100		409V-1-150	
624V-160-1		612V-160-1	
665-200-1		5-150C-1	
9022-3-40		980-3-1	



10 POCKETS TOOL POUCH



9022-3-50	1	260x70x355	480

ADJUSTABLE BELT



9022-3-10	1	1500x10x75	200

MRO 9 PIECES SET IN POUCH



9022-3-50TS1	1	260x95x355	2400

407-5.5-125		409-1-100	
407-6.5-150		409-2-125	
520-43-2		634-250-1	
624-160-1		982-TOR-1	
9022-3-50		980-5-1	

2



3



4



5



6



7



8



9



10



11



12





02.

WRENCHES

ADJUSTABLE WRENCHES

Side nut adjustable invented by IRIMO



ISO + 125%

HEAVY DUTY ADJUSTABLE WRENCH

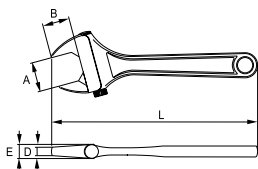

- Material: CrV
- Finish: Chrome-plated matt finished
- Hardness: 40-45 HRc
- Jaws angled at 15° to give good access even in confined spaces
- Standards: UNE 16532, ISO 6787, DIN 3117

R			A mm	B mm	D mm	E mm	L mm	g
001021	5	150 mm - 6"	21	18.5	6.5	12	155	140
001031	5	200 mm - 8"	29	26	8	14	205	290
001041	5	250 mm - 10"	34	32	9	17	255	510
001051	3	300 mm - 12"	39	36	10	20	305	795
001061	1	400 mm - 16"	49	44	14	26	405	1.620
001071	1	500 mm - 20"	62	53	17	30	500	2.860
001081	1	750 mm - 30"	78	70	23	37	750	5.550

CENTRAL NUT



- Material: CrV
- Black finish
- Hardness: 40-45 HRC
- Jaws angled at 15° to give access even in confined spaces
- Standards: UNE 16532, ISO 6787, DIN 3117
- -1 Retail packaging
- -2 Industrial packaging

Q	Icon	Icon	A	B	D	E	L	g
			mm	mm	mm	mm	mm	
5-100-1	5	100 mm - 4"	13	13.5	3.5	9	115	60
5-150-1	5	150 mm - 6"	20	21	5.5	12	160	130
5-200-1	5	200 mm - 8"	24	26	7.5	13.5	205	250
5-250-1	5	250 mm - 10"	29	29.5	9	16	260	405
5-300-1	5	300 mm - 12"	36	36	11	19	310	650
5-100-2	60	100 mm - 4"	13	13.5	3.5	9	115	60
5-150-2	50	150 mm - 6"	20	21	5.5	12	160	130
5-200-2	40	200 mm - 8"	24	26	7.5	13.5	205	250
5-250-2	30	250 mm - 10"	29	29.5	9	16	260	405
5-300-2	20	300 mm - 12"	36	36	11	19	310	650
5-375-2	1	375 mm - 15"	43	45	13	24	385	1.230
5-450-2	1	450 mm - 18"	57	53	15	27.5	465	2.000

CENTRAL NUT

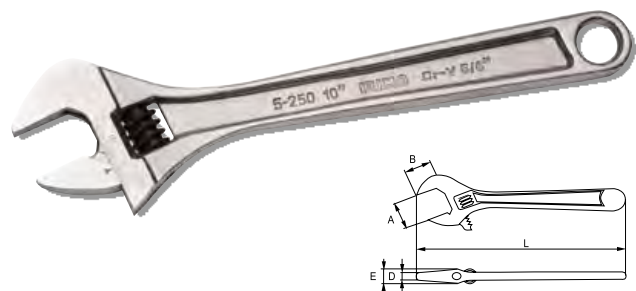

- Material: CrV
- Finish: Chrome-plated
- Hardness: 40-45 HRC
- Jaws angled at 15° to give good access even in confined spaces
- Standards: UNE 16532, ISO 6787, DIN 3117
- -1 Retail packaging
- -2 Industrial packaging

Q	Icon	Icon	A	B	D	E	L	g
			mm	mm	mm	mm	mm	
5-100C-1	5	100 mm - 4"	13	13.5	3.5	9	115	60
5-150C-1	5	150 mm - 6"	20	21	5.5	12	160	130
5-200C-1	5	200 mm - 8"	24	26	7.5	13.5	205	250
5-250C-1	5	250 mm - 10"	29	29.5	9	16	260	405
5-300C-1	5	300 mm - 12"	36	36	11	19	310	650
5-375C-2	1	375 mm - 15"	43	45	13	24	385	1.230
5-450C-2	1	450 mm - 18"	57	53	15	27.5	465	2.000

PHOSPHATED ADJUSTABLE WRENCH SET



- Material: CrV; Black finish
- Hardness: 40-45 HRC
- Jaws angled at 15° to give access even in confined spaces
- Standards: UNE 16532, ISO 6787, DIN 3117

Q	Icon	Icon	Icon	g
5-4-W	1	4	50x330x110	1.500

5-150-2, 5-200-2, 5-250-2, 5-300-2



OPEN END WRENCHES

DOUBLE OPEN END WRENCHES

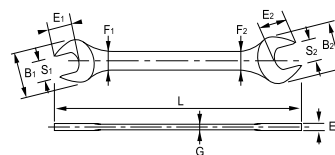

- Material: High performance alloy steel, CrV
- Finish: Chrome-plated matt finished
- Hardness: 42-50 HRC
- Standards: DIN 3110, ISO 10102, ISO 1085, ISO 1711, ISO 691, ISO 3318

R		S1 x S2 mm	L mm	B1 mm	B2 mm	F1 mm	F2 mm	E1 mm	E2 mm	E mm	G mm	g
10-0405-1	1	4x5	105	13	15	6.5	7.5	7.2	7	3.2	2.5	15
10-0607-1	1	6x7	122	17.4	19.4	7.5	8.5	8.1	9	4.1	2.8	21
10-0809-1	1	8x9	137	20.4	22.4	8.5	9.5	10.5	11.2	4.6	3.3	30
10-1011-1	1	10x11	151.4	24.2	27.2	10.5	11.5	11.6	13.3	5.4	3.8	46
10-1013-1	1	10x13	151.4	24.2	37.2	10.5	11.5	11.6	13.3	5.4	3.8	46
10-1213-1	1	12x13	166.5	29.4	31.4	12.5	13.5	13.6	15.3	6.1	4	66
10-1415-1	1	14x15	182	32.4	35.4	13.5	14.5	16	17.5	6.5	4.4	95
10-1617-1	1	16x17	196.5	36.4	38.4	15.5	16.5	18.5	19.6	6.9	4.8	124
10-1719-1	1	17x19	221	40.4	42.4	16.5	18.5	20.8	22.4	7.4	5.1	160
10-1819-1	1	18x19	211.9	40.4	42.4	16.5	18.5	20.8	21.2	7.4	5.1	157
10-2022-1	1	20x22	226.9	43.4	47.4	18.5	19.5	23.3	24.5	8.6	5.6	188
10-2123-1	1	21x23	241.9	46.4	50.4	18.5	20.5	23.6	26	9.2	5.8	211
10-2224-1	1	22x24	241.9	46.4	50.4	18.5	20.5	23.6	26	9.2	5.8	208
10-2426-1	1	24x26	261.9	50.4	54.4	21.5	23.5	27.9	29.8	10	6.2	293
10-2427-1	1	24x27	261.9	50.4	54.4	21.5	23.5	27.9	29.8	10	6.2	284
10-2528-1	1	25x28	281.9	54.4	59.4	23.5	24.5	28.6	30.7	10.6	6.6	366
10-2729-1	1	27x29	282.4	54.6	59.6	23.5	24.5	28.6	30.7	10.6	6.6	362
10-3032-1	1	30x32	302.9	61.4	68.4	24.5	26.5	33.4	35.5	11	7	481

DOUBLE OPEN END WRENCH SET



- Material: High performance alloy steel, CrV
- Finish: Chrome-plated matt finished
- Hardness: 42-50 HRc
- Standards: DIN 3110, ISO 10102, ISO 1085, ISO 1711, ISO 691, ISO 3318

10-8-H	1	8	250x120x50	870

10-0607-1, 10-0809-1, 10-1011-1, 10-1213-1, 10-1415-1, 10-1617-1, 10-1819-1, 10-2022-1

DOUBLE OPEN END WRENCH SET



- Material: High performance alloy steel, CrV
- Finish: Chrome-plated matt finished
- Hardness: 42-50 HRc
- Standards: DIN 3110, ISO 10102, ISO 1085, ISO 1711, ISO 691, ISO 3318

10-12-H	1	12	350x150x70	2.975

10-0607-1, 10-0809-1, 10-1011-1, 10-1213-1, 10-1415-1, 10-1617-1, 10-1819-1, 10-2022-1, 10-2123-1, 10-2426-1, 10-2528-1, 10-3032-1

DOUBLE OPEN END WRENCH SET



- Material: High performance alloy steel, CrV
- Finish: Chrome-plated matt finished
- Hardness: 42-50 HRc
- Standards: DIN 3110, ISO 10102, ISO 1085, ISO 1711, ISO 691, ISO 3318

10-12-W	1	12	400x140x100	2.975

10-0607-1, 10-0809-1, 10-1011-1, 10-1213-1, 10-1415-1, 10-1617-1, 10-1819-1, 10-2022-1, 10-2123-1, 10-2426-1, 10-2528-1, 10-3032-1

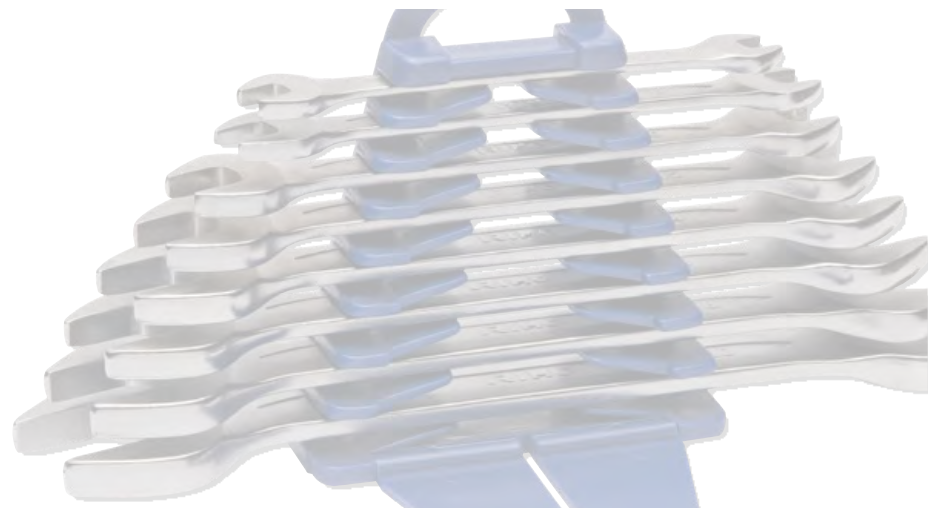

COMBINATION WRENCHES

COMBINATION WRENCHES IN MM

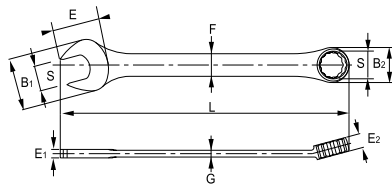

- Material: High performance alloy steel, CrV
- Finish: Chrome-plated matt finished
- Hardness: 42-50 HRc
- Standards: DIN 3113, ISO 1711-1, ISO 3318, ISO 691, ISO 7738
- -1 Retail packaging
- -2 Industrial packaging

R	S mm	L mm	B1 mm	B2 mm	F mm	E mm	E1 mm	E2 mm	G mm	g	
25-06-1	1	6	103	15.7	10.6	6.2	7.9	3.7	5.2	3	15
25-07-1	1	7	109	18	12.1	6.8	8.2	3.7	5.5	3	17
25-08-1	1	8	119	18.8	13.6	6.8	9.9	4.0	6	3.3	21
25-09-1	1	9	124	21	15.1	7.9	10.4	4.0	6.8	3.4	26
25-10-1	1	10	134	22.8	16.2	8.6	10.7	4.8	7	3.6	38
25-11-1	1	11	143	25.8	17.1	9.1	12.6	4.8	7.5	3.6	39
25-12-1	1	12	154	27.8	18.9	10	13.2	5.2	8	4.2	51
25-13-1	1	13	164	29.8	20.2	11.5	14.6	5.2	8.3	4.2	63
25-14-1	1	14	174	29.8	21.2	11.4	15.8	5.8	8.9	4.6	68
25-15-1	1	15	183	34.1	22.3	12.2	16.9	5.8	8.9	4.6	85
25-16-1	1	16	194	35.1	23.8	13.2	17.6	6.3	9.5	5	107
25-17-1	1	17	203	37.2	25.3	14.4	18.6	6.3	10	5	118
25-18-1	1	18	214	39.2	26.8	14.4	20.5	6.7	10.5	5.2	137
25-19-1	1	19	228	41.4	28.3	15.8	21.1	7.0	11.2	5.2	163
25-20-1	1	20	240	42.4	29.7	17.3	22.8	7.5	11.4	5.5	186
25-21-1	1	21	249.5	45.4	32.4	17.3	22.8	8.6	12.6	6	210
25-22-1	1	22	249.5	45.4	32.4	17.3	22.8	8.6	12.2	6	202
25-23-1	1	23	270	49.7	36.1	20.3	25	9.2	13.6	6.4	281
25-24-1	1	24	270	49.7	36.1	20.3	25	9.2	13.6	6.4	276
25-25-1	1	25	289.5	53.4	39.6	22.5	27.6	9.6	14.2	6.8	346
25-26-1	1	26	289.5	53.4	39.6	22.5	27.6	9.6	14.2	6.8	345
25-27-1	1	27	310	58.4	41.6	23.3	29.5	10.0	14.6	7.2	382
25-28-1	1	28	310	58.4	41.6	23.3	29.5	10.0	14.6	7.2	402
25-29-1	1	29	330	60.4	45.6	23.3	32.1	10.6	15.6	7.6	476
25-30-1	1	30	330	60.4	45.6	23.3	32.1	10.6	15.6	7.6	468
25-32-1	1	32	349	67.4	48.8	25.3	35.6	11.2	17.8	8	567
25-34-1	1	34	350	67.4	48.8	25.3	35.6	11.2	17.8	8	541
25-19-2	1	19	228	41.4	28.3	15.8	21.1	7.0	11.2	5.2	163
25-20-2	1	20	240	42.4	29.7	17.3	22.8	7.5	11.4	5.5	186
25-21-2	1	21	249.5	45.4	32.4	17.3	22.8	8.6	12.6	6	210
25-22-2	1	22	249.5	45.4	32.4	17.3	22.8	8.6	12.2	6	202
25-23-2	1	23	270	49.7	36.1	20.3	25	9.2	13.6	6.4	281
25-24-2	1	24	270	49.7	36.1	20.3	25	9.2	13.6	6.4	276
25-25-2	1	25	289.5	53.4	39.6	22.5	27.6	9.6	14.2	6.8	346
25-26-2	1	26	289.5	53.4	39.6	22.5	27.6	9.6	14.2	6.8	345
25-27-2	1	27	310	58.4	41.6	23.3	29.5	10.0	14.6	7.2	382
25-28-2	1	28	310	58.4	41.6	23.3	29.5	10.0	14.6	7.2	402
25-29-2	1	29	330	60.4	45.6	23.3	32.1	10.6	15.6	7.6	476
25-30-2	1	30	330	60.4	45.6	23.3	32.1	10.6	15.6	7.6	468
25-32-2	1	32	349	67.4	48.8	25.3	35.6	11.2	17.8	8	567
25-34-2	1	34	350	67.4	48.8	25.3	35.6	11.2	17.8	8	541
25-36-2	1	36	401	74	54	31	62	10.4	17	8	787
25-41-2	1	41	436	82	61	34	70	12	19.5	8	1.070
25-46-2	1	46	556	92	66	33.6	79.8	15	23	11	1.750
25-50-2	1	50	602	100	73	36.6	86.7	17	26	12	2.200
25-55-2	1	55	612	113	84	42	94	18	28	14.5	3.070
25-60-2	1	60	660	125	90	47	100	20	30	16	3.500
25-65-2	1	65	710	132	98	52	110	21	34	18	4.750
25-70-2	1	70	760	140	102	52	110	22	35	18	5.550
25-75-2	1	75	810	150	108	55	120	25	38	19	6.800
25-80-2	1	80	820	179	131	60	120	30	38	20	10.000
25-85-2	1	85	820	179	131	60	120	30	38	20	10.000
25-90-2	1	90	790	179	131	60	120	30	38	20	10.000
25-95-2	1	95	860	187	145	62	120	32	43	20	12.000
25-100-2	1	100	860	187	145	62	120	32	43	20	12.000

R	S mm	L mm	B1 mm	B2 mm	F mm	E mm	E1 mm	E2 mm	G mm	g	
25-06-2	1	6	103	15.7	10.6	6.2	7.9	3.7	5.2	3	15
25-07-2	1	7	109	18	12.1	6.8	8.2	3.7	5.5	3	17
25-08-2	1	8	119	18.8	13.6	6.8	9.9	4.0	6	3.3	21
25-09-2	1	9	124	21	15.1	7.9	10.4	4.0	6.8	3.4	26
25-10-2	1	10	134	22.8	16.2	8.6	10.7	4.8	7	3.6	38
25-11-2	1	11	143	25.8	17.1	9.1	12.6	4.8	7.5	3.6	39
25-12-2	1	12	154	27.8	18.9	10	13.2	5.2	8	4.2	51
25-13-2	1	13	164	29.8	20.2	11.5	14.6	5.2	8.3	4.2	63
25-14-2	1	14	174	29.8	21.2	11.4	15.8	5.8	8.9	4.6	68
25-15-2	1	15	183	34.1	22.3	12.2	16.9	5.8	8.9	4.6	85
25-16-2	1	16	194	35.1	23.8	13.2	17.6	6.3	9.5	5	107
25-17-2	1	17	203	37.2	25.3	14.4	18.6	6.3	10	5	118
25-18-2	1	18	214	39.2	26.8	14.4	20.5	6.7	10.5	5.2	137
25-19-2	1	19	228	41.4	28.3	15.8	21.1	7.0	11.2	5.2	163
25-20-2	1	20	240	42.4	29.7	17.3	22.8	7.5	11.4	5.5	186
25-21-2	1	21	249.5	45.4	32.4	17.3	22.8	8.6	12.6	6	210
25-22-2	1	22	249.5	45.4	32.4	17.3	22.8	8.6	12.2	6	202
25-23-2	1	23	270	49.7	36.1	20.3	25	9.2	13.6	6.4	281
25-24-2	1	24	270	49.7	36.1	20.3	25	9.2	13.6	6.4	276
25-25-2	1	25	289.5	53.4	39.6	22.5	27.6	9.6	14.2	6.8	346
25-26-2	1	26	289.5	53.4	39.6	22.5	27.6	9.6	14.2	6.8	345
25-27-2	1	27	310	58.4	41.6	23.3	29.5	10.0	14.6	7.2	382
25-28-2	1	28	310	58.4	41.6	23.3	29.5	10.0	14.6	7.2	402
25-29-2	1	29	330	60.4	45.6	23.3	32.1	10.6	15.6	7.6	476
25-30-2	1	30	330	60.4	45.6	23.3	32.1	10.6	15.6	7.6	468
25-32-2	1	32	349	67.4	48.8	25.3	35.6	11.2	17.8	8	567
25-34-2	1	34	350	67.4	48.8	25.3	35.6	11.2	17.8	8	541
25-36-2	1	36	401	74	54	31	62	10.4	17	8	787
25-41-2	1	41	436	82	61	34	70	12	19.5	8	1.070
25-46-2	1	46	556	92	66	33.6	79.8	15	23	11	1.750
25-50-2	1	50	602	100	73	36.6	86.7	17	26	12	2.200
25-55-2	1	55	612	113	84	42	94	18	28	14.5	3.070
25-60-2	1	60	660	125	90	47	100	20	30	16	3.500
25-65-2	1	65	710	132	98	52	110	21	34	18	4.750
25-70-2	1	70	760	140	102	52	110	22	35	18	5.550
25-75-2	1	75	810	150	108	55	120	25	38	19	6.800
25-80-2	1	80	820	179	131	60	120	30	38	20	10.000
25-85-2	1	85	820	179	131	60	120	30	38	20	10.000
25-90-2	1	90	790	179	131	60	120	30	38	20	10.000
25-95-2	1	95	860	187	145	62	120	32	43	20	12.000
25-100-2	1	100	860	187	145	62	120	32	43	20	12.000

COMBINATION WRENCHES IN INCHES



- Material: High performance alloy steel, CrV
- Finish: Chrome-plated matt finished
- Hardness: 42-50 HRC
- Standards: DIN 3113, ISO 1711-1, ISO 3318, ISO 691, ISO 7738
- -1 Retail packaging
- -2 Industrial packaging

Q	Icon	S	L	B1	B2	F	E	E1	E2	G	g
		mm	mm	mm	mm	mm	mm	mm	mm	mm	
25A-08-1	1	1/4"	103	15.9	10.6	6.6	7.9	3.7	5.2	3	15
25A-10-1	1	5/16"	119	19	13.6	7.2	9.9	4	6	3.3	21
25A-12-1	1	3/8"	124	21.2	15.1	8.3	10.4	4	6.8	3.4	26
25A-14-1	1	7/16"	143	26	17.1	9.5	12.6	4.8	7.5	3.6	39
25A-16-1	1	1/2"	164	30	20.2	11.9	14.6	5.2	8.3	4.2	63
25A-18-1	1	9/16"	174	30	21.2	11.8	15.8	5.8	8.9	4.6	68
25A-20-1	1	5/8"	194	35.3	23.8	13.6	17.6	6.3	9.5	5	107
25A-22-1	1	11/16"	214	39.4	26.8	14.8	20.5	6.7	10.5	5.2	137
25A-24-1	1	3/4"	228	41.6	28.3	16.2	21.1	7	11.2	5.2	163
25A-26-1	1	13/16"	249.5	45.4	32.4	17.3	22.8	8.6	12.6	6	210
25A-28-1	1	7/8"	249.5	45.4	32.4	17.3	22.8	8.6	12.6	6	210
25A-30-1	1	15/16"	270	49.7	36.1	20.3	25	9.2	13.6	6.4	281
25A-32-1	1	1"	289.5	53.4	39.6	22.5	27.6	9.6	14.2	6.8	346
25A-34-1	1	1.1/16"	310	58.4	41.6	23.3	29.5	10	14.6	7.2	382
25A-36-1	1	1.1/8"	330	60.4	45.6	23.3	32.1	10.6	15.6	7.6	476
25A-40-1	1	1.1/4"	349	67.4	48.8	25.3	35.6	11.2	17.8	8	567
25A-44-1	1	1.3/8"	350	67.4	48.8	25.3	35.6	11.2	17.8	8	541
25A-46-1	1	1.7/16"	401	74	54	31	62	10.4	17	8	787
25A-48-1	1	1.1/2"	401	74	54	31	62	10.4	17	8	787
25A-52-1	1	1.5/8"	435	80	61	34	70	11.5	19.5	8	1.050
25A-58-1	1	1.13/16"	555	91	66	34	79.8	15	23	11	1.850
25A-64-1	1	2"	602	100	73	36.6	86.7	17	26	12	2.215
25A-08-2	1	1/4"	103	15.9	10.6	6.6	7.9	3.7	5.2	3	15
25A-10-2	1	5/16"	119	19	13.6	7.2	9.9	4	6	3.3	21
25A-12-2	1	3/8"	124	21.2	15.1	8.3	10.4	4	6.8	3.4	26
25A-14-2	1	7/16"	143	26	17.1	9.5	12.6	4.8	7.5	3.6	39
25A-16-2	1	1/2"	164	30	20.2	11.9	14.6	5.2	8.3	4.2	63
25A-18-2	1	9/16"	174	30	21.2	11.8	15.8	5.8	8.9	4.6	68
25A-20-2	1	5/8"	194	35.3	23.8	13.6	17.6	6.3	9.5	5	107
25A-22-2	1	11/16"	214	39.4	26.8	14.8	20.5	6.7	10.5	5.2	137
25A-24-2	1	3/4"	228	41.6	28.3	16.2	21.1	7	11.2	5.2	163
25A-26-2	1	13/16"	249.5	45.4	32.4	17.3	22.8	8.6	12.6	6	210
25A-28-2	1	7/8"	249.5	45.4	32.4	17.3	22.8	8.6	12.6	6	210
25A-30-2	1	15/16"	270	49.7	36.1	20.3	25	9.2	13.6	6.4	281
25A-32-2	1	1"	289.5	53.4	39.6	22.5	27.6	9.6	14.2	6.8	346

COMBINATION WRENCH SET



- Material: High performance alloy steel, CrV
- Finish: Chrome-plated matt finished
- Hardness: 42-50 HRC
- Standards: DIN 3113, ISO 1711-1, ISO 3318, ISO 691, ISO 7738

Q	Icon	Icon	Icon	g
25-8-H	1	8	250x120x50	875

25-08-1, 25-10-1, 25-11-1, 25-13-1, 25-14-1, 25-17-1, 25-19-1, 25-22-1

COMBINATION WRENCH SET



- Material: High performance alloy steel, CrV
- Finish: Chrome-plated matt finished
- Hardness: 42-50 HRC
- Standards: DIN 3113, ISO 1711-1, ISO 3318, ISO 691, ISO 7738

Q	Icon	Icon	Icon	g
25-12-H	1	12	350x50x70	2.975

25-10-1, 25-11-1, 25-12-1, 25-13-1, 25-14-1, 25-17-1, 25-19-1, 25-22-1, 25-24-1, 25-27-1, 25-30-1, 25-32-1

COMBINATION WRENCH SET



- High performance alloy steel, CrV
- Finish: Chrome-plated matt finished
- Hardness: 42-50 HRC
- Standards: DIN 3113, ISO 1711-1, ISO 3318, ISO 691, ISO 7738

Q	Icon	Icon	Icon	g
25-12-W	1	12	400x140x100	2.975

25-10-1, 25-11-1, 25-12-1, 25-13-1, 25-14-1, 25-17-1, 25-19-1, 25-22-1, 25-24-1, 25-27-1, 25-30-1, 25-32-1

RATCHETING COMBINATION WRENCHES

RATCHETING COMBINATION WRENCH



- Material: High performance alloy steel
- Finish: Chrome-plated matt finished
- Hardness: 40-50 HRc

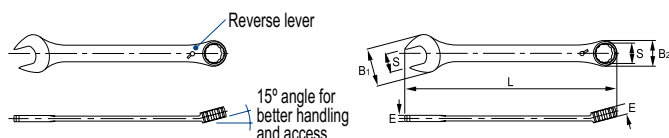

Strong ratchet exceeds ISO plus endurance

R	Box	S mm	B1 mm	B2 mm	E mm	L mm	g
18-06-1	1	6	15	14.3	4	128	27
18-07-1	1	7	16.4	16.8	4.4	138	35
18-08-1	1	8	18	18.3	4.8	140	38
18-09-1	1	9	20	20	4.8	150	48
18-10-1	1	10	22	21.5	5.1	160	57
18-11-1	1	11	24.5	23.5	5.5	165	67
18-12-1	1	12	26	25	5.9	170	82
18-13-1	1	13	28	26.4	6.4	180	95
18-14-1	1	14	30.8	28	6.7	190	113
18-15-1	1	15	33	30	7.3	200	130
18-16-1	1	16	24.5	31	7.8	210	158
18-17-1	1	17	37	33	8	225	180
18-18-1	1	18	39.5	35	8.2	235	213
18-19-1	1	19	40.8	36	8.4	245	233
18-21-1	1	21	44.8	42	9	290	343
18-22-1	1	22	44.8	42	9	290	345
18-24-1	1	24	52.8	48	9.7	332	503
18-27-1	1	27	56	53	10.8	359	550
18-30-1	1	30	62	58	11.2	404	750
18-32-1	1	32	65	62	12	424	900

RATCHETING COMBINATION WRENCH SET



- Ratcheting combination wrench set
- Material: High performance alloy steel
- Finish: Chrome-plated matt finished
- Hardness: 40-50 HRc

R	Box	X	mm	g
18-8-H	1	8	45x245x130	870

18-08-1, 18-10-1, 18-11-1, 18-12-1, 18-13-1, 18-14-1, 18-17-1, 18-19-1

RATCHETING COMBINATION WRENCH SET



- Material: High performance alloy steel
- Finish: Chrome-plated matt finished
- Hardness: 40-50 HRc

R	Box	X	mm	g
18-12-H	1	12	180x35x250	1.510

18-08-1, 18-09-1, 18-10-1, 18-11-1, 18-12-1, 18-13-1, 18-14-1, 18-15-1, 18-16-1, 18-17-1, 18-18-1, 18-19-1

STUBBY RATCHETING COMBINATION WRENCHES

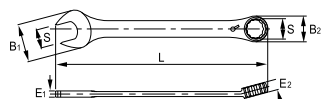

- Material: High performance alloy steel
- Finish: Chrome-plated matt finished
- Hardness: 40-50 HRc
- -1 retail packaging

Code	Packaging	S mm	B1 mm	B2 mm	E1 mm	E2 mm	L mm	g
18S-08-1	1	8	18	18.3	5.3	7.2	90	30
18S-10-1	1	10	22	22	6.0	7.8	96	48
18S-13-1	1	13	28	28	6.8	9.1	108	72
18S-17-1	1	17	37	37	8.1	10.5	128	125
18S-19-1	1	19	40.8	40.8	8.5	11.2	138	163

STUBBY RATCHETING COMBINATION WRENCH SET



- Material: High performance alloy steel
- Finish: Chrome-plated matt finished
- Hardness: 40-50 HRc

Code	Packaging	Quantity	Dimensions	g
18S-5-H	5	5	8-10-13-17-19 mm	462

RATCHETING DOUBLE RING WRENCH SET



- Material: High performance alloy steel
- Finish: Chrome-plated matt finished
- Hardness: 40-50 HRc

Code	Packaging	Quantity	Dimensions	g
18D-5-H	5	5	8x9, 10x11, 12x13, 16x17, 18x19 mm	664

FLEX HEAD RATCHETING COMBINATION WRENCHES

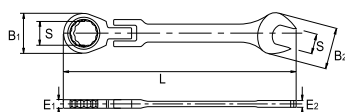

- Material: High performance alloy steel
- Finish: Chrome-plated
- Hardness: 40-50 HRc

Code	Packaging	S mm	B1 mm	B2 mm	E1 mm	E2 mm	L mm	g
19-08-1	1	8	18.3	18	7.2	4.8	140	35
19-10-1	1	10	21.5	22	7.8	5.1	160	55
19-11-1	1	11	23.5	24.5	8.4	5.5	165	63
19-12-1	1	12	25	26	8.8	5.9	170	83
19-13-1	1	13	26.4	28	9.1	6.4	180	93
19-14-1	1	14	28	30.8	9.4	6.7	190	113
19-17-1	1	17	33	37	10.5	8	225	173
19-19-1	1	19	36.5	40.8	11.2	8.4	245	233

RATCHETING COMBINATION WRENCHES

FLEX HEAD RATCHETING COMBINATION WRENCH SET



- Material: High performance alloy steel
- Finish: Chrome-plated matt finished
- Hardness: 40-50 HRC

R	📦	📦	📦	g
19-8-H	1	8	45x240x140	850

19-08-1, 19-10-1, 19-11-1, 19-12-1, 19-13-1, 19-14-1, 19-17-1, 19-19-1

FLEX HEAD RATCHETING COMBINATION WRENCH SET



- Material: High performance alloy steel
- Finish: Chrome-plated matt finished
- Hardness: 40-50 HRC

R	📦	📦	📦	g
19-12-H	1	12	35 x 180 x 250	1.724

19-08-1, 19-09-1, 19-10-1, 19-11-1, 19-12-1, 19-13-1, 19-14-1, 19-15-1, 19-16-1, 19-17-1, 19-18-1, 19-19-1

FLAT RING WRENCHES

DOUBLE RING END WRENCHES



- Material: High performance alloy steel, CrV
- Finish: Chrome-plated matt finished
- Hardness: 42-48 HRC
- Standards: DIN 837, ISO 10103, ISO 1085

R	📦	S1x S2 mm	B1 mm	B2 mm	E mm	L mm	g
020011	1	6x7	9.8	11	4.5	95	14
020031	1	8x9	12.5	14	5.5	110	22
020051	1	10x11	15	16.5	6	125	32
020071	1	12x13	18.5	20	6.5	140	46
020091	1	14x15	21	22.5	7	155	57
020121	1	16x17	24	25	7.5	170	73
020141	1	18x19	26.5	27.5	8	185	94
020171	1	20x22	29	32	9	205	125
020181	1	21x23	30	33	9.5	225	154
020201	1	24x26	35	37.8	11	250	210
020211	1	24x27	35	37.5	11	250	208
020221	1	25x28	37.5	41	11	275	280
020241	1	27x29	37.5	41	11	275	272
020251	1	30x32	43	45.5	12	300	367

DOUBLE RING END WRENCHES SET



- Material: High performance alloy steel, CrV
- Finish: Chrome-plated matt finished
- Hardness: 42-48 HRC
- Standards: DIN 837, ISO 10103, ISO 1085

R	📦	📦	📏	g
021221	1	8	6-7, 8-9, 10-11, 12-13, 14-15, 16-17, 18-19, 20-22 mm	500
021251	1	12	6-7, 8-9, 10-11, 12-13, 14-15, 16-17, 18-19, 20-22, 21-23, 24-27, 25-28, 30-32 mm	1.550

OFFSET RING WRENCHES

DOUBLE OFFSET RING WRENCHES

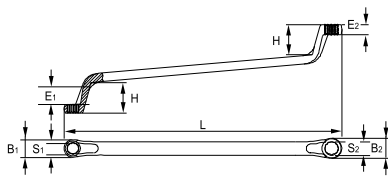

- Material: High performance alloy steel
- Finish: Chrome-plated matt finished
- Hardness: 42-48 HRC
- Standards: ISO 10104 and DIN 838
- -1 Retail packaging
- -2 Industrial packaging

E		S1x S2 mm	B1 mm	B2 mm	E1 mm	E2 mm	H mm	L mm	g
15-0607-1	1	6x7	10.8	12.5	4.9	5.6	20	170	45
15-0809-1	1	8x9	13.4	15.3	6.0	6.8	21	182	70
15-1011-1	1	10x11	16.0	17.8	7.4	7.9	23	197	90
15-1213-1	1	12x13	18.8	20.2	8.4	8.9	25	213	126
15-1415-1	1	14x15	20.8	22.5	9.4	9.9	26	228	155
15-1617-1	1	16x17	24.2	25.7	10.4	10.9	29	246	193
15-1719-1	1	17x19	27.6	28.7	11.4	11.9	31	265	243
15-1819-1	1	18x19	27.6	28.7	11.4	11.9	31	265	241
15-2022-1	1	20x22	29.7	32.5	12.4	12.9	33	288	315
15-2123-1	1	21x23	31.0	33.2	12.3	13.3	33	310	341
15-2426-1	1	24x26	34.8	39.2	13.7	14.3	34	330	478
15-2427-1	1	24x27	34.8	39.2	13.7	14.3	34	330	475
15-2528-1	1	25x28	36.6	40.5	14.2	14.7	35	348	548
15-2729-1	1	27x29	42.0	45.2	15.0	16.0	37	372	662
15-3032-1	1	30x32	42.2	45.5	14.8	15.8	37	372	635
15-3236-2	1	32x36	48.5	54.0	16.5	17.8	41	417	962
15-3641-2	1	36x41	53.5	62.0	17.3	19.2	48	450	1.037

DOUBLE OFFSET RING WRENCHES SET



- Material: High performance alloy steel
- Finish: Chrome-plated matt finished
- Hardness: 42-48 HRC
- Standards: ISO 10104 and DIN 838

E				g
15-8-H	1	8	6-7, 8-9, 10-11, 12-13, 14-15, 16-17, 18-19, 20-22 mm	1.245

DOUBLE OFFSET RING WRENCHES SET



- Material: High performance alloy steel
- Finish: Chrome-plated matt finished
- Hardness: 42-48 HRC
- Standards: ISO 10104 and DIN 838

E				g
15-8-W	1	8	6-7, 8-9, 10-11, 12-13, 14-15, 16-17, 18-19, 20-22 mm	1.350
15-12-W	1	12	6-7, 8-9, 10-11, 12-13, 14-15, 16-17, 18-19, 20-22, 21-23, 24-27, 25-28, 30-32 mm	3.465



L-PIPE DOUBLE SOCKET WRENCHES

L-PIPE DOUBLE SOCKET WRENCHES

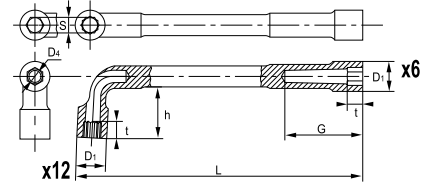

- Material: High performance alloy steel
- Finish: Chrome-plated matt finished
- Hardness: 40-50 HRc
- Standards: ISO 1711, ISO 691, ISO 2236

6x12		6x6		S	Icon	D1 mm	D4 mm	G mm	h mm	t mm	L mm	g
Q	Q	Q	Q									
51-06-1	52-06-1	6	1	10	4.5	21.0	17	6.0	102	30		
51-07-1	52-07-1	7	1	11	4.5	22.0	17.5	7.0	106	40		
51-08-1	52-08-1	8	1	12.5	7.0	25.0	19.5	8.0	114	60		
51-09-1	52-09-1	9	1	13.5	7.0	26.0	20.0	9.0	122	70		
51-10-1	52-10-1	10	1	15.0	8.0	28.0	24.0	10.0	129	90		
51-11-1	52-11-1	11	1	16.5	8.0	30.0	26.5	11.0	136	120		
51-12-1	52-12-1	12	1	18.0	9.0	36.0	28.0	11.0	144	150		
51-13-1	52-13-1	13	1	19.5	9.0	38.6	30.0	12.0	152	160		
51-14-1	52-14-1	14	1	21.0	10.5	40.0	31.5	13.0	160	190		
51-15-1	52-15-1	15	1	22.5	10.5	42.0	34.0	14.0	169	200		
51-16-1	52-16-1	16	1	24.0	13.0	46.0	37.0	16.0	178	280		
51-17-1	52-17-1	17	1	25.5	13.0	48.0	39.0	17.0	187	300		
51-18-1	52-18-1	18	1	26.5	13.0	50.0	40.0	18.0	195	310		
51-19-1	52-19-1	19	1	28.5	15.0	51.0	41.0	19.0	204	420		
51-20-1	52-20-1	20	1	29.5	15.0	53.0	43.0	20.0	212	450		
51-21-1	52-21-1	21	1	30.5	15.0	55.0	46.0	21.0	221	470		
51-22-1	52-22-1	22	1	32.0	15.0	57.0	48.0	22.0	230	530		
51-23-1	52-23-1	23	1	33.5	18.0	64.0	50.5	23.0	240	650		
51-24-1	52-24-1	24	1	34.5	18.0	67.0	54.0	24.0	250	630		
51-25-1	52-25-1	25	1	36.0	20.0	69.0	56.0	25.0	260	830		
51-26-1	52-26-1	26	1	37.0	20.0	70.0	58.5	26.0	270	860		
51-27-1	52-27-1	27	1	38.0	22.0	73.0	58.0	27.0	280	990		
51-28-1	52-28-1	28	1	39.5	22.0	75.0	60.0	28.0	290	1.000		
51-29-1	52-29-1	29	1	41.0	22.0	76.0	62.0	29.0	300	1.080		
51-30-1	52-30-1	30	1	42.0	24.0	83.0	64.0	30.0	310	1.220		
51-32-1	52-32-1	32	1	44.5	24.0	88.0	70.0	31.0	330	1.380		

L-PIPE DOUBLE SOCKET WRENCHES SET



- Material: High performance alloy steel
- Finish: Chrome-plated matt finished
- Hardness: 40-50 HRc
- Standards: ISO 1711, ISO 691, ISO 2236

Q	Icon	Q	Icon	Q	Icon	g
6x12	Icon	x	Icon	8, 10, 11, 13, 14, 17, 19, 22 mm	g	1.980
51-8-W	1	8				
6x6	Icon	x	Icon	8, 10, 11, 13, 14, 17, 19, 22 mm	g	1.980
52-8-W	1	8				

TUBULAR SOLID WRENCHES

DOUBLE HEAD SOCKET WRENCHES

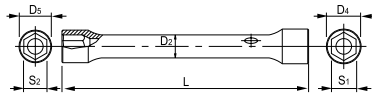

- Material: High performance alloy steel, CrV
- Finish: Chrome-plated matt finished
- From 16 onwards, with hole to locate the stud
- Hardness: 42-48 HRc
- Standards: UNE 16586

IRIMO	Box	S1x S2 mm	D4 mm	D5 mm	D2 mm	L mm	g
055011	10	6x7	10	11	7	103	31
055031	10	8x9	12.5	13.5	9	108	53
055051	10	10x11	15	16	11	120	78
055071	10	12x13	17	19	13	138	127
055091	10	14x15	20	21	14	143	152
055121	10	16x17	22	24	16	153	185
055141	10	18x19	25	26	18	163	235
055171	10	20x22	28	30	20	173	312
055181	5	21x23	29	31	21	183	359
055201	5	24x26	33	35	24	193	438
055211	5	24x27	33	37	24	193	466
055221	5	25x28	34	37	25	203	535
055241	5	27x29	37	39	27	208	592
055251	5	30x32	40	43	30	208	737

BAR HANDLE FOR SOCKET WRENCH

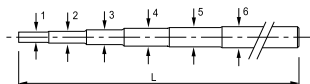

DOUBLE HEAD SOCKET WRENCHES SET



- Material: High performance alloy steel, CrV
- Finish: Chrome-plated matt finished
- From 16 onwards, with hole to locate the stud
- Hardness: 42-48 HRc
- Standards: UNE 16586

IRIMO	Box	Case	Wrench	g
056231	1	8	6-7, 8-9, 10-11, 12-13, 14-15, 16-17, 18-19, 20-22 mm	1.150
056271	1	12	6-7, 8-9, 10-11, 12-13, 14-15, 16-17, 18-19, 20-22, 21-23, 24-26, 25-28, 30-32 mm	3.200

- Material: High performance alloy steel, CrV
- Hardness: 42-48 HRc
- Standards: DIN 900

IRIMO	Box	1	2	3	4	5	6	L mm	g	
055301	1	3.1	4.3	5.3	5.8	8	-	6x7 ▲ 14x15	175	54
055311	1	6.8	7.8	9.8	11.8	12.8	14	16x17 ▲ 30x32	270	251



SLOGGING RING, OPEN END

RING END SLOGGING WRENCHES

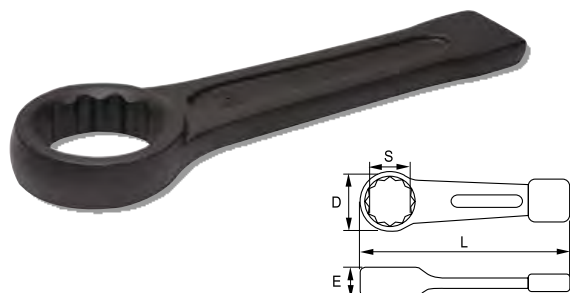

- Material: High performance alloy steel
- Hardness: 24-46 mm - 34-40 HRc and 50-100 mm - 30-36 HRc
- Standards: DIN 7444

Part No.	QTY	S mm	D mm	E mm	L mm	Weight (g)
30-24-2	1	24	43	15	165	235
30-27-2	1	27	46	16	180	290
30-30-2	1	30	53	18	195	435
30-32-2	1	32	53	18	195	415
30-34-2	1	34	59	18	205	510
30-36-2	1	36	59	18	205	510
30-38-2	1	38	59	18	205	510
30-41-2	1	41	65	20	230	710
30-46-2	1	46	74	22.5	240	980
30-50-2	1	50	79	24	255	1.050
30-55-2	1	55	86	25	270	1.410
30-60-2	1	60	93	26	280	1.640
30-65-2	1	65	103	29	300	2.180
30-70-2	1	70	109	33	315	2.400
30-75-2	1	75	114	34	330	2.775
30-80-2	1	80	125	36	348	3.150
30-85-2	1	85	129	37	360	4.860
30-90-2	1	90	148	40	379	5.680
30-95-2	1	95	151	41	395	6.500
30-100-2	1	100	154	45	405	7.830

OPEN END SLOGGING WRENCHES

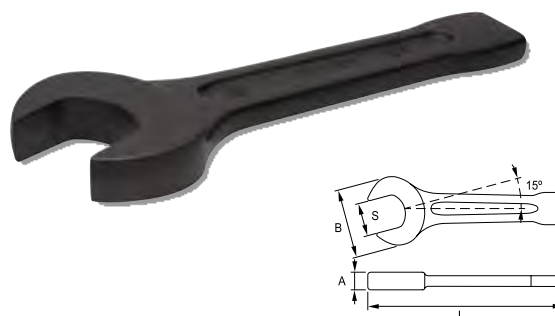

- Material: High performance alloy steel
- Hardness: 30-46 mm - 34-40 HRc and 50-85 mm - 30-36 HRc
- Standards: DIN 133

Part No.	QTY	S mm	A mm	B mm	L mm	Weight (g)
31-30-2	1	30	17	65	190	550
31-32-2	1	32	17	67	195	560
31-36-2	1	36	18	77	210	845
31-41-2	1	41	19	88	230	1.040
31-46-2	1	46	20	96	250	1.375
31-50-2	1	50	21	106	275	1.670
31-55-2	1	55	24	116	305	2.175
31-60-2	1	60	24	125	315	2.455
31-65-2	1	65	28	136	345	3.550
31-70-2	1	70	30	148	370	4.075
31-75-2	1	75	30	158	385	5.170
31-80-2	1	80	33	170	400	5.785
31-85-2	1	85	33	174	410	6.870

HOOK WRENCHES

HOOK WRENCH

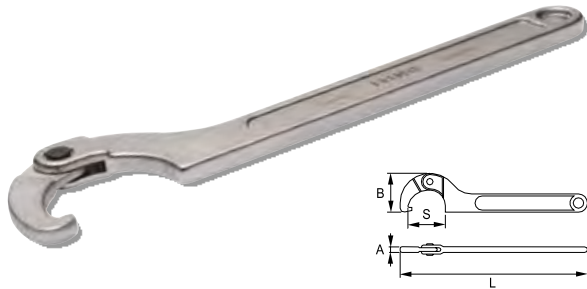

- Material: High performance alloy steel
- Finish: Chrome-plated matt finished
- Hardness: 40 HRC
- Standards: DIN 137-B

Code	Box	S mm	A mm	B mm	L mm	g
29-3550-2	1	35-50	6	38	202	186
29-5080-2	1	50-80	8	55	280	382
29-80120-2	1	80-120	9	75	345	642

HOOK WRENCH WITH INTERCHANGEABLE PIN

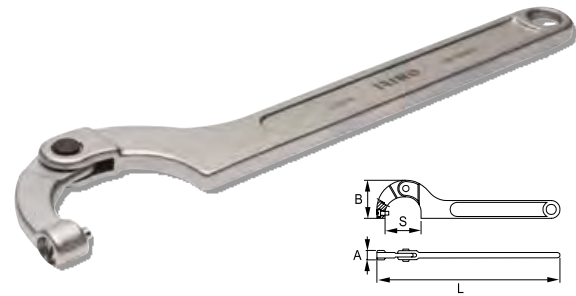

- Material: High performance alloy steel
- Finish: Chrome-plated matt finished
- Hardness: 40 HRC
- Standards: DIN 137-B

Code	Box	S mm	A mm	B mm	L mm	g
29P-3550-2	1	35-50	11	38	202	186
29P-5080-2	1	50-80	14	55	280	382
29P-80120-2	1	80-120	18	75	345	642

SPARE PART - INTERCHANGEABLE PIN



- Material: High performance alloy steel

Code	Box	Code	D mm	g
29P-3550-A	1	29P-3550-2	4	5
29P-5080-A	1	29P-5080-2	5	9
29P-80120-A	1	29P-80120-2	6	19

MULTIFITTING KEY

7 IN 1 UNIVERSAL KEY



- Universal key for all common locks
- 1 wrench for 7 different applications
- With radiator aerating key in the central hub
- For electricity, heating, ventilation and air-conditioning systems as well as building construction applications
- Made from zinc die casting, with chain, adaptor and bit (1.2x7 mm & PH2)
- Plastic blister retail packaging

Code	Box	Bit	Adaptor	Hub	Chain	Bit	Chain	g
71-UN7-1	1	1.2	PH-2	3-5	9	3-5	72x72	89

9 IN 1 UNIVERSAL KEY



- Universal key for all common locks
- 1 wrench for 9 different applications
- For electricity, heating, ventilation and air-conditioning systems as well as building construction applications
- Made from zinc die casting, with chain, adaptor and bit (1.2x7 mm & PH2)
- Plastic blister retail packaging

Code	Box	Bit	Adaptor	Hub	Chain	Bit	Chain	g
71-UN9-1	1	1.2	PH-2	5-7-8	9-10	9-10	90x62	87





03.

TORQUE TOOLS



TORQUE WRENCHES

ADJUSTABLE CLICK WRENCH WITH FIXED RATCHET HEADS

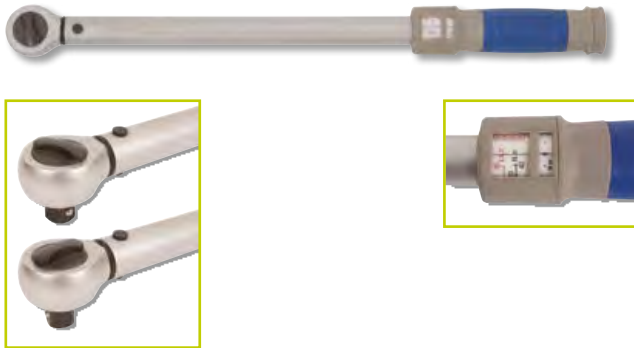

ADJUSTABLE CLICK WRENCH WITH INTERCHANGEABLE HEADS

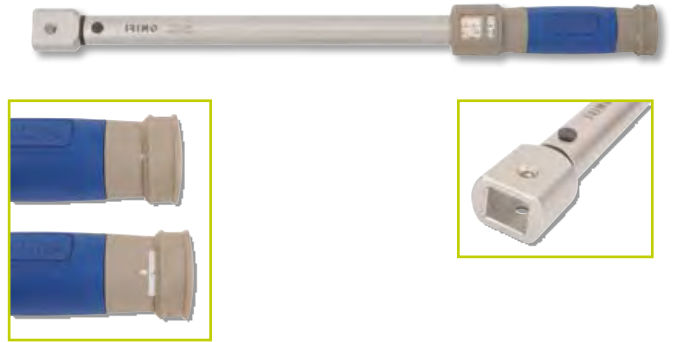

- Adjustable mechanical click torque wrench
- Precision: $\pm 4\%$ clockwise
- Fixed ratchet head
- Reversible ratchet with 45 teeth / 8° angle action
- Plastic handle for higher comfort
- Standard: ISO 6789

R	Icon	Size	N·m	Δ N·m	L mm	kg
070411	1	1/4"	4-20	0.050	275	0.5
070421	1	3/8"	10-60	0.125	360	0.8
070431	1	1/2"	25-125	0.25	420	0.9
070441	1	1/2"	40-200	0.5	460	1.0
070451	1	1/2"	65-335	0.5	520	1.2
070461	1	3/4"	65-335	0.5	520	1.2
070471	1	3/4"	150-800	2	1.040	4.9
070481	1	1"	300-1500	3	1.250	8.2

- Adjustable mechanical click torque wrenches
- Precision: $\pm 4\%$
- 9x12 and 14x18 interchangeable heads
- Plastic handle for higher comfort
- Standard: ISO 6789

R	Icon	Head Size	N·m	Δ N·m	L mm	kg
7309-30	1	9x12	6-30	0.050	298	0.6
7309-60	1	9x12	10-60	0.125	367	0.7
7309-125	1	9x12	25-125	0.25	422	0.8
7314-200	1	14x18	40-200	0.5	455	0.9
7314-335	1	14x18	65-335	0.5	515	1.1

9x12 MM OPEN END INSERTS

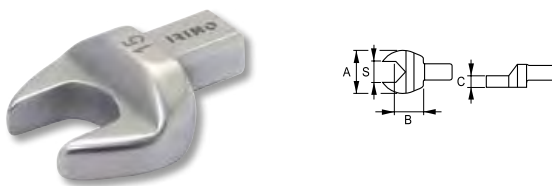

- Open-end insert heads, 9x12 mm
- High performance alloy steel
- Forged chrome-plated

R	Icon	S mm	A mm	B mm	C mm	g
7309-1-10	1	10	25	17.5	5.7	40
7309-1-11	1	11	26	17.5	5.7	40
7309-1-12	1	12	28	17.5	5.7	45
7309-1-13	1	13	29	17.5	5.7	45
7309-1-14	1	14	32	20.0	7.7	50
7309-1-17	1	17	38	20.0	7.7	60
7309-1-19	1	19	42	20.0	7.7	70

9x12 MM RING END INSERTS

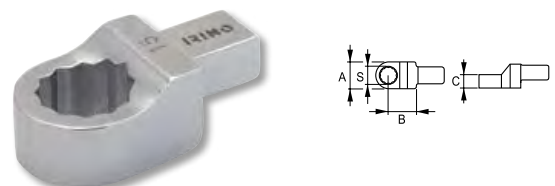

- Ring-end insert head, 9x12 mm
- High performance alloy steel
- Forged chrome-plated

R	Icon	S mm	A mm	B mm	C mm	g
7309-2-10	1	10	18	17.5	8	40
7309-2-11	1	11	19	17.5	8	40
7309-2-12	1	12	20	17.5	12	50
7309-2-13	1	13	21	17.5	12	50
7309-2-14	1	14	23	17.5	12	50
7309-2-17	1	17	27	17.5	13	50
7309-2-19	1	19	31	17.5	13	60

9x12 & 14x18 MM RATCHET HEAD INSERTS

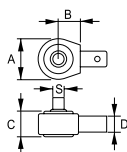

- 1/4", 3/8" & 1/2" square drive ratchet inserts in 9x12 mm
- 1/2" Square drive ratchet inserts in 14x18 mm
- Teeth number: 45
- Angle action: 8°
- High performance alloy steel
- Forged chrome-plated

R	Icon	S mm	A mm	B mm	C mm	D mm	Max N·m	g
7309-1/4	1	1/4"	37	18	20	9x12	25	135
7309-3/8	1	3/8"	38	18	20	9x12	160	160
7309-1/2	1	1/2"	38	18	20	9x12	160	160
7314-1/2	1	1/2"	40	25	20	14x18	420	265

14x18 MM OPEN END INSERTS

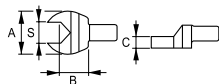

- Open-end insert head, 14x18 mm
- High performance alloy steel
- Forged chrome-plated

R	Icon	S mm	A mm	B mm	C mm	g
7314-1-13	1	13	30	25.0	7	130
7314-1-14	1	14	31	25.0	7	130
7314-1-17	1	17	37	25.0	9	135
7314-1-19	1	19	41	25.0	9	140
7314-1-22	1	22	47	25.0	11	170
7314-1-24	1	24	51	25.0	11	180
7314-1-27	1	27	59	32.5	14	220
7314-1-30	1	30	63	32.5	14	240
7314-1-32	1	32	65	32.5	14	240

14x18 MM RING END INSERTS

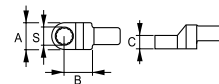





- Ring-end insert head, 14x18 mm
- High performance alloy steel
- Forged chrome-plated

R	Icon	S mm	A mm	B mm	C mm	g
7314-2-13	1	13	21	25	12	120
7314-2-14	1	14	23	25	12	120
7314-2-17	1	17	28	25	13	130
7314-2-19	1	19	30	25	13	140
7314-2-22	1	22	35	25	15	145
7314-2-24	1	24	38	25	15	145
7314-2-27	1	27	42	31	18	170
7314-2-30	1	30	45	31	18	180
7314-2-32	1	32	48	31	18	180
7314-2-36	1	36	53	31	19	205
7314-2-41	1	41	59	31	19	235

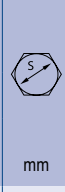
03 TORQUE TOOLS

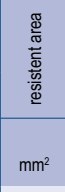
BOLTS AND NUTS. PRE-LOAD AND TORQUE DATA

 coarse pitch mm	 mm	 mm	 resistant area mm ²	 friction coefficient mm	PROPERTY CLASS. COARSE PITCH												
					4.8		5.8		6.8		8.8		10.9		12.9		
					Pre-load N	Torque N·m	Pre-load N	Torque N·m	Pre-load N	Torque N·m	Pre-load N	Torque N·m	Pre-load N	Torque N·m	Pre-load N	Torque N·m	
M2	040	40	15	207	010 014	4480 4495	0.15 0.19	610.6 561.9	0.19 0.23	732.7 674.3	0.23 0.28	976.9 899.0	0.31 0.37	1373.8 1264.3	0.43 0.52	1648.6 1517.1	0.52 0.63
M2.5	045	50	20	3.39	0.10 0.14	813.5 749.9	0.31 0.38	1016.9 937.4	0.39 0.48	1220.2 1124.9	0.47 0.58	1627.0 1499.8	0.63 0.77	2288.0 2109.1	0.88 1.08	2745.6 2531.0	1.06 1.30
M3	050	55	25	5.03	0.10 0.14	1219.9 1125.9	0.54 0.60	1524.9 1407.4	0.68 0.83	1829.9 1688.9	0.82 1.00	2439.9 2251.9	1.09 1.34	3431.0 3166.7	1.53 1.88	4117.2 3800.0	1.84 2.26
M3.5	060	60	-	6.78	0.10 0.14	1638.2 1511.3	0.84 1.03	2047.8 1889.2	1.05 1.28	2457.3 2267.0	1.26 1.54	3276.4 3022.6	1.68 2.05	4607.5 4250.6	2.36 2.89	5528.9 5100.7	2.84 3.47
M4	070	70	30	8.78	0.10 0.14	21154 19509	1.25 1.53	2644.3 2438.7	1.56 1.91	3173.1 2926.4	1.88 2.29	4230.8 3901.9	2.50 3.06	5949.6 5487.0	3.52 4.30	7139.5 6584.4	4.22 5.16
M5	080	80	40	14.20	0.10 0.14	34616 31968	2.46 3.02	4327.0 3996.0	3.08 3.78	5192.3 4795.2	3.70 4.53	6923.1 6393.7	4.93 6.04	9735.7 8991.1	6.93 8.50	11682.8 10789.3	8.32 10.20
M6	100	100	50	20.10	0.10 0.14	48747 44991	4.24 5.19	6093.4 5623.9	5.30 6.48	7312.1 6748.6	6.35 7.78	9749.4 8998.2	8.47 10.37	13710.1 12653.7	11.92 14.59	16452.2 15184.4	14.30 17.51
M7	100	110	-	28.90	0.10 0.14	71345 65996	6.97 8.60	8918.2 8249.5	8.71 10.76	10701.8 9899.4	10.45 12.90	14269.1 13199.2	13.94 17.21	20065.9 18561.4	19.60 24.20	24079.1 22273.6	23.52 29.04
M8	125	130	60	36.60	0.10 0.14	89471 82656	10.20 12.54	11183.9 10332.0	12.75 15.67	13420.7 12398.4	15.30 18.80	17894.2 16531.2	20.41 25.07	25163.7 23247.0	28.70 35.26	30196.5 27896.5	34.44 42.31
M10	150	160	80	58.00	0.10 0.14	142445 131674	20.11 24.76	17805.6 16459.2	25.14 30.95	21366.8 19751.1	30.16 37.14	28489.0 26334.8	40.22 49.52	40062.7 37033.3	56.56 69.64	48075.3 44439.9	67.87 83.56
M12	175	180	100	84.30	0.10 0.14	207666 192040	34.43 42.42	25958.3 24005.0	43.03 53.03	31149.9 28806.0	51.64 63.63	41533.2 38408.0	68.86 84.84	58406.1 54011.2	96.83 119.31	70087.3 64813.5	116.20 143.17
M14	200	210	120	115.00	0.10 0.14	283899 262612	54.77 67.56	35487.4 32826.5	68.46 84.45	42584.9 39391.8	82.15 101.34	56779.8 52522.4	109.53 135.13	79846.6 73859.6	154.03 190.02	95816.0 88631.5	184.84 228.03
M16	200	240	140	157.00	0.10 0.14	392421 363642	85.14 105.80	49052.7 45455.3	106.43 132.26	58863.2 54546.3	127.72 158.71	78484.3 72728.5	170.29 211.61	110368.5 102274.4	239.47 297.58	132442.2 122729.3	287.36 357.09
M18	250	270	140	192.00	0.10 0.14	47533.0 43986.1	117.48 145.16	59416.3 54982.7	146.85 181.45	71299.6 65979.2	176.22 217.74	95066.1 87972.3	234.96 290.32	133686.7 123711.0	330.41 402.26	160424.1 148453.2	396.49 489.92
M20	250	300	170	245.00	0.10 0.14	61238.0 56747.1	166.08 206.39	76547.5 70933.9	207.61 257.98	91857.0 85120.6	249.13 309.58	122476.0 113494.2	332.17 412.78	172231.9 159601.2	467.11 580.47	206678.2 191521.5	560.54 696.56
M22	250	340	170	303.00	0.10 0.14	76305.2 70791.9	227.22 283.79	95381.5 88489.8	284.02 354.74	114457.8 106187.8	340.82 425.69	152610.4 141583.7	454.43 567.58	214608.3 199102.1	639.05 798.16	257530.0 238922.5	766.85 957.80
M24	300	360	190	353.00	0.10 0.14	88232.4 81761.8	287.16 356.84	110290.5 102202.2	358.94 446.05	132348.6 122642.7	430.73 535.26	176646.9 163523.6	574.31 713.68	248153.7 229955.1	807.63 1003.61	297784.4 275944.1	969.15 1204.33
M27	300	410	190	459.00	0.10 0.14	115778.8 107441.5	420.04 525.08	144723.5 134301.9	525.05 656.35	173668.2 161162.2	630.06 787.62	231557.6 214883.0	840.08 1050.16	325627.9 302179.2	1181.36 1476.79	390753.4 362615.0	1417.63 1772.15
M30	350	460	220	561.00	0.10 0.14	140999.5 130770.6	572.83 714.49	176249.4 163463.3	716.03 893.11	211499.3 196155.9	859.24 1071.73	281999.0 261541.2	1145.65 1428.97	396561.1 367792.3	1611.08 2009.49	475873.4 441350.8	1933.29 2411.39
M33	350	500	220	694.00	0.10 0.14	175618.1 163058.0	774.65 970.43	219522.6 203822.5	968.32 1213.03	263427.1 244587.0	1161.98 1455.64	351236.2 326115.9	1549.31 1940.86	493925.8 458600.5	2178.72 2729.33	592711.0 550320.6	2614.46 3275.19
M36	400	550	240	817.00	0.10 0.14	206081.7 191241.8	998.60 1248.41	257602.2 239052.3	1248.25 1560.51	309122.6 286862.7	1497.89 1872.61	412163.5 382483.6	1997.19 2496.81	579604.8 537867.6	2808.55 3511.14	695525.8 645441.1	3370.26 4213.37
M39	400	600	270	976.00	0.10 0.14	247520.0 229902.6	1291.81 1620.96	309400.0 287378.3	1614.77 2026.20	371279.9 344853.9	1937.72 2431.44	495039.9 459805.2	2583.63 3241.92	696149.8 646601.0	3633.23 4558.96	835379.8 775921.3	4359.88 5470.75
M42	450	650	-	1120.00	0.10 0.14	283225.0 262939.0	1601.25 2005.46	354031.2 328673.8	2001.57 2506.83	424837.4 394408.5	2401.88 3008.20	566449.9 525878.0	3202.51 4010.93	796570.1 739516.0	4503.53 5640.37	955884.2 887419.2	5404.23 6768.44
M45	450	700	320	1310.00	0.10 0.14	332751.5 309151.8	2005.51 2519.55	415939.4 386439.7	2506.89 3149.43	499127.3 463727.7	3008.26 3779.32	665503.0 618303.6	4011.02 5039.09	935863.6 869489.3	5640.50 7086.23	1123036.0 1043387.0	6768.60 8503.47
M48	500	750	-	1470.00	0.10 0.14	372429.3 345862.9	2406.51 3018.11	465536.6 432328.7	3008.14 3772.64	558644.0 518794.4	3609.77 4527.17	744858.6 691725.8	4813.03 6036.23	1047457.0 973739.4	6768.32 8488.45	1256949.0 1167287.0	8121.98 10186.14
M52	500	800	360	1760.00	0.10 0.14	448108.9 416499.0	3099.96 3900.52	560136.1 520623.8	3874.95 4875.65	672163.4 624748.5	4649.93 5850.78	896217.8 832998.0	6199.91 7801.04	1260306.0 1171404.0	8718.63 10970.21	1512368.0 1405684.0	10462.36 13164.25
M56	550	850	410	2030.00	0.10 0.14	516202.9 479683.4	3838.14 4824.40	645253.6 599604.2	4797.68 6030.50	774304.4 719525.1	5757.21 7236.60	1032406.0 959366.8	7676.29 9648.80	1451821.0 1349110.0	10794.78 13568.63	1742185.0 1618931.0	12953.73 16282.36
M60	550	900	-	2360.00	0.10 0.14	602498.5 560267.5	4754.64 5992.71	753123.1 700334.4	5943.30 7490.88	903747.8 840401.2	7131.96 8989.06	1204997.0 1120535.0	9509.28 11985.42	1694527.0 1575752.0	13372.43 16854.49	2033432.0 1890903.0	16046.91 20225.39
M64	600	950	460	2680.00	0.10 0.14	683339.5 635299.9	5746.17 7235.13	854174.4 794124.9	7182.71 9043.92	1025009.0 952949.8	8619.25 10852.70	1366679.0 1270600.0	11492.34 14470.27	1921892.0 1786781.0	16161.10 20348.82	2306271.0 2144137.0	19393.32 24418.58
M68	600	1000	-	3060.00	0.10 0.14	782799.9 728201.8	6939.64 8758.24	978499.8 910252.2	8674.55 10947.80	1174200.0 1092303.0	10409.46 13137.36	1565600.0 1456404.0	13879.28 17516.48	2201625.0 2048068.0	19517.74 24632.55	2641950.0 2457681.0	23421.29 29559.06



04.

SOCKETRY

1/4" SOCKETS

1/4" HEXAGONAL SOCKETS

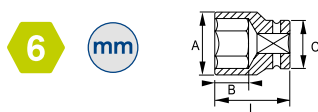

- Chrome vanadium alloy steel
- Chrome-plated bright finish
- Wave shape profile NPP
- Standards: DIN 3120, DIN 3124

R	Box	Hex	A mm	B mm	C mm	L mm	g
101-04-1	5	4	6.9	9.0	12.0	25.0	11
101-045-1	5	4.5	7.5	9.0	12.0	25.0	11
101-05-1	5	5	8.2	9.0	12.0	25.0	11
101-055-1	5	5.5	8.8	9.0	12.0	25.0	12
101-06-1	5	6	9.4	9.0	12.0	25.0	11
101-07-1	5	7	11.0	9.0	12.0	25.0	13
101-08-1	5	8	12.0	12.0	12.0	25.0	13
101-09-1	5	9	13.0	12.0	13.0	25.0	15
101-10-1	5	10	14.0	12.0	12.6	25.0	21
101-11-1	5	11	16.0	12.0	14.0	25.0	24
101-12-1	5	12	17.0	12.0	14.8	25.0	26
101-13-1	5	13	18.0	12.0	15.8	25.0	28
101-14-1	5	14	20.0	12.0	17.4	25.0	39



R	Box	Hex	A mm	B mm	C mm	L mm	g
101A-05-1	5	5/32"	6.9	8.5	12.0	25.0	10
101A-06-1	5	3/16"	7.5	8.5	12.0	25.0	10
101A-07-1	5	7/32"	8.8	9.5	12.0	25.0	11
101A-08-1	5	1/4"	9.4	9.5	12.0	25.0	11
101A-09-1	5	9/32"	11.0	10.5	12.0	25.0	13
101A-10-1	5	5/16"	12.0	10.5	12.0	25.0	12
101A-11-1	5	11/32"	13.0	10.5	12.0	25.0	14
101A-12-1	5	3/8"	14.0	10.5	12.6	25.0	18
101A-14-1	5	7/16"	16.0	11.5	14.0	25.0	23
101A-16-1	5	1/2"	18.0	11.5	15.8	25.0	29
101A-18-1	5	9/16"	20.0	11.5	17.4	25.0	37

1/4" DEEP HEXAGONAL SOCKETS

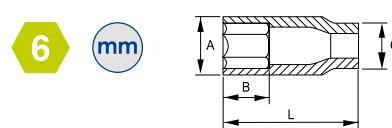

- Chrome vanadium alloy steel
- Chrome-plated bright finish
- Wave shape profile NPP
- Standards: DIN 3120, DIN 3124

R	Box	Hex	A mm	B mm	C mm	L mm	g
103-04-1	5	4	6.9	12.0	12.0	50.0	21
103-045-1	5	4.5	7.5	12.0	12.0	50.0	20
103-05-1	5	5	8.2	12.0	12.0	50.0	21
103-055-1	5	5.5	8.8	12.0	12.0	50.0	22
103-06-1	5	6	9.4	12.0	12.0	50.0	22
103-07-1	5	7	11.0	24.0	12.0	50.0	26
103-08-1	5	8	12.0	24.0	10.9	50.0	29
103-09-1	5	9	13.0	24.0	11.6	50.0	30
103-10-1	5	10	14.0	24.0	13.0	50.0	39
103-11-1	5	11	16.0	24.0	14.2	50.0	44
103-12-1	5	12	17.0	24.0	15.0	50.0	49
103-13-1	5	13	18.0	24.0	16.0	50.0	55
103-14-1	5	14	20.0	24.0	17.0	50.0	65



R	Box	Hex	A mm	B mm	C mm	L mm	g
103A-06-1	5	3/16"	8.2	12.0	12.0	50.0	21
103A-08-1	5	1/4"	9.7	12.0	12.0	50.0	22
103A-09-1	5	9/32"	11.2	24.0	12.0	50.0	26
103A-10-1	5	5/16"	12.0	24.0	12.0	50.0	29
103A-11-1	5	11/32"	13.0	24.0	12.0	50.0	30
103A-12-1	5	3/8"	13.7	24.0	12.0	50.0	39
103A-14-1	5	7/16"	16.1	24.0	14.2	50.0	44
103A-16-1	5	1/2"	18.0	24.0	16.0	50.0	55

1/4" SOCKETS, TORX®

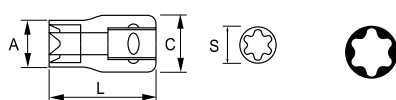

- Chrome vanadium alloy steel
- Chrome-plated bright finish
- Standard: DIN 3120

R	Box	Torx	S mm	A mm	B mm	L mm	g
106-04-1	5	E-4	3.8	6.0	12.0	25.0	10
106-05-1	5	E-5	4.7	7.0	12.0	25.0	11
106-06-1	5	E-6	5.7	8.0	12.0	25.0	11
106-07-1	5	E-7	6.2	8.6	12.0	25.0	11
106-08-1	5	E-8	7.5	10.3	12.0	25.0	12
106-10-1	5	E-10	9.4	12.3	13.0	25.0	21

1/4" BIT DRIVERS

1/4" BIT DRIVER, SLOTTED



- Bit made with S2 special steel
- Slotted
- Standard: DIN 3120

Part No.	Box Qty	Size	A mm	B mm	L mm	g
107-0840-1	5	0.8 x 4	11.8	20.0	37.5	15
107-1055-1	5	1 x 5.5	11.8	20.0	37.5	15
107-1280-1	5	1.2 x 8	11.8	20.0	37.5	16

1/4" BIT DRIVER, PHILLIPS



- Bit made with S2 special steel
- Phillips bit driver
- Standard: DIN 3120

Part No.	Box Qty	Size	A mm	B mm	L mm	g
107-PH1-1	5	PH-1	11.8	20.0	37.5	15
107-PH2-1	5	PH-2	11.8	20.0	37.5	15
107-PH3-1	5	PH-3	11.8	20.0	37.5	16

1/4" BIT DRIVER, POZIDRIV



- Bit made with S2 special steel
- Pozidriv bit driver
- Standard: DIN 3120

Part No.	Box Qty	Size	A mm	B mm	L mm	g
107-PZ1-1	5	PZ-1	11.8	20.0	37.5	15
107-PZ2-1	5	PZ-2	11.8	20.0	37.5	15
107-PZ3-1	5	PZ-3	11.8	20.0	37.5	16

1/4" BIT DRIVER, HEXAGONAL



- Bit made with S2 special steel
- Hexagonal bit driver
- Standard: DIN 3120

Part No.	Box Qty	Size	A mm	B mm	L mm	g
107-H3-1	5	3	11.8	20.0	37.5	15
107-H4-1	5	4	11.8	20.0	37.5	15
107-H5-1	5	5	11.8	20.0	37.5	16
107-H6-1	5	6	11.8	20.0	37.5	17
107-H8-1	5	8	11.8	20.0	37.5	19

Part No.	Box Qty	Size	A mm	B mm	L mm	g
107A-4-1	5	1/8"	11.8	20.0	37.5	15
107A-5-1	5	5/32"	11.8	20.0	37.5	15
107A-6-1	5	3/16"	11.8	20.0	37.5	16
107A-7-1	5	7/32"	11.8	20.0	37.5	17

1/4" BIT DRIVER, TORX®



- Bit made with S2 special steel
- TORX® bit driver
- Standard: DIN 3120

Part No.	Box Qty	Size	S mm	A mm	C mm	L mm	g
107-T08-1	5	T8	2.3	11.8	20.0	37.5	15
107-T09-1	5	T9	2.5	11.8	20.0	37.5	15
107-T10-1	5	T10	2.7	11.8	20.0	37.5	15
107-T15-1	5	T15	3.3	11.8	20.0	37.5	15
107-T20-1	5	T20	3.8	11.8	20.0	37.5	15
107-T25-1	5	T25	4.4	11.8	20.0	37.5	15
107-T27-1	5	T27	5.0	11.8	20.0	37.5	16
107-T30-1	5	T30	5.5	11.8	20.0	37.5	16
107-T40-1	5	T40	6.6	11.8	20.0	37.5	16

1/4" ACCESSORIES

1/4" REVERSIBLE RATCHET

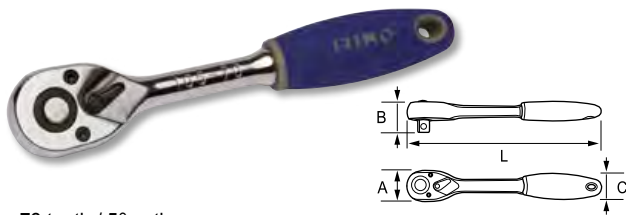

- 72 teeth / 5° action
- Chrome vanadium alloy steel
- Chrome-plated bright finish
- Quick release
- 2-component handle
- Cushion thermo rubber grip
- Standards: DIN 3120, DIN 3122

R	Icon	A mm	B mm	C mm	L mm	g
105-70-1	5	28	25	23	152	151

1/4" REVERSIBLE RATCHET

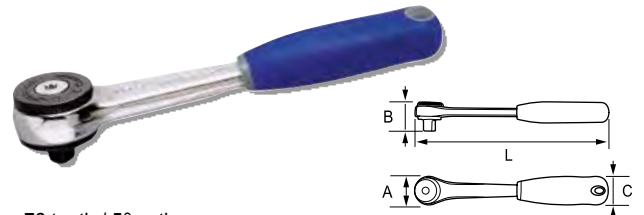

- 72 teeth / 5° action
- High performance alloy steel
- Chrome-plated high polished finish
- 2-component handle
- Cushion thermo rubber grip
- Standards: DIN 3122, DIN 3120, ISO 3315, UNE 16512
- * 105711 Repair Kit

R	Icon	A mm	B mm	C mm	L mm	g
105501	1	25	23	21	122	150

RATCHET EXHIBITOR WITH 12 1/4" RATCHETS



- Reversible ratchet
- 72 teeth / 5° action
- Chrome vanadium alloy steel
- Chrome-plated bright finish
- Quick release
- 2-component handle
- Cushion thermo rubber grip
- Standard: DIN 3122, DIN 3120
- Use part number 105-70-1 to order individual ratchets

R	Icon	Icon	Icon	g
105-70-12DISP	1	12	160x150x230	2.590

1/4" HEXAGONAL SOCKET SET IN RAIL, 11 pieces



- 1/4" Socket set in display
- 11 pcs socket set
- Hexagonal sockets, metric sizes
- Chrome plated bright finish
- Standard: DIN 3120, DIN 3124, DIN 3122
- Hang sell presentation

R	Icon	Icon	Icon	g
109-11-4	5	11	232x60x15	250

101-04-1, 101-05-1, 101-06-1, 101-07-1, 101-08-1, 101-09-1, 101-10-1, 101-11-1, 101-12-1, 101-13-1, 101-14-1

1/4" SOCKET SET, HEXAGONAL AND METRIC



- 13 pcs, 1/4" drive socket set
- Hexagonal sockets, metric sizes
- Chrome plated bright finish
- Standard: DIN 3120, DIN 3124, DIN 3122
- Hang sell presentation
- * Counter display when ordering 12 pieces

R	Icon	Icon	Icon	g
109-13-4	8	13	254x70x30	460

105-70-1 105-24-1

101-04-1, 101-05-1, 101-06-1, 101-07-1, 101-08-1, 101-09-1, 101-10-1, 101-11-1, 101-12-1, 101-13-1, 101-14-1

1/4" EXTENSIONS



- Standards: DIN 3120, DIN 3122

R	Icon	A mm	B mm	L mm	g	
105-22-1		5	8.1	12.2	50	20
105-24-1		5	8.1	12.2	100	38
105-26-1		5	8.1	12.2	150	65

1/4" SLIDING T-HANDLE

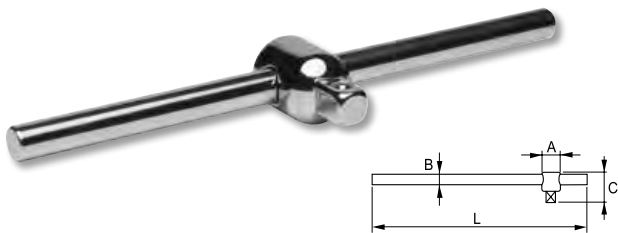

- Standards: DIN 3120, DIN 3122

R	Icon	A mm	B mm	C mm	L mm	g	
105-42-1		5	13.5	6.0	24	115	45

1/4" SPINNER HANDLE

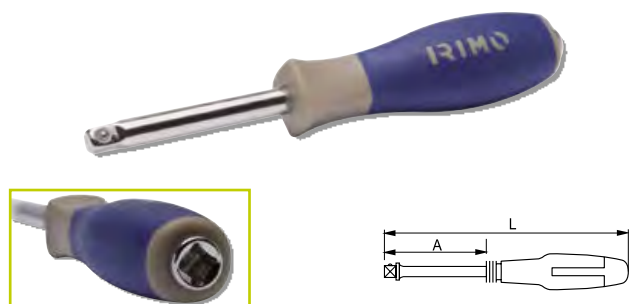

- Female 1/4" square in the head
- Standard: DIN 3120

R	Icon	A mm	L mm	Icon	Icon	g
105-50-1		5	61	1/4"	1/4"	88

1/4"-3/8" INCREASING ADAPTOR

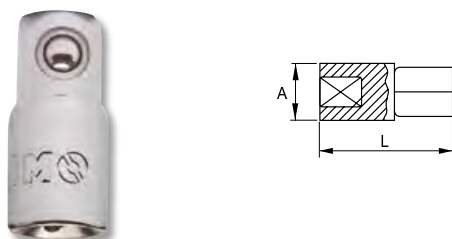

- Increasing adaptor 1/4" to 3/8"
- Standards: DIN 3120, DIN 3122

R	Icon	A mm	L mm	g	
105-46-1		5	12.0	26.0	31

1/4" FLEXIBLE EXTENSION

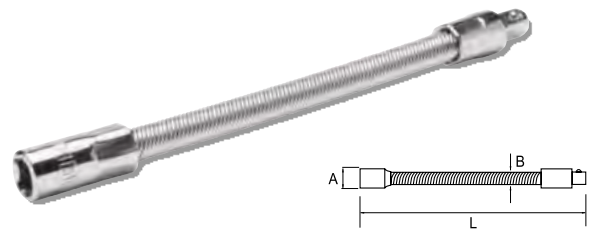

- Standard: DIN 3120

R	Icon	A mm	B mm	L mm	g	
105-28-1		5	12.5	8	148	57

1/4" UNIVERSAL JOINT

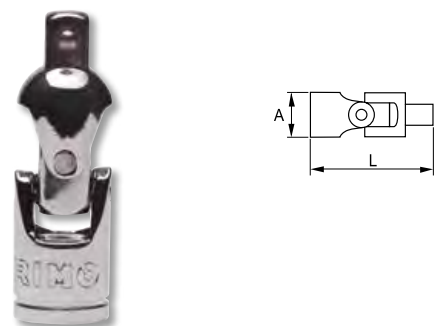

- Standards: DIN 3120, DIN 3122

R	Icon	A mm	L mm	g	
105-40-1		5	13.8	38.0	27

1/4" BIT HOLDER

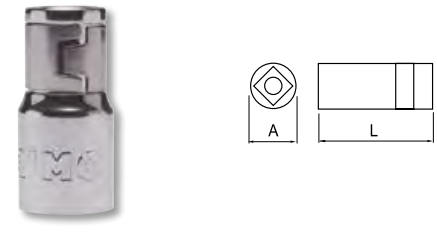

- 1/4" female square to 1/4" female hex
- Standard: DIN 3120

R	Icon	A mm	L mm	g	
105-48-1		5	11.9	25.0	12



1/4" SOCKET SETS

1/4" SOCKET AND BIT SET

1/4" mm



- 1/4" 23 pcs socket and bit set DIN 3120 and DIN 3124
- Ratchet torque according to DIN 3122
- Special bit ratchet hex 1/4" drive; Reversible; 60 teeth; L= 90 mm
- Bimaterial ratchet handle
- ABS plastic box
- Includes belt clip
- Ratchet is sold as a spare part: SP121

R	Box	Qty	Dimensions	Weight
109-23-4	1	23	110x75x45	340
101-06-1, 101-07-1, 101-08-1, 101-10-1, 101-11-1, 101-13-1				1/4"
475A-25-1				
475-PH1-1, 475-PH2-1				
475-PZ1-1, 475-PZ2-1				
475-4-1, 475-6.0-1				
475-H3-1, 475-H4-1, 475-H5-1, 475-H6-1				
475-T10-1, 475-T15-1, 475-T20-1, 475-T25-1, 475-T30-1				
SP121				

1/4" SOCKET SET, HEXAGONAL AND METRIC

1/4" mm



- Hex sockets, metric sizes
- Chrome vanadium alloy steel
- Chrome-plated bright finish
- Standards: DIN 3120, DIN 3124, DIN 3122
- Box in high density polyethylene

R	Box	Qty	Dimensions	Weight
109-19-4	10	19	260x185x55	1.100
105-40-1				
105-42-1				
105-22-1				
101-04-1, 101-045-1, 101-05-1, 101-055-1, 101-06-1, 101-07-1, 101-08-1, 101-09-1, 101-10-1, 101-11-1, 101-12-1, 101-13-1, 101-14-1				1/4"

1/4" SOCKET SET, HEXAGONAL AND METRIC

1/4" mm



- 35 pcs socket set
- Hex sockets, metric sizes
- Chrome vanadium alloy steel
- Chrome-plated bright finish
- Standards: DIN 3120, DIN 3124, DIN 3122
- Box in high density polyethylene

R	Box	Qty	Dimensions	Weight
109-35-4	1	35	250x170x60	1.200
105-48-1				
105-42-1				
105-22-1				
105-24-1				
101-04-1, 101-045-1, 101-05-1, 101-055-1, 101-06-1, 101-07-1, 101-08-1, 101-09-1, 101-10-1, 101-11-1, 101-12-1, 101-13-1				1/4"
040001, 040011, 040021				
475-PH1-1, 475-PH2-1, 475-PH3-1				
475-PZ1-1, 475-PZ2-1, 475-PZ3-1				
475-4-1, 475-6.0-1				
475-H3-1, 475-H4-1, 475-H5-1, 475-H6-1				

SUPER COMPACT

SMALL & HANDY.



1/4" mm



- 1/4" hexagonal socket and bit handy set, 37 pcs
- Bit holder with swiveling system for easy Access
- Handy reversible ratchet of 72 teeth. Length 105 mm
- Bimaterial handles
- Bright chrome plated finish
- DIN 3120 and DIN 3124

Part No.	Qty	Dimensions	Weight (g)	
109-37-4	1	37	45x100x150	780
x10	1/4"	5.5-6-7-8-9-10-11-12-13-14 mm		
x1	72	1/4"	x2 1/4" 50-100 mm	
x1	1/4"		x1 1/4"	
x22	1/4"			
(3x)	⓪	SL4-5-6	(3x) ⓧ PZ1-2-3	
(5x)	⓪	H3-4-5-6-7	(3x) ⓧ PH1-2-3	
(7x)	⓪	T10-15-20-25-27-30-40	(1x) ⓧ 1/4"	

3/8" SOCKETS

3/8" HEXAGONAL SOCKETS

6 mm

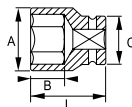

- Chrome vanadium alloy steel
- Chrome-plated bright finish
- Wave shape profile NPP
- Standards: DIN 3120, DIN 3124

Part No.	Qty	Hex Size	A mm	B mm	C mm	L mm	Weight (g)
112-06-1	5	6	10.5	9.0	17.0	28.0	21
112-07-1	5	7	11.0	9.0	17.0	28.0	24
112-08-1	5	8	12.2	9.0	17.0	28.0	27
112-09-1	5	9	13.5	9.0	17.0	28.0	26
112-10-1	5	10	14.7	9.0	17.0	28.0	24
112-11-1	5	11	16.0	9.0	17.0	28.0	26
112-12-1	5	12	18.0	15.0	17.0	28.0	24
112-13-1	5	13	19.0	15.0	17.0	28.0	29
112-14-1	5	14	20.0	15.0	17.7	28.0	38
112-15-1	5	15	22.0	15.0	17.9	28.0	40
112-16-1	5	16	22.0	15.0	17.9	28.0	46
112-17-1	5	17	24.0	15.0	18.8	30.0	56
112-18-1	5	18	26.0	15.0	19.8	30.0	75
112-19-1	5	19	26.0	15.0	20.7	30.0	66
112-20-1	5	20	28.0	15.0	21.8	30.0	88
112-21-1	5	21	28.0	15.0	21.8	30.0	84
112-22-1	5	22	30.0	15.0	22.8	32.0	104

3/8" HEXAGONAL DEEP SOCKETS

6 mm

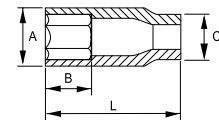

- Deep sockets
- Chrome vanadium alloy steel
- Chrome-plated bright finish
- Wave shape profile NPP
- Standard: DIN 3120

Part No.	Qty	Hex Size	A mm	B mm	C mm	L mm	Weight (g)
113-07-1	5	7	11.0	16.0	17.0	64.0	45
113-08-1	5	8	12.2	16.0	17.0	64.0	49
113-09-1	5	9	13.5	16.0	17.0	64.0	53
113-10-1	5	10	14.7	16.0	17.0	64.0	60
113-11-1	5	11	17.0	29.0	16.0	64.0	61
113-12-1	5	12	18.0	29.0	17.2	64.0	63
113-13-1	5	13	19.0	29.0	16.8	64.0	75
113-14-1	5	14	20.0	29.0	17.8	64.0	81
113-16-1	5	16	22.0	29.0	18.0	64.0	98
113-17-1	5	17	24.0	29.0	18.9	64.0	123
113-19-1	5	19	26.0	29.0	20.8	64.0	145

3/8" ACCESSORIES

3/8" REVERSIBLE RATCHET

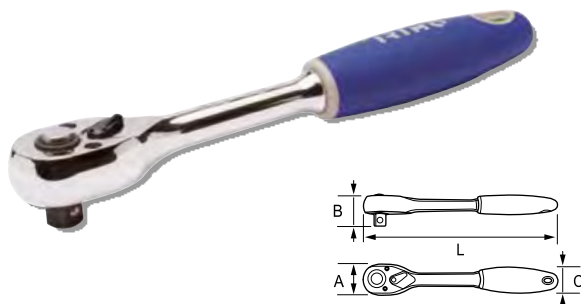

- 72 teeth / 5° action
- Chrome vanadium alloy steel
- Chrome-plated bright finish
- Quick release
- 2-component handle
- Cushion thermo rubber grip
- Standards: DIN 3120, DIN 3122

Part No.	Box	A mm	B mm	C mm	L mm	g
115-70-1	5	33	33	32	202	341

3/8" REVERSIBLE RATCHET

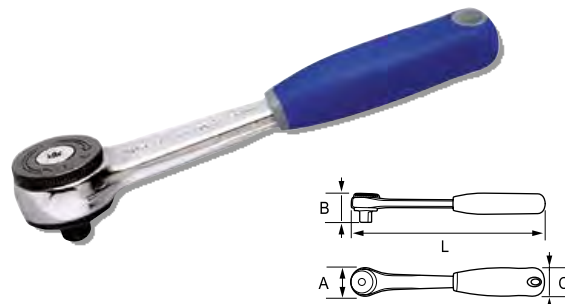

- 72 teeth / 5° action
- High performance alloy steel
- Chrome-plated high polished finish
- 2-component handle
- Cushion thermo rubber grip
- Standards: DIN 3122, DIN 3120, ISO 3315, UNE 16512
- * 115701 Repair Kit

Part No.	Box	A mm	B mm	C mm	L mm	g
115501	1	29	30	24	197	230

3/8" EXTENSIONS



- Standards: DIN 3120, DIN 3122

Part No.	Box	A mm	B mm	L mm	g
115-20-1	5	17.0	12.1	75	125
115-22-1	5	17.0	12.1	150	138
115-24-1	5	17.0	12.1	250	232

3/8" SLIDING T-HANDLE

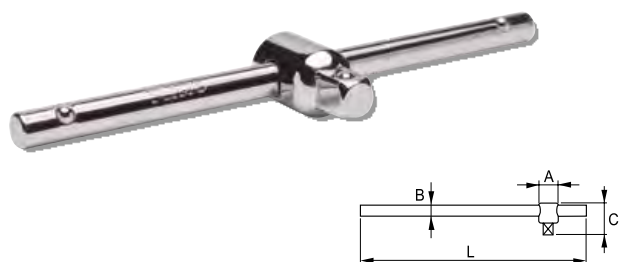

- Standards: DIN 3120, DIN 3122

Part No.	Box	A mm	B mm	C mm	L mm	g
115-42-1	5	17.5	8.5	35	152	114

3/8" T-HANDLE HEAD

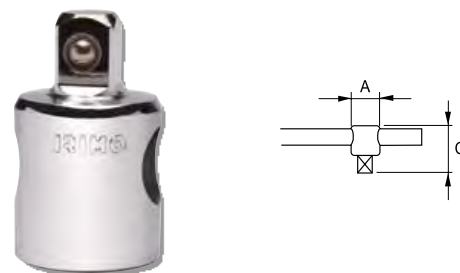

- Sliding T handle head
- Standard: DIN 3120

Part No.	Box	A mm	C mm	g
115-43-1	5	24.0	40.5	30

3/8" UNIVERSAL JOINT



- Standards: DIN 3120, DIN 3122

Part No.	QTY	A mm	L mm	Weight (g)
115-40-1	5	17.8	59.0	61

3/8"-1/4" REDUCING ADAPTOR

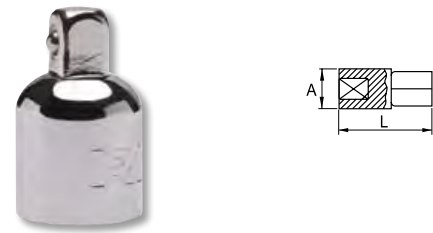

- Reducing adaptor 3/8" to 1/4"
- Standard: DIN 3120

Part No.	QTY	A mm	L mm	Weight (g)
115-46-1	5	16.0	25.0	17

3/8"-1/2" INCREASING ADAPTOR



- Increasing adaptor 3/8" to 1/2"
- Standard: DIN 3120

Part No.	QTY	A mm	L mm	Weight (g)
115-44-1	5	18.0	35.5	45

3/8" BIT HOLDER



- 3/8" female square to 5/16" female hex
- Standard: DIN 3120

Part No.	QTY	Size	A mm	L mm	Weight (g)
115-48-1	5	5/16"	15.4	28.0	24

3/8" SOCKET SET

3/8" SOCKET SET, HEXAGONAL AND METRIC



- 3/8" Socket set, 18 pcs
- Hex sockets, metric sizes
- Chrome vanadium alloy steel
- Chrome-plated bright finish
- Standards: DIN 3120, DIN 3124, DIN 3122
- Box in high density polyethylene

Part No.	QTY	QTY	Dimensions	Weight (g)
119-18-4	1	18	320x250x75	3.250

112-07-1, 112-08-1, 112-10-1, 112-11-1, 112-12-1, 112-13-1, 112-14-1, 112-15-1, 112-16-1, 112-17-1, 112-19-1, 112-21-1, 112-22-1		
--	--	--

115-70-1	
----------	--

115-20-1, 115-22-1	
--------------------	--

115-40-1	
----------	--

115-43-1	
----------	--

1/2" SOCKETS

1/2" HEXAGONAL SOCKETS

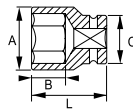

- Chrome vanadium alloy steel
- Chrome-plated bright finish
- Wave shape profile NPP
- Standards: DIN 3120, DIN 3124

R	Icon	Icon	A mm	B mm	C mm	L mm	g
121-08-1	5	8	14.8	13.0	22.0	38.0	50
121-09-1	5	9	15.3	13.0	22.0	38.0	48
121-10-1	5	10	15.3	13.0	22.0	38.0	49
121-11-1	5	11	16.5	13.0	22.0	38.0	50
121-12-1	5	12	17.8	13.0	22.0	38.0	52
121-13-1	5	13	19.0	13.0	22.0	38.0	54
121-14-1	5	14	20.3	13.0	22.0	38.0	56
121-15-1	5	15	22.0	17.8	20.5	38.0	57
121-16-1	5	16	22.0	17.8	20.5	38.0	71
121-17-1	5	17	24.0	17.8	21.9	38.0	72
121-18-1	5	18	25.0	17.8	22.9	38.0	90
121-19-1	5	19	26.0	17.8	22.9	38.0	84
121-20-1	5	20	28.0	17.8	23.9	38.0	87
121-21-1	5	21	28.0	17.8	23.9	38.0	95
121-22-1	5	22	30.0	17.8	26.1	38.0	97
121-23-1	5	23	32.0	17.8	28.1	38.0	103
121-24-1	5	24	32.0	17.8	28.1	38.0	109
121-25-1	5	25	34.0	17.8	29.1	40.0	146
121-26-1	5	26	34.0	17.8	29.1	42.0	192
121-27-1	5	27	36.0	17.8	30.1	42.0	211
121-28-1	5	28	38.0	17.8	32.1	42.0	212
121-30-1	5	30	40.0	17.8	34.1	44.0	214
121-32-1	5	32	42.0	17.8	36.1	44.0	217
121-34-1	5	34	50.0	18.0	38.0	44.0	260
121-36-1	5	36	52.0	18.2	40.0	45.0	300

1/2" BIHEXAGONAL SOCKETS

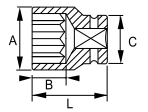

- Chrome vanadium alloy steel
- Chrome-plated bright finish
- Wave shape profile NPP
- Standards: DIN 3120, DIN 3124

R	Icon	Icon	A mm	B mm	C mm	L mm	g
122-08-1	5	8	14.8	13.0	22.0	38.0	50
122-09-1	5	9	15.3	13.0	22.0	38.0	48
122-10-1	5	10	15.3	13.0	22.0	38.0	49
122-11-1	5	11	16.5	13.0	22.0	38.0	50
122-12-1	5	12	17.8	13.0	22.0	38.0	52
122-13-1	5	13	19.0	13.0	22.0	38.0	54
122-14-1	5	14	20.3	13.0	22.0	38.0	56
122-15-1	5	15	22.0	17.8	20.5	38.0	57
122-16-1	5	16	22.0	17.8	20.5	38.0	71
122-17-1	5	17	24.0	17.8	21.9	38.0	72
122-18-1	5	18	25.0	17.8	22.9	38.0	90
122-19-1	5	19	26.0	17.8	22.9	38.0	84
122-20-1	5	20	28.0	17.8	23.9	38.0	87
122-21-1	5	21	28.0	17.8	23.9	38.0	95
122-22-1	5	22	30.0	17.8	26.1	38.0	97
122-23-1	5	23	32.0	17.8	28.1	38.0	103
122-24-1	5	24	32.0	17.8	28.1	38.0	109
122-27-1	5	27	36.0	17.8	30.1	42.0	211
122-30-1	5	30	40.0	17.8	34.1	44.0	214
122-32-1	5	32	42.0	17.8	36.1	44.0	217
122-34-1	5	34	44.0	17.8	37.1	45.0	220
122-36-1	5	36	44.0	17.8	38.1	44.0	220



R	Icon	Icon	A mm	B mm	C mm	L mm	g
122A-10-1	5	5/16"	14.8	13.0	22.0	38.0	50
122A-11-1	5	11/32"	15.3	13.0	22.0	38.0	48
122A-12-1	5	3/8"	15.5	13.0	22.0	38.0	45
122A-14-1	5	7/16"	16.7	13.0	22.0	38.0	49
122A-16-1	5	1/2"	19.2	13.0	22.0	38.0	54
122A-18-1	5	9/16"	20.5	13.0	22.0	38.0	55
122A-20-1	5	5/8"	22.0	17.8	20.6	38.0	69
122A-22-1	5	11/16"	24.0	17.8	21.9	38.0	71
122A-24-1	5	3/4"	26.0	17.8	22.9	38.0	75
122A-26-1	5	13/16"	28.0	17.8	23.9	38.0	76
122A-28-1	5	7/8"	30.0	17.8	26.1	38.0	88
122A-30-1	5	15/16"	32.0	17.8	28.1	38.0	104
122A-34-1	5	1.1/16"	36.0	17.8	30.1	42.0	141
122A-38-1	5	1.3/16"	40.0	17.8	34.1	44.0	214
122A-40-1	5	1.1/4"	42.0	17.8	36.1	44.0	233

1/2" SQUARE DRIVE DEEP SOCKETS WITH METRIC HEX PROFILE

6 mm

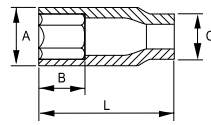

- 1/2" Deep sockets, Hexagonal, sizes in mm
- Chrome vanadium alloy steel
- Knurled shank for finger turning of free running fasteners
- Chrome-plated bright finish
- Wave shape profile NPP
- Standards: DIN 3120, DIN 3124

R			A mm	B mm	C mm	L mm	g
123-10-1	5	10	15.3	27.0	22.0	78.0	78
123-12-1	5	12	17.8	27.0	22.0	78.0	103
123-13-1	5	13	19.0	27.0	22.0	78.0	108
123-14-1	5	14	20.3	27.0	22.0	78.0	109
123-15-1	5	15	22.0	31.0	22.0	78.0	113
123-16-1	5	16	22.0	31.0	22.0	78.0	115
123-17-1	5	17	24.0	31.0	22.0	78.0	123
123-18-1	5	18	25.0	31.0	22.8	78.0	149
123-19-1	5	19	26.0	31.0	22.8	78.0	138
123-21-1	5	21	28.0	31.0	23.8	78.0	151
123-22-1	5	22	30.0	31.0	26.0	78.0	190
123-24-1	5	24	32.0	31.0	28.0	78.0	220

1/2" SOCKETS, TORX®

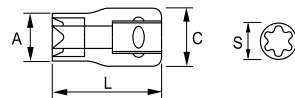

- Standard: DIN 3120

R			S mm	A mm	C mm	L mm	g
126-10-1	5	E-10	9.4	14.7	22.0	38.0	55
126-11-1	5	E-11	10.0	15.2	22.0	38.0	53
126-12-1	5	E-12	11.1	16.0	22.0	38.0	57
126-14-1	5	E-14	12.9	17.0	22.0	38.0	59
126-16-1	5	E-16	14.7	22.0	20.1	38.0	65
126-18-1	5	E-18	16.6	24.0	21.8	38.0	77
126-20-1	5	E-20	18.4	24.0	21.8	38.0	73
126-24-1	5	E-24	22.1	28.0	23.8	38.0	110

1/2" BIHEXAGONAL DEEP SOCKETS

12 mm

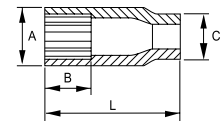

- 1/2" Sockets, long
- Chrome vanadium alloy steel
- Chrome-plated bright finish
- Wave shape profile NPP
- Standards: DIN 3120, DIN 3124

R			A mm	B mm	C mm	L mm	g
124-10-1	5	10	15.3	27.0	22.0	78.0	78
124-11-1	5	11	16.5	27.0	22.0	78.0	86
124-12-1	5	12	17.8	27.0	22.0	78.0	103
124-13-1	5	13	19.0	27.0	22.0	78.0	108
124-14-1	5	14	20.3	27.0	22.0	78.0	109
124-15-1	5	15	22.0	31.0	22.0	78.0	113
124-16-1	5	16	22.0	31.0	22.0	78.0	115
124-17-1	5	17	24.0	31.0	22.0	78.0	123
124-18-1	5	18	25.0	31.0	22.8	78.0	149
124-19-1	5	19	26.0	31.0	22.8	78.0	135
124-21-1	5	21	28.0	31.0	23.8	78.0	151
124-22-1	5	22	30.0	31.0	26.0	78.0	190
124-24-1	5	24	32.0	31.0	28.0	78.0	220
124-27-1	5	27	36.0	31.0	30.0	78.0	250
124-30-1	5	30	40.0	31.0	34.0	78.0	341
124-32-1	5	32	42.0	31.0	36.0	78.0	382

12 in

R			A mm	B mm	C mm	L mm	g
124A-18-1	5	9/16"	22.0	31.0	22.0	78.0	113
124A-20-1	5	5/8"	22.0	31.0	22.0	78.0	115
124A-22-1	5	11/16"	25.0	31.0	22.8	78.0	149
124A-24-1	5	3/4"	26.0	31.0	22.8	78.0	135
124A-26-1	5	13/16"	28.0	31.0	23.8	78.0	151

1/2" BIT DRIVERS

1/2" BIT DRIVER, HEXAGONAL

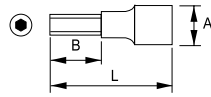

- Hexagonal bit driver
- Standard: DIN 3120 / ISO 1174

R	Icon	Icon	A mm	B mm	L mm	g
180-04-1	5	4	21.8	22	60	70
180-05-1	5	5	21.8	22	60	71
180-06-1	5	6	21.8	22	60	72
180-07-1	5	7	21.8	22	60	72
180-08-1	5	8	21.8	22	60	73
180-10-1	5	10	21.8	22	60	81
180-12-1	5	12	21.8	22	60	89
180-14-1	5	14	21.8	22	60	96
180-17-1	5	17	23.8	22	60	100
180-19-1	5	19	23.8	22	60	100

R	Icon	Icon	A mm	B mm	L mm	g
180-05X-1	5	5	21.8	62	100	89
180-06X-1	5	6	21.8	62	100	90
180-07X-1	5	7	21.8	62	100	91
180-08X-1	5	8	21.8	62	100	91
180-10X-1	5	10	21.8	62	100	109
180-12X-1	5	12	21.8	62	100	130

1/2" BIT DRIVER, TORX®

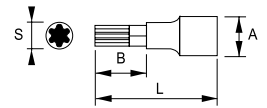

- TORX® Bit driver
- Standard: DIN 3120 / ISO 1174

R	Icon	Icon	S mm	A mm	B mm	L mm	g
183-20-1	5	T20	3.84	21.8	22	60	69
183-25-1	5	T25	4.40	21.8	22	60	69
183-27-1	5	T27	4.96	21.8	22	60	70
183-30-1	5	T30	5.49	21.8	22	60	70
183-40-1	5	T40	6.60	21.8	22	60	70
183-45-1	5	T45	7.77	21.8	22	60	70
183-50-1	5	T50	8.79	21.8	22	60	71
183-55-1	5	T55	11.17	21.8	22	60	76
183-60-1	5	T60	13.20	21.8	22	60	81

R	Icon	Icon	S mm	A mm	B mm	L mm	g
183-40X-1	5	T40	6.60	21.8	82	120	95
183-45X-1	5	T45	7.77	21.8	82	120	96
183-50X-1	5	T50	8.79	21.8	82	120	98
183-55X-1	5	T55	11.17	21.8	102	140	117

1/2" HEX BIT DRIVERS SOCKET SET



- 9 pcs bit driver set 1/2"
- Metric hexagonal bits
- Bright chrome socket
- Black finish bit
- Standard: DIN 3120 / ISO 1174
- Box in high density polyethylene

R	Icon	Icon	Icon	g
129-9H-4	1	9	55x200x160	1.080

180-04-1, 180-05-1, 180-06-1, 180-07-1, 180-08-1, 180-10-1, 180-12-1, 180-14-1, 180-17-1

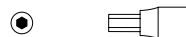

1/2" TORX® BIT DRIVER SOCKET SET



- 9 pcs bit driver set 1/2"
- TORX® bits
- Bright chrome socket
- Black finish bit
- Standard: DIN 3120 / ISO 1174
- Box in high density polyethylene

R	Icon	Icon	Icon	g
129-9T-4	1	9	55x200x160	1.140

183-20-1, 183-25-1, 183-27-1, 183-30-1, 183-40-1, 183-45-1, 183-50-1, 183-55-1, 183-60-1



1/2" BIT DRIVER, XZN



- XZN Bit driver
- Standard: DIN 3120 / ISO 1174

R	Icon	Icon	A mm	B mm	L mm	g
185-05-1	5	M 5	21.8	22	60	67
185-06-1	5	M 6	21.8	22	60	69
185-08-1	5	M 8	21.8	22	60	69
185-10-1	5	M 10	21.8	22	60	77
185-12-1	5	M 12	21.8	22	60	85
185-14-1	5	M 14	21.8	22	60	90
185-16-1	5	M 16	21.8	22	60	95

R	Icon	Icon	A mm	B mm	L mm	g
185-06X-1	5	M 6	21.8	62	100	87
185-08X-1	5	M 8	21.8	62	100	89
185-10X-1	5	M 10	21.8	62	100	105
185-12X-1	5	M 12	21.8	62	100	123

1/2" SOCKET DRIVERS FOR TORX® TAMPER SCREWS



- 1/2" socket drivers for TORX® tamper screws
- Finish: zinc phosphated
- Material: high performance alloy steel
- In plastic bag of 1 piece

R	Icon	Icon	Icon	L mm	L1 mm	g
T49T30XL	1	TR30	1/2"	200	160	122
T49T40XL	1	TR40	1/2"	200	160	123
T49T45XL	1	TR45	1/2"	200	160	125
T49T70HL	1	TR70	1/2"	100	60	167
T49T80HL	1	TR80	1/2"	100	30	163

1/2" ACCESSORIES

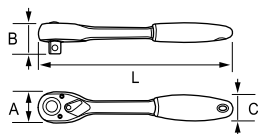

- 72 teeth / 5° action
- Chrome vanadium alloy steel
- Chrome-plated bright finish
- Quick release
- 2-component handle
- Cushion thermo rubber grip
- Standard: DIN 3122, DIN 3120

R	Icon	A mm	B mm	C mm	L mm	g
125-70-1	5	42	41	36	262	591

1/2" REVERSIBLE RATCHET

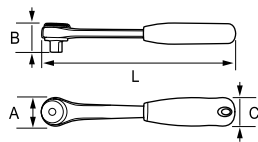
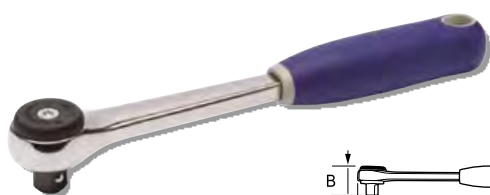

- 72 teeth / 5° action
- High performance alloy steel
- Chrome-plated high polished finish
- 2-component handle
- Cushion thermo rubber grip
- Standards: DIN 3122, DIN 3120, ISO 3315, UNE 16512
- * 125701 Repair Kit

R	Icon	A mm	B mm	C mm	L mm	g
125501	1	39	41	30	251	614



1/2" ACCESSORIES

RATCHET EXHIBITOR WITH 12 1/2" RATCHETS



- Reversible ratchet
- 72 teeth / 5° action
- Chrome vanadium alloy steel
- Chrome-plated bright finish
- Quick release
- 2-component handle
- Cushion thermo rubber grip
- Standard: DIN 3122, DIN 3120
- Use part number 125-70-1 to order individual ratchets

125-70-12DISP	1	12	225 x 295 x 220	7.852

1/2" HEXAGONAL SOCKET SET IN RAIL, 10 pieces



- 1/2" Socket set in display
- 10 pcs socket set
- Hexagonal sockets, metric sizes
- Chrome plated bright finish
- Standard: DIN 3120, DIN 3124, DIN 3122
- Hang sell presentation

129-10-4	5	10	360 x 90 x 15	800

121-10-1, 121-12-1, 121-13-1, 121-14-1, 121-16-1, 121-17-1, 121-19-1, 121-21-1, 121-22-1, 121-24-1

1/2" EXTENSIONS



- Standards: DIN 3120, DIN 3122

		A mm	B mm	L mm	
125-22-1	5	22.4	15.7	75	120
125-23-1	5	22.4	15.7	125	193
125-25-1	5	22.4	15.7	250	380

1/2" SPEED BRACE

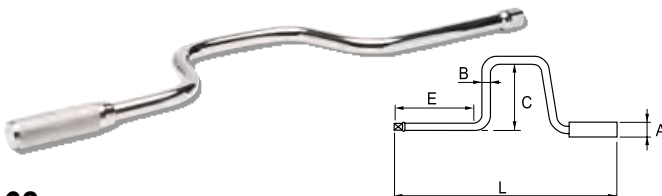

68

1/2" SOCKET SET, HEXAGONAL AND METRIC



- 12 pcs socket set
- Hexagonal sockets, metric sizes
- Chrome plated bright finish
- Standards: DIN 3120, DIN 3124, DIN 3122
- Hang sell presentation
- * Counter display when ordering 8 pieces

129-12-4	8	12	330 x 100 x 50	1.600

125-70-1 125-23-1
 121-10-1, 121-12-1, 121-13-1, 121-14-1, 121-16-1, 121-17-1, 121-19-1, 121-21-1, 121-22-1, 121-24-1

1/2" SWIVEL HANDLE

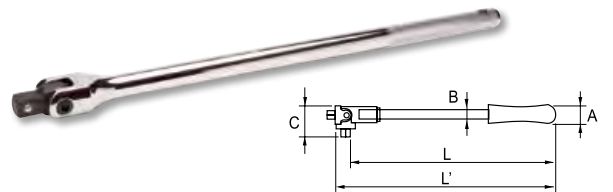

- Standard: DIN 3120

		A mm	B mm	C mm	L' mm	L mm	
125-52-1	5	35	12	40	375	355.0	692

- Standards: DIN 3120, DIN 3122

		A mm	B mm	C mm	E mm	L mm	
125-49-1	5	31.0	12.7	75	152	420	575

1/2" SLIDING T-HANDLE

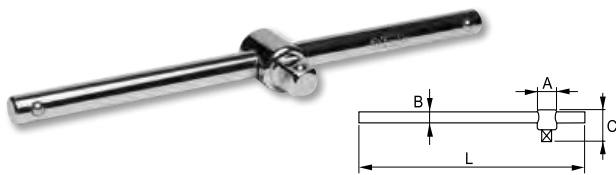

- Standards: DIN 3120, DIN 3122

Part No.	PKT	A mm	B mm	C mm	L mm	g
125-42-1	5	23.5	13.5	45	250	272

1/2"-3/8" REDUCING ADAPTOR



- Reducing adaptor 1/2" to 3/8"
- Standards: DIN 3120, DIN 3122

Part No.	PKT	A mm	L mm	g
125-46-1	5	22.0	35.5	45

1/2" L-HANDLE

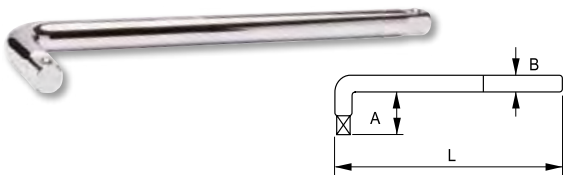

- Standards: DIN 3120, DIN 3122

Part No.	PKT	A mm	B mm	L mm	g
125-60-1	5	46	14	250	456

1/2" UNIVERSAL JOINT



- Standards: DIN 3120, DIN 3122

Part No.	PKT	A mm	L mm	g
125-40-1	5	23.8	72.0	146

1/2" T-HANDLE HEAD

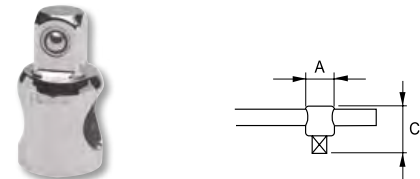

- Sliding T handle head
- Standard: DIN 3120

Part No.	PKT	A mm	C mm	g
125-43-1	5	24.0	44	73

1/2"-3/4" INCREASING ADAPTOR



- Increasing adaptor 1/2" to 3/4"
- Standards: DIN 3120, DIN 3122

Part No.	PKT	A mm	L mm	g
125-44-1	5	25.0	50.0	140

1/2" SPARK PLUG SOCKET

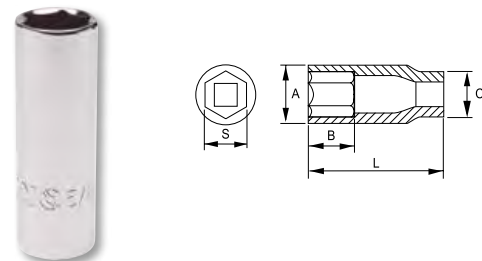

Part No.	PKT	S mm	A mm	B mm	C mm	L mm	g
125-53-1	5	5/8" - 16	22.0	32.0	22.0	65.0	90
125-54-1	5	13/16" - 21	28.0	31.0	24.0	65.0	146

1/2" BIT HOLDER

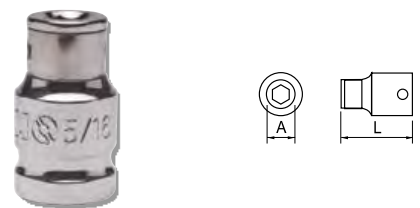

- 1/2" female square to 5/16" female hex
- Standard: DIN 3120

Part No.	PKT	Hex Size	A mm	L mm	g
125-48-1	5	5/16"	17.0	38.5	56





1/2" SOCKET SETS

1/2" SOCKET SET, HEXAGONAL AND METRIC

1/2" SOCKET SET, HEXAGONAL AND METRIC



- 23 pcs socket set
- Hex sockets, metric sizes
- Chrome vanadium alloy steel
- Chrome-plated bright finish
- Standards: DIN 3120, DIN 3124, DIN 3122
- Box in high density polyethylene
- Box with metal locks

- 33 pcs sockets and wrenches set
- Hex sockets, metric sizes
- Combination wrenches, metric sizes
- Chrome vanadium alloy steel
- Chrome-plated bright finish
- Standards: DIN 3120, DIN 3124, DIN 3122
- Box in high density polyethylene
- Box with metal locks

Part No.	Icon 1	Icon 2	Icon 3	Icon 4
129-23-4	1	23	320x250x75	3.500
125-70-1			125-43-1	
125-25-1			125-23-1	
125-40-1				
121-08-1, 121-10-1, 121-12-1, 121-13-1, 121-14-1, 121-16-1, 121-17-1, 121-19-1, 121-20-1, 121-21-1, 121-22-1, 121-23-1, 121-24-1, 121-26-1, 121-27-1, 121-28-1, 121-30-1, 121-32-1				

Part No.	Icon 1	Icon 2	Icon 3	Icon 4
129-33W-4	1	33	320x250x75	5.020
125-70-1			125-43-1	
125-25-1			125-23-1	
125-40-1				
25-08-1, 25-09-1, 25-10-1, 25-11-1, 25-12-1, 25-13-1, 25-14-1, 25-15-1, 25-17-1, 25-19-1				
121-08-1, 121-10-1, 121-12-1, 121-13-1, 121-14-1, 121-16-1, 121-17-1, 121-19-1, 121-20-1, 121-21-1, 121-22-1, 121-23-1, 121-24-1, 121-26-1, 121-27-1, 121-28-1, 121-30-1, 121-32-1				

1/4"-1/2" SOCKET SET, HEXAGONAL AND METRIC



- 58 pcs socket set
- Hex sockets, metric sizes
- Chrome vanadium alloy steel
- Chrome-plated bright finish
- Standards: DIN 3120, DIN 3124, DIN 3122
- Box in high density polyethylene
- Box with metal locks

Part No.	Qty	Qty	Dimensions	Weight
129-58-4	1	58	380x280x80	4.750
105-50-1		105-70-1		
105-42-1		105-40-1		
105-22-1		105-24-1		
125-70-1		125-43-1		
125-25-1		125-40-1		
125-23-1				
101-04-1, 101-045-1, 101-05-1, 101-055-1, 101-06-1, 101-07-1, 101-08-1, 101-09-1, 101-10-1, 101-11-1, 101-12-1, 101-13-1				
121-08-1, 121-10-1, 121-12-1, 121-13-1, 121-14-1, 121-16-1, 121-17-1, 121-19-1, 121-20-1, 121-21-1, 121-22-1, 121-23-1, 121-24-1, 121-26-1, 121-27-1, 121-28-1, 121-30-1, 121-32-1				
040001, 040011, 040021				
475-PH1-1, 475-PH2-1, 475-PH3-1				
475-PZ1-1, 475-PZ2-1, 475-PZ3-1				
475-3-1, 475-4-1, 475-5-5-1				
475-H3-1, 475-H4-1, 475-H5-1, 475-H6-1				

1/4"-1/2" SOCKET SET, HEXAGONAL, INCHES



- 53 pcs socket set
- Hexagonal sockets, AF
- Bright chrome plating finish
- Standards: DIN 3120, DIN 3124, DIN 3122
- Box in high density polyethylene
- Box with metal locks

Part No.	Qty	Qty	Dimensions	Weight
129A-53-4	1	53	380x280x80	4.750
105-48-1		105-70-1		
105-42-1		105-50-1		
105-22-1		105-24-1		
105-40-1		125-70-1		
125-25-1		125-43-1		
125-23-1		125-40-1		
101A-05-1, 101A-06-1, 101A-07-1, 101A-08-1, 101A-09-1, 101A-10-1, 101A-11-1, 101A-12-1, 101A-14-1, 101A-16-1, 101A-18-1				
122A-10-1, 122A-11-1, 122A-12-1, 122A-14-1, 122A-16-1, 122A-18-1, 122A-20-1, 122A-22-1, 122A-24-1, 122A-26-1, 122A-28-1, 122A-30-1, 122A-34-1, 122A-38-1, 122A-40-1				
040001, 040011, 040021				
475-PH1-1, 475-PH2-1, 475-PH3-1				
475-PZ1-1, 475-PZ2-1, 475-PZ3-1				
475-3-1, 475-4-1, 475-5-5-1				
1/4" Hex 1/8", 5/32", 3/16", 7/32" AF				



1/2" SOCKET SETS

1/4"-1/2" SOCKET SET, HEXAGONAL AND METRIC



- 108 pcs socket set
- Hexagonal sockets, metric sizes
- Chrome plated, bright finish
- Standards: DIN 3120, DIN 3124, DIN 3122, ISO 10102
- Box in high density polyethylene
- Box with metal locks

R	Box	X	mm	g
129-108-4	1	108	380x280x80	7.100
105-48-1		105-70-1		
125-42-1		105-50-1		
105-22-1		105-40-1		
105-24-1		125-70-1		
125-48-1		125-43-1		
125-25-1		125-23-1		
125-40-1				
101-04-1, 101-045-1, 101-05-1, 101-055-1, 101-06-1, 101-07-1, 101-08-1, 101-09-1, 101-10-1, 101-11-1, 101-12-1, 101-13-1, 101-14-1		1/4"		
103-06-1, 103-07-1, 103-08-1, 103-09-1, 103-10-1, 103-12-1, 103-13-1		1/4"		
106-04-1, 106-05-1, 106-06-1, 106-07-1, 106-08-1				
121-10-1, 121-11-1, 121-12-1, 121-13-1, 121-14-1, 121-15-1, 121-16-1, 121-17-1, 121-18-1, 121-19-1, 121-20-1, 121-21-1, 121-22-1, 121-24-1, 121-27-1, 121-30-1, 121-32-1		1/2"		
126-10-1, 126-11-1, 126-12-1, 126-14-1, 126-16-1, 126-18-1, 126-20-1, 126-24-1				
124-14-1, 124-15-1, 124-17-1, 124-19-1, 124-22-1		1/2"		
125-53-1, 125-54-1				
107-T08-1, 107-T10-1, 107-T15-1, 107-T20-1, 107-T25-1, 107-T27-1, 107-T30-1				
107-H3-1, 107-H4-1, 107-H5-1, 107-H6-1				
107-PH1-1, 107-PH2-1				
107-PZ1-1, 107-PZ2-1				
107-0840-1, 107-1055-1, 107-1280-1				
040001, 040011, 040021				
045801, 045811, 045821				
470-10.0-1, 470-12.0-1, 470-8.0-1				
470-H10-1, 470-H7-1, 470-H8-1				
470-PH3-1, 470-PH4-1				
470-T40-1, 470-T45-1, 470-T50-1, 470-T55-1, 470-T60-1				
470-PZ3-1, 470-PZ4-1				

1/4"-1/2" SOCKET SET, HEXAGONAL, INCHES



- 103 pcs socket set, AF sizes
- Hexagonal sockets
- Bright chrome plating finish
- Standards: DIN 3120, DIN 3124, DIN 3122
- Box in high density polyethylene
- Box with metal locks

R	Box	X	mm	g
129A-103-4	1	103	380x280x80	7.000
105-40-1		105-70-1		
105-42-1		105-50-1		
105-22-1		105-24-1		
125-70-1		125-43-1		
125-25-1		125-40-1		
125-23-1		125-48-1		
101A-05-1, 101A-06-1, 101A-07-1, 101A-08-1, 101A-10-1, 101A-11-1, 101A-12-1, 101A-14-1, 101A-16-1, 101A-18-1		1/4"		
103A-06-1, 103A-08-1, 103A-09-1, 103A-10-1, 103A-11-1, 103A-12-1, 103A-14-1, 103A-16-1		1/4"		
106-04-1, 106-05-1, 106-06-1, 106-07-1, 106-08-1				
122A-12-1, 122A-14-1, 122A-16-1, 122A-18-1, 122A-20-1, 122A-22-1, 122A-24-1, 122A-26-1, 122A-28-1, 122A-40-1		1/2"		
124A-18-1, 124A-20-1, 124A-22-1, 124A-24-1, 124A-26-1		1/2"		
126-10-1, 126-11-1, 126-12-1, 126-14-1, 126-16-1, 126-18-1, 126-20-1, 126-24-1				
125-53-1, 125-54-1				
107-T08-1, 107-T09-1, 107-T10-1, 107-T15-1, 107-T20-1, 107-T25-1, 107-T27-1, 107-T30-1				
107A-4-1, 107A-5-1, 107A-6-1, 107A-7-1				
107-PH1-1, 107-PH2-1				
107-PZ1-1, 107-PZ2-1				
107-0840-1, 107-1055-1, 107-1280-1				
040001, 040011, 040021				
470-T40-1, 470-T45-1, 470-T50-1, 470-T55-1, 470-T60-1				
470-10.0-1, 470-12.0-1, 470-8.0-1				
470-H7-1, 470-H8-1, 470-H10-1, 470-H12-1, 470-H14-1				
470-PH3-1, 470-PH4-1				
470-PZ3-1, 470-PZ4-1				

1/4"-1/2" SOCKET SET, HEXAGONAL AND METRIC



- 101 pcs socket set
- Hex sockets, metric sizes
- Chrome vanadium alloy steel
- Chrome-plated bright finish
- Standards: DIN 3120, DIN 3124, DIN 3122
- Box in high density polyethylene
- Box with metal locks

Part No.	Qty	Dimensions	Weight
129-101-4	1	101	380x280x80
7.000			
105-48-1		105-70-1	
105-42-1		105-50-1	
105-22-1		105-40-1	
105-24-1		105-28-1	
125-70-1		125-43-1	
125-25-1		125-40-1	
125-23-1		125-48-1	
101-04-1, 101-045-1, 101-05-1, 101-055-1, 101-06-1, 101-07-1, 101-08-1, 101-09-1, 101-10-1, 101-11-1, 101-12-1, 101-13-1, 101-14-1			1/4"
103-06-1, 103-07-1, 103-08-1, 103-10-1, 103-11-1, 103-12-1, 103-13-1, 103-14-1			1/4"
121-08-1, 121-10-1, 121-12-1, 121-13-1, 121-14-1, 121-16-1, 121-17-1, 121-19-1, 121-20-1, 121-21-1, 121-22-1, 121-23-1, 121-24-1, 121-26-1, 121-27-1, 121-28-1, 121-30-1, 121-32-1			1/2"
124-13-1, 124-17-1, 124-19-1, 124-22-1			1/2"
107-T08-1, 107-T10-1, 107-T15-1, 107-T20-1, 107-T25-1, 107-T30-1			
107-H3-1, 107-H 4-1, 107-H5-1, 107-H6-1			
107-PH1-1, 107-PH2-1			
107-PZ1-1, 107-PZ2-1			
107-0840-1, 107-1055-1, 107-1280-1			
040001, 040011, 040021			
475-H3-1, 475-H4-1, 475-H5-1			
475-T10-1, 475-T15-1, 475-T20-1, 475-T25-1, 475-T27-1, 475-T30-1			
470-8.0-1, 470-10.0-1			
470-H6-1, 470-H7-1, 470-H8-1, 470-H10-1			
470-T30-1, 470-T40-1, 470-T45-1, 470-T50-1, 470-T55-1			

SOCKET SET 1/4", 3/8" AND 1/2"



- 172 pcs socket set
- Hexagonal sockets, metric sizes
- Chrome plated, bright finish
- DIN 3120, DIN 3124, DIN 3122, ISO 10102
- Box in high density polyethylene
- Box with metal locks

Part No.	Qty	Dimensions	Weight
129-172-4	1	172	100x500x370
9.650			
105-48-1		105-70-1	
105-42-1		105-50-1	
105-22-1		105-40-1	
105-24-1		115-70-1	
115-22-1		115-48-1	
115-40-1			
125-70-1		125-43-1	
125-25-1		125-40-1	
125-23-1		125-48-1	
101-04-1, 101-045-1, 101-05-1, 101-055-1, 101-06-1, 101-07-1, 101-08-1, 101-09-1, 101-10-1, 101-11-1, 101-12-1, 101-13-1, 101-14-1			1/4"
103-04-1, 103-05-1, 103-06-1, 103-07-1, 103-08-1, 103-09-1, 103-10-1			1/4"
106-04-1, 106-05-1, 106-06-1, 106-07-1, 106-08-1			
112-10-1, 112-11-1, 112-12-1, 112-13-1, 112-14-1, 112-15-1, 112-16-1, 112-17-1, 112-18-1, 112-19-1			3/8"
113-10-1, 113-11-1, 113-12-1, 113-13-1, 113-14-1, 113-15-1			3/8"
126-20-1, 126-24-1			
125-53-1, 125-54-1			
121-10-1, 121-11-1, 121-12-1, 121-13-1, 121-14-1, 121-15-1, 121-16-1, 121-17-1, 121-18-1, 121-19-1, 121-20-1, 121-21-1, 121-22-1, 121-24-1, 121-27-1, 121-30-1, 121-32-1			1/2"
107-T08-1, 107-T09-1, 107-T10-1, 107-T15-1, 107-T20-1, 107-T25-1, 107-T27-1, 107-T30-1			
107-H3-1, 107-H4-1, 107-H5-1, 107-H6-1			
107-PH0-1, 107-PH1-1, 107-PH2-1			
107-PZ0-1, 107-PZ1-1, 107-PZ2-1			
1/4" Drive bit socket: 4.5-5-6.5-7 mm			
1/4" Drive bit socket: T8H-T9H-T10H-T15H-T20H-T25H-T27H-T30H			
3/8" Drive E-Profile sockets: E10-E11-E12-E14-E16-E18			
3/8" Drive Spark Plug Socket: 16 mm			
1/2" Drive Deep Socket: (6 PT) 16-17-18-19-22 mm			
Hex Key Wrench: 1.5-2-2.5-3-4-5-6 mm			

20 pcs 1/4" bit 25 mm L W/ Holder: T8-T9-T10-T15-T20-T25-T27-T30-T40-T45 / H3-H4-H5-H6 / PH0-PH1-PH2 / PZ0-PZ1-PZ2

24 pcs 8 mm Bit 30 mm L: T40-T45-T50-T55-T60-T70 / H7-H8-H10-H12-H14 / T40H-T45H-T50H-T55H-T60H-T70H / PH3-PH4 / PZ3-PZ4 / SL8-SL10-SL12

1/2" SOCKET SETS

SOCKET SET 1/4, 3/8 AND 1/2"



- 164 pcs socket set
- Hex sockets, metric sizes
- Chrome vanadium alloy steel
- Chrome-plated bright finish
- Standards: DIN 3120, DIN 3124, DIN 3122
- Box in high density polyethylene
- Box with two extra locks to ensure the transport

Part No.	Qty	Box Qty	Box Dim (mm)	Weight (g)
149-164-4	1	164	490x370x100	12.919
105-48-1			105-70-1	
105-24-1			105-50-1	
105-22-1			105-40-1	
115-70-1			115-40-1	
115-20-1			115-24-1	
115-44-1			115-46-1	
115-48-1			125-70-1	
125-23-1			125-25-1	
125-46-1			125-40-1	
601-200-1			612-160-1	
475R-1/4-30			48-9-H	
475-5-1				
101-04-1, 101-05-1, 101-055-1, 101-06-1, 101-07-1, 101-08-1, 101-09-1, 101-10-1, 101-11-1, 101-12-1			1/4"	
103-04-1, 103-05-1, 103-06-1, 103-07-1, 103-08-1, 103-09-1, 103-10-1, 103-11-1, 103-12-1			1/4"	
112-08-1, 112-09-1, 112-10-1, 112-11-1, 112-12-1, 112-13-1, 112-14-1, 112-15-1, 112-16-1, 112-17-1, 112-18-1, 112-19-1			3/8"	
113-08-1, 113-09-1, 113-10-1, 113-11-1, 113-12-1, 113-13-1, 113-14-1, 113-15-1, 113-17-1, 113-19-1			3/8"	
121-14-1, 121-17-1, 121-18-1, 121-19-1, 121-20-1, 121-21-1, 121-22-1, 121-24-1, 121-27-1, 121-30-1, 121-32-1			1/2"	
124-12-1, 124-13-1, 124-14-1, 124-15-1, 124-17-1, 124-18-1, 124-19-1, 124-21-1, 124-22-1			1/2"	
167-17-1, 167-19-1, 167-21-1, 167-23-1			1/2"	
18-12-1, 18-13-1, 18-14-1				
25-08-1, 25-09-1, 25-10-1, 25-11-1, 25-12-1, 25-13-1, 25-14-1, 25-17-1, 25-18-1, 25-19-1				
475-T10-1, 475-T15-1, 475-T20-1, 475-T25-1, 475-T27-1, 475-T30-1, 475-T40-1				
475-TR10-1, 475-TR15-1, 475-TR20-1, 475-TR25-1, 475-TR27-1, 475-TR30-1, 475-TR40-1				
3/8" Drive Spark Plug Sockets: 16-21 mm				
3/8" Drive bit socket: 3-4-5-6 mm				
3/8" Drive bit sockets: PH1-PH2				
3/8" Drive bit sockets: PZ1-PZ2				
3/8" Drive bit sockets: TR10-TR15-TR20-TR25-TR30-TR40				
3/8" TORX® sockets: E8, E10, E11, E12, E14, E16, E18, E20				

3/4" SOCKETS

3/4" HEXAGONAL SOCKETS

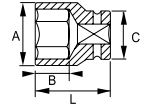

- Chrome vanadium alloy steel
- Chrome-plated bright finish
- Hexagonal
- Wave shape profile NPP
- Standards: DIN 3124, DIN 3120

Part No.	Qty	Hex Size (mm)	A (mm)	B (mm)	C (mm)	L (mm)	Weight (g)
131-19-1	1	19	30	12	36	50	200
131-21-1	1	21	32	12	36	50	215
131-22-1	1	22	33	12	36	50	215
131-23-1	1	23	34	14	36	50	215
131-24-1	1	24	34	16	36	50	215
131-25-1	1	25	38	16	36	50	220
131-26-1	1	26	38	16	36	52	220
131-27-1	1	27	38	18	36	52	240
131-28-1	1	28	38	18	36	52	250
131-29-1	1	29	42	18	38	52	260
131-30-1	1	30	42	20	38	52	275
131-32-1	1	32	44	22	38	52	310
131-33-1	1	33	46	22	38	55	340
131-34-1	1	34	46	22	38	57	330
131-35-1	1	35	48	24	42	57	380
131-36-1	1	36	50	24	42	57	415
131-38-1	1	38	52	26	44	57	455
131-40-1	1	40	56	27	44	63	505
131-41-1	1	41	56	27	44	63	545
131-42-1	1	42	58	27	44	63	600
131-46-1	1	46	62	30	44	68	650
131-50-1	1	50	68	33	44	72	755
131-55-1	1	55	75	36	48	75	1.000
131-60-1	1	60	80	39	48	77	1.100

3/4" BIHEXAGONAL SOCKETS

12 mm

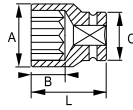

- Chrome vanadium alloy steel
- Chrome-plated bright finish
- Bi-Hexagonal
- Wave shape profile NPP
- Standards: DIN 3120, DIN 3124

Part No.	Box	Profile	A mm	B mm	C mm	L mm	g
131B-19-2	1	19	30	12	36	50	200
131B-21-2	1	21	32	12	36	50	215
131B-22-2	1	22	33	12	36	50	215
131B-23-2	1	23	34	14	36	50	215
131B-24-2	1	24	34	16	36	50	215
131B-26-2	1	26	38	16	36	52	220
131B-27-2	1	27	38	18	36	52	240
131B-29-2	1	29	42	18	38	52	260
131B-30-2	1	30	42	20	38	52	275
131B-32-2	1	32	44	22	38	52	310
131B-35-2	1	35	48	24	42	57	380
131B-36-2	1	36	50	24	42	57	415
131B-38-2	1	38	52	26	44	57	455
131B-41-2	1	41	56	27	44	63	545
131B-46-2	1	46	56	27	44	63	545
131B-50-2	1	50	67	29	46	72	715

12 in

Part No.	Box	Profile	A mm	B mm	C mm	L mm	g
132A-28-1	1	7/8"	33	12	36	50	215
132A-30-1	1	15/16"	35	16	36	50	215
132A-32-1	1	1"	38	16	36	52	200
132A-34-1	1	1.1/16"	38	18	36	54	240
132A-36-1	1	1.1/8"	42	18	38	55	280
132A-40-1	1	1.1/4"	44	22	38	55	310
132A-42-1	1	1.5/16"	46	22	38	57	340
132A-44-1	1	1.3/8"	48	24	42	57	380
132A-46-1	1	1.7/16"	50	24	42	57	415
132A-48-1	1	1.1/2"	52	26	44	57	455
132A-52-1	1	1.5/8"	56	27	44	63	545
132A-54-1	1	1.11/16"	58	27	44	63	600
132A-60-1	1	1.7/8"	65	30	44	68	700
132A-64-1	1	2"	68	33	44	72	755

3/4" ACCESSORIES

3/4" REVERSIBLE RATCHET HEAD

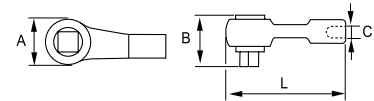

- 24 Teeth
- Chrome vanadium alloy steel
- Chrome-plated bright finish
- Quick release
- Standards: DIN 3120, DIN 3122

Part No.	Box	A mm	B mm	C mm	L mm	g
135-70-1	1	65	61.5	20	155	1.360

3/4" EXTENSIONS

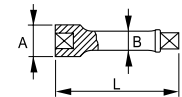

- Ball retaining system

Part No.	Box	A mm	B mm	L mm	g
135-21-1	1	36	23	125	515
135-22-1	1	36	23	200	725
135-24-1	1	36	23	400	1.350

3/4" RATCHET HANDLE

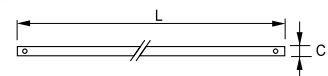

- Ratchet handle

Part No.	Box	C mm	L mm	g
135-85-1	1	20	450	1.100

3/4" SLIDING T-HANDLE

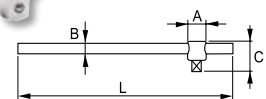

- Ball retaining system

Part No.	Box	A mm	B mm	C mm	L mm	g
135-42-1	1	36	20	60	450	1.335

3/4" ACCESSORIES

SLIDING T HANDLE HEAD

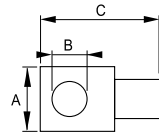

- Ball retaining system

R	Box	A mm	B mm	C mm	g
135-43-1	1	35	20.5	60	235

3/4"-1/2" REDUCING ADAPTOR

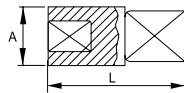

- Reducing adaptor 3/4" to 1/2"
- Ball retaining system

R	Box	A mm	L mm	g
135-46-1	1	36	54	260

3/4" SOCKET SETS

3/4" SOCKET SET, METRIC



- 17 pcs socket set
- Hex sockets, metric sizes
- Chrome vanadium alloy steel
- Chrome-plated bright finish
- Standards: DIN 3120, DIN 3124, DIN 3122
- Box in high density polyethylene
- Box with metal locks
- Spare Box part number: SP-106S-BOX17
- Two spare locks 3/4": SP104S

R	Box	X	Box	g
139-17-4	1	17	475x295x100	12.500

135-70-1		135-24-1	
----------	--	----------	--

135-22-1		135-43-1	
----------	--	----------	--

135-85-1	
----------	--

131-22-1, 131-24-1, 131-27-1, 131-30-1, 131-32-1, 131-33-1, 131-34-1, 131-36-1, 131-38-1, 131-41-1, 131-46-1, 131-50-1

3/4" UNIVERSAL JOINT

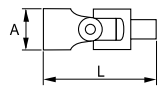

- Ball retaining system

R	Box	A mm	L mm	g
135-40-1	1	40	108	540

3/4" SWIVEL HANDLE

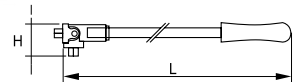
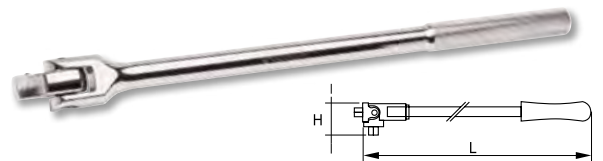

- Ball retaining system

R	Box	H mm	L mm	g
135-52-1	1	40	450	1.700

3/4" SOCKET SET, METRIC



- 21 pcs socket set
- Hexagonal sockets, metric sizes
- Chrome vanadium alloy steel
- Chrome plated bright finish
- Standards: DIN 3120, DIN 3124, DIN 3122
- Box in high density polyethylene
- Box with metal locks
- Spare Box part number: SP-106S-BOX21

R	Box	X	Box	g
139-21-4	1	21	475x295x100	11.900

135-70-1		135-24-1	
----------	--	----------	--

135-22-1		135-43-1	
----------	--	----------	--

135-85-1	
----------	--

131-19-1, 131-21-1, 131-22-1, 131-23-1, 131-24-1, 131-26-1, 131-27-1, 131-29-1, 131-30-1, 131-32-1, 131-35-1, 131-36-1, 131-38-1, 131-41-1, 131-46-1, 131-50-1

3/4" SOCKET SET, METRIC

3/4" mm



- 21 pcs socket set
- Bihexagonal sockets, metric sizes
- Chrome vanadium alloy steel
- Chrome plated bright finish
- Standards: DIN 3120, DIN 3124, DIN 3122
- Box in high density polyethylene
- Box with metal locks
- Spare Box part number: SP-106S-BOX21

Part No.	Qty	Material	Dimensions	Weight
139-21B-4	1	21	475x295x100	11.900
135-70-1				
135-22-1				
135-24-1				
135-43-1				
135-85-1				

131B-19-2, 131B-21-2, 131B-22-2, 131B-23-2, 131B-24-2, 131B-26-2, 131B-27-2, 131B-29-2, 131B-30-2, 131B-32-2, 131B-35-2, 131B-36-2, 131B-38-2, 131B-41-2, 131B-46-2, 131B-50-2

3/8" IMPACT SOCKETS

3/8" IMPACT HEXAGONAL SOCKETS, METRIC

6 mm

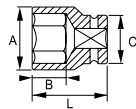

3/8" IMPACT HEXAGONAL SOCKETS, LONG SERIES, METRIC

6 mm

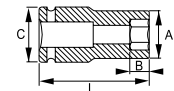

- Standards: UNE 16507, ISO 2725, DIN 3129

Part No.	Qty	Material	A mm	B mm	C mm	L mm	g
160-07-1	1	7	12.6	13	19	32	39
160-08-1	1	8	14	13	19	32	39
160-10-1	1	10	15.8	13	19	32	40
160-11-1	1	11	16.9	13	19	32	41
160-12-1	1	12	18.2	13	19	32	41
160-13-1	1	13	19.5	13	22	32	54
160-14-1	1	14	20.5	13	22	32	54
160-15-1	1	15	22	16	22	32	54
160-16-1	1	16	24	16	22	32	57
160-17-1	1	17	25	17	22	34	67
160-18-1	1	18	26	17	22	34	67
160-19-1	1	19	28	17	22	34	71
160-20-1	1	20	28	17	22	34	79
160-21-1	1	21	30	17	22	34	80
160-24-1	1	24	34	17	22	34	102

Part No.	Qty	Material	A mm	B mm	C mm	L mm	g
161-10-1	1	10	15.9	10	19	63	77
161-13-1	1	13	19.7	10	19	63	96
161-17-1	1	17	24.5	11	22	63	184

3/8" IMPACT ACCESSORIES

3/8" EXTENSIONS



- Standards: DIN 16503, ISO 1174

R	Box	A mm	B mm	L mm	g
162-00-1	1	19	12.5	75	99
162-02-1	1	19	12.5	150	159

3/8" UNIVERSAL JOINT



- Standards: DIN 16503, ISO 1174

R	Box	A mm	L mm	g
162-50-1	1	22	50	124

3/8"-1/4" REDUCING ADAPTOR

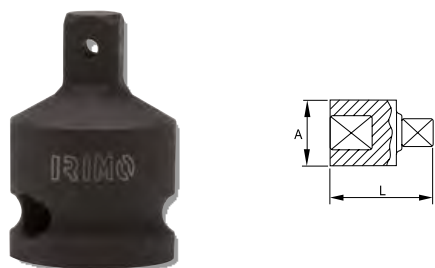

- 3/8" to 1/4" reducing adaptor
- Standards: DIN 16503, ISO 1174
- Due to the special working conditions of this adaptor, it is not guaranteed against male failure

R	Box	A mm	L mm	g
162-65-1	1	19	28	57

3/8"-1/2" INCREASING ADAPTOR

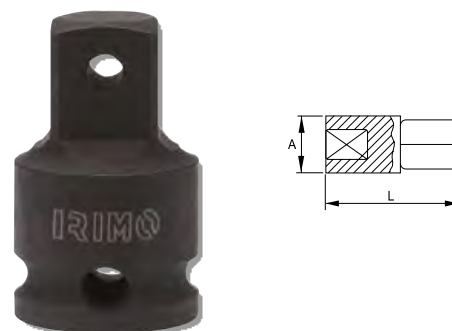

- 3/8" to 1/2" increasing adaptor
- Standards: DIN 16503, ISO 1174

R	Box	A mm	L mm	g
162-60-1	1	22	36	96

SAFETY SPRINGS



- 3/8" safety rings

R	Box	□	○	g
162931	1	3/8"	7-12	2
162941	1	3/8"	13-24	2

1/2" IMPACT SOCKETS

1/2" IMPACT HEXAGONAL SOCKETS, METRIC

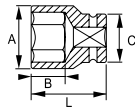

• Standards: UNE 16507, ISO 2725, DIN 3129

R			A mm	B mm	C mm	L mm	g
167-08-1	1	8	15	15	25	38	84
167-10-1	1	10	17.5	15	25	38	89
167-12-1	1	12	19	15	25	38	94
167-13-1	1	13	20	15	25	38	94
167-14-1	1	14	22	15	25	38	94
167-15-1	1	15	23	15	25	38	134
167-16-1	1	16	24	15	25	38	134
167-17-1	1	17	26	15	30	38	134
167-18-1	1	18	27	15	30	38	134
167-19-1	1	19	28	17.5	30	38	134
167-20-1	1	20	29	17.5	30	38	137
167-21-1	1	21	30	17.5	30	38	149
167-22-1	1	22	32	17.5	30	38	149
167-23-1	1	23	34	18	30	40	149
167-24-1	1	24	34	18	30	40	179
167-26-1	1	26	36	22	30	42	189
167-27-1	1	27	38	22	30	42	204
167-30-1	1	30	42	22	30	44	234
167-32-1	1	32	44	22	40	44	282
167-34-1	1	34	46	22	40	48	406
167-36-1	1	36	48	22	40	48	467
167-38-1	1	38	50	23	40	48	480
167-41-1	1	41	50	24	42	48	495

1/2" IMPACT HEXAGONAL SOCKETS, LONG SERIES, METRIC

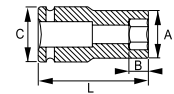

R			A mm	B mm	C mm	L mm	g
168-10-1	1	10	17.5	24	25	78	118
168-11-1	1	11	18	24	25	78	121
168-13-1	1	13	20	24	25	78	163
168-14-1	1	14	22	37	25	78	190
168-16-1	1	16	24	37	25	78	239
168-17-1	1	17	26	37	30	78	239
168-18-1	1	18	27	37	30	78	239
168-19-1	1	19	28	39	30	78	246
168-21-1	1	21	30	39	30	78	267
168-22-1	1	22	32	39	30	78	328
168-23-1	1	23	34	39	30	78	348
168-24-1	1	24	34	39	30	78	351
168-27-1	1	27	38	39	30	78	373
168-30-1	1	30	42	39	30	78	409
168-32-1	1	32	43	40	32	78	415

1/2" IMPACT SOCKET HEXAGONAL SET MM, 7 pieces



- High performance Cr-Mo alloy steel
- Phosphated finish
- To be used with machines
- To be used with safety spring
- Dynamic-drive profile to protect nuts
- High density polyethylene box
- Standards: UNE 16507, DIN 3129, ISO 2725

R				g
168-7-4	1	7	52x180x255	2.100

168-10-1, 168-13-1, 168-17-1, 168-19-1, 168-22-1, 168-24-1, 168-27-1



1/2" IMPACT SOCKETS

1/2" IMPACT SOCKET HEXAGONAL SET MM, 9 pieces



- High performance Cr-Mo alloy steel
- Phosphated finish
- To be used with machines
- To be used with safety spring 169921 or 169931
- Dynamic-drive profile to protect nuts
- High density polyethylene box
- Standards: UNE 16507, DIN 3129, ISO 2725

167-9-4	1	9	58x170x210	1.610

167-17-1, 167-19-1, 167-22-1, 167-24-1, 167-27-1

169-01-1 169-25-1

169-65-1 169-60-1

1/2" IMPACT SOCKET HEXAGONAL SET MM, 11 pieces



- High performance Cr-Mo alloy steel
- Phosphated finish
- To be used with machines
- To be used with safety spring
- Dynamic-drive profile to protect nuts
- High density polyethylene box
- -Standards: UNE 16507, DIN 3129, ISOV2725

167-11-4	1	11	58x170x210	1.600

167-08-1, 167-10-1, 167-12-1, 167-14-1, 167-17-1, 167-19-1, 167-22-1, 167-24-1, 167-27-1

169-03-1 169-25-1

1/2" IMPACT SOCKET SET, 10 pieces



- Set 10 impact socket
- Strong blow moulded case
- Hex sockets
- Black finish
- Standards: ISO 2725, DIN 3129
- Plastic box in high density polyethylene

167-10-4	1	10	200x160x52	1.425

167-10-1, 167-13-1, 167-14-1, 167-16-1, 167-17-1, 167-18-1, 167-19-1, 167-21-1, 167-22-1, 167-24-1

1/2" IMPACT SOCKET HEXAGONAL SET MM, 14 pieces



- High performance Cr-Mo alloy steel
- Phosphated finish
- To be used with machines
- To be used with safety spring
- Dynamic-drive profile to protect nuts
- High density polyethylene box
- Standards: UNE 16507, DIN 3129, ISO 2725

168-14-4	1	14	82x263x335	4.230

168-10-1, 168-11-1, 168-13-1, 168-14-1, 168-16-1, 168-17-1, 168-18-1, 168-19-1, 168-21-1, 168-22-1, 168-24-1, 168-27-1, 167-30-1, 167-32-1



1/2" IMPACT ACCESSORIES

1/2" EXTENSIONS

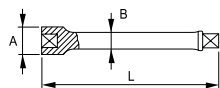

- Standards: DIN 16503, ISO 1174

Part No.	Box	A mm	B mm	L mm	g
169-03-1	1	25	16.5	75	139
169-01-1	1	25	16.5	125	274
169-02-1	1	25	16.5	150	484

1/2"-3/4" INCREASING ADAPTOR

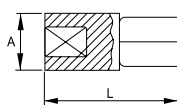

- 1/2" to 3/4" increasing adaptor
- Standards: DIN 16503, ISO 1174

Part No.	Box	A mm	L mm	g
169-60-1	1	30	48	114

1/2" UNIVERSAL JOINT

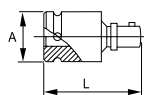

- Standards: DIN 16503, ISO 1174

Part No.	Box	A mm	L mm	g
169-25-1	1	30	63	189

1/2"-3/8" REDUCING ADAPTOR

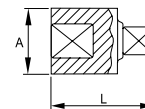

- 1/2" to 3/8" reducing adaptor
- Standards: ISO 1174, DIN 16503
- Due to the special working conditions of this adaptor, it is not guaranteed against male failure

Part No.	Box	A mm	L mm	g
169-65-1	1	25	38	129

SAFETY SPRINGS



- 1/2" safety rings

Part No.	Box	Size	Length	Weight	
169921	1	1/2"	10-14	5-10	2
169931	1	1/2"	15-36	12-19	2

3/4" IMPACT SOCKETS

3/4" IMPACT HEXAGONAL SOCKETS, METRIC

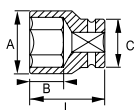

Standards: UNE 16507, ISO 2725, DIN 3129

Part No.	Box	Hex Size	A mm	B mm	C mm	L mm	Weight (g)
173-17-2	1	17	30	21	44	51	339
173-18-2	1	18	32	21	44	51	339
173-19-2	1	19	33	21	44	51	349
173-21-2	1	21	35	21	44	51	359
173-22-2	1	22	36	21	44	51	359
173-23-2	1	23	37	21	44	51	369
173-24-2	1	24	38	21	44	51	379
173-27-2	1	27	41	21	44	51	399
173-28-2	1	28	42	23	44	51	409
173-29-2	1	29	45	23	44	51	409
173-30-2	1	30	46	23	44	51	439
173-32-2	1	32	48	27	44	57	469
173-33-2	1	33	50	27	44	57	489
173-34-2	1	34	51	27	44	57	509
173-36-2	1	36	53	27	44	57	519
173-38-2	1	38	56	27	44	57	559
173-41-2	1	41	59	28	44	58	659
173-46-2	1	46	66	30	44	62	709
173-50-2	1	50	71	32	54	65	839
173-55-2	1	55	77	37	54	70	1109
173-60-2	1	60	84	37	54	70	1200

3/4" IMPACT HEXAGONAL SOCKETS, LONG SERIES, METRIC

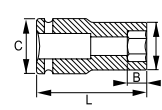

Part No.	Box	Hex Size	A mm	B mm	C mm	L mm	Weight (g)
174-17-2	1	17	30	23	44	90	560
174-19-2	1	19	33	23	44	90	600
174-21-2	1	21	35	23	44	90	680
174-22-2	1	22	36	23	44	90	700
174-24-2	1	24	38	23	44	90	750
174-27-2	1	27	41	23	44	90	800
174-30-2	1	30	46	27	44	90	898
174-32-2	1	32	48	27	44	90	957
174-33-2	1	33	50	27	44	90	1010
174-34-2	1	34	51	27	44	90	1030
174-36-2	1	36	55	27	44	90	1084
174-41-2	1	41	59	28	44	90	1270

3/4" IMPACT ACCESSORIES

3/4" UNIVERSAL JOINT

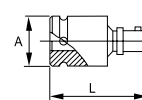

Standards: DIN 16503, ISO 1174

Part No.	Box	A mm	L mm	Weight (g)
175-25-2	1	42	92	580

SAFETY SPRINGS



3/4" safety rings

Part No.	Box	Hex Size	Inner Dia mm	Outer Dia mm	Weight (g)
175911	1	3/4"	17-46	12-24	2
179931	1	3/4"	50-60		2

3/4" IMPACT SOCKET SET, IN METAL BOX



Set in metal box

Part No.	Box	Hex Size	Range	Weight (g)
173-01-5	1	8	24 - 27 - 29 - 30 - 32 - 34 - 36 - 38 mm	4.000

3/4" IMPACT ACCESSORIES

3/4" EXTENSIONS



- Standards: DIN 16503, ISO 1174

Part No.	Box	A mm	B mm	L mm	g
175-01-2	1	175	44	21	850
175-10-2	1	250	44	21	1.190
175-02-2	1	325	44	21	1.460

3/4"-1" INCREASING ADAPTOR



- 3/4" to 1" increasing adaptor
- Standards: DIN 16503, ISO 1174

Part No.	Box	A mm	L mm	g
175-60-2	1	44	63	410

3/4"-1/2" REDUCING ADAPTOR



- 3/4" to 1/2" reducing adaptor
- Standards: DIN 16503, ISO 1174
- Due to the special working conditions of this adaptor, it is not guaranteed against male failure

Part No.	Box	A mm	L mm	g
175-65-2	1	44	57	350

1" IMPACT SOCKETS

1" IMPACT HEXAGONAL SOCKETS, METRIC



- Standards: UNE 16507, ISO 2725, DIN 3129

Part No.	Box	Hex	A mm	B mm	C mm	L mm	g
177-22-2	1	22	39	22	54	58	645
177-24-2	1	24	41	22	54	58	650
177-27-2	1	27	46	22	54	58	670
177-30-2	1	30	49	24	54	62	680
177-32-2	1	32	52	24	54	62	695
177-33-2	1	33	54	24	54	62	695
177-34-2	1	34	54	24	54	62	720
177-36-2	1	36	56	29	54	65	800
177-38-2	1	38	58	29	54	65	845
177-41-2	1	41	61	34	54	70	920
177-42-2	1	42	64	34	54	70	950
177-46-2	1	46	68	36	54	75	1150
177-50-2	1	50	73	36	54	75	1375
177-55-2	1	55	79	44	54	83	1540
177-60-2	1	60	86	47	54	87	1700
177-65-2	1	65	92	47	54	90	1940
177-70-2	1	70	97	47	54	93	2450
177-75-2	1	75	104	47	86	95	2900
177-80-2	1	80	110	39	86	100	3300

1" IMPACT SOCKET SET, IN METAL BOX



- Set in metal box

Part No.	Box	Quantity	Hex	g
177-10-5	1	7	24 - 27 - 30 - 32 - 33 - 36 - 38 mm	5.500



1" IMPACT SOCKETS

1" IMPACT HEXAGONAL SOCKETS, LONG SERIES, METRIC

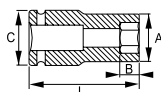

R	Icon	Hex Size	A mm	B mm	C mm	L mm	g
178-22-2	1	22	39	23	54	90	975
178-24-2	1	24	42	23	54	90	1016
178-27-2	1	27	46	23	54	90	1134
178-30-2	1	30	49	24	54	90	1256
178-32-2	1	32	52	24	54	90	1297
178-33-2	1	33	54	24	54	92	1311
178-34-2	1	34	54	24	54	92	1350
178-36-2	1	36	56	29	54	92	1474
178-38-2	1	38	58	29	54	92	1479
178-41-2	1	41	61	34	54	92	1533
178-46-2	1	46	68	36	54	95	1710
178-50-2	1	50	73	36	54	95	1896
178-55-2	1	55	79	44	54	100	2155
178-60-2	1	60	86	47	54	100	2372

1" IMPACT ACCESSORIES

1" EXTENSIONS

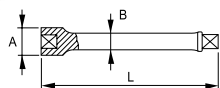

- Standards: DIN 16503, ISO 1174

R	Icon	A mm	B mm	L mm	g
179-00-2	1	125	54	34	1.085
179-01-2	1	175	54	34	1.390
179-02-2	1	325	54	34	2.395

SAFETY SPRINGS



- 1" safety rings

R	Icon	Hex Size	19-70	17-27	g
179931	1	1"	19-70	17-27	9
179941	1	1"	75-80		13

1"-3/4" REDUCING ADAPTOR

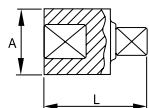

- 1" to 3/4" reducing adaptor
- Standards: DIN 16503, ISO 1174
- Due to the special working conditions of this adaptor, it is not guaranteed against male failure

R	Icon	A mm	L mm	g
179-65-2	1	54	70	350

1" UNIVERSAL JOINT

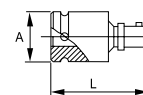

- Standards: DIN 16503, ISO 1174

R	Icon	A mm	L mm	g
179-52-2	1	54	120	650



05.

CLAMPING TOOLS

BENCH VICES

ROUND GUIDE VICE

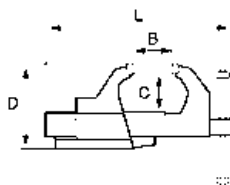

SQUARE GUIDE VICE



- Round guide bench vice
- Heavy duty
- Manufactured by high grade cast steel
- Interchangeable jaws
- Oversized anvil
- Laminated spindle thread
- Smooth operation
- Can be used with swivel base

R	Icon	B mm	C mm	D mm	L mm	g	
201231	1	80	90	42	130	260	5.850
201241	1	100	110	56	166	325	11.350
201251	1	125	130	72	196	375	18.200
201261	1	150	170	80	230	430	29.700

- Heavy duty square guide bench vice
- Manufactured from high grade cast steel
- Interchangeable jaws
- Oversized anvil
- Laminated spindle thread for smooth operation
- Can be used with swivel base
- Free play adjustment via screw mechanism
- With pipe holding jaws

R	Icon	B mm	C mm	D mm	L mm	g	
216041	1	100	145	50	122	325	6.497
216051	1	125	170	63	152	402	13.733
216061	1	150	230	80	182	492	20.388
216071	1	175	250	94	211	551	30.688

SQUARE GUIDE VICE

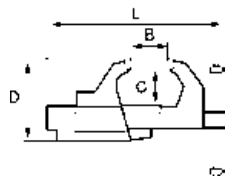

- Heavy duty square guide bench vice
- Manufactured from high grade cast steel
- Oversized anvil
- Interchangeable jaws are available
- Laminated spindle thread for smooth operation
- Can be used with swivel base

R	Icon	B mm	C mm	D mm	L mm	g	
207041	1	100	145	50	122	325	6.200
207051	1	125	170	63	152	402	13.200
207061	1	150	230	80	182	492	19.800
207071	1	175	250	94	211	551	30.100

SQUARE GUIDE VICE

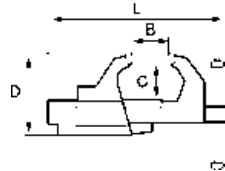

- Heavy duty square guide bench vice
- Manufactured from ductile iron, with similar characteristics to steel
- High impact resistance and durability
- Fitted with swivel base
- Large square anvil
- Added a stop pin at the main screw end to prevent jaw from falling out
- Spare jaws and spindle available
- GS certification

Q	Icon	mm	B mm	C mm	D mm	L mm	g
207-100	1	100	100	61	164	330	11.450
207-125	1	125	125	72	193	408	20.000
207-150	1	150	150	84	223	466	29.700

SPARE PARTS FOR BENCH VICES

SPARE JAWS

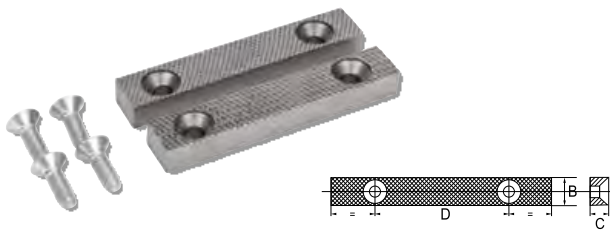

- Pair of spare jaws and screws for round guide vice 201

Q	Icon	mm	B mm	C mm	D mm	g
202401	1	80	15	10	55	170
202411	1	100	20	12	64	350
202421	1	125	20	12	77	450
202431	1	150	25	14	90	750

SPARE JAWS

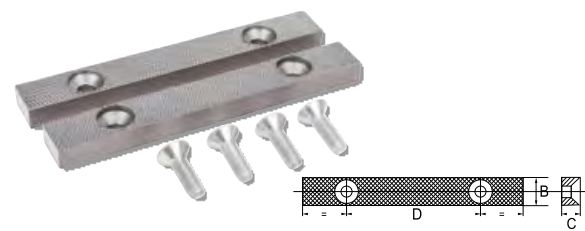

- Pair of spare jaws and screws for square guide vices 207041 / 207071 and 216

Q	Icon	mm	B mm	C mm	D mm	g
202441	1	100	15	10	64	350
202421	1	125	20	12	77	450
202451	1	150	20	12	90	750
202461	1	175	25	14	105	1.020

SPARE JAWS



- Pair of spare jaws and screws for square guide vices 207-100/207-150

Q	Icon	mm	B mm	C mm	D mm	g
202-100	1	100	20	10	60	270
202-125	1	125	21	12	75	460
202-150	1	150	21	12	90	550

PAIR OF PIPE JAWS AND SCREWS



- Pair of pipe jaws and screws for square guide vices 207041 / 207071 and 216

Q	Icon	mm	mm	g
206721	1	100	13.5 - 26.9	245
206741	1	125	21.3 - 76.1	436
206761	1	150 / 175	26.9 - 89.0	478

SPARE PARTS FOR BENCH VICES

SPARE SPINDLE AND BOLT



- Spare spindle and bolt for round guide vice 201

R	Icon	Q	L (mm)	g
202811	1	80	251	875
202821	1	100	317	1.400
202831	1	125	364	2.200
202841	1	150	428	3.400

SPARE SPINDLE AND NUT



- Spare spindle and nut for square guide vice 207041/207071 and 216

R	Icon	Q	L (mm)	g
206821	1	100	287	600
206831	1	125	352	1.400
206841	1	150	432	2.200
206851	1	175	471	3.200

SPARE SPINDLE



- Spare spindle for square guide vices 207-100/207-150

R	Icon	Q	L (mm)	g
206-100	1	100	165	560
206-125	1	125	188	920
206-150	1	150	216	1.060

ACCESSORIES FOR BENCH VICES

ALUMINIUM JAWS

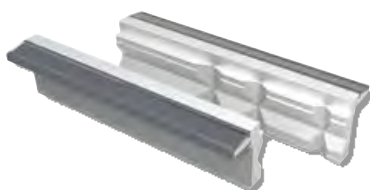

- Prism jaws of hardened aluminium
- Offer efficient clamping and protection of the workpiece at the same time
- Designed for horizontal clamping of flat and round objects
- Designed for vertical clamping of round objects
- 90° recess in the top to hold flat bar stock while marking out or centrepunching
- Horizontal vee-groove with an angle of 120° for clamping of pipes and other round workpieces
- 3 vertical vee-grooves with angles of 100°, 120° and 130° for clamping of pipes and other round workpieces
- Excellent powerful neodymium magnetic strip

R	Icon	Q	g
202561	1	100	180
202571	1	125	200
202581	1	150	220

ALUMINIUM JAWS



- Neutral jaws of hardened aluminium
- For clamping rough or medium finish, machined workpieces
- Impact resistant extruded polycarbonate PC
- Hardened aluminium offers superior corrosion resistance along with excellent surface finish
- Excellent powerful neodymium magnetic strip

R	Icon	Q	g
202511	1	100	180
202521	1	125	200
202541	1	150	220

POLYURETHANE JAWS



- Polyurethane jaws with grooves
- For clamping of round parts with very delicate details
- The jaws are manufactured from the special flexible polyurethane material
- Shore hardness A82
- Polyurethane is known for its unique abilities to "bite onto" the work piece without damaging or scratching it
- Polyurethane is so flexible, that it returns to its original shape after deformation
- Excellent powerful neodymium magnetic strip

Part No.	Box	Length (mm)	Weight (g)
202661	1	100	150
202671	1	125	175
202681	1	150	200

POLYURETHANE JAWS

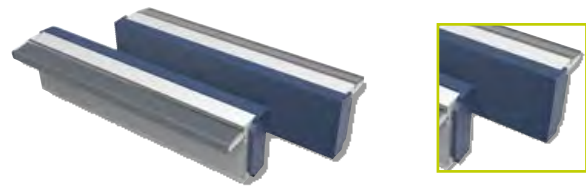

- Polyurethane jaws with small cross serrations
- For clamping of flat parts with very delicate details
- The jaws are manufactured from the special flexible polyurethane material
- Shore hardness A82
- Polyurethane is known for its unique abilities to "bite onto" the work piece without damaging or scratching it
- Polyurethane is so flexible, that it returns to its original shape after deformation
- Excellent powerful neodymium magnetic strip

Part No.	Box	Length (mm)	Weight (g)
202761	1	100	150
202771	1	125	175
202781	1	150	200

SWIVEL VICE BASE



- Swivel base for all round 201 and 207041 / 207071 square guide vice models
- Manufactured from high grade cast steel

Part No.	Box	Ø mm	mm	L mm	d mm	g
201431	1	80	100	90	11	850
201451	1	100	125	115	13	1.150
201461	1	125	150	145	13	1.500
201471	1	150	175	165	17	2.500

TABLE VICE

MINI BENCH VICE

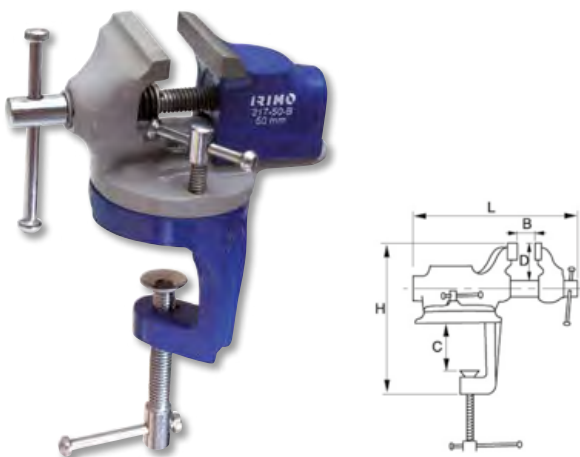

- Versatile tool for filing, flattening or laying out work
- With swivel base
- Finished anvil
- Material: cast iron
- Blister packaging

Part No.	Box	Length (mm)	B mm	C mm	D mm	H mm	L mm	g
217-50-B	1	50	40	34	20	120	125	1.100



SCREW CLAMPS

FORGED WOODEN HANDLE F-CLAMP



- Professional type F clamp with one fixed and one sliding bracket fitted to a galvanised profiled steel rail
- Screwed wooden handle for a comfortable adjusting
- Forged jaws allows a high and maintained clamping force

R		A mm	B mm	HxS mm	g
258-100-2	1	60	100	15.5x7.5	450
258-120-2	1	60	120	15.5x7.5	750
258-160-2	1	80	160	15.5x7.5	900
258-200-2	10	120	200	22x10.6	1.200
258-250-2	10	120	250	22x10.6	1.500
258-300-2	10	120	300	22x10.6	1.586

STEEL CLAMP, 90 MM



R		A mm	B mm	HxS mm	g
256001	5	150	90	30x8	1.100
256011	5	200	90	30x8	1.200
256031	5	300	90	30x8	1.400
256041	5	400	90	30x8	1.600

STEEL T-HANDLE CLAMP, 120 MM

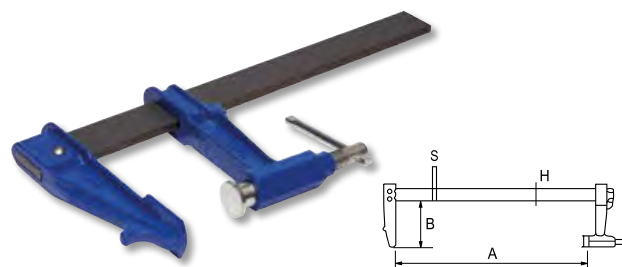

R		A mm	B mm	HxS mm	g
256131	5	300	120	35x8	2.000
256141	5	400	120	35x8	2.200
256151	5	500	120	35x8	2.400
256161	5	600	120	35x8	2.600
256181	5	800	120	35x8	3.000
256201	5	1.000	120	35x8	3.400

NON-SLIP BRAKING MECHANISM CLAMP, 150 MM

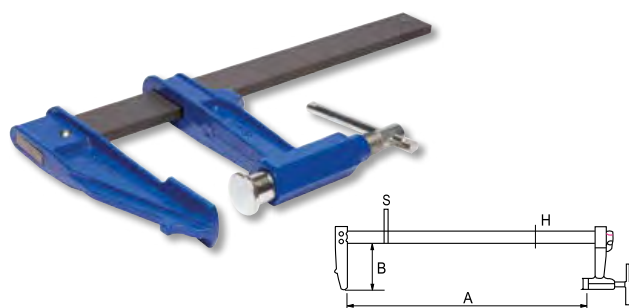

R		A mm	B mm	HxS mm	g
256231	5	300	150	40x10	3.100
256241	5	400	150	40x10	3.400
256251	2	500	150	40x10	3.700
256261	2	600	150	40x10	4.000
256281	2	800	150	40x10	4.600
256301	2	1.000	150	40x10	5.200
256321	1	1.200	150	40x10	5.800

LIGHT SCREW CLAMP, 70 MM

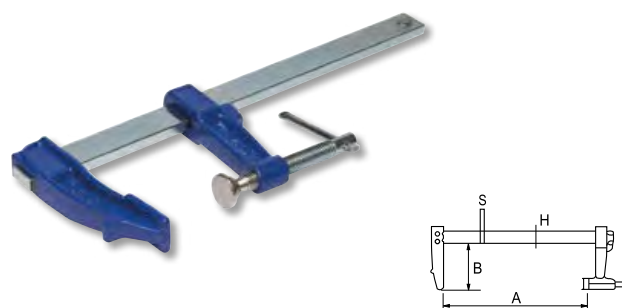

R		A mm	B mm	HxS mm	g
255011	10	120	70	18x7	420
255021	10	150	70	18x7	450
255031	10	200	70	18x7	500
255041	10	250	70	18x7	550
255051	10	300	70	18x7	600

FORGED RATCHETING F-CLAMP

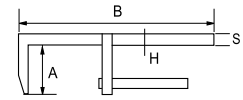

- Professional clamp
- Strong Clamping tool
- Aluminium body
- Up to 5100 Nw
- Ratcheting system to facilitate adjust and clamping

€		B mm	A mm	HxS mm	
257-200-2	10	200	140	25x12	986
257-300-2	10	300	140	25x12	1.586
257-400-2	10	400	140	25x12	2.286
257-500-2	10	500	140	25x12	2.886
257-600-2	10	600	140	25x12	3.286

QUICK CLAMPS

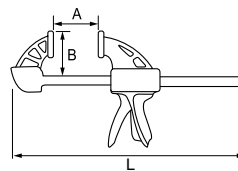

- High resistance clamps with quick release system
- Clamping capacity over 70 kg
- Reversible jaw mechanism



€		A mm	B mm	L mm	
254-150-2	1	150 - 6"	60	335	487
254-300-2	6	300 - 12"	60	485	586
254-450-2	6	450 - 18"	60	635	686
254-600-2	6	600 - 24"	60	785	781
254-900-2	6	900 - 36"	60	1.085	980
254-1200-2	4	1.200 - 48"	60	1.685	1.165

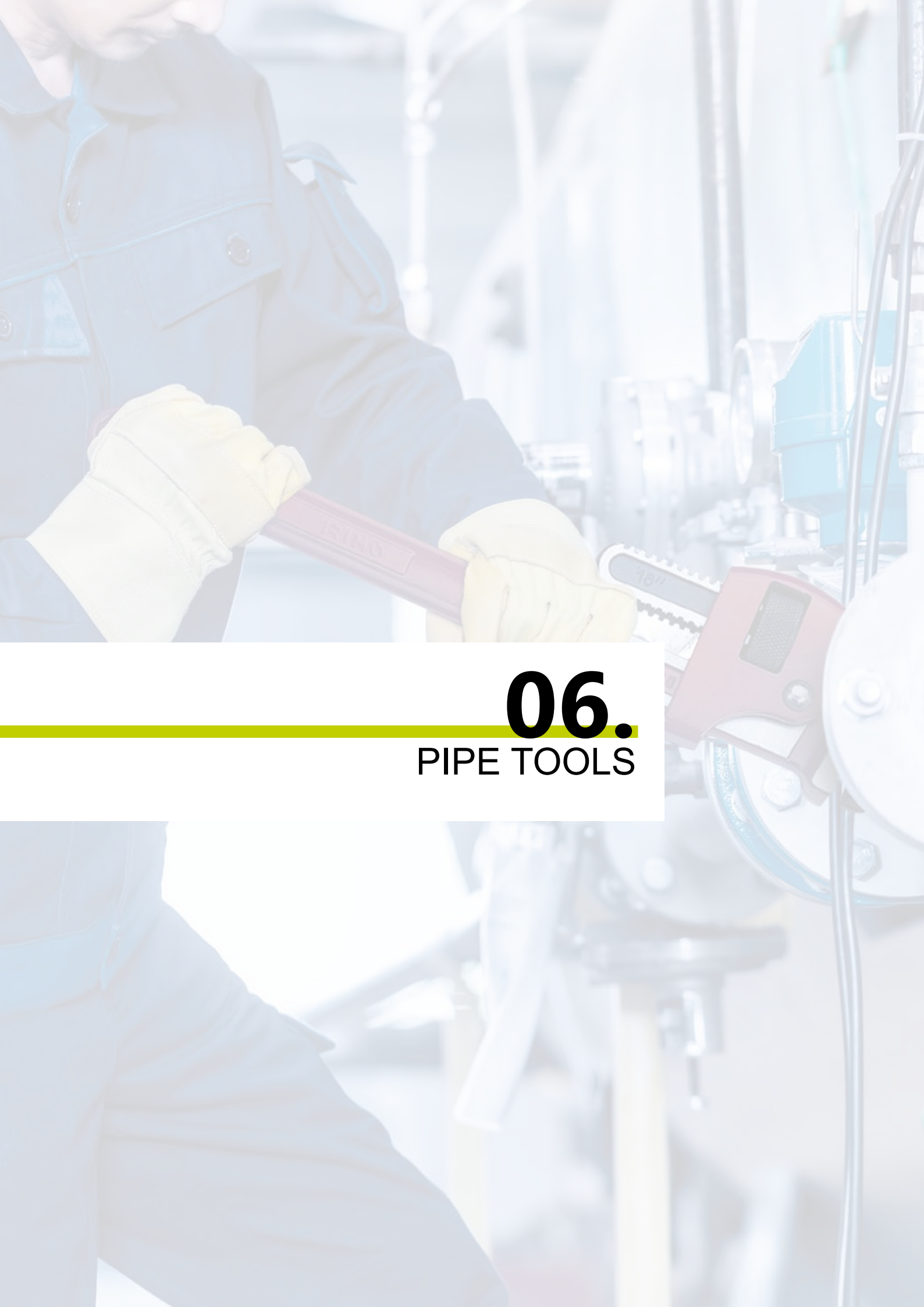

06.

PIPE TOOLS

STILLSON WRENCHES

STILLSON WRENCH

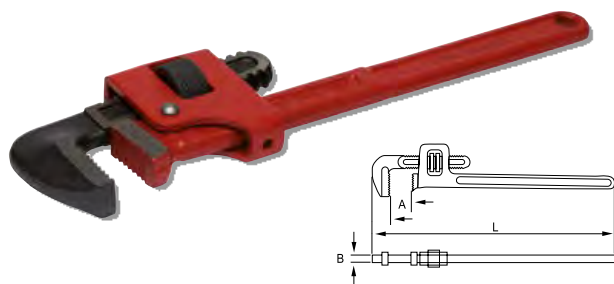

- Forged template steel
- Hardened gripping teeth 55+60 HRc
- Epoxy painting

R	📦	A inch	A mm	B mm	L inch	L mm	g
302-210-2	3	1"	19	11	8"	210	290
302-260-2	3	1.3/8"	25	15	10"	260	620
302-310-2	3	1.3/4"	26	17	12"	310	800
302-365-2	3	2"	28	19	14"	365	1.120
302-465-2	1	2.3/8"	30	23	18"	465	1.890
302-615-2	1	3"	39	26	24"	615	3.200
302-900-2	1	4"	48	30	36"	900	6.100

STILLSON ALUMINIUM WRENCH

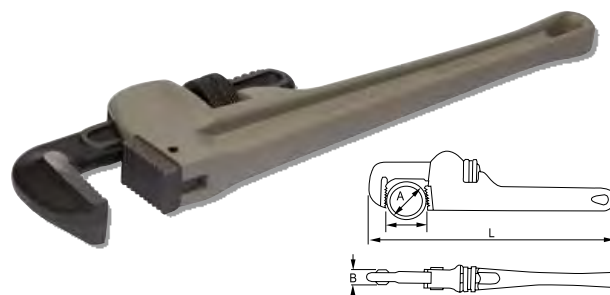

- Aluminium alloy handle with section in double T
- Light, 40% less weight and great resistance

R	📦	A inch	A mm	B mm	L inch	L mm	g
304-250-2	2	1.1/2"	22	17	10"	250	430
304-350-2	2	2"	26	21	14"	350	950
304-450-2	1	2.1/2"	29	26	18"	450	1.650
304-600-2	1	3"	33	28	24"	600	2.500
304-900-2	1	5"	44	32	36"	900	5.200

SPARE PARTS FOR STILLSON WRENCHES



R	R	📦	L inch
302S-210-2	302T-210-2	1	8"
302S-260-2	302T-260-2	1	10"
302S-310-2	302T-310-2	1	12"
302S-365-2	302T-365-2	1	14"
302S-465-2	302T-465-2	1	18"
302S-615-2	302T-615-2	1	24"
302S-900-2	302T-900-2	1	36"

SPARE PARTS FOR STILLSON ALUMINIUM WRENCH



R	R	R	📦	L inch
304S-250-2	304T-250-2	304F-250-2	1	10"
304S-350-2	304T-350-2	304F-350-2	1	14"
304S-450-2	304T-450-2	304F-450-2	1	18"
304S-600-2	304T-600-2	304F-600-2	1	24"
304S-900-2	304T-900-2	304F-900-2	1	36"

CHAIN PIPE WRENCH

CHAIN PIPE WRENCH



- Strong chain made of tempered special steel
- Jaws and body in forged hardened steel
- Double sided tooth system for ratchet-like use
- Self locking function in both directions

E	Icon	S	A mm	B mm	L mm	g
307-350-2	1	1.1/2"	8	38	350	1.400
307-685-2	1	2.1/2"	9	79	685	3.500
307-940-2	1	4"	13	60	940	6.700
307-1122-2	1	6"	20	75	1.122	12.600

SPARE CHAIN



- Material: tempered special steel

E	Icon	Part	Weight (g)
307S-350-2	1	307-350-2	340
307S-685-2	1	307-685-2	475
307S-940-2	1	307-940-2	560
307S-1122-2	1	307-1122-2	830

PIPE WRENCHES SWEDISH MODEL

CORNER MOUTH

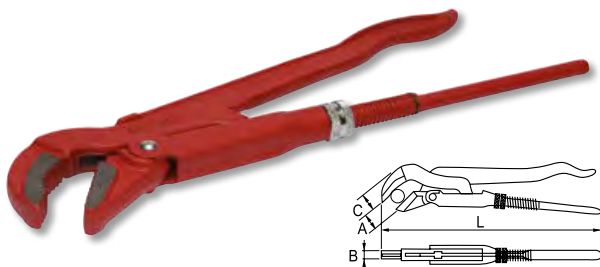

- Forged steel
- Epoxy painting
- Hardened gripping teeth

E	Icon	A inch	A mm	C mm	B mm	L mm	g
303081	1	1/2"	15	20	8	240	665
303111	1	1"	25	25	11	315	1.145
303121	1	1.1/2"	40	27	12	425	1.890
303131	1	2"	50	30	13	550	3.275
303171	1	3"	80	36	17	655	6.425

PERPENDICULAR MOUTH

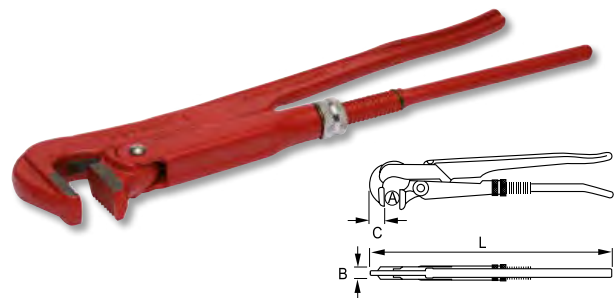

- Forged steel
- Epoxy painting
- Hardened gripping teeth

E	Icon	A inch	A mm	C mm	B mm	L mm	g
303201	1	1"	25	16	18	320	800
303211	1	1.1/2"	40	19	20	425	1.300
303221	1	2"	50	21	25	560	2.300
303231	1	3"	80	22	30	630	2.900
303241	1	4"	117	30	32	735	5.900

CURVED MOUTH

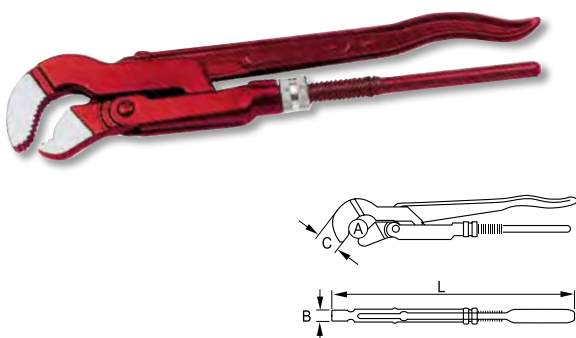

- Forged steel
- Epoxy painting
- Hardened gripping teeth

E	Icon	A inch	A mm	C mm	B mm	L mm	g
303291	1	1/2"	15	13	16	235	400
303301	1	1"	25	17	23	330	800
303311	1	1.1/2"	40	19	27	420	1.400
303321	1	2"	50	21	32	535	2.400
303331	1	3"	80	24	34	648	4.200

PIPE CUTTERS

SMALL COPPER PIPE CUTTER

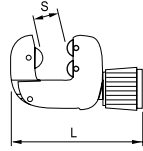

- Enamelled
- Phosphated finish

R	📦	S	Ø mm	L mm	g
321161	2	1/8" - 5/8"	3 - 16	58	122
321171	2	1/8" - 1.1/8"	3 - 30	80	220

MULTIPURPOSE PIPE CUTTER

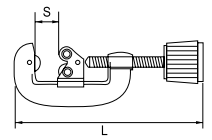

- Enamelled
- Phosphated finish

R	📦	S	Ø mm	L mm	g
321281	1	1/8" - 1.1/8"	3 - 30	30	321

TELESCOPIC COPPER PIPE CUTTER

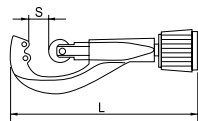

- Enamelled
- Phosphated finish

R	📦	S	Ø mm	L mm	g
321361	1	1/8" - 1.3/8"	3 - 35	160	330

STEEL PIPE CUTTER

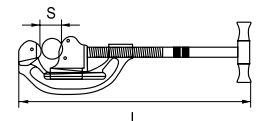

- Enamelled
- Phosphated finish

R	📦	S	Ø mm	L mm	g
321501	1	1/8" - 2"	3 - 50	385	2.520

SPARE WHEELS



R	📦	🔧	D mm	d mm	E mm	g
321511	1	321161/321171/321281/321321/ 321351/321361	20	5	5	5
321551	1	321501	31	9	19	28

AUTO RETRACT PLASTIC TUBE CUTTER



- From 6 to 42 mm
- Used for PVC, CPVC, POLY, PEX & PE tube materials
- Retail packaging

R	📦	L mm	g
321-42-1	12	205	680

SPARE BLADE

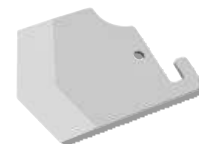

- Spare blade for 312-42-1 Plastic tube cutter
- Retail packaging

R	📦	g
321-BLADE-1	25	58

GASKET CUTTERS

GASKET CUTTERS SET



332-51-4	1	11	140 x 130 x 40	680

333-003-2, 333-004-2, 333-006-2, 333-008-2, 333-010-2, 333-012-2, 333-014-2, 333-016-2, 333-018-2, 333-020-2
332S-030-2



GASKET CUTTERS

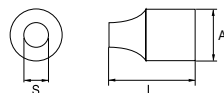

- Interchangeable gasket washer cutters
- Cuts all gasket materials: leather, rubber, cardboard, fibre, asbestos, lead, felt, plastic, etc.
- Triple shapening: inside, outside and cutting edge
- Atmosphere protected tempered alloy steel punches

		S mm		A mm	L mm	
333-003-2	1	3	1/2 x 24 Z"	14	31	15
333-004-2	1	4	1/2 x 24 Z"	14	31	15
333-006-2	1	6	1/2 x 24 Z"	14	31	15
333-008-2	1	8	1/2 x 24 Z"	14	31	15
333-010-2	1	10	1/2 x 24 Z"	14	31	15
333-012-2	1	12	Flat	25	30	30
333-014-2	1	14	Flat	25	30	30
333-016-2	1	16	Flat	25	30	30
333-018-2	1	18	Flat	25	30	30
333-020-2	1	20	Flat	25	30	30
333-022-2	1	22	Flat	35	35	50
333-024-2	1	24	Flat	35	35	50
333-026-2	1	26	Flat	35	35	50
333-028-2	1	28	Flat	35	35	50
333-030-2	1	30	Flat	35	35	50

GASKET CUTTERS SET



332-52-4	1	16	140 x 130 x 40	680

333-003-2, 333-004-2, 333-006-2, 333-008-2, 333-010-2, 333-012-2, 333-014-2, 333-016-2, 333-018-2, 333-020-2, 333-022-2, 333-024-2, 333-026-2, 333-028-2, 333-030-2
332S-030-2



WAD PUNCHES 3 - 30 HANDLE



332S-030-2	1	003-030 mm	350

REVOLVER WAD PUNCHES

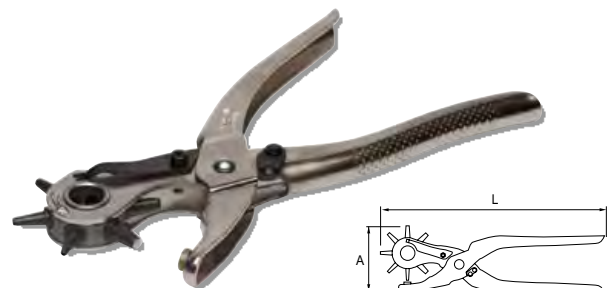

- Rotating wheel for 6 punching sizes in leather, rubber, plastic, canvas, joints and other similar material
- Easy selection and diameter hole vision to avoid errors
- Its exclusive design reduces necessary force in a 70%

		S	∅ mm	L mm	
330021	1	1/8" - 2"	3 - 50	385	2.520





07.

SCREWDRIVERS & BITS

SCREWDRIVERS



**MANUFACTURED
IN EUROPE**

SLOTTED SCREWDRIVERS FOR ENGINEERINGS



- 2-component handle with hanging hole
- Blade is made of high performance alloy steel, CrV. Chrome-plated and entirely hardened. Vapour blasted tip for greater screw-tip adherence and full anti-rust guarantee
- Size and part number are laser branded on the blade for easy identification
- Standard: ISO 2380, DIN 5265, UNE 16516

R	Icon	mm	mm	mm	mm	mm	g	
407-4-75		10	0.8	4	75	90	165	40
407-4-100		10	0.8	4	100	90	190	40
407-5.5-100		10	1	5.5	100	100	200	65
407-5.5-125		10	1	5.5	125	100	225	70
407-6.5-125		10	1.2	6.5	125	110	235	100
407-6.5-150		10	1.2	6.5	150	110	260	105
407-8-150		10	1.6	8	150	110	260	119
407-8-175		10	1.6	8	175	110	285	127
407-10-200		10	1.6	10	200	120	320	175
407-12-250		5	2	12	250	120	370	230
407-14-250		5	2.5	14	250	120	370	260

SLOTTED SCREWDRIVERS FOR ELECTRICIANS



- 2-component handle with hanging hole
- Blade is made of high performance alloy steel, CrV. Chrome-plated and entirely hardened. Vapour blasted tip for greater screw-tip adherence and full anti-rust guarantee
- Size and part number are laser branded on the blade for easy identification
- Standard: ISO 2380, DIN 5265, UNE 16516

R	Icon	mm	mm	mm	mm	mm	mm	g
408-2.5-75		10	0.4	2.5	75	90	165	34
408-3-75		10	0.5	3	75	90	165	35
408-3-100		10	0.5	3	100	90	190	40
408-3-200		5	0.5	3	200	90	290	45
408-3.5-100		10	0.6	3.5	100	90	190	40
408-4-100		10	0.8	4	100	90	190	45
408-4-125		10	0.8	4	125	90	215	45
408-4-250		5	0.8	4	250	90	340	60
408-5.5-125		10	1	5.5	125	100	225	65
408-5.5-150		10	1	5.5	150	100	250	90
408-5.5-300		5	1	5	300	100	400	106
408-6.5-150		10	1.2	6.5	150	110	260	110

STUBBY SLOTTED SCREWDRIVERS



- 2-component handle with hanging hole
- Blade is made of high performance alloy steel, CrV. Chrome-plated and entirely hardened. Vapour blasted tip for greater screw-tip adherence and full anti-rust guarantee
- Standard: ISO 2380, DIN 5265, UNE 16516

R	Icon	mm	mm	mm	mm	mm	g	
408-5.5-25		10	1.2	5.0	25	60	85	35
408-6.5-25		10	1.2	6.0	25	60	85	35

PHILLIPS SCREWDRIVERS



- 2-component handle with hanging hole
- Blade is made of high performance alloy steel, CrV. Chrome-plated and entirely hardened. Vapour blasted tip for greater screw-tip adherence and full anti-rust guarantee
- Size and part number are laser branded on the blade for easy identification
- Standard: ISO 8764, DIN 5262, UNE 16520

Part No.	Quantity	Bit	Blade Length (mm)	Blade Width (mm)	Blade Thickness (mm)	Weight (g)
409-0-75	10	PH-0	75	90	165	35
409-1-100	10	PH-1	100	100	200	65
409-2-125	10	PH-2	125	110	235	100
409-3-150	5	PH-3	150	120	270	160
409-4-200	5	PH-4	200	120	320	200
409-1-250	5	PH-1	250	100	350	89
409-2-300	5	PH-2	300	110	410	130

POZIDRIV SCREWDRIVERS



- 2-component handle with hanging hole
- Blade is made of high performance alloy steel, CrV. Chrome-plated and entirely hardened. Vapour blasted tip for greater screw-tip adherence and full anti-rust guarantee
- Size and part number are laser branded on the blade for easy identification
- Standard: ISO 8764, DIN 5262, UNE 16520

Part No.	Quantity	Bit	Blade Length (mm)	Blade Width (mm)	Blade Thickness (mm)	Weight (g)
413-0-75	5	PZ-0	75	90	165	35
413-1-100	5	PZ-1	100	100	200	75
413-2-125	5	PZ-2	125	110	235	100
413-3-150	5	PZ-3	150	120	270	160
413-4-200	5	PZ-4	200	120	270	205

STUBBY PHILLIPS SCREWDRIVERS



- 2-component handle with hanging hole
- Blade is made of high performance alloy steel, CrV. Chrome-plated and entirely hardened. Vapour blasted tip for greater screw-tip adherence and full anti-rust guarantee
- Standard: ISO 8764, DIN 5262, UNE 16520

Part No.	Quantity	Bit	Blade Length (mm)	Blade Width (mm)	Blade Thickness (mm)	Weight (g)
409-1-25	10	PH-1	25	60	85	35
409-2-25	10	PH-2	25	60	85	35

STUBBY POZIDRIV SCREWDRIVERS



- 2-component handle with hanging hole
- Blade is made of high performance alloy steel, CrV. Chrome-plated and entirely hardened. Vapour blasted tip for greater screw-tip adherence and full anti-rust guarantee
- Standard: ISO 8764, DIN 5262, UNE 16520

Part No.	Quantity	Bit	Blade Length (mm)	Blade Width (mm)	Blade Thickness (mm)	Weight (g)
413-1-25	10	PZ-1	25	60	85	35
413-2-25	10	PZ-2	25	60	85	35



EAN CODE LASER MARKED

POLYPROPYLENE & ELASTOMER COMBINATION FOR PERFECT GRIP

STRIPES ON THE ELASTOMER AVOID ROLLING OUT



PRODUCT CODE FOR EASY IDENTIFICATION



SCREWDRIVERS

TORX® SCREWDRIVERS



- 2-component handle with hanging hole
- Blade is made of high performance alloy steel, CrV. Chrome-plated and entirely hardened. Black finish tip for higher accuracy
- Size and part number are laser branded on the blade for easy identification

Part No.	Box	Bit	Tip	Blade	Shaft	Handle	Weight
414-5-75	10	T-5	2.5	75	90	165	32
414-6-75	10	T-6	3	75	90	165	35
414-7-75	10	T-7	3	75	90	165	35
414-8-75	10	T-8	3	75	90	165	35
414-9-75	10	T-9	3	75	90	165	35
414-10-75	10	T-10	3	75	90	165	35
414-15-100	10	T-15	3.5	100	90	190	45
414-20-100	10	T-20	4	100	90	190	45
414-25-125	10	T-25	5	125	100	225	70
414-27-125	10	T-27	5.5	125	100	225	70
414-30-150	10	T-30	6	150	110	260	105
414-40-150	5	T-40	7	150	110	260	120
414-45-150	5	T-45	7	150	110	260	120

NUT DRIVER WITH HANDLE 1/4"



- 2-component handle with hanging hole
- Blade is made of high performance alloy steel, CrV. Chrome-plated and entirely hardened
- Size and part number are laser branded on the blade for easy identification
- Standard: ISO 691, DIN 3125, UNE 16502

Part No.	Box	Bit	Tip	Blade	Shaft	Handle	Weight
417-3.2-125	5	3.2	5.7	125	90	215	60
417-4-125	5	4	6.9	125	90	215	60
417-4.5-125	5	4.5	7.5	125	90	215	60
417-5-125	5	5	8.2	125	100	250	70
417-5.5-125	5	5.5	8.8	125	100	250	70
417-6-125	5	6	9.4	125	100	250	70
417-7-125	5	7	11.0	125	110	260	120
417-8-125	5	8	12.2	125	110	260	120
417-9-125	5	9	13.5	125	110	260	120
417-10-125	5	10	14.7	125	110	260	120
417-11-125	5	11	16.0	125	120	270	155
417-12-125	5	12	17.2	125	120	270	155
417-13-125	5	13	18.5	125	120	270	155
417-14-125	5	14	19.7	125	120	270	155

MAGNETIC BIT HOLDER FOR 1/4" BITS



- 2-component handle with hanging hole
- Blade is made of high performance alloy steel, CrV
- Strong magnet
- Size and part number are laser branded on the blade for easy identification

Part No.	Box	Bit	Blade	Handle	Weight
475-1/4-125	5	1/4"	125	235	112

NUT DRIVER WITH HANDLE, WITH FLEXIBLE BLADE 1/4"



- 2-component handle with hanging hole
- Blade is made of high performance alloy steel, CrV
- Flexible blade

E	Box	mm	mm	mm	g
190-6-135	1	6	135	260	125
190-7-135	1	7	135	270	125
190-8-135	1	8	135	270	125

RATCHETING BIT HOLDER FOR 1/4" BITS

RATCHETING BIT HOLDER SCREWDRIVER FOR 1/4" BITS



- Handle: 2-component handle
- Interchangeable bit storage compartment with release button for quick access
- Slide tray that keeps 12 different bits:
Slotted 4, 5, 6 mm; PH 1, 2, 3; TORX® 15, 20, 25; Hex 3, 4, 5 mm
- Magnetic blade secures bit in screwdriver
- Smooth ratcheting stroke
- Three position ratchet mechanism: forward, reverse and neutral

E	Box	mm	mm	mm	g	
475R-1/4-110	6	1/4"	110	125	235	310

RATCHETING BIT HOLDER STUBBY FOR 1/4" BITS



- Ratcheting bit holder stubby for 1/4" bits
- Handle: 2-component handle
- Interchangeable bit storage
- 6 double ended bits:
Slotted 5.0, 6.0; PH1, PH2; T15, T20, T25, T30; Hex 2.5, 3, 4, 5 mm
- Magnetic blade secures bit in screwdriver
- Smooth ratcheting stroke, three position ratchet mechanism
- Presented in a blister packaging

E	Box	mm	mm	mm	g	
475R-1/4-30	6	1/4"	30	80	110	192

INSULATED SCREWDRIVER, 1000V



SLOTTED INSULATED 1000V SCREWDRIVERS

IEC 60900



- For work on live equipment, up to 1000V
- 2-component handle with hanging hole
- Blade is made of high performance alloy steel, insulation moulded directly onto blade. Black finish tip for higher accuracy
- Size and part number are laser branded on the blade for easy identification
- Standard: ISO 2380

Part No.	Blade Width (mm)	Blade Thickness (mm)	Blade Length (mm)	Blade Width at Tip (mm)	Blade Length at Tip (mm)	Blade Length (mm)	Blade Length (mm)
408V-2.5-100	10	0.4	2.5	100	90	165	20
408V-3-100	10	0.5	3	100	90	190	22
408V-3.5-100	10	0.6	3.5	100	90	190	32
408V-4-100	10	0.8	4	100	90	190	35
408V-5.5-125	10	1	5.5	125	100	225	65
408V-6.5-150	10	1.2	6.5	150	110	260	90
408V-8-175	5	1.2	8	175	120	295	110

PHILLIPS INSULATED 1000V SCREWDRIVERS

IEC 60900

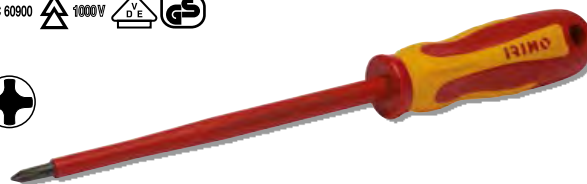

- For work on live equipment, up to 1000V
- 2-component handle with hanging hole
- Blade is made of high performance alloy steel, insulation moulded directly onto blade. Black finish tip for higher accuracy
- Size and part number are laser branded on the blade for easy identification
- Standard: ISO 8764

Part No.	Blade Width (mm)	Blade Thickness (mm)	Blade Length (mm)	Blade Width at Tip (mm)	Blade Length (mm)	Blade Length (mm)	Blade Length (mm)
409V-0-100	10	PH-0	100	90	190	40	
409V-1-150	10	PH-1	150	100	260	80	
409V-2-175	10	PH-2	175	110	285	120	
409V-3-200	5	PH-3	200	120	320	180	

POZIDRIV INSULATED 1000V SCREWDRIVERS

IEC 60900



- For work on live equipment, up to 1000V
- 2-component handle with hanging hole
- Blade is made of high performance alloy steel, insulation moulded directly onto blade. Black finish tip for higher accuracy
- Size and part number are laser branded on the blade for easy identification
- Standard: ISO 8764

Part No.	Qty	Tip	Blade Length (mm)	Blade Width (mm)	Total Length (mm)	Weight (g)
413V-0-100	10	PZ-0	100	90	190	40
413V-1-150	10	PZ-1	150	100	260	80
413V-2-175	10	PZ-2	175	110	285	120
413V-3-200	5	PZ-3	200	120	320	180

TORX® INSULATED 1000V SCREWDRIVERS

IEC 60900



- For work on live equipment, up to 1000V
- 2-component handle with hanging hole
- Blade is made of high performance alloy steel, insulation moulded directly onto blade. Black finish tip for higher accuracy
- Size and part number are laser branded on the blade for easy identification
- Standard: ISO 8764

Part No.	Qty	Tip	Blade Length (mm)	Blade Width (mm)	Total Length (mm)	Weight (g)
414V-10-100	10	T-10	100	90	190	320
414V-15-125	10	T-15	125	100	225	650
414V-20-125	10	T-20	125	100	225	750
414V-25-150	10	T-25	150	110	360	900

TWIN PACK INSULATED SCREWDRIVERS + TESTER

IEC 60900



- Screwdriver set, 3 pcs
- Includes 2 screwdrivers and 1 main tester 150V-250V
- For slotted and Phillips head screws

Part No.	Qty	Tip	Blade Length (mm)	Weight (g)
459V-3-1	1	3	35 x 130 x 310	35
408V-4-100				
409V-1-150				
429-03-1				

INSULATED 1000V SCREWDRIVER SET, 6 pieces

IEC 60900

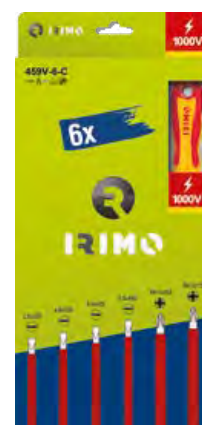

- Screwdriver set of 6 pieces
- For slotted and Phillips head screws
- In cardboard box

Part No.	Qty	Tip	Blade Length (mm)	Weight (g)
459V-6-C	1	6	42 x 325 x 160	580
408V-2.5-100, 408V-4-100, 408V-5.5-125, 408V-6.5-150				
409V-1-150, 409V-2-175				

SCREWDRIVER SETS

SCREWDRIVER SET, 6 pieces

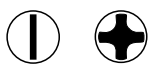

- For slotted and Phillips head screws
- In cardboard box

459-6-C	1	6	42x325x160	570

408-3-75, 408-4-100		
407-5.5-125, 407-6.5-150		
409-1-100, 409-2-125		

SCREWDRIVER SET FOR ENGINEERINGS, 6 pieces

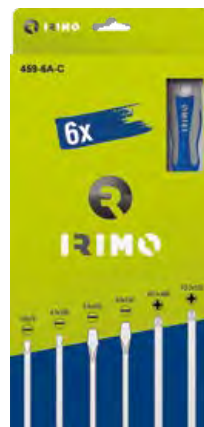
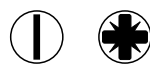

- For slotted and Pozidriv head screws
- In cardboard box

459-6A-C	1	6	42x325x160	570

408-3-75, 408-4-100		
407-5.5-125, 407-6.5-150		
413-1-100, 413-2-125		

SCREWDRIVER SET, 5 pieces

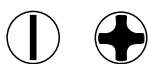

- For slotted and Phillips head screws
- In clamshell packaging

459-5-B	1	5	48x190x335	435

408-3-75, 408-4-100		
407-6.5-150		
409-1-100, 409-2-125		

SCREWDRIVER SET, 6 pieces



- For TORX® head screws
- In cardboard box

459-6B-C	1	6	42x325x160	470

414-10-75, 414-15-100, 414-20-100, 414-25-125, 414-27-125, 414-30-150		
---	--	--

SCREWDRIVER SET FOR ELECTRICIANS, 6 pieces

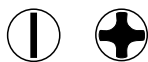

- For slotted and Phillips head screws
- In cardboard box

IRIMO	Box	Box X	Box Y	Weight
459-6C-C	1	6	42 x 325 x 160	505
408-3-100, 408-4-125, 408-5.5-150				①
409-1-100, 409-2-125				⊕
429-03-1				①

T-HANDLE SCREWDRIVERS



T-HANDLE WITH HEXAGONAL TIP

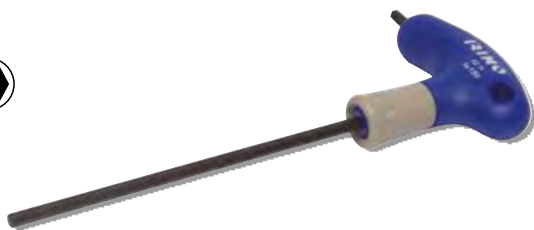

- Blade is made of high quality steel. Black finish
- The long blade allows to apply a controlled torque and provides an easy access to screws requiring depth
- The short 90° blade is used for extreme torque or to work in areas where height is limited
- Size and part number are laser branded on the blade for easy identification
- Rotating cap in the handle that allows a fast finger movement during turning reducing tightening time

IRIMO	Box	Hex Tip	Blade Length	Blade Width	Blade Height	Weight
42-H2-100	5	2	130	100	64x30	23
42-H2.5-100	5	2.5	130	100	64x30	25
42-H3-100	5	3	130	100	64x30	28
42-H4-150	5	4	190	150	80x40	57
42-H5-150	5	5	190	150	80x40	70
42-H6-200	5	6	250	200	100x50	134
42-H8-200	5	8	250	200	100x50	186
42-H10-200	5	10	250	200	100x50	254



T-HANDLE SCREWDRIVERS

T-HANDLE WITH TORX® TIP



- Blade is made of high quality steel. Black finish
- The long blade allows to apply a controlled torque and provides an easy access to screws requiring depth
- The short 90° blade is used for extreme torque or to work in areas where height is limited
- Size and part number are laser branded on the blade for easy identification
- Rotating cap in the handle that allows a fast finger movement during turning reducing tightening time

Part No.	Pcs	Tip	Blade Length (mm)	Blade Width (mm)	Blade Height (mm)	Weight (g)	
46-T10-100	5	T10	2.72	130	100	64 x 30	27
46-T15-150	5	T15	3.26	190	150	80 x 40	55
46-T20-150	5	T20	3.84	190	150	80 x 40	55
46-T25-150	5	T25	4.40	190	150	80 x 40	66
46-T30-200	5	T30	5.49	250	200	100 x 50	126
46-T40-200	5	T40	6.60	250	200	100 x 50	147

T-HANDLE SCREWDRIVERS, NUT DRIVER



- Blade is made of high quality steel
- Size and part number are laser branded on the blade for easy identification
- Rotating cap in the handle that allows a fast finger movement during turning reducing tightening time

Part No.	Pcs	Tip	Blade Length (mm)	Blade Width (mm)	Blade Height (mm)	Weight (g)
191-6-150	5	6	190	150	69 x 40	78
191-7-175	5	7	225	175	84 x 50	121
191-8-175	5	8	225	175	84 x 50	123
191-10-175	5	10	225	175	84 x 50	160
191-12-175	5	12	225	175	84 x 50	167
191-13-175	5	13	225	175	84 x 50	172

T-HANDLE WITH HEXAGONAL BALL TIP



- Blade: high quality steel. Black finish
- The long blade allows to apply a controlled torque and provides an easy access to screws requiring depth
- The short 90° blade is used for extreme torque or to work in areas where height is limited
- Ball end allows to easily insert the tip in the screw head from a range of angles
- More efficient and time saving than a standard T Handle
- Branding: size and part number laser branded in the blade for easier identification

Part No.	Pcs	Tip	Blade Length (mm)	Blade Width (mm)	Blade Height (mm)	Weight (g)
42B-H3-100	5	3	130	100	64 x 30	28
42B-H4-150	5	4	190	150	80 x 40	57
42B-H5-150	5	5	190	150	80 x 40	70
42B-H6-200	5	6	250	200	100 x 50	134
42B-H8-200	5	8	250	200	100 x 50	186
42B-H10-200	5	10	250	200	100 x 50	254

HEX BALL END T HANDLE SET, 6 pieces

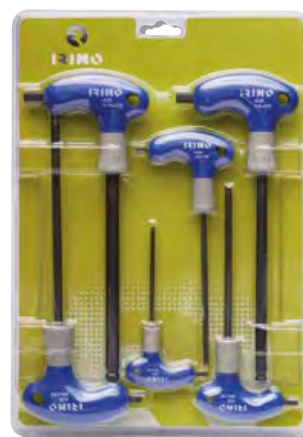

- T-handle hexagonal ball tip, 6 pcs
- In clamshell packaging

Part No.	Pcs	Tip	Blade Length (mm)	Blade Width (mm)	Blade Height (mm)	Weight (g)
42B-6-B	1	6	355 x 247 x 40			120

42B-H10-200, 42B-H3-100, 42B-H4-150, 42B-H5-150, 42B-H6-200, 42B-H8-200

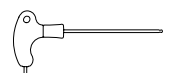

6 IN 1 SCREWDRIVER



- Double ended bits (6.35 x 65 mm): PH1 - 5 mm
- Double ended bits (8 x 75 mm): PH2 - 6 mm
- Nut Driver: 6 mm - 8 mm

475-5-1	1	1/4" / 5/16"	50	110	160	312

REVERSIBLE SCREWDRIVER



- Impact resistant plastic handle
- Blade is made of high performance alloy steel. Nickel plated blade

427411	10	1.2	6	PH-2	156	26

MAGNETISER



- For magnetizing and demagnetizing different tools
- Simple and easy to use small devise
- Material: magnet, plastic
- Packaging: in blister pack

458-02-1	5	53x50x30	164

- 1
- 2
- 3
- 4
- 5
- 6
- 7
- 8
- 9
- 10
- 11
- 12

PRECISION SCREWDRIVER

PRECISION SCREWDRIVER SET, 6 pieces



↓
OPEN
CLOSE
↑

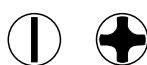

- Precision screwdriver set, 6 pcs
- Chrome Vanadium steel blades
- Chrome plated finish and black tips
- Free turning caps for easy and accurate driving
- Sliding system of the plastic frame to open and release
- Sizes included:
 - 4 slotted: 1.6-2.0-2.5-3.0 mm
 - 2 Phillips: PH00-PH0

461-6-B	1	150	50	120

POCKET PRECISION SCREWDRIVER



478-4-1



478-4-2



- 4 ends tips: PH0 / 3 mm and PH1/4 mm
- Satin finish, head treated bits
- Easy carrying pen size with clip

478-4-1	1	PH0/PH1	120	3.0/4.0	20
478-4-2	48	PH0/PH1	120	3.0/4.0	1.100

VOLTAGE TESTER



429-03-1
429-04-1



429-10-1

- Handle: clear transparent plastic handle, impact resistant
- Blade: high quality steel, nickel plated blade, plastic protection up to the tip
- According to DIN VDE0680/6 GS-marked
- 429-10-1: Auto tester 6-24-V

429-03-1	6	0.6	3.0	65	75	140	30
429-04-1	6	-	3.5	100	90	190	29
429-10-1	6	-	3.0	45	75	120	22

NICKEL PLATED KEYS FOR HEX SCREWS

NICKEL PLATED KEYS, METRIC



- High quality steel, entirely hardened
- Nickel plated
- Size stamped on the blade for easy identification
- Standard: ISO 2936

Code	Quantity	Hex Size (mm)	a (mm)	b (mm)	Weight (g)
040001	10	1.5	15	47	1
040011	10	2.0	18	52	1
040021	10	2.5	21	59	3
040031	10	3.0	23	66	4
040041	10	4.0	29	74	10
040051	10	5.0	33	85	18
040061	10	6.0	38	96	29
040071	10	7.0	41	102	41
040081	10	8.0	44	108	57
040091	5	9.0	47	114	76
040101	5	10.0	50	122	100
040121	5	12.0	57	137	163
040141	1	14.0	70	154	253
040171	1	17.0	80	177	427
040191	1	19.0	89	199	600
040221	1	22.0	102	222	910

NICKEL PLATED KEYS, INCHES



- High quality steel, entirely hardened
- Nickel plated
- Size stamped on the blade for easy identification
- Standard: ISO 2936

Code	Quantity	Hex Size (inch)	a (mm)	b (mm)	Weight (g)
040541	10	1/16"	15	47	1
040011	10	5/64"	18	52	1
040561	10	3/32"	21	59	3
040581	10	1/8"	23	66	4
040041	10	5/32"	29	74	10
040601	10	3/16"	33	85	18
040611	10	7/32"	35.5	91	29
040621	10	1/4"	38	96	32
040641	10	5/16"	44	108	60
040661	5	3/8"	50	122	100
040681	5	7/16"	53	129	140
040701	5	1/2"	63	145	182
040731	1	5/8"	76	168	370
040191	1	3/4"	89	199	601

NICKEL PLATED KEYS SETS, METRIC



- In plastic wallet
- Sizes marked at the top of the wallet, for an easy identification
- Hanging hole

Code	Quantity	Hex Size (mm)	Weight (g)
041011	1	2.0, 2.5, 3.0, 4.0, 5.0, 6.0 mm	76
041071	1	2.0, 2.5, 3.0, 4.0, 5.0, 6.0, 7.0, 8.0 mm	180
041021	1	2.0, 2.5, 3.0, 4.0, 5.0, 6.0, 7.0, 8.0, 10, 12 mm	380
041091	1	2.0, 2.5, 3.0, 4.0, 5.0, 6.0, 7.0, 8.0, 9.0, 10, 12 mm	570
041031	1	2.0, 2.5, 3.0, 4.0, 5.0, 6.0, 7.0, 8.0, 10, 12, 14, 17, 19 mm	1.800
041101	1	2.0, 2.5, 3.0, 4.0, 5.0, 6.0, 7.0, 8.0, 9.0, 10, 12, 14, 17, 19, 22 mm	2.920

NICKEL PLATED KEYS SETS, INCHES



- In plastic wallet
- Sizes marked at the top of the wallet, for an easy identification
- Hanging hole

Code	Quantity	Hex Size (inch)	Weight (g)
041041	1	1/8, 5/32, 3/16, 7/32, 1/4"	95
041051	1	1/8, 5/32, 3/16, 7/32, 1/4, 5/16, 3/8, 7/16, 1/2"	580
041061	1	1/8, 5/32, 3/16, 7/32, 1/4, 5/16, 3/8, 7/16, 1/2, 9/16, 5/8, 3/4"	1.865

NICKEL PLATED KEYS FOR HEX SCREWS

OFFSET SCREWDRIVER SET, 3 pieces



- 3 pieces with double tips (Slotted & Phillips)
- Chrome plated keys set for hex screws, in metric
- Content: Slotted (5.0, 6.0, 8.0 mm); Phillips (PH1, PH2, PH3)
- Packaging: in blister pack

420-3-1	1	3	20x230x100	202

CHROME PLATED KEYS FOR HEX SCREWS, LONG

CHROME PLATED BLADE SET FOR HEX SCREWS, LONG BALL END METRIC



- Set of long ball end hex keys, 9 pieces, metric
- In plastic holder with hanging hole
- Sizes marked at the top of the lid, for an easy identification
- In blister packaging

48-9C-H	1	9	1.5-2-2.5-3-4-5-6-8-10 mm	360

BLACK KEYS FOR HEX SCREWS

BLACK KEYS, METRIC



- High quality steel, entirely hardened
- Black finish
- Size stamped on the blade for easy identification
- Standard: ISO 2936

			a mm	b mm	
045001	10	1.5	15	47	1
045011	10	2.0	18	52	2
045021	10	2.5	21	59	3
045031	10	3.0	23	66	4
045041	10	4.0	29	74	10
045051	10	5.0	33	85	13
045061	10	6.0	38	95	29
045071	10	7.0	41	102	41
045081	10	8.0	44	105	57
045091	5	9.0	47	114	76
045101	5	10.0	50	122	100
045121	5	12.0	57	137	163
045141	1	14.0	70	154	253
045171	1	17.0	80	177	427
045191	1	19.0	89	199	600
045221	1	22.0	102	222	910

BLACK KEYS FOR HEX SCREWS

BLACK KEYS, METRIC

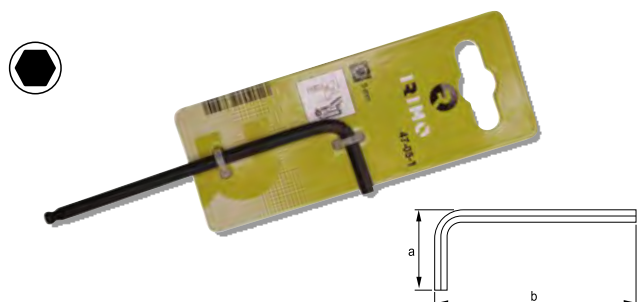

- High quality steel, entirely hardened
- Black finish
- Size stamped on the blade for easy identification
- Standard: ISO 2936

Code	Quantity	Hex Size (mm)	a (mm)	b (mm)	Weight (g)
45-00-1	1	1.5	14.5	45.5	5.4
45-01-1	1	2.0	27.0	51.0	6.4
45-02-1	1	2.5	19.5	55.5	7.5
45-03-1	1	3.0	22.0	64.0	9.4
45-04-1	1	4.0	28.0	72.0	14.4
45-05-1	1	5.0	22.0	83.0	22.4
45-06-1	1	6.0	38.0	94.0	33.8
45-08-1	1	7.0	37.0	105.0	63.8
45-10-1	1	10.0	49.0	119.0	107.3

BLACK KEYS SETS, METRIC



- In plastic wallet
- Sizes marked at the top of the wallet, for an easy identification
- Hanging hole

Code	Quantity	Hex Size (mm)	Set Sizes (mm)	Weight (g)
046011	1	6	2.0, 2.5, 3.0, 4.0, 5.0, 6.0 mm	76
046021	1	10	2.0, 2.5, 3.0, 4.0, 5.0, 6.0, 7.0, 8.0, 10, 12 mm	180
046091	1	11	2.0, 2.5, 3.0, 4.0, 5.0, 6.0, 7.0, 8.0, 9.0, 10, 12 mm	460
046031	1	13	2.0, 2.5, 3.0, 4.0, 5.0, 6.0, 7.0, 8.0, 10, 12, 17, 19 mm	1.805
046101	1	15	2.0, 2.5, 3.0, 4.0, 5.0, 6.0, 7.0, 8.0, 9.0, 10, 12, 14, 17, 19, 22 mm	2.830

BLACK KEYS SETS, METRIC



- Set of black finish hex keys, 9 pieces, metric
- In plastic holder with hanging hole
- Sizes marked at the top of the wallet, for an easy identification
- In blister packaging

Code	Quantity	Hex Size (mm)	Set Sizes (mm)	Weight (g)
46-9-H	1	9	1.5, 2, 2.5, 3, 4, 5, 6, 8, 10 mm	270

BLACK KEYS SETS, METRIC



- Set of black finish hex keys, 8 pieces, metric
- In high quality impact resistant folder
- Allows many different working positions
- Positive stop at 270° degrees, for maximum leverage
- Easy to store
- Retail packaging with hanger

Code	Quantity	Hex Size (mm)	Set Sizes (mm)	Weight (g)
46-8-F	1	8	1.5, 2.0, 2.5, 3.0, 4.0, 5.0, 6.0, 8.0 mm	160

BLACK KEYS FOR HEX SCREWS

BLACK KEYS, INCHES



- High quality steel, entirely hardened
- Black finish
- Size stamped on the blade for easy identification
- Standard: ISO 2936

Part No.	Box Qty	Hex Size	a mm	b mm	Box Qty
045541	10	1/16"	15	47	1
045011	10	5/64"	18	52	2
045561	10	3/32"	21	59	3
045581	10	1/8"	23	66	5
045041	10	5/32"	29	74	10
045601	10	3/16"	33	85	16
045611	10	7/32"	35.5	91	24
045621	10	1/4"	38	96	32
045641	10	5/16"	44	105	60
045661	5	3/8"	50	122	100
045681	5	7/16"	53	129	140
045701	5	1/2"	63	145	182
045731	1	5/8"	76	168	370
045191	1	3/4"	89	199	601

BLACK KEYS SETS, INCHES



- In plastic wallet
- Sizes marked at the top of the wallet, for an easy identification
- Hanging hole

Part No.	Box Qty	Box Qty	Hex Sizes	Box Qty
046041	1	5	1/8, 5/32, 3/16, 7/32, 1/4"	95
046051	1	9	1/8, 5/32, 3/16, 7/32, 1/4, 5/16, 3/8, 7/16, 1/2"	580
046061	1	12	3/32, 1/8, 5/32, 3/16, 7/32, 1/4, 5/16, 3/8, 7/16, 1/2, 5/8, 3/4"	1.865

BLACK KEYS FOR HEX SCREWS, LONG

BLACK KEYS, METRIC LONG

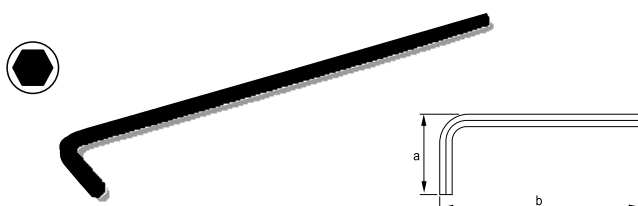

- High quality steel, entirely hardened
- Black finish
- Size laser marking on the blade for an easy identification
- Long arm provides higher torque transmission and accessibility
- Standard: ISO 2936

Part No.	Box Qty	Hex Size	a mm	b mm	Box Qty
045801	10	1.5	15	91	1
045811	10	2.0	18	102	3
045821	10	2.5	21	114	5
045831	10	3.0	23	129	8
045841	10	4.0	29	144	17
045851	10	5.0	33	165	31
045861	10	6.0	38	186	51
045871	10	7.0	41	197	64
045881	5	8.0	44	208	100
045891	5	9.0	47	219	134
045901	5	10.0	50	234	175
045921	2	12.0	57	262	283
045941	2	14.0	70	294	439

LONG BALL END, METRIC

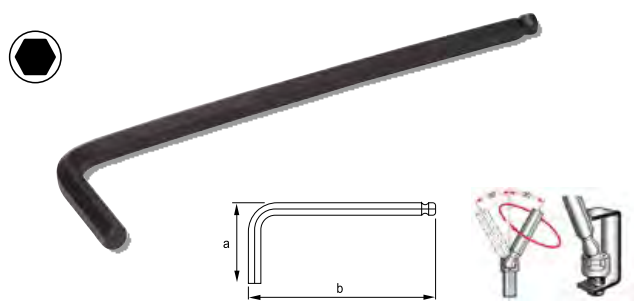

- High quality steel, entirely hardened. Black finish
- Size laser marking on the blade for an easy identification
- Long arm provides higher torque transmission and accessibility
- Ball end allows to easily insert the key in the screw head from a range of angles
- More efficient and time saving than a standard hex key
- Standard: ISO 2936

E	Icon	mm	a mm	b mm	g
047001	10	1.5	15	91	1
047011	10	2.0	18	102	3
047021	10	2.5	21	114	5
047031	10	3.0	23	129	8
047041	10	4.0	29	144	17
047051	10	5.0	33	165	31
047061	10	6.0	38	186	50
047081	10	8.0	44	208	100
047101	5	10.0	50	234	171
047121	2	12.0	57	262	275

LONG BALL END, METRIC

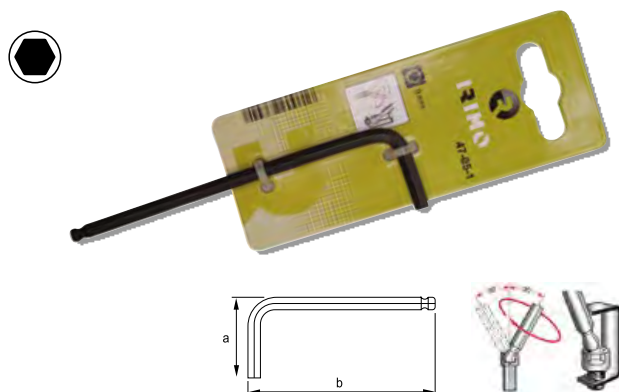

- High quality steel, entirely hardened. Black finish
- Size laser marking on the blade for an easy identification
- Long arm provides higher torque transmission and accessibility
- Ball end allows to easily insert the key in the screw head from a range of angles
- More efficient and time saving than a standard hex key
- Standard: ISO 2936

E	Icon	mm	a mm	b mm	g
47-00-1	1	1.5	14.5	62.5	6.0
47-01-1	1	2.0	17.0	76.0	7.2
47-02-1	1	2.5	19.5	85.5	8.8
47-03-1	1	3.0	22.0	91.0	11.0
47-04-1	1	4.0	28.0	102.0	17.6
47-05-1	1	5.0	32.0	118.0	28.0
47-06-1	1	6.0	37.0	139.0	44.4
47-08-1	1	8.0	43.0	155.0	82.6
47-10-1	1	10.0	49.0	177.0	144.0

LONG BALL END, METRIC



- Set of long ball end hex keys, 9 pieces, metric
- In plastic holder with hanging hole
- Sizes marked at the top of the lid, for an easy identification
- In blister packaging

E	Icon	Icon	Icon	g
48-9-H	1	9	1.5, 2, 2.5, 3, 4, 5, 6, 8, 10 mm	360

LONG BALL END, INCHES



- Set of long ball end hex keys, 13 pieces
- In plastic holder with hanging hole
- Sizes marked at the top of the lid, for an easy identification
- In blister packaging

E	Icon	Icon	Icon	g
48A-13-H	1	9	0.05-1/16-5/64-3/32-7/64-1/8-9/64-5/32-3/16-7/32-1/4-5/16-3/8"	360



BLACK KEYS FOR TORX® SCREWS

BLACK KEYS FOR TORX® SCREWS

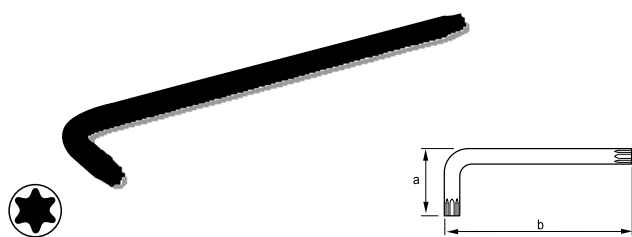

- High quality steel, entirely hardened
- Black finish
- Size laser marking on the blade for an easy identification
- Long arm provides higher torque transmission and accessibility

Part No.	Packaging	Head	a mm	b mm	g
457061	5	T-6	15	75	4
457071	5	T-7	16	80	4
457081	5	T-8	16	80	5
457091	5	T-9	16	80	5
457101	5	T-10	17	86	6
457151	5	T-15	18	90	10
457201	5	T-20	19	95	11
457251	5	T-25	20	100	17
457271	5	T-27	21	105	19
457301	5	T-30	24	114	29
457401	5	T-40	26	124	43
457451	5	T-45	29	133	61
457501	5	T-50	32	152	88

BLACK KEYS FOR TORX® SCREWS

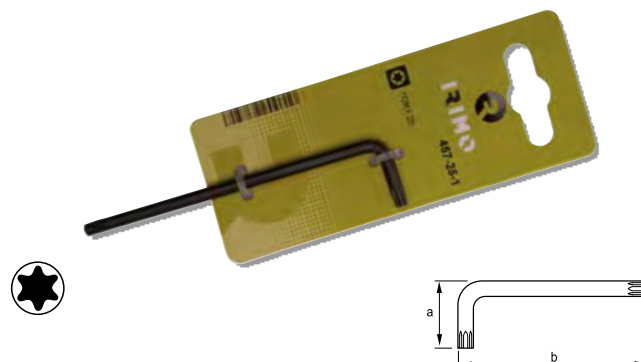

- High quality steel, entirely hardened
- Black finish
- Size laser marking on the blade for an easy identification
- Long arm provides higher torque transmission and accessibility

Part No.	Packaging	Head	a mm	b mm	g
457-10-1	1	T10	17	86	10.0
457-15-1	1	T15	18	90	12.2
457-20-1	1	T20	19	95	15.2
457-25-1	1	T20	20	100	18.8
457-27-1	1	T27	21	105	23.2
457-30-1	1	T30	24	114	28.0
457-40-1	1	T40	26	124	48.2
457-45-1	1	T45	29	133	66.4
457-50-1	1	T50	32	152	94.2

BLACK KEY SET FOR TORX® SCREWS



- Set of long black finish offset screwdrivers for TORX® head screws, 9 pieces
- All sizes marked on the holder for an easy selection
- Hanging hole
- In blister packaging

Part No.	Packaging	Quantity	Head	g
458-9-H	10	9	T10, T15, T20, T25, T27, T30, T40, T45, T50	290

BLACK KEY SET FOR TORX® SCREWS



- Set of black finish offset screwdrivers for TORX® head screws, 8 pieces
- Impact resistant holder
- Allows many different working positions
- Positive stop at 270° degrees, for maximum leverage
- In blister packaging

Part No.	Packaging	Quantity	Head	g
458-8-F	1	8	T9, T10, T15, T20, T25, T27, T30, T40	160

BLACK KEYS FOR TORX® TAMPER RESISTANT SCREWS

BLACK KEYS FOR TORX® TAMPER RESISTANT SCREWS

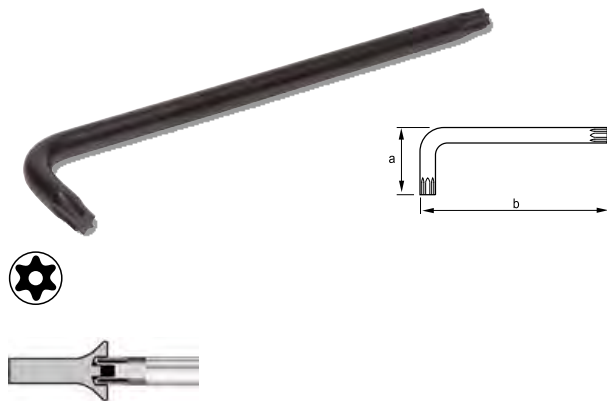

- High quality steel, entirely hardened
- Black finish
- Size laser marking on the blade for easy identification
- Long arm provides higher torque transmission and accessibility

R			a mm	b mm	Ø mm	g
454091	5	TR9	16	80	3.0	4
454101	5	TR10	17	86	3.0	5
454151	5	TR15	18	90	4.0	8
454201	5	TR20	19	95	4.0	11
454251	5	TR25	20	100	5.0	17
454271	5	TR27	21	105	5.0	19
454301	5	TR30	24	114	6.0	29
454401	5	TR40	26	124	7.0	43

BLACK KEY SETS FOR TORX® TAMPER RESISTANT SCREWS

BLACK KEY SETS FOR TORX® TAMPER RESISTANT SCREWS



- Set of long black finish offset screwdrivers for TORX® tamper head screws, 9 pieces
- All sizes marked on the holder for an easy selection
- Hanging hole
- In blister packaging

R				g
454-9-H	10	9	TR10, TR15, TR20, TR25, TR27, TR30, TR40, TR45, TR50	290



- Set of black finish offset screwdrivers for TORX® tamper head screws, 8 pieces
- Impact resistant holder
- Allows many different working positions
- Positive stop at 270° degrees, for maximum leverage
- In blister packaging

R				g
454-8-F	1	8	TR9, TR10, TR15, TR20, TR25, TR27, TR30, TR40	160

1/4" BITS

1/4" BITS FOR SLOTTED SCREWS, 25 MM



- Drive: 1/4" DIN 3126-C 6,3, ISO 1173
- Finish: sand blasting
- Material: high performance alloy steel
- Application: for all screw applications in trade and industry
- In plastic box for 10 pieces

Part No.	Box	W mm	H mm	L mm	g
475-4-1	1	0.5	4.0	25	35
475-4.5-1	1	0.6	4.5	25	35
475-5.5-1	1	0.8	5.5	25	35
475-6.0-1	1	1.0	6.0	25	35
475-6.5-1	1	1.2	6.5	25	35
475-8.0-1	1	1.6	8.0	25	35

1/4" BITS SLOTTED SCREWS, 70 MM



- Drive: 1/4" DIN 3126-C 6,3, ISO 1173
- Finish: sand blasting
- Material: high performance alloy steel
- Application: for all screw applications in trade and industry
- In plastic box for 5 pieces

Part No.	Box	W mm	H mm	L mm	g
475-70-3.0-1	1	0.5	3.0	70	70
475-70-3.5-1	1	0.6	3.5	70	70
475-70-5.5-1	1	0.8	5.5	70	77
475-70-6.5-1	1	1.2	6.5	70	80

1/4" BITS FOR PHILLIPS SCREWS, 25 MM



- Drive: 1/4" DIN 3126-C 6,3, ISO 1173
- Finish: sand blasting
- Material: high performance alloy steel
- Application: for all screw applications in trade and industry
- In plastic box for 10 pieces

Part No.	Box	Symbol	L mm	g
475-PH0-1	1	PH-0	25	35
475-PH1-1	1	PH-1	25	35
475-PH2-1	1	PH-2	25	35
475-PH3-1	1	PH-3	25	35

1/4" BITS FOR PHILLIPS SCREWS, 50 MM



- Drive: 1/4" DIN 3126-E 6,3, ISO 1173
- Finish: sand blasting
- Material: high performance alloy steel
- Application: for all screw applications in trade and industry
- In plastic box for 5 pieces

Part No.	Box	Symbol	L mm	g
475-50PH1-1	1	PH-1	50	70
475-50PH2-1	1	PH-2	50	70
475-50PH3-1	1	PH-3	50	77

1/4" BITS FOR PHILLIPS SCREWS, 70 MM



- Drive: 1/4" DIN 3126-E 6,3, ISO 1173
- Finish: sand blasting
- Material: high performance alloy steel
- Application: for all screw applications in trade and industry
- In plastic box for 5 pieces

Part No.	Box	Symbol	L mm	g
475-70PH1-1	1	PH-1	70	70
475-70PH2-1	1	PH-2	70	70
475-70PH3-1	1	PH-3	70	77

1/4" BITS FOR PHILLIPS SCREWS, 89 MM



- Drive: 1/4" DIN 3126-E 6,3, ISO 1173
- Finish: sand blasting
- Material: high performance alloy steel
- Application: for all screw applications in trade and industry
- In plastic box for 5 pieces

IRIMO	Box	Drive	L (mm)	g
475-89PH1-1	1	PH-1	89	100
475-89PH2-1	1	PH-2	89	100
475-89PH3-1	1	PH-3	89	110

1/4" BITS FOR PHILLIPS SCREWS, 150 MM



- Drive: 1/4" DIN 3126-E 6,3, ISO 1173
- Finish: sand blasting
- Material: high performance alloy steel
- Application: for all screw applications in trade and industry
- In plastic box for 5 pieces

IRIMO	Box	Drive	L (mm)	g
475-150PH1-1	1	PH-1	150	150
475-150PH2-1	1	PH-2	150	150

1/4" BITS FOR PHILLIPS DRY WALL SCREWS, 25 MM



- Drive: 1/4" DIN 3126-C 6,3, ISO 1173
- Finish: sand blasting
- Material: high performance alloy steel
- Application: Grabber bits for drywall screws
- With reduced nose diameter 4.8 mm
- In plastic box of 10 pieces

IRIMO	Box	Drive	L (mm)	g
475-PH2G-1	1	PH-2G	25	35

1/4" BITS FOR POZIDRIV SCREWS, 25 MM



- Drive: 1/4" DIN 3126-C 6,3, ISO 1173
- Finish: sand blasting
- Material: high performance alloy steel
- Application: for all screw applications in trade and industry
- In plastic box of 10 pieces

IRIMO	Box	Drive	L (mm)	g
475-PZ0-1	1	PZ-0	25	35
475-PZ1-1	1	PZ-1	25	35
475-PZ2-1	1	PZ-2	25	35
475-PZ3-1	1	PZ-3	25	35

1/4" BITS FOR POZIDRIV SCREWS, 50 MM



- Drive: 1/4" DIN 3126-E 6,3, ISO 1173
- Finish: sand blasting
- Material: high performance alloy steel
- Application: for all screw applications in trade and industry
- In plastic box of 5 pieces

IRIMO	Box	Drive	L (mm)	g
475-50PZ1-1	1	PZ-1	50	70
475-50PZ2-1	1	PZ-2	50	70
475-50PZ3-1	1	PZ-3	50	77



1/4" BITS

1/4" BITS FOR POZIDRIV SCREWS, 70 MM



- Drive: 1/4" DIN 3126-E 6,3, ISO 1173
- Finish: sand blasting
- Material: high performance alloy steel
- Application: for all screw applications in trade and industry
- In plastic box of 5 pieces

Part No.	Qty	Drive	Length (mm)	Weight (g)
475-70PZ1-1	1	PZ-1	70	70
475-70PZ2-1	1	PZ-2	70	70
475-70PZ3-1	1	PZ-3	70	77

1/4" BITS FOR POZIDRIV SCREWS, 89 MM



- Drive: 1/4" DIN 3126-E 6,3, ISO 1173
- Finish: sand blasting
- Material: high performance alloy steel
- Application: for all screw applications in trade and industry
- In plastic box of 5 pieces

Part No.	Qty	Drive	Length (mm)	Weight (g)
475-89PZ1-1	1	PZ-1	89	100
475-89PZ2-1	1	PZ-2	89	100
475-89PZ3-1	1	PZ-3	89	110

1/4" BITS FOR POZIDRIV SCREWS, 150 MM



- Drive: 1/4" DIN 3126-E 6,3, ISO 1173
- Finish: sand blasting
- Material: high performance alloy steel
- Application: for all screw applications in trade and industry
- In plastic box of 5 pieces

Part No.	Qty	Drive	Length (mm)	Weight (g)
475-150PZ1-1	1	PZ-1	150	150
475-150PZ2-1	1	PZ-2	150	150

1/4" BITS FOR TORX® SCREWS, 25 MM



- Drive: 1/4" DIN 3126-C 6,3, ISO 1173
- Finish: sand blasting
- Material: high performance alloy steel
- Application: for all screw applications in trade and industry
- In plastic box of 10 pieces (T30/T40 packed in box of 5 pieces)

Part No.	Qty	Drive	Length (mm)	Weight (g)	
475-T5-1	1	T5	1.70	25	30
475-T6-1	1	T6	1.70	25	30
475-T7-1	1	T7	1.99	25	35
475-T8-1	1	T8	2.31	25	35
475-T9-1	1	T9	2.50	25	35
475-T10-1	1	T10	2.74	25	35
475-T15-1	1	T15	3.27	25	35
475-T20-1	1	T20	3.86	25	35
475-T25-1	1	T25	4.43	25	35
475-T27-1	1	T27	4.99	25	35
475-T30-1	1	T30	5.52	25	40
475-T40-1	1	T40	6.65	25	50
475-T45-1	1	T45	7.90	25	70
475-T50-1	1	T50	7.94	25	80

1/4" BITS FOR TORX® SCREWS, 50 MM



- Drive: 1/4" DIN 3126-C 6,3, ISO 1173
- Finish: sand blasting
- Material: high performance alloy steel
- Application: for all screw applications in trade and industry
- In plastic box of 5 pieces

Part No.	Qty	Drive	Length (mm)	Weight (g)	
475-50T6-1	1	T6	1.70	50	38
475-50T8-1	1	T8	2.51	50	40
475-50T10-1	1	T10	2.74	50	42
475-50T15-1	1	T15	3.27	50	44
475-50T20-1	1	T20	3.86	50	46
475-50T25-1	1	T25	4.43	50	50
475-50T30-1	1	T30	5.52	50	52
475-50T40-1	1	T40	6.65	50	54

1/4" BITS FOR TORX® SCREWS, 89 MM



- Drive: 1/4" DIN 3126-C 6,3, ISO 1173
- Finish: sand blasting
- Material: high performance alloy steel
- Application: for all screw applications in trade and industry
- In plastic box of 5 pieces

Part No.	Box	Drive	Tip Length (mm)	Length (mm)	Weight (g)
475-89T10-1	1	T10	2.74	89	80
475-89T15-1	1	T15	3.27	89	85
475-89T20-1	1	T20	3.86	89	90
475-89T25-1	1	T25	4.43	89	100
475-89T27-1	1	T27	4.99	89	100
475-89T30-1	1	T30	5.52	89	110
475-89T40-1	1	T40	6.65	89	120

1/4" BITS FOR TORX® SCREWS, 150 MM



- Drive: 1/4" DIN 3126-C 6,3, ISO 1173
- Finish: sand blasting
- Material: high performance alloy steel
- Application: for all screw applications in trade and industry
- In plastic box of 5 pieces

Part No.	Box	Drive	Tip Length (mm)	Length (mm)	Weight (g)
475-150T10-1	1	T10	2.74	150	150
475-150T15-1	1	T15	3.27	150	150
475-150T20-1	1	T20	3.86	150	153
475-150T25-1	1	T25	4.43	150	155
475-150T30-1	1	T30	5.52	150	157
475-150T40-1	1	T40	6.65	150	160

1/4" BITS FOR TORX® TAMPER SCREWS, 25 MM



- Drive: 1/4" DIN 3126-C 6,3, ISO 1173
- Finish: sand blasting
- Material: high performance alloy steel
- Application: for all screw applications in trade and industry
- TORX® tamper resistant screws have a centre pin to prevent a standard TORX® driver to be inserted
- In plastic box of 5 pieces

Part No.	Box	Drive	Tip Length (mm)	Length (mm)	Weight (g)
475-TR10-1	1	T10	2.74	25	35
475-TR15-1	1	T15	3.27	25	35
475-TR20-1	1	T20	3.86	25	35
475-TR25-1	1	T25	4.43	25	35
475-TR27-1	1	T27	4.99	25	35
475-TR30-1	1	T30	5.52	25	40
475-TR40-1	1	T40	6.65	25	50

1/4" BITS FOR HEXAGONAL SCREWS, 25 MM



- Drive: 1/4" DIN 3126-C 6,3, ISO 1173
- Finish: sand blasting
- Material: high performance alloy steel
- Application: for all screw applications in trade and industry
- In plastic box of 5 pieces

Part No.	Box	Drive	Tip Length (mm)	Length (mm)	Weight (g)
475-H3-1	1	3	3	25	30
475-H4-1	1	4	4	25	35
475-H5-1	1	5	5	25	40
475-H6-1	1	6	6	25	45



1/4" BITS

TORSION BIT FOR PHILLIPS HEAD SCREWS, 25 MM



- Drive: 1/4" DIN 3126-C 6,3, ISO 1173
- Finish: steel grey surface coated with clear lacquer for rust protection
- Material: high performance alloy steel
- Application: torsion bits are suitable for hard material applications
- Torsion zone that absorbs torque peaks avoiding premature wear and tear and improving service life
- In plastic box of 10 pieces

Code	Box	Drive	L mm	g
475T-PH1-1	1	PH-1	25	30
475T-PH2-2	1	PH-2	25	40
475T-PH3-2	1	PH-3	25	40

TORSION BIT FOR POZIDRIV HEAD SCREWS, 25 MM



- Drive: 1/4" DIN 3126-C6.3,ISO 1173
- Finish: steel grey surface coated with clear lacquer for rust protection
- Material: high performance alloy steel
- Application: torsion bits are suitable for hard material applications
- Torsion zone that absorbs torque peaks avoiding premature wear and tear and improving service life
- In plastic box of 10 pieces

Code	Box	Drive	L mm	g
475T-PZ1-1	1	PZ-1	25	30
475T-PZ2-2	1	PZ-2	25	40
475T-PZ3-2	1	PZ-3	25	40

DIAMOND BIT FOR PHILLIPS HEAD SCREWS, 25 MM



- Drive: 1/4" DIN 3126-C 6,3, ISO 1173
- Finish: gold coloured diamond coating
- Material: high performance alloy steel
- Application: high performance in any application
- Minimises the cam-out effect reducing "down-time"
- Reduces wear of bit and screw
- Torsion zone that absorbs torque peaks avoiding premature wear and tear and improving service life
- In plastic box of 5 pieces

Code	Box	Drive	L mm	g
475D-PH1-1	1	PH-1	25	30
475D-PH2-1	1	PH-2	25	40
475D-PH3-1	1	PH-3	25	40

DIAMOND BIT FOR POZIDRIV HEAD SCREWS, 25 MM



- Drive: 1/4" DIN 3126-C 6,3, ISO 1173
- Finish: gold coloured diamond coating
- Material: high performance alloy steel
- Application: high performance in any application
- Minimises the cam-out effect reducing "down-time"
- Reduces wear of bit and screw
- Torsion zone that absorbs torque peaks avoiding premature wear and tear and improving service life
- In plastic box of 5 pieces

Code	Box	Drive	L mm	g
475D-PZ1-1	1	PZ-1	25	30
475D-PZ2-1	1	PZ-2	25	40
475D-PZ3-1	1	PZ-3	25	40

1/4" POWER MAGNETIC NUT DRIVER, METRIC



- Drive: 1/4" DIN 3126-E 6,3, ISO 1173
- Finish: sand blasting
- Material: high performance alloy steel
- Application: for all screw applications in trade and industry
- With strong magnet
- Hexagon socket
- In plastic holder (1 piece)

Part No.	Box	mm	1/4"	Ø mm	L mm	g
474M-5.5-1	1	5.5	1/4"	11.5	50	25
474M-6-1	1	6	1/4"	11	50	21
474M-7-1	1	7	1/4"	12	50	28
474M-8-1	1	8	1/4"	12.5	50	24
474M-9-1	1	9	1/4"	13.5	50	31
474M-10-1	1	10	1/4"	15.5	50	36
474M-11-1	1	11	1/4"	18.4	50	30
474M-12-1	1	12	1/4"	14.5	50	34
474M-13-1	1	13	1/4"	17	50	40

1/4" POWER MAGNETIC NUT DRIVER SET



- Drive: 1/4" DIN 3126 E 6.3, ISO 1173
- Finish: sand blasting
- Material: high performance alloy steel
- Application: for all screw applications in trade and industry
- With strong magnet
- Hexagon socket. In blister packaging

Part No.	Box	Blister	g
474M-5-H	1	5	134

474M-5.5-1, 474M-7-1, 474M-8-1, 474M-10-1, 474M-13-1

1/4" POWER MAGNETIC NUT DRIVER, INCHES



- Drive: 1/4" DIN 3126-E 6,3, ISO 1173
- Finish: sand blasting
- Material: high performance alloy steel
- Application: for all screw applications in trade and industry
- With strong magnet
- Hexagon socket
- In plastic holder (1 piece)

Part No.	Box	1/4"	1/4"	Ø mm	L mm	g
474M-1/4-1	1	1/4"	1/4"	11	50	21
474M-3/8-1	1	3/8"	1/4"	14.3	50	31

1/4" POWER NUT DRIVER WITH RETAINING RING



- Drive: 1/4" DIN 3126-E 6,3, ISO 1173
- Finish: sand blasting
- Material: high performance alloy steel
- Application: for all screw applications in trade and industry
- Hexagon socket
- In plastic holder (1 piece)

Part No.	Box	1/4"	1/4"	Ø mm	L mm	g
474MR-8-1	1	8	1/4"	12.5	50	24
474MR-10-1	1	10	1/4"	13.5	50	36

1/4" BITS

ADAPTOR 1/4", 25 MM



- Drive: 1/4" DIN 3126-A 6.3, ISO 1173
- Finish: black finish
- Material: high performance alloy steel
- Hexagonal male to square male DIN3120
- In plastic bag (1 piece)
- Retail package

Part No.	Qty	Drive	Hex Size	Length (mm)	Weight (g)
475A-25-1	1	1/4"	1/4"	25	5

ADAPTOR 1/4", 50 MM



- Drive: 1/4" DIN 3126-A 6.3, ISO 1173
- Finish: black finish
- Material: high performance alloy steel
- Hexagonal male to square male DIN3120
- In plastic holder (1 piece)

Part No.	Qty	Drive	Hex Size	Length (mm)	Weight (g)
475A-50-1	1	1/4"	1/4"	50	18
475A-50-1/2-1	1	1/2"	1/4"	50	25

UNIVERSAL HOLDER 1/4"



- Drive: 1/4" DIN 3126-E 6,3, ISO 1173
- Finish: black finish
- Material: high performance alloy steel
- With strong magnet
- DIN 3126 D 6,3
- In plastic holder (1 piece)

Part No.	Qty	Drive	Hex Size	Length (mm)	Weight (g)
475A-M-50-1	1	1/4"	1/4"	50	20
475A-M-75-1	1	1/4"	1/4"	75	35
475A-M-150-1	1	1/4"	1/4"	150	47

QUICK RELEASE BIT HOLDER 1/4"



- Drive: DIN 3126-E 6,3, ISO 1173
- Material: high performance alloy steel
- DIN 3126 D 6,3
- With permanent magnet
- In plastic holder (1 piece)

Part No.	Qty	Drive	Hex Size	Ø (mm)	Length (mm)	Weight (g)
475A-60QR-1	1	1/4"	1/4"	14	60	15
475A-75QR-1	1	1/4"	1/4"	14	75	33

1/4" BITS SETS

1/4" BITS SETS, 32 pieces



- Drive: 1/4" DIN 3126-C 6,3, ISO 1173
- Finish: sand blasting
- Material: high performance alloy steel
- Display: 475-32-8 Disp 8 sets in blister packaging

475-32-1	1	32	30x105x65	275
475-32-8DISP	1	8	360x340x260	2.240
475-4.5-1, 475-4-1, 475-5.5-1				
2x 475-PH1-1, 2x 475-PH2-1, 2x 475-PH3-1				
475-PH2G-1				
2x 475-PZ1-1, 2x 475-PZ2-1, 2x 475-PZ3-1				
475-T10-1, 2x 475-T15-1, 2x 475-T20-1, 2x 475-T25-1, 475-T27-1, 2x 475-T30-1, 475-T40-1				
475-H3-1, 475-H4-1, 475-H5-1, 475-H6-1				
475A-25-1				
105-48-1				
475A-60QR-1				

1/4" BITS SETS, 32 pieces



- Bits set of 32 pieces: 30 bits, 1 magnetic quick release bit holder and bit holding screwdriver for interchangeable bits
- 1/4" hexagon drive. DIN 3126, ISO 1173, style C 6.3
- Lock-in type system for easy and safety lock, magnetic. The bit stays caught until the release is driven
- Robust and tough bits
- Quick release bit holder with strong magnet (style E 6.3)
- Sand blasting finish bits
- Robust plastic case with hanger. Transparent lid
- For universal use
- High performance alloy steel
- In blister packaging

475-32A-1	6	32	153x35x100	375
475A-60QR-1				
475-4.5-1, 475-5.5-1, 475-6.5-1				
3x 475-PH1-1, 3x 475-PH2-1, 3x 475-PH3-1				
3x 475-PZ1-1, 3x 475-PZ2-1, 3x 475-PZ3-1				
475-H4-1, 475-H5-1, 475-H6-1				
475-T10-1, 475-T15-1, 475-T20-1, 475-T25-1, 475-T30-1, 475-T40-1				

1/4" BITS SETS

1/4" TORX® BITS SET



- Bits set of 9 pieces: 8 bits and 1 magnetic quick release bit holder
- 1/4" hexagon drive. DIN 3126, ISO 1173, style C 6.3
- Robust and tough bits
- Quick release bit holder with strong magnet (style E 6.3)
- Sand blasting finish bits
- The small size of the set is ideal to be carried in a pocket. Easy to open and close
- For universal use
- High performance alloy steel
- In blister packaging

Part No.	Quantity	Dimensions (mm)	Weight (g)
475-9-1	1	40x20x97	129
475A-60QR-1			
475-T10-1, 475-T15-1, 2x 475-T20-1, 2x 475-T25-1, 475-T30-1, 475-T40-1			

1/4" BITS SETS, 61 pieces



- Drive: 1/4" DIN 3126-C 6.3, ISO 1173
- Finish: sand blasting
- Material: high performance alloy steel
- In blister packaging

Part No.	Quantity	Dimensions (mm)	Weight (g)
475-61-1	1	35x148x112	549
475-4.5-1, 475-4-1, 475-5.5-1, 475-6.0-1, 475-6.5-1, 475-8.0-1			
475-PH0-1, 2x 475-PH1-1, 3x 475-PH2-1, 2x 475-PH3-1			
2x 475-PH2G-1			
475-PZ0-1, 2x 475-PZ1-1, 3x 475-PZ2-1, 2x 475-PZ3-1			
475-T6-1, 475-T7-1, 475-T8-1, 475-T9-1, 2x 475-T10-1, 2x 475-T15-1, 3x 475-T20-1, 2x 475-T25-1, 2x 475-T27-1, 2x 475-T30-1, 2x 475-T40-1			
475-TR10-1, 475-TR15-1, 475-TR20-1, 475-TR25-1, 475-TR27-1, 475-TR30-1, 475-TR40-1			
475-H3-1, 475-H4-1, 475-H5-1, 475-H6-1			
475A-25-1			
R-1, R-2, R-3			
475A-60QR-1			

PRECISION SCREWDRIVER SET FOR PRECISION ENGINEERING AND ELECTRONICS APPLICATIONS

RATCHETING BIT HOLDER PRECISION SCREWDRIVER WITH 17 PIECES BITS



- Bits drive: 5/32" DIN 3126-C 4, ISO 1173
- Bits: made of chrome-vanadium steel, durable and high precision
- Handle: 2-component handle
- The rotating head allows an easy and accurate driving
- Magnetic blade secures bit in screwdriver
- Smooth ratcheting stroke: Three position ratchet mechanism: forward, reverse and neutral
- In blister packaging

Part No.	Quantity	Dimensions (mm)	Weight (g)
471-18-1	1	35x95x130	220
x3	SL: 1-1.5-2 mm	x3	PH000-PH00-PH0
x5	T2-T3-T4-T5-T6	x2	0.8-1.2
x2	Y 2.0-3.0	x1	U 2.6
x1	2.3	x1	

5/16" BITS

5/16" BITS FOR SLOTTED SCREWS



x2

- Drive: 5/16" DIN 3126-C 8, ISO 1173
- Finish: zinc phosphated
- Material: high performance alloy steel
- In plastic bag of 2 pieces
- Retail package

E	Icon	mm	mm	mm	g
470-5.5-1	1	1.0	5.5	36	18
470-6.5-1	1	1.2	6.5	36	20
470-8.0-1	1	1.2	8.0	36	22
470-10.0-1	1	1.6	10.0	36	30
470-12.0-1	1	2.0	12.0	36	36
470-14.0-1	1	2.5	14.0	36	38

5/16" BITS FOR HEXAGONAL SCREWS



x2

- Drive: 5/16" DIN 3126-C 8, ISO 1173
- Finish: zinc phosphated
- Material: high performance alloy steel
- In plastic bag of 2 pieces
- Retail package

E	Icon	mm	mm	g
470-H4-1	1	4	36	25
470-H5-1	1	5	36	26
470-H6-1	1	6	36	27
470-H7-1	1	7	36	28
470-H8-1	1	8	36	29
470-H10-1	1	10	36	36

5/16" BITS FOR PHILLIPS SCREWS



x2

- Drive: 5/16" DIN 3126-C 8, ISO 1173
- Finish: zinc phosphated
- Material: high performance alloy steel
- In plastic bag of 2 pieces
- Retail package

E	Icon	PH	mm	g
470-PH1-1	1	PH-1	36	22
470-PH2-1	1	PH-2	36	24
470-PH3-1	1	PH-3	36	25
470-PH4-1	1	PH-4	36	28

5/16" BITS FOR TORX® SCREWS



x2

- Drive: 5/16" DIN 3126-C 8, ISO 1173
- Finish: zinc phosphated
- Material: high performance alloy steel
- In plastic bag of 2 pieces
- Retail package

E	Icon	T	mm	mm	g
470-T20-1	1	T20	3.86	36	21
470-T25-1	1	T25	4.43	36	22
470-T27-1	1	T27	4.99	36	24
470-T30-1	1	T30	5.52	36	24
470-T40-1	1	T40	6.65	36	27
470-T45-1	1	T45	7.82	36	27
470-T50-1	1	T50	8.83	36	27
470-T55-1	1	T55	11.22	36	28



5/16" IMPACT SCREWDRIVER

5/16" IMPACT SCREWDRIVER



- To turn frozen screws
- Converts hammer action on turning driving
- Hammer action guarantees that the bit will remain against the screw
- Square drive 1/2". Bit size 5/16"
- Reversible by positioning the adaptor

		L mm	C mm	A mm	L1 mm	
470011	1	125	33	24	40	650

5/16" IMPACT SCREWDRIVER ADAPTOR



- Finish: Chrome-plated
- 1/2" square drive
- For 5/16" bits
- With retaining ring

		L mm	
470051	1	40	54

5/16" IMPACT DRIVER BIT SET



- 1 Impact screwdriver, 1/2" square drive
- 1 Bit holding adaptor for screwdriver bits, 5/16" hexagon and 1/2" square drive
- 18 bits of 5/16"
- In black metal box

471011	1	197 x 70 x 45	1.280

470-8.0-1, 470-10.0-1, 470-12.0-1		
470-PH2-1, 470-PH3-1, 470-PH4-1		
470-H4-1, 470-H5-1, 470-H6-1, 470-H7-1, 470-H8-1, 470-H10-1		
470-T25-1, 470-T27-1, 470-T30-1, 470-T40-1, 470-T45-1, 470-T50-1		
470011		

10 MM BITS

10 MM BITS FOR HEXAGONAL SCREWS



- Drive: 10 mm
- Finish: zinc phosphated
- Material: high performance alloy steel
- In plastic bag of 1 piece

Part No.	Qty	Hex Size (mm)	Length (mm)	Weight (g)
T49H4	1	4	30	5
T49H5	1	5	30	6.5
T49H6	1	6	30	7
T49H7	1	7	30	7
T49H8	1	8	30	7
T49H10	1	10	30	7
T49H12	1	12	30	12
T49H14	1	14	30	14
T49H4L	1	4	75	20
T49H5L	1	5	75	20
T49H6L	1	6	75	20
T49H7L	1	7	75	20
T49H8L	1	8	75	20
T49H10L	1	10	75	20
T49H12L	1	12	75	20
T49H10XL	1	10	115	75

10 MM BITS FOR TORX® SCREWS



- Drive: 10 mm
- Finish: zinc phosphated
- Material: high performance alloy steel
- In plastic bag of 1 piece

Part No.	Qty	Drive	Tip Size (mm)	Length (mm)	Weight (g)
T49T20	1	T20	3.84	30	6.5
T49T25	1	T25	4.4	30	6.5
T49T27	1	T27	4.96	30	6.5
T49T30	1	T30	5.49	30	6.5
T49T40	1	T40	6.6	30	6.5
T49T45	1	T45	7.7	30	6.5
T49T50	1	T50	8.79	30	6.5
T49T55	1	T55	11.17	30	6.5
T49T60	1	T60	13.2	30	6.5
T49T20L	1	T20	3.84	75	20
T49T25L	1	T25	4.4	75	20
T49T27L	1	T27	4.96	75	20
T49T30L	1	T30	5.49	75	20
T49T40L	1	T40	6.6	75	20
T49T45L	1	T45	7.7	75	20
T49T50L	1	T50	8.79	75	20
T49T55L	1	T55	11.17	75	20
T49T60L	1	T60	13.2	75	20
T49T55XL	1	T55	11.17	115	75

1/2" ADAPTOR FOR 10 MM BITS



- 1/2" Adaptor for 10 mm bits
- Finish: zinc phosphated
- Material: high performance alloy steel
- In plastic bag of 1 piece

Part No.	Qty	Hex Size (mm)	L (mm)	D1 (mm)	D2 (mm)	g
T4901	1	10	36	17	22	55

3/8" ADAPTOR FOR 10 MM BITS



- 3/8" Adaptor for 10 mm bits
- Finish: zinc phosphated
- Material: high performance alloy steel
- In plastic bag of 1 piece

Part No.	Qty	Hex Size (mm)	L (mm)	D1 (mm)	D2 (mm)	g
T4902	1	10	35	15	10	32

10 MM BITS

10 MM BITS FOR TORX® TAMPER SCREWS



- Drive: 10 mm
- Finish: zinc phosphated
- Material: high performance alloy steel
- In plastic bag of 1 piece

R					
T49T20H	1	TR20	3.84	30	6.5
T49T25H	1	TR25	4.4	30	6.5
T49T27H	1	TR27	4.96	30	6.5
T49T30H	1	TR30	5.49	30	6.5
T49T40H	1	TR40	6.6	30	6.5
T49T45H	1	TR45	7.7	30	6.5
T49T50H	1	TR50	8.79	30	6.5
T49T55H	1	TR55	11.17	30	6.5
T49T60H	1	TR60	13.2	30	6.5
T49T20HL	1	TR20	3.84	75	20
T49T25HL	1	TR25	4.4	75	20
T49T27HL	1	TR27	4.96	75	20
T49T30HL	1	TR30	5.49	75	20
T49T40HL	1	TR40	6.6	75	20
T49T45HL	1	TR45	7.7	75	20
T49T50HL	1	TR50	8.79	75	20
T49T55HL	1	TR55	11.17	75	20
T49T60HL	1	TR60	13.2	75	20

10 MM BITS FOR XZN SCREWS



- Drive: 10 mm
- Finish: zinc phosphated
- Material: high performance alloy steel
- In plastic bag of 1 piece

R				
T49M5	1	M5	30	6.5
T49M6	1	M6	30	7
T49M8	1	M8	30	7
T49M10	1	M10	30	8.5
T49M12	1	M12	30	10
T49M14	1	M14	30	20
T49M5L	1	M5	75	15
T49M6L	1	M6	75	15
T49M8L	1	M8	75	15
T49M10L	1	M10	75	15
T49M12L	1	M12	75	15

10 MM SQUARE BITS



- Drive: 10 mm
- Finish: zinc phosphated
- Material: high performance alloy steel
- In plastic bag of 1 piece

R				
T49SQ8	1	8	30	17
T49SQ10	1	10	30	22

1/2" SOCKET DRIVERS

1/2" SOCKET DRIVERS FOR TORX® TAMPER SCREWS

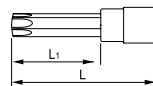

- 1/2" socket drivers for TORX® tamper screws
- Finish: zinc phosphated
- Material: high performance alloy steel
- In plastic bag of 1 piece

R				L mm	L1 mm	
T49T30XL	1	TR30	1/2"	200	160	122
T49T40XL	1	TR40	1/2"	200	160	123
T49T45XL	1	TR45	1/2"	200	160	125
T49T70HL	1	TR70	1/2"	100	60	167
T49T80HL	1	TR80	1/2"	100	30	163

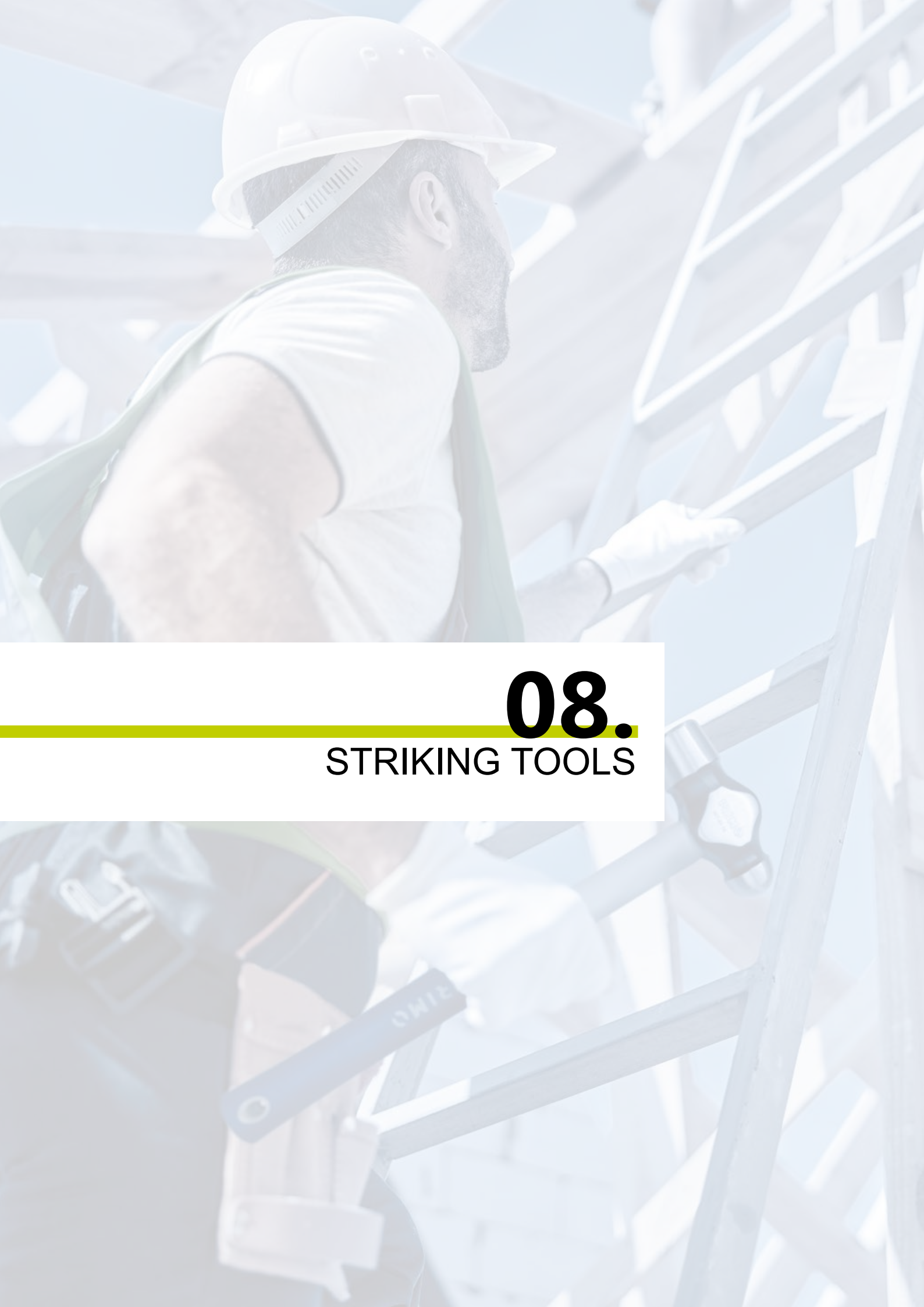

08.

STRIKING TOOLS

PUNCHES AND CHISELS

COLD CHISELS



- Chrome vanadium
- Standard: UNE 16567

Code	Box	L mm	S mm	A mm	g
501-150-1	25	150	18	10	133
501-200-1	25	200	22	12	243
501-250-1	20	250	25	13	357
501-300-1	25	300	26	14	552

FLAT COLD CHISELS

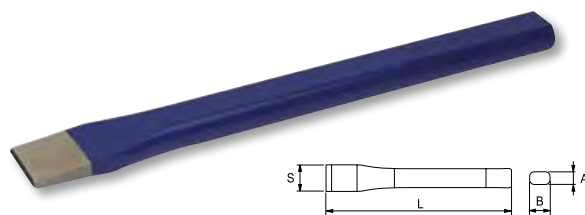

- Chrome molib. vanadium
- Finish: Lacquered, blue painted
- Flat oval shank
- Standard: DIN 7250

Code	Box	L mm	S mm	AxB mm	g
504-150-1	10	150	21	11x17	181
504-175-1	10	175	24	12x20	269
504-200-1	10	200	28	13x23	390
504-250-1	10	250	28	13x23	500
504-300-1	10	300	32	13x26	602

FLAT COLD CHISEL

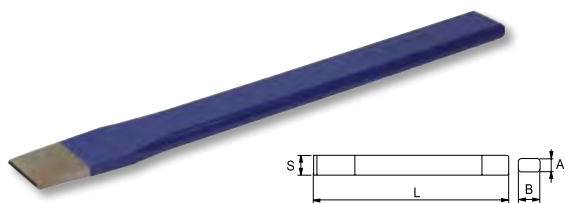

- Chrome molib. vanadium
- Finish: Lacquered, blue painted
- Flat oval shank

Code	Box	L mm	S mm	A mm	B mm	g
502-230-1	10	230	26	7	26	285

EXTRAFLAT COLD CHISEL

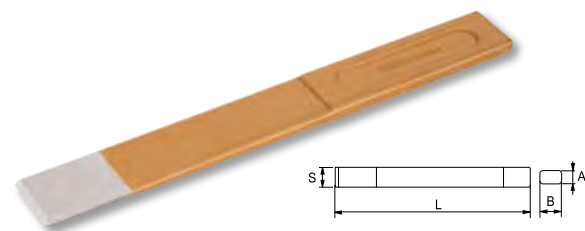

- Extraflat cold chisel
- Chrome molib. vanadium
- Flat oval shank

Code	Box	L mm	S mm	A mm	B mm	g
500-240-1	10	230	26	4	26	278

FLAT CAPE CHISELS

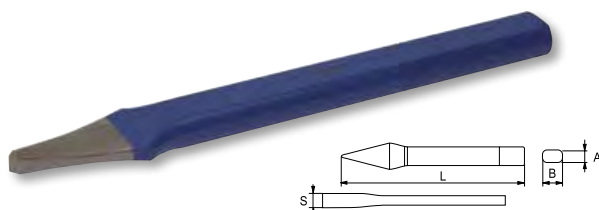

- Chrome molib. vanadium
- Finish: Lacquered, blue painted
- Flat oval shank
- Standard: DIN 7250

Code	Box	L mm	S mm	AxB mm	g
506-150-1	10	150	6	11x17	152
506-175-1	10	175	7	12x20	231
506-200-1	10	200	8	13x23	335

ROUND CENTRE PUNCHES

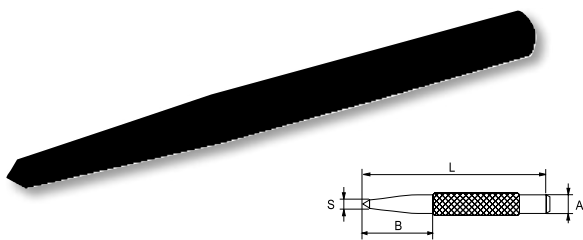

- Black finish
- Standard: UNE 16574

R	Icon	S mm	L mm	A mm	B mm	g
511-100-1		2.5	100	8	35	31
511-105-1		4	105	8	35	34
511-110-1		5	110	8	40	37
511-115-1		6	115	10	45	60
511-130-1		8	130	12	50	98

OCTAGONAL CENTRE PUNCHES



- Chrome molib. vanadium
- Finish: Lacquered, blue painted
- Octagonal shank
- Standard: DIN 7250

R	Icon	S mm	L mm	A mm	B mm	g
512-010-1		4	120	10	40	62
512-012-1		5	120	12	40	88

ROUND CENTRE PUNCH SETS



R	Icon	Icon	Icon	g
511-91-4				234
511-92-4				275

ROUND TAPER PUNCHES

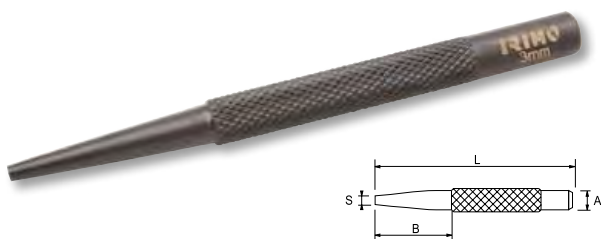

- Black finish
- Standard: UNE 16576

R	Icon	S mm	L mm	A mm	B mm	g
513-002-1		2	100	8	35	31
513-003-1		3	100	8	35	32
513-004-1		4	115	10	45	55
513-005-1		5	115	10	45	59
513-006-1		6	130	12	50	94
513-008-1		8	150	12	55	117
513-010-1		10	170	14	60	183

OCTAGONAL TAPER PUNCHES

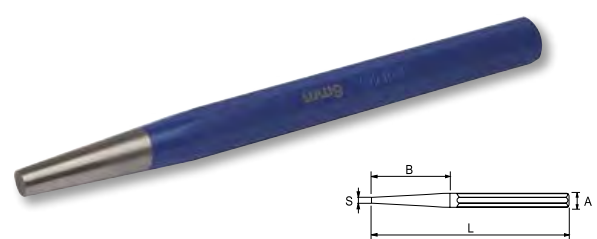

- Chrome molib. vanadium
- Finish: Lacquered, blue painted
- Octagonal shank
- Standard: DIN 6458

R	Icon	S mm	L mm	A mm	B mm	g
514-002-1		2	120	10	40	60
514-003-1		3	120	10	40	60
514-004-1		4	120	10	40	62
514-005-1		5	120	10	40	64
514-006-1		6	120	12	40	93



PUNCHES AND CHISELS

ROUND TAPER PUNCH SET



IRIMO	Box	Case	Diagram	Weight (g)
513-91-4	1	5	2-4-6-8-10 mm	502
513-92-4	1	7	2-3-4-5-6-8-10 mm	602

OCTAGONAL TAPER PUNCH SETS



IRIMO	Box	Case	Diagram	Weight (g)
519-91-4	1	6	150x80x12	409
2-3-4-5-6 mm				
4 mm				

ROUND PARALLEL PIN PUNCHES

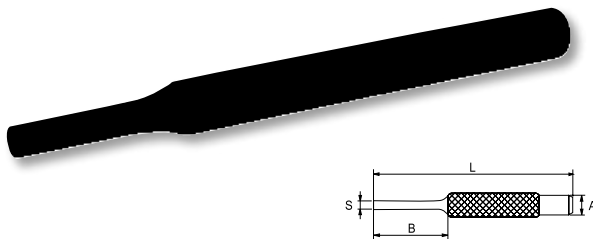

- Black finish
- Standard: UNE 16575

IRIMO	Box	S mm	L mm	A mm	B mm	Weight (g)
515-002-1	25	2	100	8	28	29
515-003-1	25	3	100	8	28	30
515-004-1	25	4	100	8	28	31
515-005-1	25	5	115	10	33	53
515-006-1	25	6	115	10	33	55
515-007-1	25	7	115	10	33	58
515-008-1	20	8	130	12	43	91
515-009-1	20	9	130	12	43	96
515-010-1	20	10	130	14	53	143

OCTAGONAL PARALLEL PIN PUNCHES



- Chrome molib. vanadium
- Finish: Lacquered, blue painted
- Octagonal shank
- Standard: DIN 6450

IRIMO	Box	S mm	L mm	A mm	B mm	Weight (g)
516-002-1	20	2	150	10	35	63
516-003-1	20	3	150	10	40	63
516-004-1	20	4	150	10	50	63
516-005-1	20	5	150	10	50	64
516-006-1	20	6	150	10	50	70
516-008-1	20	8	150	12	55	106

ROUND PARALLEL PIN PUNCH SET



515-91-4	1	9	2-3-4-5-6-7-8-9-10 mm	622

OCTAGONAL PARALLEL PIN PUNCH SET



519-92-4	1	6	2-3-4-5-6-8 mm	409

ROUND PARALLEL PIN PUNCHES, LONG SERIES

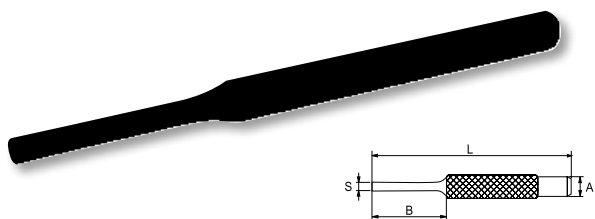

- Black finish
- Standard: UNE 16575

		S mm	L mm	A mm	B mm	
517-120-1	25	2	120	8	30	33
517-130-1	25	3	130	8	40	35
517-135-1	25	4	135	8	45	37
517-140-1	25	5	140	10	50	60
517-145-1	20	6	145	10	55	64
517-150-1	20	8	150	12	60	100

OCTAGONAL PARALLEL PIN PUNCHES, LONG SERIES

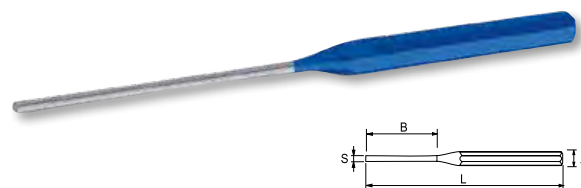

- Finish: Lacquered, blue painted
- Octagonal shank
- Long length

		S mm	L mm	A mm	B mm	
518-004-1	20	4	175	10	80	61
518-006-1	20	6	175	10	80	72

ROUND PARALLEL PIN PUNCH SETS, LONG SERIES



517-91-4	1	6	2-3-4-5-6-8 mm	355



PUNCHES AND CHISELS

ELECTRICIAN'S COLD CHISELS

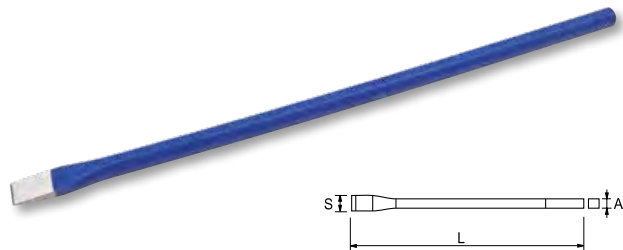

- Finish: Lacquered, blue painted
- Chrome molib. vanadium

Code	Box	L mm	S mm	A mm	g
503-200-1	20	200	12	8	93
503-250-1	20	250	12	8	119
503-300-1	20	300	12	8	142

SET



Code	Box	Case	Dimensions	g
519-93-4	1	6	160x85x12	600
504-150-1				
506-150-1				
512-010-1				
514-003-1, 514-004-1				
516-005-1				

ENGINEERS SCRIBERS



- Suitable for marking on hard surfaces
- 150 mm long

Code	Box	L mm	g
511501	1	150	39

WRECKING BARS



- Heavy duty tool for striking tasks
- Designed for a good penetration in very narrow places and nails provided
- With special designed claw areas to facilitate nail extraction
- Smooth finishing and high quality paint to get a comfortable use

Code	Box	Ø mm	L mm	g
WB-300-2	1	14	346	450
WB-500-2	1	16	487	1.100
WB-625-2	1	17	685	1.450
WB-710-2	1	17	704	1.950
WB-900-2	1	20	890	2.850

HAMMERS

CURVED CLAW HAMMER WITH WOODEN HICKORY HANDLE



- Handle fitting to hammer head with wedges

Code	Box	oz	g	A mm	B mm	L mm	g
520-41-2	6	16	450	29	130	330	710
520-61-2	6	20	560	30	140	333	820

CURVED CLAW HAMMER WITH FIBREGLASS HANDLE



- Handle specially glued to hammer head
- Trimaterial handle with fiberglass core and covered with polypropylene and elastomere for an effective grip

Code	Box	oz	g	A mm	B mm	L mm	g
520-43-2	6	16	450	29	130	330	710
520-63-2	6	20	560	30	140	333	820

SPARE WOODEN HICKORY HANDLE FOR CURVED CLAW HAMMERS



- Served with corresponding wedges

Code	Box	Code	g
520-42-2	12	520-41-2 / 520-61-2	160

STUBBY CLAW HAMMER



- Handle specially glued to hammer head
- Trimaterial handle with fiberglass core and covered with polypropylene and elastomere for an effective grip
- Magnet on the head for holding the nail

Code	Box	oz	g	A mm	B mm	L mm	g
520-13S-1	6	8	227	23	105	160	300

SPANISH TYPE CURVED CLAW HAMMER WITH WOODEN HICKORY HANDLE



- Handle has conical fitting to the hammer head

Code	Box	g	A mm	B mm	L mm	g
521-51-2	6	350	28.2	107.3	330	500
521-71-2	6	475	31.1	118.3	330	625
521-81-2	6	550	31.6	125.5	330	700

SPARE WOODEN HICKORY HANDLE FOR SPANISH TYPE CURVED CLAW HAMMERS



- Conical hickory handle

Code	Box	Code	g
521-52-2	18	521-51-2 / 521-71-2	160
521-82-2	18	521-81-2	160



HAMMERS

JOINER'S HAMMER WITH WOODEN HICKORY HANDLE



- Handle fitted with wedges to hammer head

R	Icon	g	A mm	B mm	L mm	g
522-21-2	12	170	20	91	282	270
522-31-2	6	270	25	107	291	380
522-41-2	6	460	30	120	311	680

GERMAN DIN HAMMER WITH WOODEN HICKORY HANDLE



- Handle wedged to hammer head

R	Icon	g	A mm	B mm	L mm	g
525-11-2	6	100	17	90	270	250
525-21-2	6	200	19	95	280	280
525-31-2	6	300	23	105	300	420
525-41-2	6	500	27	118	320	650
525-61-2	6	800	33	130	350	990
525-71-2	4	1.000	36	135	360	1.220
525-81-2	4	1.500	42	145	380	1.790
525-91-2	4	2.000	45	150	380	2.300

SPARE WOODEN HICKORY HANDLE FOR JOINER'S HAMMERS



- Served with corresponding wedges

R	Icon	g	g
522-22-2	18	522-21-2	63
522-32-2	18	522-31-2	100
522-42-2	18	522-41-2	140

SPARE WOODEN HICKORY HANDLE FOR GERMAN DIN HAMMERS



- Served with corresponding wedges

R	Icon	g	g
525-12-2	12	525-11-2	96
525-22-2	12	525-21-2	86
525-32-2	12	525-31-2	93
525-42-2	12	525-41-2	136
525-62-2	12	525-61-2	212
525-72-2	12	525-71-2	260
525-82-2	12	525-81-2	298
525-92-2	12	525-91-2	344

JOINER'S HAMMER WITH FIBREGLASS HANDLE



- Handle specially glued to hammer head
- Trimaterial handle with fiberglass core and covered with polypropylene and elastomere for an effective grip

R	Icon	g	A mm	B mm	L mm	g
522-23-2	12	170	20	91	282	270
522-33-2	6	270	25	107	291	380
522-43-2	6	460	30	120	311	680

GERMAN DIN HAMMER WITH FIBREGLASS HANDLE



- Handle specially glued to hammer head
- Trimaterial handle with fiberglass core and covered with polypropylene and elastomere for an effective grip

R	Icon	g	A mm	B mm	L mm	g
525-43-2	6	500	27	118	330	735

RIVOIR HAMMER WITH WOODEN HICKORY HANDLE



- Handle wedged to hammer head

Q	Icon	g	A mm	B mm	L mm	g
526-31-2	4	250	25	81.5	265	350
526-41-2	4	400	30	92	280	520
526-51-2	4	630	35	103	300	800
526-61-2	4	800	40	110	330	1.000
526-71-2	4	1.150	45	124	350	1.400
526-91-2	4	2.000	50	138	380	2.250

SPARE WOODEN HICKORY HANDLE FOR RIVOIR HAMMERS



- Served with corresponding wedges

Q	Icon	g
526-32-2	12	526-31-2 93
526-42-2	12	526-41-2 136
526-52-2	12	526-51-2 212
526-62-2	12	526-61-2 260
526-72-2	12	526-71-2 298
526-92-2	12	526-91-2 344

RIVOIR HAMMER WITH FIBREGLASS HANDLE



- Handle specially glued to hammer head
- Trimaterial handle with fiberglass core and covered with polypropylene and elastomere for an effective grip

Q	Icon	g	A mm	B mm	L mm	g
526-53-2	6	630	35	103	330	630

BALL PEIN HAMMER WITH WOODEN HICKORY HANDLE



- Handle wedged to hammer head

Q	Icon	oz	g	A mm	B mm	L mm	g
527-31-2	6 B	12	340	27	87	318	440
527-41-2	6 C	16	455	30	97	318	560
527-51-2	6 D	20	560	33	106	318	720
527-61-2	6 E	24	680	35	116	343	920
527-71-2	6 F	32	910	37	127	343	1.148
527-81-2	6 G	40	1.135	38	134	378	1.400
527-91-2	6 H	48	1.360	40	144	385	1.640

SPARE WOODEN HICKORY HANDLE FOR BALL PEIN HAMMERS



- Served with corresponding wedges

Q	Icon	g
527-32-2	18	527-31-2 (B) / 527-41-2 (C) / 527-51-2 (D) 100
527-52-2	12	527-61-2 (E) / 527-71-2 (F) 160
527-82-2	12	527-81-2 (G) / 527-91-2 (H) 220

BALL PEIN HAMMER WITH FIBREGLASS HANDLE



- Handle specially glued to hammer head
- Trimaterial handle with fiberglass core and covered with polypropylene and elastomere for an effective grip

Q	Icon	oz	g	A mm	B mm	L mm	g
527-33-2	6 B	12	340	27	90	317	500
527-43-2	6 C	16	455	30	100	320	600
527-53-2	6 D	20	560	33	108	324	760
527-63-2	6 E	24	680	35	120	335	920
527-73-2	6 F	32	910	37	131	337	1.148
527-83-2	6 G	40	1.135	38	139	387	1.400
527-93-2	6 H	48	1.360	40	148	390	1.640



HAMMERS

STONING HAMMER WITH WOODEN HICKORY HANDLE



- Handle wedged to the club hammer head

R	Icon	g	A mm	B mm	L mm	g
530-03-2	6	700	35	110	280	800
530-05-2	6	1.000	38	120	280	1.200
530-07-2	6	1.250	43	135	280	1.400

STONING HAMMER WITH WOODEN HICKORY HANDLE

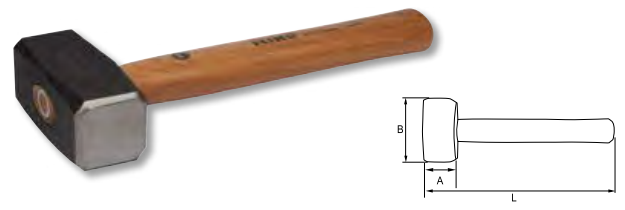

- Handle wedged to club hammer head

R	Icon	g	A mm	B mm	L mm	g
531-05-2	6	1.000	40	95	260	1.155
531-07-2	6	1.250	43	100	260	1.405
531-08-2	4	1.500	45	110	280	1.675
531-09-2	2	2.000	50	120	300	2.235

SPARE WOODEN HICKORY HANDLE FOR STONING HAMMERS



- Served with corresponding wedges

R	Icon	g	
530-13-2	12	530-03-2	145
530-15-2	12	530-05-2 / 530-07-2	159

SPARE WOODEN HICKORY HANDLE FOR STONING HAMMERS



- Served with corresponding wedges

R	Icon	g	
531-15-2	12	531-05-2	165
531-17-2	12	531-07-2	168
531-18-2	12	531-08-2	205
531-19-2	12	531-09-2	231

BLACK RUBBER MALLET

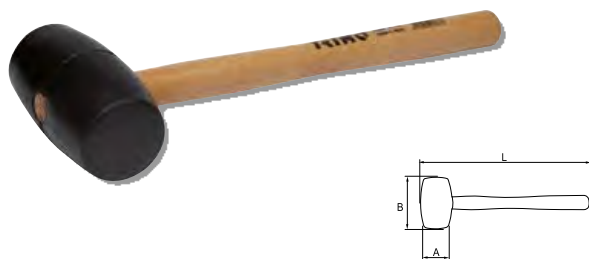

- Handle wedged to club hammer head

R	Icon	A mm	B mm	L mm	g
529251	1	55	90	320	250
529261	1	65	115	340	440
529271	1	75	125	360	600
529291	1	90	139	360	720

ANTI-BOUNCE NYLON FACED HAMMERS



- Wooden handle

R		S mm	A mm	L mm	
529611	6	35	115	370	500
529621	6	50	120	390	1.000
529631	6	60	125	420	1.560



- Anti-bounce nylon tips

R		A mm	L mm	
529701	6	25	35	20
529711	6	28	50	50
529721	6	30	60	60



- Anti-bounce hammer handle

R			
529801	1	529611	90
529811	1	529621	140
529821	1	529631	215

NYLON FACED HAMMERS



- Metal handle, rubber grip

R		S mm	A mm	L mm	
529021	6	28	80	255	325
529031	6	35	100	285	650
529041	6	44	125	300	1.105

NYLON FACED HAMMERS



- Wooden handle

R		S mm	A mm	L mm	
529151	6	22	65	215	145
529161	6	28	80	270	260
529171	6	35	100	295	500
529181	6	44	125	345	1.010
529191	6	55	140	380	1.480



- Spare tips for nylon faced hammers

R		A mm	L mm	Ø mm	
529061	10	12	22	8	10
529071	10	19	28	9	15
529081	10	22	35	10	20
529091	10	27	44	13	50
529101	10	32	55	16	80



- Spare handle for nylon faced hammers

R			
529751	1	529151	50
529761	1	529161	70
529771	1	529171	100
529781	1	529181	150
529791	1	529191	170



CHISELS

CHISEL SET, 3 pieces



- General purpose bevel edge wood chisels
- Mono-material polypropylene handle
- High quality Cr-V 58-62 HRC steel blades hardened for long-lasting performance
- Ground blades
- Fitted with a tip protector

805-3-C	1	3	12, 18, 25 mm	589

WOOD CARVING SET, 6 pieces



- Carving chisel set, 6 pieces
- Rubberwood handle
- High quality chrome vanadium steel blades
- Hardness at least up to 55 HRC for durability and easy maintenance
- Black oxide finish and anti-rust oil for protection of rust
- Length of chisels: 160 mm

806-6-B	1	6	160	221

	1 piece square chisel, 12 mm
	1 piece skene chisel, 12 mm
	1 piece curved gouge, 6.5 mm
	1 piece straight gouge, 5 mm
	1 piece curved flat, 5 mm
	1 piece curved U tool, 12 mm

A woman in a blue lab coat and safety glasses is working on a circuit board in a factory setting. She is wearing white gloves and using red-handled pliers to work on the board. The background is a blurred industrial environment with shelves and equipment.

09.

PLIERS –
SCISSORS & KNIVES

PLIERS

MADE TO LAST

Universal

for holding and cutting objects with steadiness.

Versatile

with cutting capacity in semi-hard wires from
 $\varnothing 1,60-2,00-2,50$ mm &
 Copper wires $\varnothing 1$ mm.

Antislippery handle

with rubber and hard plastic provides a perfect
 combination for grip in your hand.





Hardened

cutting edges for more exigent tasks.

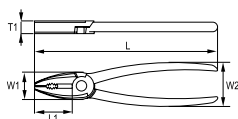

COMBINATION PLIERS



		L mm	L1 mm	W1 mm	W2 mm	T1 mm	 1 mm	 2 mm	
601-160-1	5	160	35	24	50	10	$\varnothing 1.0$ mm	$\varnothing 1.6$ mm	190
601-180-1	5	180	38	27	50	10	$\varnothing 1.0$ mm	$\varnothing 2.0$ mm	240
601-200-1	5	197	41.5	29.5	50	10	$\varnothing 1.0$ mm	$\varnothing 2.5$ mm	300

SIDE CUTTING PLIERS

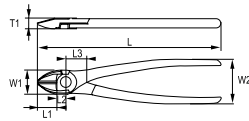

- High performance steel
- Hardness: edges hardened to 60-65 HRc
- Standard: ISO 5749
- Cutting capacity:
 - 1- Bronze wire: 0.50 mm
 - 2- Medium hard wire: 1.60 mm

Code	Q	Box	L mm	L1 mm	L2 mm	L3 mm	W1 mm	W2 mm	T1 mm	1 mm	2 mm	g
624-140-1	5		142	20.5	6	12	18.6	50	10	Ø 0.5 mm	Ø 1.6 mm	170
624-160-1	5		160	21.5	7	13	21.6	50	11.5	Ø 0.5 mm	Ø 1.6 mm	200
624-180-1	5		176	24.5	7	14	25.6	50	12.5	Ø 0.5 mm	Ø 1.6 mm	250

SIDE CUTTING PLIERS

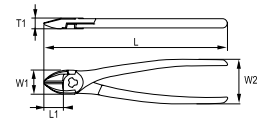

- High performance steel
- Hardness: edges at 60-65 HRc
- Standard: ISO 5749
- Cutting capacity:
 - 1- Bronze wire: 0.50 mm
 - 2- Medium hard wire: 1.80-2.00 mm

Code	Q	Box	L mm	L1 mm	W1 mm	W2 mm	T1 mm	1 mm	2 mm	g
625-180-1	5		180	20.5	25.6	49	11.5	Ø 0.5 mm	Ø 1.8 mm	280
625-200-1	5		206	23	30	54	12	Ø 0.5 mm	Ø 2.0 mm	320

SNIPE NOSE PLIERS

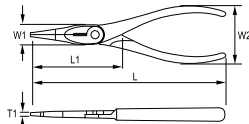

- High performance steel
- Hardness: edges at 58-65 HRc
- Standard: ISO 5745
- Cutting capacity:
 - 1- Bronze wire: 1.00 mm
 - 2- Medium hard wire: 1.60 mm

Code	Q	Box	L mm	L1 mm	W1 mm	W2 mm	T1 mm	1 mm	2 mm	g
612-160-1	5		161	61.5	16.5	49	10	Ø 1.0 mm	Ø 1.6 mm	140
612-200-1	5		201	78	18	50	10.5	Ø 1.0 mm	Ø 1.6 mm	180

SNIPE NOSE PLIERS BENT TIP

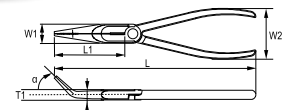

- High performance steel
- Hardness: edges at 58-65 HRc
- Angled at 45°
- Standard: ISO 5745
- Cutting capacity:
 - 1- Bronze wire: 1.00 mm
 - 2- Medium hard wire: 1.60 mm

Code	Q	Box	L mm	L1 mm	W1 mm	W2 mm	T1 mm	α	1 mm	2 mm	g
613-160-1	5		158	48	18	50	9.0	45°	Ø 1.0 mm	Ø 1.6 mm	132
613-200-1	5		197	74	18	50	10.5	45°	Ø 1.0 mm	Ø 1.6 mm	180

FLAT NOSE PLIERS

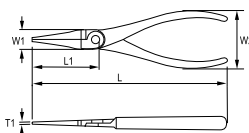

- High performance steel
- Hardness: 45-50 HRc
- Standard: ISO 5745

Code	Q	Box	L mm	L1 mm	W1 mm	W2 mm	T1 mm	g
604-160-1	5		158	48	17	48	9	150
604-180-1	5		180	50	20	50	11	175



PLIERS

ROUND NOSE PLIERS

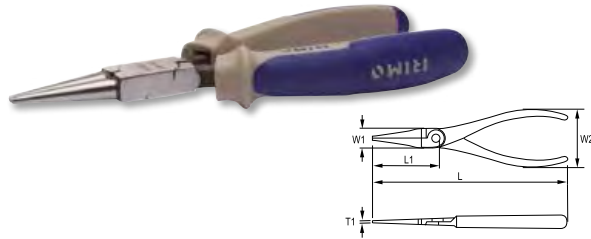

- High performance steel
- Hardness: 45-50 HRC
- Standard: ISO 5745

R	Icon	L mm	L1 mm	W1 mm	W2 mm	T1 mm	g
608-160-1	5	158	38	17	48	8.5	150

SLIP JOINT PLIERS



- High performance steel
- Hardness: teeth hardened to 50-57 HRC
- Standard: ISO 8976

R	Icon	L mm	W1 mm	W2 mm	W3 mm	T1 mm	T2 mm	g
634-200-1	5	175	5.8	35.8	41	7	12	170
634-250-1	5	240	5	47.5	50	7.5	12.5	320
634-300-1	5	302	3	52.5	59.6	8	14.5	430

QUICK ADJUST SLIP JOINT PLIERS



- With button for a quick adjustment
- High performance steel
- Hardness: teeth hardened to 50-57 HRC
- Standard: ISO 8976

R	Icon	L mm	W1 mm	W2 mm	W3 mm	T1 mm	T2 mm	g
634Q-250-1	5	240	5	47.5	50	7.5	12.5	320

PLIERS SETS

PLIERS SETS



- High performance steel
- Bi-material handles

R	Icon	Icon	Icon	g
601-3-C	1	3	270 x 205 x 40	690

601-180-1	
624-160-1	
612-200-1	

PLIERS SETS



- High performance steel
- Bi-material handles

R	Icon	Icon	Icon	g
602-3-C	1	3	270 x 205 x 40	850

601-180-1	
624-160-1	
634-250-1	

MINI PLIERS

MINI COMBINATION PLIERS

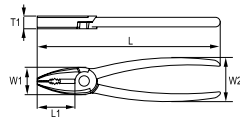

- Mini combination pliers for fine assembly work in electronics and fine mechanics
- With gripping zones for flat and round material, suitable for versatile use
- With cutting edge for soft wire
- Cutting edge hardness: 58-65 HRC
- Soft grip bimaterial handles provide comfort and control
- Equipped with a return spring
- High performance alloy steel
- Standard: ISO 9655
- Cutting capacity:
 - 1- Min. cutting capacity Cu: 0.5 mm
 - 2- Max. cutting capacity medium hard wire: 0.8 mm

Part No.	PK	L mm	L1 mm	W1 mm	W2 mm	T1 mm	1 mm	2 mm	g
601M-125-1	5	120	22	15	85	7	0.5	0.8	60

MINI FLAT NOSE PLIERS

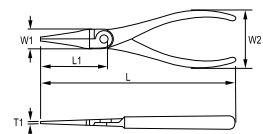

- Mini flat nose pliers for fine assembly work in electronics and fine mechanics
- Smooth jaws for gripping, holding and bending delicate components
- Hardness: 42-50 HRC
- Soft grip bimaterial handles provide comfort and control
- Equipped with a return spring
- High performance alloy steel
- Standard: ISO 9655

Part No.	PK	L mm	L1 mm	W1 mm	W2 mm	T1 mm	g
604M-125-1	5	130	27	12	85	8	89

MINI SNIPE NOSE PLIERS

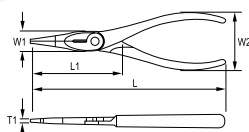

- Mini snipe nose pliers for fine assembly work in electronics and fine mechanics
- With serrated jaws for a better grip
- With cutting edge for soft wire
- Cutting edge hardness: 58-65 HRC
- Soft grip bimaterial handles provide comfort and control
- Equipped with a return spring
- High performance alloy steel
- Standard: ISO 9655
- Cutting capacity:
 - 1- Min. cutting capacity Cu: 0.5 mm
 - 2- Max. cutting capacity medium hard wire: 0.8 mm

Part No.	PK	L mm	L1 mm	W1 mm	W2 mm	T1 mm	1 mm	2 mm	g
612M-125-1	5	130	27	12	85	8	0.5	0.8	86

MINI SIDE CUTTING PLIERS

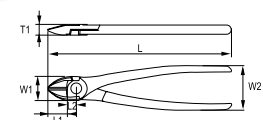

- Mini side cutting pliers for fine cutting work in electronics and fine mechanics
- With induction hardened cutting edge for soft and hard wire
- Oval head design
- Cutting edge hardness: 58-65 HRC
- Soft grip bimaterial handles provide comfort and control
- Equipped with a return spring
- High performance alloy steel
- Standard: ISO 9654
- Cutting capacity:
 - 1- Min. cutting capacity Cu: 0.5 mm
 - 2- Max. cutting capacity medium hard wire: 0.8 mm

Part No.	PK	L mm	L1 mm	W1 mm	W2 mm	T1 mm	1 mm	2 mm	g
624M-125-1	5	120	16	12	85	8	0.5	0.8	81



MINI PLIERS

MINI END CUTTING PLIERS



- Mini end cutting pliers for fine cutting work in electronics and fine mechanics
- With induction hardened cutting edge for soft and hard wire
- Cutting edge hardness: 58-65 HRC
- Soft grip bimaterial handles provide comfort and control
- Equipped with a return spring
- High performance alloy steel
- Standard: ISO 9654
- Cutting capacity:
 - 1- Min. cutting capacity Cu: 0.5 mm
 - 2- Max. cutting capacity medium hard wire: 0.8 mm

R	A	B	C	D	E	F	G	1mm	2mm	g	
626M-125-1	5	110	8	16	10	3	3	9	0.5	0.8	81

PLIERS FOR ELECTRICIANS

STRIPPING PLIERS

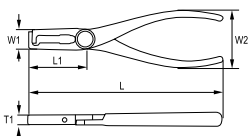

- High performance steel
- Hardness: 45-50 HRC

R	L	L1	W1	W2	T1	T	g	
629-160-1	5	160	40.5	19	48	9	1-6	170

COPPER ALUMINIUM WIRE CUTTER



- Wire cutting and stripping pliers for copper and aluminium
- Finish: Forged surfaces are black finished and mirror polished
- Material: Carbon steel, PVC coated handles

R	L	L1	W1	T1	T	g		
655-160-1	5	160	25	25	10	50/35	10	160
655-200-1	5	200	28	30	12	70/50	13	280

CRIMPING PLIER INSULATED TERMINALS



- Pliers made of thick metal steel sheet and working areas are hardened
- Lightweight, occupy small volume and are easy to carry in the toolbox
- Suitable for crimping, cutting and stripping operations
- Crimping terminals: 1.5/2.5/6 mm²
- Cutting: M2.6-M5.0
- Stripping: 0.75-6.0 mm²

		L	A	C						
		mm	mm	mm	mm ²	AWG	mm ²	AWG	mm ²	g
630-B1-1	12	220	38	3	1.5-6.0	20-10	0.75-6.0	20-10	0.75-6.0	220

CRIMPING PLIER NON-INSULATED TERMINALS



- Pliers made of thick metal steel sheet and working areas are hardened
- Lightweight, occupy small volume and are easy to carry in the toolbox
- Suitable for crimping, cutting and stripping operations
- Crimping terminals: 1.5/2.5/6 mm²
- Cutting: M2.6-M5.0
- Stripping: 0.75-6.0 mm²

		L	A	C						
		mm	mm	mm	mm ²	AWG	mm ²	AWG	mm ²	g
630-B2-1	12	220	38	3	1.5-6.0	14-10	0.75-6.0	18-12	0.75-6.0	220

CRIMPING PLIER NON-INSULATED FASTON TYPE TERMINALS



- Pliers made of thick metal steel sheet and working areas are hardened
- Lightweight, occupy small volume and are easy to carry in the toolbox
- Suitable for crimping, cutting and stripping operations
- Crimping terminals: 1.5/2.5/6 mm²
- Cutting: M2.6-M5.0
- Stripping: 0.75-6.0 mm²

		L	A	C						
		mm	mm	mm	mm ²	AWG	mm ²	AWG	mm ²	g
630-B3-1	12	220	38	3	1.5-6.0	14-10	0.75-6.0	18-12	0.75-6.0	220

CRIMPING PLIER INSULATED TERMINALS SET



- Pliers made of thick metal steel sheet and working areas are hardened
- Lightweight, occupy small volume and are easy to carry in the toolbox
- Suitable for crimping, cutting and stripping operations
- 60 insulated terminals and crimping pliers are included in the set
- Crimping terminals: 1.5/2.5/6 mm²
- Cutting: M2.6-M5.0
- Stripping: 0.75-6.0 mm²

630-61B1-4	1	60 + 1	24x160x270		370

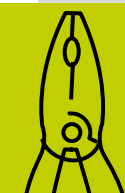

PLIERS FOR ELECTRICIANS

INSULATED END SLEEVES AND PLUG CONNECTORS SET, 295 pieces



- Plastic box with compartments
- Contents:
 - 45 pcs insulated end sleeves with different diameters
 - 250 pcs insulated plug connectors with different shapes and diameters

630-295T-4	1	295	30 x 115 x 220	250

CRIMPING PLIER SET WITH INTERCHANGEABLE JAWS



* **Compatible for solar panel connectors MC4**

- Blow molded case
- Strong ratcheting plier with bimaterial handles for a perfect grip
- Contents:
 - Jaw for non-insulated open barrel terminals 0.5-6 mm² / AWG 22-10
 - Jaw for insulated terminals 0.5-6 mm² / AWG 22-10
 - Jaw for non-insulated twin cord end terminals 6-16 mm² / AWG 10-6
 - Jaw for cord end terminals 4-35 mm² / AWG 10-35
 - Jaw for non-insulated terminals 0.5-10 mm² / AWG 22-8

630-5HD-4	1	5	60 x 250 x 290	450

INSULATED PLIERS

INSULATED COMBINATION PLIERS

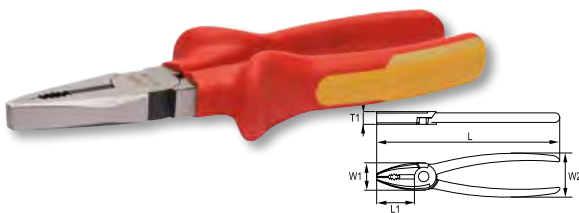

- For work on live equipment, up to 1000V
- High performance steel
- Hardness: edges at 58-65 HRC
- Standard: ISO 5746
- Cutting capacity:
 - 1- Bronze wire: 1.00 mm
 - 2- Medium hard wire: 1.60-2.00-2.50 mm

		L mm	L1 mm	W1 mm	W2 mm	T1 mm			
601V-160-1	5	160	35	24	50	10	Ø 1.0 mm	Ø 1.6 mm	190
601V-180-1	5	180	38	27	50	10	Ø 1.0 mm	Ø 2.0 mm	240
601V-200-1	5	197	41.5	29.5	50	11	Ø 1.0 mm	Ø 2.5 mm	300

INSULATED FLAT NOSE PLIER

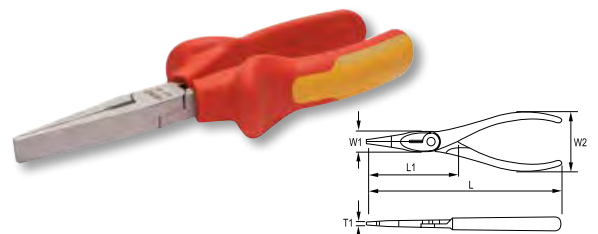

- For work on live equipment, up to 1000V
- High performance steel
- Hardness: edges at 58-65 HRC
- Standard: ISO 5745

		L mm	L1 mm	W1 mm	W2 mm	T1 mm	
604V-160-1	5	158	48	17	50	9	150

INSULATED SNIPE NOSE PLIERS

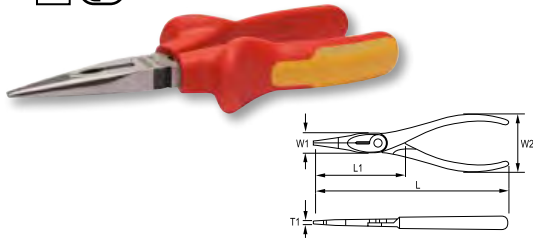

- High performance steel
- Hardness: edges at 58-65 HRC
- Standard: ISO 5746
- Cutting capacity:
 - 1- Bronze wire: 1.00 mm
 - 2- Medium hard wire: 1.60 mm

Q	Icon	L	L1	W1	W2	T1	Icon	Icon	g
		mm	mm	mm	mm	mm	1 mm	2 mm	
612V-160-1	5	161	61.5	16.5	49	10	Ø 1.0 mm	Ø 1.6 mm	140
612V-200-1	5	201	78	18	50	10.5	Ø 1.0 mm	Ø 1.6 mm	180

INSULATED SNIPE NOSE PLIERS BENT TIP

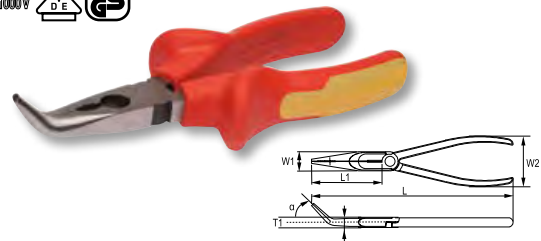

- For work on live equipment, up to 1000V
- High performance steel
- Hardness: edges at 58-65 HRC
- Angled at 45°
- Standard: ISO 5746
- Cutting capacity:
 - 1- Bronze wire: 1.00 mm
 - 2- Medium hard wire: 1.60 mm

Q	Icon	L	L1	W1	W2	T1	α	Icon	Icon	g
		mm	mm	mm	mm	mm	°	1 mm	2 mm	
613V-160-1	5	158	50	18	18	9.0	45°	Ø 1.0 mm	Ø 1.6 mm	132
613V-200-1	5	197	74	18	50	10.5	45°	Ø 1.0 mm	Ø 1.6 mm	180

INSULATED SIDE CUTTING PLIERS

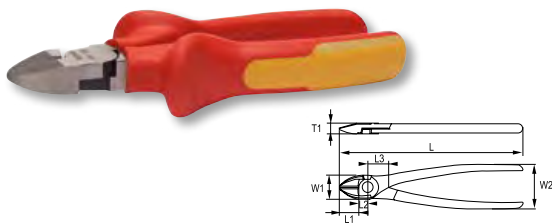

- For work on live equipment, up to 1000V
- High performance steel
- Hardness: edges at 60-65 HRC
- Standard: ISO 5749
- Cutting capacity:
 - 1- Bronze wire: 0.50 mm
 - 2- Medium hard wire: 1.60 mm

Q	Icon	L	L1	L2	L3	W1	W2	T1	Icon	Icon	g
		mm	mm	mm	mm	mm	mm	mm	1 mm	2 mm	
624V-140-1	5	142	20.5	7	13	18.6	50	10.0	Ø 0.5 mm	Ø 1.6 mm	170
624V-160-1	5	155	21.5	7	13	21.6	50	11.5	Ø 0.5 mm	Ø 1.6 mm	200

INSULATED HEAVY DUTY SIDE CUTTING PLIERS

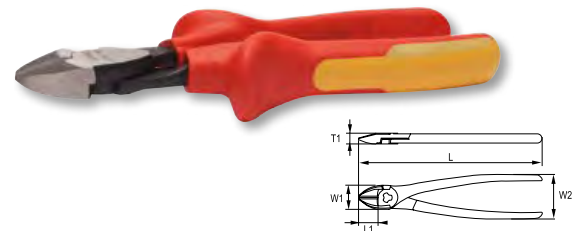

- For work on live equipment, up to 1000V
- High performance steel
- Hardness: edges at 60-65 HRC
- Standard: ISO 5749
- Cutting capacity:
 - 1- Bronze wire: 0.50 mm
 - 2- Medium hard wire: 1.80 mm

Q	Icon	L	L1	W1	W2	T1	Icon	Icon	g
		mm	mm	mm	mm	mm	1 mm	2 mm	
625V-180-1	5	180	20.5	25.6	49	11.5	Ø 0.5 mm	Ø 1.8 mm	280



INSULATED PLIERS

INSULATED STRIPPING PLIERS

IEC 60900

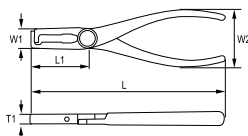

- For work on live equipment, up to 1000V
- High performance steel
- Hardness: 45-50 HRC

629V-160-1	5	160	40.5	19	48	9	1-6	170
------------	---	-----	------	----	----	---	-----	-----

INSULATED SLIP JOINT PLIERS

IEC 60900



- For work on live equipment, up to 1000V
- High performance steel
- Hardness: teeth hardened to 50-57 HRC
- Standard: ISO 8976

634V-250-1	5	240	5	47.5	50	7.5	12.5	310
------------	---	-----	---	------	----	-----	------	-----

INSULATED PLIERS SETS

INSULATED PLIERS SET

IEC 60900



- For work on live equipment, up to 1000V
- High performance steel
- Standard: IEC 60900

601V-3-C	1	3	270 x 205 x 40	690
----------	---	---	----------------	-----

624V-160-1		601V-180-1	
------------	--	------------	--

612V-200-1	
------------	--

PINCERS AND FENCING PLIERS

CARPENTER'S PINCERS

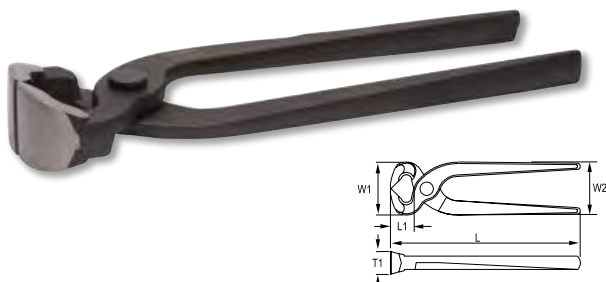

- Hardness: teeth hardened at 58-64 HRc
- Standard: ISO 5746
- Cutting capacity: Medium hard wire: 1.60 mm

Code	PK	L mm	L1 mm	W1 mm	W2 mm	T1 mm	Wire	g
631-200-1	5	200	23	53	45	24	1.6 mm	360

FENCING PLIERS

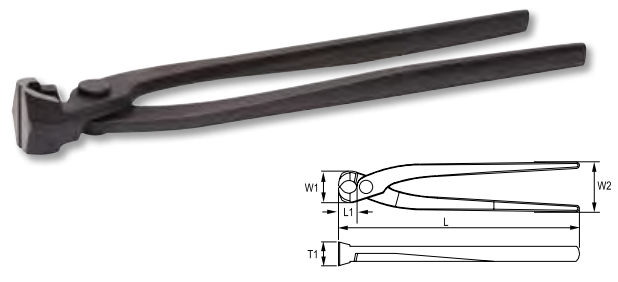

- Hardness: teeth hardened to 58-64 HRc
- Standard: ISO 9242
- Cutting capacity: Medium hard wire: 1.60 mm

Code	PK	L mm	L1 mm	W1 mm	W2 mm	T1 mm	Wire	g
632-220-1	5	220	16	29.4	46	22	1.6 mm	350
632-250-1	5	250	18	33	46	24.5	1.6 mm	400
632-280-1	5	280	19	37	48	24.5	1.6 mm	460

FENCING PLIERS WITH PVC DIPPED HANDLES

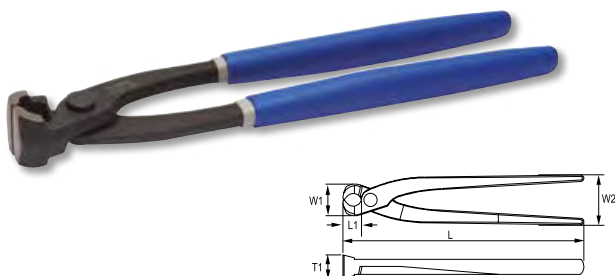

- High performance steel
- Blue dipped handles
- Hardness: teeth hardened to 58-64 HRc
- Standard: ISO 9242
- Cutting capacity 1.6 mm

Code	PK	L mm	L1 mm	W1 mm	W2 mm	T1 mm	Wire	g
632D-250-1	5	250	18	33	46	24.5	1.6 mm	400

BOLT CUTTERS

BOLT CUTTERS



- High performance alloy steel
- Double heat treatment on the blades
- Black finish

Code	PK	L mm	A mm	B mm	Ø 80 kg/mm²	Ø 160 kg/mm²	Ø 120 kg/mm²	g	
651101	1	N.0	320	48	77	5	4	3	500
651111	1	N.1	470	66	104	7	6	5	1.785
651121	1	N.2	630	85	137	9	8	7	2.860
651131	1	N.3	750	100	160	11	9	8	4.410
651141	1	N.4	900	120	182	13	10	9	5.800

SPARE HEAD BOLT CUTTER



Code	PK	Code	PK	L mm	A mm	B mm	g
651201N	1	651201N2	1	651101	48	77	180
651211N	1	651211N2	1	651111	66	104	370
651221N	1	651221N2	1	651121	85	137	875
651231N	1	651231N2	1	651131	100	160	1.295
651241N	1	651241N2	1	651141	120	182	1.930

CIRCLIP PLIERS

INTERNAL STRAIGHT



- Black finish for corrosion protection
- High performance alloy steel
- Straight forged tips
- Hardness: 45-50 HRc
- Standard: DIN 5256

R	Icon	L mm	B mm	E mm	Icon	Icon	g
621551	5	140	38	0.8	8 - 13	1	80
621561	5	140	38	1.2	12 - 25	1	80
621571	5	180	57	1.7	19 - 60	1	170
621581	5	225	69	2.2	40 - 100	1	275
621591	1	310	95	3.1	85 - 165	1	490

INTERNAL BENT TIP



- Black finish for corrosion protection
- High performance alloy steel
- Curved forged tips
- Hardness: 45-50 HRc
- Standard: DIN 5256

R	Icon	L mm	B mm	E mm	Icon	Icon	g
621651	5	127	25	0,8	8 - 13	1	80
621661	5	127	25	1,2	12 - 25	1	80
621671	5	165	43	1,7	19 - 60	1	170
621681	5	208	52	2,2	40 - 100	1	275
621691	1	289	74	3,1	85 - 165	1	490

EXTERNAL STRAIGHT



- Black finish for corrosion protection
- High performance alloy steel
- Straight forged tips
- Internal spring
- Hardness: 45-50 HRc
- Standard: DIN 5254

R	Icon	L mm	B mm	E mm	Icon	Icon	g
621751	5	140	38	0.8	3 - 10	1	80
621761	5	140	38	1.2	10 - 25	1	80
621771	5	180	57	1.7	19 - 60	1	170
621781	5	225	69	2.2	40 - 100	1	275
621791	1	295	95	3.1	85 - 165	1	490

EXTERNAL BENT



- Black finish for corrosion protection
- High performance alloy steel
- Bent forged tips
- Internal spring
- Hardness: 45-50 HRc
- Standard: DIN 5254

R	Icon	L mm	B mm	E mm	Icon	Icon	g
621851	5	127	25	0.8	3 - 10	1	80
621861	5	127	25	1.2	10 - 25	1	80
621871	5	165	43	1.7	19 - 60	1	170
621881	5	208	52	2.2	40 - 100	1	275
621891	1	295	74	3.1	85 - 165	1	490

CIRCLIP PLIERS SET



- Black finish for corrosion protection
- High performance alloy steel
- Forged tips
- Hardness: 45-50 HRc

R	Icon	Icon	Icon	g
601911	1	4	260 x 220 x 30	750

621571	Icon	Icon	621671	Icon	Icon
621771	Icon	Icon	621871	Icon	Icon

LOCKING PLIERS

UNIVERSAL, CURVED JAWS WITH WIRE CUTTER



- General purpose, holds bars and sheets, nuts and bolts
- Strong jaws, drop forged
- Chrome molybdenum steel
- Nickel plated

Q		A mm	B mm	C mm	D mm	E mm	F mm	G mm		g
64A-190-1	1	190	31	40	12	0-20	7	5	338	358
64A-235-1	1	225	38	48	12	0-35	7	6	543	556

UNIVERSAL, STRAIGHT JAWS



- Holds metal sheet, small bars and thin pieces
- Strong jaws, reinforced. Drop forged
- Chrome molybdenum steel
- Nickel plated

Q		A mm	B mm	C mm	D mm	E mm	F mm	g
64B-190-1	1	190	29	42	15	0-17	13	358
64B-235-1	1	225	32	54	17	0-21	13	556

LONG NOSE



- Long reach jaws. Drop forged
- Jaws have flat and round holding shapes
- Chrome molybdenum steel
- Nickel plated

Q		A mm	B mm	C mm	D mm	E mm	F mm	g
64L-165-1	1	165	52	25	9	6	0-18	195

WELDING



- U shape jaws provides accessibility and good vision in welding jobs
- Jaws beam-shaped to increase strenght
- Chrome molybdenum steel
- Nickel plated

Q		A mm	B mm	C mm	D mm	E mm	F mm	g
64W-300-1	1	263	75	70	75	70	44	832

STEEL CLAMP



- C shape to hold bulky parts
- Chrome vanadium steel
- Nickel plated

Q		A mm	B mm	C mm	D mm	E mm	F mm	g
64C-300-1	1	275	90	140	14	0-65	7	775



LOCKING PLIERS

STEEL CLAMP, SWIVEL PADS



- C shape to hold bulky parts
- Swivel pads to hold non parallel and uneven parts
- Chrome vanadium steel
- Nickel plated

R		A mm	B mm	C mm	D mm	E mm	F mm	g
64CA-175-1	1	175	61	90	21	0-32	5	276
64CA-300-1	1	280	95	130	28	0-72	7	835
64CA-450-1	1	460	270	150	28	0-130	7	1280

STEEL CLAMP, SWIVEL PADS, SLIM



- Long reach
- Swivel pads to hold non parallel and uneven parts
- Chrome molybdenum steel
- Nickel plated

R		A mm	B mm	C mm	D mm	E mm	F mm	g
64CAD-300-1	1	282	97	81	28	0-72	7	850

TABLE C CLAMP

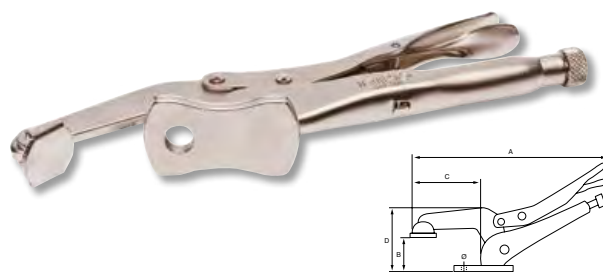

- Swivel pad to hold non parallel and uneven parts
- Hidden lever to avoid unwanted unlocking
- Chrome molybdenum steel
- Nickel plated

R		A mm	B mm	C mm	D mm	Ø mm	g
64T-300-1	1	300	0-80	95	90	12.4	650

4 POSITION PLIERS



- Chrome-plated for good rust protection
- Shape: with flat and convex jaws that can be adjusted in 4 different positions for an increased gripping capacity
- Application: holds most L, T and U profiles
- Retail packed

R		A mm	B mm	C mm	D mm	E mm	F mm	g
647-235-1	1	235	37	59	17	10	15	540

4 POSITION PLIERS



- Chrome-plated for good rust protection
- Shape: with flat and convex jaws that can be adjusted in 4 different positions for an increased gripping capacity
- Extra long jaws with twice as large gripping capacity compared to standard model
- Application: holds most L, T and U profiles
- Retail packed

R		A mm	B mm	C mm	D mm	E mm	F mm	g
647-250-1	1	255	67	64	17	10	15	650

CURVED JAWS WITH CUTTER



- Chrome vanadium steel. Chrome-plated
- Shape: curved jaws for general purpose
- Soft grip two-component handle

Q	Icon	L mm	C mm	Jaw width mm	g
648-140-1	1	140	7	28	160
648-185-1	1	185	8.5	41	345
648-250-1	1	225	10.5	48	525

LONG NOSE



- Chrome vanadium steel. Chrome-plated
- Shape: long slim jaw design
- Soft grip two-component handle

Q	Icon	L mm	C mm	Jaw width mm	g
648-165-1	1	165	4.2	57	180

SOFT GRIP PLIERS SET



- Two-component handle
- Rolling nylon pouch

Q	Icon	Icon	g
648-4-W	1	4	1.200
648-140-1, 648-185-1, 648-250-1			
648-165-1			

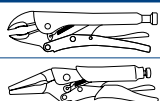

AUTOMATIC HAND VICES

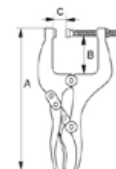

- Finish: black
- Shape: locking clamp with movable jaw for increased flexibility and general purpose work
- Application: for production or maintenance applications and general purpose work

Q	Icon	A mm	B mm	C mm	Icon	Icon	Icon	g
645011	1	193	30	32	645-L075	645-YOKE	645-NUT	690
645021	1	196	30	70	645-L120	645-YOKE	645-NUT	765
645031	1	240	62	70	645-L120	645-YOKE	645-NUT	935
645041	1	240	62	150	645-L200	645-YOKE	645-NUT	1.180



RIVETING TOOLS

HAND RIVETER



- Riveter with four different exchangeable heads for rivet sizes of 1.8-2.2-2.8-3.2 mm
- To be used with aluminium, steel, stainless steel and copper rivets
- Includes a wrench for changing heads

R		L mm	A mm	B mm	g
546-265-1	1	265	90	25	700



546-265-A



546-265-B

R	Spares for hand riveter 546-265-1		
546-265-A	Jaw mechanism		1
546-265-B	Mouthpieces set		1

NUT RIVETER SET



- To create a threaded fixing where there is little or no access to the rear of a panel
- Supplied with the inserts for the different rivet nut sizes as well as the necessary tools to assemble and disassemble those inserts
- To be used with aluminium, steel and stainless steel nuts of M3-M4-M5-M6

R		L mm	A mm	B mm	g
548-275-1	1	270	100	23	700



R	Spares for hand riveter 548-275-1		
548-275-M3	M3 insert		1
548-275-M4	M4 insert		1
548-275-M5	M5 insert		1
548-275-M6	M6 insert		1

2 ARM RIVETER



- Riveter with long handles for greater leverage
- To be used with aluminium, steel and stainless rivets
- The transparent tube collects snapped off rivet tails

R		A mm	B mm	C mm	D mm	g
546021	1	520	22	58	160	1.800



546211



546251

R	Spare parts 546021	
546201	Nosepiece of Ø 4 mm	
546211	Nosepiece of Ø 5 mm	
546221	Nosepiece of Ø 6-6.4 mm	
546251	3 jaws set	
1467-A01	Transparent tube	

HAND RIVETER SET WITH RIVETS



- 265 mm riveter with four different exchangeable heads for rivet sizes of 2.4 mm; 3.0-3.2 mm; 4.0 mm and 4.8 mm
- Includes a wrench for changing heads
- To be used with aluminum, steel, stainless steel and copper rivets
- 160 rivets (40 of each size)
- Blow molded case

R				g
546-265-4	1	160	300x210x60	1.200

ELECTRICIAN'S SCISSORS AND KNIVES

9 MM SNAP OFF KNIFE

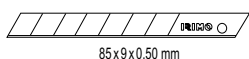

667-135-1	12	133	56

18 MM SNAP OFF KNIFE

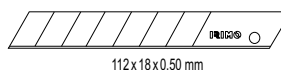

666-156-1	12	157	106

SAFETY UTILITY KNIFE



- Autoretractil blade for safety purposes

668-150-1	12	150	157

SAFETY UTILITY KNIFE



- Auto retractil blade when cutting is finished and operation button is released
- Easy Open System (EOS)

669-175-1	10	175	210

GLASS SCRAPER WITH INTERCHANGEABLE BLADES

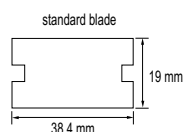

- Ideal for removing paint, glue, putty or stickers from glass, tile, walls, floors and other smooth surfaces
- Ergonomic two-component design for comfortable no-slip grip
- Blade retracts for safe storage
- Internal storage compartment (includes 5 blades)
- Good size to fit in the palm of your hand. Scraper length 130 mm
- Uses standard sing-edge razor blades. Blade width: 40 mm

538-140-1	1	135	65

MULTIPURPOSE TRADESMAN KNIVES WITH SHEATH

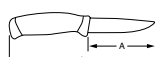

- Comfortable handle provides excellent grip
- Supplied with a practical sheath for belt carrying
- Robust multipurpose knife with a solid stainless steel blade

672-220-1	12	100	220	233



ELECTRICIAN'S SCISSORS AND KNIVES

FOLDABLE KNIFE



- 3Cr13 Stainless Steel
- Retail pack
- Light and comfortable
- Belt clip included
- Strong cutting tool
- Blade thickness 2.3 mm

R	Icon	A mm	L mm	g
670-178-1	10	78	178	120

FOLDABLE KNIFE



- Black 3Cr13 Stainless Steel
- Retail packaging
- Black finishing
- Comfortable and strong cutting tool
- Belt clip included
- Blade thickness 2.6 mm

R	Icon	A mm	L mm	g
669-190-1	10	77	190	130

ELECTRICIANS' KNIFE



- Electrician's pocket folding knife
- Wire stripping shape with wooden handle

R	Icon	A mm	L mm	g
664-200-1	10	85	200	83

ELECTRICIANS' KNIFE



- Electrician's pocket folding knife
- Stainless steel blade with plastic handle
- Wire stripping shape

R	Icon	A mm	L mm	g
665-200-1	10	85	200	60

MULTITOOL



- Foldable Knife
- 3Cr13 Stainless Steel
- Comes with clip
- Length: 96 mm closed / 150 mm overall
- Pouch included for easy transport
- Multi tool for all purposes with:
 - Needle Nose Pliers
 - Wire cutter
 - Slotted Screwdriver
 - Medium Slotted Screwdriver
 - Wood / Metal File
 - Bottle opener
 - Phillips Screwdriver
 - Regular Pliers
 - Can Opener
 - Small Slotted Screwdriver
 - Saw
 - Large slotted screwdriver
 - Slotted Screwdriver
 - Scissors

R	Icon	L mm	g
671-150-1	10	150 (96)	255

ELECTRICIANS' SCISSORS



- Electrician's scissors with plastic coated finger loops
- Small groove in the blade for stripping cables
- 43 mm Cutting length

IRIMO	Icon	A mm	L mm	g
661051	10	42.5	130	70

ELECTRICIANS' SCISSORS



- Electrician's scissors with longer handles, plastic coated finger loops
- Small groove in the blade for stripping cables
- Better access to confined spaces
- Requiring less cutting force
- 38 mm cutting length

IRIMO	Icon	A mm	L mm	g
661061	10	38	152	130

ELECTRICIANS' SCISSORS



- Electrician's scissors with plastic coated finger rings
- Professional use. Integrate steel structure
- Micro serrated blade
- 43 mm cutting length
- Rotary belt holster

IRIMO	Icon	A mm	L mm	g
661-140-1	12	43	145	76



- Display for 12 scissors

IRIMO	Icon	g
661-140-12-DISP	1	

HOOKS AND PICKING TOOLS

MINI PICK AND HOOK SET, 4 pieces



- Used for scratching, manipulating or removing O-rings, springs, welding,...
- 170 mm length
- Two-component Soft grip handle
- Material: Carbon steel blades, hardened tips
 - 1 pc straight pick,
 - 1 pc angle hook,
 - 1 pc full hook,
 - 1 pc 90° hook

IRIMO	Icon	Icon	Icon	g
722-4-1	12	4	20x230x130	100





10.

PULLING TOOLS

PULLERS

UNIVERSAL 2 ARM PULLERS

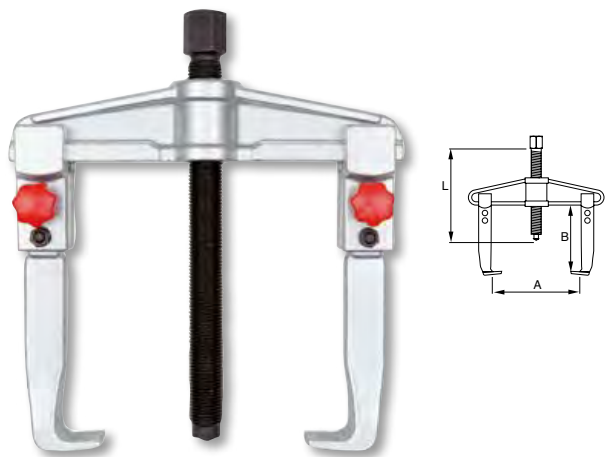

- Body and arms manufactured from forged steel
- Beam shape section light and strong
- Finish: galvanised, with induction hardened spindle
- By reversing the arms, the extractor can be used as internal or external
- Protective case on screw top for easy use
- Quick-adjust screws for an easy and quick fitting

R		A mm	B mm	L mm	T _{to}	g	
701-90-1	N1	1	90	100	130	4	900
701-130-1	N11	1	130	100	130	4	980
701-160-1	N2	1	160	150	210	6	2.450
701-200-1	N21	1	200	150	210	6	2.880
701-250-1	N3	1	250	205	280	8	6.950
701-350-1	N31	1	350	205	280	8	7.680



R	R	mm	mm	g	R	L mm	g	R	L mm	g
701-90-1	701-90-S	17	M14x1.5x130	175	701-90-K	95	528	701-90-B	136	315
701-130-1	701-90-S	17	M14x1.5x130	175	701-90-K	95	528	701-130-B	177	485
701-160-1	701-160-S	22	M20x2x210	575	701-160-K	150	1.058	701-160-B	217.5	890
701-200-1	701-160-S	22	M20x2x210	575	701-160-K	150	1.058	701-200-B	262	1.360
701-250-1	701-250-S	27	M27x2x280	1.275	701-250-K	202	3.262	701-250-B	330	2.750
701-350-1	701-250-S	27	M27x2x280	1.275	701-250-K	202	3.262	701-350-B	430	3.575

SELF-CENTERING 2 ARMS PULLERS

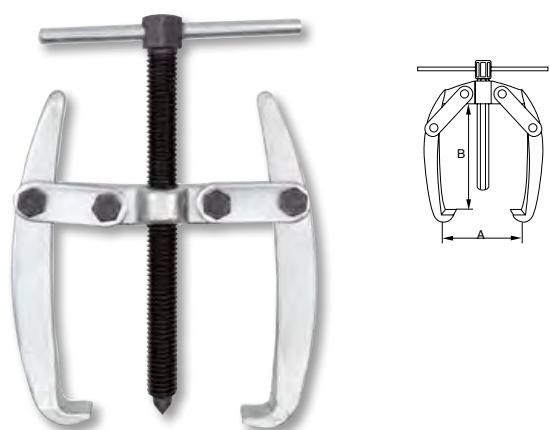

- Body and arms manufactured from forged steel
- Finish: galvanised, with induction hardened spindle
- Ideal for removing small parts such as battery terminals, pulleys, wheels, ball bearings, etc.
- Automatic gripping

R		A mm	B mm	T _{to}	g
702-40-1	1	60	40	0.50	180
702-65-1	1	65	65	0.50	190
702-80-1	1	80	80	1.00	220



R	R	mm	g	R	L mm	g	R	L mm	g	R	L mm	g
702-40-1	702-40-S	M10x1.5x100	61	702-40-K	54.5	40	702-40-B	42x13	20	702-40-P	33.5x3	20
702-65-1	702-65-S	M10x1.5x105	63	702-65-K	88	74						
702-80-1	702-80-S	M10x1.5x122	72	702-80-K	103	98						

SELF-CENTERING 3 ARMS PULLERS

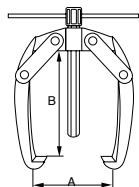

- Body and arms manufactured from forged steel
- Finish: galvanised, with induction hardened spindle
- Ideal for removing small parts such as battery terminals, pulleys, wheels, ball bearings, etc.
- Automatic gripping

R		A mm	B mm	$\frac{M}{T_n}$	g
703-40-1	1	60	40	0.75	230
703-65-1	1	65	65	0.75	290
703-80-1	1	80	80	1.50	320



R	R	$\frac{M}{mm}$	g	R	L mm	g	R	$\frac{L}{mm}$	g	R	$\frac{L}{mm}$	$\frac{L}{T_n}$	g
703-40-1	702-40-S	M10x1.5x100	61	702-40-K	54.5	40	703-40-B	42x13	20	702-40-P	33.5x3	20	
703-65-1	702-65-S	M10x1.5x105	63	702-65-K	88	74							
703-80-1	702-80-S	M10x1.5x122	72	702-80-K	103	98							

MULTIPLE PULLERS

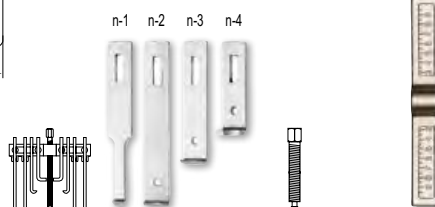
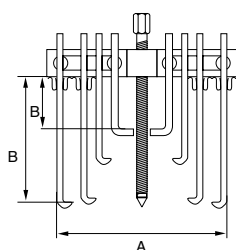

- Can be used as internal and external puller
- Two or more legs can be attached in line, obtaining greater reach

R		A (mm) min. - max.	B (mm) min. - max.	$\frac{M}{T_n}$	g
713001	1	20 - 173	65 - 140	5	2.700
713011	1	75 - 250	77 - 182	10	6.000

R	R	R	R	R
713001	796511	n-1	796491	796501
	796521	n-2		
	796531	n-3		
	796541	n-4		
713011	713511	n-1	713611	796561
	713521	n-2		
	713531	n-3		
	713541	n-4		

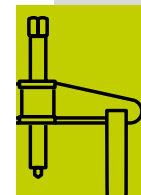

EXTRACTORS

STUD EXTRACTORS SETS



- To remove broken screws, studs and pipes
- Finish: grinded
- Material: High-quality carbon steel

R	Box	Case	Box X	g
716-5-1	1	90x58x15	5	# 1, 2, 3, 4, 5 M3-M18 120
716-8-1	1	215x130x50	8	# 1, 2, 3, 4, 5, 6, 7, 8 M3-M50 840

R	#	mm	Ø mm	L mm	g
716-M6-1	1	2.0	4.00	50	M 3-6 4
716-M8-1	2	2.8	4.30	58	M 6-8 6
716-M11-1	3	4.0	6.00	65	M 8-11 13
716-M14-1	4	6.3	7.50	75	M 11-14 20
716-M18-1	5	7.5	10.70	80	M 14-18 45
	6	10.3	15.00	85	M 18-25 95
	7	13.5	19.00	92	M 25-35 140
	8	20.6	24.00	97	M 35-50 240

TAP WRENCH



- With reversible ratchet: forward - reverse - locked
- Parallel clamping action
- Hardened jaws
- Sliding handle
- Chrome-plated steel

R	Box	mm	L mm	g
718211	1	2.6 - 5.5	85	180
718231	1	4.6 - 8	110	300

NUT SPLITTERS



- For splitting jammed or stripped nuts without damaging the stud thread
- Galvanised and gunmetal finish
- Material: special steel
- Suitable for nuts up to quality grade 6

R	Box	A mm	L mm	g	g	g	
730011	1	32	126	M3-M16	6-27	440	796661 796671
730131	1	42	170	M14-M24	24-40	560	796681 796691

PICK-UP TOOLS

MAGNETIC PICK-UP TOOLS

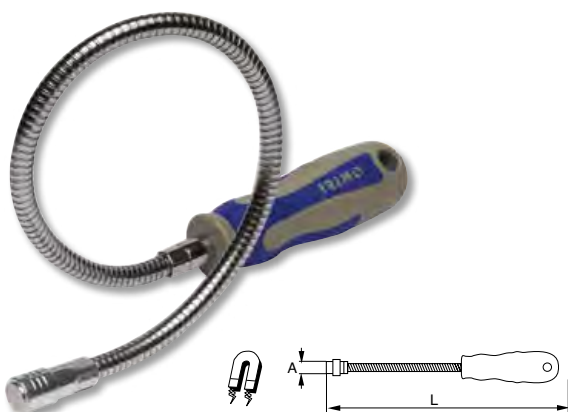

- Two component handle, with hanging hole and anti-roll design
- Polished and chrome-plated
- Blade finish: chrome-plated and polished
- 720-1M-413 has neodymium magnet with capacity of 1 kg and 720-3M-413 has neodymium magnet with capacity of 3 kg

R	Box	Ø mm	A mm	L mm	g	g	
720-1M-413	1	10	10	550	413	110	130
720-3M-413	1	17	13	550	413	110	280

CLAW PICK-UP TOOL

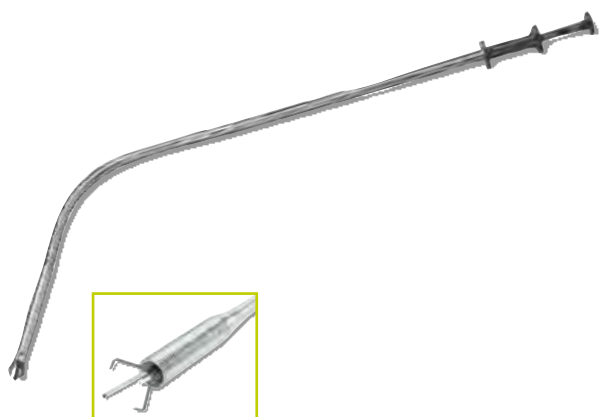

- For gripping small parts
- Flexible shaft with steel core
- Finish: chrome-plated

720031	1	650	80

CLAW PICK-UP TOOL

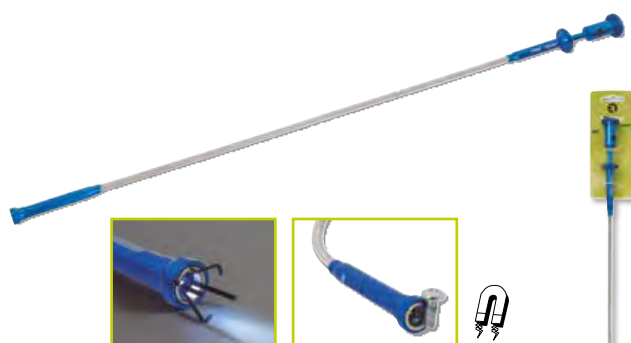

- For gripping very small parts
- Built-in light to locate objects in the dark
- Neodymium magnet on the tip
- Flexible shaft with steel core
- Finish: Chrome-plated

720-LM-1	1	625	120

PRY BARS

PRY BAR

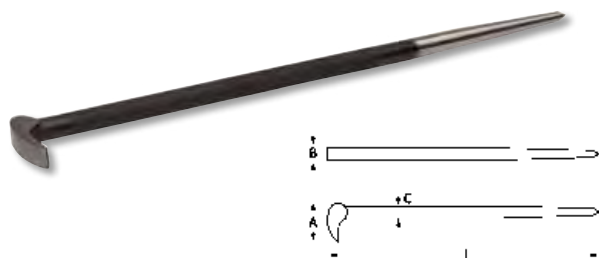

- 90° special lever. Suitable for work in confined spaces such as behind gears
- Finish: black phosphated with polished head and pointed tip
- Material: hardened special alloy steel

		A mm	B mm	C mm		
066-400-1	1	44	14	14	406	450

OFFSET LEVER SET

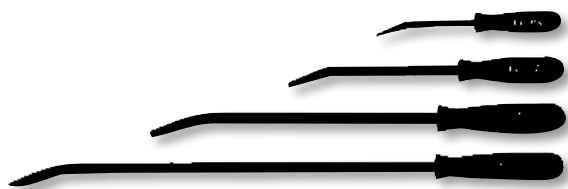

- Pry bars for easy prying and bending
- Plastic handles with lightweight design offers a comfortable grip as well as powerful leverage capacity

ZH70610	1	645x115x35	1.400

ZH70611, ZH70612, ZH70613, ZH70614

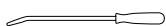

OFFSET LEVER

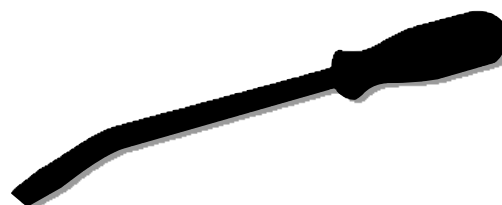

- Pry bars for easy prying and bending
- Plastic handles with lightweight design offers a comfortable grip as well as powerful leverage capacity

ZH70611	1	210	200
ZH70612	1	310	300
ZH70613	1	460	400
ZH70614	1	610	500



SHEET PUNCHES

SHEET METAL PUNCHES



- Screw hole punches
- For a 16 to 50 mm hole diameter
- Ground cutting areas for an easier cut
- Hexagonal head bolt
- For steel sheet plates up to 2 mm thick
- For stainless steel sheet plates up to 1.2 mm thick
- Individual packaging

Part No.	Box Qty	Ø mm	Thread	Weight (g)
740-016-2	1	16	M 8	80
740-020-2	1	20	M 10	120
740-022-2	1	22	M 10	160
740-025-2	1	25	M 10	180
740-030-2	1	30	M 12	320
740-035-2	1	35	M 12	500
740-040-2	1	40	M 14	660
740-050-2	1	50	M 14	1.040

SPARE BOLT



- Spare bolts for sheet metal punches 740 Series
- M8 to M14 Standard bolt
- Sold in a kit

Part No.	Box Qty	Ø mm
740S-008-2	6	M 8
740S-010-2	6	M 10
740S-012-2	6	M 12
740S-014-2	6	M 14



11.

CUTTING TOOLS & MEASURING

BOWSAW FRAMES AND BLADES

BOWSAW FRAMES

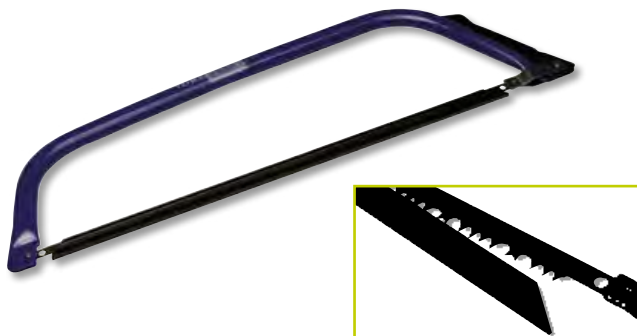

- Powder painted steel tube bowsaw
- 802-2400-1 for dry wood (52)
- 802-3000-1 & 802-3600-1 for wet wood (23)
- Tooth protector included

Part No.	Box Qty	Length (mm)	Length (in)	Teeth	Weight (g)	Weight (oz)
802-2400-1	5	607	24"	51	675	23.8
802-3000-1	5	759	30"	23	800	28.2
802-3600-1	5	912	36"	23	920	32.4

BOWSAW BLADES, GREEN WOOD



- Suitable for sawing in green wood - wet wood
- Hardened and tempered high-quality steel
- Rust prevention treated and packed in individual sleeve

Part No.	Box Qty	Length (mm)	Length (in)	Weight (g)	Weight (oz)
802-2423-1	10	607	24"	60	2.1
802-3023-1	10	759	30"	75	2.6
802-3623-1	10	912	36"	95	3.4

BOWSAW BLADES, DRY WOOD



- For cutting dry, seasoned wood
- Hardened and tempered high-quality steel
- Rust prevention treated and packed in individual sleeve

Part No.	Box Qty	Length (mm)	Length (in)	Weight (g)	Weight (oz)
802-2451-1	10	607	24"	65	2.3
802-3051-1	10	759	30"	80	2.8
802-3651-1	10	912	36"	100	3.5

HANDSAW & HACKSAWS

TENON SAW



- Tenon saw for fine and medium thick materials, specially adapted for cutting of small-diameter timber and mitre guide sawing
- Hardpoint universal teeth for long lasting sharpness
- Heavy steel back for rigidity and accurate cutting
- Screwed plastic handle

Part No.	Box Qty	Length (mm)	Length (in)	Teeth	Weight (g)
800-131-1	10	300	12"	15/16	450

GENERAL PURPOSE HANDSAW



- General purpose saw with fine teeth for smooth sawing in a wide variety of materials, including aluminium, plastics, laminates, wood and chipboard
- Hardpoint fleam-toothing
- Toolbox size
- Screwed 1-piece plastic handle
- Ideal to carry in a toolbox

Part No.	Box Qty	Length (mm)	Length (in)	Teeth	Weight (g)
800-151-1	4	300	12"	15/16	225

DOVETAIL FLEX HANDSAW



- Saw blade for cutting wood & plastic materials
- Universal toothing, hardpoint teeth for long lasting sharpness
- Light steel back for rigidity
- Angled wooden handle to allow flush cutting
- Handle swings to allow both left and right hand sawing where access is restricted

800-111-1	4	250	10"	15/16	240

COMPASS SAW



- Compass saw for all kinds of wood and plastic material
- Hardpoint universal teeth for long lasting sharpness
- Screwed, plastic handle

800-141-1	4	300	12"	7/8	120

ALUMINIUM HACKSAW FRAME

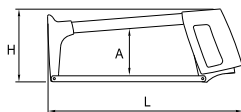
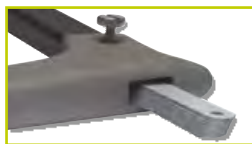

- Supplied with 300 mm (12") reliable and shatterproof bi-metal blade 24 TPI
- A professional and strong hacksaw frame
- Alternative 55° blade mounting for flush cutting

801101	5	400 (300)	24	748

HACKSAW FRAME

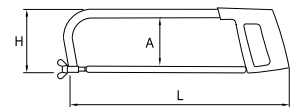
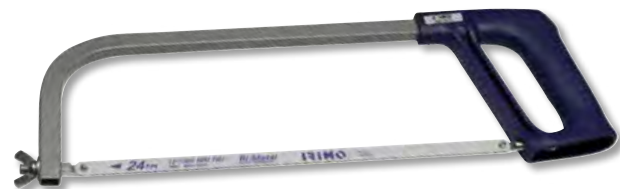

- Traditional design
- Easy to use hacksaw frame

801-041-1	10	110	151	400	665

BI-METAL

- Shatterproof bi-metal blade with precision teeth for all kinds of metal sawing
- Bi-metal blade is guaranteed to keep its sharpness for a long time
- Packaging:
5 Blades in a hanging clip



803-318-5	5	300x13x0.65	18	17
803-324-5	5	300x13x0.65	24	17
803-332-5	5	300x13x0.65	32	17

- Packaging:
50 Blades in a plastic box



803-318-50	50	300x13x0.65	18	17
803-324-50	50	300x13x0.65	24	17
803-332-50	50	300x13x0.65	32	17



HANDSAW & HACKSAWS

ALUMINIUM HOLDER



- A useful mini-hacksaw for small spaces

€	Icon	H mm	L mm	g
801-145-1	5	51	229	140

HACKSAW FRAME

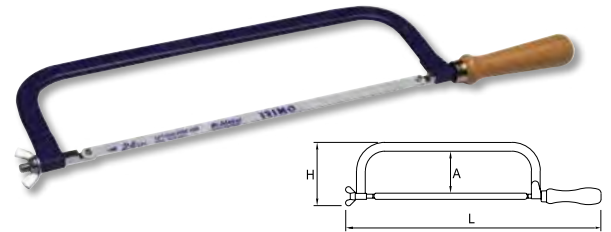

- A traditional designed, easy to use hacksaw frame

€	Icon	A mm	H mm	L mm	g
801-011-1	10	100	128	512	575

HOLESAWS

HOLESAW SET, 9 pieces



- Bi-metal hole saw set of 9 pieces:
 - 6 pcs hole saws sizes 22, 29, 35, 44, 51 and 64 mm
 - 1 pc holder for big size hole saws (inc. Pilot drill)
 - 1 pc holder for small size hole saws (inc. Pilot drill)
 - 1 pc extra replacement Pilot drill

€	Icon	X	mm	g
810-2264-4	1	9	230 x 180 x 70	1.000

FILES

FLAT FILES

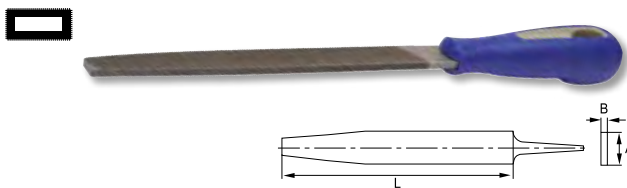

- Edges tapered towards the point, surface parallel
- Surface double cut, edges single cut

€	Icon	L mm	A mm	B mm	Icon	Icon	g
BASTARD							
534521	6	150 / 6"	16	4	13	33	90
534531	6	200 / 8"	20	5	10	25	160
534541	6	250 / 10"	25	5.5	9	23	250
534551	6	300 / 12"	30	6	8	20	413
SECOND CUT							
534251	6	150 / 6"	16	4	18	46	50
534261	6	200 / 8"	20	5	14	36	160

HAND FILES

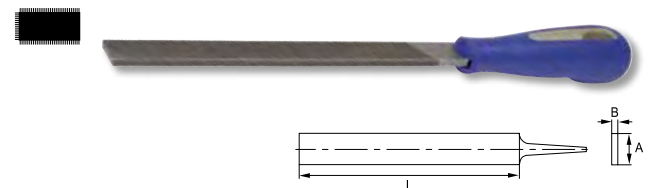

- Edges and surfaces parallel
- Surface double cut, one edge uncut and one edge single cut

€	Icon	L mm	A mm	B mm	Icon	Icon	g
BASTARD							
534561	6	150 / 6"	16	4	13	33	90
534571	6	200 / 8"	20	5	10	25	160
SECOND CUT							
534281	6	150 / 6"	16	4	18	46	50
534291	6	200 / 8"	20	5	14	36	160

HALF ROUND FILES

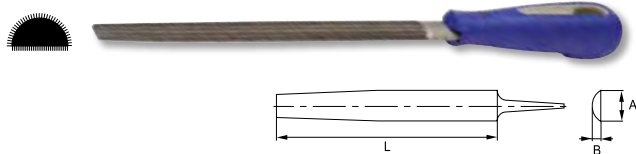

- Edges and surfaces tapered towards the point
- Double cut

Q	Icon	L mm	A mm	B mm	Icon	Icon	g
BASTARD							
534681	6	150 / 6"	16	4.7	13	33	100
534691	6	200 / 8"	20.5	6	10	25	170
534701	6	250 / 10"	26.5	7.5	9	23	344
SECOND CUT							
534371	6	150 / 6"	16	4.7	18	46	100
534381	6	200 / 8"	20.5	6	14	36	170

THREE SQUARE FILES

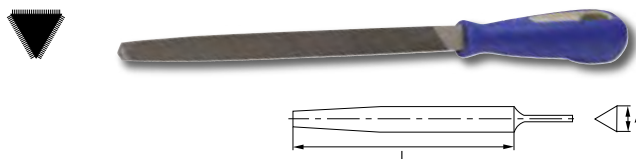

- Equilateral triangle, tapered towards the point
- Double cut surface

Q	Icon	L mm	A mm	Icon	Icon	g
BASTARD						
534901	6	150 / 6"	11	13	33	94
SECOND CUT						
534341	6	150 / 6"	11	18	46	94
534351	6	200 / 8"	15.5	14	36	203

FILE SET



ROUND FILES

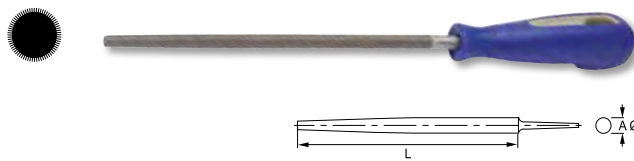

- Tapered towards the point
- Double cut

Q	Icon	L mm	A mm	B mm	Icon	Icon	g
BASTARD							
534601	6	150 / 6"	16	4.7	13	33	100
534611	6	200 / 8"	20.5	6	10	25	170
534621	6	250 / 10"	26.5	7.5	9	23	344
SECOND CUT							
534311	6	150 / 6"	16	4.7	18	46	100
534321	6	200 / 8"	20.5	6	14	36	170

SQUARE FILES

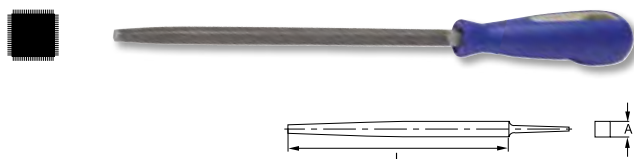

- Surface tapered towards the point
- Double cut surface

Q	Icon	L mm	A mm	Icon	Icon	g
BASTARD						
534931	6	150 / 6"	6	13	33	79
534941	6	200 / 8"	8	10	25	132
SECOND CUT						
534401	6	150 / 6"	6	18	46	79
534411	6	200 / 8"	8	14	36	132

Q	Icon	Icon	Icon	g
534501	1	6	44x37x3	1.150
534261	Icon	Icon	534351	Icon
534291	Icon	Icon	534381	Icon
534321	Icon	Icon	534411	Icon



SPIRIT LEVELS

SPIRIT LEVELS

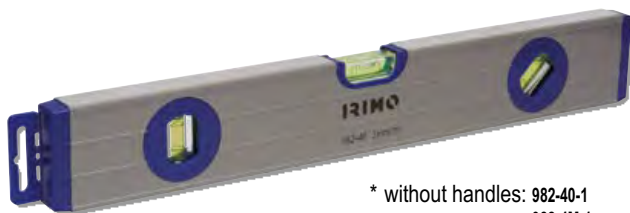

* without handles: 982-40-1
982-4M-1



* with handles: 982-60-1
982-80-1
982-6M-1

- Accuracy ± 1 mm/m
- High visibility, barrel shape acrylic vials
- Three vials: horizontal, vertical and 45°
- Light aluminium material 1.5 kg/m
- Strong profile design. Milled top and bottom measuring surfaces
- Long lasting epoxy painting

R	Icon	A mm	B mm	L mm	g
982-40-1	1	24	60	400	300
982-60-1	1	24	60	600	360
982-80-1	1	24	60	800	550

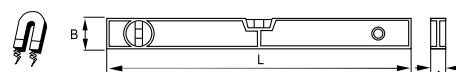

- Two magnets
- Separating force 9 Newton
- Three vials: horizontal, vertical and 45°

R	Icon	A mm	B mm	L mm	g
982-4M-1	1	22	60	400	280
982-6M-1	1	24	60	600	370

SPIRIT LEVELS

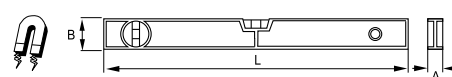
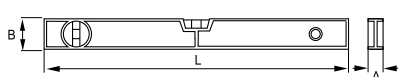

- Aluminium tube, light, 450 g/m
- Tube is slim, easy to carry, size 20 x 49 mm
- Accuracy ± 0.5 mm/m
- High visibility vials
- Three vials: horizontal, vertical and 45°
- Protective end caps
- Long lasting epoxy painting

R	Icon	A mm	B mm	L mm	g
981-400-1	1	20	49	400	175
981-600-1	1	20	49	600	215
981-800-1	1	20	49	800	275
981-1000-1	1	20	49	1.000	325
981-1200-1	1	20	49	1.200	380
981-1500-1	1	20	49	1.500	480
981-1800-1	1	20	49	1.800	550
981-2000-1	1	20	49	2.000	605

- Aluminium tube, light, 450 g/m
- Tube is slim, easy to carry, size 22 x 49 mm
- Accuracy ± 0.5 mm/m
- High visibility vials
- Three vials: horizontal, vertical and 45°
- Two built in magnets
- Protective end caps
- Long lasting epoxy painting

R	Icon	A mm	B mm	L mm	g
981-400M-1	1	22	49	400	300
981-600M-1	1	22	49	600	450

SET OF LEVELS

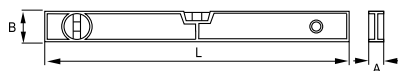

- Set of 2 levels:
Spirit level 600 mm + Torpedo level
- Aluminium tube, 530 g/m
- High visibility and low density liquid inside the vials
- Torpedo level 982-TOR

Q	Icon	A mm	B mm	L mm	g
982-SET	1	55	60	600	410

TORPEDO LEVEL

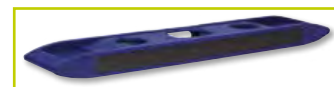

- Magnet in the base
- Suitable for plumbers
- 3 vials: horizontal, vertical and 45°
- ±1 mm/m accuracy in horizontal vial
- ±1 mm/m accuracy in vertical vial
- High visibility liquid inside the vials

Q	Icon	A mm	B mm	L mm	g
982-TOR-1	1	15	40	230	80

POCKET SPIRIT LEVEL, 100 MM

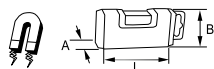
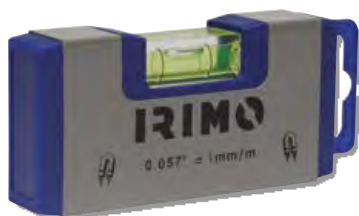

- Pocket level 10 cm
- Accuracy ±1 mm/m
- High visibility, barrel shape acrylic vials
- Removable hanging clip
- Long lasting epoxy painting
- 2 strong magnets hidden inside profile, they hold 500 g
- Profile 1.0 mm thickness and weight of 295 g/m

Q	Icon	A mm	B mm	L mm	g
982-10-1	1	20	50	100	60

ALUMINUM LEVEL WITH HOLSTER



- Strong magnet with neodyms
- High quality vials
- With textile pouch for easy transport

Q	Icon	Icon	g
983-25-1	5	240x140x25	315

1	Icon
2	Icon
3	Icon
4	Icon
5	Icon
6	Icon
7	Icon
8	Icon
9	Icon
10	Icon
12	Icon

MEASURING TAPES

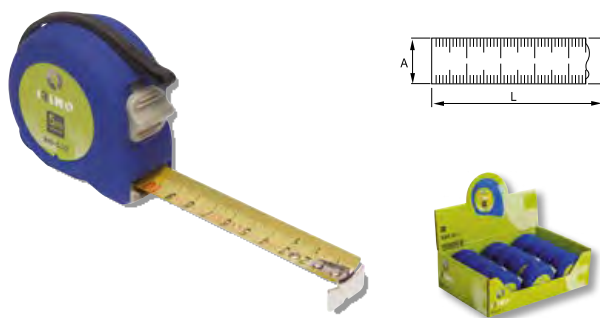

- According to EU Measuring Instruments Directive
- Class II accuracy
- ABS case with thermo rubber coating
- Blade locking system
- Wrist strap
- Metal belt clip
- High quality 50C steel blade
- 3 rivets on stopper

* Counter display when ordering 12 pieces

€	📦	A mm	L m	g
980-3-1	12	16	3	140
980-5-1	12	19	5	180
980-5-25-1	12	25	5	175

- According to EU Measuring Instruments Directive
- Class II accuracy
- ABS case with thermo rubber coating
- Blade locking system
- Wrist strap
- Metal belt clip
- High quality 50C steel blade
- 3 rivets on stopper

* Counter display when ordering 12 pieces

€	📦	A mm	L m	g
980-3B-1	12	16	3	125
980-5B-1	12	19	5	195
980-8B-1	12	25	8	370

TAPE TWINPACK



- Measuring tapes twin pack mm
3 m x 16 mm & 10 m x 25 mm

€	📦	📦	📦	g
980-TP2-1	12	2	170 x 80 x 42	549

HIGH VISIBILITY MEASURING TAPES

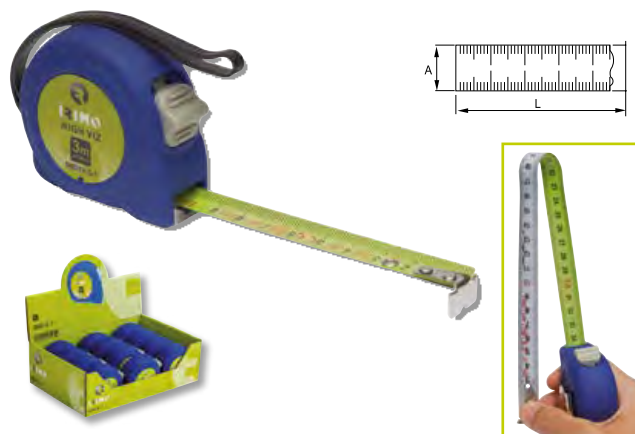

- Special green color of the blade for high visibility
- Vertical marking in the back side
- Back side marking allows easy vertical measurement and marking
- According to EU Measuring Instruments Directive
- Class II accuracy
- ABS case with thermo rubber coating
- Blade locking system
- Wrist strap
- Metal belt clip
- High quality 50C steel blade nylon coated resistant to abrasion
- 3 rivets on stopper hook

* Counter display when ordering 12 pieces

€	📦	A mm	L m	g
980HV-3-1	12	16	3	105
980HV-5-1	12	19	5	175

MEASURING TAPE FOR VERTICAL MEASUREMENTS

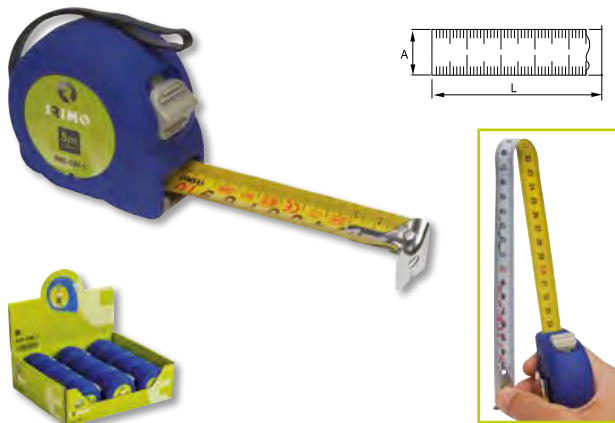

- Measuring tape 5 m x 30 mm wide
- Marked in mm in both sides
- Vertical marking in the back
- * Counter display when ordering 12 pieces

Code	Quantity	A mm	L m	Weight (g)
980-5W-1	12	30	5	295

LONG TAPE



- According to EU Measuring Instruments Directive
- Class II accuracy
- ABS case with thermo rubber grip
- High quality 50C steel blade
- Stopper with ring and foldable jaw
- Belt clip
- Quick wind mechanism
- Individual box that can be hung

Code	Quantity	A mm	L m	Weight (g)
980-20S-1	12	13	20	350

WOODEN FOLDING RULE



- 10 blades wooden folding rule
- Birch wood, flexible and resistant
- Special varnish resistant to abrasion
- According to EU Measuring Instruments Directive
- Class III

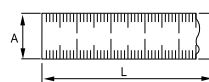

Code	Quantity	A mm	L m	Weight (g)
985-2-1	1	16	2	115

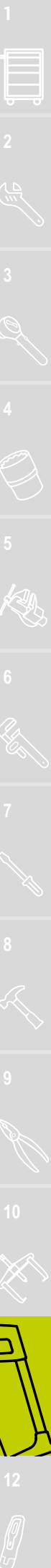

SQUARES

SQUARES



- Scale in mm
- Stainless steel blade
- Aluminium handle

Code	Quantity	Length (mm)	Weight (g)
991-200-1	1	200	230
991-250-1	1	250	250
991-300-1	1	300	290
991-400-1	1	400	330

COMBINATION SQUARES



- Scale in mm and inches
- Stainless steel blade
- Includes a level with 1 mm/m accuracy
- Zinc handle and brass parts

Code	Quantity	Length (mm)	Weight (g)
993-150-1	1	150	200
993-300-1	1	300	230
993-400-1	1	400	260

GAUGE SETS

SCREW PITCH GAUGE SET



- Blade length: 70 mm

Code	Quantity	Blades	Weight (g)
972-52-1	25	52 blades	65
Metric 60° - 0.25 to 6 mm 0.25-0.30-0.35-0.40-0.45-0.50-0.60-0.70-0.75- 0.80-0.90-1-1.25-1.50-1.75-2-2.5-3-3.5-4-4.5- 5-5.5-6			
Whitworth 55° - 4 a 62 thread" 4-4.5-5-6-7-8-9-10-11-12-13-14-16-18-19- 20-22-24-25-26-28-30-32-36-40- 48-60-62			

FEELER GAUGE SETS



- Blade length: 100 mm

Code	Quantity	Blades	Weight (g)
971-13-1	5	13 blades	52
0.05 to 1 mm 0.05-0.10-0.15-0.20-0.25-0.30-0.40-0.50-0.60-0.70- 0.80-0.90-1			
971-20-1	5	20 blades	83
0.05 to 1 mm 0.05-0.10-0.15-0.20-0.25-0.30-0.35-0.40-0.45-0.50-0.55- 0.60-0.65-0.70-0.75-0.80-0.85-0.90-0.95-1			

CALIPERS

VERNIER CALIPER 150 MM



- Vernier caliper
- Accuracy ± 0.03 mm
- Made in hardened stainless steel
- Includes thread chart
- Includes plastic box for safe storage

984-6-1 1 0-150 0-6" 235 25x90x245 150

DIGITAL VERNIER CALIPER 150 MM



- Digital Vernier caliper
- Accuracy ± 0.03 mm
- Made in hardened stainless steel
- Includes thread chart
- Includes plastic box for safe storage

984-6D-1 1 0-150 0-6" 235 25x90x245 150

INFRARED THERMOMETER



- Non contact measuring temperature
- Measuring range: -50°C to 420°C (-58°F to 788°F)
- With laser pointer
- Accuracy: 0 to 420°C , $\pm 1.5^{\circ}$
 -50 to 0°C , $\pm 3^{\circ}$
- Resolution: 0.1°C
- Repeatability: 1% of reading or 1°C
- Response time: 500 ms
- Measuring cone ratio: L12 to D1
- 9V battery not included

LT-420-1 1 155 170



PAINT SCRAPERS

PAINT SCRAPERS



- Flexible carbon steel ground blade
- 1.5 mm thickness/0.5 mm at the tip
- Excellent flexibility and maximum durability
- Polished and varnished blade for longer life
- Metallic ring for perfect fixing between handle and blade
- Comfortable and light plastic handle
- Provided with hanging hole
- Standards: DIN 7216, UNE 16608

€	Icon	S mm	L mm	g
540021	12	20	220	50
540031	12	30	220	55
540041	12	40	220	60
540051	12	50	220	65
540061	12	60	220	70
540071	12	70	220	75
540081	12	80	220	80
540091	12	90	220	85
540101	12	100	220	90
540121	12	120	220	100

BODY WORK SCRAPER SET



- Bodywork scraper set, 4 pcs
- Carbon steel ground blade
- Excellent flexibility and maximum durability
- Polished and varnished blade to prevent oxidation
- Supplied in a plastic pouch

€	Icon	Icon	Icon	g
536011	1	4	160 x 130	120

90x50 mm, 120x80 mm, 120x105 mm, 120x120 mm

FASTENING TOOLS

CAULKING GUNS

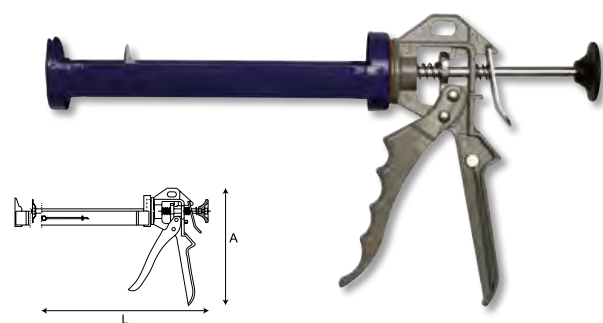

- Caulking gun for 9" cartridges
- Suitable for most grades of resins and glues
- Handle and trigger made of high quality aluminium
- Rotary skeleton for easy loading
- Needle incorporated for cleaning
- Thrust ratio 7:1
- Maximum push force 1500N

€	Icon	A mm	L mm	g
549-230-2	1	200	330	550

ELECTRONIC GLUE GUN SET



- Industrial performance glue gun
- With ON-OFF switch for energy saving
- CE/GS Standards
- Protected nozzle for added safety, reliability and extended life
- 2 additional nozzles (spreader & precision) with a valve to prevent unintentional glue drop
- Foldable stand for safe, handy storage while in use
- Power: 80W. Voltage: 220-240V. Preheat time: 3-5 minutes. Flow of glue: 14-15 g per minute. 1,6 m cord
- 12 pcs of 11.2x150 mm glue stick (6 x General Purpose glue sticks, 6 x Super Strength glue sticks)
- Blister pack

€	Icon	Icon	g
550-80-4	1	40 x 190 x 190	250

HEAT GUN 2000W



- Adjustable temperature heat gun 2000W
- Led display for temperature adjustment
- 12 temperature setting values
- 2 different airflow option:
 - Speed 1: 250 l/min - 50°C, 100°C, 150°C, 200°C, 250°C, 350°C
 - Speed 2: 550 l/min - 100°C, 200°C, 300°C, 400°C, 500°C, 600°C
- Auto cool-down system: 280 l/min - 50°C
- Hands-free mode

551-HG-1	1	200x65x240	560

HEAT GUN NOZZLES



- 4x heat gun nozzles
- Four different nozzles, one for each kind of work
- Compatible with 551-HG-1 2000W heat gun

551-NOZ-1	1	4	5x110x150	10

HEAVY DUTY STAPLE GUN 4 IN 1



- Promotional kit with stapler remover including a box with 1000 staples
- Compact, multi-purpose stapler and brad nail staple gun
- High-low power setting to control intensity application
- Fastener window provides clear visibility to determine when staple reload is required
- Anti-jam mechanism for continuous use and reliable operation
- Lock down handle for safe storage and transportation
- Belt clip

560-41LP-1	3	170x290x40	690

HAMMER TACKER



- Promotional kit with a box with 1000 staples
- Compact hammer tacker with steel housing
- Anti-jam mechanism for continuous use and reliable operation
- Ergonomic handle for better grip and handling

560-HTS-1	6	115x350x32	520



FASTENING TOOLS

HEAVY DUTY STAPLE GUN 4 IN 1



- Compact, multi-purpose stapler and brad nail staple gun
- High-low power setting to control intensity application
- Fastener window provides clear visibility to determine when staple reload is required
- Anti-jam mechanism for continuous use and reliable operation
- Lock down handle for safe storage and transportation
- Belt clip
- Compatible with:
 - Heavy duty staples (1.2): 6-14 mm (1/4"-9/16")
 - Light duty staples (0.7): 6-14 mm (1/4"-9/16")
 - Cable staples: 10-14 mm (3/8"-9/16")
 - 18 ga. brad nails: 15 mm (19/32")

Code	Length (mm)	Width (mm)	Height (mm)	Weight (g)
560-41-1	3	170x290x40		690

HEAVY DUTY STAPLES

x1000



- For heavy duty stapling jobs such as insulation, carpets or roofing felt
- Staples suitable for fabrics, cloths, carpets, cardboard, flat wooden slats, wooden cardboard and metal mesh

Code	Length (mm)	A (mm)	B (mm)	C (mm)	Width (mm)	Height (mm)
560-HD-06	12	1.2	11.3	6	40x28x80	110
560-HD-08	12	1.2	11.3	8	65x35x80	137
560-HD-10	12	1.2	11.3	10	65x35x80	158
560-HD-12	12	1.2	11.3	12	65x35x80	172
560-HD-14	12	1.2	11.3	14	65x35x80	195

BRAD NAILS 15 MM

x1000



- Suitable brad nails for craft or carpentry projects

Code	Length (mm)	A (mm)	B (mm)	C (mm)	Width (mm)	Height (mm)
560-BN-15	12	1.2	2	15	40x28x80	122

HAMMER TACKER



- Compact hammer tacker with steel housing
- Anti-jam mechanism for continuous use and reliable operation
- Ergonomic handle for better grip and handling

Code	Length (mm)	Width (mm)	Height (mm)	Weight (g)
560-HT-1	6	115x350x32		520

LIGHT DUTY STAPLES

x1000



- Suitable staples for light duty household and crafting stapling jobs

Code	Length (mm)	A (mm)	B (mm)	C (mm)	Width (mm)	Height (mm)
560-LD-06	12	0.7	11.3	6	40x28x80	70
560-LD-08	12	0.7	11.3	8	65x35x80	88
560-LD-10	12	0.7	11.3	10	65x35x80	102
560-LD-12	12	0.7	11.3	12	65x35x80	112
560-LD-14	12	0.7	11.3	14	65x35x80	117

CABLE STAPLES

x1000



- Suitable staples for low voltage wires

Code	Length (mm)	A (mm)	B (mm)	C (mm)	Width (mm)	Height (mm)
560-CA-10	12	1.2	7.5	10	65x35x80	127
560-CA-12	12	1.2	7.5	12	65x35x80	145
560-CA-14	12	1.2	7.5	14	65x35x80	151



12.

LIGHTING & PNEUMATIC TOOLS

POCKET LAMPS

FLEXIBLE LIGHT



- LED COB (main) / 1xSMD (torch)
- LUMENS: 400 lm (main) / 70 lm (torch)
- Battery:
 - Material: Li-ion 3.7V 2000 mAh
 - Operating time: 3 h (main) / 10 h (torch)
 - Charging time: 3 h
 - Charging port: Micro USB
- Two light intensity options
- Micro USB cable 1m included
- Temperature: 5700 °K
- CRI: >70
- IP54 / IK07
- CE-EMC / RoHS / Reach

L-FLEX-1	1	400	70	✓	3/10	3.5	74x262x45 307

COMPACT



- LED COB (main) / 1xSMD (torch)
- LUMENS: 600 lm (main) / 100 lm (torch)
- Battery:
 - Material: Li-ion 3.7V 2000 mAh
 - Operating time: 2.5 h (main) 6 h (torch)
 - Charging time: 3 h
 - Charging port: Micro USB
- Micro USB cable 1 m included
- Temperature: 5700 °K
- CRI: >80
- IP54 / IK07
- CE-EMC / RoHS / Reach

L-COMP-1	1	600	100	✓	2.5/6	3	75x207x38 223

SLIM FLEX



- LED COB (main) / 1xSMD (torch)
- LUMENS: 400 lm (main) / 70 lm (torch)
- Battery:
 - Material: Li-ion 3.7V 2000 mAh
 - Operating time: 3-8 h (main) 8 h (torch)
 - Charging time: 3 h
 - Charging port: Micro USB
- Thumbwheel light intensity regulator
- Micro USB cable 1 m included
- Temperature: 5700 °K
- CRI: >70
- IP20 / IK07
- CE-EMC / RoHS / Reach

L-SLIM-1	1	400	70	✓	3/8	3	82x168x36 200

MINI FLEXIBLE LIGHT



250
LUMENS

- LED SMD 4+1
- LUMENS: 250 lm (main) / 70 lm (torch)
- Battery:
 - Material: Li-ion 3.7V 1000 mAh
 - Operating time: 3 h (main) 7 h (torch)
 - Charging time: 3 h
 - Charging port: Micro USB
- Micro USB cable 1m included
- Temperature: 5700 °K
- CRI: >80
- IP20 / IK07
- CE-EMC / RoHS / Reach

L-MINI-1	1	250	70	✓	3/7	3	53x195x53	130	

INSPECTION LAMPS

ALUMINIUM TORCH



100
LUMENS

- LED COB
- LUMENS: 100 lm
- Battery:
 - 3AAA included
 - Operating time: 9 h
- Aluminium body
- Easy push rubber bottom
- Strap to hang it
- Temperature: 6500 °K
- CRI: >70
- IP44
- CE-EMC / RoHS

L-ALUM-1	1	100	3AAA	100x45x35	100
L-ALUM-12DISP	1			105x220x170	1.050

WORKING LAMPS

BOOK LIGHT



1000
LUMENS

- LED 27xSMD
- Two intensity options
- LUMENS: 500 lm / 1000 lm
- Battery:
 - Material: Li-ion 3.7V 4000 mAh
 - Operating time: 6 h / 500 lm, 3 h / 1000 lm
 - Charging time: 2.5-3 h / 5V 2A
 - Charging port: Micro USB
- Power bank functionality
- Rotating handle 270°
- Micro USB cable 1 m included
- Temperature: 6000 °K
- CRI: >80
- IP54 / IK08
- CE-EMC / RoHS / Reach

L-BOOK-1	1	500/1000	3/6	3	182x142x52	400



HEAD LAMPS

HEAD LIGHT



400
LUMENS



- LED SMD
- LUMENS: 400 lm
- Battery:
 - Material: Li-ion 3.7V 2200mAh
 - Operating time: 5 h
 - Charging time: 4 h
 - Charging port: Micro USB
- Two intensity and blinking option in the front
- Rear red light with blinking option
- Adjustable strap
- Swiveling head
- Zoom for better focus
- Micro USB cable 1 m included
- Temperature: 6000 °K
- CRI: >70
- IP44
- CE-EMC / RoHS / Reach

L-HEAD-1	1	5	4	118x87x64	125

HEAD LIGHT



350
LUMENS



- LED: COB&PE
- Two settings for intensity and flashing light
- Motion sensor activation mode for contactless On/Off
- Battery:
 - Material: 3.7 V 1200 mAh lithium battery
- Adjustable strap
- USB charging cable included
- IPX4

L-FRONT-1	1	150	x	8	2.5	IPX4	6000	40x60x100	70

1/2" IMPACT WRENCH

P-IW-12



- 1/2" pneumatic impact wrench, 1600 N·m
- Powerful twin hammer mechanism
- Light, durable and insulated composite housing
- Powerful twin hammer mechanism
- Easy one-hand forward and reverse change
- Three-step power regulator
- Progressive trigger mechanism
- Built-in silencer

P-IW-12C



- Compact 1/2" pneumatic impact wrench, 1200 N·m
- Powerful twin hammer mechanism
- Light, durable and insulated composite housing
- Powerful twin hammer mechanism
- Easy one-hand forward and reverse change
- Three-step power regulator
- Progressive trigger mechanism
- Built-in silencer

3/4" IMPACT WRENCH

P-IW-12P



- High performance 1/2" pneumatic impact wrench, 2230 N·m
- Powerful twin hammer mechanism
- Light, durable and insulated composite housing
- Powerful twin hammer mechanism
- Easy one-hand forward and reverse change
- Three-step power regulator
- Progressive trigger mechanism
- Built-in silencer

P-IW-34



- 3/4" pneumatic impact wrench, 2298 N·m
- Powerful twin hammer mechanism
- Light, durable and insulated composite housing
- Powerful twin hammer mechanism
- Easy one-hand forward and reverse change
- Three-step power regulator
- Progressive trigger mechanism
- Built-in silencer



			BAR												
				inch	mm	mm	N·m	MAX N·m	rpm	mm ²	mm	mm	mm	kg	
P-IW-12	1	1/2"	6.3	1/4" - 19	10	184	680-730	1600	8.500	1.000	110	6.34	185	2.1	
P-IW-12C	1	1/2"	6.3	1/4" - 19	10	184	500-580	1200	10.500	1.250	110	6.34	125	1.25	
P-IW-12P	1	1/2"	6.3	1/4" - 19	10	184	1050-1150	2230	7.500	1.000	110	6.34	195	2.3	
P-IW-34	1	3/4"	6.3	1/4" - 19	10	184	1080-1150	2298	7.500	1.000	110	6.34	195	2.37	



1/4" RATCHET

P700

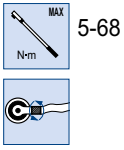

1/2" RATCHET

P821



• Composite

	QTY	SIZE	BAR	inch	mm	mm	Nm	RPM	dB	mm	kg	
P700	1	1/4"	6.3	1/4" - 18	10	136	0 - 27	300	94.00	3.60	133	0.50
P821	1	1/2"	6.3	1/4" - 18	10	120	0 - 67	150	80.00	2.60	256	1.20

AIR LINE COUPLERS



	QTY	SIZE	mm	g
PM5002 PM5003	1	1/4" 3/8"	Male Male	70
PM5012 PM5013	1	1/4" 3/8"	Female Female	80
PM5142 PM5143	1	1/4" 3/8"	Male Male	20
PM5152 PM5153	1	1/4" 3/8"	Female Female	20
PM5248	1	-	For 8 mm hose	10

CORDLESS SCREWDRIVER

3.6V CORDLESS SCREWDRIVER



- 3.6V Li-ion rechargeable battery
- 1/4" hex quick release bit holder
- 6+1 torque positions
- LED light to lighten the working area
- 4 LED lamp to work as a regular torch
- Adaptable handle in straight or pistol shapes
- One hand forward/reverse change
- Integrated colour LEDs to know the battery status
- 4 screwdriver bits included
- Packed in a retail color cardboard box



	QTY	V	mm	RPM	g
3.6SDR	1	3.6	95x65x35	200	400

POINT OF SALE MATERIAL



MEE-SIGN-CARR-I SIGN CARRIER+SIGN IRIMO (100 cm)

MEE-1S2L-B-I METAL WALL_1SIDE_2LEG_BAHC&IRI

* Tools not included



- The IRIMO exhibitors are a perfect solution that contributes to improving the point of sale management.
- With their attractive design, these displays will help enhance the image of the store.
- This solution facilitates stock control and at the same time, optimize display space.
- **NOTE:** Below are some examples; for more information about different accessories and sizes, please contact us and we will offer the ideal solution suited to your needs.

POINT OF SALE MATERIAL

METAL WALL 1 SIDE 2 LEGS

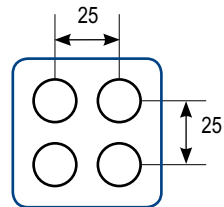

Perforated wall detail

	W mm	H mm	L mm	kg
MEE-1S2L-B-I	524	2250	1030	53.63

LIGHTBOX



- Short cable is included
- Order long cable separately (PEE-LCABLE-B-I)

	W mm	H mm	L mm	kg
MEE-LIGHTBOX-I	412	170	1000	13.32

SIGN CARRIER + SIGN IRIMO



	W mm	H mm	L mm	kg
MEE-SIGN-CARR-I	90	200	1000	1.98

METAL WALL CORNER 1 LEG

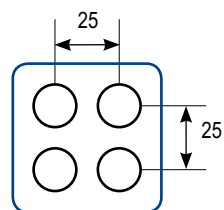

Perforated wall detail

	W mm	H mm	L mm	kg
MEE-COR-1L-B-I	388	2350	941	44.05

LIGHTBOX CORNER WALL



- Short cable is included
- Order long cable separately (PEE-LCABLE-B-I)

	W mm	H mm	L mm	kg
MEE-COR-LIGHT-I	400	174	910	7.375

POINT OF SALE MATERIAL

SPARE PARTS FOR METAL WALL

METHACRYLATE FOR LIGHTBOX



IRIMO	W mm	H mm	L mm	kg
PEE-METHACRYL-I	3	168	980	0.61

PVC TOP SIGN FOR SIGN CARRIER



IRIMO	W mm	H mm	L mm	kg
PEE-SIGN-DB-W-2	3	150	980	0.2

TOP SIGN FOR DOUBLE SIDED WALL



IRIMO	W mm	H mm	L mm	kg
PEE-TOPSIGN-I	3	150	980	0.2

DOUBLE SIDE WALL WITH WHEELS

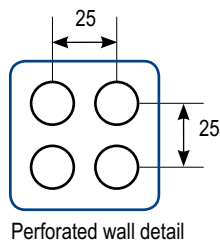

IRIMO	W mm	H mm	L mm	kg
MEE-DB-W-NL	300	800	1390	29.99

BANNER FOR METAL WALLS



IRIMO	W mm	H mm	L mm	kg
MEE-BANNER-I	15	1200	230	1.025

TRIANGULAR METAL WALL WITH WHEELS

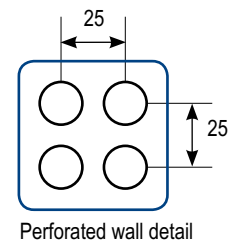
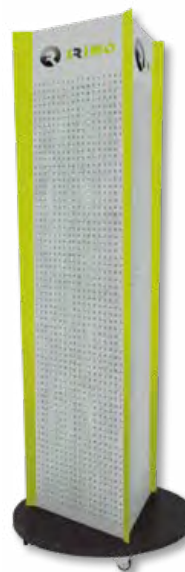

IRIMO	W mm	H mm	L mm	kg
MEE-TR-W-I	700	1860	700	23.45

ADDITIONAL POS MATERIAL. EMPTY DISPLAYS

GENERIC COUNTER DISPLAY



R	W mm	H mm	L mm	kg
MEE-COUNT-IR-1	295	615	430	6.7

COUNTER S DISPLAY



- The display includes 12 hooks of 240 mm length each one

R	W mm	H mm	L mm	kg
MEE-COUNT-IR-2	260	465	465	2.6

COUNTER L DISPLAY



- The display includes 22 hooks of 240 mm length each one

R	W mm	H mm	L mm	kg
MEE-COUNT-IR-3	270	465	775	4.12

PALLET COVER EUROPALLET



R	W mm	H mm	L mm	kg
PEE-PC-IR-1	1150	250	800	0.735

COUNTER DISPLAY PLIERS, 20 pieces



R	W mm	H mm	L mm	kg
PEE-COUNT-006	280	240	365	0.23

COUNTER DISPLAY PLIERS, 5 pieces



R	W mm	H mm	L mm	kg
CEE-COUNT-IR-1	200	60	90	0.237

STICKERS A4 SHEET



R	W mm	L mm	kg
PPOS-A4-STICK-I	210	295	0.018

STAND ALONE



- Material: metal and plastic
- Color: black and green
- The display can be used to expose 3 different socket sets: small - medium - big
- The following socket sets can be exposed:
 - Small socket set (109-35-4)
 - Medium socket set (119-18-4 or 129-23-4)
 - Big socket set (129-58-4 or 129-101-4)
- Includes 3 wall racks with a methacrylate cover
- Delivered already mounted & empty

R	QTY	W mm	H mm	L mm	kg
MEE-SA-SS-IR	1	1835	455	380	



Q	📖
001021	36
001031	36
001041	36
001051	36
001061	36
001071	36
001081	36
020011	44
020031	44
020051	44
020071	44
020091	44
020121	44
020141	44
020171	44
020181	44
020201	44
020211	44
020221	44
020241	44
020251	44
021221	44
021251	44
040001	111
040011	111
040021	111
040031	111
040041	111
040051	111
040061	111
040071	111
040081	111
040091	111
040101	111
040121	111
040141	111
040171	111
040191	111
040221	111
040541	111
040561	111
040581	111
040601	111
040611	111
040621	111
040641	111
040661	111
040681	111
040701	111
040731	111
041011	111
041021	111
041031	111
041041	111
041051	111
041061	111

Q	📖
041071	111
041091	111
041101	111
045001	112
045011	112-114
045021	112
045031	112
045041	112-114
045051	112
045061	112
045071	112
045081	112
045091	112
045101	112
045121	112
045141	112
045171	112
045191	112-114
045221	112
045541	114
045561	114
045581	114
045601	114
045611	114
045621	114
045641	114
045661	114
045681	114
045701	114
045731	114
045801	114
045811	114
045821	114
045831	114
045841	114
045851	114
045861	114
045871	114
045881	114
045891	114
045901	114
045921	114
045941	114
046011	113
046021	113
046031	113
046041	114
046051	114
046061	114
046091	113
046101	113
047001	115
047011	115
047021	115
047031	115
047041	115

Q	📖
047051	115
047061	115
047081	115
047101	115
047121	115
055011	47
055031	47
055051	47
055071	47
055091	47
055121	47
055141	47
055171	47
055181	47
055201	47
055211	47
055221	47
055241	47
055251	47
055301	47
055311	47
056231	47
056271	47
066-400-1	167
070411	52
070421	52
070431	52
070441	52
070451	52
070461	52
070471	52
070481	52
10-0405-1	38
10-0607-1	38
10-0809-1	38
10-1011-1	38
10-1013-1	38
10-12-H	39
10-12-W	39
10-1213-1	38
10-1415-1	38
10-1617-1	38
10-1719-1	38
10-1819-1	38
10-2022-1	38
10-2123-1	38
10-2224-1	38
10-2426-1	38
10-2427-1	38
10-2528-1	38
10-2729-1	38
10-3032-1	38
10-8-H	39
101-04-1	56
101-045-1	56
101-05-1	56

Q	📖
101-055-1	56
101-06-1	56
101-07-1	56
101-08-1	56
101-09-1	56
101-10-1	56
101-11-1	56
101-12-1	56
101-13-1	56
101-14-1	56
101A-05-1	56
101A-06-1	56
101A-07-1	56
101A-08-1	56
101A-09-1	56
101A-10-1	56
101A-11-1	56
101A-12-1	56
101A-14-1	56
101A-16-1	56
101A-18-1	56
103-04-1	56
103-045-1	56
103-05-1	56
103-055-1	56
103-06-1	56
103-07-1	56
103-08-1	56
103-09-1	56
103-10-1	56
103-11-1	56
103-12-1	56
103-13-1	56
103-14-1	56
103A-06-1	56
103A-08-1	56
103A-09-1	56
103A-10-1	56
103A-11-1	56
103A-12-1	56
103A-14-1	56
103A-16-1	56
105-22-1	59
105-24-1	59
105-26-1	59
105-28-1	59
105-40-1	59
105-42-1	59
105-46-1	59
105-48-1	59
105-50-1	59
105-70-1	58
105-70-12DISP	58
105501	58
106-04-1	56
106-05-1	56

Q	📖
106-06-1	56
106-07-1	56
106-08-1	56
106-10-1	56
107-0840-1	57
107-1055-1	57
107-1280-1	57
107-H3-1	57
107-H4-1	57
107-H5-1	57
107-H6-1	57
107-H8-1	57
107-PH1-1	57
107-PH2-1	57
107-PH3-1	57
107-PZ1-1	57
107-PZ2-1	57
107-PZ3-1	57
107-T08-1	57
107-T09-1	57
107-T10-1	57
107-T15-1	57
107-T20-1	57
107-T25-1	57
107-T27-1	57
107-T30-1	57
107-T40-1	57
107A-4-1	57
107A-5-1	57
107A-6-1	57
107A-7-1	57
109-11-4	58
109-13-4	58
109-19-4	60
109-23-4	60
109-35-4	60
109-37-4	61
112-06-1	61
112-07-1	61
112-08-1	61
112-09-1	61
112-10-1	61
112-11-1	61
112-12-1	61
112-13-1	61
112-14-1	61
112-15-1	61
112-16-1	61
112-17-1	61
112-18-1	61
112-19-1	61
112-20-1	61
112-21-1	61
112-22-1	61
113-07-1	61
113-08-1	61

Q	📖
113-09-1	61
113-10-1	61
113-11-1	61
113-12-1	61
113-13-1	61
113-14-1	61
113-16-1	61
113-17-1	61
113-19-1	61
115-20-1	62
115-22-1	62
115-24-1	62
115-40-1	63
115-42-1	62
115-43-1	62
115-44-1	63
115-46-1	63
115-48-1	63
115-70-1	62
115501	62
119-18-4	63
121-08-1	64
121-09-1	64
121-10-1	64
121-11-1	64
121-12-1	64
121-13-1	64
121-14-1	64
121-15-1	64
121-16-1	64
121-17-1	64
121-18-1	64
121-19-1	64
121-20-1	64
121-21-1	64
121-22-1	64
121-23-1	64
121-24-1	64
121-25-1	64
121-26-1	64
121-27-1	64
121-28-1	64
121-30-1	64
121-32-1	64
121-34-1	64
121-36-1	64
122-08-1	64
122-09-1	64
122-10-1	64
122-11-1	64
122-12-1	64
122-13-1	64
122-14-1	64
122-15-1	64
122-16-1	64
122-17-1	64



Q	Q	Q			
122-18-1	64	124A-20-1	65	131-36-1	74
122-19-1	64	124A-22-1	65	131-38-1	74
122-20-1	64	124A-24-1	65	131-40-1	74
122-21-1	64	124A-26-1	65	131-41-1	74
122-22-1	64	125-22-1	68	131-42-1	74
122-23-1	64	125-23-1	68	131-46-1	74
122-24-1	64	125-25-1	68	131-50-1	74
122-27-1	64	125-40-1	69	131-55-1	74
122-30-1	64	125-42-1	69	131-60-1	74
122-32-1	64	125-43-1	69	131B-19-2	75
122-34-1	64	125-44-1	69	131B-21-2	75
122-36-1	64	125-46-1	69	131B-22-2	75
122A-10-1	64	125-48-1	69	131B-23-2	75
122A-11-1	64	125-49-1	68	131B-24-2	75
122A-12-1	64	125-52-1	68	131B-26-2	75
122A-14-1	64	125-53-1	69	131B-27-2	75
122A-16-1	64	125-54-1	69	131B-29-2	75
122A-18-1	64	125-60-1	69	131B-30-2	75
122A-20-1	64	125-70-1	67	131B-32-2	75
122A-22-1	64	125-70-12DISP	68	131B-35-2	75
122A-24-1	64	125501	67	131B-36-2	75
122A-26-1	64	126-10-1	65	131B-38-2	75
122A-28-1	64	126-11-1	65	131B-41-2	75
122A-30-1	64	126-12-1	65	131B-46-2	75
122A-34-1	64	126-14-1	65	131B-50-2	75
122A-38-1	64	126-16-1	65	132A-28-1	75
122A-40-1	64	126-18-1	65	132A-30-1	75
123-10-1	65	126-20-1	65	132A-32-1	75
123-12-1	65	126-24-1	65	132A-34-1	75
123-13-1	65	129-10-4	68	132A-36-1	75
123-14-1	65	129-101-4	73	132A-40-1	75
123-15-1	65	129-108-4	72	132A-42-1	75
123-16-1	65	129-12-4	68	132A-44-1	75
123-17-1	65	129-172-4	73	132A-46-1	75
123-18-1	65	129-23-4	70	132A-48-1	75
123-19-1	65	129-33W-4	70	132A-52-1	75
123-21-1	65	129-58-4	71	132A-54-1	75
123-22-1	65	129-9H-4	66	132A-60-1	75
123-24-1	65	129-9T-4	66	132A-64-1	75
124-10-1	65	129A-103-4	72	135-21-1	75
124-11-1	65	129A-53-4	71	135-22-1	75
124-12-1	65	131-19-1	74	135-24-1	75
124-13-1	65	131-21-1	74	135-40-1	76
124-14-1	65	131-22-1	74	135-42-1	75
124-15-1	65	131-23-1	74	135-43-1	76
124-16-1	65	131-24-1	74	135-46-1	76
124-17-1	65	131-25-1	74	135-52-1	76
124-18-1	65	131-26-1	74	135-70-1	75
124-19-1	65	131-27-1	74	135-85-1	75
124-21-1	65	131-28-1	74	139-17-4	76
124-22-1	65	131-29-1	74	139-21-4	76
124-24-1	65	131-30-1	74	139-21B-4	77
124-27-1	65	131-32-1	74	1467-A01	158
124-30-1	65	131-33-1	74	149-164-4	74
124-32-1	65	131-34-1	74	15-0607-1	45
124A-18-1	65	131-35-1	74	15-0809-1	45

Q	📖
15-1011-1	45
15-12-W	45
15-1213-1	45
15-1415-1	45
15-1617-1	45
15-1719-1	45
15-1819-1	45
15-2022-1	45
15-2123-1	45
15-2426-1	45
15-2427-1	45
15-2528-1	45
15-2729-1	45
15-3032-1	45
15-3236-2	45
15-3641-2	45
15-8-H	45
15-8-W	45
160-07-1	77
160-08-1	77
160-10-1	77
160-11-1	77
160-12-1	77
160-13-1	77
160-14-1	77
160-15-1	77
160-16-1	77
160-17-1	77
160-18-1	77
160-19-1	77
160-20-1	77
160-21-1	77
160-24-1	77
161-10-1	77
161-13-1	77
161-17-1	77
162-00-1	78
162-02-1	78
162-50-1	78
162-60-1	78
162-65-1	78
162931	78
162941	78
167-08-1	79
167-10-1	79
167-10-4	80
167-11-4	80
167-12-1	79
167-13-1	79
167-14-1	79
167-15-1	79
167-16-1	79
167-17-1	79
167-18-1	79
167-19-1	79
167-20-1	79

Q	📖
167-21-1	79
167-22-1	79
167-23-1	79
167-24-1	79
167-26-1	79
167-27-1	79
167-30-1	79
167-32-1	79
167-34-1	79
167-36-1	79
167-38-1	79
167-41-1	79
167-9-4	80
168-10-1	79
168-11-1	79
168-13-1	79
168-14-1	79
168-14-4	80
168-16-1	79
168-17-1	79
168-18-1	79
168-19-1	79
168-21-1	79
168-22-1	79
168-23-1	79
168-24-1	79
168-27-1	79
168-30-1	79
168-32-1	79
168-7-4	79
169-01-1	81
169-02-1	81
169-03-1	81
169-25-1	81
169-60-1	81
169-65-1	81
169921	81
169931	81
173-01-5	82
173-17-2	82
173-18-2	82
173-19-2	82
173-21-2	82
173-22-2	82
173-23-2	82
173-24-2	82
173-27-2	82
173-28-2	82
173-29-2	82
173-30-2	82
173-32-2	82
173-33-2	82
173-34-2	82
173-36-2	82
173-38-2	82
173-41-2	82

Q	📖
173-46-2	82
173-50-2	82
173-55-2	82
173-60-2	82
174-17-2	82
174-19-2	82
174-21-2	82
174-22-2	82
174-24-2	82
174-27-2	82
174-30-2	82
174-32-2	82
174-33-2	82
174-34-2	82
174-36-2	82
174-41-2	82
175-01-2	83
175-02-2	83
175-10-2	83
175-25-2	82
175-60-2	83
175-65-2	83
175911	82
177-10-5	83
177-22-2	83
177-24-2	83
177-27-2	83
177-30-2	83
177-32-2	83
177-33-2	83
177-34-2	83
177-36-2	83
177-38-2	83
177-41-2	83
177-42-2	83
177-46-2	83
177-50-2	83
177-55-2	83
177-60-2	83
177-65-2	83
177-70-2	83
177-75-2	83
177-80-2	83
178-22-2	84
178-24-2	84
178-27-2	84
178-30-2	84
178-32-2	84
178-33-2	84
178-34-2	84
178-36-2	84
178-38-2	84
178-41-2	84
178-46-2	84
178-50-2	84
178-55-2	84



Q	📖	Q	📖	Q	📖
178-60-2	84	183-55-1	66	202451	87
179-00-2	84	183-55X-1	66	202461	87
179-01-2	84	183-60-1	66	202511	88
179-02-2	84	185-05-1	67	202521	88
179-52-2	84	185-06-1	67	202541	88
179-65-2	84	185-06X-1	67	202561	88
179931	82-84	185-08-1	67	202571	88
179941	84	185-08X-1	67	202581	88
18-06-1	42	185-10-1	67	202661	89
18-07-1	42	185-10X-1	67	202671	89
18-08-1	42	185-12-1	67	202681	89
18-09-1	42	185-12X-1	67	202761	89
18-10-1	42	185-14-1	67	202771	89
18-11-1	42	185-16-1	67	202781	89
18-12-1	42	18D-5-H	43	202811	88
18-12-H	42	18S-08-1	43	202821	88
18-13-1	42	18S-10-1	43	202831	88
18-14-1	42	18S-13-1	43	202841	88
18-15-1	42	18S-17-1	43	206-100	88
18-16-1	42	18S-19-1	43	206-125	88
18-17-1	42	18S-5-H	43	206-150	88
18-18-1	42	19-08-1	43	206721	87
18-19-1	42	19-10-1	43	206741	87
18-21-1	42	19-11-1	43	206761	87
18-22-1	42	19-12-1	43	206821	88
18-24-1	42	19-12-H	44	206831	88
18-27-1	42	19-13-1	43	206841	88
18-30-1	42	19-14-1	43	206851	88
18-32-1	42	19-17-1	43	207-100	87
18-8-H	42	19-19-1	43	207-125	87
180-04-1	66	19-8-H	44	207-150	87
180-05-1	66	190-6-135	103	207041	86
180-05X-1	66	190-7-135	103	207051	86
180-06-1	66	190-8-135	103	207061	86
180-06X-1	66	191-10-175	108	207071	86
180-07-1	66	191-12-175	108	216041	86
180-07X-1	66	191-13-175	108	216051	86
180-08-1	66	191-6-150	108	216061	86
180-08X-1	66	191-7-175	108	216071	86
180-10-1	66	191-8-175	108	217-50-B	89
180-10X-1	66	201231	86	25-06-1	40
180-12-1	66	201241	86	25-06-2	40
180-12X-1	66	201251	86	25-07-1	40
180-14-1	66	201261	86	25-07-2	40
180-17-1	66	201431	89	25-08-1	40
180-19-1	66	201451	89	25-08-2	40
183-20-1	66	201461	89	25-09-1	40
183-25-1	66	201471	89	25-09-2	40
183-27-1	66	202-100	87	25-10-1	40
183-30-1	66	202-125	87	25-10-2	40
183-40-1	66	202-150	87	25-100-2	40
183-40X-1	66	202401	87	25-11-1	40
183-45-1	66	202411	87	25-11-2	40
183-45X-1	66	202421	87	25-12-1	40
183-50-1	66	202431	87	25-12-2	40
183-50X-1	66	202441	87	25-12-H	41



Q	Q	Q	
25-12-W	41	25A-26-1	41
25-13-1	40	25A-26-2	41
25-13-2	40	25A-28-1	41
25-14-1	40	25A-28-2	41
25-14-2	40	25A-30-1	41
25-15-1	40	25A-30-2	41
25-15-2	40	25A-32-1	41
25-16-1	40	25A-32-2	41
25-16-2	40	25A-34-1	41
25-17-1	40	25A-36-1	41
25-17-2	40	25A-40-1	41
25-18-1	40	25A-44-1	41
25-18-2	40	25A-46-1	41
25-19-1	40	25A-48-1	41
25-19-2	40	25A-52-1	41
25-20-1	40	25A-58-1	41
25-20-2	40	25A-64-1	41
25-21-1	40	29-3550-2	49
25-21-2	40	29-5080-2	49
25-22-1	40	29-80120-2	49
25-22-2	40	29P-3550-2	49
25-23-1	40	29P-3550-A	49
25-23-2	40	29P-5080-2	49
25-24-1	40	29P-5080-A	49
25-24-2	40	29P-80120-2	49
25-25-1	40	29P-80120-A	49
25-25-2	40	3.6SDR	188
25-26-1	40	30-100-2	48
25-26-2	40	30-24-2	48
25-27-1	40	30-27-2	48
25-27-2	40	30-30-2	48
25-28-1	40	30-32-2	48
25-28-2	40	30-34-2	48
25-29-1	40	30-36-2	48
25-29-2	40	30-38-2	48
25-30-1	40	30-41-2	48
25-30-2	40	30-46-2	48
25-32-1	40	30-50-2	48
25-32-2	40	30-55-2	48
25-34-1	40	30-60-2	48
25-34-2	40	30-65-2	48
25-36-2	40	30-70-2	48
25-41-2	40	30-75-2	48
25-46-2	40	30-80-2	48
25-50-2	40	30-85-2	48
25-55-2	40	30-90-2	48
25-60-2	40	30-95-2	48
25-65-2	40	302-210-2	94
25-70-2	40	302-260-2	94
25-75-2	40	302-310-2	94
25-8-H	41	302-365-2	94
25-80-2	40	302-465-2	94
25-85-2	40	302-615-2	94
25-90-2	40	302-900-2	94
25-95-2	40	302S-210-2	94
254-1200-2	91	302S-260-2	94
254-150-2	91		
254-300-2	91		
254-450-2	91		
254-600-2	91		
254-900-2	91		
255011	90		
255021	90		
255031	90		
255041	90		
255051	90		
256001	90		
256011	90		
256031	90		
256041	90		
256131	90		
256141	90		
256151	90		
256161	90		
256181	90		
256201	90		
256231	90		
256241	90		
256251	90		
256261	90		
256281	90		
256301	90		
256321	90		
257-200-2	91		
257-300-2	91		
257-400-2	91		
257-500-2	91		
257-600-2	91		
258-100-2	90		
258-120-2	90		
258-160-2	90		
258-200-2	90		
258-250-2	90		
258-300-2	90		
25A-08-1	41		
25A-08-2	41		
25A-10-1	41		
25A-10-2	41		
25A-12-1	41		
25A-12-2	41		
25A-14-1	41		
25A-14-2	41		
25A-16-1	41		
25A-16-2	41		
25A-18-1	41		
25A-18-2	41		
25A-20-1	41		
25A-20-2	41		
25A-22-1	41		
25A-22-2	41		
25A-24-1	41		
25A-24-2	41		



Q	Q
302S-310-2	94
302S-365-2	94
302S-465-2	94
302S-615-2	94
302S-900-2	94
302T-210-2	94
302T-260-2	94
302T-310-2	94
302T-365-2	94
302T-465-2	94
302T-615-2	94
302T-900-2	94
303081	95
303111	95
303121	95
303131	95
303171	95
303201	95
303211	95
303221	95
303231	95
303241	95
303291	95
303301	95
303311	95
303321	95
303331	95
304-250-2	94
304-350-2	94
304-450-2	94
304-600-2	94
304-900-2	94
304F-250-2	94
304F-350-2	94
304F-450-2	94
304F-600-2	94
304F-900-2	94
304S-250-2	94
304S-350-2	94
304S-450-2	94
304S-600-2	94
304S-900-2	94
304T-250-2	94
304T-350-2	94
304T-450-2	94
304T-600-2	94
304T-900-2	94
307-1122-2	95
307-350-2	95
307-685-2	95
307-940-2	95
307S-1122-2	95
307S-350-2	95
307S-685-2	95
307S-940-2	95
31-30-2	48

Q	Q
31-32-2	48
31-36-2	48
31-41-2	48
31-46-2	48
31-50-2	48
31-55-2	48
31-60-2	48
31-65-2	48
31-70-2	48
31-75-2	48
31-80-2	48
31-85-2	48
321-42-1	96
321-BLADE-1	96
321161	96
321171	96
321281	96
321361	96
321501	96
321511	96
321551	96
330021	97
332-51-4	97
332-52-4	97
332S-030-2	97
333-003-2	97
333-004-2	97
333-006-2	97
333-008-2	97
333-010-2	97
333-012-2	97
333-014-2	97
333-016-2	97
333-018-2	97
333-020-2	97
333-022-2	97
333-024-2	97
333-026-2	97
333-028-2	97
333-030-2	97
407-10-200	100
407-12-250	100
407-14-250	100
407-4-100	100
407-4-75	100
407-5.5-100	100
407-5.5-125	100
407-6.5-125	100
407-6.5-150	100
407-8-150	100
407-8-175	100
408-2.5-75	100
408-3-100	100
408-3-200	100
408-3-75	100
408-3.5-100	100

Q	Q
408-4-100	100
408-4-125	100
408-4-250	100
408-5.5-125	100
408-5.5-150	100
408-5.5-25	100
408-5.5-300	100
408-6.5-150	100
408-6.5-25	100
408V-2.5-100	104
408V-3-100	104
408V-3.5-100	104
408V-4-100	104
408V-5.5-125	104
408V-6.5-150	104
408V-8-175	104
409-0-75	101
409-1-100	101
409-1-25	101
409-1-250	101
409-2-125	101
409-2-25	101
409-2-300	101
409-3-150	101
409-4-200	101
409V-0-100	104
409V-1-150	104
409V-2-175	104
409V-3-200	104
413-0-75	101
413-1-100	101
413-1-25	101
413-2-125	101
413-2-25	101
413-3-150	101
413-4-200	101
413V-0-100	105
413V-1-150	105
413V-2-175	105
413V-3-200	105
414-10-75	102
414-15-100	102
414-20-100	102
414-25-125	102
414-27-125	102
414-30-150	102
414-40-150	102
414-45-150	102
414-5-75	102
414-6-75	102
414-7-75	102
414-8-75	102
414-9-75	102
414V-10-100	105
414V-15-125	105
414V-20-125	105



Q	Q	Q
414V-25-150	457-20-1	470-H5-1
417-10-125	457-25-1	470-H6-1
417-11-125	457-27-1	470-H7-1
417-12-125	457-30-1	470-H8-1
417-13-125	457-40-1	470-PH1-1
417-14-125	457-45-1	470-PH2-1
417-3.2-125	457-50-1	470-PH3-1
417-4-125	457061	470-PH4-1
417-4.5-125	457071	470-T20-1
417-5-125	457081	470-T25-1
417-5.5-125	457091	470-T27-1
417-6-125	457101	470-T30-1
417-7-125	457151	470-T40-1
417-8-125	457201	470-T45-1
417-9-125	457251	470-T50-1
42-H10-200	457271	470-T55-1
42-H2-100	457301	470011
42-H2.5-100	457401	470051
42-H3-100	457451	471-18-1
42-H4-150	457501	471011
42-H5-150	458-02-1	474M-1/4-1
42-H6-200	458-8-F	474M-10-1
42-H8-200	458-9-H	474M-11-1
420-3-1	459-5-B	474M-12-1
427411	459-6-C	474M-13-1
429-03-1	459-6A-C	474M-3/8-1
429-04-1	459-6B-C	474M-5-H
429-10-1	459-6C-C	474M-5.5-1
42B-6-B	459V-3-1	474M-6-1
42B-H10-200	459V-6-C	474M-7-1
42B-H3-100	46-8-F	474M-8-1
42B-H4-150	46-9-H	474M-9-1
42B-H5-150	46-T10-100	474MR-10-1
42B-H6-200	46-T15-150	474MR-8-1
42B-H8-200	46-T20-150	475-1/4-125
45-00-1	46-T25-150	475-150PH1-1
45-01-1	46-T30-200	475-150PH2-1
45-02-1	46-T40-200	475-150PZ1-1
45-03-1	461-6-B	475-150PZ2-1
45-04-1	47-00-1	475-150T10-1
45-05-1	47-01-1	475-150T15-1
45-06-1	47-02-1	475-150T20-1
45-08-1	47-03-1	475-150T25-1
45-10-1	47-04-1	475-150T30-1
454-8-F	47-05-1	475-150T40-1
454-9-H	47-06-1	475-32-1
454091	47-08-1	475-32-8DISP
454101	47-10-1	475-32A-1
454151	470-10.0-1	475-4-1
454201	470-12.0-1	475-4.5-1
454251	470-14.0-1	475-5-1
454271	470-5.5-1	475-5.5-1
454301	470-6.5-1	475-50PH1-1
454401	470-8.0-1	475-50PH2-1
457-10-1	470-H10-1	475-50PH3-1
457-15-1	470-H4-1	475-50PZ1-1



Q	Q	Q
475-50PZ2-1	475-T30-1	5-300-2
475-50PZ3-1	475-T40-1	5-300C-1
475-50T10-1	475-T45-1	5-375-2
475-50T15-1	475-T5-1	5-375C-2
475-50T20-1	475-T50-1	5-4-W
475-50T25-1	475-T6-1	5-450-2
475-50T30-1	475-T7-1	5-450C-2
475-50T40-1	475-T8-1	500-240-1
475-50T6-1	475-T9-1	501-150-1
475-50T8-1	475-TR10-1	501-200-1
475-6.0-1	475-TR15-1	501-250-1
475-6.5-1	475-TR20-1	501-300-1
475-61-1	475-TR25-1	502-230-1
475-70-3.0-1	475-TR27-1	503-200-1
475-70-3.5-1	475-TR30-1	503-250-1
475-70-5.5-1	475-TR40-1	503-300-1
475-70-6.5-1	475A-25-1	504-150-1
475-70PH1-1	475A-50-1	504-175-1
475-70PH2-1	475A-50-1/2-1	504-200-1
475-70PH3-1	475A-60QR-1	504-250-1
475-70PZ1-1	475A-75QR-1	504-300-1
475-70PZ2-1	475A-M-150-1	506-150-1
475-70PZ3-1	475A-M-50-1	506-175-1
475-8.0-1	475A-M-75-1	506-200-1
475-89PH1-1	475D-PH1-1	51-06-1
475-89PH2-1	475D-PH2-1	51-07-1
475-89PH3-1	475D-PH3-1	51-08-1
475-89PZ1-1	475D-PZ1-1	51-09-1
475-89PZ2-1	475D-PZ2-1	51-10-1
475-89PZ3-1	475D-PZ3-1	51-11-1
475-89T10-1	475R-1/4-110	51-12-1
475-89T15-1	475R-1/4-30	51-13-1
475-89T20-1	475T-PH1-1	51-14-1
475-89T25-1	475T-PH2-2	51-15-1
475-89T27-1	475T-PH3-2	51-16-1
475-89T30-1	475T-PZ1-1	51-17-1
475-89T40-1	475T-PZ2-2	51-18-1
475-9-1	475T-PZ3-2	51-19-1
475-H3-1	478-4-1	51-20-1
475-H4-1	478-4-2	51-21-1
475-H5-1	48-9-H	51-22-1
475-H6-1	48-9C-H	51-23-1
475-PH0-1	48A-13-H	51-24-1
475-PH1-1	5-100-1	51-25-1
475-PH2-1	5-100-2	51-26-1
475-PH2G-1	5-100C-1	51-27-1
475-PH3-1	5-150-1	51-28-1
475-PZ0-1	5-150-2	51-29-1
475-PZ1-1	5-150C-1	51-30-1
475-PZ2-1	5-200-1	51-32-1
475-PZ3-1	5-200-2	51-8-W
475-T10-1	5-200C-1	511-100-1
475-T15-1	5-250-1	511-105-1
475-T20-1	5-250-2	511-110-1
475-T25-1	5-250C-1	511-115-1
475-T27-1	5-300-1	511-130-1

Q	📖
511-91-4	133
511-92-4	133
511501	136
512-010-1	133
512-012-1	133
513-002-1	133
513-003-1	133
513-004-1	133
513-005-1	133
513-006-1	133
513-008-1	133
513-010-1	133
513-91-4	134
513-92-4	134
514-002-1	133
514-003-1	133
514-004-1	133
514-005-1	133
514-006-1	133
515-002-1	134
515-003-1	134
515-004-1	134
515-005-1	134
515-006-1	134
515-007-1	134
515-008-1	134
515-009-1	134
515-010-1	134
515-91-4	135
516-002-1	134
516-003-1	134
516-004-1	134
516-005-1	134
516-006-1	134
516-008-1	134
517-120-1	135
517-130-1	135
517-135-1	135
517-140-1	135
517-145-1	135
517-150-1	135
517-91-4	135
518-004-1	135
518-006-1	135
519-91-4	134
519-92-4	135
519-93-4	136
52-06-1	46
52-07-1	46
52-08-1	46
52-09-1	46
52-10-1	46
52-11-1	46
52-12-1	46
52-13-1	46
52-14-1	46

Q	📖
52-15-1	46
52-16-1	46
52-17-1	46
52-18-1	46
52-19-1	46
52-20-1	46
52-21-1	46
52-22-1	46
52-23-1	46
52-24-1	46
52-25-1	46
52-26-1	46
52-27-1	46
52-28-1	46
52-29-1	46
52-30-1	46
52-32-1	46
52-8-W	46
520-13S-1	137
520-41-2	137
520-42-2	137
520-43-2	137
520-61-2	137
520-63-2	137
521-51-2	137
521-52-2	137
521-71-2	137
521-81-2	137
521-82-2	137
522-21-2	138
522-22-2	138
522-23-2	138
522-31-2	138
522-32-2	138
522-33-2	138
522-41-2	138
522-42-2	138
522-43-2	138
525-11-2	138
525-12-2	138
525-21-2	138
525-22-2	138
525-31-2	138
525-32-2	138
525-41-2	138
525-42-2	138
525-43-2	138
525-61-2	138
525-62-2	138
525-71-2	138
525-72-2	138
525-81-2	138
525-82-2	138
525-91-2	138
525-92-2	138
526-31-2	139

Q	📖
526-32-2	139
526-41-2	139
526-42-2	139
526-51-2	139
526-52-2	139
526-53-2	139
526-61-2	139
526-62-2	139
526-71-2	139
526-72-2	139
526-91-2	139
526-92-2	139
527-31-2	139
527-32-2	139
527-33-2	139
527-41-2	139
527-43-2	139
527-51-2	139
527-52-2	139
527-53-2	139
527-61-2	139
527-63-2	139
527-71-2	139
527-73-2	139
527-81-2	139
527-82-2	139
527-83-2	139
527-91-2	139
527-93-2	139
529021	141
529031	141
529041	141
529061	141
529071	141
529081	141
529091	141
529101	141
529151	141
529161	141
529171	141
529181	141
529191	141
529251	140
529261	140
529271	140
529291	140
529611	141
529621	141
529631	141
529701	141
529711	141
529721	141
529751	141
529761	141
529771	141
529781	141



Q	📖	Q	📖	Q	📖
529791	141	540121	180	612V-160-1	151
529801	141	546-265-1	158	612V-200-1	151
529811	141	546-265-4	158	613-160-1	145
529821	141	546-265-A	158	613-200-1	145
530-03-2	140	546-265-B	158	613V-160-1	151
530-05-2	140	546021	158	613V-200-1	151
530-07-2	140	546201	158	621551	154
530-13-2	140	546211	158	621561	154
530-15-2	140	546221	158	621571	154
531-05-2	140	546251	158	621581	154
531-07-2	140	548-275-1	158	621591	154
531-08-2	140	548-275-M3	158	621651	154
531-09-2	140	548-275-M4	158	621661	154
531-15-2	140	548-275-M5	158	621671	154
531-17-2	140	548-275-M6	158	621681	154
531-18-2	140	549-230-2	180	621691	154
531-19-2	140	550-80-4	180	621751	154
534251	172	551-HG-1	181	621761	154
534261	172	551-NOZ-1	181	621771	154
534281	172	560-41-1	182	621781	154
534291	172	560-41LP-1	181	621791	154
534311	173	560-BN-15	182	621851	154
534321	173	560-CA-10	182	621861	154
534341	173	560-CA-12	182	621871	154
534351	173	560-CA-14	182	621881	154
534371	173	560-HD-06	182	621891	154
534381	173	560-HD-08	182	624-140-1	145
534401	173	560-HD-10	182	624-160-1	145
534411	173	560-HD-12	182	624-180-1	144
534501	173	560-HD-14	182	624M-125-1	147
534521	172	560-HT-1	182	624V-140-1	151
534531	172	560-HTS-1	181	624V-160-1	151
534541	172	560-LD-06	182	625-180-1	145
534551	172	560-LD-08	182	625-200-1	145
534561	172	560-LD-10	182	625V-180-1	151
534571	172	560-LD-12	182	626M-125-1	148
534601	173	560-LD-14	182	629-160-1	148
534611	173	601-160-1	144	629V-160-1	152
534621	173	601-180-1	144	630-295T-4	150
534681	173	601-200-1	144	630-5HD-4	150
534691	173	601-3-C	146	630-61B1-4	149
534701	173	601911	154	630-B1-1	149
534901	173	601M-125-1	147	630-B2-1	149
534931	173	601V-160-1	150	630-B3 -1	149
534941	173	601V-180-1	150	631-200-1	153
536011	180	601V-200-1	150	632-220-1	153
538-140-1	159	601V-3-C	152	632-250-1	153
540021	180	602-3-C	146	632-280-1	153
540031	180	604-160-1	145	632D-250-1	153
540041	180	604-180-1	145	634-200-1	146
540051	180	604M-125-1	147	634-250-1	146
540061	180	604V-160-1	150	634-300-1	146
540071	180	608-160-1	146	634Q-250-1	146
540081	180	612-160-1	145	634V-250-1	152
540091	180	612-200-1	145	645011	157
540101	180	612M-125-1	147	645021	157



Q	
645031	157
645041	157
647-235-1	156
647-250-1	156
648-140-1	157
648-165-1	157
648-185-1	157
648-250-1	157
648-4-W	157
64A-190-1	155
64A-235-1	155
64B-190-1	155
64B-235-1	155
64C-300-1	156
64CA-175-1	156
64CA-300-1	156
64CA-450-1	156
64CAD-300-1	156
64L-165-1	155
64T-300-1	156
64W-300-1	155
651101	153
651111	153
651121	153
651131	153
651141	153
651201N	153
651201N2	153
651211N	153
651211N2	153
651221N	153
651221N2	153
651231N	153
651231N2	153
651241N	153
651241N2	153
655-160-1	148
655-200-1	148
661-140-1	161
661-140-12-DISP	161
661051	161
661061	161
664-200-1	160
665-200-1	160
666-156-1	159
667-135-1	159
668-150-1	159
669-175-1	159
669-190-1	160
670-178-1	160
671-150-1	160
672-220-1	159
701-130-1	164
701-130-B	164
701-160-1	164
701-160-B	164

Q	
701-160-K	164
701-160-S	164
701-200-1	164
701-200-B	164
701-250-1	164
701-250-B	164
701-250-K	164
701-250-S	164
701-350-1	164
701-350-B	164
701-90-1	164
701-90-B	164
701-90-K	164
701-90-S	164
702-40-1	164
702-40-B	164
702-40-K	164-165
702-40-P	164-165
702-40-S	164-165
702-65-1	164
702-65-K	164-165
702-65-S	164-165
702-80-1	164
702-80-K	164-165
702-80-S	164-165
703-40-1	165
703-40-B	165
703-65-1	165
703-80-1	165
71-UN7-1	49
71-UN9-1	49
713001	165
713011	165
713511	165
713521	165
713531	165
713541	165
713611	165
716-5-1	166
716-8-1	166
716-M11-1	166
716-M14-1	166
716-M18-1	166
716-M6-1	166
716-M8-1	166
718211	166
718231	166
720-1M-413	166
720-3M-413	166
720-LM-1	167
720031	167
722-4-1	161
730011	166
730131	166
7309-1-10	52
7309-1-11	52

Q	
7309-1-12	52
7309-1-13	52
7309-1-14	52
7309-1-17	52
7309-1-19	52
7309-1/2	53
7309-1/4	53
7309-125	52
7309-2-10	52
7309-2-11	52
7309-2-12	52
7309-2-13	52
7309-2-14	52
7309-2-17	52
7309-2-19	52
7309-3/8	53
7309-30	52
7309-60	52
7314-1-13	53
7314-1-14	53
7314-1-17	53
7314-1-19	53
7314-1-22	53
7314-1-24	53
7314-1-27	53
7314-1-30	53
7314-1-32	53
7314-1/2	53
7314-2-13	53
7314-2-14	53
7314-2-17	53
7314-2-19	53
7314-2-22	53
7314-2-24	53
7314-2-27	53
7314-2-30	53
7314-2-32	53
7314-2-36	53
7314-2-41	53
7314-200	52
7314-335	52
740-016-2	168
740-020-2	168
740-022-2	168
740-025-2	168
740-030-2	168
740-035-2	168
740-040-2	168
740-050-2	168
740S-008-2	168
740S-010-2	168
740S-012-2	168
740S-014-2	168
796491	165
796501	165
796511	165



Q	📖
796521	165
796531	165
796541	165
796551	165
796561	165
796571	165
800-111-1	171
800-131-1	170
800-141-1	171
800-151-1	170
801-011-1	172
801-041-1	171
801-145-1	172
801101	171
802-2400-1	170
802-2423-1	170
802-2451-1	170
802-3000-1	170
802-3023-1	170
802-3051-1	170
802-3600-1	170
802-3623-1	170
802-3651-1	170
803-318-5	171
803-318-50	171
803-324-5	171
803-324-50	171
803-332-5	171
803-332-50	171
805-3-C	142
806-6-B	142
810-2264-4	172
902021	27
902031	27
902131	27
9021FTW520	24
9021FTW520-AC1	24
9021FTW520-AC2	24
9021FTW520-AC3	24
9021FTW520-AC4	24
9021FTW520-AC5	24
9021FTW520FF1	24
9022-1-16SB	29
9022-1-19HB	29
9022-2-16HB	29
9022-2-19HB	29
9022-3-10	33
9022-3-20	31
9022-3-20TS1	31
9022-3-20TS2	31
9022-3-30	32
9022-3-30TS1	32
9022-3-30TS2	32
9022-3-40	32
9022-3-40TS1	32
9022-3-40TS2	32

Q	📖
9022-3-50	33
9022-3-50TS1	33
9022-4-35	31
9022-4-35TS1	31
9022-BP1	30
9022-BPW	30
9024-1TS1	28
9024-1TS145	28
9062-1500-1	26
9062-1800-1	26
9062-CAST-1	26
9062-FIX-1	26
9062-HOOK-1	26
9062-P1500-1	26
9062-P1800-1	26
9062FWB160	27
9063FT90	25
9063HT150	25
9063HT150FI	25
9063HT150SW	25
9063HT300	25
9063HT300FI	25
9063HT300SW	25
9064-15	14
9064AC01	14
9064K-02	25
9064K-02T	25
9065K4	14
9066K-01	14
9066K-02	14
9066K-03	14
9066K-05	14
9066K-06	14
9066K5	14
9066K6	14
9066K6FF100	15
9066K6FF101	16
9066K7	14
9066K7FF102	17
971-13-1	178
971-20-1	178
972-52-1	178
980-20S-1	177
980-3-1	176
980-3B-1	176
980-5-1	176
980-5-25-1	176
980-5B-1	176
980-5W-1	177
980-8B-1	176
980-TP2-1	176
980HV-3-1	176
980HV-5-1	176
981-1000-1	174
981-1200-1	174
981-1500-1	174

Q	📖
981-1800-1	174
981-2000-1	174
981-400-1	174
981-400M-1	174
981-600-1	174
981-600M-1	174
981-800-1	174
982-10-1	175
982-40-1	174
982-4M-1	174
982-60-1	174
982-6M-1	174
982-80-1	174
982-SET	175
982-TOR-1	175
983-25-1	175
984-6-1	179
984-6D-1	179
985-2-1	177
991-200-1	178
991-250-1	178
991-300-1	178
991-400-1	178
993-150-1	178
993-300-1	178
993-400-1	178
CEE-COUNT-IR-1	193
IFF1A001	18
IFF1A002	18
IFF1A003	18
IFF1A004	19
IFF1A005	19
IFF1A006	19
IFF1A007	20
IFF1E001	20
IFF1E002	20
IFF1E003	20
IFF1E004	20
IFF1E005	20
IFF1E006	20
IFF1E007	21
IFF1E008	21
IFF1E009	21
IFF1E010	21
IFF1E011	21
IFF1E012	21
IFF1E013	22
IFF1E014	22
IFF1E015	22
IFF1E016	22
IFF1E017	22
IFF1E018	22
IFF1E019	23
IFF1E021	23
IFF1E023	23
IFF1E024	23

Q	Q
IFF1E025	23
L-ALUM-1	185
L-ALUM-12DISP	185
L-BOOK-1	185
L-COMP-1	184
L-FLEX-1	184
L-FRONT-1	186
L-HEAD-1	186
L-MINI-1	185
L-SLIM-1	184
LT-420-1	179
MEE-1S2L-B-I	190-191
MEE-BANNER-I	192
MEE-COR-1L-B-I	191
MEE-COR-LIGHT-I	191
MEE-COUNT-IR-1	193
MEE-COUNT-IR-2	193
MEE-COUNT-IR-3	193
MEE-DB-W-NL	192
MEE-LIGHTBOX-I	191
MEE-SA-SS-IR	193
MEE-SIGN-CARR-I	190-191
MEE-TR-W-I	192
P-IW-12	187
P-IW-12C	187
P-IW-12P	187
P-IW-34	187
P700	188
P821	188
PEE-COUNT-006	193
PEE-METHACRYL-I	192
PEE-PC-IR-1	193
PEE-SIGN-DB-W-2	192
PEE-TOPSIGN-I	192
PM5002	188
PM5003	188
PM5012	188
PM5013	188
PM5142	188
PM5143	188
PM5152	188
PM5153	188
PM5248	188
PPOS-A4-STICK-I	193
T4901	129
T4902	129
T49H10	129
T49H10L	129
T49H10XL	129
T49H12	129
T49H12L	129
T49H14	129
T49H4	129
T49H4L	129
T49H5	129
T49H5L	129

Q	Q
T49H6	129
T49H6L	129
T49H7	129
T49H7L	129
T49H8	129
T49H8L	129
T49M10	130
T49M10L	130
T49M12	130
T49M12L	130
T49M14	130
T49M5	130
T49M5L	130
T49M6	130
T49M6L	130
T49M8	130
T49M8L	130
T49SQ10	130
T49SQ8	130
T49T20	129
T49T20H	130
T49T20HL	130
T49T20L	129
T49T25	129
T49T25H	130
T49T25HL	130
T49T25L	129
T49T27	129
T49T27H	130
T49T27HL	130
T49T27L	129
T49T30	129
T49T30H	130
T49T30HL	130
T49T30L	129
T49T30XL	67-130
T49T40	129
T49T40H	130
T49T40HL	130
T49T40L	129
T49T40XL	67-130
T49T45	129
T49T45H	130
T49T45HL	130
T49T45L	129
T49T45XL	67-130
T49T50	129
T49T50H	130
T49T50HL	130
T49T50L	129
T49T55	129
T49T55H	130
T49T55HL	130
T49T55L	129
T49T55XL	129
T49T60	129

Q	Q
T49T60H	130
T49T60HL	130
T49T60L	129
T49T70HL	67-130
T49T80HL	67-130
WB-300-2	136
WB-500-2	136
WB-625-2	136
WB-710-2	136
WB-900-2	136
ZH70610	167
ZH70611	167
ZH70612	167
ZH70613	167
ZH70614	167



HEXAGONAL FEMALE SCREWS

mm	mm.					mm	inch	U.S.A.			G.B.	
	DIN 912 DIN 6912	DIN 7984	DIN 7991	DIN 913-916	USAS B 18-3-1969			BS 2470-1954				
1.5	1.6-2		2.5	3	1/16"	1.59	Nº 1	Nº 3-Nº 4	Nº 5-Nº 6	6 BA	5 BA-4 BA	
2	2.5		3	4	5/64"	1.98	Nº 2-Nº 3	Nº 5-Nº 6	Nº 8	5 BA-4 BA	3 BA	
2.5	3		3.5-4	5	3/32"	2.38	Nº 4-Nº 5	Nº 8	Nº 10	3/16-2 BA-1 BA	3/16-2 BA-1 BA	
3	4	5	5	6	7/64"	2.78	Nº 6	Nº 10	1/4"		0 BA-1/4	
4	5	6	6	8	1/8"	3.17						
5	6	8	8	10	9/64"	3.57	Nº 8					
6	8		10	12	5/32"	3.97	Nº 10	1/4"	5/16"	3/16-2 BA-1 BA	5/16	
7		10	12	16	3/16"	4.75	1/4"	5/16"	3/8"	1/4-0 BA	3/8-BSP 1/8	
8	10	12	12		7/32"	5.55		3/8"	7/16"	5/16"	7/16	
9					1/4"	6.35	5/16"	7/16"	1/2"		1/2-BSP 1/4	
10	12	14	14-16	20	5/16"	7.94	3/8"	1/2"	5/8"	3/8-7/16"	5/8-BSP 3/8	
12	14	16-18	18-20	24	3/8"	9.52	7/16-1/2"	5/8"	3/4"	1/2"	3/4-BSP 1/2	
14	16-18	20-22			1/2"	12.70			7/8"	5/8"	7/8-BSP 5/8	
17	20-22	24			9/16"	14.29			1-1 1/8"	3/4-7/8"	1-BSP 3/4	
19	24-27				5/8"	15.88			1"	1"		
22	30				3/4"	19.05			1 1/2"	1"		

THREAD DIAMETERS AND DIAMETER/KEYS

mm	mm.					A.F.	mm	UNIFIED			U.S.A.			G.B.		
	ISO 972 1902	UNE 17052 1978	DIN 931 1970	NFE 27111 1930	DS 2074-5 1988			BS 1769	BS 1768	BS 1768	ASAB 18-2.2 ASAB 18-2.1	ASAB 18-2.1	ASAB 18-2.2	BS 916-1083	BA BS 57W BS 192	
3.2						3/32"	2.38									
3.5						1/8"	3.17									
4	1.6	1.6	1.6			5/32"	3.97									
4.5			2.3	2.5											7 BA	
5	2	2	2.6	3		3/16"	4.76								6 BA	
5.5																
6	2.5	2.5	3	3.5		7/32"	5.56								5 BA	
7	3	3	3.5	4-4.5		1/4"	6.35								4 BA	
8	4	4	4	5		9/32"	7.14								3 BA	
9																
10	5	5	5	5.5		5/16"	7.94								2 BA	
11						11/32"	8.73								1/8 W	
12						3/8"	9.52								1 BA	
13	6	6	6	6	1/4"	7/16"	11.11		1/4"	1/4"	1/4"	1/4"	0.413	10.49	0 BA	
14	7	7	7	7									0.445	11.30	3/16 W	
15																
16	8	8	8	8	5/16"	1/2"	12.70	1/4"	5/16"	5/16"	1/4"	5/16"	5/16"	0.525	13.34	5/16"
17						9/16"	14.29	5/16"	3/8"	3/8"	5/16"	3/8"	3/8"	0.600	15.24	3/8"
18						19/32"	15.08									5/16 W
19	10	10	10	9	3/8"	5/8"	15.88		7/16"	7/16"		7/16"		0.710	18.03	7/16"
21																
22	12	12	12	11	7/16"	3/4"	19.05	3/8"	1/2"	1/2"	7/16"	1/2"	7/16"	0.820	20.83	1/2"
23	14	14	14	12	1/2"	7/8"	22.22	7/16"	9/16"	9/16"	1/2"	9/16"	9/16"			7/16 W
24																
26	16	16	16	14		15/16"	23.81	1/2"	1/2"	1/2"	9/16"	5/8"	5/8"	0.920	23.37	9/16"
27						1"	25.40		5/8"	5/8"	9/16"	5/8"	5/8"	1.010	25.65	5/8"
28	18	18	18	18	5/8"	1 1/16"	26.99	5/8"			5/8"			1.100	27.94	11/16"
29						1 1/8"	28.58		3/4"	3/4"		3/4"	3/4"			5/8 W
30	20	20	20	20	1/4"	1 3/16"	30.16							1.200	30.48	3/4"
32						1 1/4"	31.75	3/4"								11/16 W
34	22	22	22	20	3/4"	1 5/16"	33.34		7/8"	7/8"	3/4"	7/8"	7/8"	1.300	33.02	7/8"
35														1.390	35.31	15/16"
36	24	24	24	22	7/8"	1 3/8"	34.92	7/8"			7/8"			1.480	37.59	1"
38						1 7/8"	36.51		1"	1"	7/8"	1"	1"			7/8 W
41	27	27	27	27	1"	1 1/2"	38.10				1"	1"	1"	1.480	37.59	1"
42						1 5/8"	41.28	1"	1 1/8"	1 1/8"	1"	1 1/8"	1 1/8"	1.670	42.42	1 1/8"
46	30	30	30	30	1 1/8"	1 11/16"	44.45	1 1/8"	1 1/8"	1 1/8"	1"	1 1/8"	1 1/8"	1.670	42.42	1 1/8"
50	33	33	33	33	1 1/4"	1 13/16"	46.04	1 1/8"	1 1/4"	1 1/4"	1 1/8"	1 1/4"	1 1/4"	1.860	47.24	1 1/4"
54						1 7/8"	47.62	1 1/4"			1 1/4"					
55	36	36	36	36	1 1/4"	2"	50.80	1 1/4"	1 1/4"	1 1/4"	1 1/4"	1 1/4"	1 1/4"	2.050	52.07	1 1/4 W
58																
60	36	36	36	39	1 3/8"	2 1/16"	52.39	1 3/8"	1 3/8"	1 3/8"	1 3/8"	1 3/8"	1 3/8"	2.220	56.39	1 1/2"
63						2 3/16"	55.56	1 3/8"	1 1/2"	1 1/2"	1 3/8"	1 1/2"	1 1/2"	2.410	61.21	1 5/8"
65	39	39	39	42	1 1/2"	2 1/4"	57.17	1 3/8"	1 1/2"	1 1/2"	1 3/8"	1 1/2"	1 1/2"	2.580	65.53	1 5/8 W
67																
70	45	45	45	45	1 1/2"	2 3/8"	60.32	1 1/2"			1 1/2"	1 5/8"	1 5/8"			1/2 W
71						2 7/16"	61.91				1 1/2"	1 5/8"	1 5/8"			
75	48	48	48	48	1 3/4"	2 9/16"	65.09				1 5/8"	1 5/8"	1 5/8"	2.760	70.10	1 3/4 W
77						2 3/4"	69.85	1 3/4"	1 3/4"	1 3/4"	1 3/4"	1 3/4"	1 3/4"			
80	52	52	52	52	1 7/8"	2 13/16"	71.44	1 3/4"	1 3/4"	1 3/4"	1 3/4"	1 7/8"	1 7/8"			
82						2 15/16"	74.61				1 7/8"	2"	2"	3.150	76.70	1 7/8 W
85						3"	76.20	2"	2"	2"	2"	2"	2"			2 W
88	56	56	56	56	2"	3 1/8"	79.38	2"			2"	2"	2"			
90						3 3/8"	85.72									
94	60	60	60	64	2 1/4"	3 1/2"	88.90				2 1/4"	2 1/4"	2 1/4"			
95														3.550	90.17	2 1/2"
100	68	68	68	68	2 1/2"	3 3/4"	95.25				2 1/2"	2 1/2"	2 1/2"			
105																
110	72	72	72	72	3"	3 7/8"	98.42				2 1/2"	2 3/4"	2 3/4"	3.890	98.81	2 3/4 W
115	80	80	80	80	3"	4 1/8"	104.78				2 3/4"	3"	3"	4.180	106.17	3"
116						4 1/4"	107.95									
120	85	85	85	80	3 1/4"	4 1/2"	114.30							4.530	115.06	3 1/4 W
						4 5/8"	117.48				3"			4.850	123.19	3 1/2 W



INCHES TO MM CONVERSION TABLE



inch.	mm	inch.	mm	inch.	mm	inch.	mm	
.	0.0039	0.1000	.	0.5512	14.0000	.	1.8898	48.0000
.	0.0079	0.2000	9/16"	0.5625	14.2875	.	1.9291	49.0000
.	0.0118	0.3000	.	0.5709	14.5000	.	1.9685	50.0000
1/64"	0.0156	0.3969	37/64"	0.5781	14.6844	2"	2.0000	50.8000
.	0.0157	0.4000	.	0.5906	15.0000	.	2.0079	51.0000
.	0.0197	0.5000	19/32"	0.5938	15.0813	.	2.0472	52.0000
.	0.0236	0.6000	39/64"	0.6094	15.4781	.	2.0866	53.0000
.	0.0276	0.7000	.	0.6102	15.5000	.	2.1260	54.0000
1/32"	0.0313	0.7938	5/8"	0.6250	15.8750	.	2.1654	55.0000
.	0.0315	0.8000	.	0.6299	16.0000	.	2.2047	56.0000
.	0.0354	0.9000	41/64"	0.6406	16.2719	.	2.2441	57.0000
.	0.0394	1.0000	.	0.6496	16.5000	2 1/4"	2.2500	57.1500
.	0.0433	1.1000	21/32"	0.6563	16.6688	.	2.2835	58.0000
3/64"	0.0469	1.1906	.	0.6693	17.0000	.	2.3228	59.0000
.	0.0472	1.2000	43/64"	0.6719	17.0656	.	2.3622	60.0000
.	0.0512	1.3000	11/16"	0.6875	17.4625	.	2.4016	61.0000
.	0.0551	1.4000	.	0.6890	17.5000	.	2.4409	62.0000
.	0.0591	1.5000	45/64"	0.7031	17.8594	.	2.4803	63.0000
1/16"	0.0625	1.5875	.	0.7087	18.0000	2 1/2"	2.5000	63.5000
.	0.0630	1.6000	23/32"	0.7188	18.2563	.	2.5197	64.0000
.	0.0669	1.7000	.	0.7283	18.5000	.	2.5591	65.0000
.	0.0709	1.8000	47/64"	0.7344	18.6531	.	2.5984	66.0000
.	0.0748	1.9000	.	0.7480	19.0000	.	2.6378	67.0000
5/64"	0.0781	1.9844	3/4"	0.7500	19.0500	.	2.6772	68.0000
.	0.0787	2.0000	49/64"	0.7656	19.4469	.	2.7165	69.0000
.	0.0827	2.1000	.	0.7677	19.5000	2 3/4"	2.7500	69.8500
.	0.0866	2.2000	25/32"	0.7813	19.8438	.	2.7559	70.0000
.	0.0906	2.3000	.	0.7874	20.0000	.	2.7953	71.0000
3/32"	0.0938	2.3813	51/64"	0.7969	20.2406	.	2.8346	72.0000
.	0.0945	2.4000	.	0.8071	20.5000	.	2.8740	73.0000
.	0.0984	2.5000	13/16"	0.8125	20.6375	.	2.9134	74.0000
7/64"	0.1094	2.7781	.	0.8268	21.0000	.	2.9528	75.0000
.	0.1181	3.0000	53/64"	0.8281	21.0344	.	2.9921	76.0000
1/8"	0.1250	3.1750	27/32"	0.8438	21.4313	3"	3.0000	76.2000
.	0.1378	3.5000	.	0.8465	21.5000	.	3.0315	77.0000
9/64"	0.1406	3.5719	55/64"	0.8594	21.8281	.	3.0709	78.0000
5/32"	0.1563	3.9688	.	0.8661	22.0000	.	3.1102	79.0000
.	0.1575	4.0000	7/8"	0.8750	22.2250	.	3.1496	80.0000
11/64"	0.1719	4.3656	.	0.8858	22.5000	.	3.1890	81.0000
.	0.1772	4.5000	57/64"	0.8906	22.6219	.	3.2283	82.0000
3/16"	0.1875	4.7625	.	0.9055	23.0000	.	3.2677	83.0000
.	0.1969	5.0000	29/32"	0.9063	23.0188	.	3.3071	84.0000
13/64"	0.2031	5.1594	59/64"	0.9219	23.4156	.	3.3465	85.0000
.	0.2165	5.5000	.	0.9252	23.5000	.	3.3858	86.0000
7/32"	0.2188	5.5563	15/16"	0.9375	23.8125	.	3.4252	87.0000
15/64"	0.2344	5.9531	.	0.9449	24.0000	.	3.4646	88.0000
.	0.2362	6.0000	61/64"	0.9531	24.2094	3 1/2"	3.5000	88.9000
1/4"	0.2500	6.3500	.	0.9646	24.5000	.	3.5039	89.0000
.	0.2559	6.5000	31/32"	0.9688	24.6063	.	3.5433	90.0000
17/64"	0.2656	6.7469	.	0.9843	25.0000	.	3.5827	91.0000
.	0.2756	7.0000	63/64"	0.9844	25.0031	.	3.6220	92.0000
9/32"	0.2813	7.1438	1"	1.0000	25.4000	.	3.6614	93.0000
.	0.2953	7.5000	.	1.0039	25.5000	.	3.7008	94.0000
19/64"	0.2969	7.5406	.	1.0236	26.0000	.	3.7402	95.0000
5/16"	0.3125	7.9375	.	1.0433	26.5000	.	3.7795	96.0000
.	0.3150	8.0000	.	1.0630	27.0000	.	3.8189	97.0000
21/64"	0.3281	8.3344	.	1.0827	27.5000	.	3.8583	98.0000
.	0.3346	8.5000	.	1.1024	28.0000	.	3.8976	99.0000
11/32"	0.3438	8.7313	.	1.1220	28.5000	.	3.9370	100.0000
.	0.3543	9.0000	.	1.1417	29.0000	4"	4.0000	101.6000
23/64"	0.3594	9.1281	.	1.1614	29.5000	.	4.3307	110.0000
.	0.3740	9.5000	.	1.1811	30.0000	4 1/2"	4.5000	114.3000
3/8"	0.3750	9.5250	.	1.2205	31.0000	.	4.7244	120.0000
25/64"	0.3906	9.9219	1 1/4"	1.2500	31.7500	5"	5.0000	127.0000
.	0.3937	10.0000	.	1.2598	32.0000	.	5.1181	130.0000
13/32"	0.4063	10.3188	.	1.2992	33.0000	.	5.5118	140.0000
.	0.4134	10.5000	.	1.3386	34.0000	.	5.9055	150.0000
27/64"	0.4219	10.7156	.	1.3780	35.0000	6"	6.0000	152.4000
.	0.4331	11.0000	.	1.4173	36.0000	.	6.2992	160.0000
7/16"	0.4375	11.1125	.	1.4567	37.0000	.	6.6929	170.0000
.	0.4528	11.5000	.	1.4961	38.0000	.	7.0866	180.0000
29/64"	0.4531	11.5094	1 1/2"	1.5000	38.1000	.	7.4803	190.0000
15/32"	0.4688	11.9063	.	1.5354	39.0000	.	7.8740	200.0000
.	0.4724	12.0000	.	1.5748	40.0000	8"	8.0000	203.2000
31/64"	0.4844	12.3031	.	1.6142	41.0000	.	9.8425	250.0000
.	0.4921	12.5000	.	1.6535	42.0000	10"	10.0000	254.0000
1/2"	0.5000	12.7000	.	1.6929	43.0000	20"	20.0000	508.0000
.	0.5118	13.0000	.	1.7323	44.0000	30"	30.0000	762.0000
33/64"	0.5156	13.0969	1 3/4"	1.7500	44.4500	40"	40.0000	1016.0000
17/32"	0.5313	13.4938	.	1.7717	45.0000	60"	60.0000	1524.0000
.	0.5315	13.5000	.	1.8110	46.0000	80"	80.0000	2032.0000
35/64"	0.5469	13.8906	.	1.8504	47.0000	100"	100.0000	2540.0000

What is a standard?

A standard is a document that provides requirements, specifications, guidelines or characteristics that can be used consistently to ensure that materials, products, processes and services are fit for their purpose.

What are the benefits of ISO International Standards?

ISO International Standards ensure that products and services are safe, reliable and of good quality. For business, they are strategic tools that reduce costs by minimizing waste and errors, and increasing productivity. They help companies to access new markets, level the playing field for developing countries and facilitate free and fair global trade.

IRIMO main product families

Socket wrenches

- ISO 2725, hand sockets, general dimensions; ISO 1174, driving squares. The standards define the limits to certain dimensions to avoid the play between the socket and the bolt, the accessibility to reach, and guarantee the correct torque transmission and to work with nuts and studs.
- ISO 1711, hand and impact sockets, define the minimum hardness that a socket should have, and the minimum torque that a socket should resist. This assures that only the right material has been used, and the socket will be able to be used without breakage risk.
- The profile of the sockets, hex and biex, was designed for a much better distribution of the strength far from the corners to avoid possible breakings. At the same time the transmission of the torque to the bolts and nuts is made out of the edges, protecting the life of the components.

Adjustable Wrenches

- Stands ISO 6787 standard torque values plus 30% without opening and deformation.
- General dimensions of adjustable wrenches according to ISO 6787 standard.
- Design forged in one piece.

Spanners-Wrenches

- Stands ISO 1711-1 standard torque values plus 30% without opening and deformation.
- Higher hardness according to ISO 1711-1, without fragility risk.
- Wrench end fitting tolerance according to ISO 691 gives higher performance and better transmission of the torque to the bolts and nuts.

Pliers

- ISO standards on pliers define, for each product family, the basic dimensions of the product. In addition to this, when applicable ISO standards also define:
 - Maximum acceptable deformations after a load test.
 - Maximum acceptable deformations after a torsion test.
 - Maximum acceptable cutting force tests.
- The most important ISO standards for pliers are:
 - ISO 5745 Pliers for gripping and manipulating – Dimensions and test values.
 - ISO 5746 Engineer’s and “Lineman’s” pliers – Dimensions and test values.
 - ISO 5749 Diagonal cutting nippers – Dimensions and test values.
 - ISO 8976 Multiple slip joint pliers – Dimensions and test values.
 - ISO 9242 Construction worker’s pincers – Dimensions and test values.
 - ISO 9243 Pliers and nippers – Carpenter’s pincers – Dimensions and test values.

Torque wrenches

ISO 6789 classifies the torque wrenches into different types (I, II) and classes (A, B, C, D, E, F).

The ISO standard assigns different accuracy levels (4% or 6%) depending on the type, class and max torque of each wrench.

This accuracy needs to be accomplished between 20% and 100% of the maximum torque of the wrench.

The standard also establishes the calibration procedure, conditions and frequency as well as other tests and product requirements.

IRIMO torque tools comply with ISO 6789 standard and SNA Europe offers calibration services in his internal After Sales Centers.

Screwdrivers

ISO standards on screwdrivers define the tip dimension, the minimum hardness and the minimum torque that they should resist.

After torque testing with the minimum value, screwdrivers shall not show any deformation on injuries at the tip:

- ISO 2380 Slotted screwdrivers – Dimensions, hardness and minimum torque values.
- ISO 8764 Phillips and Pozidriv screwdrivers – Dimensions, hardness and minimum torque values.
- ISO 2936 Hexagon screwdrivers – Dimensions, hardness and minimum torque values.

However, the IRIMO screwdrivers must meet Internal Standards that are above the ISO standard.

Internal torque values standards is 20% over the ISO standard for Slotted screwdrivers and 50% in Phillips and Pozidriv screwdrivers.

The combination of the raw material and hardness determines the performance of the blade, longer life and quality work Internal hardness; Minimum SNA Europe 58-59 HRc. Minimum ISO standards 54 HRc. TORX® drivers; torque values are evaluated with testing gauges of Acument Global Technologies Inc., licensor of TORX®.



SNA Europe is committed to providing its customers with products that are fully compliant with all regulations, international protocols and customer standards to which they are subject. In this respect, SNA Europe complies with appropriate international regulations and directives, including REACH, RoSH, WEEE, **CE**, Conflict Minerals, etc.

Regarding REACH European regulation N° 1907/2006, it requires suppliers of any product to inform the customer of the presence of substances of very high concern (SVHC) (<http://www.echa.europa.eu/candidate-list-table>) listed in the relevant and official list above a concentration of 0.1% weight by weight (w/w). The ECHA, European Chemicals Agency, recently added several chemical substances to the list and as of December, 2014 there are 161 substances in the Candidate List of SVHC. The compliance in REACH prevents the user from probable serious effects to human health (and/or) the environment, including carcinogenic, toxic and mutagenic categories.

The definition and aim of the RoHS directive is quite simple. The RoHS directive aims to restrict certain dangerous substances commonly used in electronic and electronic equipment. Any RoHS compliant component is tested for the presence of Lead (Pb), Cadmium (Cd), Mercury (Hg), Hexavalent chromium (Hex-Cr), Polybrominated biphenyls (PBB), and Polybrominated diphenyl ethers (PBDE).

The Waste Electrical and Electronic Equipment Directive (WEEE Directive) is the European Community directive 2012/19/EU on waste electrical and electronic equipment (WEEE) which, together with the RoHS Directive 2002/95/EC, became European Law in February 2003. The WEEE Directive set collection, recycling and recovery targets for all types of electrical goods, with a minimum rate of 4 kilograms per head of population per annum recovered for recycling by 2009.

The **CE** marking is the manufacturer's declaration that the product meets the requirements of the applicable EU directives.

The term Conflict Minerals refers to raw materials that come from a particular part of the world where conflict is occurring and affects the mining and trading of those materials. These are defined as columbite-tantalite, also known as coltan (from which tantalum is derived); cassiterite (tin); gold; wolframite (tungsten); or their derivatives; to be financing conflict in the Democratic Republic of the Congo or an adjoining country.

SNA Europe

For warranty info
please check your local website
www.irimo.com

Argentina

SNAE Argentina SRL
A.M. de Justo 1750 3° A
C1107AFJ - Capital Federal
Buenos Aires
Tel: +54 (11) 4313-1004
Fax: +54 (11) 4893-3553

Australia

SNAE Australia
3 Cooper Street, Smithfield,
NSW 2164
Tel: +61 (0) 2 8787 5700
Fax: +61 (0) 2 9756 6130

Belgium

Branch of SNA Europe (Benelux) BV
De Kleetlaan 12A Pegasus Park
1831 DIEGEM
Tel: +32 (0)2 726 03 03
info.be@bahco.com

Chile

Comercial SNAE Chile LTDA
Av. Americo Vesputio 2760-D
Conchali - Santiago - Chile
Tel: + 56 2 623 0203
Fax: + 56 2 623 5395

Česká republika

SNA Europe s.r.o.
Holadnská 2/4
639 00 Brno
Tel: +420 537 022 520
Fax: +420 537 022 200

Danmark

SNA Europe [Denmark] A/S
Vallensbækvej 40,
2605 Brøndby
Tel: +45 4363 0330
Fax: +45 4396 2456

Deutschland

SNA Europe [Germany]
Willettstraße 10
40822 Mettmann
Tel: +49 (0) 2104 833 83 0
Fax: +49 (0) 2104 833 83 7999

España

SNA Europe [Industries] Iberia SA
c/ Hilanderas, 1
(P.O. Box / Apdo de Correos nº 5)
C.P. 20303 Irún
Tel: +34 902 235 100 / +34 943 649 111
Fax: +34 943 649 120

Ελλάδα

SNA Europe
Λ. Βουλιαγμένης 604Γ
167 77 Ελληνικό, Αθήνα
Τηλ: +30 210 9914263
Info.gr@snaeurope.com

Export

SNA Europe
Antigua Carretera de Altube Km 5,5
P.O.Box 307
01080 VITORIA (Spain)
Tel: +34 945269711
Fax: +34 945165040

France

SNA EUROPE (France)
41 Boulevard Pierre de Coubertin
49 000 ANGERS
Tél: +33 (0) 2 41 22 98 40
Fax: +33 (0) 2 41 22 98 50

Italia

SNA EUROPE Italia S.p.A.
Via Georges Bizet, 13/15
20092 Cinisello Balsamo MI - Italia
Tel. +39 02 3024161
info.it@snaeurope.com

Казахстан

050000, Алматы,
ул.Шевченко 1656/72г, оф.217
Тел/факс +7 727323 63 39

México

54080, Av. Gustavo Baz Prada 180F,
San Jerónimo Tepetlacalco,
54030 Tlalnepantla de Baz, México
Tel: +52 55 5010 3000
Correo: contactanos@snapon.com

Nederland

SNA Europe [Benelux] BV
Vossenbeemd 113
5705 CL Helmond
Tel: +31 (0) 492 58 23 82
info.nl@bahco.com

New Zealand

SNAE New Zealand
Unit 3/25 Highbrook Drive
East Tamaki
Auckland
Tel: +64 9-273 46 50
Fax: +64-9-273-2453

Norge

SNA Europe [Norway]
Box 800
1306 Sandvika
Tel: +47 40 49 66 00
Fax: +47 67 17 56 51

Österreich

SNA Europe
Vienna, Nineteen, Mooslackengasse 17
A - 1190 Wien
Tel: +49 (0) 2104 8 33 83 0
Fax: +49 (0) 2104 833 83 79 99

Polska

SNA Europe - Poland Sp. z o. o.
ul. Marynarska 15
02-674 Warszawa
Tel.: +48 (0) 22 6070510
Fax: +48 (0) 22 6070521

Portugal

SNA Europe [Industries] LDA
R. Maria Julia M. Ramos - Junqueira
4480-254 Vila Do Conde
Tel. +351 252 650 131
Fax. +351 252 650 160

Slovenská republika

SNA Europe s.r.o.
Karadžičova 8/A
821 08 Bratislava
Tel: +421 (0)2 5939 6124
Fax: +421 (0)2 5939 6217

SRBIJA

Vermax-alati doo
Ul. Drage Spasić 35
11000 Beograd
Tel: +381 11 2360 500
Tel: +381 11 2360 900
Fax: +381 11 2361 147
e-mail: office@vermax.rs

Suomi

SNA Europe Oy
PL 6580
00002 Helsinki
Finland
Tel: +358 207 433 510
Fax: +358 207 433 525

Sverige

SNA Europe Industries AB
Box 83
SE-745 22 Enköping
Tel: +46 (0) 171-47 82 00
Fax: +46 (0) 171-47 82 38

Schweiz / Suisse

SNA Europe
Willettstraße 10
40822 Mettmann
Tel: +49 (0) 2104 833 83 0
Fax: +49 (0) 2104 833 83 7999

Türkiye

SNA E Endüstriyel Mam. San. Tic. Ltd. Şti.
Girne Mah. Maltepe Küçük San. Sitesi
F Blok No:19 Maltepe
İstanbul
Tel: +90 (0) 216 367 10 21
Fax: +90 (0) 216 367 11 71

Украина

«Бахко Бисов Свенска Акциеболаг»
SNA Europe [Ukraine & Moldova]
Телефон +38 067 441 16 09
офис 555, улица Армянская, 6А
Киев, Украина

United Kingdom

SNA Europe [UK]
Moorhead Way, Bramley,
Rotherham, South Yorkshire S66 1YY
Tel: +44 (0) 1709 731731
Fax: +44 (0) 1709 731741



IRIMO-ENG-25NP



8 414909 249538 >