

**T** R O N E X<sup>®</sup>



PRECISION & ECONOMY

# TWEEZERS

[WWW.TRONEXTOOLS.COM](http://WWW.TRONEXTOOLS.COM)

# T R O N E X<sup>®</sup>

# T W E E Z E R S

Tronex precision cutters and pliers are known all over the world for their unmatched quality, performance, comfort and value. Now Tronex has introduced a variety of precision and economy tweezers to our customers.

With an emphasis on quality craftsmanship, Tronex has sourced the best available tweezers, produced to exacting standards by toolmakers who have been producing tweezers for decades.

All tweezers offered by Tronex are inspected and tested in our USA facility by Tronex experts.

Symbol	Technical Description	Corrosion Resistance	Hardness and Resistance to Wear	Magnetic Properties
T	Titanium	Excellent	Very Good	Totally Non-Magnetic
SA	316L Austenitic Stainless Steel	Excellent	Good	Non Magnetic*
SP	17-4 Martensitic Stainless Steel	Very Good	Very Good	Non Magnetic*
SM	304 Austenitic Stainless Steel	Very Good	Very Good	Non Magnetic*
S2	302 Austenitic Stainless Steel	Good	Good	Non Magnetic*
S10	410 Martensitic Stainless Steel	Ok	Very Good	Magnetic
S40	440 Martensitic Stainless Steel	Ok	Very Good	Magnetic
C	Carbon Steel	Subject to corrosion in humid environments	Excellent	Magnetic

\*Austenitic Stainless Steel can occasionally become slightly magnetic from cold working as well as from slow cooling. If magnetism is critical, Titanium is the best choice.



## Table of Contents

Page

Precision Tweezers: Tronex USA tweezers, Swiss tweezers, Vomm tweezers and Italian tweezers

4-7

Economy Tweezers: Colored and Polished

8-10

Mini Tweezers

11

Titanium Tweezers

12-13

ESD Safe Tweezers

14-20

Reverse Acting Tweezers

21

Cutting Tweezers

22

Replaceable Tip Tweezers: Carobfib

23-24

Replaceable Tip Tweezers: Delrin

25

Replaceable Tip Tweezers: Ceramic

26

# PRECISION TWEEZERS

## Tronex USA Tweezers:

Tronex USA tweezers are made from 17-4ph stainless steel ideal for resistance to wear and corrosion. These tweezers are made to very exacting standards with extremely precise tips and finishing.

## Tronex Swiss (CH) Tweezers:

Tronex CH tweezers are made in Switzerland by a manufacturer who has been making tweezers for decades. They are made from high quality 316L stainless, making it very rust, chemical and acid resistant. They feature excellent craftsmanship and very precise tips.

## Vomm SA & ESD Safe Tweezers:

Tronex has partnered with the famous German tweezer manufacturer Vomm to represent Vomm in North America exclusively. Vomm has been manufacturing precision tweezers in Germany for over 50 years.

## Tronex Italy (M) Tweezers:

Tronex Italy tweezers are made from 316L stainless steel. They feature good craftsmanship and excellent value.

### STYLE: AA

GENERAL PURPOSE

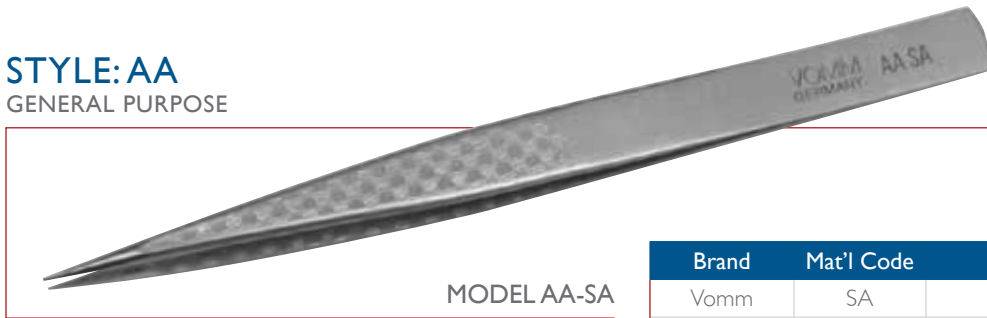

MODEL AA-SA  
MODEL AA-SA-M

Brand	Mat'l Code	Tips	Length	Finish
Vomm	SA	Very Fine	5.1 in / 130 mm	Polished
Tronex	SA	Fine	5.1 in / 130 mm	Polished

### STYLE: AC

STRONG BODY W/FINGER GROOVES



MODEL AC-SA

Brand	Mat'l Code	Tips	Length	Finish
Vomm	SA	Medium Fine	4.3 in / 110 mm	Polished

### STYLE: GG

TAPERED



MODEL GG-SA

Brand	Mat'l Code	Tips	Length	Finish
Vomm	SA	Very Fine	5.1 in / 130 mm	Polished

All tweezers shown actual size

**STYLE: PSF**  
GENERAL PURPOSE

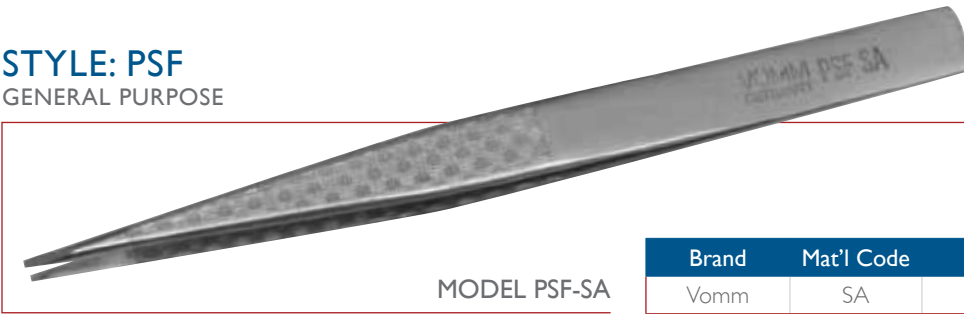

MODEL PSF-SA

Brand	Mat'l Code	Tips	Length	Finish
Vomm	SA	Sturdy Flat	5.1 in / 130 mm	Polished

**STYLE: SS**  
VERY THIN & LONG

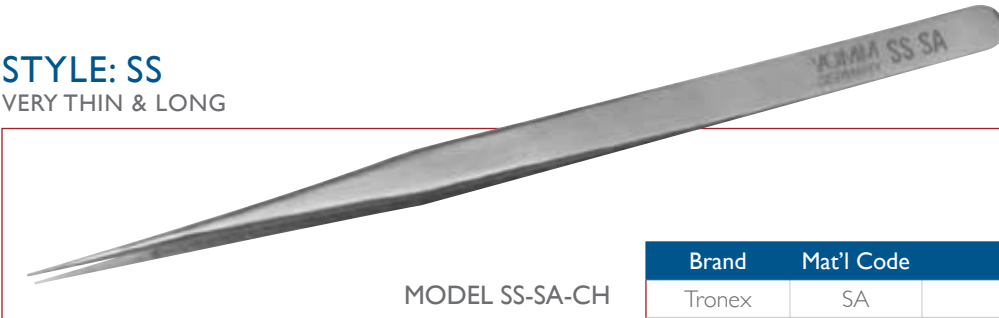

MODEL SS-SA-CH

MODEL SS-SA

Brand	Mat'l Code	Tips	Length	Finish
Tronex	SA	Fine	5.3 in / 135 mm	Polished
Vomm	SA	Fine	5.3 in / 135 mm	Polished

**STYLE: 00**  
STRONG BODY



MODEL 00-SA-CH

MODEL 00-SA

MODEL 00-SA-M

Brand	Mat'l Code	Tips	Length	Finish
Tronex	SA	Fine	4.7 in / 120 mm	Polished
Vomm	SA	Fine	4.7 in / 120 mm	Polished
Tronex	SA	Fine	4.7 in / 120 mm	Polished

**STYLE: 00D**  
SERRATED TIPS & FINGER GROOVES

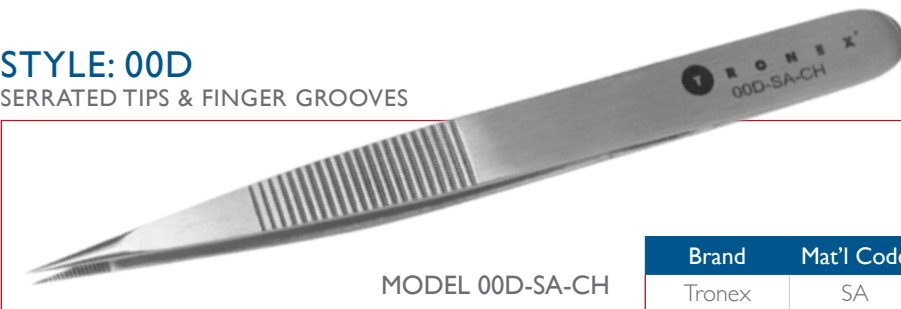

MODEL 00D-SA-CH

Brand	Mat'l Code	Tips	Length	Finish
Tronex	SA	Fine	4.7 in / 120 mm	Polished

**STYLE: 1**  
GENERAL PURPOSE, STRONG



MODEL 1-SP-US

MODEL 1-SA

Brand	Mat'l Code	Tips	Length	Finish
Tronex USA	SP	Fine	4.8 in / 123 mm	Polished
Vomm	SA	Very Fine	4.7 in / 120 mm	Polished

# PRECISION TWEEZERS

## STYLE: 2 TAPERED



MODEL 2-SA

Brand	Mat'l Code	Tips	Length	Finish
Vomm	SA	Very Fine	4.7 in / 120 mm	Polished

## STYLE: 2A SLIGHT TAPER

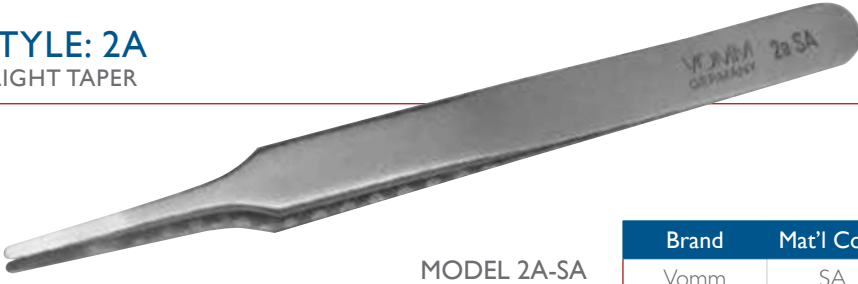

MODEL 2A-SA

Brand	Mat'l Code	Tips	Length	Finish
Vomm	SA	Blunt	4.7 in / 120 mm	Polished

## STYLE: 3 GENERAL PURPOSE, STRONG



MODEL 3-SP-US

MODEL 3-SA

Brand	Mat'l Code	Tips	Length	Finish
Tronex USA	SP	Fine	4.7 in / 120 mm	Polished
Vomm	SA	Very Fine	4.7 in / 120 mm	Polished

## STYLE: 3C GENERAL PURPOSE, LIKE 3 BUT SHORTER



MODEL 3C-SP-US

MODEL 3C-SA

MODEL 3C-SA-M

Brand	Mat'l Code	Tips	Length	Finish
Tronex USA	SP	Fine	4.3 in / 110 mm	Polished
Vomm	SA	Very Fine	4.3 in / 110 mm	Polished
Tronex	SA	Fine	4.3 in / 110 mm	Polished

## STYLE: 4 TAPERED



MODEL 4-SP-US

MODEL 4-SA

Brand	Mat'l Code	Tips	Length	Finish
Tronex USA	SP	Fine	4.6 in / 117 mm	Polished
Vomm	SA	Very Fine	4.3 in / 110 mm	Polished

All tweezers shown actual size

**STYLE: 5**

EXTRA TAPER



MODEL 5-SP-US  
MODEL 5-SA-CH  
MODEL 5-SA  
MODEL 5-SA-M

Brand	Mat'l Code	Tips	Length	Finish
Tronex USA	SP	Fine	4.6 in / 117 mm	Polished
Tronex	SA	Fine	4.3 in / 110 mm	Polished
Vomm	SA	Very Fine	4.3 in / 110 mm	Polished
Tronex	SA	Fine	4.3 in / 110 mm	Polished

**STYLE: 5A**

OFFSET

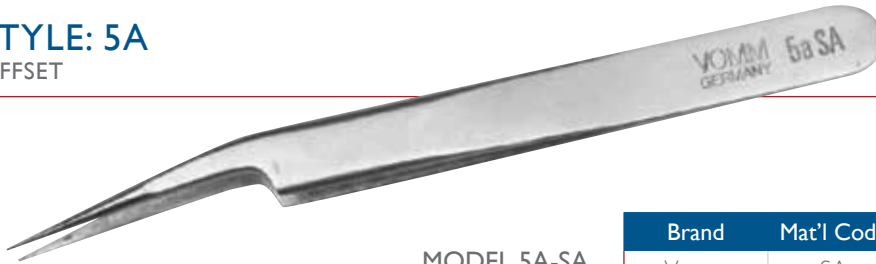

MODEL 5A-SA

Brand	Mat'l Code	Tips	Length	Finish
Vomm	SA	Very Fine	4.7 in / 120 mm	Polished

**STYLE: 6**

80 DEGREE ANGLE

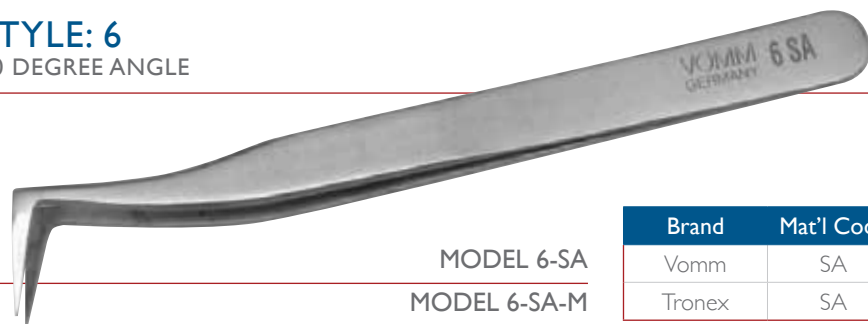

MODEL 6-SA  
MODEL 6-SA-M

Brand	Mat'l Code	Tips	Length	Finish
Vomm	SA	Very Fine	4.7 in / 120 mm	Polished
Tronex	SA	Fine	4.7 in / 120 mm	Polished

**STYLE: 7**

CURVED

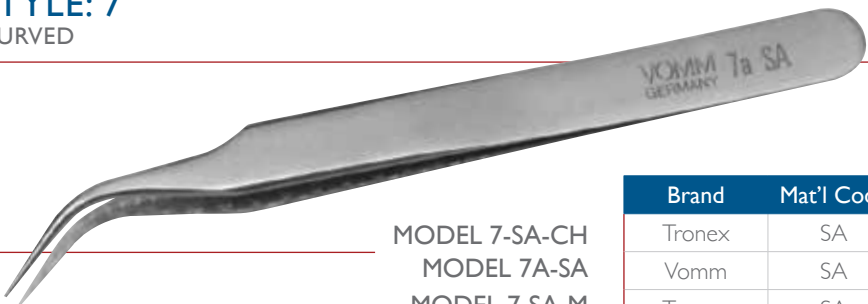

MODEL 7-SA-CH  
MODEL 7A-SA  
MODEL 7-SA-M

Brand	Mat'l Code	Tips	Length	Finish
Tronex	SA	Very Fine	4.7 in / 120 mm	Polished
Vomm	SA	Very Fine	4.7 in / 120 mm	Polished
Tronex	SA	Fine	4.7 in / 120 mm	Polished

**STYLE: ULTRA FINE TIPS**

FINE KNURLED CYLINDRICAL

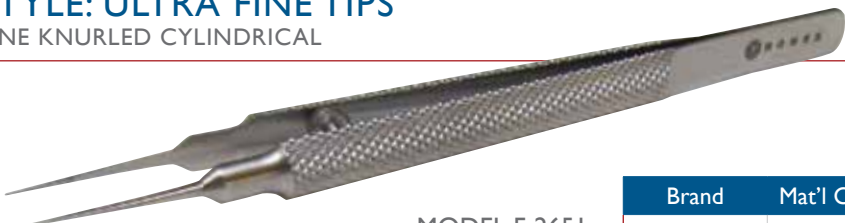

MODEL F-265 I

Brand	Mat'l Code	Tips	Length	Finish
Tronex USA	SP	Ultra Fine	4.5 in / 115 mm	Polished

# ECONOMY TWEEZERS

Tronex offers two types of Economy Tweezers: Tronex colored tweezers and Tronex polished finish tweezers. Both are excellent everyday, low cost tweezers. These tweezers are also available in kits, ideal for use with multiple work stations.

**STYLE: AA**  
GENERAL PURPOSE



Brand	Mat'l Code	Tips	Length	Finish
Tronex	S2	Medium Fine	4.9 in / 125 mm	Gold
Tronex	S10	Medium Fine	4.9 in / 125 mm	Polished

**STYLE: SS**  
VERY THIN & LONG



Brand	Mat'l Code	Tips	Length	Finish
Tronex USA	S2	Medium Fine	5.5 in / 140 mm	Red

**STYLE: 00**  
STRONG BODY



Brand	Mat'l Code	Tips	Length	Finish
Tronex	S10	Medium Fine	4.5 in / 115 mm	Polished

**STYLE: 1**  
GENERAL PURPOSE



Brand	Mat'l Code	Tips	Length	Finish
Tronex	S10	Medium Fine	4.5 in / 125 mm	Polished

All tweezers shown actual size



## STYLE: 2 TAPER



MODEL 2-S2b  
MODEL 2-S10

Brand	Mat'l Code	Tips	Length	Finish
Tronex	S2	Medium Fine Fine	4.3 in / 110 mm	Rose
Tronex	S10	Medium Fine Fine	4.5 in / 115 mm	Polished

## STYLE: 2A SLIGHT TAPER, ROUNDED TIPS



MODEL 2A-S2b  
MODEL 2A-S10

Brand	Mat'l Code	Tips	Length	Finish
Tronex	S2	Blunt	4.7 in / 120 mm	Brown
Tronex	S10	Blunt	4.5 in / 115 mm	Polished

## STYLE: 3 GENERAL PURPOSE



MODEL 3-S10

Brand	Mat'l Code	Tips	Length	Finish
Tronex	S10	Medium Fine	4.7 in / 120 mm	Polished

## STYLE: 3C GENERAL PURPOSE, LIKE 3 BUT SHORTER



MODEL 3C-S2b  
MODEL 3C-S10

Brand	Mat'l Code	Tips	Length	Finish
Tronex	S2	Medium Fine	4.3 in / 110 mm	Purple
Tronex	S10	Medium Fine	4.3 in / 110 mm	Polished

## STYLE: 4 TAPERED

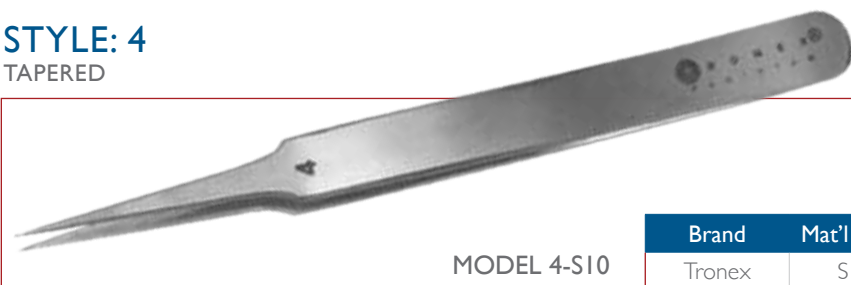

MODEL 4-S10

Brand	Mat'l Code	Tips	Length	Finish
Tronex	S10	Medium Fine	4.5 in / 115 mm	Polished

# ECONOMY TWEEZERS

## STYLE: 5 EXTRA TAPER



MODEL 5-S10

Brand	Mat'l Code	Tips	Length	Finish
Tronex	S10	Medium Fine	4.5 in / 115 mm	Polished

## STYLE: 5A OFFSET



MODEL 5A-S2b

Brand	Mat'l Code	Tips	Length	Finish
Tronex	S2	Medium Fine	4.5 in / 115 mm	Black

## STYLE: 7 CURVED



MODEL 7-S2b

MODEL 7-S10

Brand	Mat'l Code	Tips	Length	Finish
Tronex	S2	Medium Fine	4.5 in / 115 mm	Blue
Tronex	S10	Medium Fine	4.5 in / 125 mm	Polished

## STYLE: 27 GENERAL PURPOSE



MODEL 27-S2b

Brand	Mat'l Code	Tips	Length	Finish
Tronex	S2	Medium Fine	5.3 in / 125 mm	Light Brown

## ECONOMY KITS:



**MODEL 8-Mkit-S2b:**  
All 8 colored tweezers in magnetic closure case

**MODEL 8-Zkit-S2b:**  
All 8 colored tweezers in zipper closure case (pictured)



**MODEL 10-Mkit-S10:**  
All 10 polished tweezers in magnetic closure case (pictured)

**MODEL 10-Zkit-S10:**  
All 10 polished tweezers in zipper closure case

All tweezers shown actual size

# MINI TWEEZERS

Made in Switzerland from corrosion resistant stainless steel which is very similar to 316L stainless.

These special tweezers are often used under a microscope or in very restricted areas.

They have excellent craftsmanship and very precise tips.

Tweezers below shown actual size.



## STYLE: M2A

MINIATURE SLIGHT TAPER



MODEL M2A

Brand	Mat'l Code	Tips	Length	Finish
Tronex	SM	Blunt	2.75 in / 70 mm	Polished

## STYLE: M3C

MINIATURE SLIGHT TAPER  
EXTRA SHORT



MODEL M3C

Brand	Mat'l Code	Tips	Length	Finish
Tronex	SM	Fine	2.75 in / 70 mm	Polished

## STYLE: M5

MINIATURE TAPER



MODEL M5

Brand	Mat'l Code	Tips	Length	Finish
Tronex	SM	Fine	2.75 in / 70 mm	Polished

## STYLE: M7

MINIATURE CURVED



MODEL M7

Brand	Mat'l Code	Tips	Length	Finish
Tronex	SM	Curved	3.74 in / 95 mm	Polished

## TITANIUM TWEEZERS

Tronex Titanium tweezers are ideal for many clean room, chemical applications, and more humid environments. They are a particularly good choice when using magnetic materials, handling sensitive components and when soldering. Titanium tweezers hold their precise shape extremely well, are totally non-magnetic, are rust proof and can handle very high temperatures.

- Very light weight (40% lighter than steel)
- Very strong
- Totally non-magnetic
- Hypo-allergenic
- Rust proof
- Very acid resistant
- 40% lighter than steel
- Does not shed particles like steel
- Temperature resistant up to 800 Degrees F
- Solder does not adhere

### STYLE: AA GENERAL PURPOSE



MODEL AA-T

Brand	Mat'l Code	Tips	Length	Finish
Tronex	T	Very Fine	5.11 in / 130 mm	Polished

### STYLE: 00 STRONG BODY



MODEL 00-T

Brand	Mat'l Code	Tips	Length	Finish
Tronex	T	Medium Fine	4.72 in / 120 mm	Polished

### STYLE: 2 TAPERED



MODEL 2-T

Brand	Mat'l Code	Tips	Length	Finish
Tronex	T	Very Fine	4.92 in / 125 mm	Polished

### STYLE: 2A SLIGHT TAPER



MODEL 2A-T

Brand	Mat'l Code	Tips	Length	Finish
Tronex	T	Blunt	4.92 in / 125 mm	Polished

All tweezers shown actual size

**STYLE: 3**  
GENERAL PURPOSE



MODEL 3-T

Brand	Mat'l Code	Tips	Length	Finish
Tronex	T	Very Fine	4.92 in / 125 mm	Polished

**STYLE: 5**  
EXTRA TAPER



MODEL 5-T

Brand	Mat'l Code	Tips	Length	Finish
Tronex	T	Fine	4.33 in / 110 mm	Polished

**STYLE: 7**  
CURVED



MODEL 7-T

Brand	Mat'l Code	Tips	Length	Finish
Tronex	T	Very Fine	4.92 in / 125 mm	Polished

**STYLE:**  
FINE BENT W/ HOLES

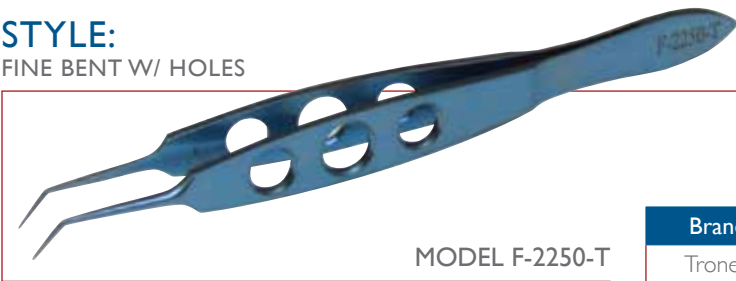

MODEL F-2250-T

Brand	Mat'l Code	Tips	Length	Finish
Tronex	T	Ultra Fine	3.93 in / 100 mm	Blue

## TITANIUM TWEEZER KIT



**MODEL 7-Mkit-T:** 7 titanium tweezers in magnetic case.  
Models AA-T, 00-T, 2-T, 2a-T, 3-T, 5-T, 7-T (does not include model F-2250-T)



# ESD SAFE TWEEZERS

Vomm has manufactured ESD safe tweezers for many years and is today a clear leader in producing these specialized precision tweezers. These ESD-Safe tweezers with black static dissipative coating are very effective in controlled environments.

**STYLE: AA**  
GENERAL PURPOSE

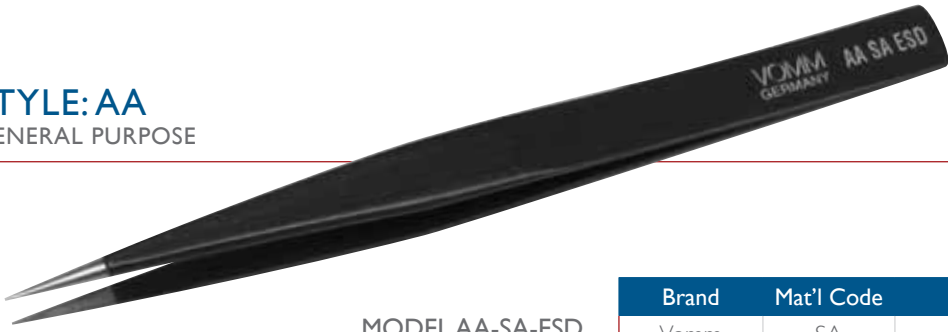

MODEL AA-SA-ESD

Brand	Mat'l Code	Tips	Length	Finish
Vomm	SA	Very Fine	5.11 in / 130 mm	ESD

**STYLE: GG**  
TAPERED



MODEL GG-SA-ESD

Brand	Mat'l Code	Tips	Length	Finish
Vomm	SA	Very Fine	5.11 in / 130 mm	ESD

**STYLE: PSF**  
GENERAL PURPOSE



MODEL PSF-SA-ESD

Brand	Mat'l Code	Tips	Length	Finish
Vomm	SA	Sturdy Flat	5.11 in / 130 mm	ESD

**STYLE: PSF**  
GENERAL PURPOSE W/ SERRATED TIPS



MODEL PSF-SA-ESD-S

Brand	Mat'l Code	Tips	Length	Finish
Vomm	SA	Serrated Flat	5.11 in / 130 mm	ESD

All tweezers shown actual size



**STYLE: SS**  
VERY THIN & LONG



MODEL SS-SA-ESD

Brand	Mat'l Code	Tips	Length	Finish
Vomm	SA	Fine	5.31 in / 135 mm	ESD

**STYLE: SSBB**  
VERY THIN & LONG, BENT TIP



MODEL SSBB-SA-ESD

Brand	Mat'l Code	Tips	Length	Finish
Vomm	SA	Very Fine	5.23 in / 133 mm	ESD

**STYLE: 00**  
STRONG BODY



MODEL 00-SA-ESD

Brand	Mat'l Code	Tips	Length	Finish
Vomm	SA	Fine	4.72 in / 120 mm	ESD

**STYLE: 1**  
GENERAL PURPOSE



MODEL 1-SA-ESD

Brand	Mat'l Code	Tips	Length	Finish
Vomm	SA	Very Fine	4.72 in / 120 mm	ESD



**STYLE: 2**  
TAPERED



MODEL 2-SA-ESD

Brand	Mat'l Code	Tips	Length	Finish
Vomm	SA	Very Fine	4.72 in / 120 mm	ESD

**STYLE: 2A**  
SLIGHT TAPER



MODEL 2A-SA-ESD

Brand	Mat'l Code	Tips	Length	Finish
Vomm	SA	Blunt	4.72 in / 120 mm	ESD

**STYLE: 3**  
GENERAL PURPOSE



MODEL 3-SA-ESD

Brand	Mat'l Code	Tips	Length	Finish
Vomm	SA	Very Fine	4.72 in / 120 mm	ESD

**STYLE: 3C**  
GENERAL PURPOSE



MODEL 3C-SA-ESD

Brand	Mat'l Code	Tips	Length	Finish
Vomm	SA	Very Fine	4.33 in / 110 mm	ESD

**STYLE: 4**  
TAPERED



MODEL 4-SA-ESD

Brand	Mat'l Code	Tips	Length	Finish
Vomm	SA	Very Fine	4.33 in / 110 mm	ESD

All tweezers shown actual size





## STYLE: 5 EXTRA TAPER



MODEL 5-SA-ESD

Brand	Mat'l Code	Tips	Length	Finish
Vomm	SA	Very Fine	4.33 in / 110 mm	ESD

## STYLE: 5ABB OFFSET W/ BENT TIP



MODEL 5ABB-SA-ESD

Brand	Mat'l Code	Tips	Length	Finish
Vomm	SA	Very Fine	4.60 in / 117 mm	ESD

## STYLE: 5BB TAPERED W/ 45 DEGREE, BENT TIPS



MODEL 5bb-SA-ESD

Brand	Mat'l Code	Tips	Length	Finish
Vomm	SA	Very Fine	4.21 in / 107 mm	ESD

## STYLE: 7A CURVED



MODEL 7A-SA-ESD

Brand	Mat'l Code	Tips	Length	Finish
Vomm	SA	Very Fine	4.72 in / 120 mm	ESD

## STYLE: 7ABB CURVED W/ REVERSE BENT TIPS



MODEL 7ABB-SA-ESD

Brand	Mat'l Code	Tips	Length	Finish
Vomm	SA	Very Fine	4.72 in / 120 mm	ESD

# ESD SAFE TWEEZERS



## STYLE: 8B

CHIP HANDLING TIPS, BENT



MODEL 8B-SA-ESD

Brand	Mat'l Code	Tips	Length	Finish
Vomm	SA	Flat	4.72 in / 120 mm	ESD

## STYLE: 22

LONG & THIN W/SERRATED TIPS & GUIDE



MODEL 22-SA-ESD

Brand	Mat'l Code	Tips	Length	Finish
Vomm	SA	Blunt	6 in / 152 mm	ESD

## STYLE: 22b

LONG STURDY BENT W/SERRATED TIPS & GUIDE



MODEL 22b-SA-ESD

Brand	Mat'l Code	Tips	Length	Finish
Vomm	SA	Blunt Serrated	6.10 in / 155 mm	ESD

## STYLE: 40

STURDY GENERAL PURPOSE



MODEL 40-SA-ESD

Brand	Mat'l Code	Tips	Length	Finish
Vomm	SA	Round Serrated	5.70 in / 145 mm	ESD

## STYLE: 50

TRANSISTER HANDLING



MODEL 50-SA-ESD

Brand	Mat'l Code	Tips	Length	Finish
Vomm	SA	3 mm x 8 mm	4.72 in / 120 mm	ESD

All tweezers shown actual size



## STYLE: 51

CYLINDRICAL COMPONENT HANDLING



MODEL 51-SA-ESD

Brand	Mat'l Code	Tips	Length	Finish
Vomm	SA	6.5 mm x 1.5 mm	4.72 in / 120 mm	ESD

## STYLE: 52

CYLINDRICAL COMPONENT HANDLING



MODEL 52-SA-ESD

Brand	Mat'l Code	Tips	Length	Finish
Vomm	SA	6.5 mm x 3.5 mm	4.72 in / 120 mm	ESD

## STYLE: 53

CYLINDRICAL COMPONENT HANDLING



MODEL 53-SA-ESD

Brand	Mat'l Code	Tips	Length	Finish
Vomm	SA	6.5 mm x 6.5 mm	4.72 in / 120 mm	ESD

## STYLE: 58

COMPONENT HANDLING



MODEL 58-SA-ESD

Brand	Mat'l Code	Tips	Length	Finish
Vomm	SA	3.5 mm x 0.8 mm	4.60 in / 117 mm	ESD

## STYLE: 59

COMPONENT HANDLING



MODEL 59-SA-SMD-ESD

Brand	Mat'l Code	Tips	Length	Finish
Vomm	SA	2.05 mm x 0.8 mm	4.60 in / 117 mm	ESD



# REVERSE ACTING TWEEZERS

**STYLE: R3**  
REVERSE ACTING STYLE 3



MODEL R3-SA-ESD

Brand	Mat'l Code	Tips	Length	Finish
Vomm	SA	Very Fine	4.52 in / 115 mm	ESD

**STYLE: R5**  
REVERSE ACTING STYLE 5



MODEL R5-SA-ESD

Brand	Mat'l Code	Tips	Length	Finish
Vomm	SA	Very Fine	4.13 in / 105 mm	ESD

**STYLE: R7a**  
REVERSE ACTING STYLE 7



MODEL R7a-SA-ESD

Brand	Mat'l Code	Tips	Length	Finish
Vomm	SA	Very Fine	4.52 in / 115 mm	ESD

**STYLE: R10**  
REVERSE CHIP HOLDING



MODEL R10-SA-ESD

Brand	Mat'l Code	Tips	Length	Finish
Vomm	SA	Chip Holding	4.60 in / 117 mm	ESD

All tweezers shown actual size

# REVERSE ACTING TWEEZERS

**STYLE: R2A**  
REVERSE ACTING STYLE 2A



MODEL R-2A-SA-CH

Brand	Mat'l Code	Tips	Length	Finish
Tronex	SA	Blunt	4.52 in / 115 mm	Polished

**STYLE: R30**  
REVERSE ACTING  
STYLE 30



MODEL R30-SA-CH

Brand	Mat'l Code	Tips	Length	Finish
Tronex	SA	Blunt	6.1 in / 155 mm	Polished

**STYLE: TS**  
REVERSE ACTING

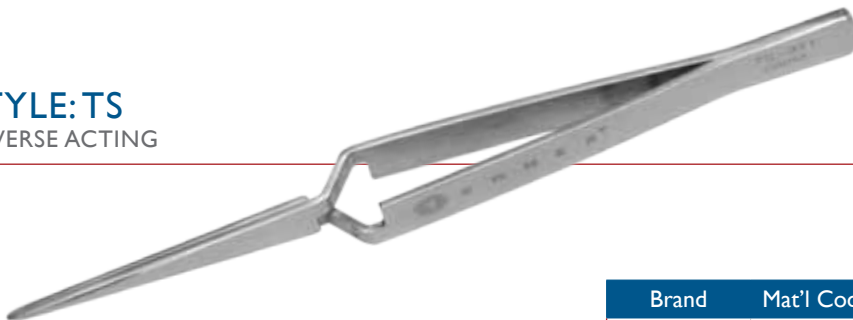

MODEL TS-321

Brand	Mat'l Code	Tips	Length	Finish
Tronex	C	Blunt	4.52 in / 115 mm	Plated

# CUTTING TWEEZERS

## STYLE: 15AB

MEDIUM CUTTING

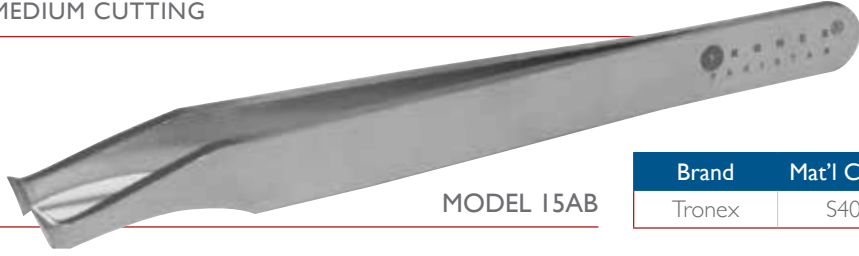

MODEL 15AB

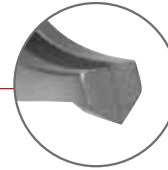

Brand	Mat'l Code	Tips	Length	Finish
Tronex	S40	Mini Taper	4.52 in / 115 mm	Polished

## STYLE: 15AP

LARGE CUTTING HEAD  
PARALLEL CUT



MODEL 15AP

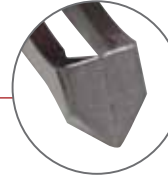

Brand	Mat'l Code	Tips	Length	Finish
Tronex	C	Pointed	4.33 in / 110 mm	Polished

## STYLE: 15AR

SMALL CUTTING HEAD  
ROUNDED

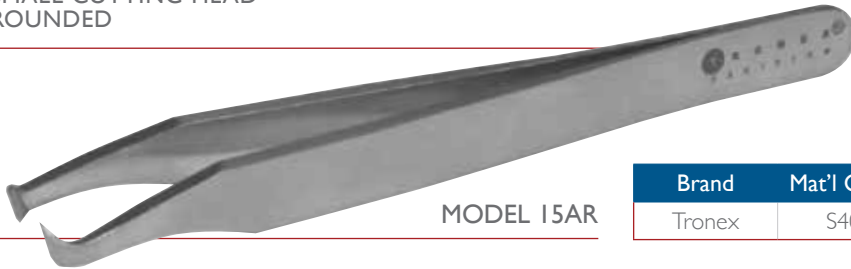

MODEL 15AR

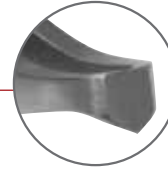

Brand	Mat'l Code	Tips	Length	Finish
Tronex	S40	Mini Oval	4.52 in / 115 mm	Polished

## STYLE: 15FW

THIN CUTTING HEAD

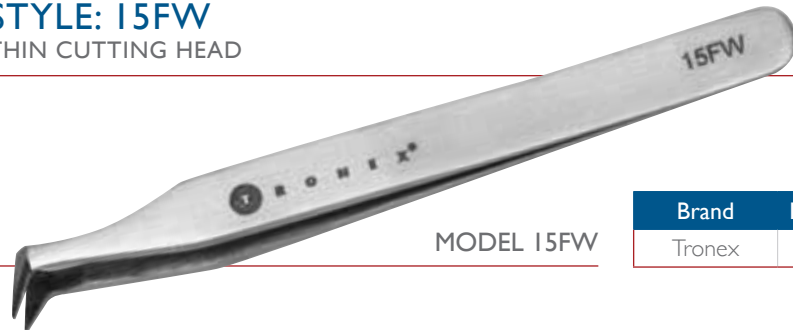

MODEL 15FW



Brand	Mat'l Code	Tips	Length	Finish
Tronex	S2	Rounded	4.33 in / 110 mm	Polished

## STYLE: 15AGW

LARGE CUTTING

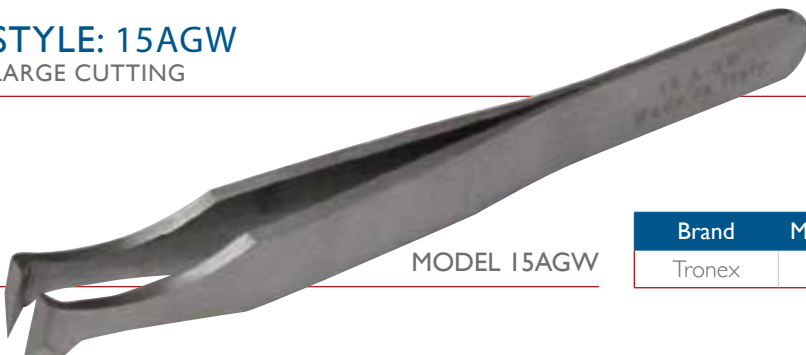

MODEL 15AGW

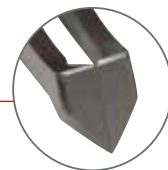

Brand	Mat'l Code	Tips	Length	Finish
Tronex	C	Pointed	4.52 in / 115 mm	Polished

All tweezers shown actual size

# CARBOFIB TIP TWEEZERS

Tronex Carbofib Replaceable Tip Tweezers are a great option for handling sensitive components.

- Tips are conductive
- Non-marring/non scratching
- Resistance up to 249° F/121° C
- Good Chemical resistance
- Made from 30% carbon fibers with high tech polymers

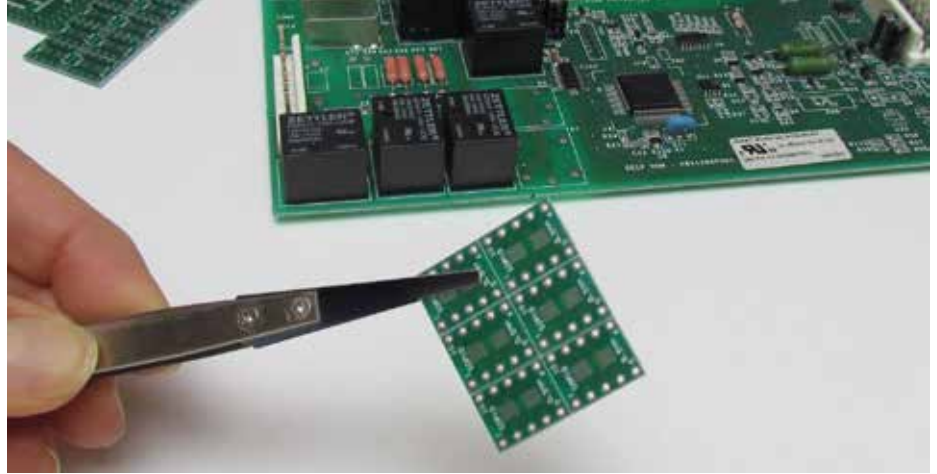

## STYLE: PSF GENERAL PURPOSE



MODEL PSF-CB-SA

Brand	Mat'l Code	Tips	Length	Finish
Tronex	SM	Sturdy Flat	5.11 in / 130 mm	Polished

## STYLE: 00 STRONG BODY



MODEL 00-CB-SA

Brand	Mat'l Code	Tips	Length	Finish
Tronex	SM	Fine	5.11 in / 130 mm	Polished

## STYLE: 2 TAPERED

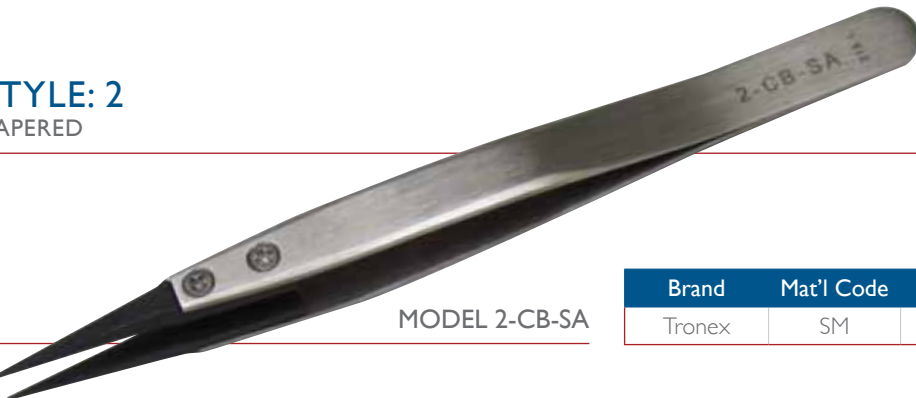

MODEL 2-CB-SA

Brand	Mat'l Code	Tips	Length	Finish
Tronex	SM	Very Fine	5.11 in / 130 mm	Polished

# REPLACEABLE TIP TWEEZERS

## STYLE: 2A SLIGHT TAPER



MODEL 2A-CB-SA

Brand	Mat'l Code	Tips	Length	Finish
Tronex	SM	Blunt	5.11 in / 130 mm	Polished

## STYLE: 3 GENERAL PURPOSE



MODEL 3-CB-SA

Brand	Mat'l Code	Tips	Length	Finish
Tronex	SM	Very Fine	5.11 in / 130 mm	Polished

## STYLE: 5 EXTRA TAPER



MODEL 5-CB-SA

Brand	Mat'l Code	Tips	Length	Finish
Tronex	SM	Very Fine	5.11 in / 130 mm	Polished

## STYLE: 7 CURVED



MODEL 7-CB-SA

Brand	Mat'l Code	Tips	Length	Finish
Tronex	SM	Very Fine	5.11 in / 130 mm	Polished

All tweezers shown actual size



# DELTRIN TIP TWEEZERS

Tronex Delrin Replaceable Tip Tweezers are a great option for handling sensitive components at lower temperatures.

- Tips are insulative
- Non-marring/non scratching
- Acid resistant
- Resistance to temps up to 185 ° F/65° C

## STYLE: 00 STRONG BODY



MODEL 00-DL-SA

Brand	Mat'l Code	Tips	Length	Finish
Tronex	SM	Fine	5.11 in / 130 mm	Polished

## STYLE: 2A SLIGHT TAPER



MODEL 2A-DL-SA

Brand	Mat'l Code	Tips	Length	Finish
Tronex	SM	Blunt	5.11 in / 130 mm	Polished

## STYLE: 3 GENERAL PURPOSE



MODEL 3-DL-SA

Brand	Mat'l Code	Tips	Length	Finish
Tronex	SM	Very Fine	5.11 in / 130 mm	Polished

## STYLE: 7 CURVED

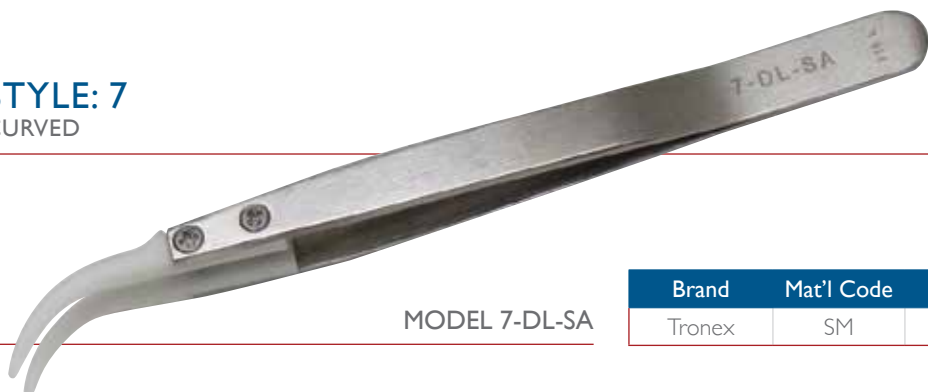

MODEL 7-DL-SA

Brand	Mat'l Code	Tips	Length	Finish
Tronex	SM	Very Fine	5.11 in / 130 mm	Polished

# CERAMIC TIP TWEEZERS

Tronex Ceramic Replaceable Tip Tweezers are a great option for handling sensitive components at high temperatures.

- Anti-static ceramic tips
- Harder than stainless steel, excellent for soldering
- ESD safe
- Can withstand temps of up to 1832° F/1000° C

**STYLE: 00**  
STRONG ROUNDED BODY



MODEL CER-00-SA

Brand	Mat'l Code	Tips	Length	Finish
Tronex	SM	Cer.Tips Fine	4.72 in / 120 mm	Polished

**STYLE: 1**  
GENERAL PURPOSE



MODEL CER-1-SA

Brand	Mat'l Code	Tips	Length	Finish
Tronex	SM	Cer.Tips Very Fine	4.72 in / 120 mm	Polished

**STYLE: 2a**  
SLIGHT TAPER



MODEL CER-2A-SA

Brand	Mat'l Code	Tips	Length	Finish
Tronex	SM	Blunt	4.72 in / 120 mm	Polished

All tweezers shown actual size

# INDEX MODEL BY NUMBER

MODEL #	PAGE#	MODEL #	PAGE#	MODEL #	PAGE#
00-CB-SA	23	3-SP-US	6	7A-SA	7
00-DL-SA	25	3-T	13	7A-SA-ESD	17
00-S10	8	3C-S10	9	7ABB-SA-ESD	17
00-SA	5	3C-S2b	9	8-MKIT-S2b	10
00-SA-CH	5	3C-SA	6	8-ZKIT-S2B	10
00-SA-ESD	15	3C-SA-ESD	16	8B-SA-ESD	18
00-SA-M	5	3C-SA-M	6	AA-S10	8
00-T	12	3C-SP-US	6	AA-S2b	8
00D-SA-CH	5	4-S10	9	AA-SA	4
1-S10	8	4-SA	6	AA-SA-ESD	14
1-SA	5	4-SA-ESD	16	AA-SA-M	4
1-SA-ESD	15	4-SP-US	6	AA-T	12
1-SP-US	5	40-SA-ESD	18	AC-SA	4
10-MKIT-S10	10	5-CB-SA	24	CER-00-SA	26
10-ZKIT-S10	10	5-S10	10	CER-1-SA	26
15AB	22	5-SA	7	CER-2A-SA	26
15AGW	22	5-SA-CH	7	F-2250-T	13
15AP	22	5-SA-ESD	17	F-2651	7
15AR	22	5-SA-M	7	GG-SA	4
15FW	22	5-SP-US	7	GG-SA-ESD	14
2-CB-SA	23	5-T	13	M2A	11
2-S10	9	50-SA-ESD	18	M3C	11
2-S2b	9	51-SA-ESD	19	M5	11
2-SA	6	52-SA-ESD	19	M7	11
2-SA-ESD	16	53-SA-ESD	19	PSF-CB-SA	23
22-SA-ESD	18	58-SA-ESD	19	PSF-SA	5
2T	12	59-SA-SMD-ESD	19	PSF-SA-ESD	14
22b-SA-ESD	18	5A-S2b	10	PSF-SA-ESD-S	14
27-S2b	10	5A-SA	7	R10-SA-ESD	20
2A-CB-SA	24	5ABB-SA-ESD	17	R2A-SA-CH	21
2A-DL-SA	25	5bb-SA-ESD	17	R3-SA-ESD	20
2A-S10	9	6-SA	7	R30-SA-CH	21
2A-S2b	9	6-SA-M	7	R5-SA-ESD	20
2A-SA	6	7-CB-SA	24	R7a-SA-ESD	20
2A-SA-ESD	16	7-DL-SA	25	SS-S2b	8
2A-T	12	7-MKIT-T	13	SS-SA	5
3-CB-SA	24	7-S10	10	SS-SA-CH	5
3-DL-SA	25	7-S2b	10	SS-SA-ESD	15
3-S10	9	7-SA-CH	7	SSBB-SA-ESD	15
3-SA	6	7-SA-M	7	TS-321	21
3-SA-ESD	16	7-T	13		

TRONEX ALSO OFFERS:

# CUTTERS & PLIERS



**T R O N E X**

2860 Cordelia Rd, Suite 230  
Fairfield, California 94534  
USA

Ph: 707-426-2550 • Fax: 707-426-6462  
[www.tronextools.com](http://www.tronextools.com)

Distributor Information

**ООО "КОМПАНИЯ ОПТУЛС"**

Москва, ул.Иловайская, д.3

Тел.: +7 (495) 646-00-96

[sale@opttools.ru](mailto:sale@opttools.ru)

[www.opttools.ru](http://www.opttools.ru)