



# BRILLIANT<sup>®</sup> TOOLS

EXCLUSIVE DEALER EDITION

powered by **KSTOOLS**



## HAND TOOLS AUTOMOTIVE SPECIAL TOOLS ENGINE ADJUSTMENT TOOLS

CATALOG 2022



**WORK  
BRILLIANT**

# THE POWER BEHIND OUR BRAND

Who decides for BRILLIANT TOOLS, decides also for KS TOOLS. The DNA from 30 years of perfection is in every single tool from BRILLIANT TOOLS.

The result: a high-quality tool assortment at a sensationally favorable price-performance ratio. From this benefit ambitious do-it-yourselfers as well as professionals from the handicraft and automotive sector.

# OUR CUSTOMERS: ALL THOSE WHOSE HEART BEATS FOR QUALITY

Whether do-it-yourselfers, craftsmen or mechanics:  
The BRILLIANT TOOLS product range offers professional tools for almost all purposes.

Whether for DIY projects or in the hard everyday work  
in the workshop or on assembly: Working with  
BRILLIANT TOOLS is guaranteed to pay off.



## OUR ASSORTMENT: HUGE

For the hard working day or for the hobby workshop; no matter whether you are a do-it-yourselfer, a craftsman mechanic or all at the same time: In the assortment of BRILLIANT TOOLS you will find the right tools for your the right tools for your project!

## BRILLIANT TOOLS AT A GLANCE:

MORE THAN  
**1.500**  
TOOLS

clearly arranged  
in our versatile  
assortment

UP TO  
**63 %**  
SAVING

due to the smart  
reduction to the  
essentials

VIA  
**5.000**  
DEALERS

carry BRILLIANT TOOLS  
articles in their  
assortment

VIA  
**85.000**  
ARTICLE IMAGES

for best information.  
What you see,  
you get

# OUR RECIPE FOR SUCCESS. THE SMART REDUCTION TO THE TO THE ESSENTIALS: QUALITY.

BRILLIANT TOOLS does not need a large distribution structure and extravagant marketing activities. Our target group is happy to do without. Instead, our customers buy at a favorable price, without having to lower their quality expectations.

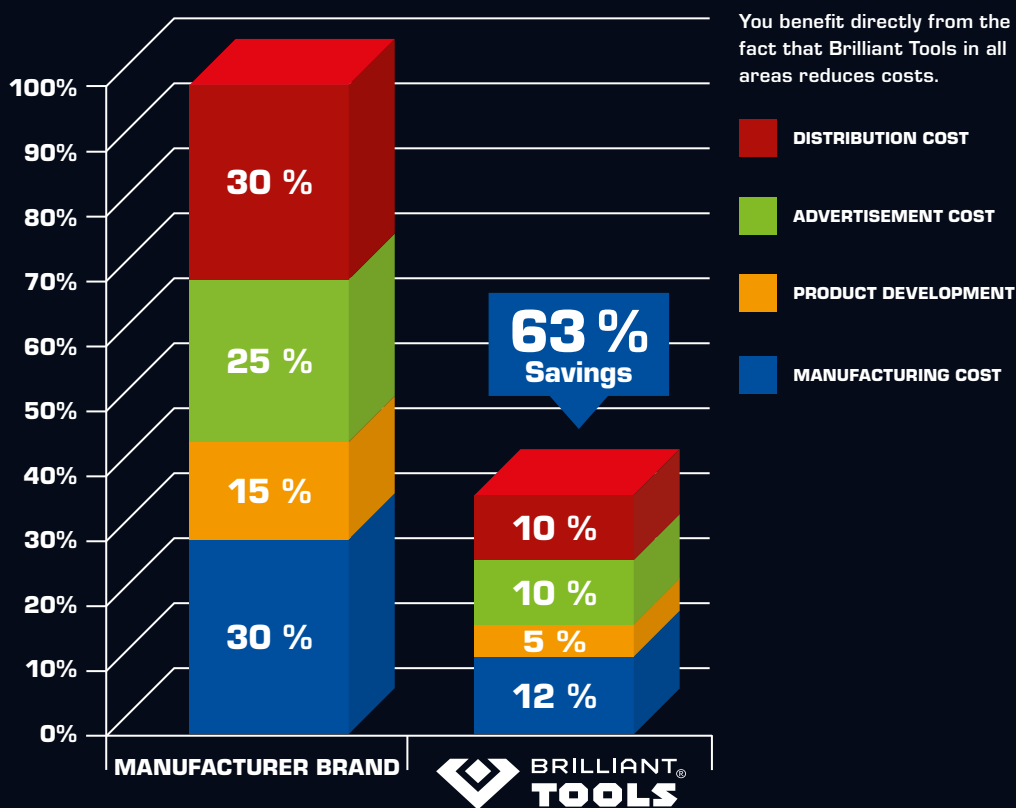

# PRODUCTION: INTERNATIONAL QUALITY: MADE IN GERMANY

Our tools are at home all over the world. Because in many countries very good tool manufacturers produce with tradition. Real professionals, from whom we manufacture with a clear conscience.

Function and quality are always guaranteed "made in Germany" - you can rely on that.



## OUR LOGISTICS: MIGHTY OUR PACE: RECORD-BREAKING

BRILLIANT TOOLS benefits from day one from the logistics of KS TOOLS in Heusenstamm. Our Tools are within a very short time used all over the world, for this we rely on the latest logistic technology.

ABOUT  
**1.000**

APPLICATION, EXPLANATION AND  
UNBOXING VIDEOS

WEBSITE IN  
**28**  
LANGUAGES

ABOUT  
**2.500**

360° VIDEOS THAT YOU CAN  
CONTROL HORIZONTALLY  
AND VERTICALLY

# DIGITIZATION: PERFECT INFORMATION CONTENT: OUTSTANDING

100% information: 7 days a week, 24 hours a day.  
No matter at what time of day or night - you can  
access to our products, images and video data base  
at any time. Because we make tools and love data, but  
above all we love satisfied customers. That is why no  
question remains unanswered.

BRILLIANT TOOLS are manufactured all over the world  
and distributed internationally. That is why it is a  
matter of that we speak the language of our customers.  
language of our customers. And that literally: Our  
website offers 28 languages. This means that we can be  
sure that our customers understand us as well as we  
understand their wishes.

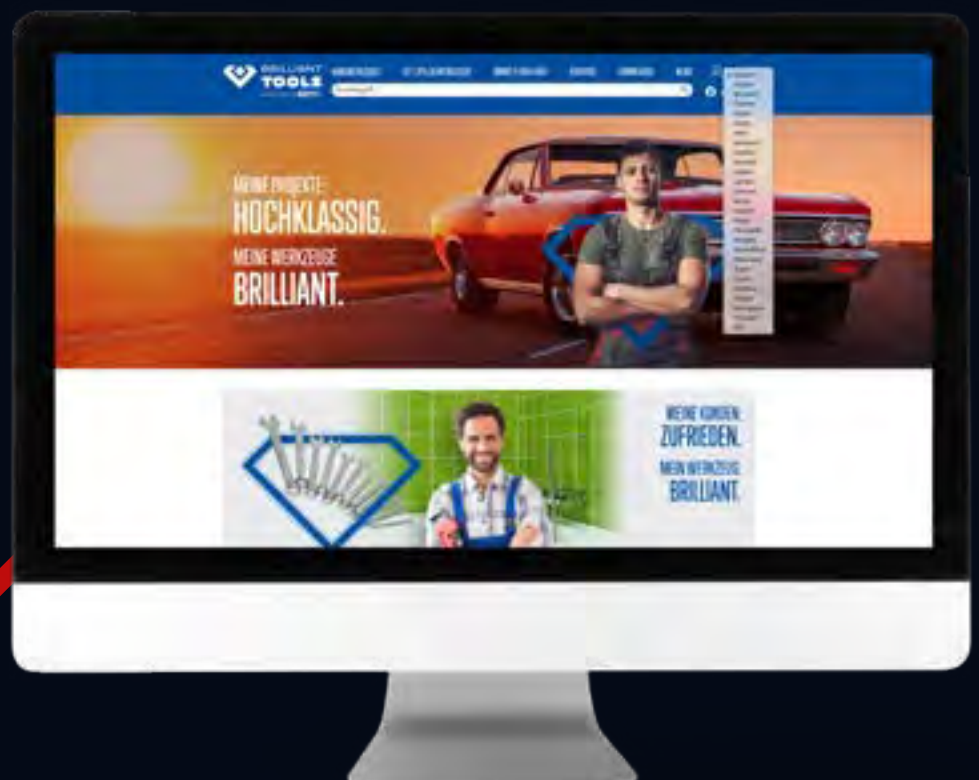



**WORK  
BRILLIANT**





BRILLIANT<sup>®</sup>  
TOOLS

powered by **KSTOOLS**



HAND TOOLS

CATALOG 2022

# CONTENTS



Page 12



Page 34

Spanner / wrenches .....	12	Key wrenches .....	94
Sockets and socket sets .....	24	Bits .....	98
Screwdriver .....	86	Pliers .....	104
		VDE tools .....	118
		Electrical tools .....	122
		Precision tools .....	126



Page 66



Page 178



**Page 168**



**Page 189**

<b>Puller .....</b>	<b>132</b>	<b>Torque tools .....</b>	<b>164</b>
<b>Hammers .....</b>	<b>136</b>	<b>Air tools .....</b>	<b>168</b>
<b>Chisels / punches / lever .....</b>	<b>138</b>	<b>Workshop equipment .....</b>	<b>178</b>
<b>Cutting and scraping tools .....</b>	<b>144</b>	<b>Index .....</b>	<b>468</b>
<b>Files / Brushes .....</b>	<b>154</b>		
<b>Measuring tools .....</b>	<b>162</b>		



**Page 184**



**Page 187**

# SPANNER

**12**  
pcs.

6 - 32 mm

**BT010012**  
**EAN 4042146773536**  
Double open-ended spanner set



**39,- €**

**12x**



- 6x7 • 8x9 • 10x11
- 12x13 • 14x15
- 16x17 • 18x19
- 20x22 • 21x23
- 24x27 • 25x28
- 30x32 mm

start from **2,- €**

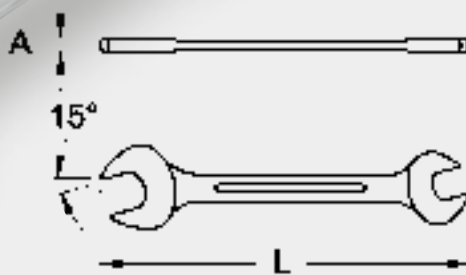

**BT010900...0914**  
Double open ended spanner

BT No.	mm	A mm	← L → mm	EAN 4042146+	€
BT010900	6x7	3,4	105	773543	2,00
BT010901	8x9	3,8	115	773550	2,00
BT010902	10x11	4,4	130	773567	3,00
BT010903	12x13	5,0	142	773574	3,00
BT010904	14x15	5,6	152	773581	3,00
BT010905	16x17	6,2	165	773598	4,00
BT010907	17x19	6,8	220	773611	4,00
BT010908	18x19	6,8	175	773628	4,00
BT010909	20x22	7,2	190	773635	5,00
BT010910	21x23	7,8	205	773642	6,00
BT010912	24x27	8,4	215	773666	7,00
BT010913	25x28	9,0	240	773673	9,00
BT010914	30x32	9,6	260	773680	10,00



**start from 5,- €**

**BT014804...815**  
Adjustable spanner

BT No.	L	"	mm	EAN 4042146+	€
BT014804	115	4	0 - 13	868744	5,00
BT014806	150	6	0 - 18	868751	7,00
BT014808	200	8	0 - 23	868768	8,00
BT014810	250	10	0 - 28	868775	10,00
BT014812	300	12	0 - 34	868782	13,00
BT014815	375	15	0 - 43	868799	25,00

**BT011015**  
**EAN 4042146773697**  
Ring open-ended spanner  
set

**15**  
pcs.

6 - 22 mm



**35,- €**

15x



- 6 • 7 • 8 • 9 •
- 10 • 11 • 12 •
- 13 • 14 • 15 •
- 16 • 17 • 18 •
- 19 • 22 mm

# SPANNER

6 - 32 mm

**21**  
pcs.



**69,- €**

BT011021  
EAN 4042146782002  
Ring open-ended spanner set

21x



6 • 7 • 8 • 9 • 10 • 11 • 12 •  
13 • 14 • 15 • 16 • 17 • 18 •  
19 • 20 • 21 • 22 • 24 • 27 •  
30 • 32 mm



start from **2,- €**



**BT011906...32**  
Ring open ended spanner

BT No.	mm	A1 mm	A2 mm	← L → mm	EAN 4042146+	€
BT011906	6	5,2	3,5	105	773710	2,00
BT011907	7	6,2	3,8	115	773727	2,00
BT011908	8	6,6	4,3	130	773734	2,00
BT011909	9	7,0	4,3	142	773741	2,00
BT011910	10	7,8	4,6	152	773758	2,00
BT011911	11	8,1	4,8	165	773765	3,00
BT011912	12	9,1	5,3	175	773772	3,00
BT011913	13	9,6	5,6	190	773789	3,00
BT011914	14	10,2	5,9	205	773796	3,00
BT011915	15	10,9	6,3	215	773802	4,00
BT011916	16	11,6	6,5	227	773819	4,00
BT011917	17	11,7	6,9	240	773826	4,00
BT011918	18	12,8	7,1	251	773833	5,00
BT011919	19	12,3	8,0	260	773840	5,00
BT011920	20	13,2	7,7	275	773857	6,00
BT011921	21	13,3	8,1	288	773864	6,00
BT011922	22	14,8	9,0	295	773871	6,00
BT011924	24	15,8	9,6	330	773888	7,00
BT011927	27	17,1	10,0	360	773895	9,00
BT011930	30	18,5	11,0	390	773901	12,00
BT011932	32	20,1	12,0	420	773918	13,00

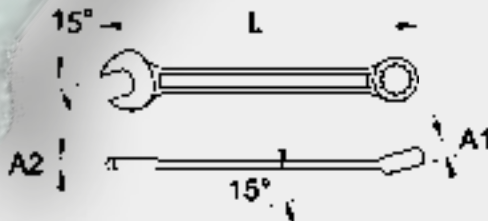



6 - 32 mm

**12**  
pcs.

**69,- €**



**BT012012**  
**EAN 4042146773925**  
Double ring spanner set, offset

12x



- 6x7 • 8x9 • 10x11
- 12x13 • 14x15
- 16x17 • 16x18
- 17x19 • 20x22
- 21x23 • 22x24
- 24x27 • 25x29
- 30x32 mm

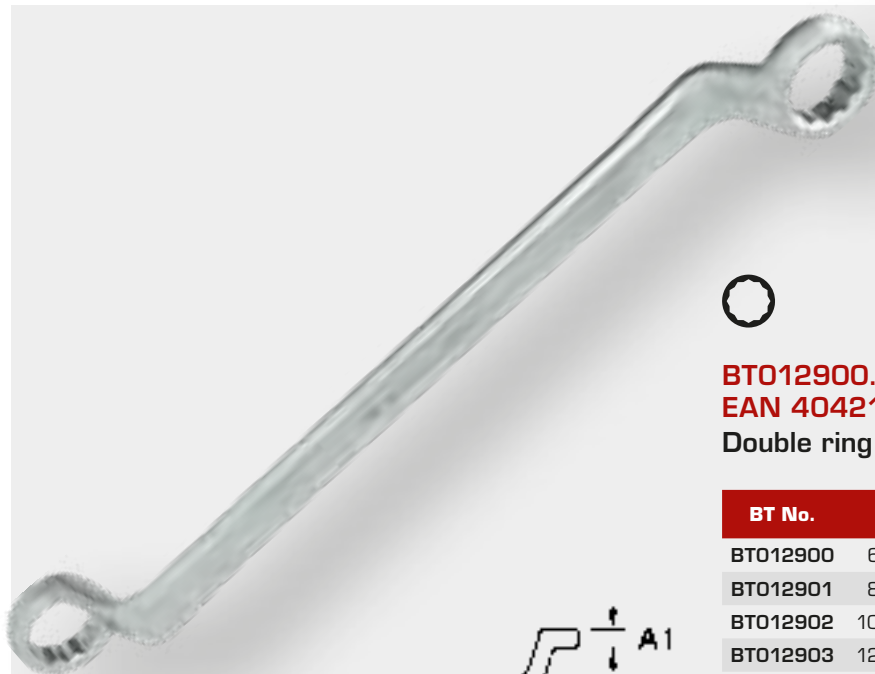

**start from 3,- €**

**BT012900...911**  
**EAN 4042146773994**  
Double ring spanner, offset

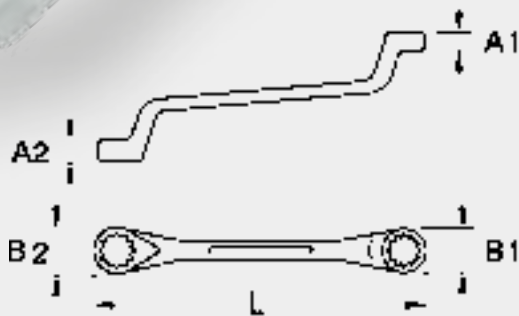

BT No.	○	A1 mm	A2 mm	← L → mm	EAN 4042146+	€
BT012900	6x7	6,3	5,7	176	773932	3,00
BT012901	8x9	7,7	6,7	190,5	773949	3,00
BT012902	10x11	9,2	8,6	205	773956	4,00
BT012903	12x13	9,9	9,5	220,5	773963	4,00
BT012904	14x15	10,8	10,2	236	773970	5,00
BT012905	16x17	12	11,4	250	773987	6,00
BT012906	18x19	12,8	12,4	271	773994	7,00
BT012907	20x22	14	13,2	291	774007	9,00
BT012908	21x23	14,2	13,6	310,5	774014	10,00
BT012909	24x27	15,6	14,4	331	774021	11,00
BT012910	25x28	15,6	14,6	350	774038	13,00
BT012911	30x32	16,9	16,4	371	774045	16,00

# SPANNER

8 - 19 mm

6  
pcs.

**BT706015**  
**EAN 4042146868089**

Line wrench set,  
8 - 19 mm



6x



8 x 9 • 10 x 11 • 12 x 13 • 14 x 15  
• 16 x 17 • 16 x 17 • 18 x 19 mm

**23,- €**



**BT706016...6021**

Line wrench

start from **4,- €**

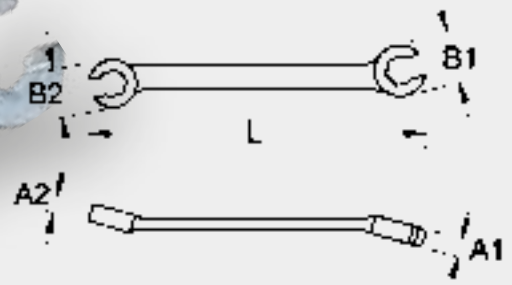

BT No.	mm	A1 mm	A2 mm	← L → mm	EAN 4042146+	€
BT706016	8x9	6.5	7.5	143	868096	4,00
BT706017	10x11	7.7	8.4	146	868102	4,00
BT706018	12x13	8.2	9.5	165	868119	5,00
BT706019	14x15	10.3	10.7	194	868126	5,00
BT706020	16x17	10.7	12.3	196	868133	7,00
BT706021	18x19	11.1	13.4	204	868140	7,00





**BT016001**  
**EAN 4042146867747**  
Scaffolding wrench

19 x 22 mm



**20,- €**



**BT013901**  
**EAN 4042146774052**  
4in1, Double ratchet ring spanner

**4 IN 1**

10, 13, 17, 19 mm



19 mm

13 mm

17 mm

10 mm



**12,50 €**

# SPANNER

**BT013105**  
**EAN 4042146863985**  
 Ratchet ring spanner set,  
 8 - 19 mm

**5**  
 pcs.

8 - 19 mm



**35,- €**

5x



8 • 10 • 13 • 17 • 19 mm

**BT013112**  
**EAN 4042146863992**  
 Ratchet ring spanner set,  
 8 - 19 mm

**12**  
 pcs.

8 - 19 mm



**79,- €**

12x



8 • 9 • 10 • 11 • 12 • 13 • 14  
 • 15 • 16 • 17 • 18 • 19 mm

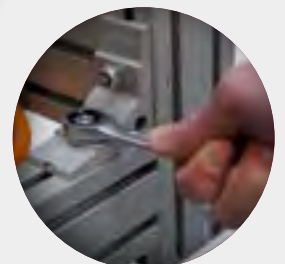



**BT013121**  
**EAN 4042146864005**

Ratchet ring spanner set,  
6 - 32 mm

**21**  
pcs.

6 - 32 mm



21x



- 6 • 7 • 8 • 9 • 10
- 11 • 12 • 13 • 14
- 15 • 16 • 17 • 18
- 19 • 20 • 21 • 22
- 24 • 27 • 30
- 32 mm



**179,- €**

BT No.	mm	A1 mm	A2 mm	B1 mm	B2 mm	← L → mm	EAN 4042146+	€
BT013706	6	6,5	4,2	17,3	13,5	125	863770	5,00
BT013707	7	6,5	4,4	17,3	16,7	133	863787	5,00
BT013708	8	6,5	4,6	17,3	17,1	140	863794	5,00
BT013709	9	7,2	4,8	19,0	19,2	150	863800	5,00
BT013710	10	7,7	5,0	21,0	21,3	159	863817	5,00
BT013711	11	8,2	5,3	22,5	23,4	165	863824	6,00
BT013712	12	8,6	5,6	24,2	25,4	171	863831	6,00
BT013713	13	9,0	5,9	25,5	27,5	178	863848	7,00
BT013714	14	9,4	6,2	27,5	29,5	191	863855	7,00
BT013715	15	9,9	6,5	29,0	31,6	200	863862	8,00
BT013716	16	10,3	6,8	30,8	33,6	209	863879	8,00
BT013717	17	10,7	7,2	32,4	35,6	225	863886	9,00
BT013718	18	11,2	7,6	33,5	37,6	237	863893	9,00
BT013719	19	11,2	8,0	33,5	40,0	245	863909	9,00
BT013720	20	13,0	8,6	42,2	46,0	290	863916	10,00
BT013721	21	13,0	8,6	42,2	46,0	290	863923	12,00
BT013722	22	13,0	8,6	42,2	46,0	290	863930	12,00
BT013724	24	14,5	9,7	49,2	46,0	335	863947	14,00
BT013727	27	15,5	10,7	53,2	56,5	359	863954	17,00
BT013730	30	17,0	11,6	58,5	62,7	405	863961	20,00
BT013732	32	17,5	12,2	62,0	66,5	425	863978	21,00



**start from 5,- €**



# SPANNER

**BT013205**  
**EAN 4042146864227**  
 Ratchet ring spanner set,  
 reversing, 8 - 19 mm



**5**  
 pcs.

8 - 19 mm



**39,- €**

5x



8 • 10 • 13 • 17 • 19 mm

**BT013212**  
**EAN 4042146864234**  
 Ratchet ring spanner set,  
 reversing, 8 - 19 mm



**12**  
 pcs.

8 - 19 mm



**89,- €**

12x



8 • 10 • 9 • 10 • 11 • 12 • 13  
 • 14 • 15 • 16 • 17 • 18 • 19 mm

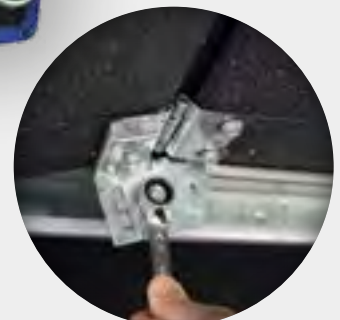



**BT013221**  
**EAN 4042146864241**

**Ratchet ring spanner set,  
reversing, 6 - 32 mm**

**21**  
pcs.

6 - 32 mm



21x



- 6 • 7 • 8 • 9 • 10
- 11 • 12 • 13 • 14
- 15 • 16 • 17 • 18
- 19 • 20 • 21
- 22 • 24 • 27
- 30 • 32 mm

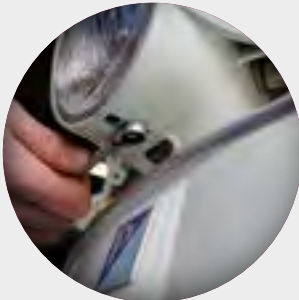

**199,- €**

BT No.	mm	A1 mm	A2 mm	B1 mm	B2 mm	← L → mm	EAN 4042146+	€
BT013806	6	6,5	4,2	17,3	13,5	125	864012	5,00
BT013807	7	6,5	4,4	17,3	16,7	133	864029	6,00
BT013808	8	6,5	5,0	18,4	18,0	140	864036	6,00
BT013809	9	7,2	5,2	19,4	20,0	150	864043	7,00
BT013810	10	7,7	5,7	21,4	23,0	159	864050	7,00
BT013811	11	8,2	6,3	23,3	25,0	165	864067	7,00
BT013812	12	8,6	6,7	24,8	27,0	171	864074	7,00
BT013813	13	9,0	7,0	26,4	28,0	178	864081	8,00
BT013814	14	9,4	7,5	28,1	32,0	191	864098	9,00
BT013815	15	9,9	8,0	30,3	33,0	200	864104	9,00
BT013816	16	10,3	8,0	32,0	35,0	209	864111	9,00
BT013817	17	10,7	8,7	34,0	38,5	225	864128	9,00
BT013818	18	11,2	9,0	35,3	39,0	237	864135	10,00
BT013819	19	11,2	9,5	36,1	42,0	245	864142	11,00
BT013820	20	13,0	9,7	42,3	46,0	290	864159	12,00
BT013821	21	13,0	9,7	42,3	46,0	290	864166	13,00
BT013822	22	13,0	9,7	42,3	46,0	290	864173	15,00
BT013824	24	14,5	10,7	49,2	52,3	335	864180	18,00
BT013827	27	15,5	11,6	53,2	56,5	359	864197	22,00
BT013830	30	17,0	12,5	58,6	62,7	405	864203	23,00
BT013832	32	17,5	13,1	62,0	66,5	425	864210	24,00



**BT013806... 832**  
**Ratchet ring spanner,  
reversing**

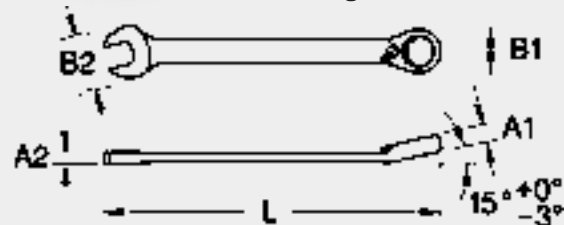

**start from 5,- €**

# SPANNER

**BT015100**  
**EAN 4042146862186**  
 Double ring spanner set

**10**  
 pcs.

8 - 19 mm

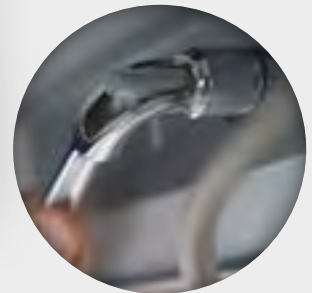
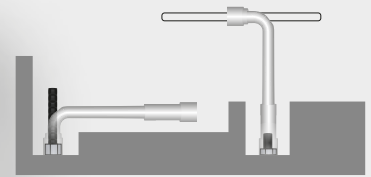

**59,- €**

21x



8 • 10 • 11 • 12 • 13 • 14 • 16 •  
 17 • 18 • 19 mm

**BT015006...024**  
 Double ring spanner,  
 offset

start from **3,- €**

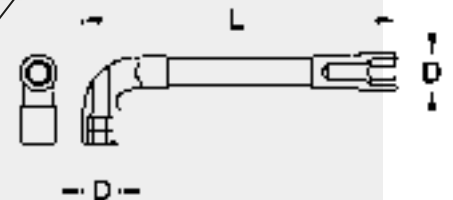
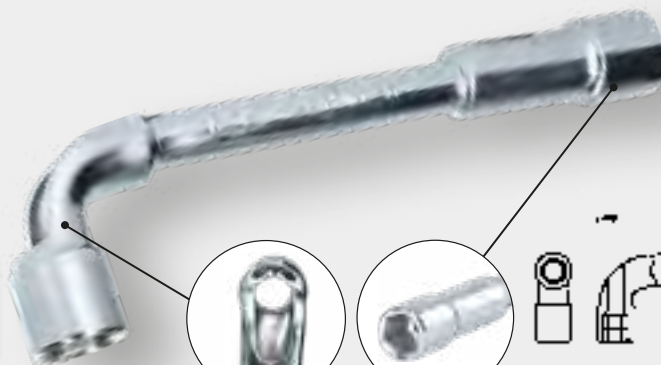

BT No.	SW mm	D mm	L mm	g	EAN 4042146+	€
BT015006	6	11.7	113	53	861998	3,00
BT015007	7	11.7	118	53	862001	3,00
BT015008	8	11.7	118	53	862018	3,00
BT015009	9	14.7	130	87	862025	3,00
BT015010	10	14.7	132	90	862032	4,00
BT015011	11	16.7	144	116	862049	4,00
BT015012	12	17.8	150	136	862056	4,00
BT015013	13	18.6	160	152	862063	4,00
BT015014	14	19.8	170	188	862070	5,00
BT015015	15	21.5	185	249	862087	6,00

BT No.	SW mm	D mm	L mm	g	EAN 4042146+	€
BT015016	16	21.5	195	256	862094	6,00
BT015017	17	23.9	202	305	862100	6,00
BT015018	18	25.7	212	400	862117	7,00
BT015019	19	25.7	218	405	862124	7,00
BT015020	20	30.7	230	545	862131	8,00
BT015021	21	30.7	241	594	862148	8,00
BT015022	22	30.7	252	603	862155	9,00
BT015023	23	33.2	265	756	862162	10,00
BT015024	24	33.2	275	766	862179	10,00



# PERFECTLY EQUIPPED: OUR WORKSHOP TROLLEYS, WITH 207 PREMIUM TOOLS AND MORE



Page 190

start from **449,- €**

# PERFECT FOR AMBITIOUS PROJECTS



1/4"  
6,3 mm



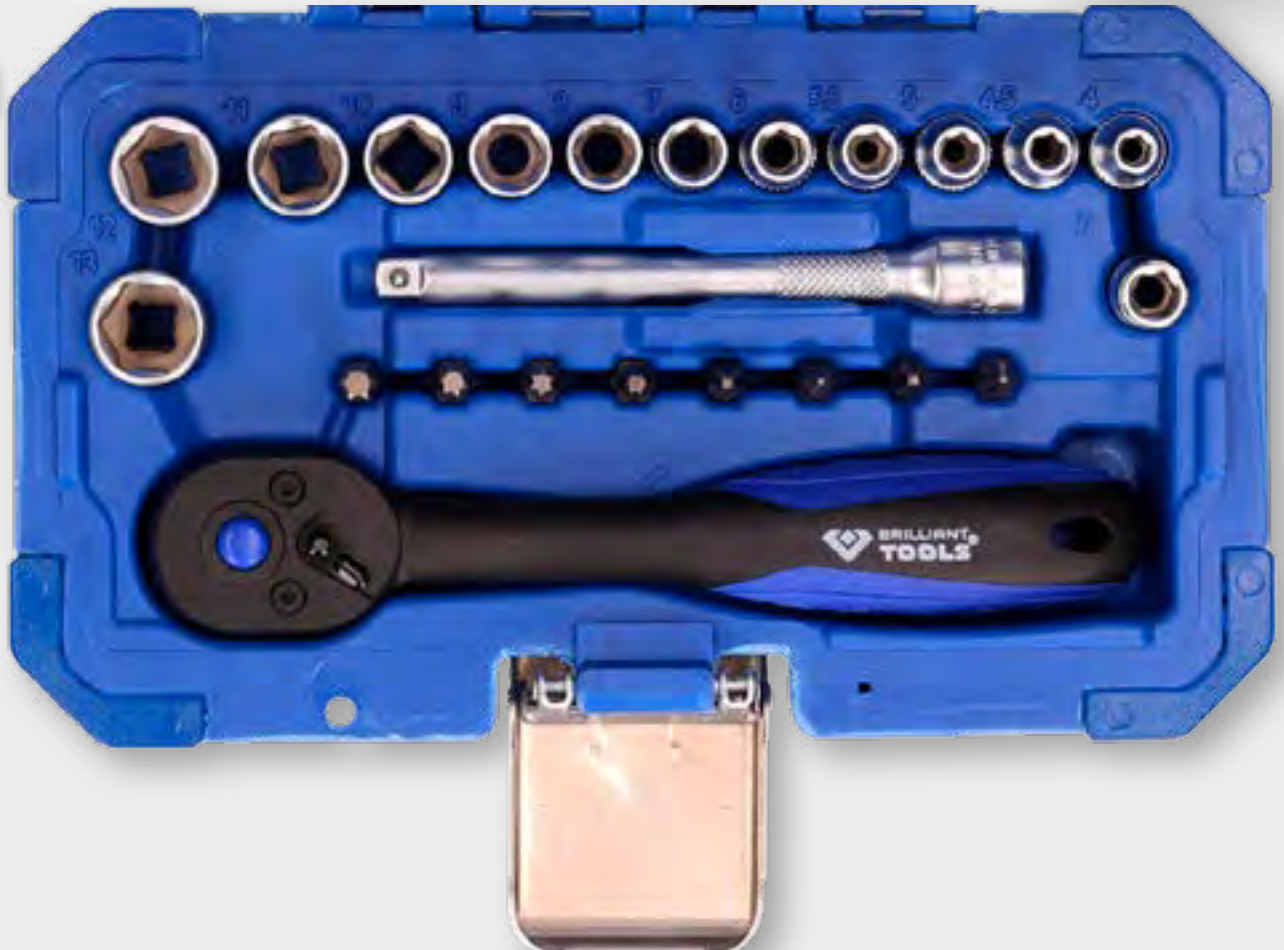

23  
pcs.

BT020023  
EAN 4042146774281  
1/4" socket set



20,- €

Profil	Size / Length
12x 	4 • 4,5 • 5 • 5,5 • 6 • 7 • 8 • 9 • 10 • 11 • 12 • 13 mm
4x 	T15 • T20 • T25 • T30
2x 	PH1 • PH2

Profil	Size / Length
2x 	PZ1 • PZ2
1x 	110 mm
1x 	100 mm
1x 	25 mm





1/4"  
6,3 mm

**BT020046**  
**EAN 4042146774298**  
1/4" socket set

**46**  
pcs.



1/4"  
6,3 mm



**25,- €**

Profil	Size / Length
13x  1/4"	4 • 4,5 • 5 • 5,5 • 6 • 7 • 8 • 9 • 10 • 11 • 12 • 13 • 14 mm
7x  1/4"	T10 • T15 • T20 • T25 • T27 • T30 • T40
3x  1/4"	PH1 • PH2 • PH3
2x  1/4"	PZ1 • PZ2

Profil	Size / Length
3x  1/4"	4 • 5,5 • 7 mm
5x  1/4"	4 • 5 • 6 • 7 • 8 mm
1x  1/4"	110 mm
1x  1/4"	150 mm
1x  1/4"	110 mm

Profil	Size / Length
1x  1/4"	100 mm
1x  1/4"	50 mm
1x  1/4"	-
1x  1/4"	25 mm
1x  1/4"	150 mm
1x  1/4"	1 • 1,5 • 2 • 2,5 mm

## SOCKETS

**BT020901**  
**EAN 4042146774304**  
1/4" Spin type speeder

1/4"  
6,3 mm

**3,- €**

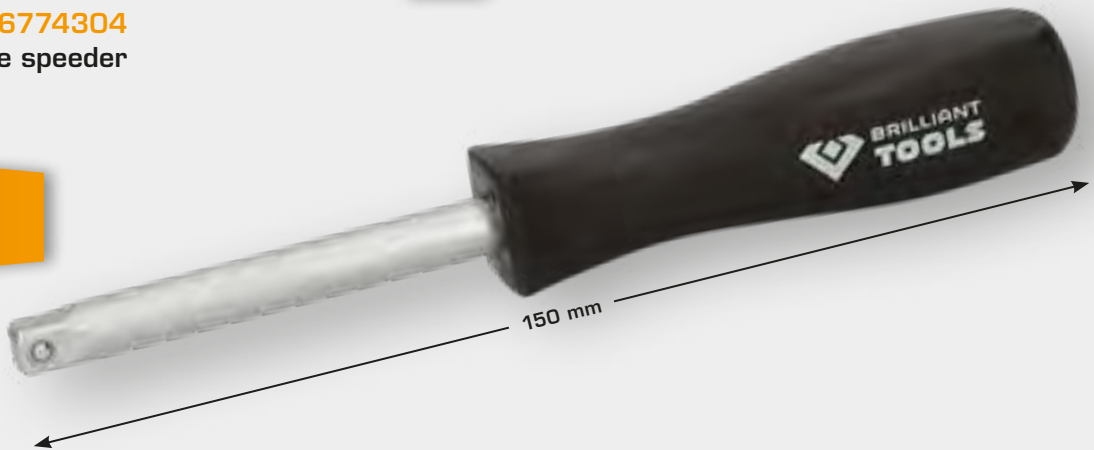

**BT020902**  
**EAN 4042146774311**  
1/4" slide grip

1/4"  
6,3 mm

**2,- €**

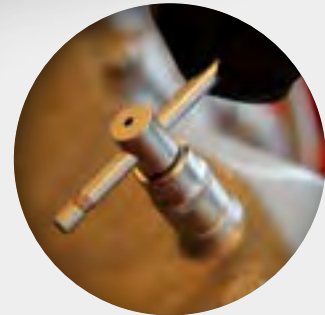
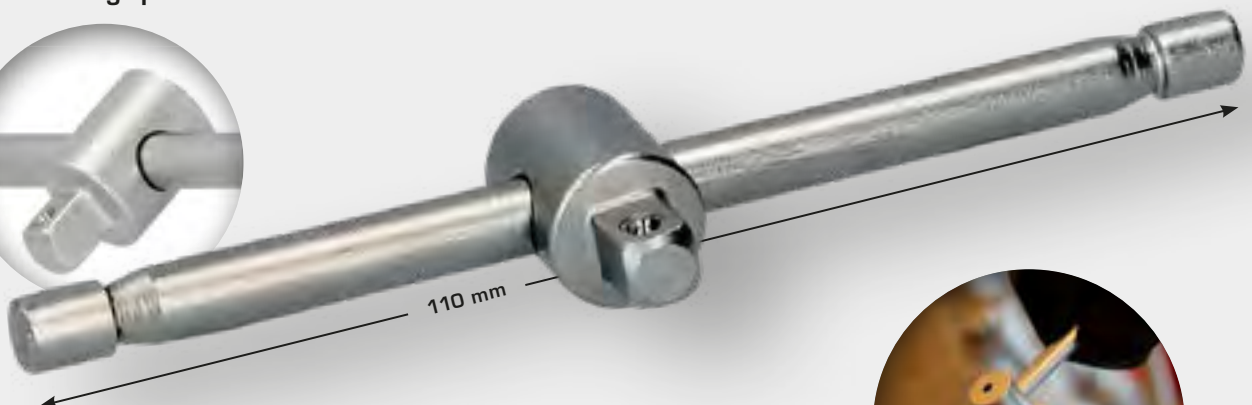

**BT020910**  
**EAN 4042146774397**  
1/4" Flexible extension

1/4"  
6,3 mm

**3,- €**

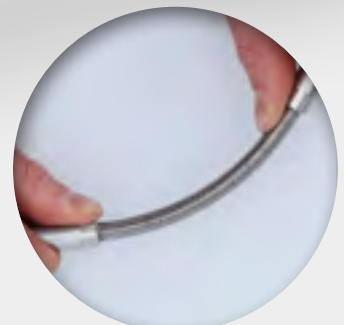
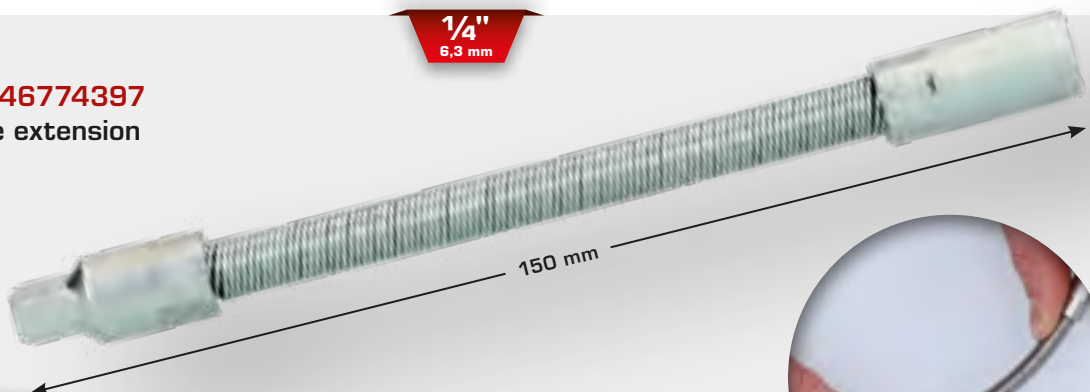



1/4"  
6,3 mm

**BT020930...942**  
1/4" hexagonal socket



BT No.	Ø	← L → mm	EAN 4042146+	€
BT020930	4	25	774427	2,00
BT020931	4,5	25	774434	2,00
BT020932	5	25	774441	2,00
BT020933	5,5	25	774458	2,00
BT020934	6	25	774465	2,00
BT020935	7	25	774472	2,00
BT020936	8	25	774489	2,00
BT020937	9	25	774496	2,00
BT020938	10	25	774502	2,00
BT020939	11	25	774519	2,00
BT020940	12	25	774526	2,00
BT020941	13	25	774533	2,00
BT020942	14	25	774540	2,00

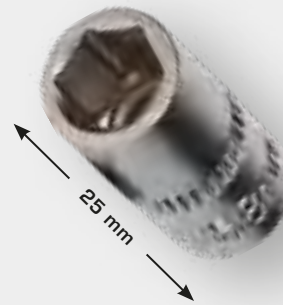

**2,- €**

1/4"  
6,3 mm

**BT020950...959**  
1/4" hexagonal socket, long version



BT No.	Ø	← L → mm	EAN 4042146+	€
BT020950	4	50	774557	2,00
BT020951	5	50	774564	2,00
BT020952	6	50	774571	2,00
BT020953	7	50	774588	2,00
BT020954	8	50	774595	2,00
BT020955	9	50	774601	2,00
BT020956	10	50	774618	2,00
BT020957	11	50	774625	2,00
BT020958	12	50	774632	2,00
BT020959	13	50	774649	2,00

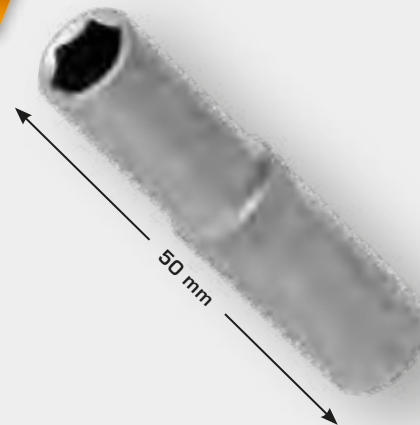

**2,- €**

1/4"  
6,3 mm

**BT020960...965**  
1/4" Torx E-socket



BT No.	Ø	← L → mm	EAN 4042146+	€
BT020960	E4	25	774656	2,00
BT020961	E5	25	774663	2,00
BT020962	E6	25	774670	2,00
BT020963	E7	25	774687	2,00
BT020964	E8	25	774694	2,00
BT020965	E10	25	774700	2,00

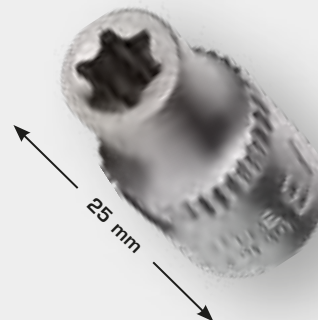

**2,- €**

# SOCKETS

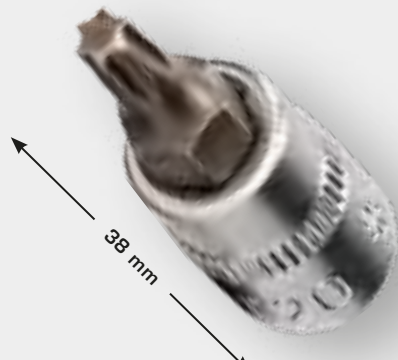

38 mm

**1/4"**  
6,3 mm



**BT020970...976**  
1/4" Torx bit socket

BT No.	★	← L → mm	EAN 4042146+	€
BT020970	T9	38	774724	2,00
BT020971	T10	38	774731	2,00
BT020972	T15	38	774748	2,00
BT020973	T20	38	774755	2,00
BT020974	T25	38	774762	2,00
BT020975	T30	38	774779	2,00
BT020976	T40	38	774786	2,00

2,- €



38 mm

**1/4"**  
6,3 mm



**BT020980...986**  
1/4" Torx bit socket, tamper-proof

BT No.	★	← L → mm	EAN 4042146+	€
BT020980	TH9	38	774793	2,00
BT020981	TH10	38	774809	2,00
BT020982	TH15	38	774816	2,00
BT020983	TH20	38	774823	2,00
BT020984	TH25	38	774830	2,00
BT020985	TH27	38	774847	2,00
BT020986	TH30	38	774854	2,00

2,- €



38 mm

**1/4"**  
6,3 mm



**BT020820...825**  
1/4" hexagonal bit socket

BT No.	⬡	← L → mm	EAN 4042146+	€
BT020820	3	38	774984	2,00
BT020821	4	38	774991	2,00
BT020822	5	38	775004	2,00
BT020823	6	38	775011	2,00
BT020824	7	38	775028	2,00
BT020825	8	38	775035	2,00

2,- €



1/4"  
6,3 mm

1/4"  
6,3 mm



38 mm

**2,- €**

**BT020810...813**  
1/4" slot bit socket

BT No.	☉	← L → mm	EAN 4042146+	€
BT020810	0,8 x 4	38	774946	2,00
BT020811	1 x 5,5	38	774953	2,00
BT020812	1,2 x 6,5	38	774960	2,00
BT020813	1,2 x 7	38	774977	2,00

1/4"  
6,3 mm



38 mm

**2,- €**

**BT020990...993**  
1/4" PH Phillips bit socket

BT No.	⊕	← L → mm	EAN 4042146+	€
BT020990	PH0	38	774861	2,00
BT020991	PH1	38	774878	2,00
BT020992	PH2	38	774885	2,00
BT020993	PH3	38	774892	2,00

1/4"  
6,3 mm

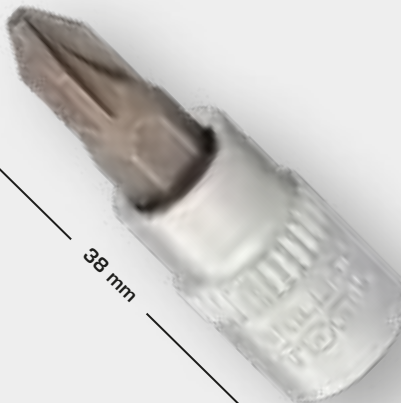

38 mm

**2,- €**

**BT020800...803**  
1/4" PZ Pozdriv bit socket

BT No.	⊕	← L → mm	EAN 4042146+	€
BT020800	PZ0	38	774908	2,00
BT020801	PZ1	38	774915	2,00
BT020802	PZ2	38	774922	2,00
BT020803	PZ3	38	774939	2,00

# SOCKETS

**1/4"**  
6,3 mm

40 mm

**4,- €**

**BT020906**  
EAN 4042146774359  
1/4" Universal joint

**1/4"**  
6,3 mm

100 mm

50 mm

**start from 2,- €**

**BT020907...08**  
1/4" extension

BT No.	← L → mm	EAN 4042146+	€
BT020907	50	774366	2,00
BT020908	100	774373	3,00

**1/4"**  
6,3 mm

1/4"

29 mm

1/4"

**1,- €**

**BT020909**  
EAN 4042146774380  
1/4" adapter

**1/4"**  
6,3 mm

3/8"

29 mm

1/4"

**2,- €**

**BT020911**  
EAN 4042146774403  
1/4" adapter to 3/8"

**1/4"**  
6,3 mm

1/4"

29 mm

1/4"

**2,- €**

**BT020912**  
EAN 4042146774410  
1/4" bit adapter



1/4"  
6,3 mm

**BT020903...905**  
1/4" wobble extension

1/4"  
6,3 mm



BT No.	← L → mm	EAN 4042146+	€
BT020903	35	774328	2,00
BT020904	75	774335	3,00
BT020905	250	774342	5,00

start from **2,- €**

**BT020009**  
EAN 4042146867372  
Wobble extension set

**9**  
pcs.

1/4" 3/8" 1/2"  
6,3 mm 10 mm 12,5 mm



**29,- €**

# SOCKETS

**BT020900**  
**EAN 4042146777749**  
 1/4" Reversible ratchet

1/4" 6,3 mm

72 5°

150 mm

2K

12,- €

**BT020999**  
**EAN 4042146868706**  
 1/4" mini reversible ratchet with metal handle, 100-tooth

1/4" 6,3 mm

100 3,6°

86 mm

12,- €

**BT020995**  
**EAN 4042146844984**  
 1/4" reversible ratchet with metal handle, 100 tooth

1/4" 6,3 mm

100 3,6°

150 mm

15,- €





1/4"  
6,3 mm

**BT020996**  
**EAN 4042146868423**  
1/4" telescopic reversible ratchet

1/4"  
6,3 mm

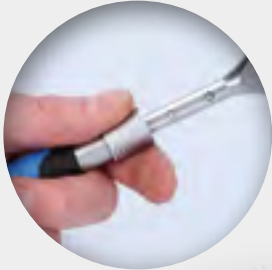

**17,- €**

**BT020997**  
**EAN 4042146868447**  
1/4" telescopic reversible  
ratchet with flexible head

1/4"  
6,3 mm

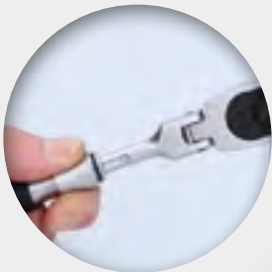

**23,- €**

# PERFECT QUALITY IN ANY FORMAT

# SOCKETS

3/8"  
10 mm

61  
pcs.

BT021061  
EAN 4042146775042  
3/8" socket set



3/8"  
10 mm



69,- €



Profil	Size / Length
18x	6 • 7 • 8 • 9 • 10 • 11 • 12 • 13 • 14 • 15 • 16 • 17 • 18 • 19 • 20 • 21 • 22 • 24 mm
10x	8 • 9 • 10 • 11 • 12 • 13 • 14 • 15 • 17 • 19 mm
2x	16 • 21 mm
7x	3 • 4 • 5 • 6 • 7 • 8 • 10 mm
3x	0,8 x 5,5 • 1 x 7 • 1,2 • 8 mm
3x	PH1 • PH2 • PH3

Profil	Size / Length
3x	PZ1 • PZ2 • PZ3
9x	T15 • T20 • T25 • T27 • T 30 • T40 • T45 • T50 • T55
1x	198 mm
1x	250 mm
1x	50 mm
1x	75 mm
1x	30 mm



3/8"  
10 mm

BT No.	Ø	← L → mm	EAN 4042146+	€
BT021800	6	28	775059	3,00
BT021801	7	28	775066	3,00
BT021802	8	28	775073	3,00
BT021803	9	28	775080	3,00
BT021804	10	28	775097	3,00
BT021805	11	28	775103	3,00
BT021806	12	28	775110	3,00
BT021807	13	28	775127	3,00
BT021808	14	28	775134	3,00
BT021809	15	28	775141	3,00
BT021810	16	28	775158	3,00
BT021811	17	30	775165	3,00
BT021812	18	30	775172	3,00
BT021813	19	30	775189	3,00
BT021814	20	30	775196	4,00
BT021815	21	30	775202	4,00
BT021816	22	30	775219	4,00
BT021817	24	30	775226	5,00

3/8"  
10 mm



**BT021800...817**  
3/8" hexagonal socket

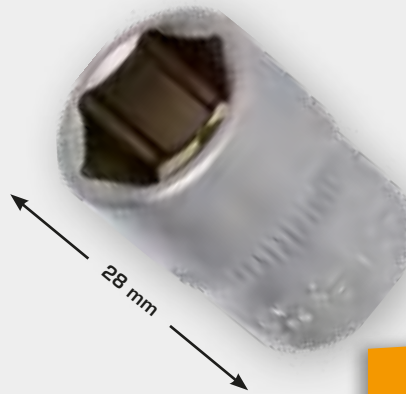

start from **3,- €**

BT No.	Ø	← L → mm	EAN 4042146+	€
BT021820	8	63	775233	4,00
BT021821	9	63	775240	4,00
BT021822	10	63	775257	4,00
BT021823	11	63	775264	4,00
BT021824	12	63	775271	4,00
BT021825	13	63	775288	4,00
BT021826	14	63	775295	4,00
BT021827	15	63	775301	4,00
BT021828	17	63	775318	4,00
BT021829	19	63	775325	5,00

3/8"  
10 mm



**BT021820...829**  
3/8" hexagonal socket,  
long version

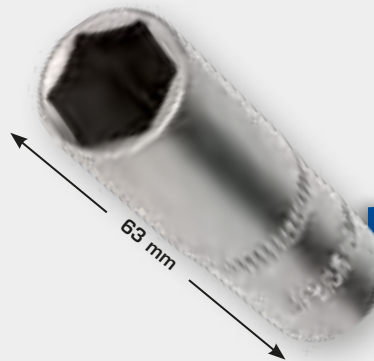

start from **4,- €**



3/8"  
10 mm



**BT021850...852**  
3/8" spark plug socket



start from **4,- €**

BT No.	Ø	← L → mm	EAN 4042146+	€
BT021850	16	66	775455	4,00
BT021851	18	66	775462	4,00
BT021852	21	66	775479	5,00

# SOCKETS

**BT021830...841**  
3/8" Torx E-socket

3/8"  
10 mm



start from **3,- €**

BT No.	⊕	← L → mm	EAN 4042146+	€
BT021830	E4	28	775332	3,00
BT021831	E5	28	775349	3,00
BT021832	E6	28	775356	3,00
BT021833	E7	28	775363	3,00
BT021834	E8	28	775370	3,00
BT021835	E10	28	775387	3,00
BT021836	E11	28	775394	3,00
BT021837	E12	28	775400	3,00
BT021838	E14	28	775417	3,00
BT021839	E16	28	775424	3,00
BT021840	E18	28	775431	3,00
BT021841	E20	28	775448	4,00

**3,- €**

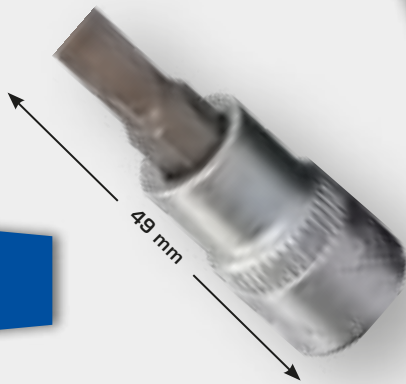

3/8"  
10 mm



**BT021860...862**  
3/8" slot bit socket

BT No.	⊖	← L → mm	EAN 4042146+	€
BT021860	0,8 x 5,5	49	775486	3,00
BT021861	1 x 7	49	775493	3,00
BT021862	2 x 8	49	775509	3,00

**3,- €**

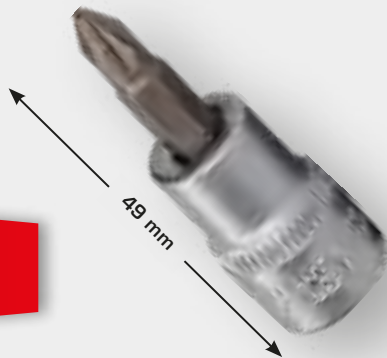

3/8"  
10 mm



**BT021880...882**  
3/8" PZ Pozdriv bit socket

BT No.	⊕	← L → mm	EAN 4042146+	€
BT021880	PZ1	49	775585	3,00
BT021881	PZ2	49	775592	3,00
BT021882	PZ3	49	775608	3,00

**3,- €**

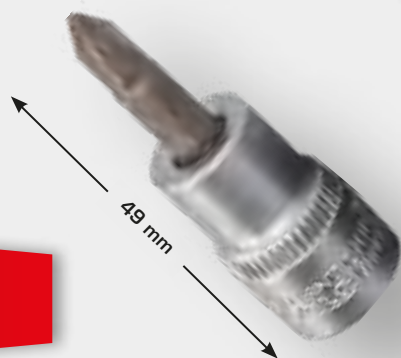

3/8"  
10 mm



**BT021890...892**  
3/8" PH Phillips bit socket

BT No.	⊕	← L → mm	EAN 4042146+	€
BT021890	PH1	49	775615	3,00
BT021891	PH2	49	775622	3,00
BT021892	PH3	49	775639	3,00



3/8"  
10 mm

3/8"  
10 mm

start from **3,- €**

**BT021870...876**  
3/8" hexagonal bit socket

BT No.	⬢	← L → mm	EAN 4042146+	€
BT021870	3	49	775516	3,00
BT021871	4	49	775523	3,00
BT021872	5	49	775530	3,00
BT021873	6	49	775547	3,00
BT021874	7	49	775554	4,00
BT021875	8	49	775561	4,00
BT021876	10	49	775578	4,00

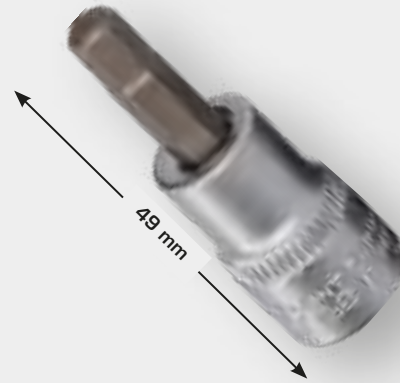

3/8"  
10 mm

start from **3,- €**

**BT021930...932**  
3/8" TORX<sup>®</sup> bit socket,  
tamper-proof

BT No.	⬠	← L → mm	EAN 4042146+	€
BT021930	T40	49	775646	3,00
BT021931	T45	49	775653	3,00
BT021932	T50	49	775660	4,00

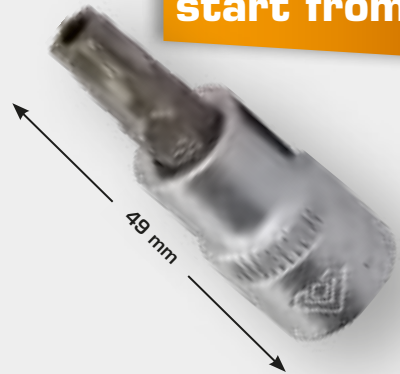

3/8"  
10 mm

start from **3,- €**

**BT021940...949**  
3/8" TORX<sup>®</sup> bit socket

BT No.	⬠	← L → mm	EAN 4042146+	€
BT021940	T15	49	775677	3,00
BT021941	T20	49	775684	3,00
BT021942	T25	49	775691	3,00
BT021943	T27	49	775707	3,00
BT021944	T30	49	775714	3,00
BT021945	T40	49	775721	3,00
BT021946	T45	49	775738	3,00
BT021947	T47	49	775745	3,00
BT021948	T50	49	775752	4,00
BT021949	T55	49	775769	4,00



**SOCKETS**

**BT021900**  
**EAN 4042146777756**  
 3/8" Reversible ratchet

**3/8" 10 mm**

**2K**

5°  
 72

198 mm

**17,50 €**

**BT021995**  
**EAN 4042146844991**  
 3/8" reversible ratchet with metal handle, 100 tooth

**3/8" 10 mm**

100  
 3,6°

200 mm

**20,- €**

**BT021996**  
**EAN 4042146868430**  
 3/8" telescopic reversible ratchet

**3/8" 10 mm**

220 - 320 mm

**20,- €**



3/8"  
10 mm

**BT021997**  
**EAN 4042146868454**  
3/8" telescopic reversible  
ratchet with flexible head



**22,50 €**

3/8"  
10 mm

**BT021901**  
**EAN 4042146775776**  
3/8" Sliding head/adaptor

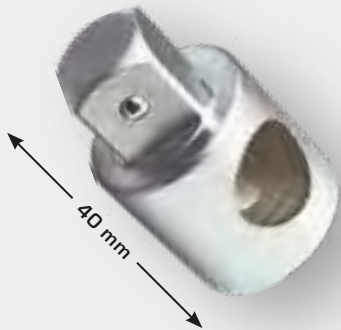

**3,- €**

3/8"  
10 mm

**BT021902**  
**EAN 4042146775783**  
3/8" Universal joint



**5,- €**

3/8"  
10 mm

**BT021903**  
**EAN 4042146775790**  
3/8" bit adaptor to 5/16"

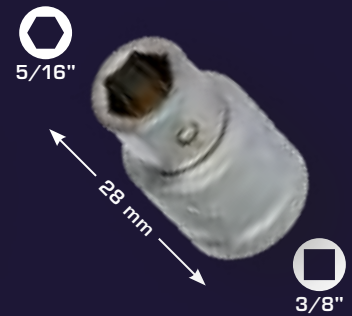

**3,- €**

3/8"  
10 mm

**BT021904**  
**EAN 4042146775806**  
3/8" Adapter to 1/2"

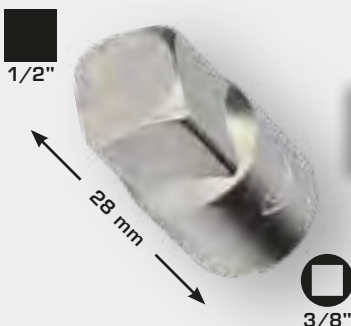

**3,- €**

3/8"  
10 mm

**BT021905**  
**EAN 4042146775813**  
3/8" Adapter to 1/4"

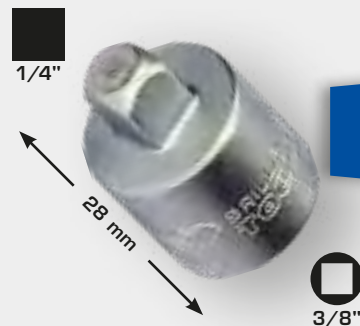

**2,- €**

# SOCKETS

**BT021907...909**  
3/8" extension

start from **3,- €**

BT No.	← L → mm	EAN 4042146+	€
BT021907	75	775837	3,00
BT021908	125	775844	4,00
BT021909	250	775851	5,00

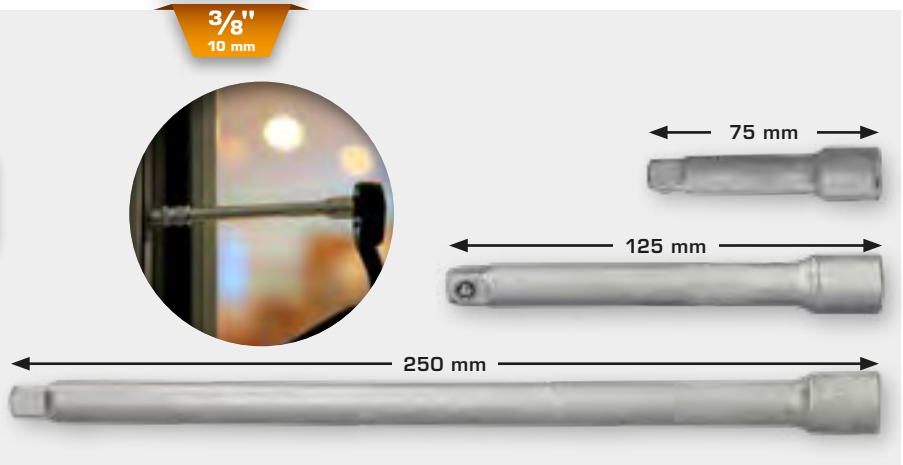

**BT021910...912**  
3/8" wobble extension

start from **3,- €**

BT No.	← L → mm	EAN 4042146+	€
BT021910	35	775868	3,00
BT021911	75	775875	4,00
BT021912	250	775882	6,00

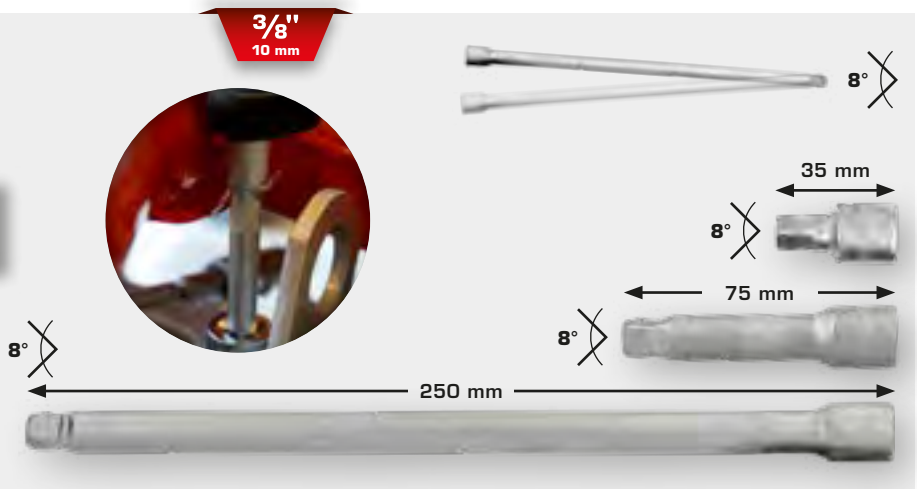

**BT020009**  
EAN 4042146867372  
Wobble extension set

**9**  
pcs.

**1/4"**  
6,3 mm

**3/8"**  
10 mm

**1/2"**  
12,5 mm



**29,- €**





1/2"  
12,5 mm

1/2"  
12,5 mm

**21**  
pcs.

1/2"  
12,5 mm

**BT022405**  
**EAN 4042146867372**  
1/2" 12-point socket set, short,  
8 – 36 mm



21x



8 • 9 • 10 • 11 • 12  
• 13 • 14 • 15 • 16  
• 17 • 18 • 19 • 20  
• 21 • 22 • 24 • 27  
• 30 • 32 • 34 • 36 mm

**59,- €**

1/2"  
12,5 mm

**BT022408...436**  
1/2" 12-point socket



start from **5,- €**

BT No.	⦿	← L → mm	EAN 4042146+	€
BT022408	8	38	869062	5,00
BT022409	9	38	869079	5,00
BT022410	10	38	869086	5,00
BT022411	11	38	869093	5,00
BT022412	12	38	869109	5,00
BT022413	13	38	869116	5,00
BT022414	14	38	869123	5,00
BT022415	15	38	869130	5,00
BT022416	16	38	869147	5,00
BT022417	17	38	869154	5,00
BT022418	18	38	869161	5,00

BT No.	⦿	← L → mm	EAN 4042146+	€
BT022419	19	38	869178	5,00
BT022420	20	38	869185	5,00
BT022421	21	38	869192	5,00
BT022422	22	38	869208	5,00
BT022424	24	38	869215	6,00
BT022427	27	38	869222	7,00
BT022430	30	38	869239	8,00
BT022432	32	38	869246	9,00
BT022434	34	38	869253	10,00
BT022436	36	38	869260	10,00

# SOCKETS

25  
pcs.

1/2"  
12,5 mm

BT022025  
EAN 4042146775899  
1/2" socket set

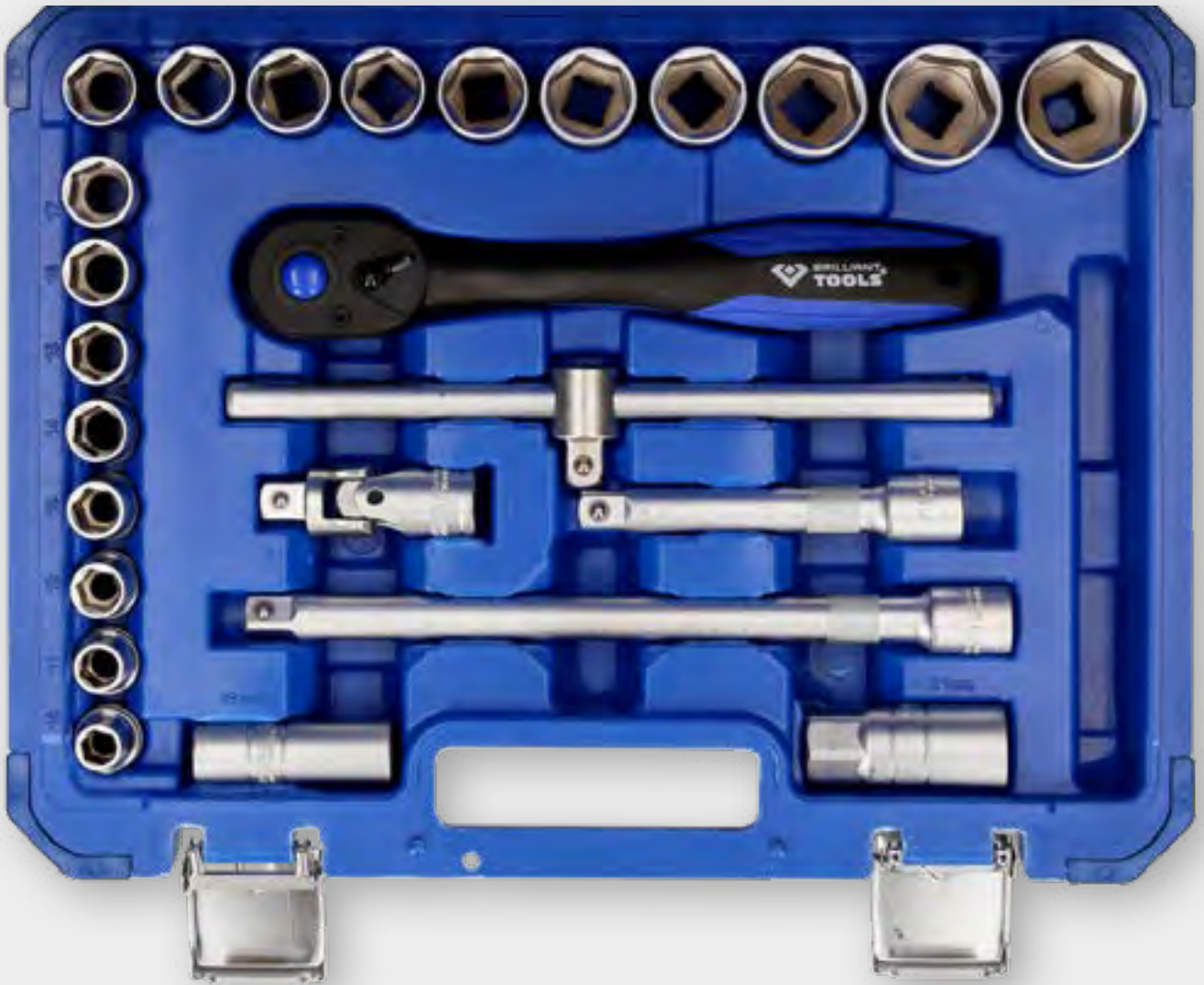

49,- €

Profil	Size / Length
18x	10 • 11 • 12 • 13 • 14 • 15 • 16 • 17 • 18 • 19 • 20 • 21 • 22 • 23 • 24 • 27 • 30 • 32 mm
2x	16 • 21 mm
1x	250 mm
1x	250 mm
1x	50 mm
1x	125 mm
1x	250 mm



1/2"  
12,5 mm

**94**  
pcs.

**BT023094**  
**EAN 4042146777701**  
**1/4" + 1/2" socket set**

1/4"  
6,3 mm  
1/2"  
12,5 mm



**75,- €**

Profil	Size / Length
13x	4 • 4,5 • 5 • 5,5 • 6 • 7 • 8 • 9 • 10 • 11 • 12 • 13 • 14 mm
8x	6 • 7 • 8 • 9 • 10 • 11 • 12 • 13 mm
4x	3 • 4 • 5 • 6 mm
3x	0,8x4 • 1x5,5 • 1,2x7 mm
2x	PH1 • PH2
2x	PZ1 • PZ2
5x	T10 • T15 • T20 • T25 • T30
1x	150 mm
1x	150 mm
1x	110 mm
1x	40 mm
1x	50 mm
1x	100 mm
1x	145 mm
1x	30 mm

Profil	Size / Length
18x	10 • 11 • 12 • 13 • 14 • 15 • 16 • 17 • 18 • 19 • 20 • 21 • 22 • 23 • 24 • 27 • 30 • 32 mm
4x	14 • 15 • 17 -19 mm
2x	16 • 21 mm
1x	250 mm
1x	75 mm
1x	125 mm
1x	250 mm
1x	44 mm
1x	37 mm
1x	1,5 • 2 • 2,5 mm
2x	PH3 • PH4
2x	PZ3 • PZ4
3x	8 • 10 • 12 mm
4x	T40 • T45 • T50 • T55
4x	8 • 10 • 12 • 14 mm

# SOCKETS

**172**  
pcs.

**BT023172**  
**EAN 4042146777688**  
1/4" + 3/8" + 1/2" socket set



**1/4"**  
6,3 mm  
**3/8"**  
10 mm  
**1/2"**  
12,5 mm







































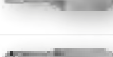

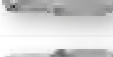



**79,- €**



1/2"  
12,5 mm

Profil		Size / Length
13x 		4 • 4,5 • 5 • 5,5 • 6 • 7 • 8 • 9 • 10 • 11 • 12 • 13 • 14 mm
5x 		E4 • E5 • E6 • E7 • E8
7x 		4 • 5 • 6 • 7 • 8 • 9 • 10
2x 		50 • 100 mm
8x 		T8 • T9 • T10 • T15 • T20 • T25 • T27 • T30
8x 		TH8 • TH9 • TH10 • TH15 • TH20 • TH25 • TH27 • TH30
3x 		PH0 • PH1 • PH2
3x 		PZ0 • PZ1 • PZ2
4x 		3 • 4 • 5 • 6 mm
4x 		0,8x4 • 1x5,5 • 1,2x6,5 • 1,2x7
1x 		40 mm
1x 		150 mm
1x 		150 mm
1x 		110 mm
1x 		25 mm
10x 		10 • 11 • 12 • 13 • 14 • 15 • 16 • 17 • 18 • 19 mm
6x 		E10 • E11 • E12 • E14 • E16 • E18
6x 		10 • 11 • 12 • 13 • 14 • 15 mm
1x 		18 mm
1x 		125 mm
1x 		28 mm

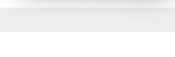
Profil		Size / Length
1x 		50 mm
1x 		198 mm
17x 		10 • 11 • 12 • 13 • 14 • 15 • 16 • 17 • 18 • 19 • 20 • 21 • 22 • 24 • 27 • 30 • 32 mm
2x 		E20 • E24
5x 		16 • 17 • 18 • 19 • 22 mm
2x 		16 • 21 mm
2x 		125 • 250 mm
1x 		37 mm
1x 		75 mm
1x 		44 mm
1x 		250 mm
3x 		M5 • M6 • M8
3x 		T5 • T6 • T7
9x 		TS10 • TS15 • TS20 • TS25 • TS27 • TS30 • TS40 • TS45
5x 		T40 • T45 • T50 • T55 • T60
5x 		7 • 8 • 10 • 12 • 14 mm
6x 		T40 • T45 • T50 • T55 • T60 • T70
6x 		TS40 • TS45 • TS50 TS55 • TS60 • TS70
2x 		PH3 • PH4
2x 		PZ3 • PZ4
3x 		8 • 10 • 12 mm
7x 		1 • 1,5 • 2 • 2,5 • 3 • 4 • 5 mm

# SOCKETS



**216**  
pcs.

**BT023216**  
**EAN 4042146777695**  
1/4" + 3/8" + 1/2" socket set

**1/4"**  
6,3 mm  
**3/8"**  
10 mm  
**1/2"**  
12,5 mm



**129,- €**

Profil	Size / Length
13x	4 • 4,5 • 5 • 5,5 • 6 • 7 • 8 • 9 • 10 • 11 • 12 • 13 • 14 mm
10x	6 • 7 • 8 • 9 • 10 • 11 • 12 • 13 • 14 • 15 mm
5x	E4 • E5 • E6 • E7 • E8

Profil	Size / Length
4x	3 • 4 • 5 • 6 mm
3x	0,8 x 4 • 1 x 5,5 • 1,2 x 6,5 mm
6x	T8 • T10 • T15 • T20 • T25 • T30



1/2"  
12,5 mm

Profil		Size / Length	Profil		Size / Length
6x		TH8 • TH10 • TH15 • TH20 • TH25 • TH30	2x		T55 • T60
2x		PH1 • PH2	1x		75 mm
2x		PZ1 • PZ2	2x		125 • 250 mm
1x		150 mm	1x		37 mm
1x		150 mm	12x		8 • 9 • 10 • 11 • 12 • 13 • 14 • 15 • 16 • 17 • 18 • 19 mm
1x		205 mm	7x		1,3 • 1,5 • 2 • 2,5 • 3 • 4 • 5 mm
1x		110 mm	3x		M5 • M6 • M8
1x		40 mm	4x		PH0 • PH1 • PH2 • PH3
2x		50 • 100 mm	4x		PZ0 • PZ1 • PZ2 • PZ3
1x		25 mm	8x		T8 • T10 • T15 • T20 • T25 • T27 • T30 • T40
10x		10 • 11 • 12 • 13 • 14 • 15 • 16 • 17 • 18 • 19 mm	8x		TB8 • TB10 • TB15 • TB20 • TB25 • TB27 • TB30 • TB40
6x		10 • 11 • 12 • 13 • 14 • 15 mm	3x		4 • 5 • 6 mm
6x		E10 • E11 • E12 • E14 • E16 • E18	3x		4 • 5,5 • 7 mm
1x		18 mm	5x		M5 • M6 • M8
1x		198 mm	2x		6 • 8 mm
1x		28 mm	3x		4 • 6 • 8 mm
1x		50 mm	3x		1 • 2 • 3 mm
1x		150 mm	3x		PH2 • PH3 • PH4
16x		10 • 11 • 12 • 13 • 14 • 15 • 17 • 18 • 19 • 20 • 21 • 22 • 24 • 27 • 30 • 32 mm	3x		PZ2 • PZ3 • PZ4
3x		17 • 19 • 22 mm	6x		T30 • T40 • T45 • T50 • T55 • T60
2x		16 • 21 mm	6x		TB30 • TB40 • TB45 • TB50 • TB55 • TB60
8x		E10 • E11 • E12 • E14 • E16 • E18 • E20 • E24	3x		8 • 10 • 12 mm
1x		250 mm			

# SOCKETS

1/2"  
12,5 mm



## BT022800...818 1/2" hexagonal socket



start from **4,- €**

BT No.	Ø	← L → mm	EAN 4042146+	€
BT022800	8	38	775943	4,00
BT022801	10	38	775950	4,00
BT022802	11	38	775967	4,00
BT022803	12	38	775974	4,00
BT022804	13	38	775981	4,00
BT022805	14	38	775998	4,00
BT022806	15	38	776001	4,00
BT022807	16	38	776018	4,00
BT022808	17	38	776025	4,00
BT022809	18	38	776032	5,00

BT No.	Ø	← L → mm	EAN 4042146+	€
BT022810	19	38	776049	5,00
BT022811	20	38	776056	5,00
BT022812	21	38	776063	5,00
BT022813	22	38	776070	5,00
BT022814	23	38	776087	6,00
BT022815	24	38	776094	6,00
BT022816	27	38	776100	6,00
BT022817	30	38	776117	7,00
BT022818	32	38	776124	7,00

1/2"  
12,5 mm



## BT022820...830 1/2" hexagonal socket, long version

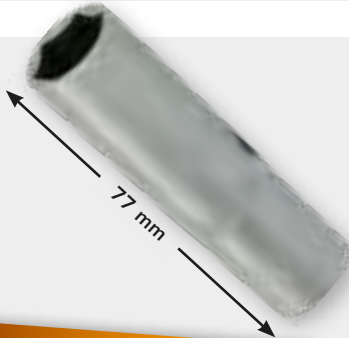

start from **6,- €**

BT No.	Ø	← L → mm	EAN 4042146+	€
BT022820	10	77	776131	6,00
BT022821	11	77	776148	6,00
BT022822	12	77	776155	6,00
BT022823	13	77	776162	6,00
BT022824	14	77	776179	6,00
BT022825	15	77	776186	6,00

BT No.	Ø	← L → mm	EAN 4042146+	€
BT022826	16	77	776193	6,00
BT022827	17	77	776209	6,00
BT022828	18	77	776216	6,00
BT022829	19	77	776223	6,00
BT022830	22	77	776230	7,00

1/2"  
12,5 mm



## BT022850...851 1/2" spark plug socket

**5,- €**



BT No.	Ø	← L → mm	EAN 4042146+	€
BT022850	16	66	776339	5,00
BT022851	21	66	776346	5,00

1/2"  
12,5 mm



## BT022840...848 1/2" Torx E-socket

start from **5,- €**

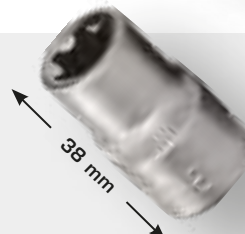

BT No.	Ø	← L → mm	EAN 4042146+	€
BT022840	E10	38	776247	5,00
BT022841	E11	38	776254	5,00
BT022842	E12	38	776261	5,00
BT022843	E14	38	776278	5,00
BT022844	E16	38	776285	5,00

BT No.	Ø	← L → mm	EAN 4042146+	€
BT022845	E18	38	776292	5,00
BT022846	E20	38	776308	5,00
BT022847	E22	38	776315	5,00
BT022848	E24	38	776322	6,00



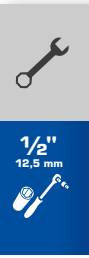

**BT022012**  
**EAN 4042146869291**  
1/2" hexagonal bit socket set, 5 - 22 mm

**12**  
pcs.

**1/2"**  
12,5 mm



**40,- €**

12x



H5 • H6 • H7 • H8 • H10  
• H12 • H14 • H16 • H17  
• H18 • H19 • H22 mm

**BT022860...868**  
1/2" hexagonal bit socket

**1/2"**  
12,5 mm

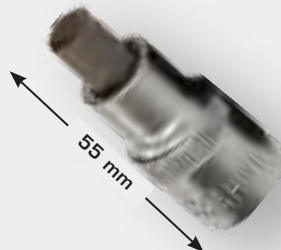

**start from 5,- €**

BT No.	⬡	← L → mm	EAN 4042146+	€	BT No.	⬡	← L → mm	EAN 4042146+	€
BT022860	5	55	776353	5,00	BT022866	14	55	776414	6,00
BT022861	6	55	776360	5,00	BT022858	16	55	869307	7,00
BT022862	7	55	776377	5,00	BT022867	17	55	776421	7,00
BT022863	8	55	776384	5,00	BT022859	18	55	869314	8,00
BT022864	10	55	776391	5,00	BT022868	19	55	776438	8,00
BT022865	12	55	776407	5,00	BT022869	22	55	869321	9,00

# SOCKETS

1/2"  
12,5 mm

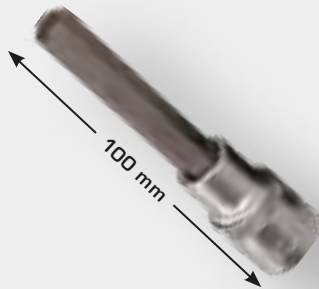

## BT022870...877

1/2" hexagonal bit socket, 100 mm long

start from **3,- €**

BT No.	●	← L → mm	EAN 4042146+	€
BT022870	5	100	776445	5,00
BT022871	6	100	776452	5,00
BT022872	7	100	776469	5,00
BT022873	8	100	776476	5,00
BT022874	10	100	776483	5,00
BT022875	11	100	776490	6,00
BT022876	12	100	776506	6,00
BT022877	13	100	776513	7,00

1/2"  
12,5 mm

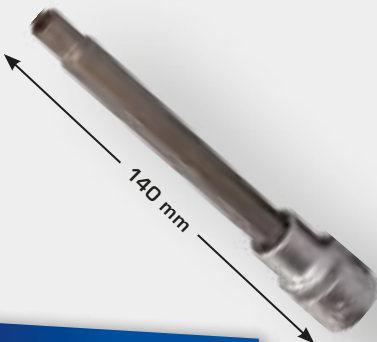

## BT022880...886

1/2" hexagonal bit socket, 140 mm long

start from **6,- €**

BT No.	●	← L → mm	EAN 4042146+	€
BT022880	5	140	776520	6,00
BT022881	6	140	776537	6,00
BT022882	7	140	776544	6,00
BT022883	8	140	776551	6,00
BT022884	10	140	776568	6,00
BT022885	12	140	776575	6,00
BT022886	14	140	776582	7,00

1/2"  
12,5 mm



## BT022890...895

1/2" hexagonal bit socket, 200 mm long

start from **7,- €**

BT No.	●	← L → mm	EAN 4042146+	€
BT022890	5	200	776599	7,00
BT022891	6	200	776605	7,00
BT022892	7	200	776612	7,00
BT022893	8	200	776629	7,00
BT022894	10	200	776636	7,00
BT022895	12	200	776643	8,00



1/2"  
12,5 mm

**BT022930...937**

1/2" spline bit socket, 55 mm long

start from **5,- €**

BT No.	●	← L → mm	EAN 4042146+	€
BT022930	M5	55	776650	5,00
BT022931	M6	55	776667	5,00
BT022932	M8	55	776674	5,00
BT022933	M9	55	776681	5,00
BT022934	M10	55	776698	5,00
BT022935	M12	55	776704	5,00
BT022936	M14	55	776711	6,00
BT022937	M16	55	776728	7,00

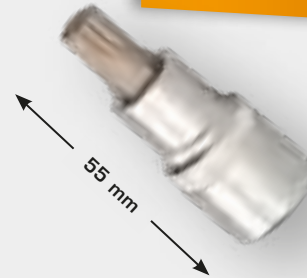

1/2"  
12,5 mm

**BT022940...946**

1/2" spline bit socket, 100 mm long

start from **5,- €**

BT No.	●	← L → mm	EAN 4042146+	€
BT022940	M5	100	776735	5,00
BT022941	M6	100	776742	5,00
BT022942	M8	100	776759	5,00
BT022943	M9	100	776766	5,00
BT022944	M10	100	776773	5,00
BT022945	M12	100	776780	6,00
BT022946	M14	100	776797	7,00

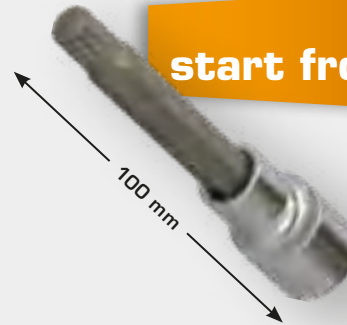

1/2"  
12,5 mm

**BT022950...956**

1/2" spline bit socket, 140 mm long

start from **6,- €**

BT No.	●	← L → mm	EAN 4042146+	€
BT022950	M5	140	776803	6,00
BT022951	M6	140	776810	6,00
BT022952	M8	140	776827	6,00
BT022953	M9	140	776834	6,00
BT022954	M10	140	776841	6,00
BT022955	M12	140	776858	6,00
BT022956	M14	140	776865	7,00

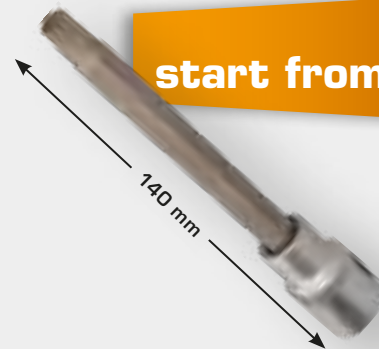

1/2"  
12,5 mm

**BT022960...963**

1/2" spline bit socket, 200 mm long

start from **7,- €**

BT No.	●	← L → mm	EAN 4042146+	€
BT022960	M8	200	776872	7,00
BT022961	M10	200	776889	7,00
BT022962	M12	200	776896	8,00
BT022963	M14	200	776902	9,00

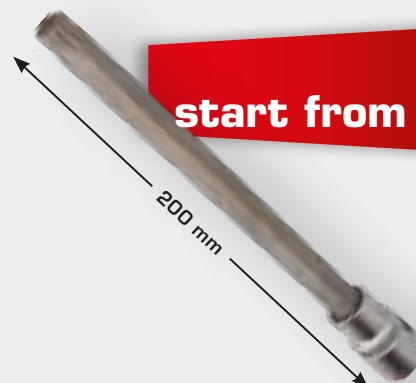

# SOCKETS

start from **5,- €**

1/2"  
12,5 mm



**BT022970...979**  
1/2" TORX® bit socket, 55 mm long



BT No.	★	← L → mm	EAN 4042146+	€
BT022970	T20	55	776919	5,00
BT022971	T25	55	776926	5,00
BT022972	T27	55	776933	5,00
BT022973	T30	55	776940	5,00
BT022974	T40	55	776957	5,00

BT No.	★	← L → mm	EAN 4042146+	€
BT022975	T45	55	776964	5,00
BT022976	T50	55	776971	5,00
BT022977	T55	55	776988	5,00
BT022978	T60	55	776995	5,00
BT022979	T70	55	777008	6,00

start from **5,- €**

1/2"  
12,5 mm



**BT022980...989**  
1/2" TORX® bit socket, 100 mm long

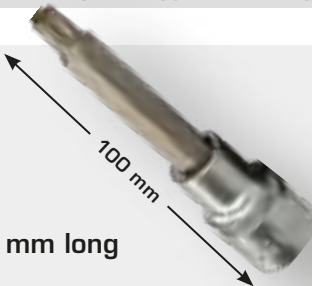

BT No.	★	← L → mm	EAN 4042146+	€
BT022980	T20	100	777015	5,00
BT022981	T25	100	777022	5,00
BT022982	T27	100	777039	5,00
BT022983	T30	100	777046	5,00
BT022984	T40	100	777053	5,00

BT No.	★	← L → mm	EAN 4042146+	€
BT022985	T45	100	777060	5,00
BT022986	T50	100	777077	5,00
BT022987	T55	100	777084	5,00
BT022988	T60	100	777091	6,00
BT022989	T70	100	777107	7,00

start from **6,- €**

1/2"  
12,5 mm



**BT022700...705**  
1/2" TORX® bit socket, 140 mm long

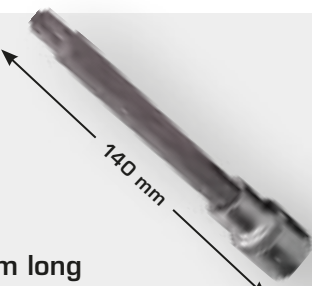

BT No.	★	← L → mm	EAN 4042146+	€
BT022700	T40	140	777114	6,00
BT022701	T45	140	777121	6,00
BT022702	T50	140	777138	6,00

BT No.	★	← L → mm	EAN 4042146+	€
BT022703	T55	140	777145	6,00
BT022704	T60	140	777152	6,00
BT022705	T70	140	777169	8,00

start from **7,- €**

1/2"  
12,5 mm



**BT022710...715**  
1/2" TORX® bit socket, 200 mm long

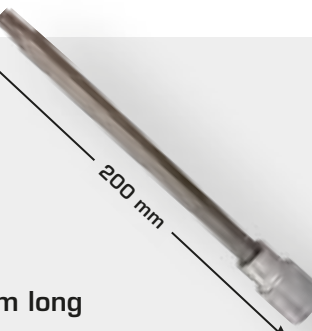

BT No.	★	← L → mm	EAN 4042146+	€
BT022710	T40	200	777176	7,00
BT022711	T45	200	777183	7,00
BT022712	T50	200	777190	7,00

BT No.	★	← L → mm	EAN 4042146+	€
BT022713	T55	200	777206	7,00
BT022714	T60	200	777213	8,00
BT022715	T70	200	777220	9,00



1/2"  
12,5 mm

1/2"  
12,5 mm



start from **5,- €**

**BT022720...728**  
1/2" RIBE bit socket, 55 mm long

BT No.		← L → mm	EAN 4042146+	€
BT022720	M5	55	777237	5,00
BT022721	M6	55	777244	5,00
BT022722	M7	55	777251	5,00
BT022723	M8	55	777268	5,00
BT022724	M9	55	777275	5,00

BT No.		← L → mm	EAN 4042146+	€
BT022725	M10	55	777282	5,00
BT022726	M12	55	777299	5,00
BT022727	M13	55	777305	6,00
BT022728	M14	55	777312	6,00

1/2"  
12,5 mm

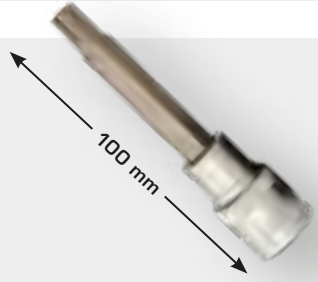

start from **5,- €**

**BT022730...738**  
1/2" RIBE bit socket, 100 mm long

BT No.		← L → mm	EAN 4042146+	€
BT022730	M5	100	777329	5,00
BT022731	M6	100	777336	5,00
BT022732	M7	100	777343	5,00
BT022733	M8	100	777350	5,00
BT022734	M9	100	777367	5,00

BT No.		← L → mm	EAN 4042146+	€
BT022735	M10	100	777374	5,00
BT022736	M12	100	777381	6,00
BT022737	M13	100	777398	7,00
BT022738	M14	100	777404	7,00

1/2"  
12,5 mm

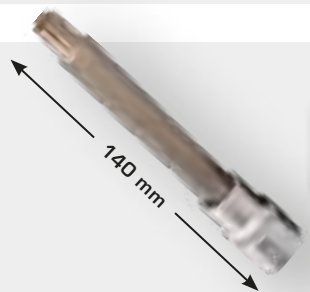

start from **6,- €**

**BT022740...746**  
1/2" RIBE bit socket, 140 mm long

BT No.		← L → mm	EAN 4042146+	€
BT022740	M8	140	777411	6,00
BT022741	M9	140	777428	6,00
BT022742	M10	140	777435	6,00
BT022743	M10,3	140	777442	6,00

BT No.		← L → mm	EAN 4042146+	€
BT022744	M12	140	777459	6,00
BT022745	M13	140	777466	7,00
BT022746	M14	140	777473	7,00

1/2"  
12,5 mm

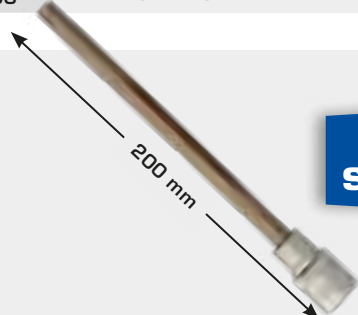

start from **6,- €**

**BT022750...756**  
1/2" RIBE bit socket, 200 mm long

BT No.		← L → mm	EAN 4042146+	€
BT022750	M8	200	777480	6,00
BT022751	M9	200	777497	7,00
BT022752	M10	200	777503	7,00
BT022753	M10,3	200	777510	8,00

BT No.		← L → mm	EAN 4042146+	€
BT022754	M12	200	777527	8,00
BT022755	M13	200	777534	11,00
BT022756	M14	200	777541	11,00

# SOCKETS

**BT022030**  
**EAN 4042146775905**  
 1/2" bit socket set, hexagonal profile

**30**  
 pcs.

1/2"  
 12,5 mm



**69,- €**



Profil		< L > mm	Size
9x		55 mm	5 • 6 • 7 • 8 • 10 • 12 • 14 • 17 • 19 mm
8x		100 mm	5 • 6 • 7 • 8 • 10 • 11 • 12 • 13 mm
7x		140 mm	5 • 6 • 7 • 8 • 10 • 12 • 14 mm
6x		200 mm	5 • 6 • 7 • 8 • 10 • 12 mm

**BT022032**  
**EAN 4042146775912**  
 1/2" bit socket set, RIBE profile

**32**  
 pcs.

1/2"  
 12,5 mm



**69,- €**



Profil		< L > mm	Size
9x		55	M5 • M6 • M7 • M8 • M9 • M10 • M12 • M13 • M14
9x		100	M5 • M6 • M7 • M8 • M9 • M10 • M12 • M13 • M14
7x		140	M8 • M9 • M10 • M10,3 • M12 • M13 • M14
7x		200	M8 • M9 • M10 • M10,3 • M12 • M13 • M14



1/2"  
12,5 mm

**26**  
pcs.



**BT022026**  
**EAN 4042146775929**  
1/2" bit socket-set, spline profile,  
XZN



1/2"  
12,5 mm



**69,- €**

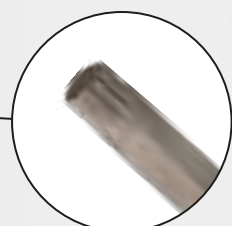

Profil		← L → mm	Size
8x			55 M5 • M6 • M8 • M9 • M10 • M12 • M14 • M16
8x			100 M5 • M6 • M8 • M9 • M10 • M12 • M14
7x			140 M5 • M6 • M8 • M9 • M10 • M12 • M14
3x			200 M10 • M12 • M14

**32**  
pcs.



**BT022532**  
**EAN 4042146775936**  
1/2" bit socket set, TORX®profile



1/2"  
12,5 mm



**69,- €**



Profil		← L → mm	Size
10x			55 T20 • T25 • T27 • T30 • T40 • T45 • T50 • T55 • T60 • T70
10x			100 T20 • T25 • T27 • T30 • T40 • T45 • T50 • T55 • T60 • T70
6x			140 T40 • T45 • T50 • T55 • T60 • T70
6x			200 T40 • T45 • T50 • T55 • T60 • T70

# SOCKETS

**BT023002**  
**EAN 4042146777770**  
 1/4" + 1/2" Reversible  
 ratchet set

**2**  
 pcs.

**2K**

**1/4"**  
 6,3 mm

**1/2"**  
 12,5 mm

**29,- €**



**BT022900**  
**EAN 4042146777763**  
 1/2" Reversible ratchet

**1/2"**  
 12,5 mm

**2K**

250 mm

5° 72

**22,- €**

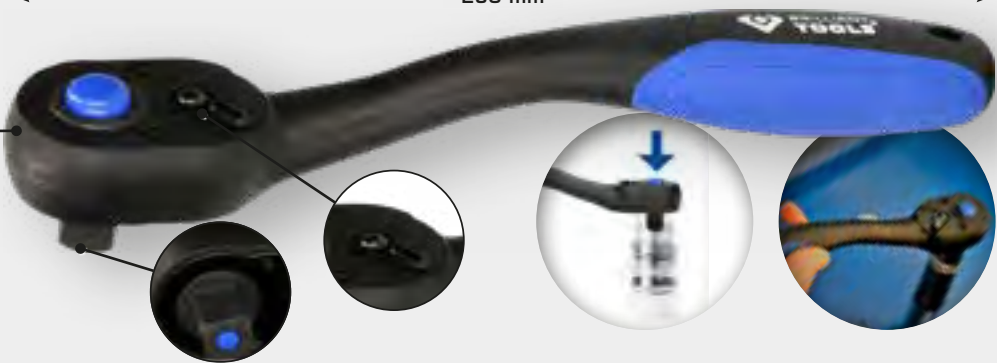

**BT022995**  
**EAN 4042146845004**  
 1/2" reversible ratchet with metal handle, 100 tooth

**1/2"**  
 12,5 mm

100 3,6°

250 mm

**20,- €**

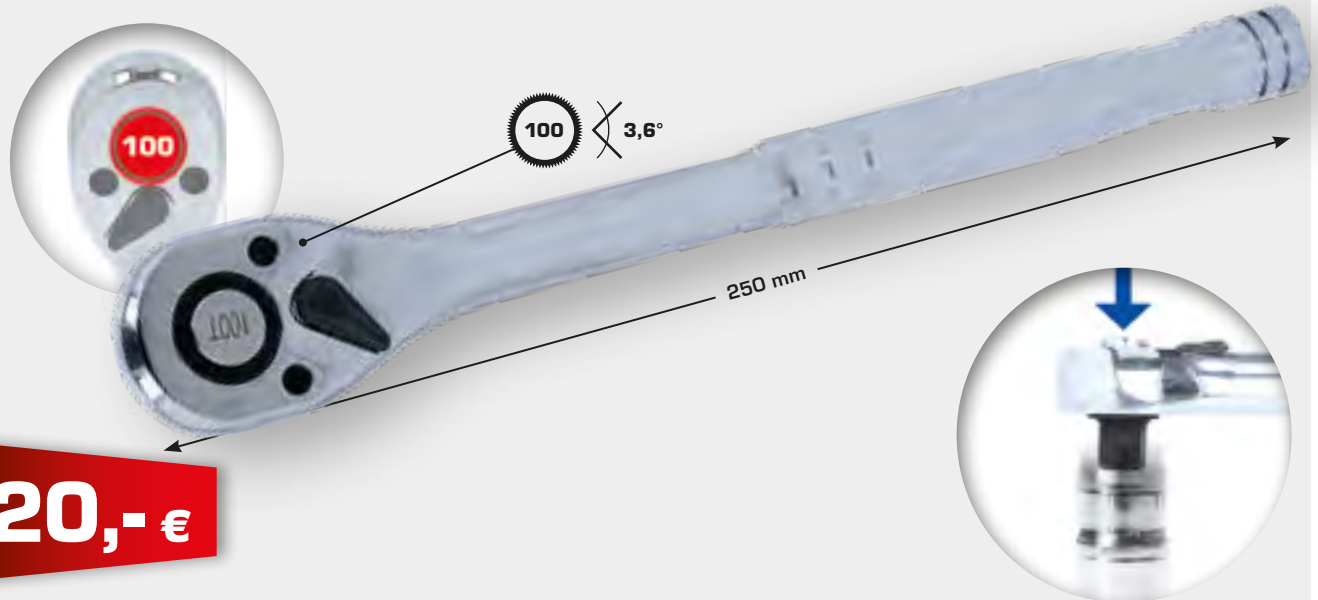





1/2"  
12,5 mm

**BT022992**  
**EAN 4042146844960**  
1/2" telescopic reversible ratchet



**22,- €**

**BT022993**  
**EAN 4042146844977**  
1/2" telescopic reversible  
ratchet with flexible head



**30,- €**

**BT022401**  
**EAN 4042146869277**  
1/2" telescopic handle



**35,- €**

**BT022401-1**  
**EAN 4042146869284**  
Replacement head for BT022401

**6,- €**

# WHETHER LONG OR SHORT: ALWAYS THE RIGHT CHOICE!

BT022901  
EAN 4042146777558  
1/2" Sliding T-handle

1/2"  
12,5 mm

8,- €

1/2"

100 mm

3/8"

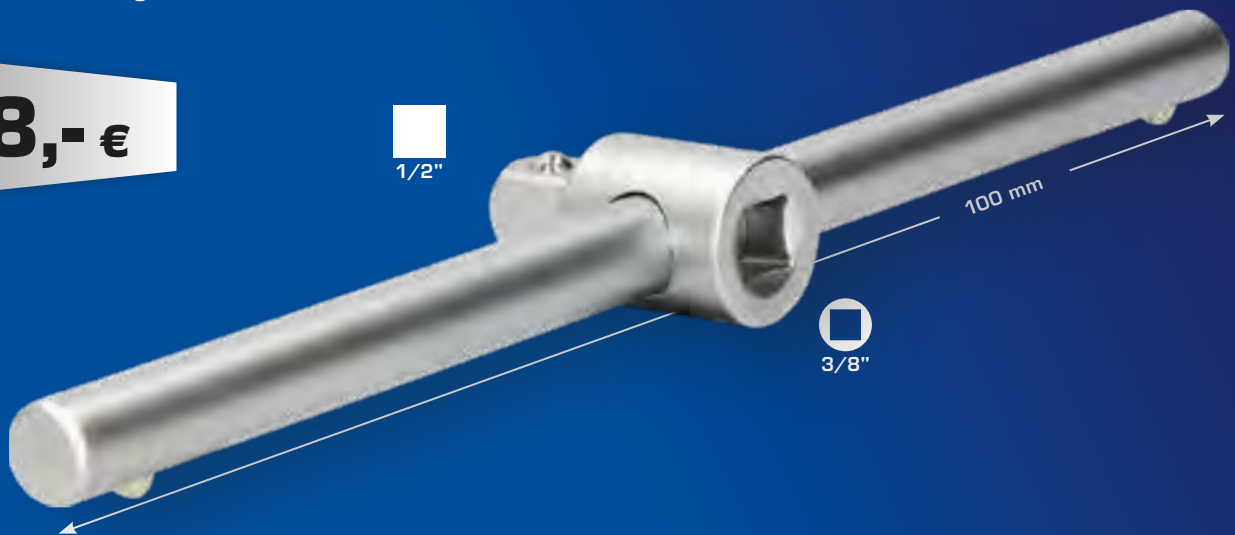



1/2"  
12,5 mm

1/2"  
12,5 mm

51 mm

**5,- €**

**BT022902**  
**EAN 4042146777565**  
1/2" TORX<sup>®</sup> E-socket, tamper-proof, TB55

1/2"  
12,5 mm

75 mm

**6,- €**

**BT022904**  
**EAN 4042146777589**  
1/2" Universal joint

1/2"  
12,5 mm

1/2"

43,7 mm

3/8"

**5,- €**

**BT022903**  
**EAN 4042146777572**  
1/2" Sliding piece

1/2"  
12,5 mm

3/8"

36 mm

1/2"

**4,- €**

**BT022905**  
**EAN 4042146777596**  
1/2" Adapter for 3/8"

1/2"  
12,5 mm

3/4"

46 mm

3/8"

**5,- €**

**BT022906**  
**EAN 4042146777602**  
1/2" Adapter for 3/4"

1/2"  
12,5 mm

1/4"

37 mm

1/2"

**4,- €**

**BT022907**  
**EAN 4042146777619**  
1/2" Bit adaptor for 1/4"

# SOCKETS

**BT022908...910**

**1/2" extension**

**1/2"**  
12,5 mm

**start from 5,- €**

BT No.	← L → mm	EAN 4042146+	€
BT022908	125	777176	5,00
BT022909	250	777183	8,00
BT022910	750	777190	17,00

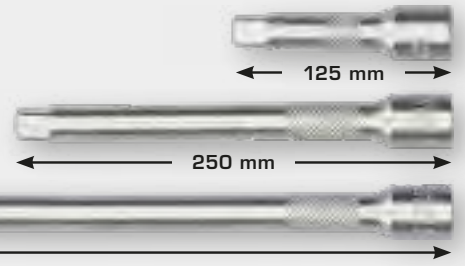

**BT022911...913**

**1/2" wobble extension**

**1/2"**  
12,5 mm

BT No.	← L → mm	EAN 4042146+	€
BT022911	50	777657	4,00
BT022912	75	777664	5,00
BT022913	250	777671	8,00

**start from 4,- €**

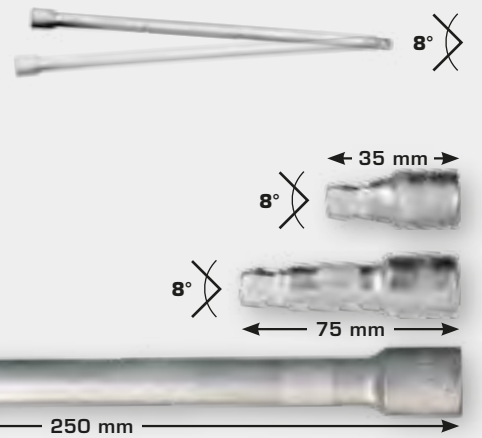

**BT020009**

**EAN 4042146867372**

**Wobble extension set**

**9**  
pcs.

**1/4"** 6,3 mm  
**3/8"** 10 mm  
**1/2"** 12,5 mm

**29,- €**





**6**  
pcs.

**1/4"**  
6,3 mm

**3/8"**  
10 mm

**1/2"**  
12,5 mm

**BT024006**

**EAN 4042146777732**

Adapter set, 1/4" + 3/8" + 1/2" + 3/4"

- |               |               |
|---------------|---------------|
| 1/4" X 3/8" ✓ | 1/2" X 3/8" ✓ |
| 3/8" X 1/4" ✓ | 1/2" X 3/4" ✓ |
| 3/8" X 1/2" ✓ | 3/4" X 1/2" ✓ |



1x		1/4" X 3/8"	1x		1/2" X 3/8"
1x		3/8" X 1/4"	1x		1/2" X 3/4"
1x		3/8" X 1/2"	1x		3/4" X 1/2"

**15,- €**

# SOCKETS

**58**  
pcs.

**BT024064**  
**EAN 4042146778654**  
Universal tool set  
in nylon case

**1/4"**  
6,3 mm



**89,- €**



1/2"  
12,5 mm

# WITH THEM YOU ARE ALWAYS WELL ON THE WAY!

Profil		Size / Length	Profil		Size / Length
7x		7 • 8 • 9 • 10 • 11 • 12 • 13 mm	1x		300 mm
1x		25 mm	1x		4 x 0,8 mm
7x		12 • 14 • 15 • 16 • 17 • 19 • 21 mm	1x		160 mm
1x		150 mm	4x		PH1 • PH2 (2x) • PH3
1x		6+1 SMD / 40 Lumen	4x		PZ1 • PZ2 (2x) • PZ3
1x		250 mm	4x		4 x 0,8 • 5 x 1 • 6,5 x 1,2 • 8 x 1,6 mm
1x		150 mm	4x		3 • 4 • 5 • 6 mm
1x		L	7x		T10 • T15 • T20 • T25 • T27 • T30 • T40
1x		400 x 300 mm	7x		TB10 • TB15 • TB20 • TB25 • TB27 • TB30 • TB40
1x		150 mm	1x		-
1x		133-645 mm	1x		60 mm

# SOCKETS

**95**  
pcs.

**BT024095**  
**EAN 4042146777718**  
1/4" + 1/2" universal tool set

1/4"  
6,3 mm  
1/2"  
12,5 mm



**149,- €**





1/2"  
12,5 mm

Profil		Size / Length	Profil		Size / Length
12x 1/4" O		4 • 4,5 • 5 • 5,5 • 6 • 7 • 8 • 9 • 10 • 11 • 12 • 13 mm	1x 1/2"		125 mm
4x 1/4" H		3 • 4 • 5 • 6 mm	12x O		8 • 9 • 10 • 11 • 12 • 13 • 14 • 15 • 16 • 17 • 18 • 19 mm
3x 1/4" H		0,8x4 • 1x5,5 • 1,2x6,5 mm	4x H		0,6 x 3 • 0,8 x 4 • 1 x 5,5 • 1,2 x 6,5 mm
3x 1/4" +		PH0 • PH1 • PH2	3x +		PH0 • PH1 • PH2
3x 1/4" +		PZ0 • PZ1 • PZ2	1x H		1,5 • 2 • 2,5 • 3 • 4 • 5 • 6 • 8 • 10 mm
6x 1/4" *		T9 • T10 • T15 • T20 • T25 • T30	1x *		T10 • T15 • T20 • T25 • T27 • T30 • T40 • T45 • T50
1x 1/4"		150 mm	1x		160 mm
1x 1/4"		40 mm	1x		200 mm
1x 1/4"		100 mm	1x		300 mm
16x 1/2" O		10 • 11 • 12 • 13 • 14 • 15 • 16 • 17 • 19 • 20 • 21 • 22 • 24 • 27 • 30 • 32 mm	1x		
1x 1/2"		250 mm			
1x 1/2"		75 mm			

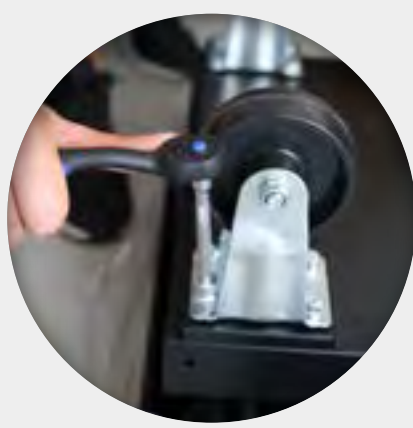
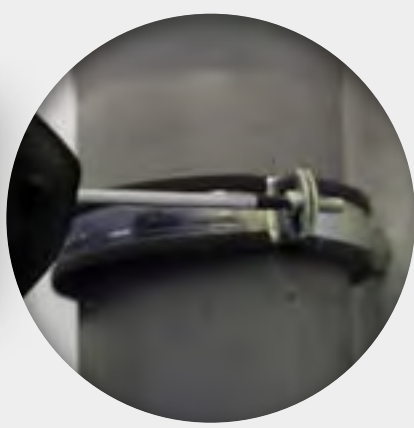

# SOCKETS

**143**  
pcs.

**BT024143**  
**EAN 4042146777725**  
Universal tool case



**1/4"**  
6,3 mm  
**1/2"**  
12,5 mm



**249,- €**

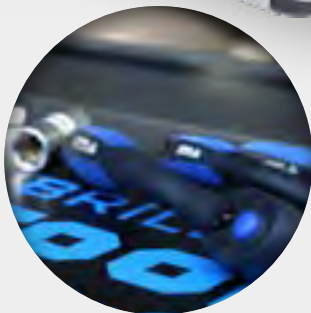
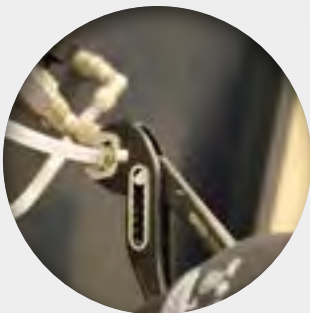



1/2"  
12,5 mm



Profil	Size / Length
1x	150 mm
1x	250 mm
1x	40 mm
1x	75 mm
2x	50 • 100 mm
2x	125 • 250 mm
16x	10 • 11 • 12 • 13 • 14 • 15 • 16 • 17 • 19 • 20 • 21 • 22 • 24 • 27 • 30 • 32 mm
12x	4 • 4,5 • 5 • 5,5 • 6 • 7 • 8 • 9 • 10 • 11 • 12 • 13 mm
12x	8 • 9 • 10 • 11 • 12 • 13 • 14 • 15 • 16 • 17 • 18 • 19 mm
4x	0,6 x 3 • 0,8 x 4 • 1 x 5,5 • 1,2 x 6,5 mm
3x	PH0 • PH1 • PH2
1x	1,5 • 2 • 2,5 • 3 • 4 • 5 • 6 • 8 • 10 mm
1x	T10 • T15 • T20 • T25 • T27 • T30 • T40 • T45 • T50
1x	180 mm
1x	0-150 mm
1x	133-645 mm
1x	150 mm
1x	150 mm
1x	150 mm
1x	150 mm
3x	
2x	Hieb 2

Profil	Size / Length
1x	160 mm
1x	200 mm
1x	300 mm
1x	3 m
32x	<ul style="list-style-type: none"> <li>◆ PZ1, PZ2, PZ3</li> <li>◆ PH: PH1, PH2, PH3</li> <li>◆ 3, 4, 5, 6 mm</li> <li>◆ T10, T15, T20, T25, T27, T30, T40</li> <li>◆ 3, 4, 5, 6 mm Magnet-Schnellöse-Bithalter - Antrieb Vierkant 6,3 mm (1/4") für Bits 6,3 mm (1/4")</li> </ul>
1x	202 mm
1x	125 mm
1x	300 mm
6x	∅ 2 • 3 • 4 • 5 • 6 • 8 x 150 mm
1x	250 mm
1x	6+1 SMD / 40 Lumen
1x	4 x 0,8 mm
1x	150 mm

# SPECIAL SOLUTIONS FOR SPECIAL PROBLEMS

1/2"  
12,5 mm

10  
pcs.

BT026000  
EAN 4042146869963  
1/2" Spiral-Profil socket set,  
10 - 19mm



Profil	$\leftarrow L \rightarrow$ mm	Size
9x 	50	10 • 11 • 12 • 13 • 14 • 15 • 16 • 17 • 19 mm

75,- €

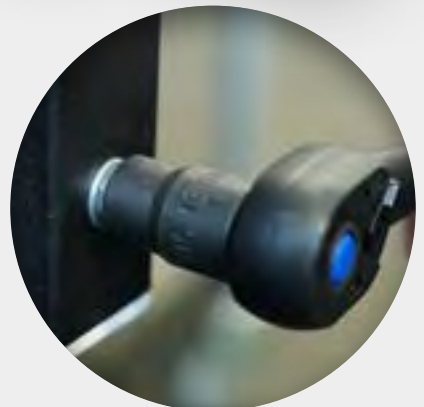
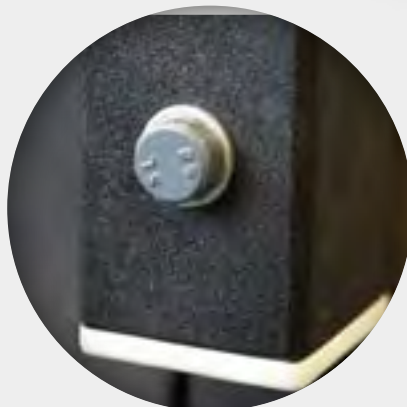
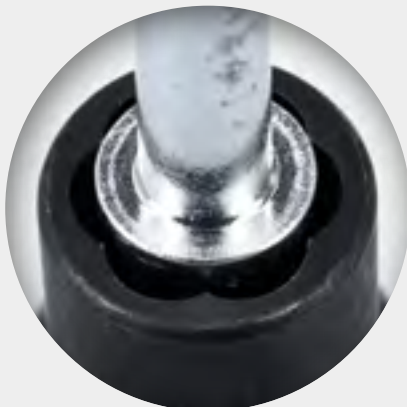



1/2"  
12,5 mm

7  
pcs.

1/2"  
12,5 mm



**BT026005**  
**EAN 4042146869970**  
1/2" Spiral-Profil socket set,  
21 - 32mm



**79,- €**

Profil		← L → mm	Size
6x		50	21 • 22 • 24 • 27 • 30 • 32 mm

1/2"  
12,5 mm



**BT026001...018**  
1/2" spiral-profile socket,  
10 - 32 mm

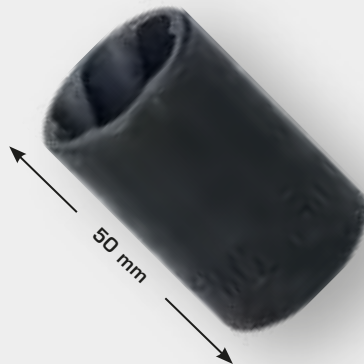

start from **10,- €**

BT No.		← L → mm	EAN 4042146+	€	BT No.		← L → mm	EAN 4042146+	€		
BT026001		10 mm	50	869987	10,00	BT026011		19 mm	50	870068	12,00
BT026002		11 mm	50	869994	10,00	BT026012		21 mm	50	870075	12,00
BT026003		12 mm	50	870006	10,00	BT026013		22 mm	50	870082	13,00
BT026004		13 mm	50	870013	10,00	BT026014		24 mm	50	870099	13,00
BT026006		14 mm	50	870020	10,00	BT026016		27 mm	50	870105	14,00
BT026007		15 mm	50	870037	10,00	BT026017		30 mm	50	870112	14,00
BT026008		16 mm	50	870044	11,00	BT026018		32 mm	50	870129	15,00
BT026009		17 mm	50	870051	11,00						

# SOCKETS

**BT022003**  
**EAN 4042146868508**  
 Universal socket set,  
 5 – 32 mm

5 - 32 mm

1/4"  
6,3 mm  
 3/8"  
10 mm  
 1/2"  
12,5 mm

**35,- €**

1/4"  
6,3 mm

5 - 14 mm

**BT020899**  
**EAN 4042146868485**  
 1/4" universal socket

40 mm

**11,- €**

3/8"  
10 mm

7 - 19 mm

**BT021899**  
**EAN 4042146844953**  
 3/8" universal socket

55 mm

**17,- €**

1/2"  
12,5 mm

11 - 32 mm

**BT022899**  
**EAN 4042146868492**  
 1/2" universal socket

85 mm

**23,- €**



3/4"  
19 mm





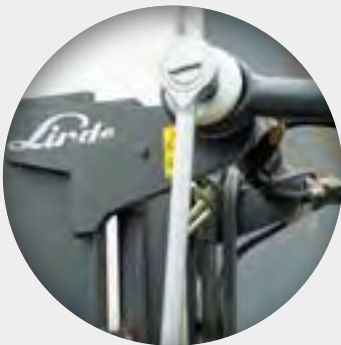
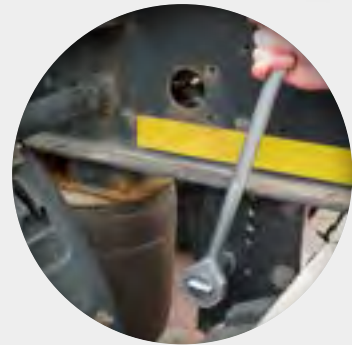
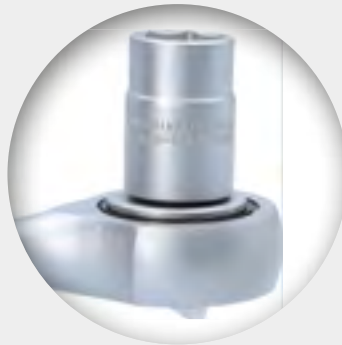
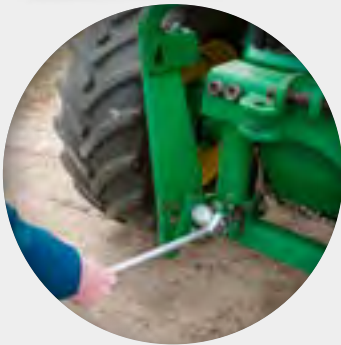

3/4"  
19 mm

20  
pcs.

3/4"  
19 mm

BT025020  
EAN 4042146863015  
3/4" socket set



Profil	Size / Length
1x 	 100 mm
1x 	 450 mm
2x  	 100 • 200 mm

Profil	Size / Length
16x 	 19 • 22 • 24 • 26 • 27 • 28 • 30 • 32 • 34 • 36 • 38 • 41 • 42 • 45 • 48 • 50 mm

**119,- €**

## SOCKETS

**BT025900**  
**EAN 4042146862971**  
 3/4" reversible ratchet, 24 teeth

**35,- €**

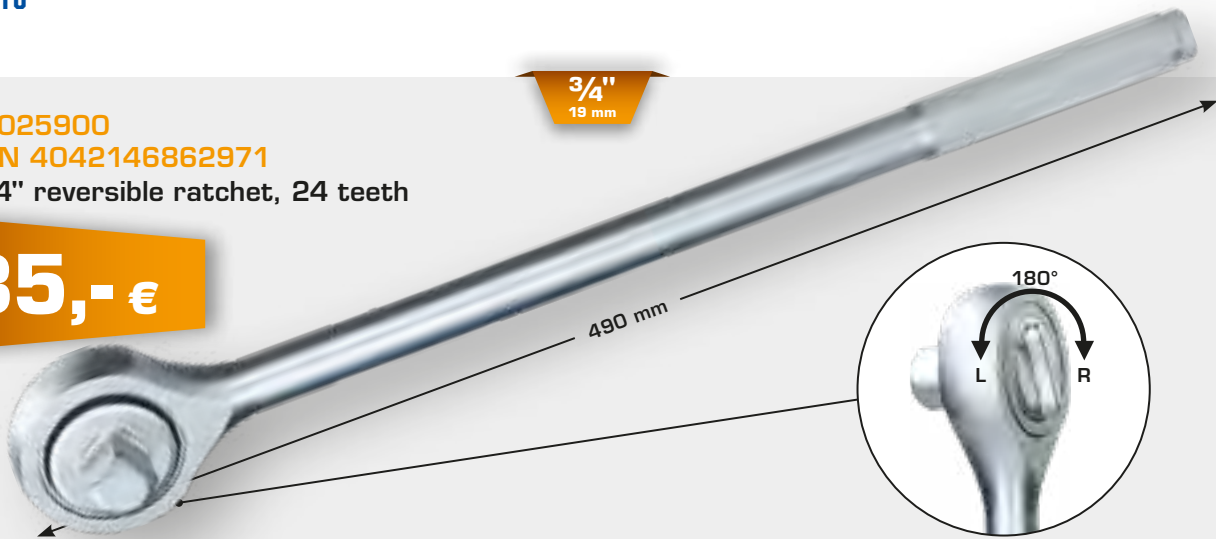

**BT025905**  
**EAN 4042146862988**  
 3/4" slide grip

**20,- €**

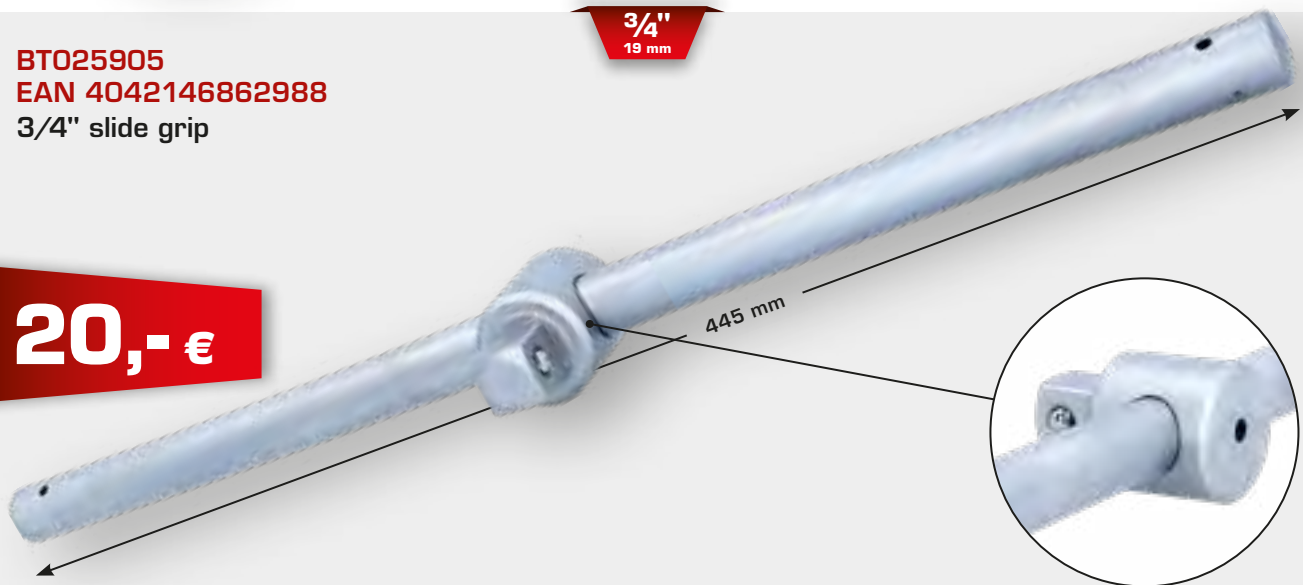

**BT025919...950**  
 3/4" hexagonal socket

**start from 8,- €**

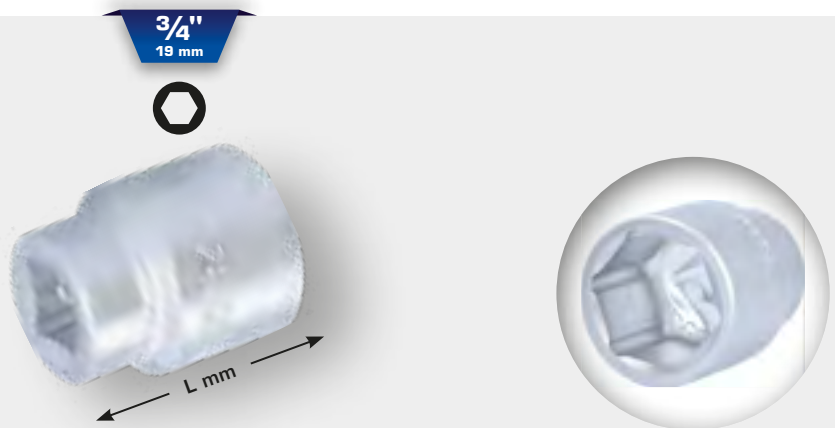

BT No.	Ø	← L → mm	EAN 4042146+	€	BT No.	Ø	← L → mm	EAN 4042146+	€
BT025919	19 mm	49	862773	8,00	BT025934	34 mm	59	862896	10,00
BT025922	22 mm	49	862827	8,00	BT025936	36 mm	60	862902	10,00
BT025924	24 mm	51	862834	8,00	BT025938	38 mm	62	862919	10,00
BT025926	26 mm	51	862841	8,00	BT025941	41 mm	62	862926	11,00
BT025927	27 mm	55	862858	8,00	BT025942	42 mm	65	862933	11,00
BT025928	28 mm	55	862865	9,00	BT025945	45 mm	67	862940	12,00
BT025930	30 mm	55	862872	9,00	BT025948	48 mm	69	862957	14,00
BT025932	32 mm	55	862889	9,00	BT025950	50 mm	70	862964	14,00





3/4"  
19 mm

**BT025906...907**  
3/4" extension

3/4"  
19 mm

start from **12,- €**

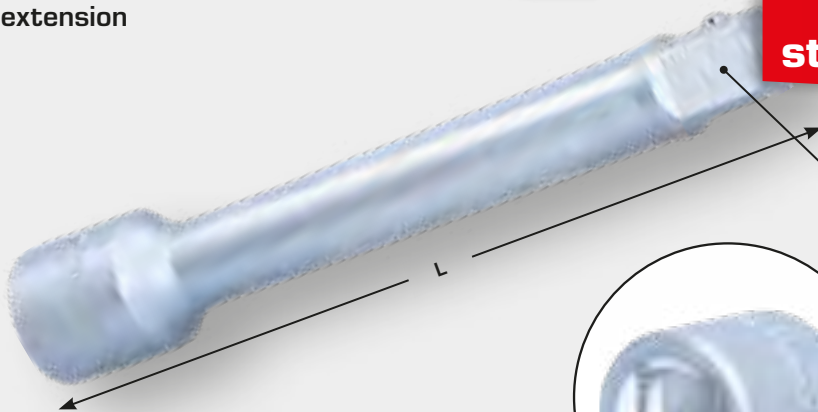

BT No.	O	← L → mm	EAN 4042146+	€
BT025906	3/4"	100	862995	12,00
BT025907	3/4"	200	863008	14,00



**THERE FOR YOU  
WHEN IT GETS TIGHT!**

## IMPACT SOCKET

8  
pcs.

1/2"  
12,5 mm

**BT022600**  
EAN 4042146869338  
1/2" impact bit socket set,  
TORX®, T30 - T80



**45,- €**

Profil	< L > mm	Size
8x		T30 • T40 • T45 • T50 • T55 • T60 • T70 • T80 mm

1/2"  
12,5 mm

**BT022601... 609**  
1/2" impact bit socket TORX®

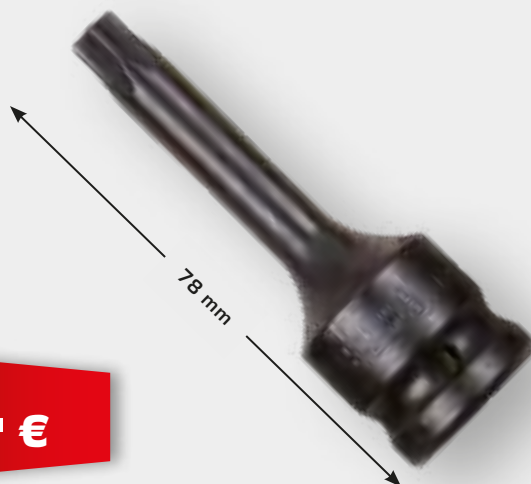

**8,- €**

BT No.		< L > mm	EAN 4042146+	€
BT022601	T 30	78	869345	8,00
BT022602	T 40	78	869352	8,00
BT022603	T 45	78	869369	8,00
BT022604	T 50	78	869376	8,00
BT022606	T 55	78	869383	8,00
BT022607	T 60	78	869390	8,00
BT022608	T 70	78	869406	8,00
BT022609	T 80	78	869413	8,00



1/2"  
12,5 mm

**8**  
pcs.

1/2"  
12,5 mm

**BT022605**  
**EAN 4042146869420**  
1/2" impact bit socket set, XZN,  
M5 – M18



Profil	← L → mm	Size
8x	78	M5 • M6 • M8 • M10 • M12 • M14 • M16 • M18 mm

**45,- €**

1/2"  
12,5 mm

**BT022611... 619**  
1/2" impact bit socket XZN

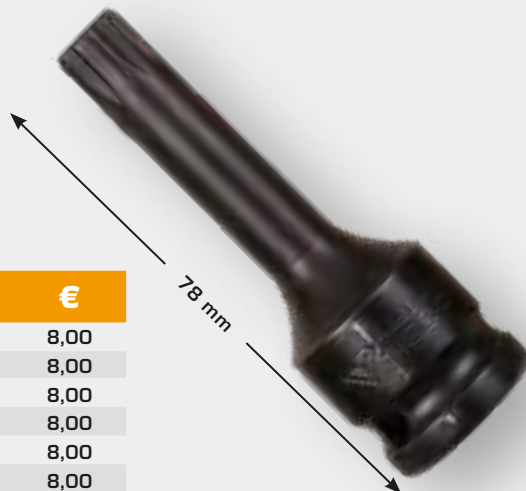

BT No.		← L → mm	EAN 4042146+	€
BT022611	M5	78	869437	8,00
BT022612	M6	78	869444	8,00
BT022613	M8	78	869451	8,00
BT022614	M10	78	869468	8,00
BT022616	M12	78	869475	8,00
BT022617	M14	78	869482	8,00
BT022618	M16	78	869499	8,00
BT022619	M18	78	869505	8,00

**8,- €**

## IMPACT SOCKET

**8**  
pcs.

**1/2"**  
12,5 mm

**BT022615**

**EAN 4042146869512**

1/2" impact bit socket hexagon socket set,  
5 - 19 mm



**45,- €**

Profil	← L → mm	Size
8x 	78	H5 • H6 • H8 • H10 • H12 • H14 • H17 • H19 mm

**8,- €**

**1/2"**  
12,5 mm

**BT022621...629**

1/2" impact bit hexagon socket

BT No.	⬡	← L → mm	EAN 4042146+	€
BT022621	5 mm	78	869529	8,00
BT022622	6 mm	78	869536	8,00
BT022623	8 mm	78	869543	8,00
BT022624	10 mm	78	869550	8,00
BT022626	12 mm	78	869567	8,00
BT022627	14 mm	78	869574	8,00
BT022628	17 mm	78	869581	8,00
BT022629	19 mm	78	869598	8,00

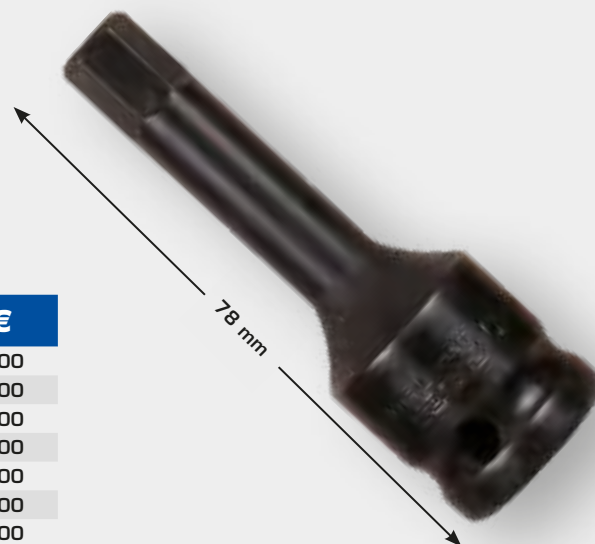



1/2"  
12,5 mm

**13**  
pcs.

1/2"  
12,5 mm



**BT022620**  
**EAN 4042146869628**  
1/2" impact hexagon socket  
set, short



Profil	← L → mm	Size
13x	38	10 • 11 • 12 • 13 • 14 • 15 • 16 • 17 • 18 • 19 • 21 • 22 • 24 mm

**45,- €**

**BT022631...668**  
1/2" impact hexagon  
socket, short

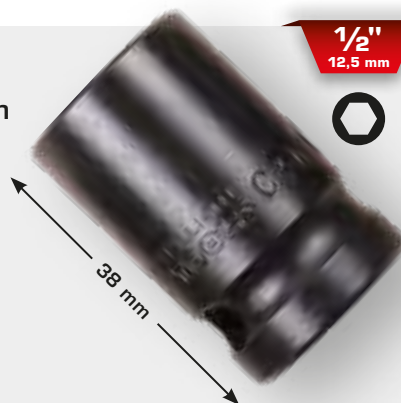

1/2"  
12,5 mm



start from **6,- €**

BT No.	○	← L → mm	EAN 4042146+	€
BT022631	10 mm	38	869635	6,00
BT022632	11 mm	38	869642	6,00
BT022633	12 mm	38	869659	6,00
BT022634	13 mm	38	869666	6,00
BT022636	14 mm	38	869673	6,00
BT022637	15 mm	38	869680	6,00
BT022638	16 mm	38	869697	6,00
BT022639	17 mm	38	869703	6,00

BT No.	○	← L → mm	EAN 4042146+	€
BT022641	18 mm	38	869710	6,00
BT022642	19 mm	38	869727	6,00
BT022643	20 mm	38	869734	7,00
BT022644	21 mm	38	869741	7,00
BT022646	22 mm	38	869758	7,00
BT022647	23 mm	38	869765	8,00
BT022648	24 mm	38	869772	8,00
BT022668	27 mm	38	869789	8,00

## IMPACT SOCKET

**BT022625**  
**EAN 4042146869802**  
 1/2" impact bit hexagon  
 socket set, long,  
 10 – 24 mm

**13**  
 pcs.

**1/2"**  
 12,5 mm



**65,- €**

Profil	← L → mm	Size
13x		78 10 • 11 • 12 • 13 • 14 • 15 • 16 • 17 • 18 • 19 • 21 • 22 • 24 mm

**BT022649...667**  
 1/2" impact hexagon  
 socket, long

**1/2"**  
 12,5 mm



**start from 8,- €**

78 mm

BT No.		← L → mm	EAN 4042146+	€	BT No.		← L → mm	EAN 4042146+	€
BT022649	10 mm	78	869819	8,00	BT022659	18 mm	78	869895	8,00
BT022651	11 mm	78	869826	8,00	BT022661	19 mm	78	869901	8,00
BT022652	12 mm	78	869833	8,00	BT022662	20 mm	78	869918	9,00
BT022653	13 mm	78	869840	8,00	BT022663	21 mm	78	869925	9,00
BT022654	14 mm	78	869857	8,00	BT022664	22 mm	78	869932	10,00
BT022656	15 mm	78	869864	8,00	BT022666	23 mm	78	869949	10,00
BT022657	16 mm	78	869871	8,00	BT022667	24 mm	78	869956	10,00
BT022658	17 mm	78	869888	8,00					



1/2"  
12,5 mm

**BT691011**  
**EAN 4042146844823**  
1/2" 4in1 impact socket set

**2**  
pcs.

1/2"  
12,5 mm

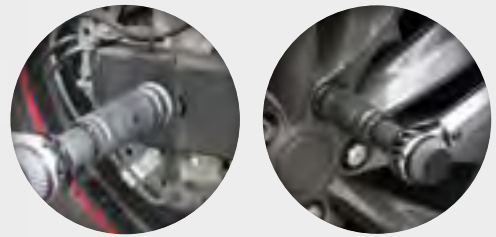

**21,- €**

**BT691004...009**  
**EAN 4042146844243**  
1/2" impact socket for aluminium rims

1/2"  
12,5 mm



BT No.	⊙	← L → mm	EAN 4042146+	€
BT691004	15 mm	83	844670	6,00
BT691006	17 mm	83	844236	6,00
BT691007	19 mm	83	844243	6,00
BT691008	21 mm	83	844250	7,00
BT691009	22 mm	83	844687	8,00

**start from 6,- €**

## IMPACT SOCKET

**BT691005**  
**EAN 4042146844229**  
1/2" impact socket set for  
aluminium rims 17 / 19 / 21 mm



**3**  
pcs.

**1/2"**  
12,5 mm



17 mm



19 mm



21 mm

**15,- €**

**BT691010**  
**EAN 4042146844663**  
1/2" impact socket set for  
aluminium rims 15 / 17 / 19 /  
21 / 22 mm



**5**  
pcs.

**1/2"**  
12,5 mm



15 mm



17 mm



19 mm



21 mm



22 mm

**25,- €**





1/2"  
12,5 mm

**11**  
pcs.

1/2"  
12,5 mm



**BT022645**  
**EAN 4042146870174**  
1/2" impact hexagon socket set,  
short



8x



10 • 13 • 14 • 17 • 19 • 21  
• 22 • 24 • 27 mm

1x



10 • 13 • 14 • 17 • 19 • 21  
• 22 • 24 • 27 mm

1x



125 mm

**45,- €**

1/2"  
12,5 mm

**BT022669**  
**EAN 4042146869796**  
1/2" impact extension, 125 mm



**10,- €**

## IMPACT SOCKET

1/2"  
12,5 mm



**BT022682**  
EAN 4042146869604  
1/2" impact 12-point  
socket 32 mm, short



**11,- €**

1/2"  
12,5 mm



**BT022683**  
EAN 4042146869611  
1/2" impact 12-point  
socket 36 mm, short

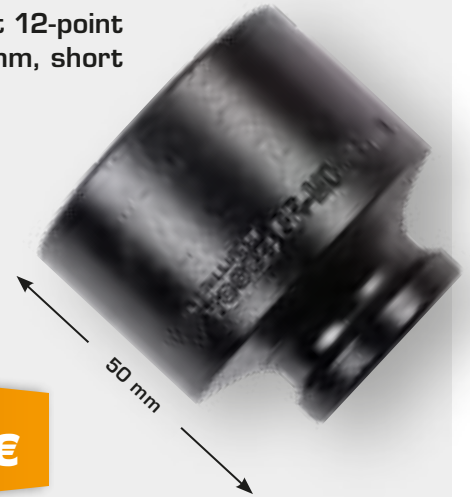

**12,- €**

**6**

pcs.

**BT024605**  
EAN 4042146870921  
Impact adapter set, 1/4" + 3/8" + 1/2" + 3/4"

- 1/4" x 3/8" ✓
- 3/8" x 1/4" ✓
- 3/8" x 1/2" ✓
- 1/2" x 3/8" ✓
- 1/2" x 3/4" ✓
- 3/4" x 1/2" ✓



**19,- €**

1x		1/4" X 3/8"	1x		3/8" X 1/2"	1x		1/2" X 3/4"
1x		3/8" X 1/4"	1x		1/2" X 3/8"	1x		3/4" X 1/2"



1/2"  
12,5 mm

**3**  
pcs.

**BT024603**  
**EAN 4042146870136**  
1/4" + 3/8" + 1/2" impact ball joint set



1/4"  
6,3 mm  
3/8"  
10 mm  
1/2"  
12,5 mm



3x



1/4"  
• 3/8"  
• 1/2"

**35,- €**

1/4"  
6,3 mm

**BT024601**  
**EAN 4042146870143**  
1/4" impact ball joint



**9,- €**

3/8"  
10 mm

**BT024602**  
**EAN 4042146870150**  
3/8" impact ball joint



**12,- €**

1/2"  
12,5 mm

**BT024604**  
**EAN 4042146870167**  
1/2" impact ball joint



**16,- €**

# IMPACT SOCKET

3/4"  
19 mm

8  
pcs.

3/4"  
19 mm

**BT025600**  
**EAN 4042146870181**  
3/4" impact bit hexagon socket  
set, long, 24 – 36 mm



**119,- €**

8x



24 • 27 • 29  
• 30 • 32  
• 33 • 34  
• 36 mm

3/4"  
19 mm



**BT025606...614**  
3/4" impact hexagon  
socket, 24 mm, long



start from **15,- €**

BT No.	Ø	← L → mm	EAN 4042146+	€
BT025606	24 mm	90	870198	15,00
BT025607	27 mm	90	870204	15,00
BT025608	29 mm	90	870211	15,00
BT025609	30 mm	90	870228	16,00
BT025611	32 mm	90	870235	16,00
BT025612	33 mm	90	870242	16,00
BT025613	34 mm	90	870259	16,00
BT025614	36 mm	90	870266	16,00



3/4"  
19 mm

3/4"  
19 mm



**BT025601...604**  
3/4" impact 12-point  
socket, short

start from **16,- €**

BT No.	○	< L > mm	EAN 4042146+	€
BT025601	24 mm	45	870273	16,00
BT025602	30 mm	50	870280	18,00
BT025603	32 mm	50	870297	18,00
BT025604	36 mm	50	870303	20,00

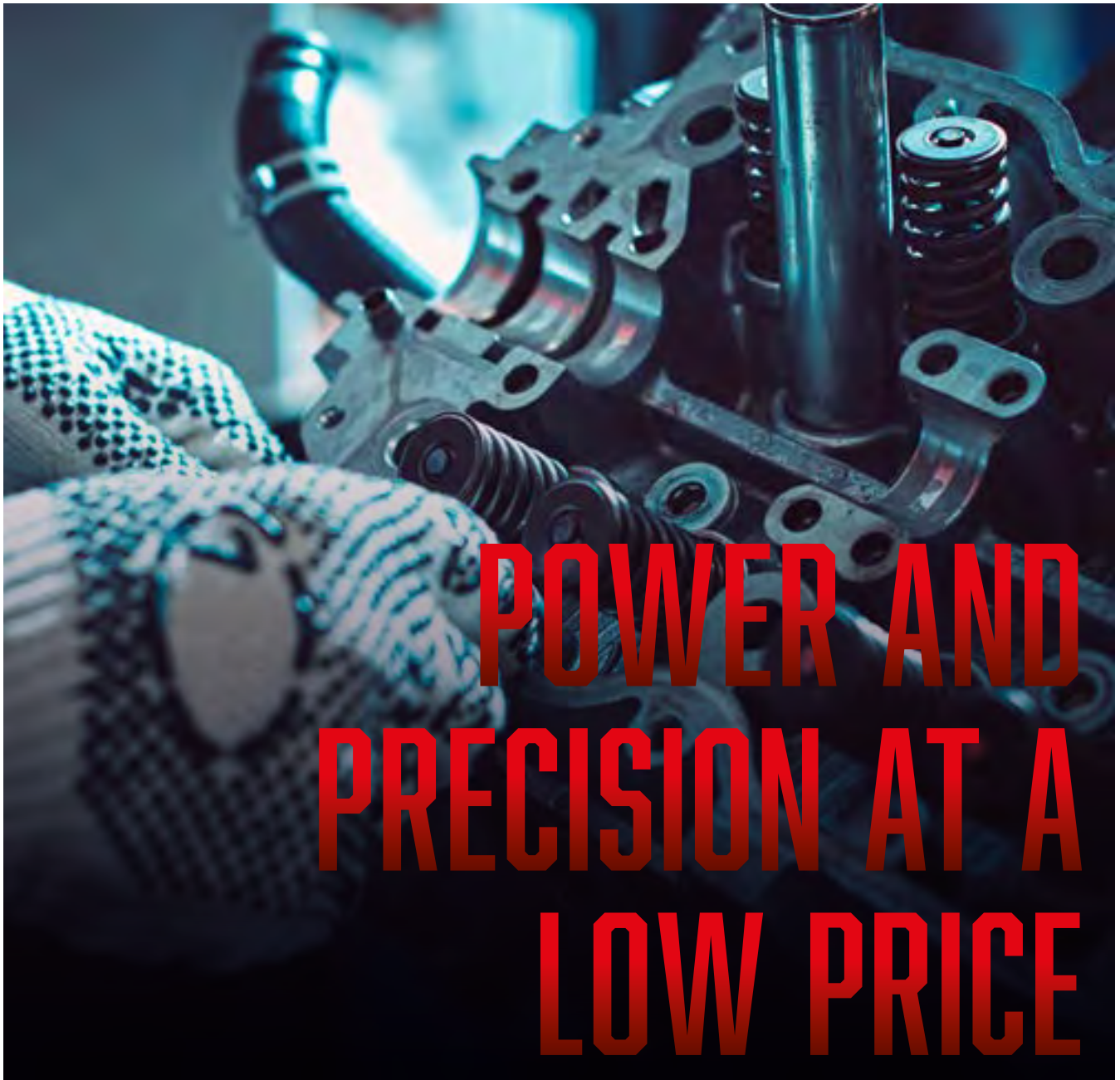

**POWER AND  
PRECISION AT A  
LOW PRICE**

# SCREWDRIVERS

6  
pcs.

**BT031000**  
**EAN 4042146855973**  
 Screwdriver set, slot +  
 PH Phillips



- 2x
  - PH1 x 80 mm
  - PH2 x 100 mm
- 4x
  - 3 x 80
  - 4 x 100
  - 5,5 x 125
  - 6,5 x 150 mm



**10,- €**

6  
pcs.

**BT031010**  
**EAN 4042146855980**  
 TORX® screwdriver set



- 6x
- T10 x 80
- T15 x 80
- T20 x 100
- T25 x 100
- T27 x 115
- T30 x 115 mm



**12,- €**



**5**  
pcs.



**BT031020**  
**EAN 4042146855997**

Screwdriver set with hammer cap,  
slot + PH Phillips



**15,- €**

# SCREWDRIVERS

**BT031031**  
**EAN 4042146858707**  
 Screwdriver slot, short form

5,5 x 38 mm

**3,- €**

**BT031032**  
**EAN 4042146858714**  
 Screwdriver cross, PH Phillips, short form

PH2 x 38 mm

**3,- €**

**BT031001...054**  
 Screwdriver slot

start from **3,- €**

BT No.	⊖	← L → mm	EAN 4042146+	€
BT031052	2	63	859353	3,00
BT031001	3	80	856017	3,00
BT031048	3	100	859322	3,00
BT031002	4	100	856024	3,00
BT031003	4,5	100	856031	3,00
BT031004	5,5	125	856048	3,00
BT031005	6,5	150	856055	4,00
BT031053	8	150	859421	4,00
BT031054	10	175	859438	5,00

**BT031006...046**  
 Screwdriver PH Phillips

start from **3,- €**

BT No.	⊕	← L → mm	EAN 4042146+	€
BT031035	PH0	75	858721	3,00
BT031046	PH0	100	859308	3,00
BT031006	PH1	80	856062	3,00
BT031007	PH2	100	856079	3,00
BT031036	PH3	150	858738	4,00



**BT031011...045**  
Screwdriver TORX<sup>®</sup>

T6 - T40



start from **3,- €**

BT No.	★	← L → mm	EAN 4042146+	€
BT031037	T6	100	858745	3,00
BT031038	T7	100	858752	3,00
BT031039	T8	100	858769	3,00
BT031041	T9	80	858776	3,00
BT031011	T10	100	856086	3,00
BT031043	T10	80	859278	4,00
BT031012	T15	80	856093	4,00
BT031044	T15	100	859285	4,00
BT031013	T20	100	856109	4,00
BT031014	T25	100	856116	4,00
BT031015	T27	100	856123	4,00
BT031016	T30	100	856130	4,00
BT031042	T40	100	858783	4,00
BT031045	T40	150	859292	5,00



**BT031021...051**  
Screwdriver slot with  
hammer cap



start from **4,- €**

BT No.	⊖	← L → mm	EAN 4042146+	€
BT031049	5 mm	75	859339	4,00
BT031021	5,5 mm	125	856147	3,00
BT031051	6 mm	100	859346	4,00
BT031022	8 mm	150	856154	3,00



**BT031023...047**  
Screwdriver PH Phillips with hammer cap



start from **3,- €**

BT No.	⊕	← L → mm	EAN 4042146+	€
BT031023	PH1	80	856161	3,00
BT031024	PH2	100	856178	3,00
BT031047	PH3	150	859315	6,00

# SCREWDRIVERS

**1/4"**

**BT031055**  
**EAN 4042146858790**  
 1/4" Bit-screwdriver

**4,- €**

100 mm

**1/4"**

**BT031056**  
**EAN 4042146862490**  
 1/4" Square drive screwdriver

**3,- €**

60 mm

**9**  
 pcs.

**BT511005**  
**EAN 4042146778791**  
 Extra long TX screwdriver set

405 mm

**T15**  
**T20**  
**T25**  
**T27**  
**T30**

**T30**

**T27**

**T25**

**T20**

**T15**

**29,- €**







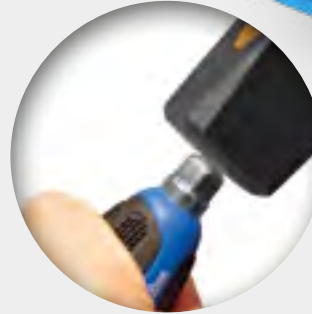
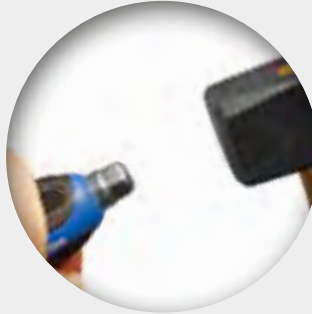
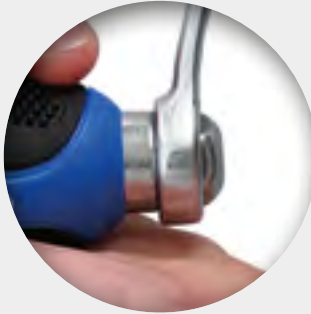

**BT034012**  
**EAN 4042146844267**  
Screwdriver set with  
hammer cap, slot +  
PH Phillips

**12**  
pcs.

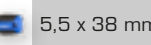

**25,- €**

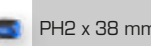
<b>5x</b> 		3,2 x 75 mm • 5,0 x 75 mm • 6,0 x 100 mm • 8,0 x 150 mm • 9,5 x 200 mm	<b>1x</b> 		5,5 x 38 mm
<b>5x</b> 		PH0 x 75 mm • PH1 x 75 mm • PH2 x 100 mm • PH3 x 150 mm • PH4 x 200 mm	<b>1x</b> 		PH2 x 38 mm

# SCREWDRIVERS

7  
pcs.

M5 - M12

**BT031070**  
**EAN 4042146870310**  
 Socket screwdriver set



7x  M5 • M6 • M8  
 • M9 • M10  
 • M11 • M12



**34,- €**

**BT031071...078**  
 Socket screwdriver



start from **5,- €**

BT No.	⊙	← L → mm	EAN 4042146+	€
BT031071	M5	165	870327	5,00
BT031072	M6	165	870334	5,00
BT031073	M8	165	870341	6,00
BT031074	M9	165	870358	6,00
BT031076	M10	165	870365	6,00
BT031077	M11	165	870372	6,00
BT031078	M12	165	870389	7,00



**BT031066...68**

Socket screwdriver with flexible blade

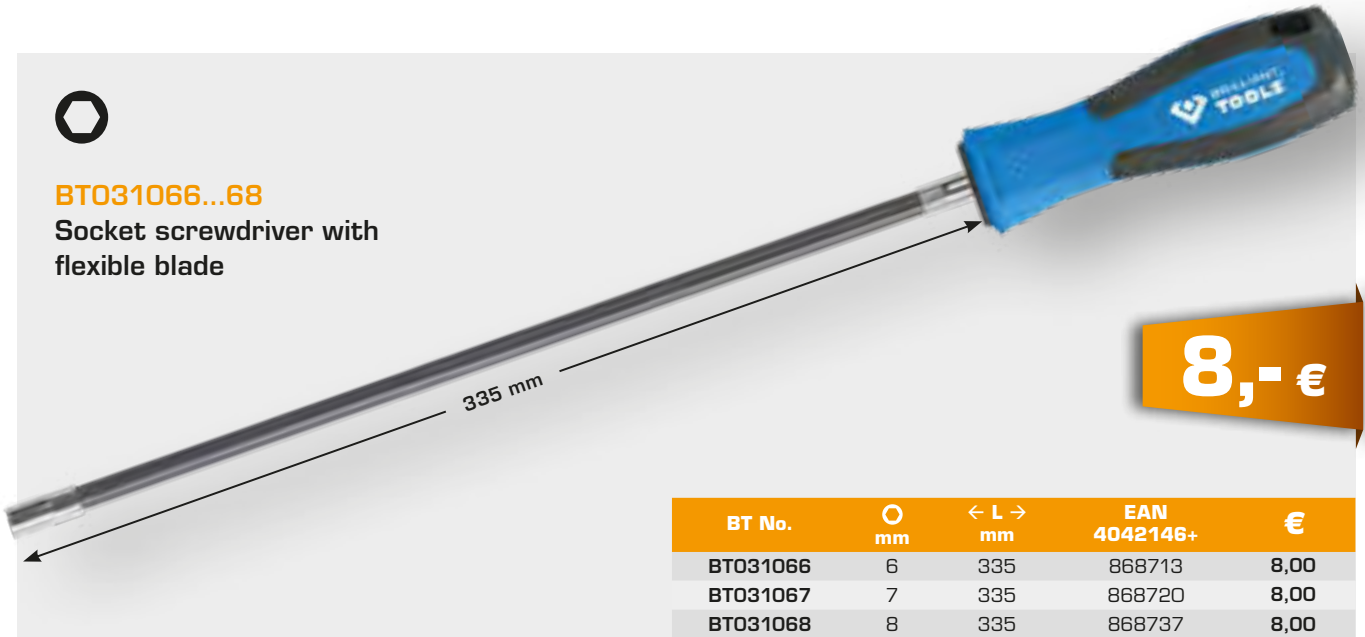

**8,- €**

BT No.	Ø mm	← L → mm	EAN 4042146+	€
BT031066	6	335	868713	8,00
BT031067	7	335	868720	8,00
BT031068	8	335	868737	8,00

# WITH THIS YOU MAKE A LOT OF PRESSURE!



**1.450 Nm**

**59,- €**

**BT160100**  
EAN 4042146844403  
1/2" Pneumatic impact wrench 1.450 Nm

## ANGLED KEY WRENCH

**BT045009**  
**EAN 4042146778067**

Ball end hexagon key wrench set,  
 short

**9**  
 pcs.



← max. 180 mm →

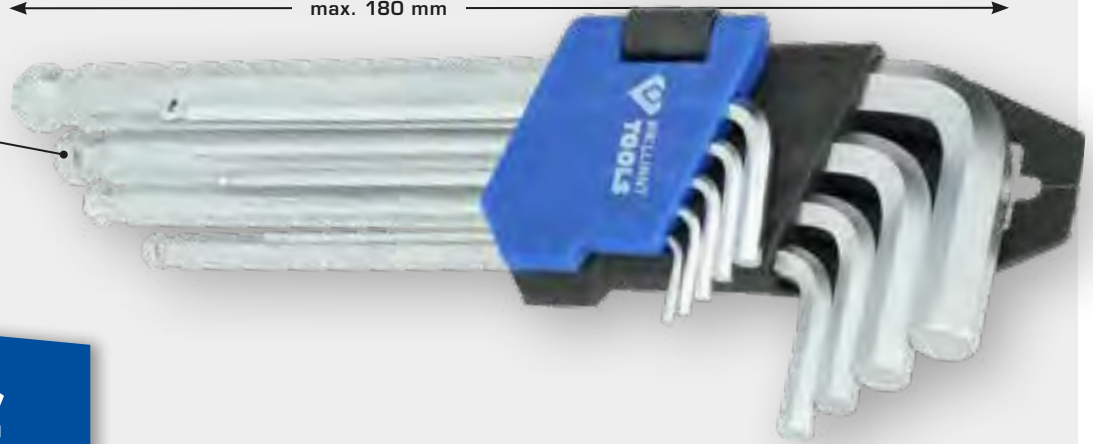

**7,- €**

9x



1,5 • 2 • 2,5 • 3 • 4  
 • 5 • 6 • 8 • 10 mm

**BT044009**  
**EAN 4042146778074**

TORX® tamper-proof key wrench  
 set, short

**9**  
 pcs.



← max. 180 mm →

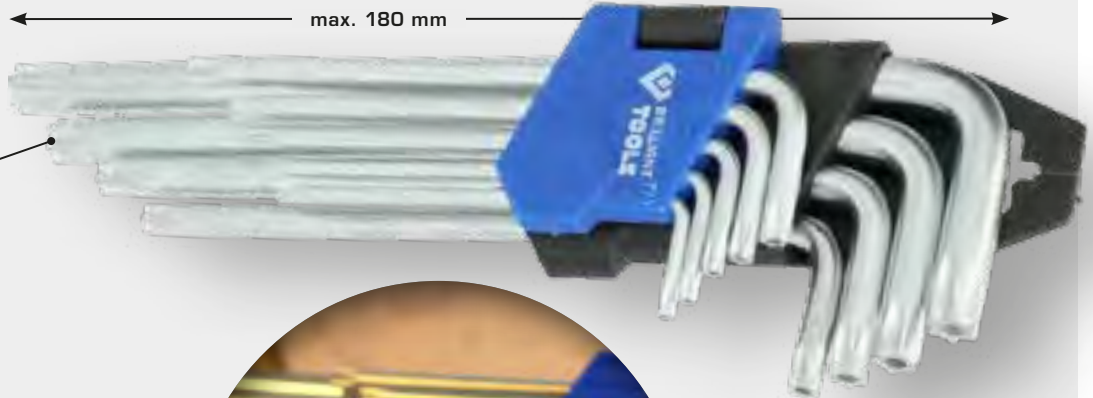

**7,- €**

9x



T10 • T15 • T20  
 • T25 • T27 • T30  
 • T40 • T45 • T50



**BT045019**  
**EAN 4042146782019**  
Ball end hexagon key wrench set,  
long

**9**  
pcs.



← max. 225 mm →

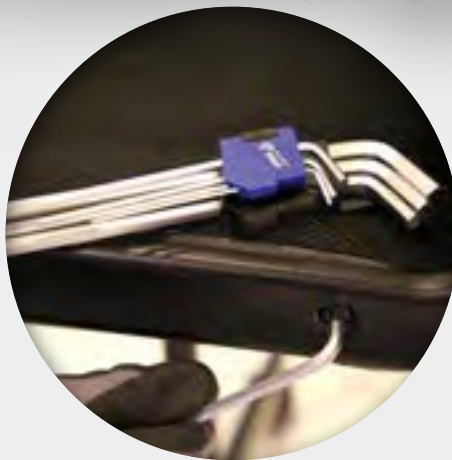
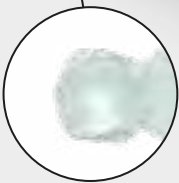

**9,- €**

9x



1,5 • 2 • 2,5 • 3 • 4  
• 5 • 6 • 8 • 10 mm

**BT044019**  
**EAN 4042146782026**  
TORX<sup>®</sup> tamper-proof key wrench  
set, long

**9**  
pcs.



← max. 225 mm →



**10,- €**

9x



T10 • T15 • T20  
• T25 • T27 • T30  
• T40 • T45 • T50

## ANGLED KEY WRENCH

**BT041100**  
**EAN 4042146778067**  
 T-handle ball ended hexagon key  
 wrench set

**9**  
 pcs.

**25,- €**



**BT041001...009**  
 T-handle ball ended hexagon  
 key wrench



**start from 3,- €**

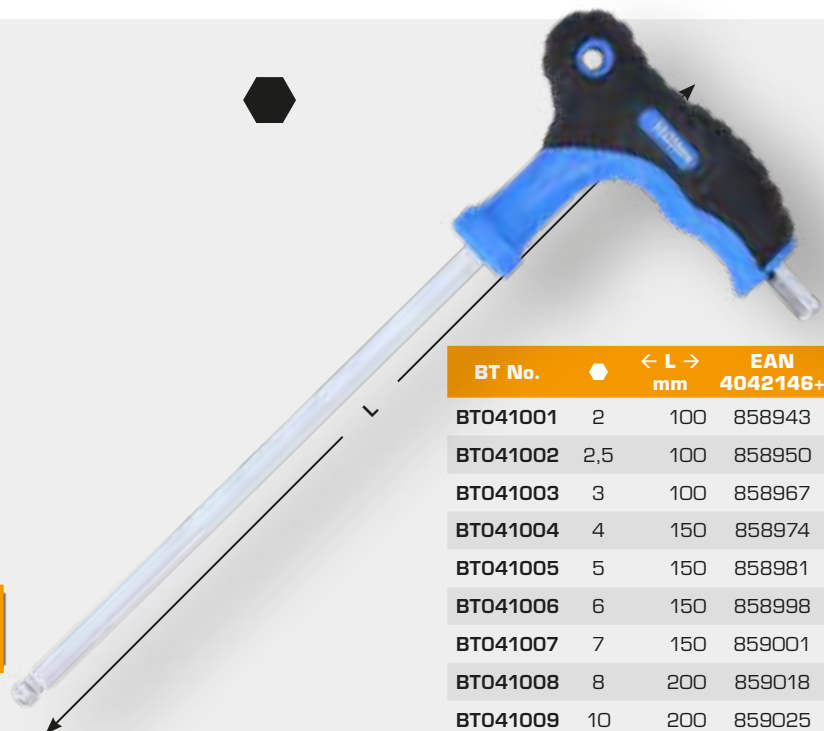

BT No.	⬡	← L → mm	EAN 4042146+	€
BT041001	2	100	858943	3,00
BT041002	2,5	100	858950	3,00
BT041003	3	100	858967	3,00
BT041004	4	150	858974	3,00
BT041005	5	150	858981	4,00
BT041006	6	150	858998	4,00
BT041007	7	150	859001	4,00
BT041008	8	200	859018	5,00
BT041009	10	200	859025	7,00





**9**  
pcs.



**25,- €**

**BT041200**  
**EAN 4042146868577**  
T-handle TORX® tamper-proof key wrench set



**BT041011...019**  
T-handle TORX®  
tamper-proof key  
wrench

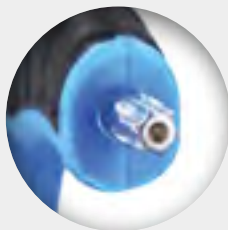

BT No.	☆	← L → mm	EAN 4042146+	€
BT041011	T10	75	859032	3,00
BT041012	T15	100	859049	3,00
BT041013	T25	150	859056	3,00
BT041014	T20	100	859063	3,00
BT041015	T27	150	859070	4,00
BT041016	T30	150	859087	4,00
BT041017	T40	150	859094	4,00
BT041018	T45	200	859100	5,00
BT041019	T50	200	859117	7,00

start from **3,- €**

**BT053001**  
**EAN 4042146870600**  
 Angled bit holder, 105°

**1/4"**  
 6,3 mm



**9,- €**

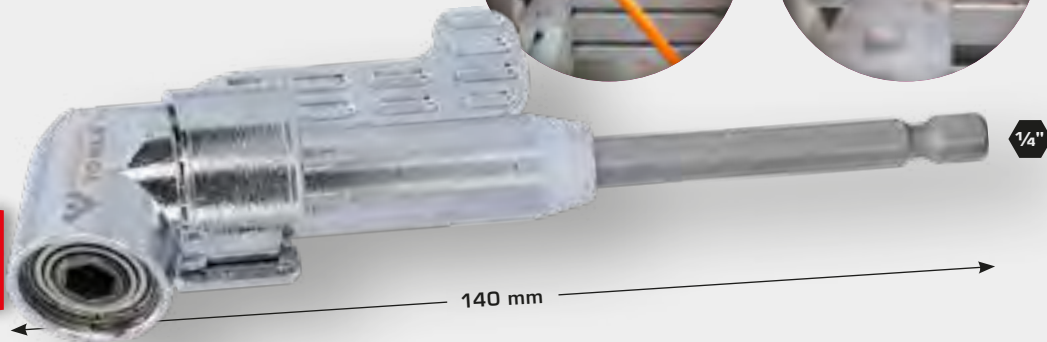

**BT053003**  
**EAN 4042146868461**  
 1/4" square drive-adaptor-set  
 1/4" + 3/8" + 1/2", 3 pcs

**3**  
 pcs.

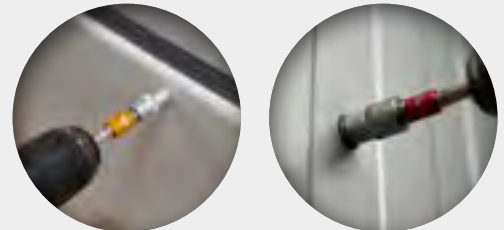

**1/4"**  
 6,3 mm  
**3/8"**  
 10 mm  
**1/2"**  
 12,5 mm

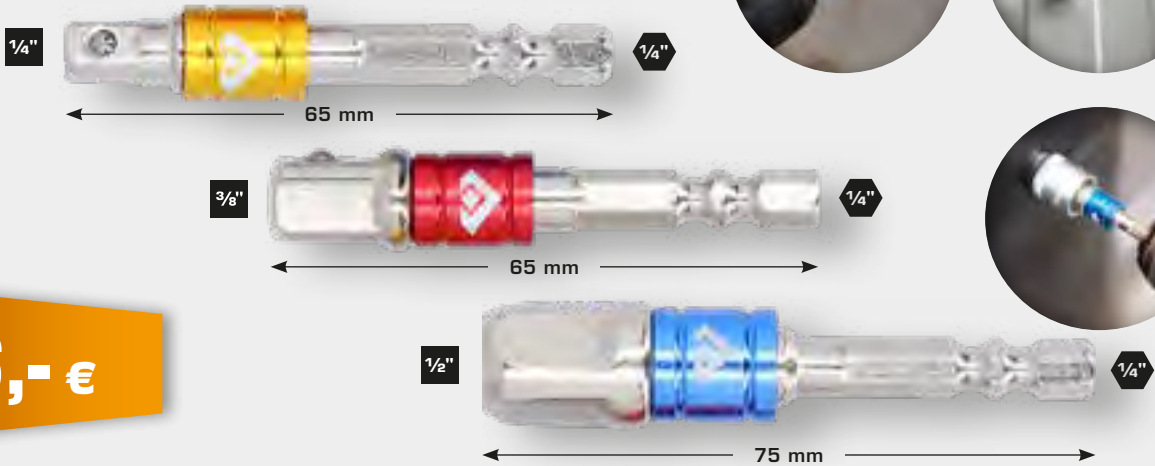

**6,- €**

**BT053901**  
**EAN 4042146870778**  
 Bit reversing ratchet

**1/4"**  
 6,3 mm

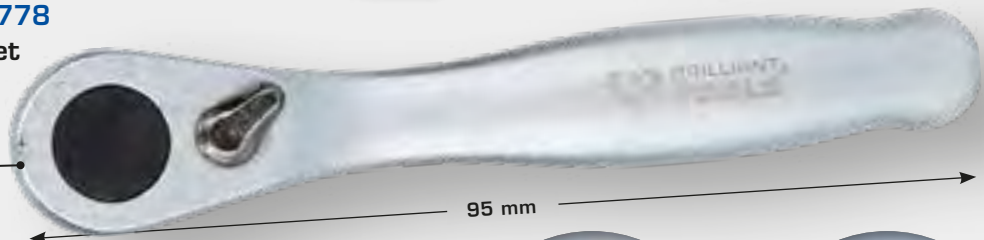

**10,- €**

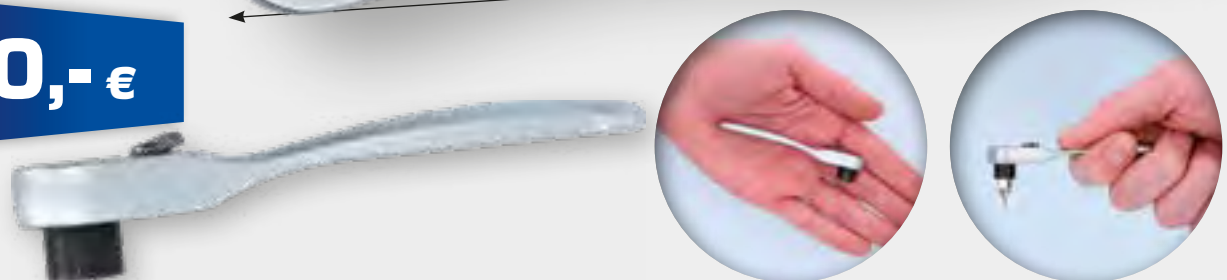

**32**  
pcs.

**BT053532**  
**EAN 4042146870761**

Bit set with bit reversing ratchet, 32 pcs



**1/4"**



**17,50 €**

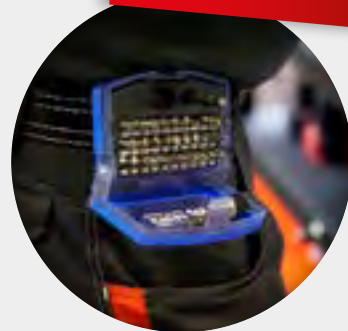
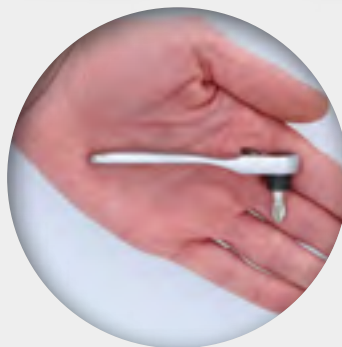

4x		PH1 • PH2 (2x) • PH3	7x		T10 • T15 • T20 • T25 • T27 • T30 • T40
4x		PZ1 • PZ2 (2x) • PZ3	1x		TH10 • TH15 • TH20 • TH25 • TH27 • TH30 • TH40
4x		4 x 0,8 • 5 x 1 • 6,5 x 1,2 • 8 x 1,6 mm	1x		60 mm
7x		3 • 4 • 5 • 6 mm	1x		95 mm

**BT053032**  
**EAN 4042146778081**  
 Bit set, 32 pcs

**32**  
 pcs.



**1/4"**  
 6,3 mm



**8,- €**

4x		PH1 • PH2 (2x) • PH3	7x		T10 • T15 • T20 • T25 • T27 • T30 • T40
4x		PZ1 • PZ2 (2x) • PZ3	7x		TH10 • TH15 • TH20 • TH25 • TH27 • TH30 • TH40
4x		4 x 0,8 • 5 x 1 • 6,5 x 1,2 • 8 x 1,6 mm	1x		25 mm
4x		3 • 4 • 5 • 6 mm	1x		60 mm

**100**  
pcs.

**BT053100**  
**EAN 4042146778098**  
Bit set, 100 pcs



**1/4"**



**15,- €**

1x		50 mm
2x		25 • 50 mm
1x		1/4"
1x		1/4"
9x		3 • 4 • 4,5 • 5 • 5,5 • 6 • 6,5 • 7 • 8 mm
8x		PH0 • PH1 • 5 x PH2 • PH3
8x		PZ0 • PZ1 • 5 x PZ2 • PZ3
9x		1,5 • 2 • 2,5 • 3 • 4 • 5 • 5,5 • 6 • 8 mm
10x		1/16" • 5/64" • 3/32" • 7/64" • 1/8" • 9/64" • 5/32" • 3/16" • 7/32" • 1/4"

6x		2 • 2,5 • 3 • 4 • 5 • 6 mm
6x		5/64" • 3/32" • 7/64" • 1/8" • 9/64" • 5/32"
9x		T8 • T10 • T15 • T20 • T25 • T27 • T30 • T40 • T45
9x		TH8 • TH10 • TH15 • TH20 • TH25 • TH27 • TH30 • TH35 • TH40
3x		M5 • M6 • M8
3x		#1 • #2 • #3
4x		#1 • #2 • #3 • #4
4x		4 • 6 • 8 • 10 mm
3x		6 • 8 • 10 mm
4x		#0 • #1 • #2 • #3

**208**  
pcs.

**BT053208**  
**EAN 4042146844441**  
Bit set, 208 pcs

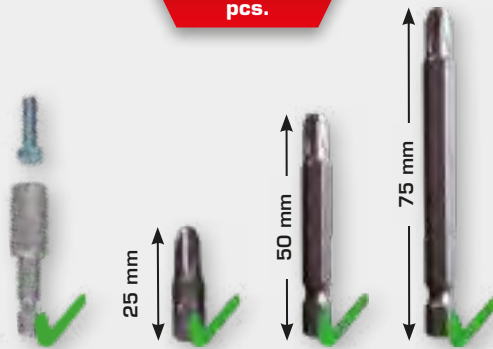

**40,- €**

**1/4"**





# IT LEAVES NOTHING TO BE DESIRED

1x		205 mm	4x		4 • 6 • 8 • 10 mm
1x		60 mm	4x		#0 • #1 • #2 • #3
1x		25 mm	9x		TS10 • TS15 • TS20 • TS25 • TS27 • TS30 • TS40 • TS45 • TS50
12x		2 • 2,5 • 3 • 3,5 • 4 • 4,5 • 5 • 5,5 • 6 • 6,5 • 7 • 8 mm	3x		PH1 • PH2 • PH3
18x		PH00 • PH0 • 5 x PH1 • 5 x PH2 • 5 x PH3 • PH4	3x		PZ1 • PZ2 • PZ3
17x		PZ00 • PZ0 • 5 x PZ1 • 5 x PZ2 • 4 x PZ3 • PZ4	5x		2,5 • 3 • 4 • 5 • 6 mm
12x		1,5 • 2 • 2,5 • 3 • 3,5 • 4 • 4,5 • 5 • 5,5 • 6 • 7 • 8 mm	7x		TB10 • TB15 • TB20 • TB25 • TB27 • TB30 • TB40
10x		1/16" • 5/64" • 3/32" • 7/64" • 1/8" • 9/64" • 5/32" • 3/16" • 7/32" • 1/4"	3x		PH1 • PH2 • PH3
6x		2 • 2,5 • 3 • 4 • 5 • 6 mm	3x		PZ1 • PZ2 • PZ3
6x		5/64" • 3/32" • 7/64" • 1/8" • 9/64" • 5/32"	5x		2,5 • 3 • 4 • 5 • 6 mm
3x		6 • 8 • 10 mm	3x		6 • 8 • 10 mm
13x		T5 • T6 • T7 • T8 • T9 • T10 • T15 • T20 • T25 • T27 • T30 • T40 • T45	7x		TB10 • TB15 • TB20 • TB25 • TB27 • TB30 • TB40
14x		TB5 • TB6 • TB7 • TB8 • TB9 • TB10 • TB15 • TB20 • TB25 • TB27 • TB30 • TB35 • TB40 • TB45	4x		#1 • #2 • #3 • #4
3x		M5 • M6 • M8	4x		4 • 6 • 8 • 10 mm
3x		#1 • #2 • #3	10x		4 • 5 • 6 • 7 • 8 • 9 • 10 • 11 • 12 • 13 mm
4x		#1 • #2 • #3 • #4	10x		5/32" • 3/16" • 7/32" • 1/4" • 9/32" • 5/16" • 11/32" • 3/8" • 7/16" • 1/2"

# PLIERS

5  
pcs.

BT060005  
EAN 4042146864333  
Pliers set

2K



45,- €

1x		160 mm
1x		180 mm
1x		200 mm
1x		200 mm
1x		240 mm





**BT061901**  
**EAN 4042146833056**  
Diagonal side cutter, 180 mm

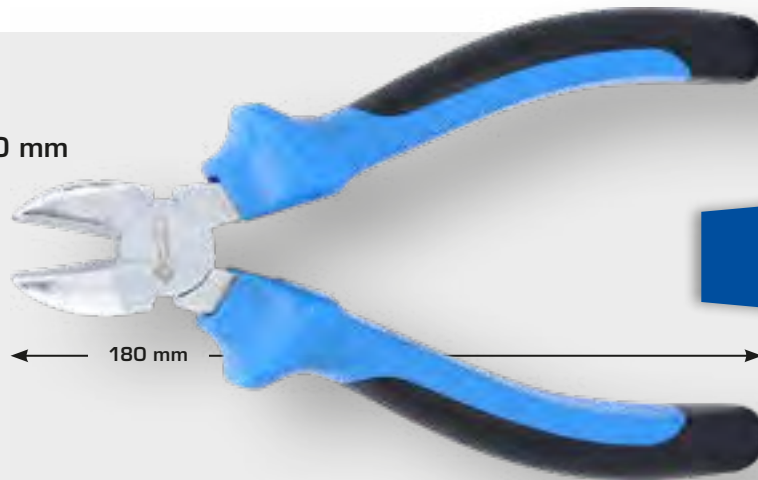

**2K**

**8,- €**

**BT060901**  
**EAN 4042146833049**  
Combination pliers 180 mm



**2K**

**9,- €**

**BT062901**  
**EAN 4042146833063**  
Needle-nose pliers  
200 mm

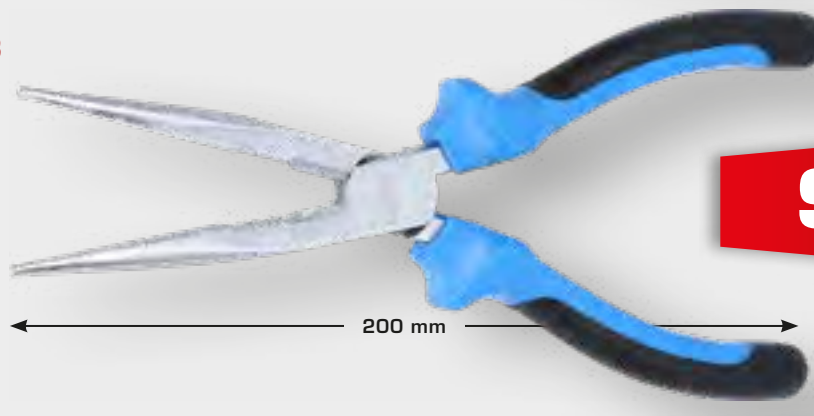
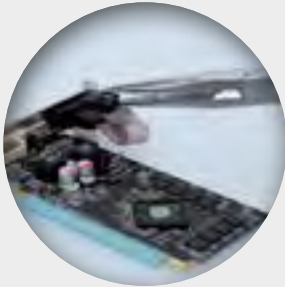

**2K**

**9,- €**

**BT060902**  
**EAN 4042146862803**  
Long nosed pliers, curved, 200 mm

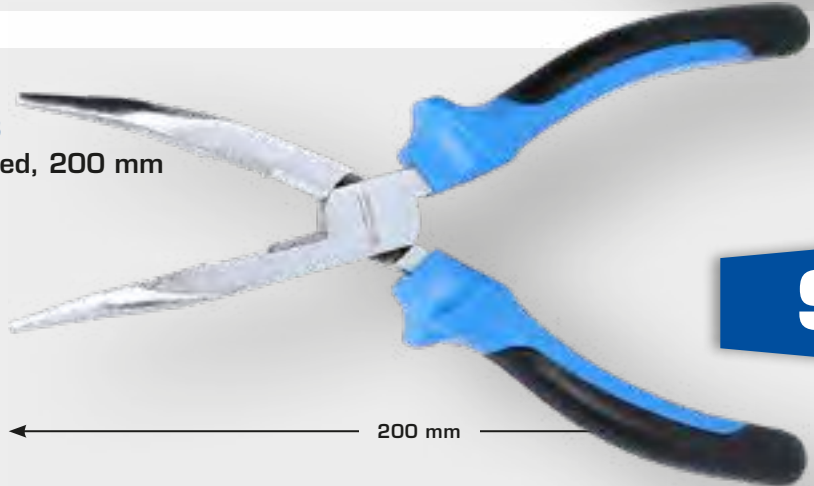
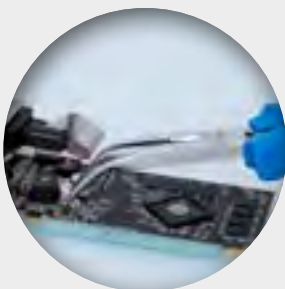

**2K**

**9,- €**

# PLIERS

**BT064902**  
**EAN 4042146864364**  
 Water pump pliers 10", 240 mm

10"

240 mm

2K

11,- €

**BT064906...908**  
 Water pump pliers

start from 7,- €

BT No.	"	< L > mm	EAN 4042146+	€
BT064906	7"	175	867303	7,00
BT064907	10"	250	867327	8,00
BT064908	12"	300	867341	10,00



**BT064910**  
**EAN 4042146867396**  
Water pump pliers set,  
7", 10", 12"

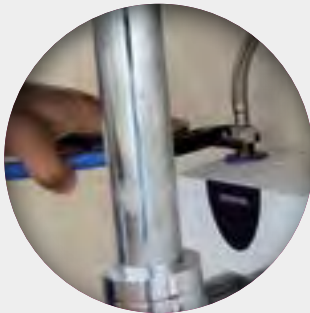
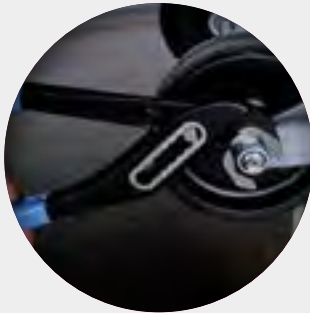

**3**  
pcs.

7", 10", 12"



**22,50 €**

1x		175 mm
1x		250 mm
1x		300 mm

**BT064911...913**  
Water pump pliers



BT No.	"	< L > mm	EAN 4042146+	€
BT064911	7"	175	868034	9,00
BT064912	10"	250	868041	10,00
BT064913	12"	300	868058	12,00

**start from 9,- €**

## PLIERS

**BT064915**  
**EAN 4042146868072**  
 Heavy pincers, 7", 175 mm

7"

7,- €



**BT064914**  
**EAN 4042146868065**  
 Mechanic nippers, 10", 250 mm

10"

8,- €



**BT067110...120**  
 Offset pipe pliers 1", 45° angled

start from 12,- €



BT No.	"	← L → mm	EAN 4042146+	€
BT067112	1/2"	240	870662	12,00
BT067110	1"	320	870679	15,00
BT067115	1,5"	430	870686	20,00
BT067120	2"	656	870693	33,00



**BT064916**  
**EAN 4042146868324**  
**Strap pipe pliers**



**11,- €**

**BT064917**  
**EAN 4042146868348**  
**Chain pipe wrench**

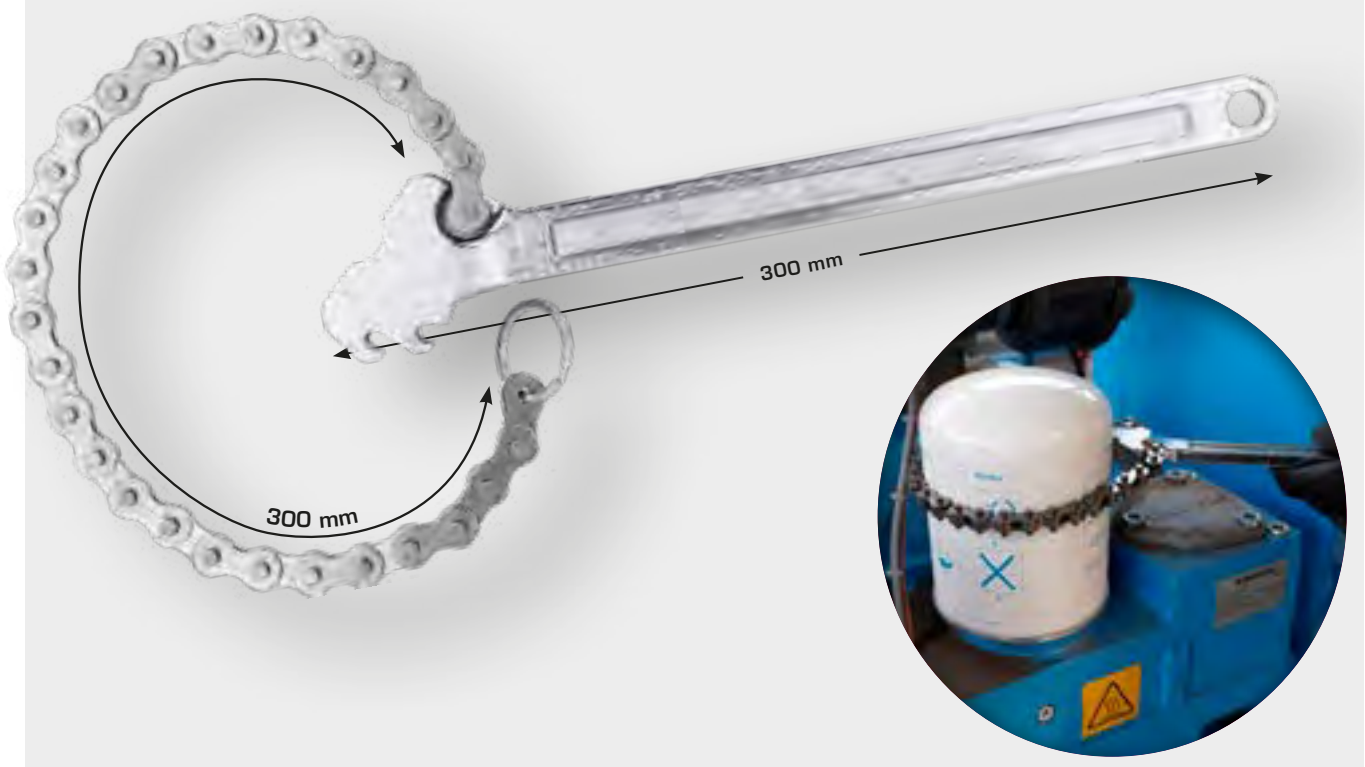

**20,- €**

# PLIERS

**BT065003**  
**EAN 4042146778142**  
Locking pliers set

**3**  
pcs.

140 - 220 mm



**20,- €**

**BT065901**  
**EAN 4042146778159**  
Long nose locking pliers 140 mm

140 mm

**7,- €**



**BT065902**  
**EAN 4042146778166**  
Locking pliers 140 mm

140 mm

**7,- €**



**BT065903**  
**EAN 4042146778173**  
Locking pliers 220 mm

220 mm

**10,- €**



**4**  
pcs.

125 - 250 mm

**BT065004**  
**EAN 4042146867358**  
Locking pliers set



**25,- €**

1x		125 mm	1x		180 mm
1x		150 mm	1x		250 mm

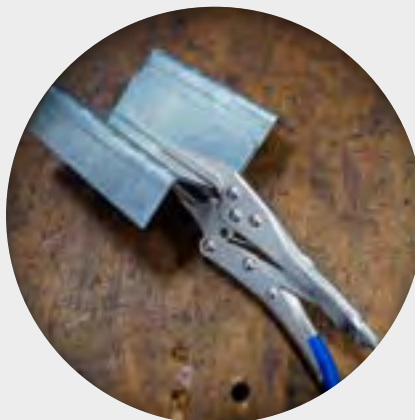

PLIERS

BT065016  
EAN 4042146853528  
Locking pliers set

16  
pcs.

2K

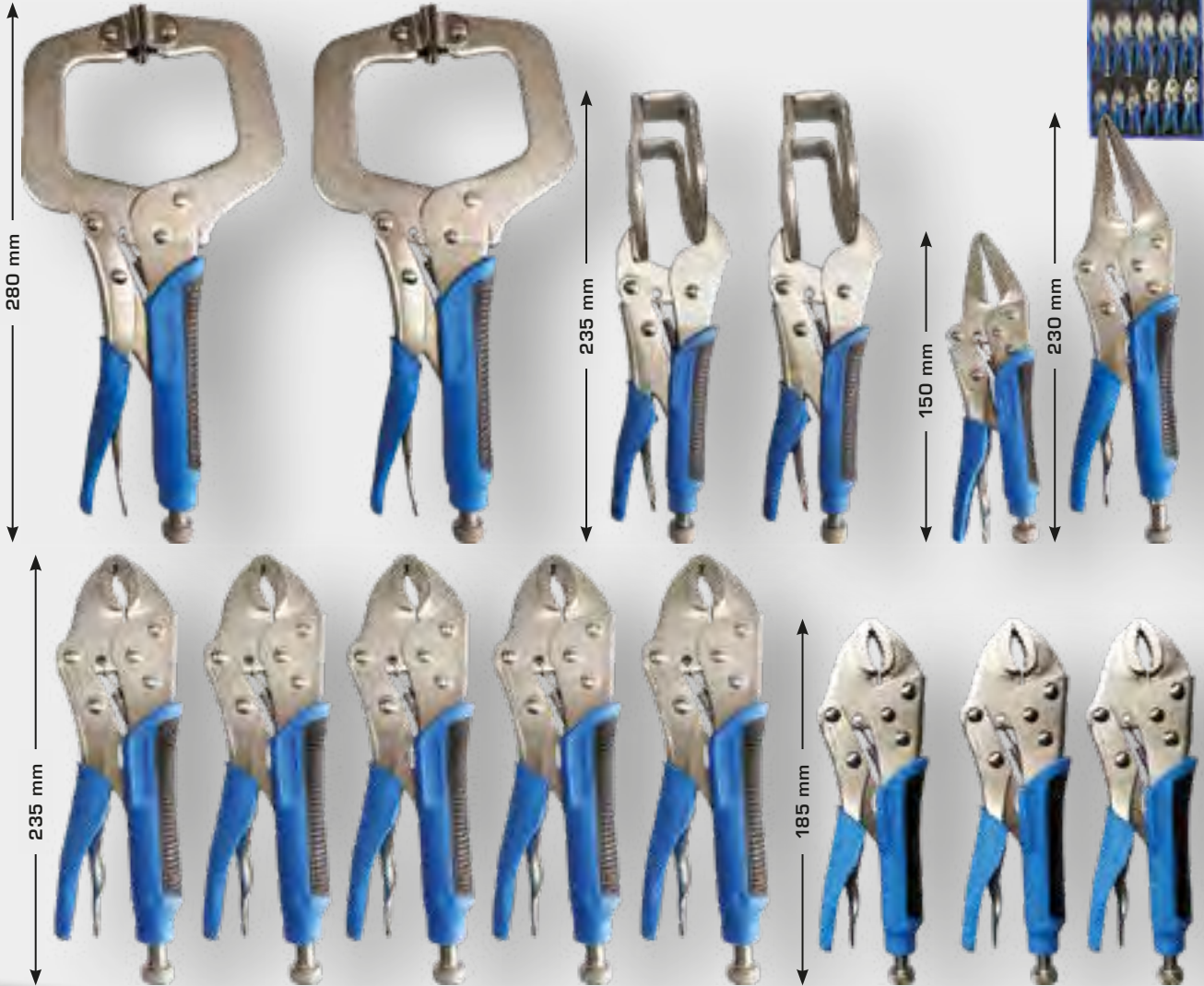

69,- €

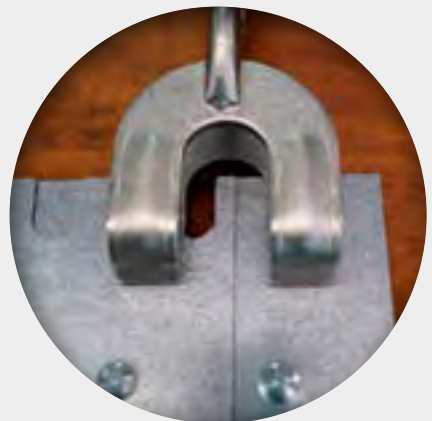
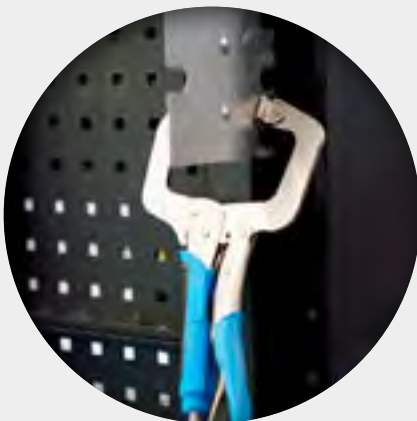





Ø 12 - 25 mm

**4**  
pcs.

For inside and outside circlips

**BT067900**  
**EAN 4042146863060**  
Circlip pliers set, 125 mm



**22,- €**

Ø 19 - 60 mm

**4**  
pcs.

For inside and outside circlips

**BT067000**  
**EAN 4042146863053**  
Circlip pliers set, 175 mm



**26,- €**

## PLIERS

Ø 12 - 25 mm

**BT067005**  
**EAN 4042146861158**

Circlip pliers for external retention rings,  
straight, 125 mm



Ø 12 - 25 mm

**6,- €**

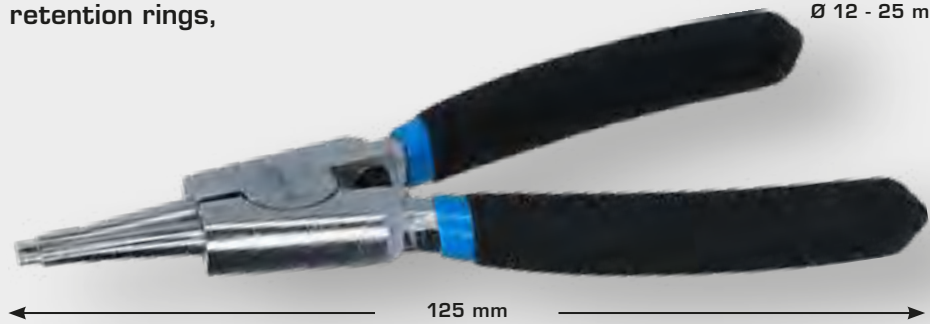

Ø 12 - 25 mm

**BT067006**  
**EAN 4042146861165**

Circlip pliers for external retention rings,  
angled, 125 mm



Ø 12 - 25 mm

**6,- €**



Ø 12 - 25 mm

**BT067007**  
**EAN 4042146861172**

Circlip pliers for internal retention rings,  
straight, 125 mm



Ø 12 - 25 mm

**6,- €**

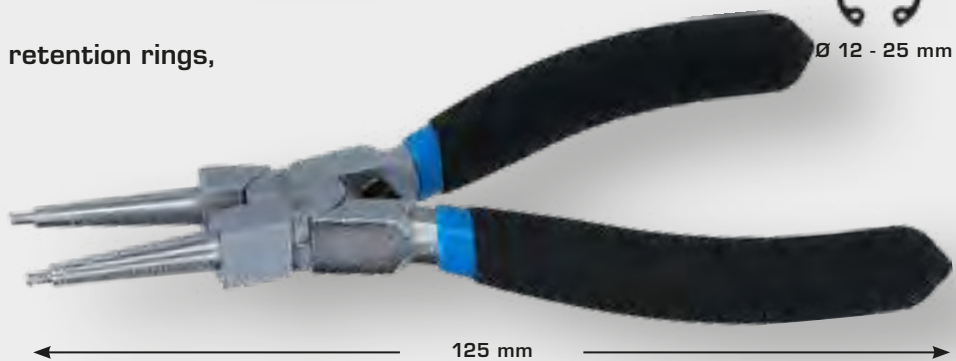

Ø 12 - 25 mm

**BT067008**  
**EAN 4042146861189**

Circlip pliers for internal retention rings,  
angled, 125 mm



Ø 12 - 25 mm

**6,- €**





**BT067001**  
**EAN 4042146858905**  
Circlip pliers for external retention rings,  
straight, 175 mm

Ø 19 - 60 mm

175 mm

7,- €

**BT067002**  
**EAN 4042146858912**  
Circlip pliers for external retention rings,  
angled, 175 mm

Ø 19 - 60 mm

175 mm

7,- €

**BT067003**  
**EAN 4042146858929**  
Circlip pliers for internal retention rings,  
straight, 175 mm

Ø 19 - 60 mm

175 mm

7,- €

**BT067004**  
**EAN 4042146858936**  
Circlip pliers for internal retention rings,  
angled, 175 mm

Ø 19 - 60 mm

175 mm

7,- €

## PLIERS

**BT066901**  
**EAN 4042146868003**

Hand riveting tool for Ø 2,4 - 3,2 - 4,0 - 4,8 mm rivets



**17,50 €**

**BT066900**  
**EAN 4042146778180**

Hand riveting tool for Ø 3,2-4,0-4,8-6,4 mm rivets

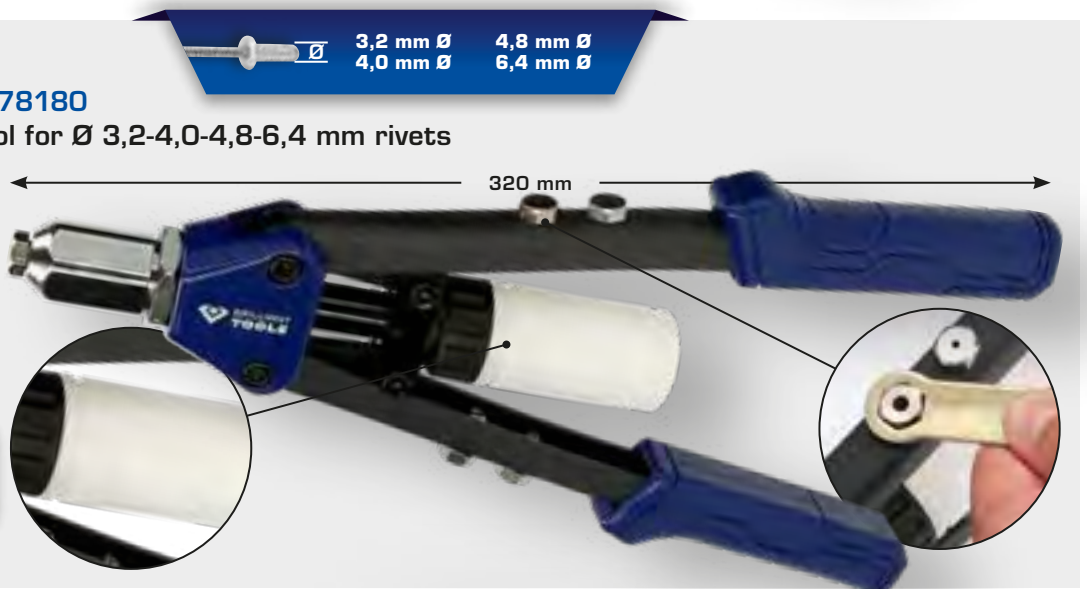

**25,- €**

**BT066950**  
**EAN 4042146813126**

Range of blind rivets Ø 2,4 - 3,2 - 4,0 - 4,8 mm

**400**  
 pcs.

**2,4 - 3,2 - 4 - 4,8 mm**

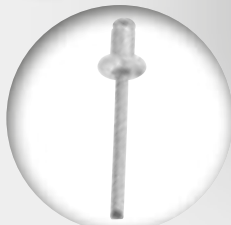

**10,- €**



Ø 2,5 - 3 - 3,5 - 4 - 4,5 mm

**BT066902**  
**EAN 4042146868027**

Revolving punch plier Ø 2,5 - 3,0 - 3,5 - 4,0 -  
4,5 - 5,0 mm

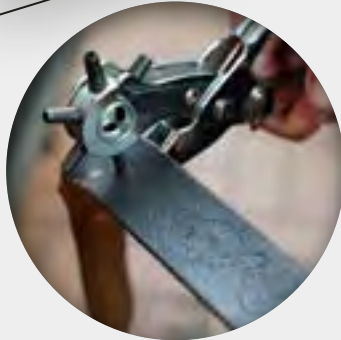

**9,- €**

**BT068018...024**  
**Bolt cutter**



**start from 19,- €**

BT No.	"	< L > mm	EAN 4042146+	€
BT068018	18"	450	868300	19,00
BT068024	24"	600	868317	26,00

**9**  
pcs.

**BT068010**  
**EAN 4042146868959**  
VDE screwdriver set, slot +  
PH Phillips

**17,50 €**

DE GS  
1000 V

⊖ ⊕

✓ ✗

**3 x 75 mm**

**BT068002**  
**EAN 4042146868973**  
VDE screwdriver slot  
3.0 x 75 mm

**5,- €**

DE GS  
1000 V

⊖

✓ ✗

**4 x 100 mm**

**BT068003**  
**EAN 4042146868980**  
VDE screwdriver slot  
4.0 x 100 mm

**5,- €**

DE GS  
1000 V

⊖

✓ ✗



**5,5 x 125 mm**

**BT068004**  
**EAN 4042146868997**  
VDE screwdriver slot  
5.5 x 125 mm

125 mm

1000 V

**6,- €**

**6,5 x 150 mm**

**BT068005**  
**EAN 4042146869000**  
VDE screwdriver slot  
6.5 x 150 mm

150 mm

1000 V

**6,- €**

**PH0 x 75 mm**

**BT068006**  
**EAN 4042146869017**  
VDE screwdriver  
PH Phillips PH0 x 75 mm

75 mm

1000 V

**5,- €**

**PH1 x 80 mm**

**BT068007**  
**EAN 4042146869024**  
VDE screwdriver  
PH Phillips PH1 x 80 mm

80 mm

1000 V

**6,- €**

**BT068008**  
**EAN 4042146869031**  
 VDE screwdriver PH Phillips  
 PH2 x 100 mm

**6,- €**

PH2 x 100 mm

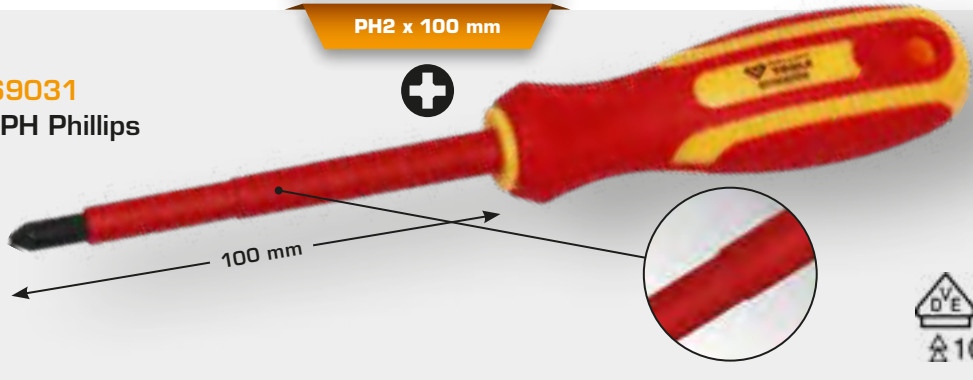

100 mm

VDE GS  
 ⚡ 1000 V

**BT068009**  
**EAN 4042146869048**  
 VDE screwdriver PH Phillips  
 PH3 x 150 mm

**7,- €**

PH3 x 150 mm

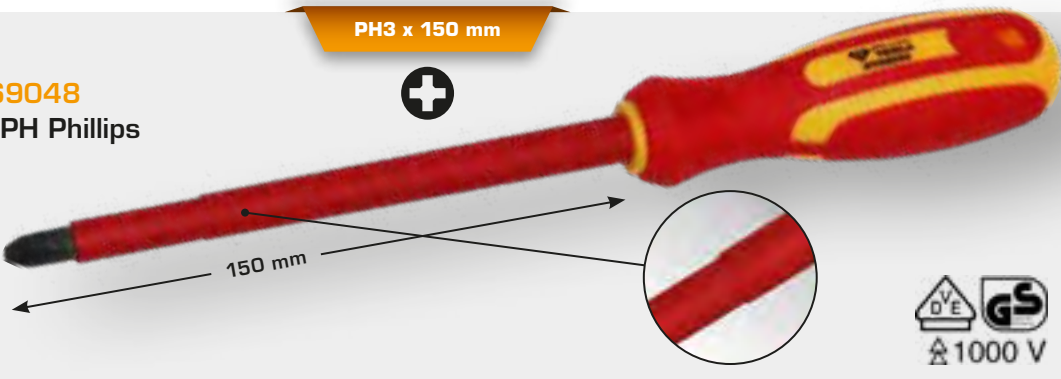

150 mm

VDE GS  
 ⚡ 1000 V

**BT068011**  
**EAN 4042146870525**  
 VDE combination pliers

**15,- €**



185 mm

VDE GS  
 ⚡ 1000 V

**BT068012**  
**EAN 4042146870532**  
 VDE long nosed pliers

**15,- €**



215 mm

VDE GS  
 ⚡ 1000 V



**BT068013**  
**4042146870549**  
VDE diagonal side cutter

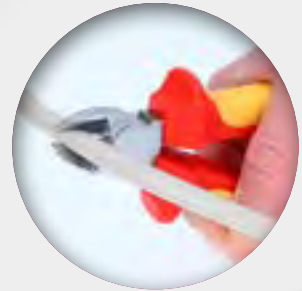
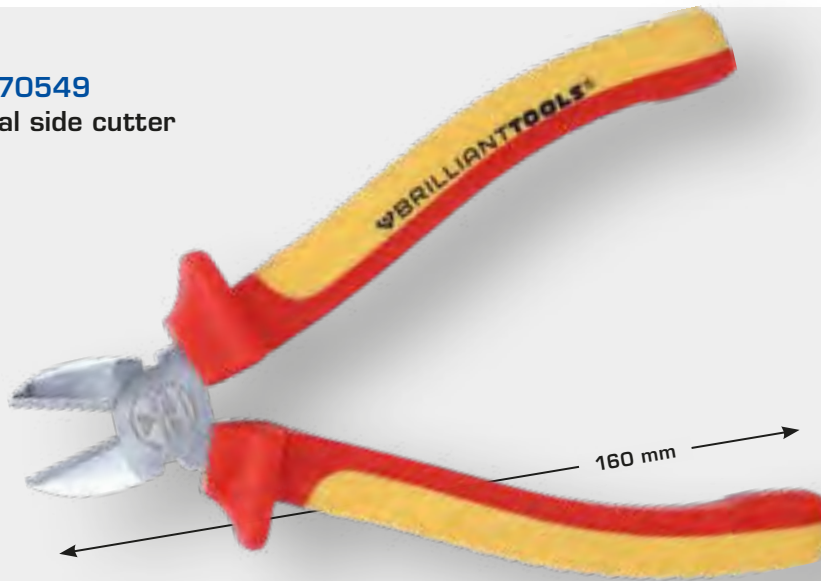

**13,- €**

**BT068014**  
**4042146870556**  
VDE cstarts from le stripper

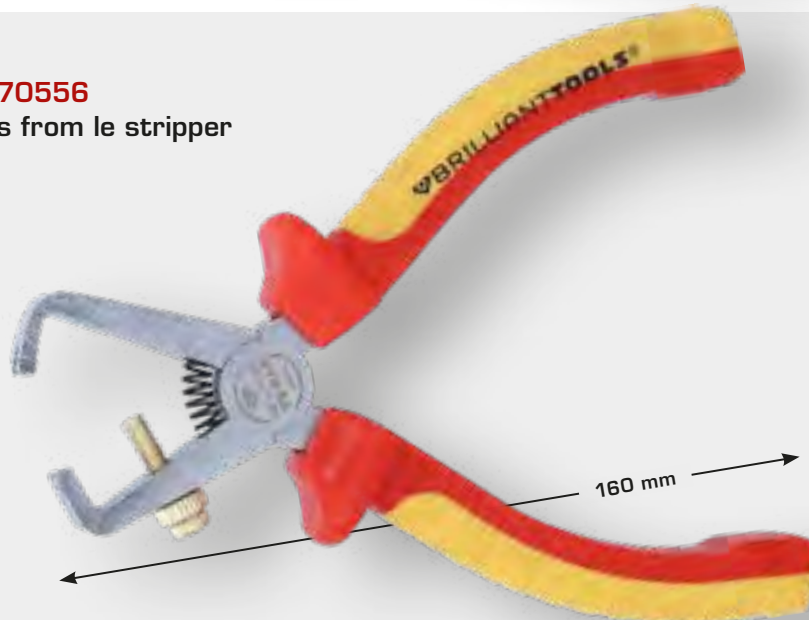

**15,- €**

**BT068015**  
**4042146870563**  
VDE round pliers

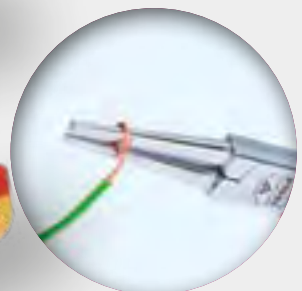

**12,- €**



# POWER TOOLS

**BT068001**  
**EAN 4042146868966**  
Voltage tester 150 - 250 V

120 - 250 V



**3,- €**

**BT120900**  
**EAN 4042146778470**  
Voltage tester 100 - 500 V

100 - 500 V

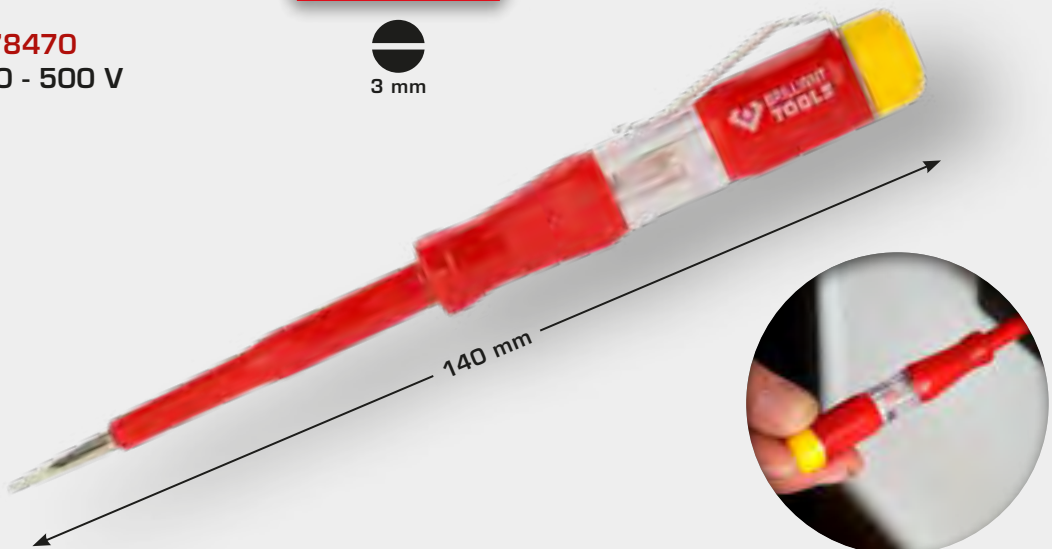

**3,- €**

**BT121900**  
**EAN 4042146778487**  
Test lamp 6 - 24 V

6 - 24 V



**4,- €**



**BT122910**  
**EAN 4042146867402**  
Digital multimeter

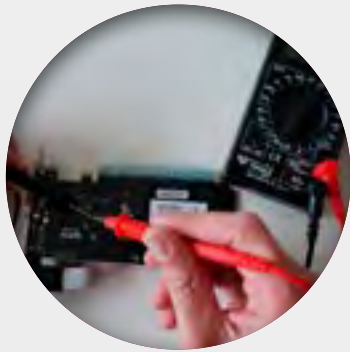
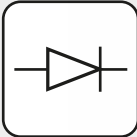

**11,- €**

**Technical data:**

DC voltage	200 mV - 600 V
AC voltage	200 V - 600 V
DC	10 A
Resistance	200 - 2.000 kOhm

**BT122900**  
**EAN 4042146778494**  
Digital multimeter

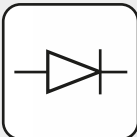

**INCLUSIVE BATTERY** 

**14,- €**

**Technical data:**

DC voltage	200 mV - 600 V
AC voltage	200 V - 600 V
DC	10 A
Resistance	200 - 2.000 kOhm

30 W

**BT124030**  
**EAN 4042146870648**  
 Soldering iron, 30 W

**Technical data:**

Operating temperature	0 - 430 °C
Performance	30 Watt
Voltage range	230 V - 50 Hz
Cable length	1,5 m
Heating time	1,5 min
Diameter of the sprocket	3,8 mm

**12,- €**



60 W

**BT124060**  
**EAN 4042146870655**  
 Soldering iron, 60 W

**12,- €**



**Technical data:**

Operating temperature	0 - 500 °C
Performance	60 Watt
Voltage range	230 V - 50 Hz
Cable length	1,5 m
Heating time	1,5 min
Diameter of the sprocket	5,8 mm

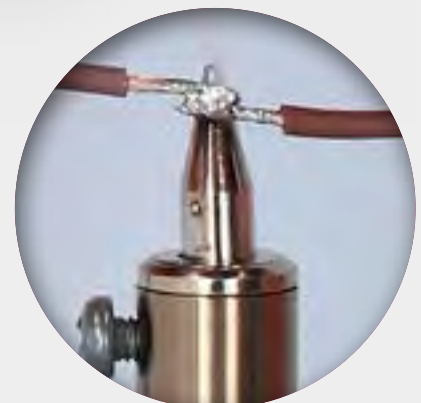



**4**  
pcs.

**BT124009**  
**EAN 4042146778500**  
Gas soldering equipment set

ISO-Butan

49 mm

200 mm

1,6 mm

5 mm

**24,- €**

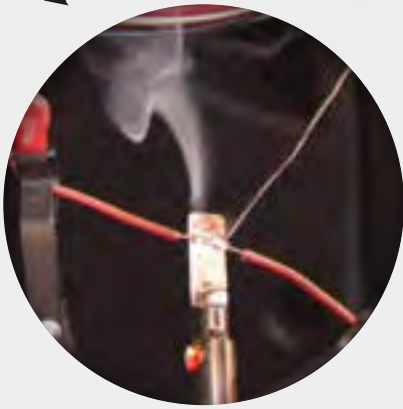

**HOT PARTS  
AT HOT  
PRICES**

**BT067601**  
**EAN 4042146870433**  
Precision combination pliers

**6,- €**



**BT067602**  
**EAN 4042146870440**  
Precision side cutter

**6,- €**

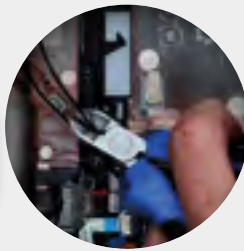

**BT067603**  
**EAN 4042146870457**  
Precision long nosed pliers

**6,- €**

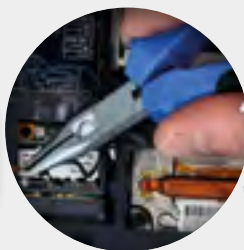

**BT067604**  
**EAN 4042146870464**  
Precision flat pliers

**6,- €**

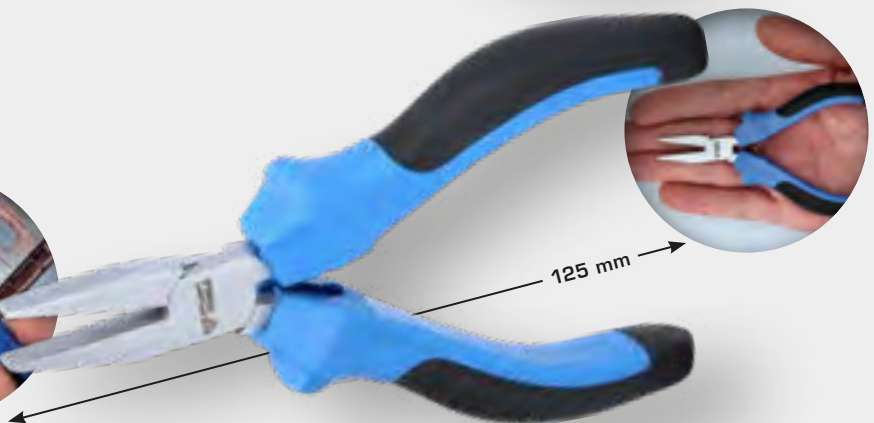
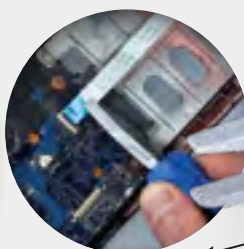



**BT067606**  
**EAN 4042146870471**  
Precision telephone pliers

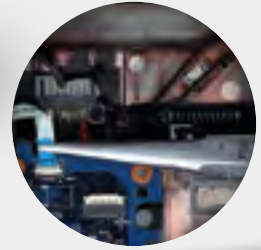
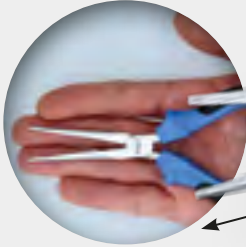

**6,- €**

**BT067607**  
**EAN 4042146870488**  
Precision long nosed pliers, curved

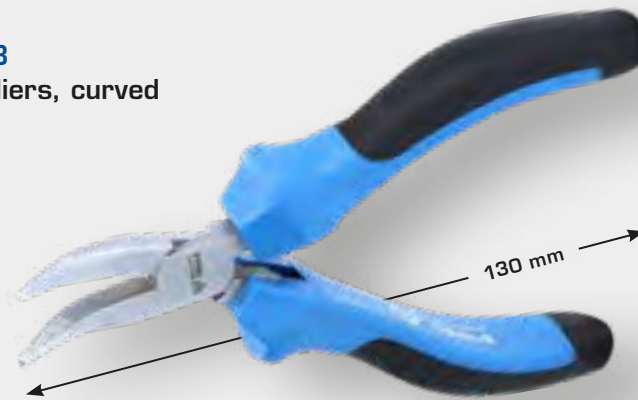
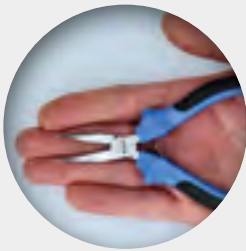

**6,- €**

**BT067609**  
**EAN 4042146870501**  
Precision cutting pliers

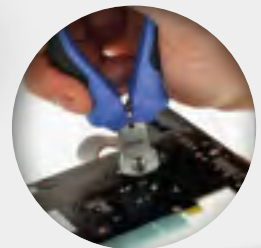
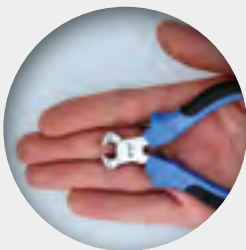

**6,- €**

**BT067608**  
**EAN 4042146870495**  
Precision needle nosed pliers

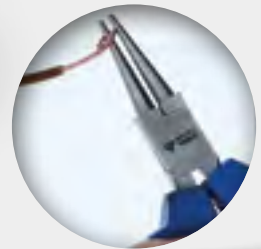
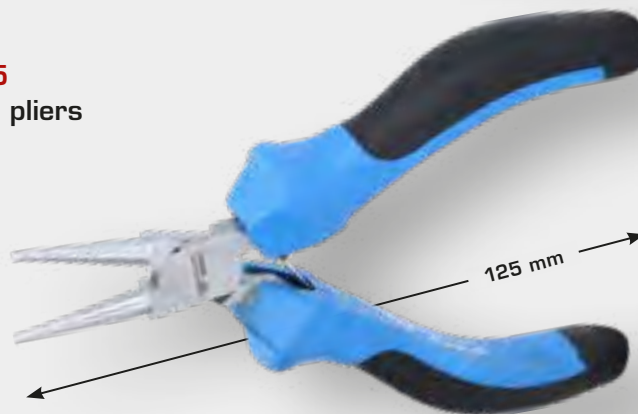
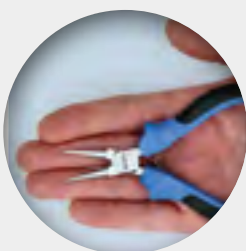

**6,- €**

12  
pcs.

BT542080  
EAN 4042146866702  
Hook and screwdriver set, 12 pcs



15,- €

2 x		2,5 • 3,5 mm
2 x		PH0 • PH00
4 x		TX6 • TX7 • TX8 • TX10
4x		0° • 45° • 90° • 135°

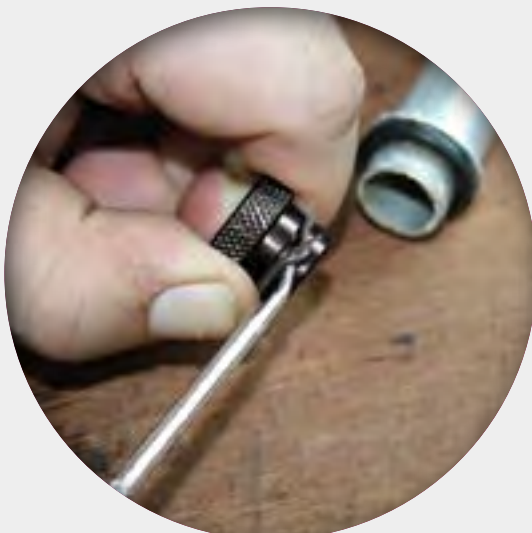





**3**  
pcs.

**BT067905**  
**EAN 4042146871058**  
Tweezers set, 3 pcs



**6,- €**

**BT115905**  
**EAN 4042146863725**  
Telescope mirror and magnetic jack set, 2 pcs

**2**  
pcs.



**13,- €**

2in1

BT115903  
EAN 4042146868379

2in1 Telescopic magnetic lifter with  
washing nozzle cleaning and  
adjustment tool



150 - 675 mm

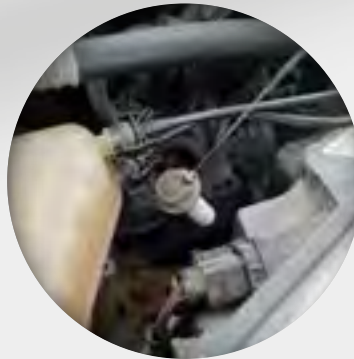

7,- €

BT115900  
EAN 4042146778463  
Telescopic magnet lifter

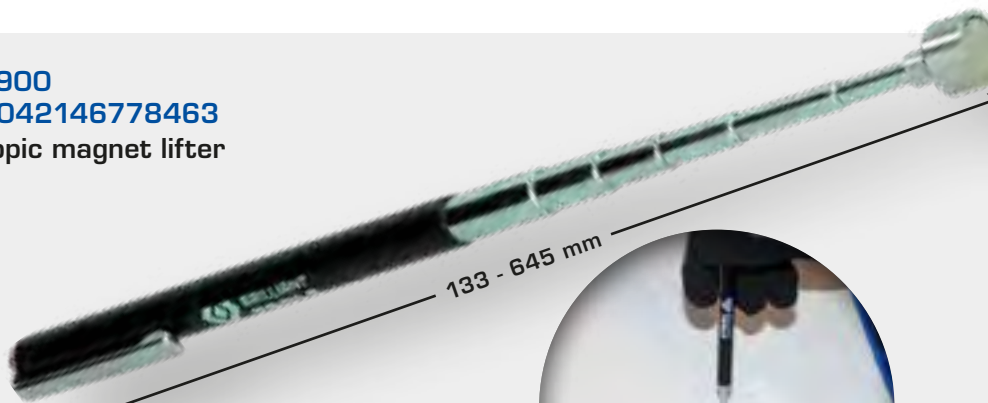

133 - 645 mm

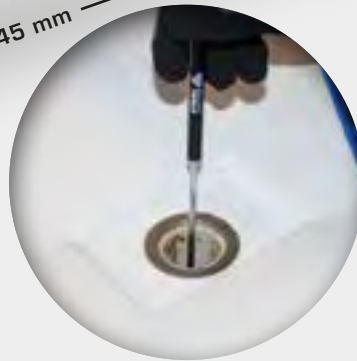

6,- €

BT115906  
EAN 4042146870815  
Magnet lifter with flexible shaft

9,- €

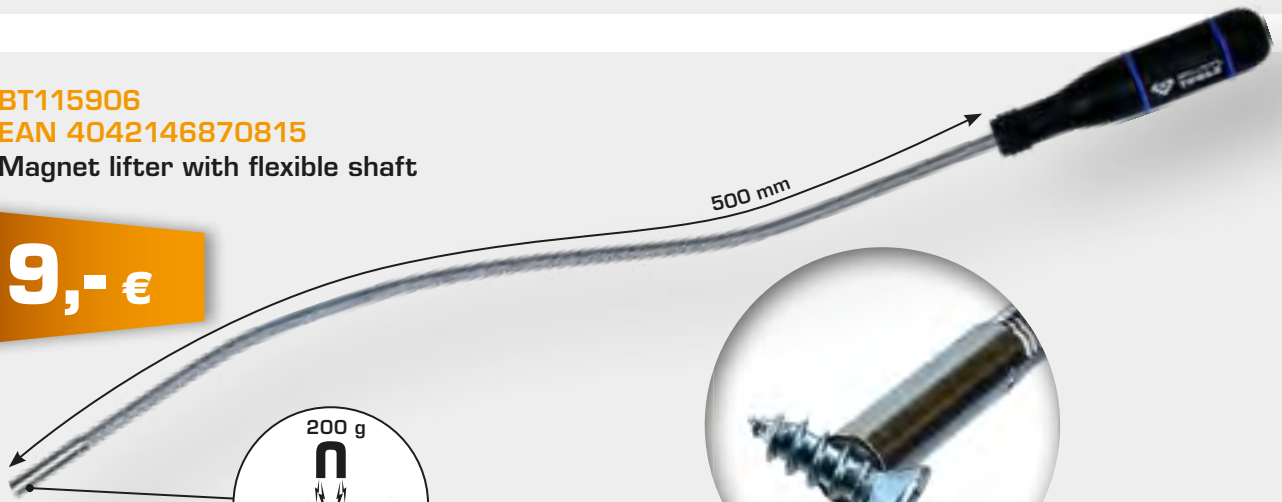

500 mm





**BT115907**  
**EAN 4042146870938**

Claw grip with magnet and LED, adaptable

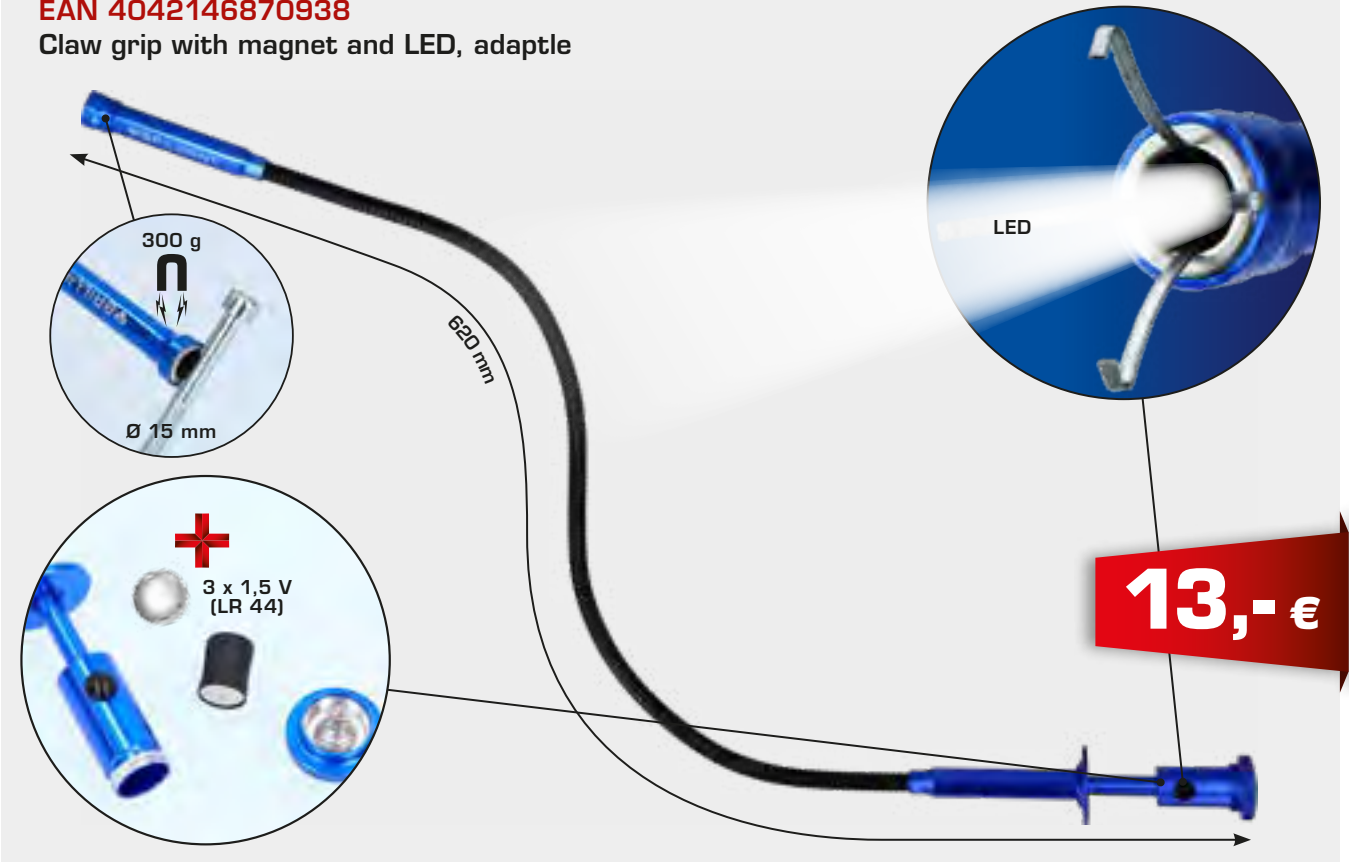

**BT115908**  
**EAN 4042146870945**

Claw grip with magnet and LED, rigid

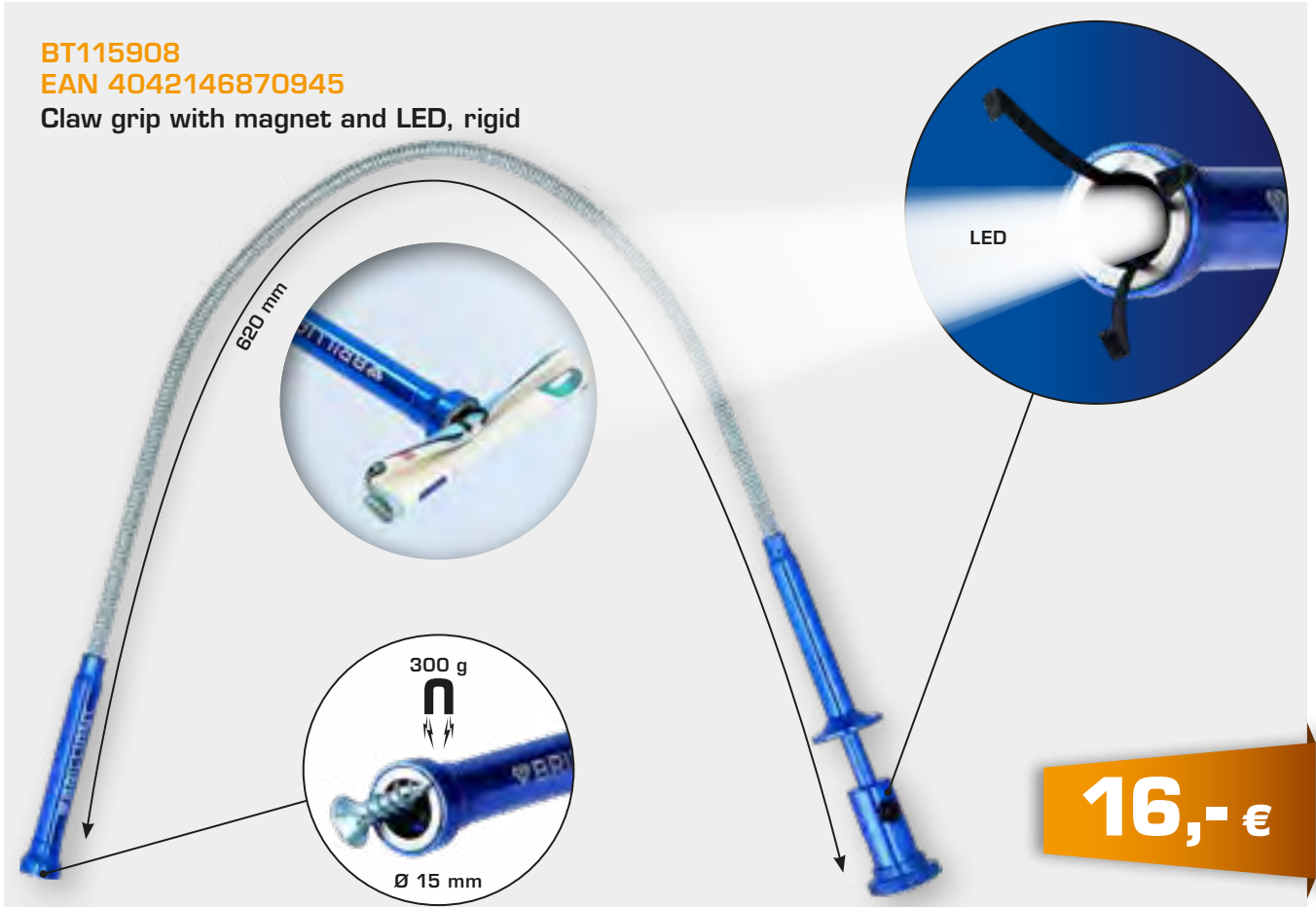

# PULLER



3" - 6"

**BT631021...023**

Universal 2-arm puller

start from **16,- €**



BT No.	L1	L2	EAN 4042146+	€
BT631021	 50 mm	105 mm	844748	16,00
BT631022	 60 mm	155 mm	844755	20,00
BT631023	 80 mm	210 mm	844762	26,00



3" - 6"

**BT631024...026**

Universal 3-arm puller

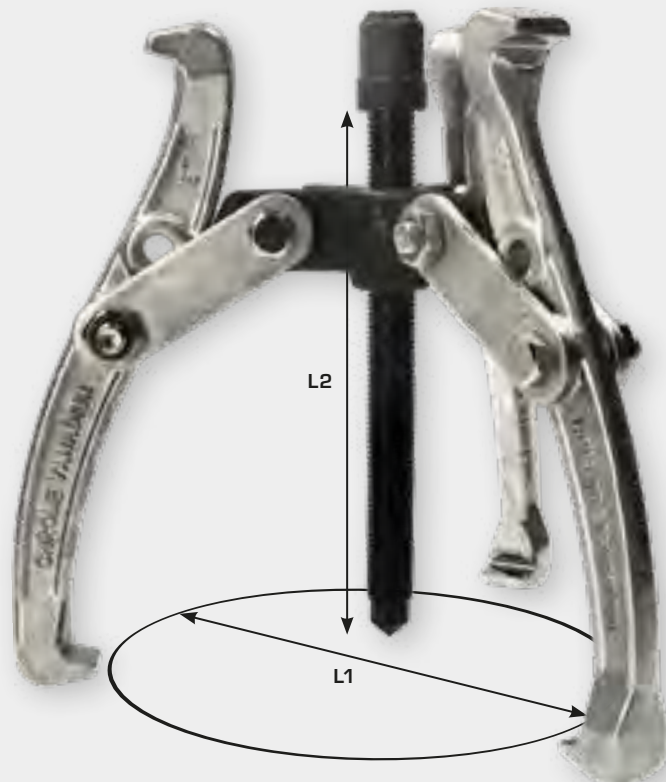
start from **25,- €**



BT No.	L1	L2	EAN 4042146+	€
BT631024	 50 mm	110 mm	844779	25,00
BT631025	 60 mm	140 mm	844786	28,00
BT631026	 80 mm	200 mm	844793	33,00



**13**  
pcs.

Ø 5 • 6 • 8

**BT631050**  
**EAN 4042146780848**  
Small insert bearing puller, 13 pcs

M10 x 1,5



**41,- €**

**16**  
pcs.

8-11 | 12-17 | 18-23 | 24-29 | 30-34 | 34-38  
39-43 | 44-48 | 49-53 | 54-58 mm

**BT631150**  
**EAN 4042146780817**  
Bearing extractor set, 16 pcs



**129,- €**

34-38 mm

39-43 mm

44-48 mm

49-53 mm

54-58 mm



8-11 mm

12-17 mm

18-23 mm

24-29 mm

30-34 mm

PULLER

14  
pcs.

Ø 30 → 56 mm / Ø 56 → 75 mm

BT631100  
EAN 4042146780831  
Bearing separator, 14 pcs

82,- €



14  
pcs.

BT631000  
EAN 4042146780855  
Universal puller set, 14 pcs

169,- €





**5**  
pcs.

40 → 80 mm  
50 → 150 mm

**BT631200**  
**EAN 4042146780824**

**3 jaw internal & external puller set, 5 pcs**



40 to 80 mm



50 to 150 mm



50 to 150 mm

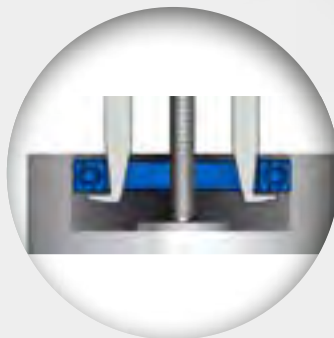

**97,- €**

## HAMMER

### BT073030...150

Fitters hammer with hickory handle



start from **9,- €**

BT No.	Weight (g)	EAN 4042146+	€
BT073030	300	868157	9,00
BT073050	500	868164	11,00
BT073080	800	868171	13,00
BT073100	1000	868188	15,00
BT073150	1500	868195	20,00

### BT077025...250

Fitter hammer with hickory handle, french form



start from **11,- €**

BT No.	Weight (g)	EAN 4042146+	€
BT077025	250	868249	11,00
BT077040	400	868256	12,00
BT077080	800	868263	17,00
BT077100	1000	868270	17,00
BT077150	1600	868287	19,00
BT077250	2500	868294	22,00

### BT075100...200

Club hammer with hickory handle



start from **13,- €**

BT No.	Weight (g)	EAN 4042146+	€
BT075100	1000	868201	13,00
BT075125	1250	868218	15,00
BT075150	1500	868225	17,00
BT075200	2000	868232	22,00





**BT071925**  
**EAN 4042146782033**

Plastic soft-head hammer Ø 32 mm

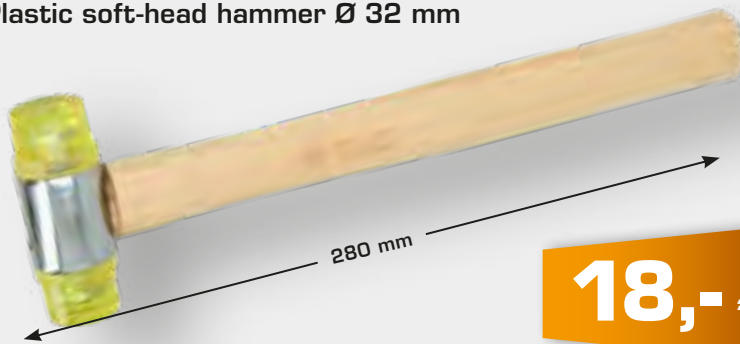

**18,- €**

**BT071926**  
**EAN 4042146782040**

Pair of replacement heads  
Ø 32 mm



**3,- €**

**BT071930**  
**EAN 4042146787793**

Plastic soft-head hammer Ø 40 mm



**23,- €**

**BT071931**  
**EAN 4042146782064**

Pair of replacement heads  
Ø 40 mm

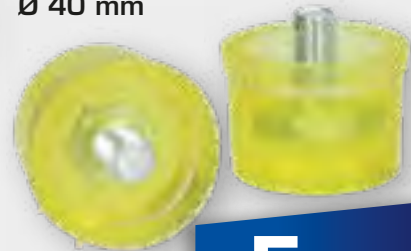

**5,- €**

**BT156912**  
**EAN 4042146871287**

Hammer tacker for wire staples

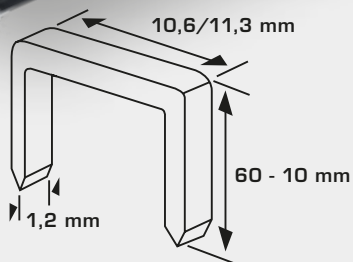

**23,- €**

# CHISEL / PUNCH / LEVER

8  
pcs.

BT085060  
EAN 4042146866757  
Chisel and punch set



20,- €

5 x		Ø 3 • 4 • 5 • 6 • 8 x 150 mm
1 x		15 x 150 mm
1 x		4 x 150 mm
1 x		3 x 150 mm

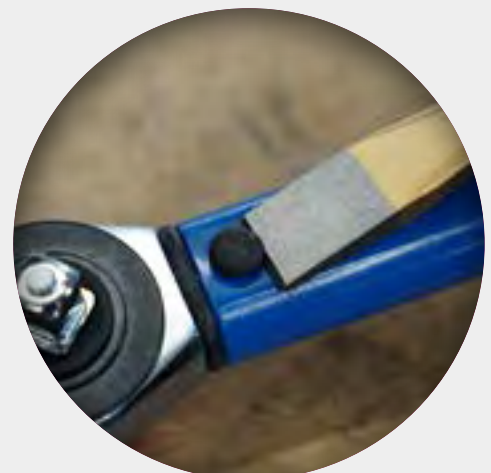

**12**  
pcs.

**BT085010**  
**EAN 4042146866733**  
Chisel and punch set

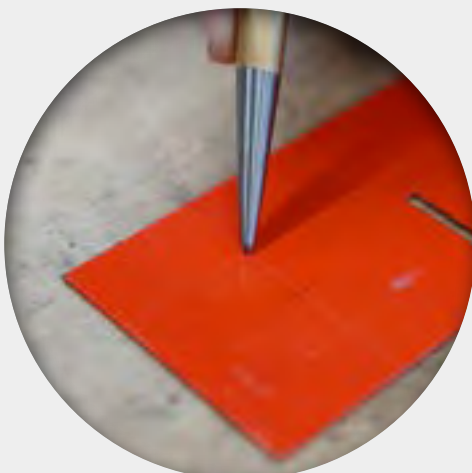

**29,- €**

<b>6 x</b>		12 x 165 • 15 x 175 • 19 x 195 • 20 x 195 • 22 x 240 • 25 x 240 mm
<b>3 x</b>		9 x 245 • 5 x 245 • 3 x 145 mm
<b>1 x</b>		9,4 x 195 mm
<b>2 x</b>		4 x 145 • 6 x 195 mm



CHISEL / PUNCH / LEVER

**BT085030**  
**EAN 4042146866740**  
 Chisel and punch set

**28**  
 pcs.

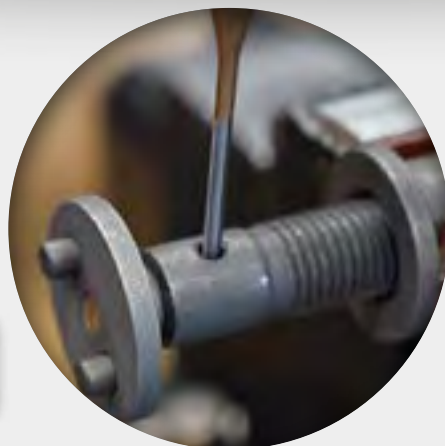

**45,- €**

5 x		2,4 x 110 • 3,2 x 120 • 4 x 125 • 5 x 135 • 6,5 x 145 mm
5 x		2,4 x 135 • 3,2 x 145 • 4 x 150 • 5 x 160 • 6,5 x 170 mm
3 x		9,5 x 14,0 • 12,5 x 150 • 16 x 165 mm
2 x		3 x 125 • 4,8 x 150 mm
6 x		12 x 165 • 15 x 175 • 19 x 195 • 20 x 195 • 22 x 240 • 25 x 240 mm
1 x		9,5 x 195 mm
3 x		3 x 145 • 5 x 245 • 9,5 x 245 mm
2 x		4,5 x 145 • 6 x 195 mm
1 x		-



**6**  
pcs.

**BT085070**  
**EAN 4042146866764**  
Punch set

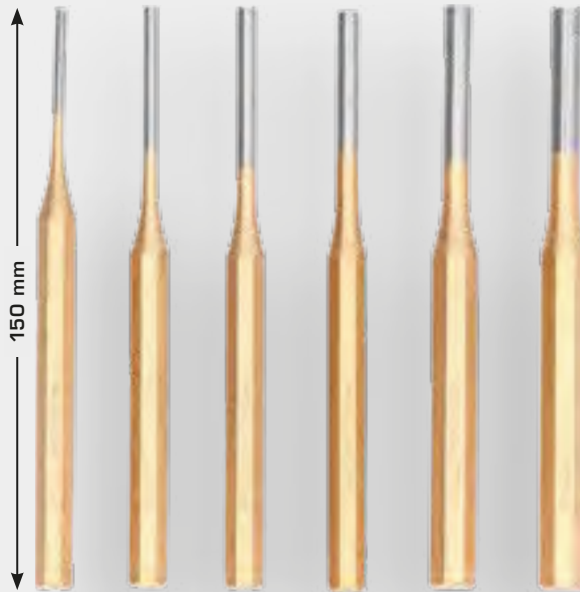

**15,- €**

6 x



Ø 3 • 4 • 5 • 6 • 7 • 8 mm

**6**  
pcs.

**BT085080**  
**EAN 4042146866771**  
Centre punch set

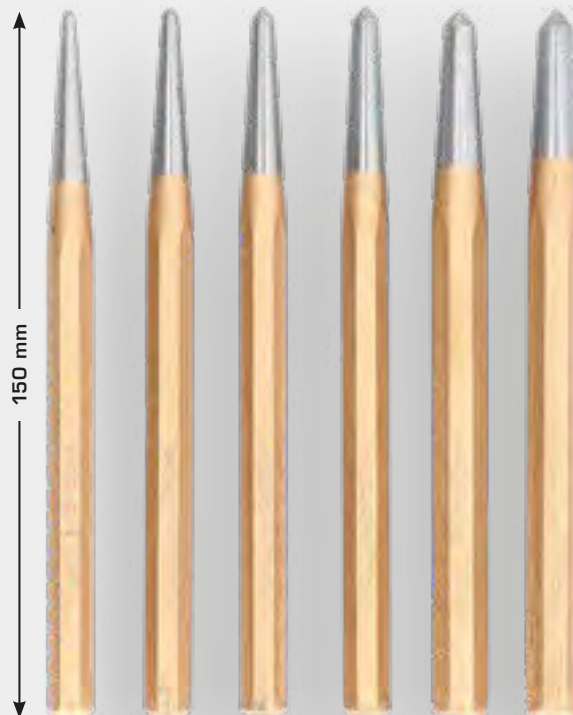

**17,- €**

6 x



Ø 3 • 4 • 5 • 6 • 7 • 8 mm

## CHISEL / PUNCH / LEVER

**BT080918**  
**EAN 4042146778272**  
Flat chisel

**5,- €**

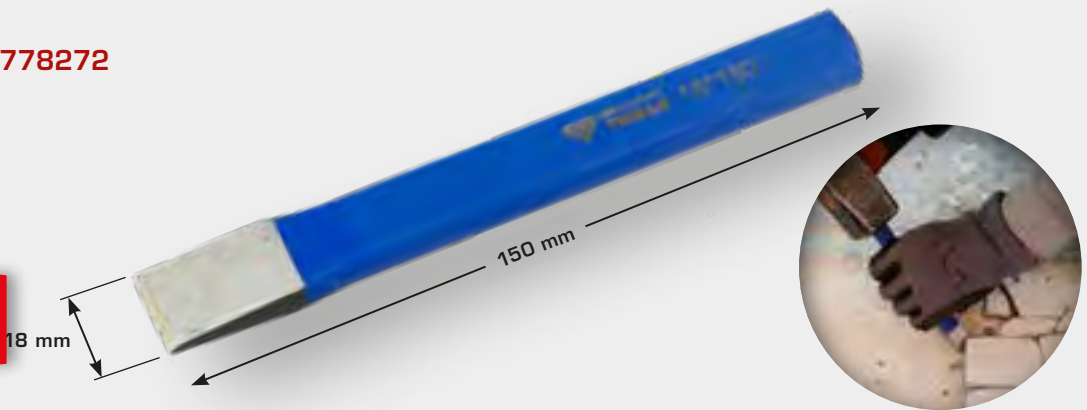

**BT081906**  
**EAN 4042146778289**  
Cape chisel

**5,- €**

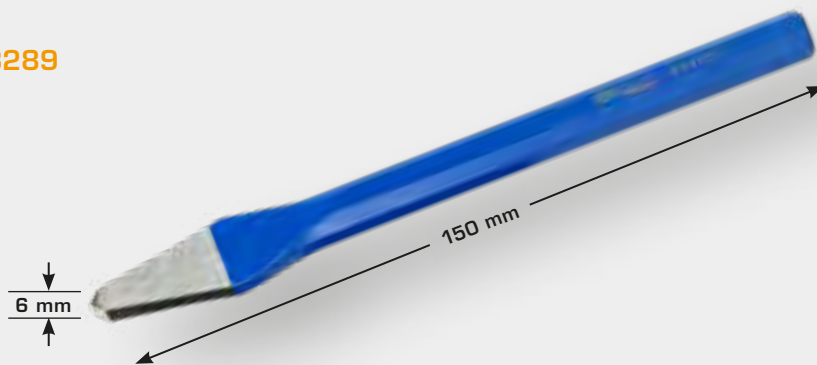

**BT084910**  
**EAN 4042146778296**  
Centre punch

**4,- €**

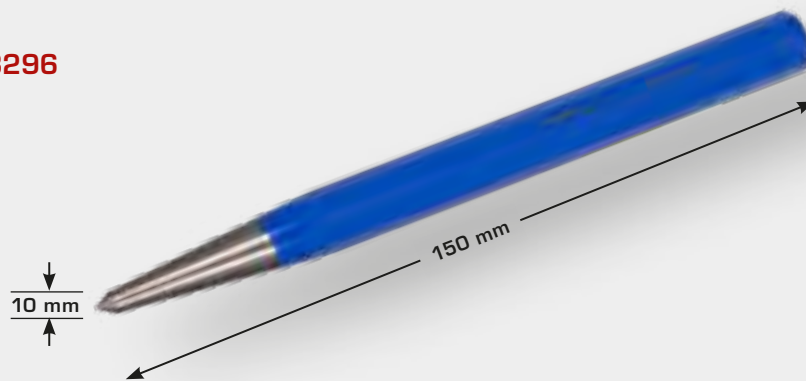

**BT084911**  
**EAN 4042146868522**  
Automatic centre punch

**6,- €**

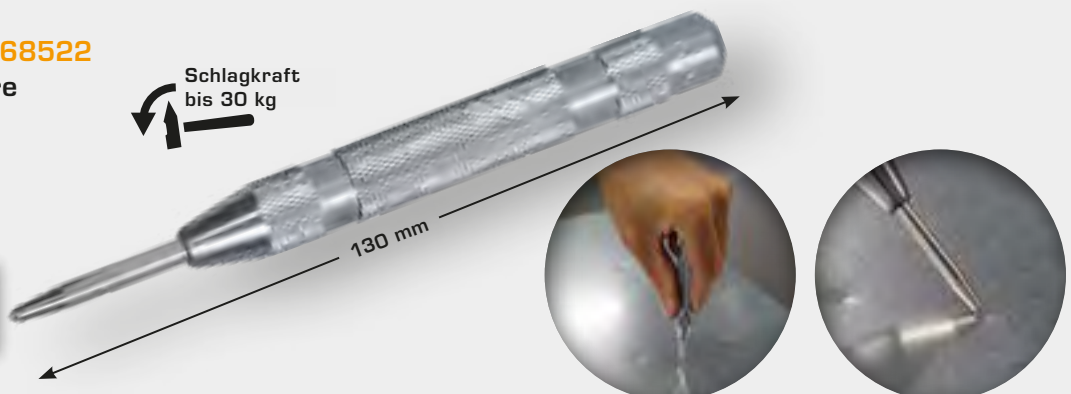

**4**  
pcs.

**BT091004**  
**EAN 4042146864401**  
Pry bar set



**20,- €**

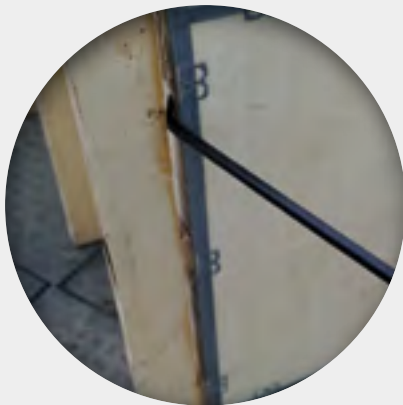

**BT090900**  
**EAN 4042146778371**  
Crowbar

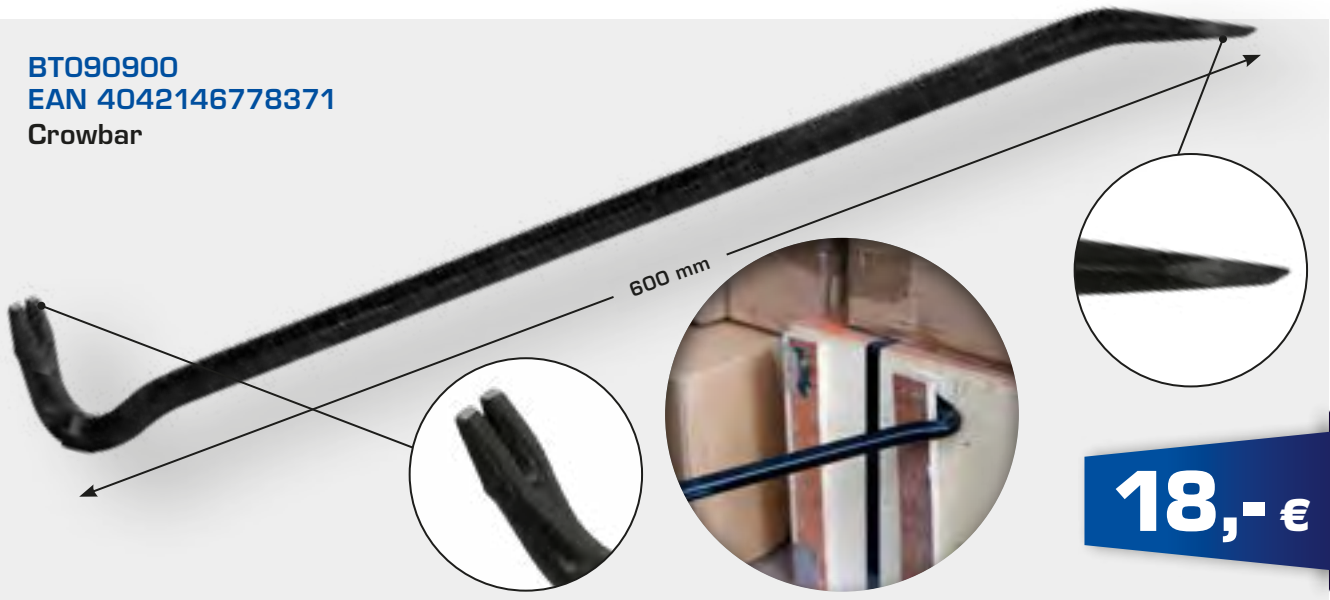

**18,- €**

## CUTTING AND SCRAPING TOOLS

BT102905

EAN 4042146778289

Folding knife with locking function and bag

12,- €



BT102900

EAN 4042146778395

Knife

3,- €

2K

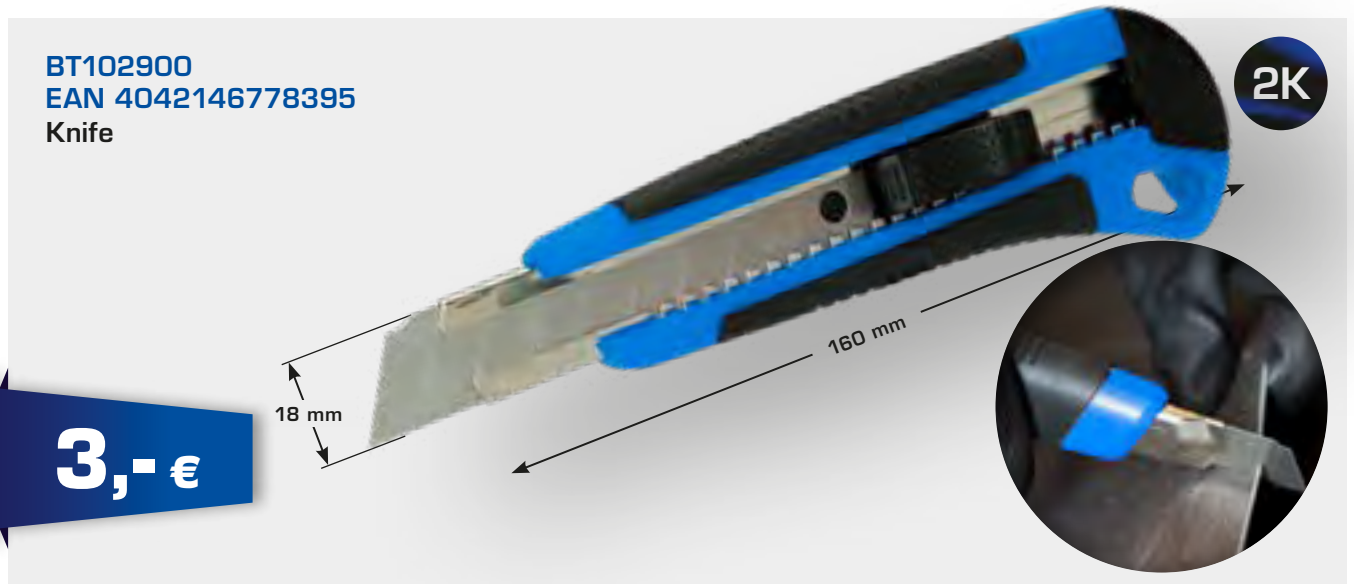

BT102901

EAN 4042146825655

Snap off blades 10 pcs

2,- €







**BT100900**  
**EAN 4042146778401**  
Universal scissors

**STAINLESS  
STEEL**

**2K**

**3,- €**



202 mm

**BT100901**  
**EAN 4042146867983**  
Universal scissors



50 mm

145 mm



**5,- €**

**BT100902**  
**EAN 4042146867990**  
Universal workshop scissors

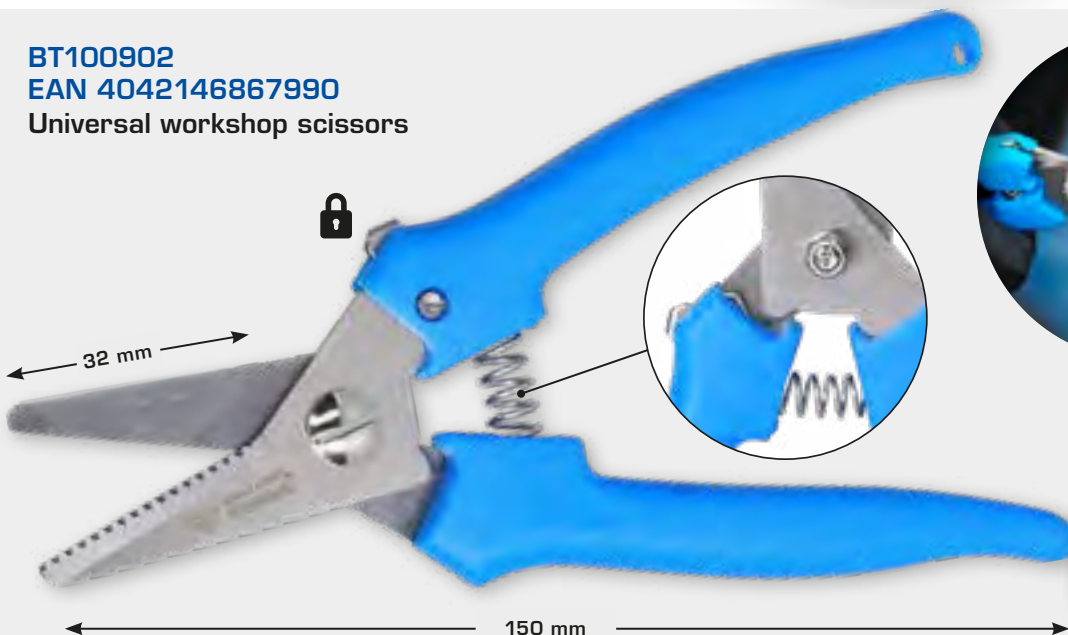

32 mm

150 mm



**4,- €**

## CUTTING AND SCRAPING TOOLS

**BT100903**  
**EAN 4042146871003**  
 Knife and multifunctional pliers



Nr.	Function
1	Snipe nose pliers
2	Plier
3	Can opener
4	Bottle opener
5	Slot screwdriver, middle

Nr.	Function
6	Preforator
7	Slot screwdriver, large
8	File
9	PH1 screwdriver
10	Knife

Nr.	Function
11	Slot screwdriver, small
12	Saw
13	Fishing hook remover
14	Cable cutters
15	Safety locks for locking

**20,- €**

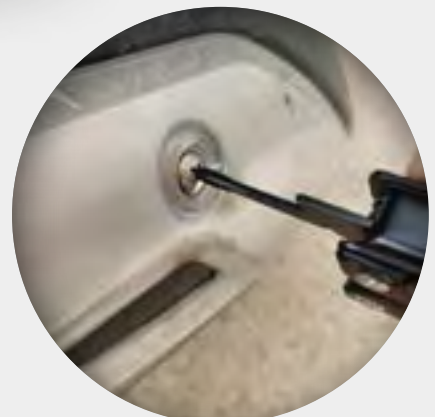
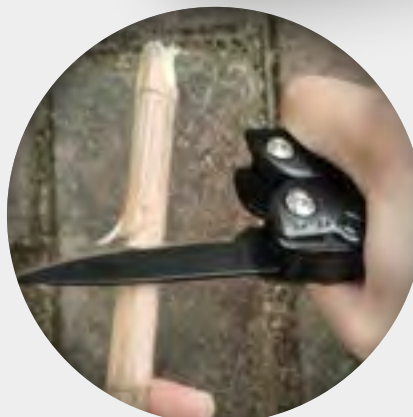
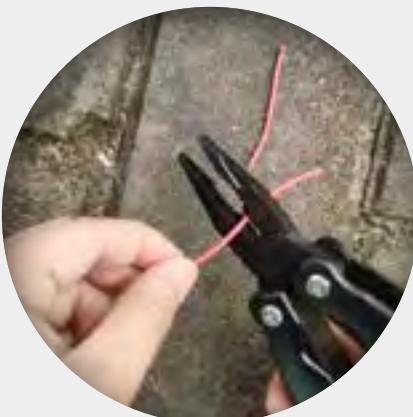

**BT101922**  
**EAN 4042146778418**  
Scraper



**5,- €**

**BT101923**  
**EAN 4042146822968**  
Scraper



**5,- €**



**BT101924**  
**EAN 4042146865347**  
Scrapers set

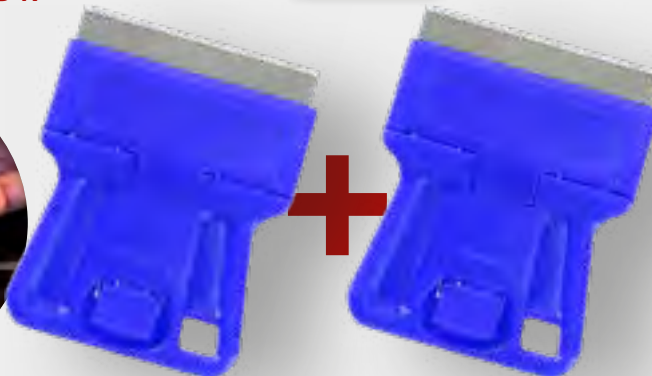

**2  
pcs.**

**2,- €**



**BT101930**  
**EAN 4042146866795**  
Universal scraper set

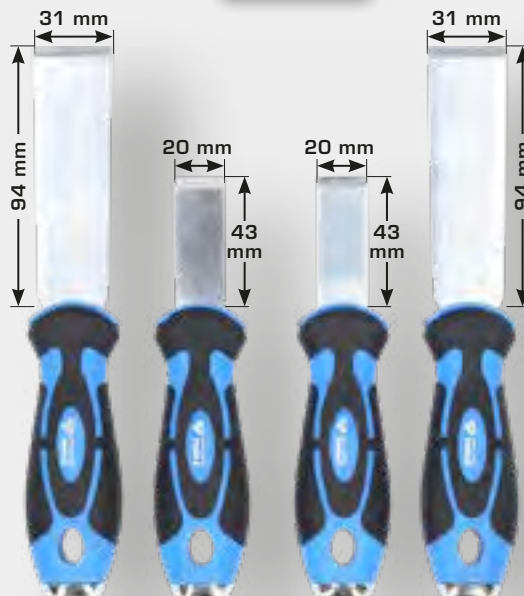
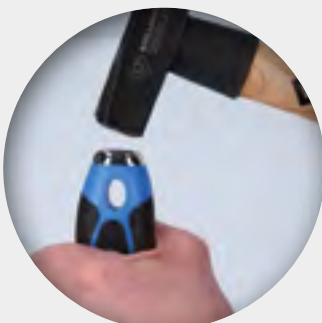

**4  
pcs.**

**40,- €**

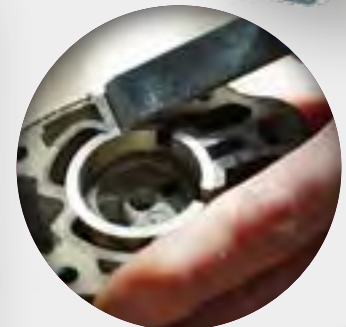

## CUTTING AND SCRAPING TOOLS

**32**  
pcs.

**BT101950**  
**EAN 4042146871133**  
TiN tap and die set



**49,- €**

1x		M3 - M12
1x		M3 - M21
1x		6,0 x 110 mm
1x		0,5 - 1,75 mm
7x		M3 x 0,5 • M4 x 0,7 • M5 x 0,8 • M6 x 1,0 • M8 x 1,25 • M10 x 1,25 • M12 x 1,75 mm
7x		M3 x 0,5 • M4 x 0,7 • M5 x 0,8 • M6 x 1,0 • M8 x 1,25 • M10 x 1,25 • M12 x 1,75 mm



**110**  
pcs.

**BT101985**  
**EAN 4042146871140**  
TiN tap and die set



**179,- €**

<b>1 x</b>		M2 – M3
<b>2 x</b>		M3 – M12 • M6 – M20
<b>2 x</b>		M2 - M9 • M10 – M18
<b>35 x</b>		M2 x 0,4 • M3 x 0,5 • M4 x 0,7 • M5 x 0,8 • M6 x 0,75 • M6 x 1,0 • M7 x 0,75 • M7 x 1,0 • M8 x 0,75 • M8 x 1,0 • M8 x 1,25 • M9 x 0,75 • M9 x 1,0 • M9 x 1,25 • M10 x 0,75 • M10 x 1,0 • M10 x 1,25 • M10 x 1,5 • M11 x 0,75 • M11 x 1,0 • M11 x 1,25 • M11 x 1,5 • M12 x 0,75 • M12 x 1,0 • M12 x 1,25 • M12 x 1,5 • M12 x 1,75 • M14 x 1,0 • M14 x 1,25 • M14 x 1,5 • M14 x 2,0 • M16 x 2,0 • M16 x 1,5 • M16 x 1,0 • M18 x 1,5 mm
<b>35 x</b>		M2 x 0,4 • M3 x 0,5 • M4 x 0,7 • M5 x 0,8 • M6 x 0,75 • M6 x 1,0 • M7 x 0,75 • M7 x 1,0 • M8 x 0,75 • M8 x 1,0 • M8 x 1,25 • M9 x 0,75 • M9 x 1,0 • M9 x 1,25 • M10 x 0,75 • M10 x 1,0 • M10 x 1,25 • M10 x 1,5 • M11 x 0,75 • M11 x 1,0 • M11 x 1,25 • M11 x 1,5 • M12 x 0,75 • M12 x 1,0 • M12 x 1,25 • M12 x 1,5 • M12 x 1,75 • M14 x 1,0 • M14 x 1,25 • M14 x 1,5 • M14 x 2,0 • M16 x 2,0 • M16 x 1,5 • M16 x 1,0 • M18 x 1,5 mm



## CUTTING AND SCRAPING TOOLS

**BT101925**  
**EAN 4042146870396**  
 Stepped drill bit set, Ø 4 – 32 mm

**3**  
 pcs.

Ø 4 - 32 mm



**44,- €**

Ø 4 - 12 mm

**BT101926**  
**EAN 4042146870402**  
 Stepped drill bit



**9,- €**

Ø 4 - 20 mm

**BT101927**  
**EAN 4042146870419**  
 Stepped drill bit



**15,- €**

Ø 4 - 32 mm

**BT101928**  
**EAN 4042146870426**  
 Stepped drill bit



**26,- €**

# EVERYTHING AT A GLANCE WITH 360° VIEWS

EVEN IF A PICTURE IS WORTH A THOUSAND WORDS:  
YOU WILL ALSO FIND DETAILED ARTICLE DESCRIPTIONS  
ON OUR WEBSITE!



**7 DAYS,  
24 HOURS**

**WWW.BRILLIANT-TOOLS.COM**



## CUTTING AND SCRAPING TOOLS

**BT101941**  
**EAN 4042146871010**  
Small hand saw frame

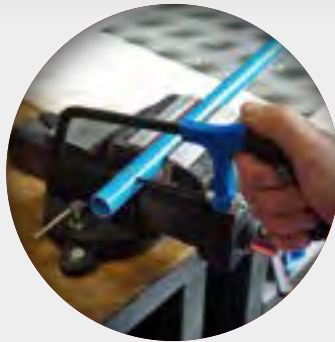
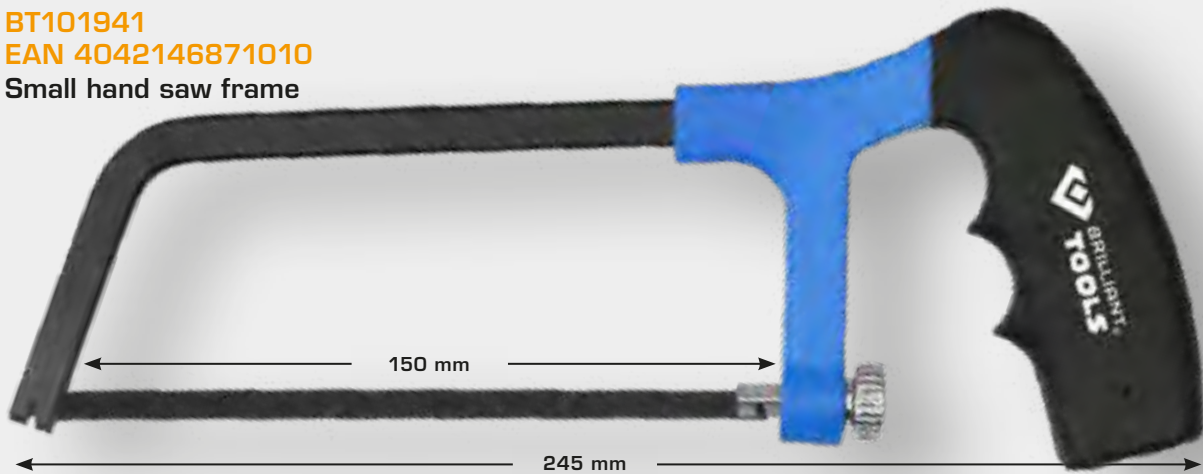

**6,- €**

**BT101942**  
**EAN 4042146871027**  
Quick release hacksaw frame

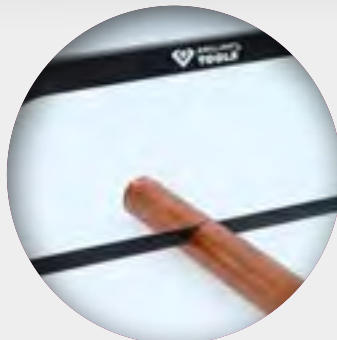
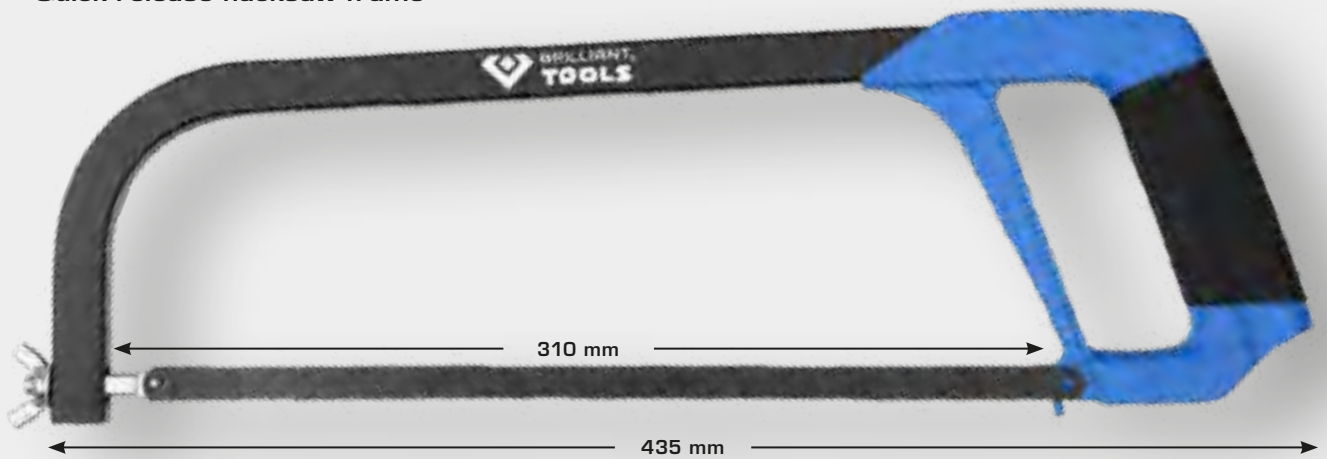

**12,- €**





**BT067200**  
**EAN 4042146870709**  
Tin snips sheet metal shear set

**3**  
pcs.

**29,- €**

**10"**

**BT067201**  
**EAN 4042146870716**  
Tin snips sheet metal shear, self opening, right handed cut

**11,- €**

**10"**

**BT067202**  
**EAN 4042146870723**  
Tin snips sheet metal shear, self opening, straight cut

**11,- €**

**10"**

**BT067203**  
**EAN 4042146870730**  
Tin snips sheet metal shear, self opening, left handed cut

**11,- €**

# FILES AND BRUSHES

BT100950  
EAN 4042146867242  
File set, 5 pcs

5  
pcs.

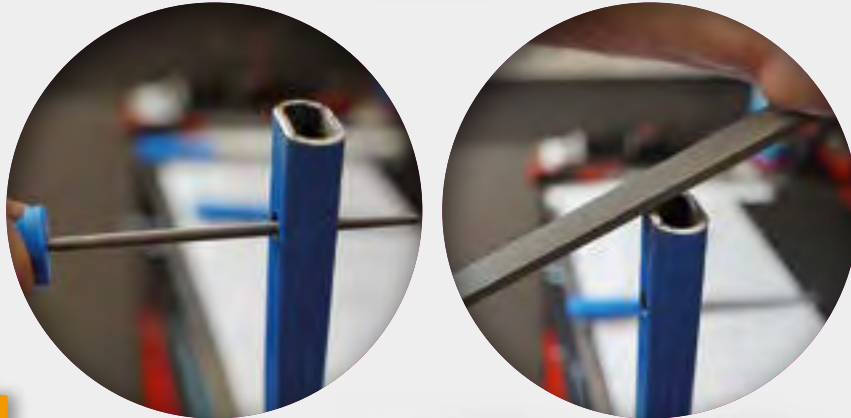

20,- €





**19**  
pcs.

**BT103030**  
**EAN 4042146868515**  
File set with file brush, 19 pcs

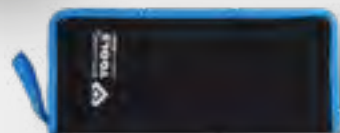
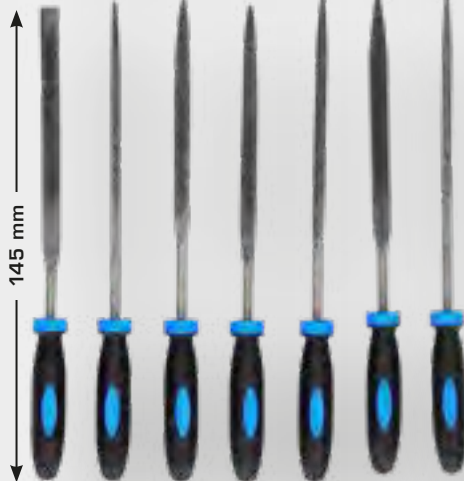
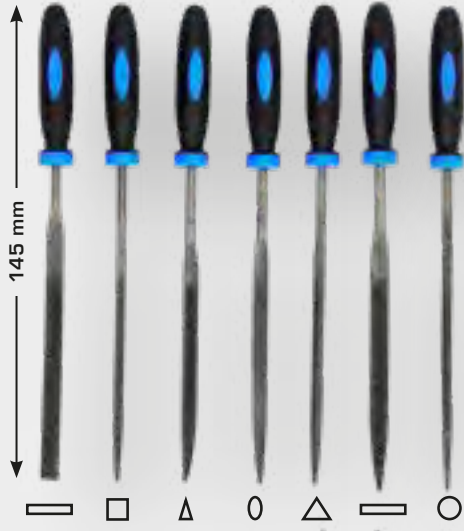
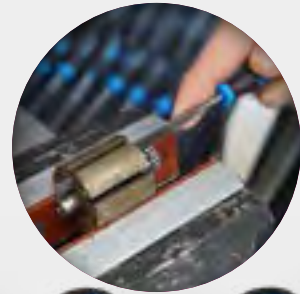

**33,- €**

# FILES AND BRUSHES

**20**  
pcs.

**1/4"**  
6,3 mm

**BT103000**  
**EAN 4042146859162**  
cleaning brush set, 20 pcs



**23,- €**

Brass

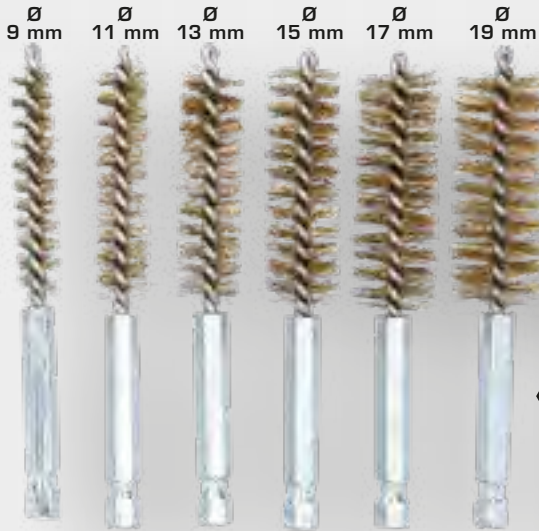

Nylon

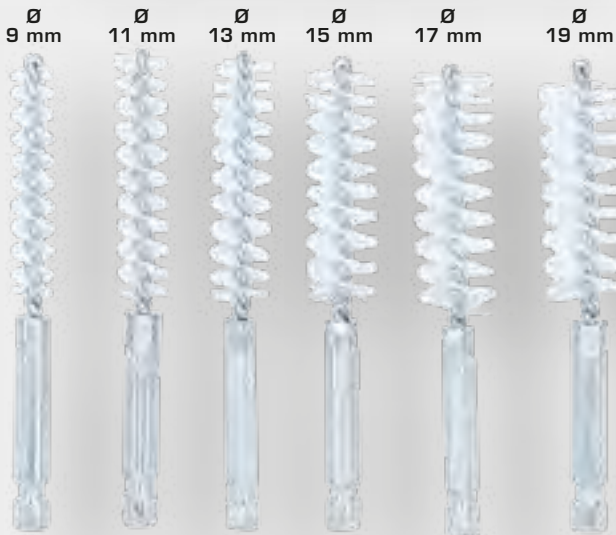

Steel

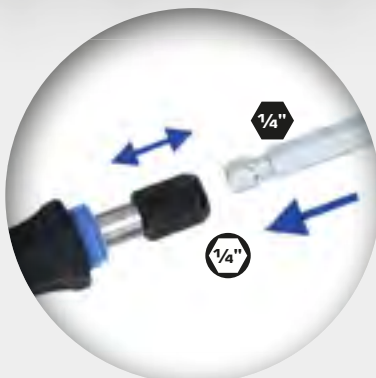
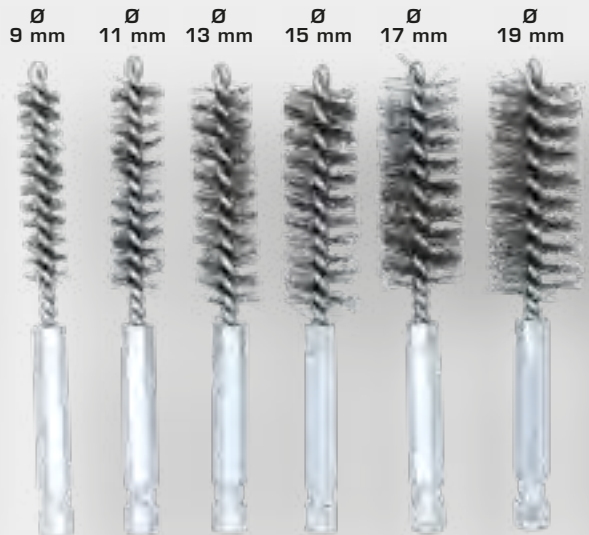



**STEEL**

**BT706002**  
**EAN 4042146813089**  
Steel hand wire brush,  
4 rows, 290 mm

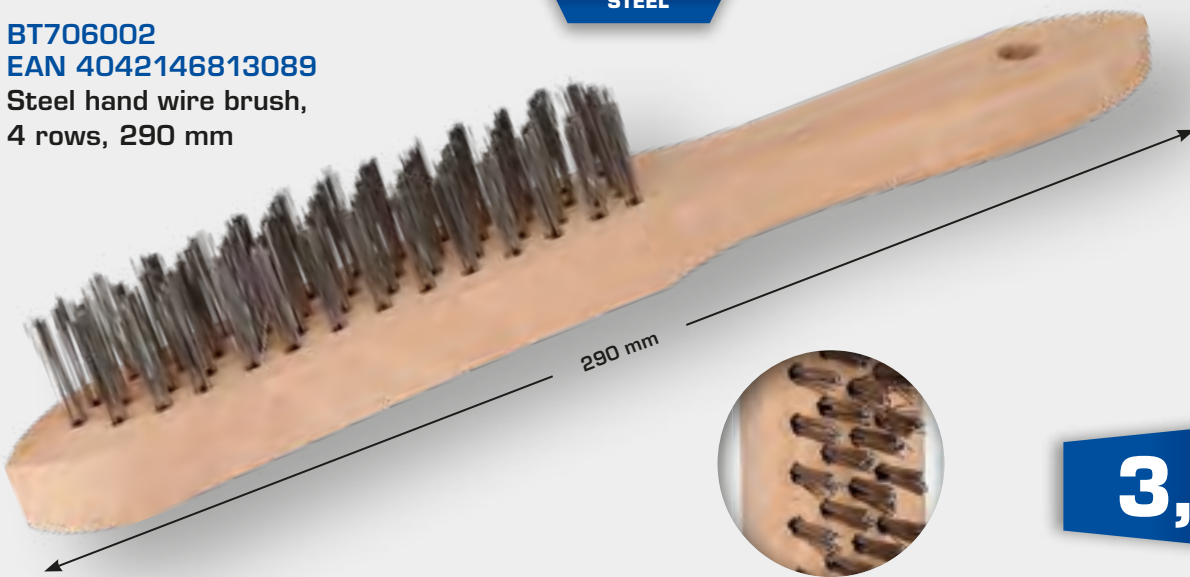

**3,- €**

**STAINLESS STEEL**

**BT706003**  
**EAN 4042146813096**  
Stainless steel hand wire brush,  
3 rows, 290 mm



**4,- €**

**BRASS**

**BT706009**  
**EAN 4042146868584**  
Brass hand wire brush,  
4 rows, 290 mm

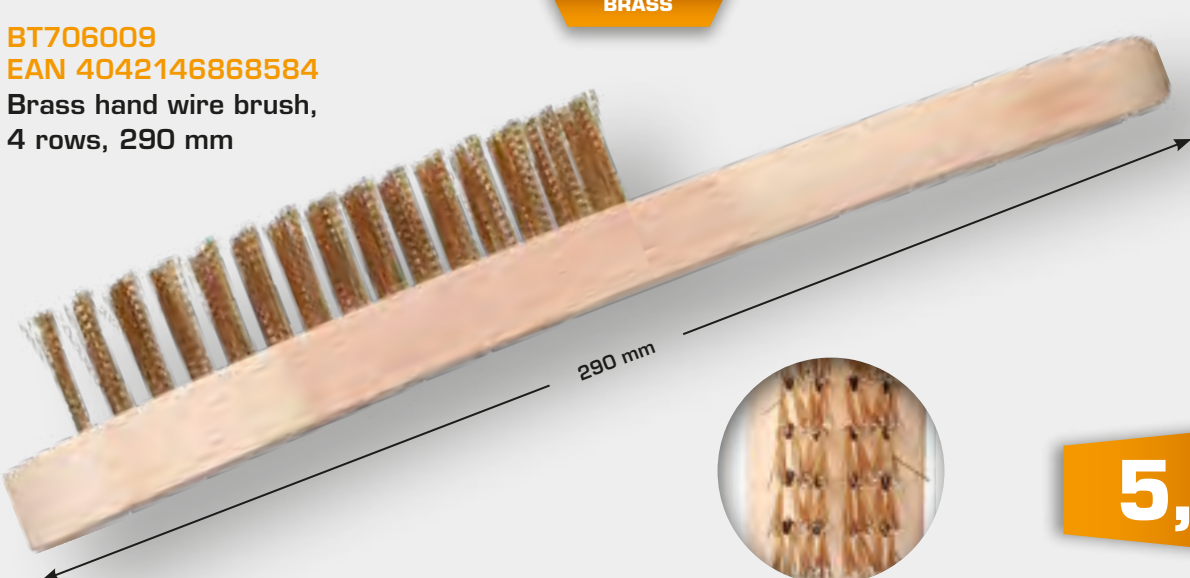

**5,- €**

## FILES AND BRUSHES

PLEDGED

**BT103101**  
**EAN 4042146868591**  
 Bevel brush, Ø 100 mm with  
 M14 x 2.0 mm holder



**7,- €**



M14 x 2,0 mm  
 admission,  
 not more than  
 12.500 U/Min

PLEDGED

**BT103102**  
**EAN 4042146868607**  
 Disc brush, Ø 115 mm



**7,- €**



Ø 22 mm  
 admission,  
 not more than  
 12.500 U/Min

PLEDGED

**BT103103**  
**EAN 4042146868614**  
 Jar brush, Ø 65 mm with  
 M14 x 2.0 mm holder



**7,- €**

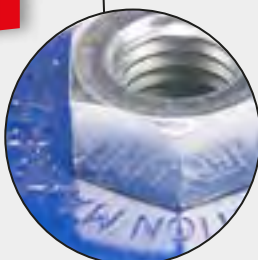

M14 x 2,0 mm  
 admission,  
 not more than  
 12.500 U/Min

PLEDGED

**BT103109**  
**EAN 4042146868676**  
 Disc brush, braided, Ø 75 mm with 6 mm  
 holder



**6,- €**



Ø 6 mm  
 admission,  
 not more than  
 12.500 U/Min



**STEEL**

**BT103104**  
**EAN 4042146868621**

Wire end brush, Ø 25 mm  
with 6 mm holder

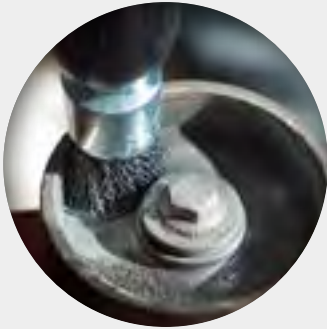

Ø 6 mm admission,  
not more than  
4.500 U/Min

**4,- €**

**STEEL**

**BT103105...106**

Jar brush, Ø 50 mm with 6 mm holder



Ø 6 mm admission,  
not more than  
4.500 U/Min

**start from 4,- €**

BT No.	Ø	EAN 4042146+	€
BT103105	50	868638	4,00
BT103106	75	868645	5,00

**STEEL**

**BT103107...108**

Disc brush  
with 6 mm holder



Ø 6 mm admission,  
not more than  
4.500 U/Min

**start from 4,- €**

BT No.	Ø	EAN 4042146+	€
BT103107	75	868652	4,00
BT103108	100	868669	5,00

# FILES AND BRUSHES

4  
pcs.

BT103110  
EAN 4042146870983  
Brush attachment set for  
power drills, 4 pcs



12,- €

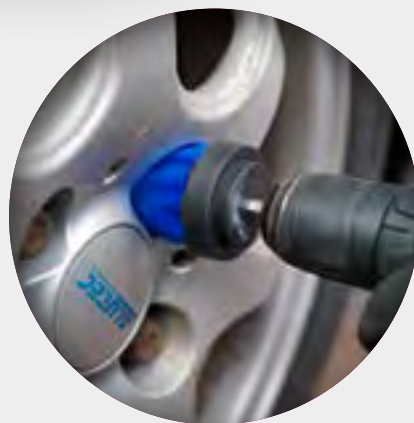





## MEASURING TOOLS

BT110900  
EAN 4042146778425  
Ruler

2 m

8,- €



BT111903  
EAN 4042146778432  
Measure tape

3 m

4,- €



18 mm

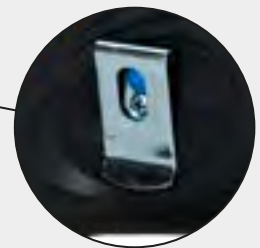

BT114901  
EAN 4042146867730  
Precision feeler gauge

0,05 - 1 mm

6,- €





**BT114903**  
**EAN 4042146778456**  
Digital-depth gauge



**12,- €**

**BT114902**  
**EAN 4042146870617**  
Vernier caliper



**17,- €**

**BT114900**  
**EAN 4042146778456**  
Digital vernier caliper



**19,- €**

## RATCHEN HEADS



### FOUR-EDGED REPLUGGING

By simply replugging the square edge, the switch from right to left suit takes place. The torque wrenches can be converted to a different drive size with the help of the selection.

### ROBUST RATCHET HEAD

Robust ratchet mechanism for left and right suit

### RATCHET HEAD

A very robust ratchet mechanism for the right and left suit is installed in the polished ratchet head. Changing the direction of rotation is done by simply replugging the drive square edge with the help of the push-button quick release function on the Raschenkopf. A sliding roller buckling mechanism inside the key guarantees maximum accuracy and long service life. The achievement of the desired torque is automatically made clear by an audible and tactile signal.

# WITH PRECISION TO PERFECTION.

### ACCURACY OF

**±3 %**

of scale value  
Repeatstart fromle and precise with at least 5,000 load changes

### SCALE WITH MAGNIFYING GLASS:

Under a generously dimensioned viewing window hides an easy-to-read scale in Nm and Lbf ft division, which allows a particularly precise setting of the desired torque value. In order to guarantee an optimal and simplified reading, a strong magnifying glass is installed in the viewing window.

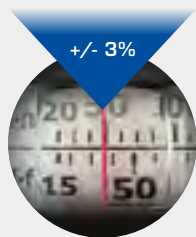

+/- 3%



### serial number:

An irrevocstart fromle, individual serial number is applied to all torque wrenches, which is used for unique product identification.

### Micrometer scale:

With the white micrometer scale ring, a fine adjustment can now also be made. The viewing window is generously dimensioned and guarantees an optimal and simplified reading of the micrometer value thanks to the integrated magnifying glass function. Depending on the model, divisions of 1/0.5/0.25/0.1 or 0.025 Nm can be precisely adjusted.



### 2K HANDLE

The new handy and ergonomic two-component handle guarantees safe and fatigue-free working, while the softer component also prevents the hand start from slipping and ensures maximum safety.

### END OF THE HANDLE:

By simply pulling out and pushing in the slide-in button at the end of the handle, using the ergonomic finger recesses, the desired torque can be set and fixed. A blue ring on the slide-in button indicates that the setting of the key still needs to be fixed or prevents accidental adjustment of the key during use.



# IF YOU TAKE IT EXACTLY



1 - 320 Nm

**BT141901...905**

Torque wrench with rotary mushroom ratchet head, 1 - 320 Nm



2K

start from **79,- €**

BT No.	"	Nm	EAN 4042146+	€
BT141905	1/4	1 - 25	865569	79,00
BT141903	3/8	5 - 50	863749	79,00
BT141904	1/2	10 - 100	863756	79,00
BT141901	1/2	20 - 200	813140	79,00
BT141902	1/2	60 - 320	863633	89,00



1 - 320 Nm

**BT141906...910**

Torque wrench with reversible ratchet head, 1 - 320 Nm



**DISPOSAL MECHANICS**

With push-button quick release function at the ratchet head

2K

start from **89,- €**

BT No.	"	Nm	EAN 4042146+	€
BT141906	1/4	1 - 25	866139	89,00
BT141907	3/8	5 - 50	866146	89,00
BT141908	1/2	10 - 100	866153	89,00
BT141909	1/2	20 - 200	866160	89,00
BT141910	1/2	60 - 320	866177	99,00



# TORQUE

1/2"

5  
pcs.

28 - 200 Nm

BT142005  
EAN 4042146778548  
Torque wrench set, 5 pcs



45,- €

EVERYTHING  
YOU  
NEED!



1/2"  
12,5 mm

3  
pcs.

17 / 19 / 21 mm

# POWER AND CONTROL



21 mm



17 mm



19 mm



**15,- €**

BT691005  
EAN 4042146844229  
1/2" impact socket set for aluminium  
rims



Nm

# THEY KEEP THEIR PROMISES!

**BT115902**  
**EAN 4042146845035**  
 Magnet holder for impact wrench, torque wrench and sockets

**19,- €**

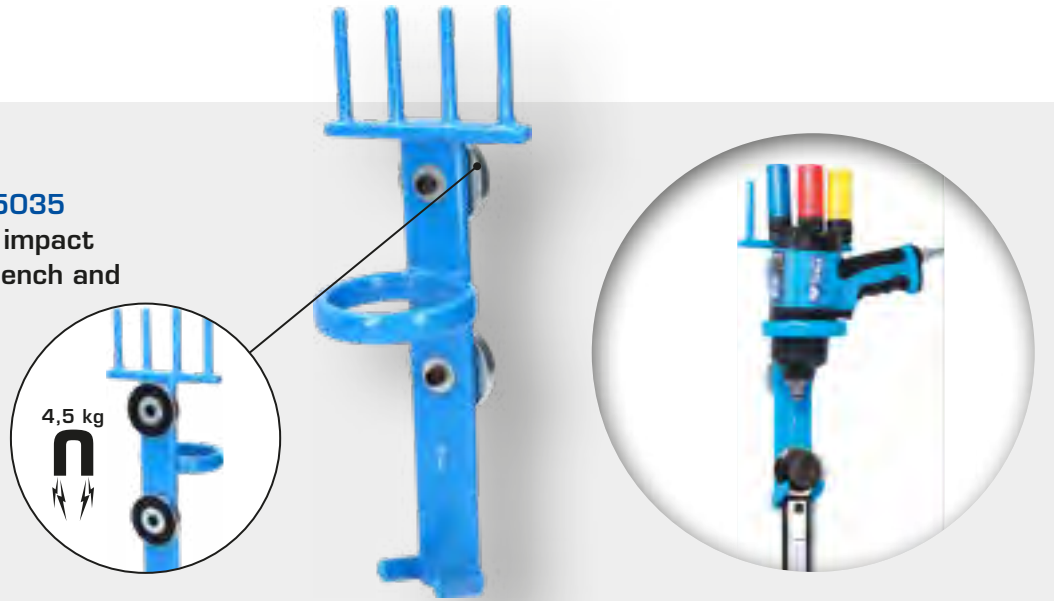

**BT160400**  
**EAN 4042146863077**  
 1/2" Mini pneumatic impact wrench 1.240 Nm

**1.240 Nm**



**65,- €**

Ø	↻ MAX.	↻ MAX.	↻ EMPFOHLEN	↻	⚡	🔊	🔊	🌬️	🕒	🔧	📏
Zoll	Nm	Nm	Nm	U/min	m/s <sup>2</sup>	dbA	dbA	l/min	bar	mm	PT
1/2	180, 470, 710	1240	520	9000	<10,25	108,9	115	170	max. 6,3	min. 10	1/4"



**BT160100**  
**EAN 4042146844403**  
1/2" Pneumatic impact wrench 1.450 Nm

**1.450 Nm**

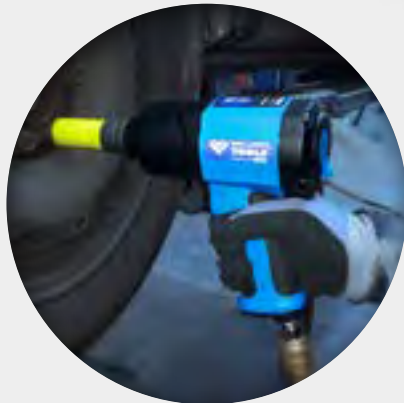

1/2"  
12,5 mm

190 mm

185 mm

2,2 kg



3/4" pneumatic impact wrench, 1.800 Nm



**59,- €**

Ø	MAX. Nm	MAX. Nm	EMPFÖHLEN Nm	U/min	m/s <sup>2</sup>	dbA	dbA	l/min	bar	mm	PT
1/2	470, 610, 830	1450	530	8500	<17,25	100,9	89,9	169	max. 6,3	min. 10	1/4"

**BT160200**  
**EAN 4042146853047**  
3/4" Pneumatic impact wrench 1.800 Nm

**1.800 Nm**



3/4"  
19 mm

190 mm

185 mm

2,2 kg



**109,- €**

Ø	MAX. Nm	MAX. Nm	EMPFÖHLEN Nm	U/min	m/s <sup>2</sup>	dbA	dbA	l/min	bar	mm	PT
3/4	610, 950, 1230	1800	830	8500	<17,25	100,9	91	198	max. 6,3	min. 10	1/4"

## PNEUMATIC BLOW

**BT160601**  
**EAN 4042146867860**  
 1/4" pneumatic ratchet, 35 Nm



**50,- €**

mm	MAX. Nm	U/min	m/s <sup>2</sup>	dbA	dbA	l/min	bar	mm	PT
1/2" (12,5 mm)	67	160	3,3	100,5	89,5	144	max. 6,3	10	1/4"

**BT160602**  
**EAN 4042146867877**  
 3/8" pneumatic ratchet, 35 Nm



**50,- €**

mm	MAX. Nm	U/min	m/s <sup>2</sup>	dbA	dbA	l/min	bar	mm	PT
3/8" (10 mm)	35	240	3,47	98,5	87,5	77	max. 6,3	10	1/4"

**BT160600**  
**EAN 4042146867884**  
 1/2" pneumatic ratchet, 67 Nm



**79,- €**

mm	MAX. Nm	U/min	m/s <sup>2</sup>	dbA	dbA	l/min	bar	mm	PT
1/2" (12,5 mm)	67	160	3,3	100,5	89,5	144	max. 6,3	10	1/4"

**BT160701**  
**EAN 4042146867891**  
Pneumatic die grinder, angled



**4**  
pcs.

**69,- €**

mm	U/min	m/s <sup>2</sup>	dbA	dbA	l/min	bar	mm	PT
6	20.000	5,02	101,6	99,1	85,5	max. 6,3	10	1/4"

**BT160702**  
**EAN 4042146867907**  
Pneumatic die grinder, straight



**45,- €**

mm	U/min	m/s <sup>2</sup>	dbA	dbA	l/min	bar	mm	PT
6	22.000	2,9	97,1	86,1	128,2	max. 6,3	10	1/4"

**BT160705**  
**EAN 4042146867914**  
Mini pneumatic die grinder, straight



**40,- €**

mm	U/min	m/s <sup>2</sup>	dbA	dbA	l/min	bar	mm	PT
6	22.000	2,1	95,1	82,4	86	max. 6,3	10	1/4"

15  
pcs.

BT160700

EAN 4042146867945

Mini pneumatic die grinder set, 15 pcs

INCLUDED  
10 GRINDING PINS



50,- €

mm	U/min	m/s <sup>2</sup>	dbA	dbA	l/min	bar	mm	PT
6	22.000	2,1	95,1	82,4	86	max. 6,3	10	1/4"

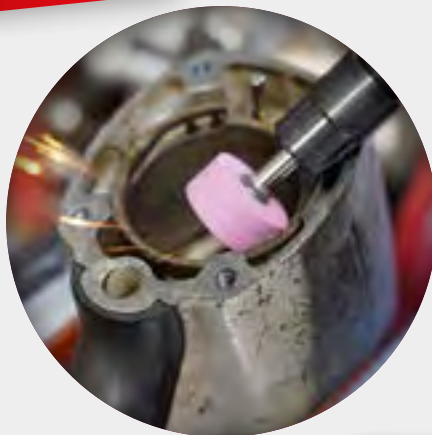

10  
pcs.

BT160711

EAN 4042146870976

Grinding pin set for pencil grinder, 10 pcs

9,- €



**BT160703**  
**EAN 4042146867921**  
Pneumatic angled disc cutter

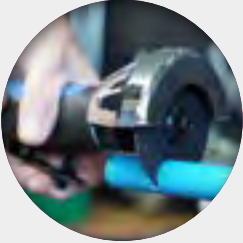

**63,- €**

Ø	U/min	m/s <sup>2</sup>	dbA	dbA	l/min	bar	mm	PT
6	22.000	1,67	90,4	79,4	128	max. 6,3	10	1/4"

**BT160704**  
**EAN 4042146867938**  
Pneumatic pistol grip drill

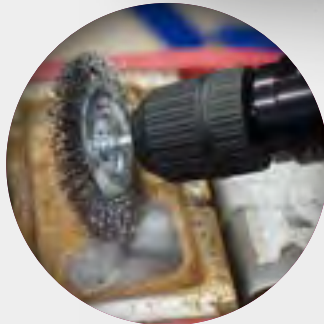

**67,- €**

Ø	U/min	m/s <sup>2</sup>	dbA	dbA	l/min	bar	mm	PT
0,8 - 10	1.800	1,5	103	92	114	max. 6,3	10	1/4"

**16**  
pcs.

**BT160710**  
**EAN 4042146870969**  
Pneumatic pencil grinder set,  
16 pcs



**46,- €**

Ø	U/min	m/s <sup>2</sup>	dbA	dbA	l/min	bar	mm	PT
3	54.000	xx	79,5	68,5	60	max. 6,2	9,52	1/4"

## PNEUMATIC BLOW

**3 pcs.** **110 - 500 mm**

**BT160500**  
**EAN 4042146863497**  
Pneumatic blow out pistol set, 3 pcs

500 mm  
300 mm  
110 mm

**13,- €**

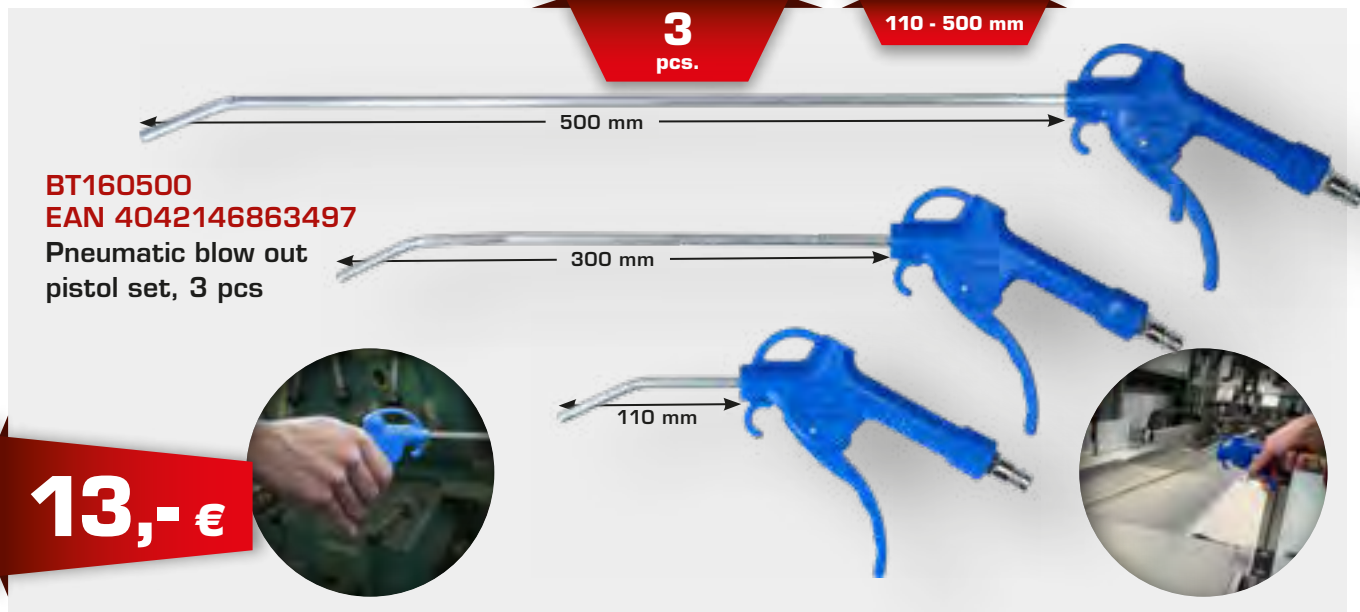

**BT161103**  
**EAN 4042146861134**  
Pneumatic blow out pistol included 3 changeable nozzles

200 mm  
100 mm

**7,- €**



**BT161104**  
**EAN 4042146864395**  
Pneumatic underbody protection gun

500 mm

**17,- €**









**BT160300**  
**EAN 4042146863046**  
Pneumatic cleaning gun



**45,- €**

			
l/min	bar	mm	PT
210	max. 9,2	10	1/4"



## PNEUMATIC BLOW

**BT160005...015**

Air hose

start from **12,- €**



Ø 9 mm, 10 m

Ø 9 mm, 5 m

BT No.	Ø mm	← L → mm	EAN 4042146+	€
BT160005	6	10	867273	12,00
BT160010	9	5	867280	15,00
BT160015	9	10	867297	23,00

10 m

**BT160030**

**EAN 4042146867310**

Air spiral coiled hose

Ø 6 mm, 10 meter



Ø 6 mm

**12,- €**

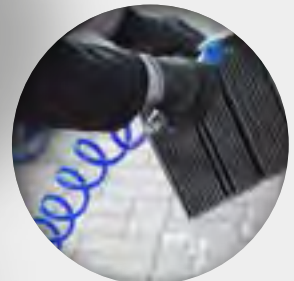

10 m

**BT160035**

**EAN 4042146867334**

Air spiral coiled hose

Ø 10 mm, 10 meter



Ø 10 mm

**29,- €**







**10 m**

**BT161101**  
**EAN 4042146859155**  
Automatic air hose reel  
Ø 8 mm, 10 meter

**60,- €**

Ø 8 mm

10 m  
50ft

8 mm  
12 mm

max. 20  
bar

1/4"  
6,3 mm

**15 m**

**BT161100**  
**EAN 4042146850169**  
Automatic air hose reel  
Ø 10 mm, 15 meter

**75,- €**

Ø 10 mm

15 m  
50ft

max. 18  
bar

3/8"  
10 mm

## WORKSHOP EQUIPMENT

15 m

**BT162000**  
**EAN 4042146859179**  
 Automatic cable reel, 15 + 1 meter

**90,- €**

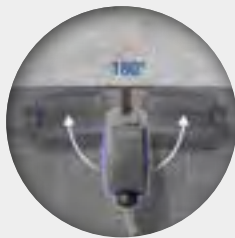

### Technical data:

Cable length	~ 15 m + 1 m supply cable
Cable cross-section	3 x 1,5 mm <sup>2</sup>
Cable type	H05VV-F1,5 mm <sup>2</sup>
Load capacity rolled up	1.000W / 230V
Load capacity unrolled	3.000W / 230V
Protection class	IP 44

310 ml

**BT094901**  
**EAN 4042146778388**  
 Cartridge gun, 310 ml

**11,- €**



500 ccm

**BT094902**  
**EAN 4042146867235**  
 Single-handed grease gun, 500 ccm

**33,- €**



**BT156930... 933**  
Micro fine-knit gloves

**12**  
pcs.

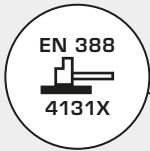

BT No.	Pcs.	Hand	EAN 4042146+	€
BT156930	12 x	S	856192	12,00
BT156931	12 x	M	856208	12,00
BT156932	12 x	L	856215	12,00
BT156933	12 x	XL	856222	12,00

**12,- €**

**BT156910**  
**EAN 4042146856284**  
Magnetic strap

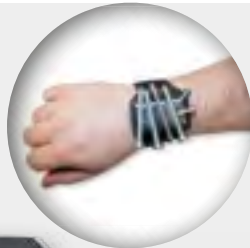

**4,- €**

**0,3 L**

**BT156917**  
**EAN 4042146868010**  
Oil spray can, 300 ml

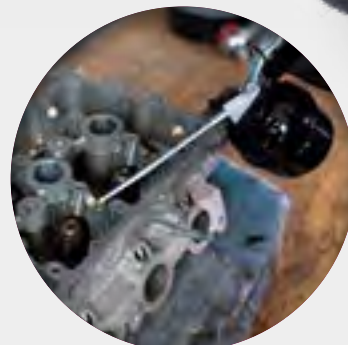

**6,- €**

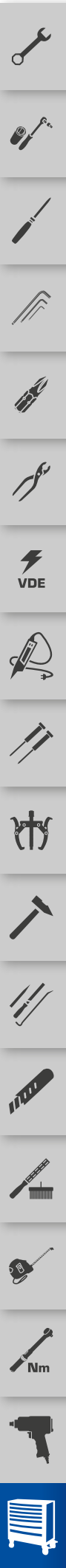

## WORKSHOP EQUIPMENT

**BT101935**  
**EAN 4042146868683**  
 Japan spatula set, plastic

**4,- €**

**4**  
 pcs.

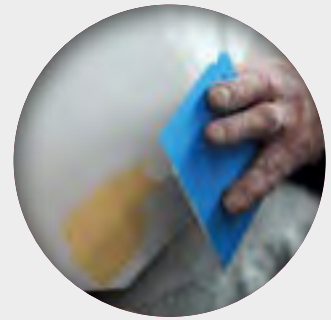

**BT101940**  
**EAN 4042146868690**  
 Japan spatula set, metal

**4,- €**

**4**  
 pcs.



**BT716003...005**  
 Oil drip tray /  
 multifunctional tray,  
 5 litres

start from **7,- €**

**6 - 13 L**



BT No.	L	EAN 4042146+	€
BT716003	5	870570	7,00
BT716004	8	870587	9,00
BT716005	13	870594	12,00

**BT156921**  
**EAN 4042146870631**  
 Universal wing cover

**23,- €**



**BT156923**  
**EAN 4042146870976**  
 Seat protection cover for single seats

**17,- €**



6", 150 mm

**BT156942**  
**EAN 4042146870518**  
Bench vice 6", 150 mm



**125,- €**

**BT156940**  
**EAN 4042146868409**  
Bench vice-protective jaws with notches, plastic

**2**  
pcs.

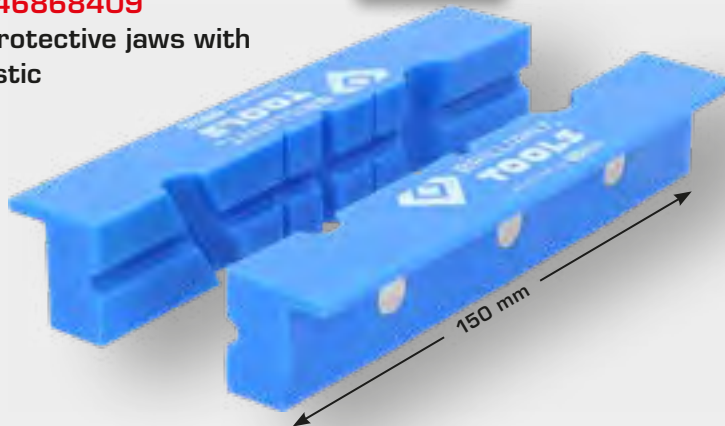

**TPU**

**12,- €**

**BT156941**  
**EAN 4042146868416**  
Bench vice-protective jaws with structure, plastic

**2**  
pcs.

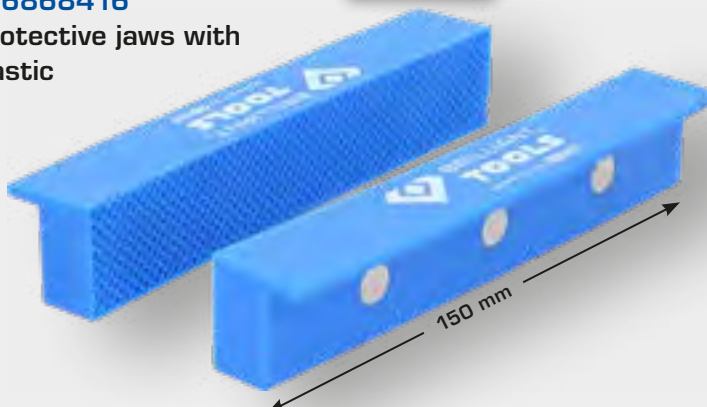

**TPU**

**12,- €**



## WORKSHOP EQUIPMENT

**BT180005**  
**EAN 4042146867952**  
Engine bridge, 500 kg

500 kg



**78,- €**

2  
pcs.

**BT180010**  
**EAN 4042146866719**  
Axle stands with quick unlocking, 2 tonnes



**45,- €**



480 x 320 x 30 mm

**BT156919**  
**EAN 4042146868362**  
Knee mat / knee board

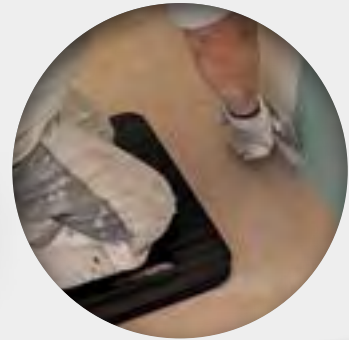
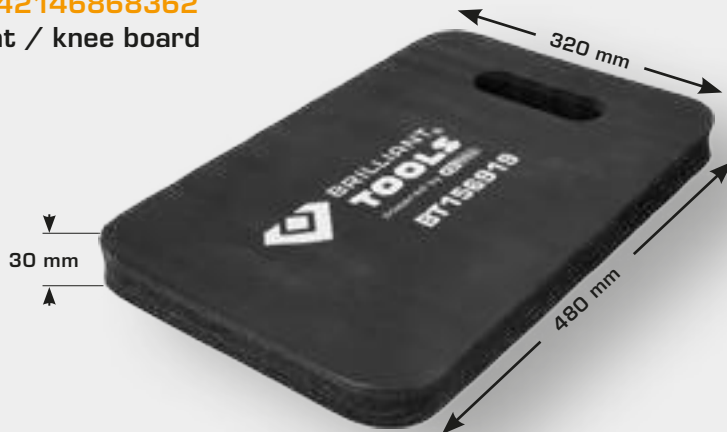

**9,- €**

1.200 x 400 x 23 mm

**BT156920**  
**EAN 4042146816844**  
Folding mechanic protection matt

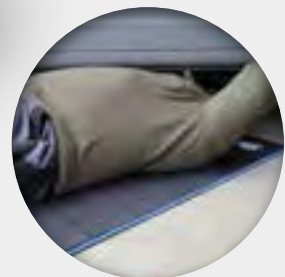
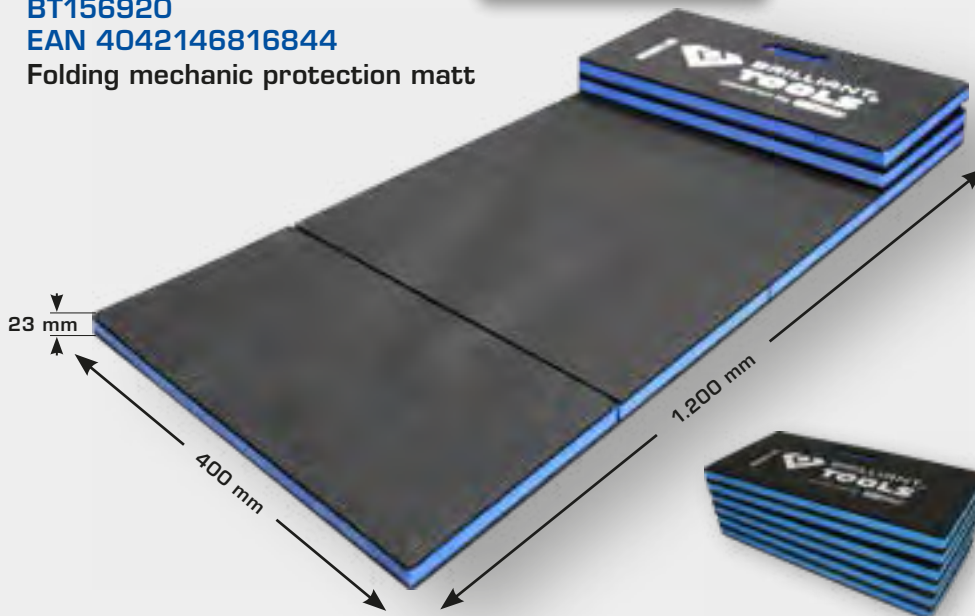

**19,- €**

**BT156905**  
**EAN 4042146813133**  
Workshop creeper

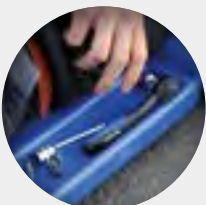
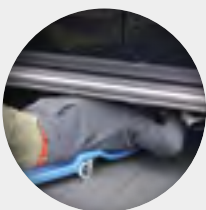

**41,- €**

4in1

BT180000  
EAN 4042146863695  
4in1 universal workbench

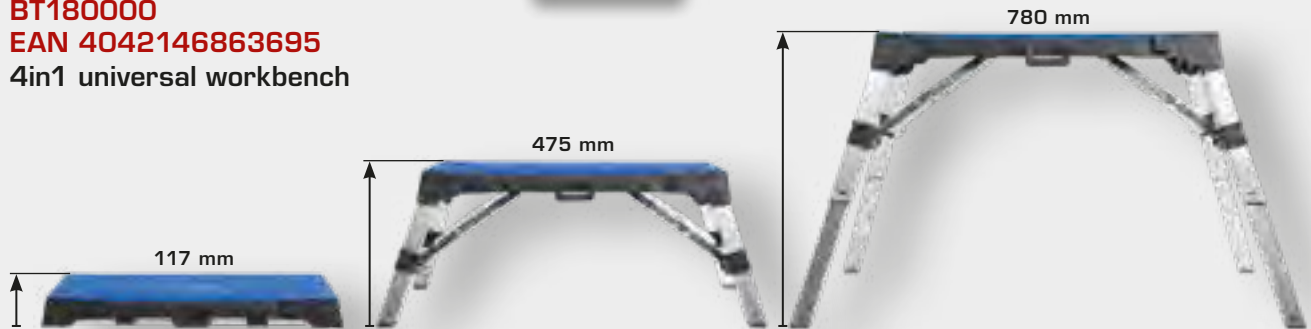

**1** WORKBENCH  
MAX. 150 KG



**2** WORK PLATFORM  
MAX. 150 KG

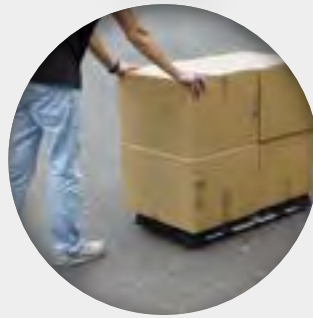

**3** TRANSPORT ROLLER  
MAX. 120 KG



**4** WORKSHOP DOLLY  
MAX. 120 KG



149,- €



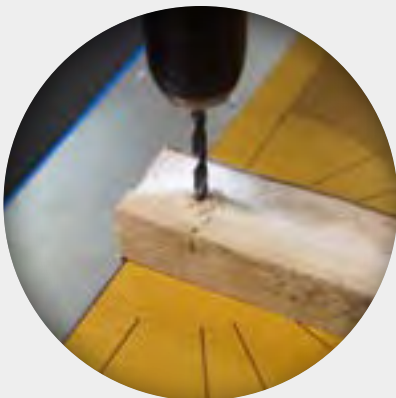
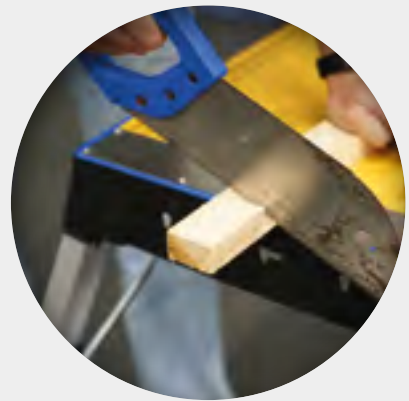
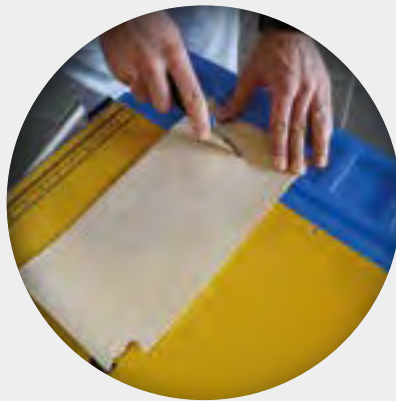
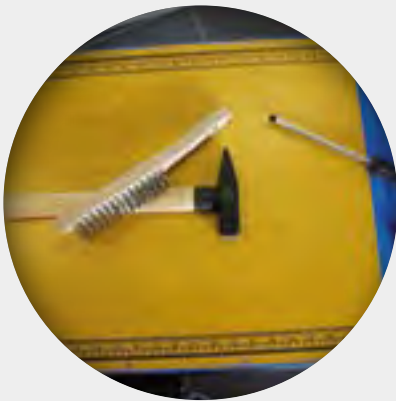

## WORKSHOP EQUIPMENT

BT150800  
EAN 4042146867266  
Metal tool box, folding

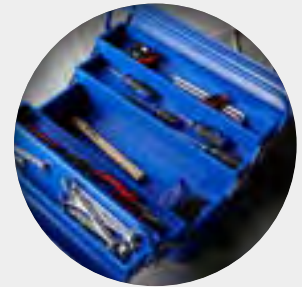

**40,- €**

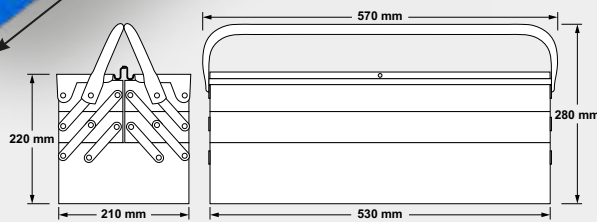

BT156916  
EAN 4042146867976  
Universal funnel set

**3  
pcs.**

Ø 160 mm / 1 L

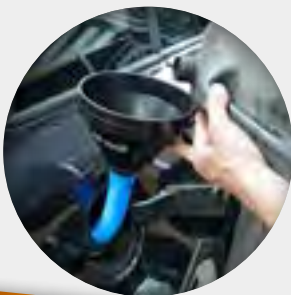
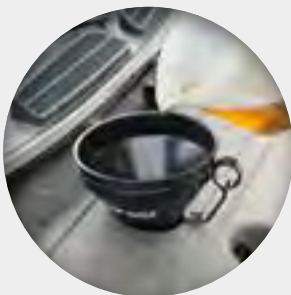

**9,- €**

**2in1**

BT130910  
EAN 4042146851890  
2 in 1 COB torch with  
140 lumen



**40  
LUMEN**

**6,- €**

**140  
LUMEN**

168 mm

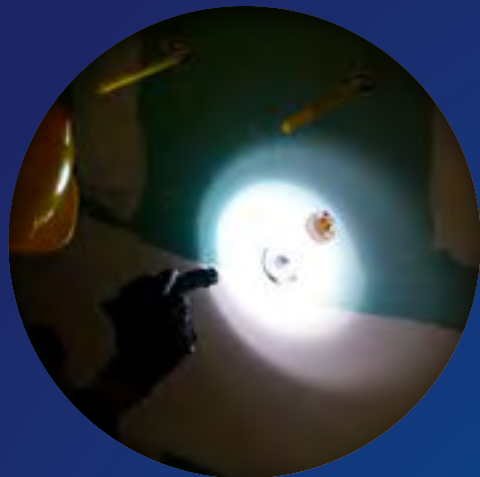

**On  
Off**



3 x AAA



Ø 25 mm



WORKSHOP EQUIPMENT

BT150900  
 EAN 4042146769942  
 Service cart



**BT152900**  
**EAN 4042146829882**

Tool cabinet with  
7 drawers, empty



WITH CENTRAL LOCKING



WITH INDIVIDUAL DRAWER LOCKING

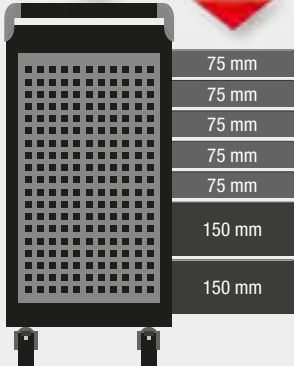

Drawer internal dimensions 5 x 528 x 398 x 75 mm  
2 x 528 x 398 x 150 mm

Ball-bearing

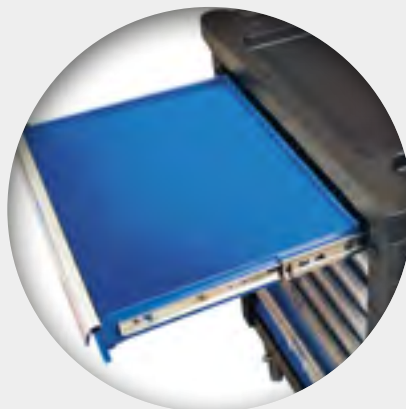

**389,- €**



**207**  
pcs.

BT153207  
EAN 4042146831878  
Tool cabinet with 7 drawers and 207 tools

# PROFESSIONAL WORKSHOP TROLLEY INCLUDING 207 PREMIUM TOOLS!

**449,- €**



**170**  
pcs.

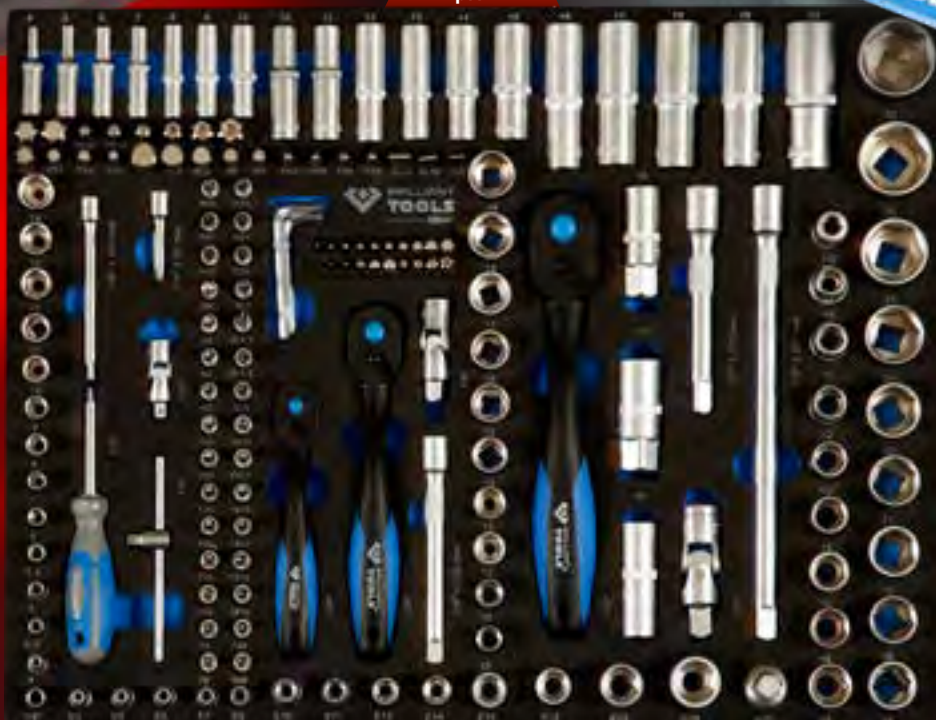

BT158170  
Sockets

**24**  
pcs.

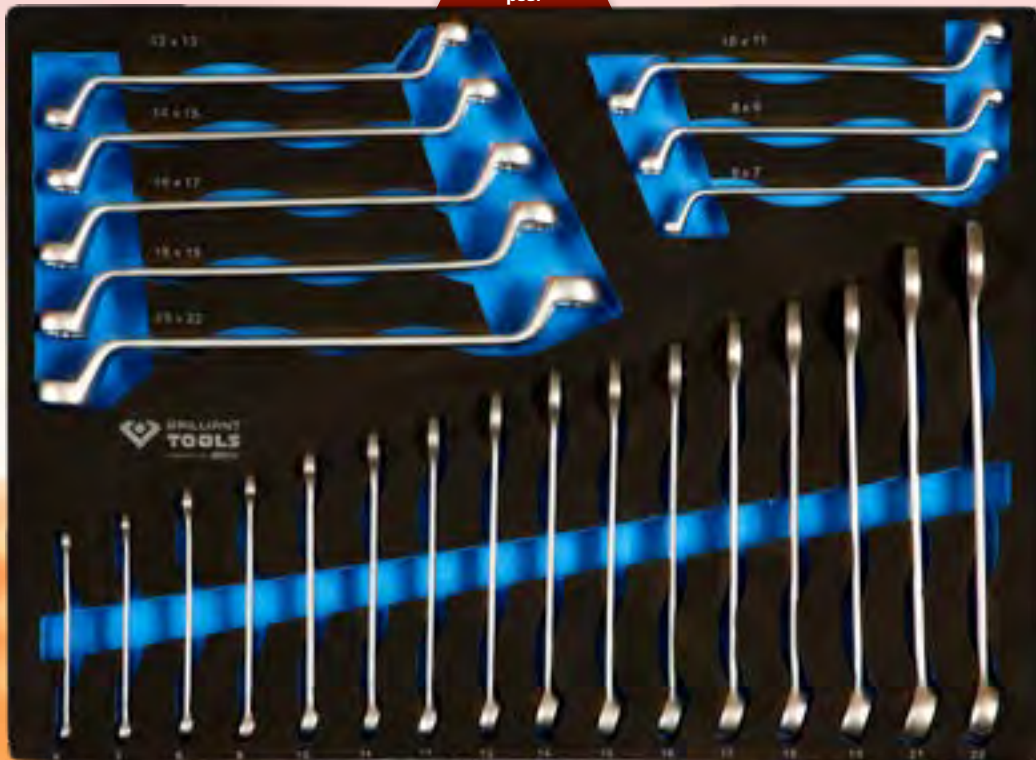

**BT158024**  
Combination and double-end ring spanner

**13**  
pcs.



**BT158013**  
Screwdrivers and pliers



# WORKSHOP EQUIPMENT

**BT153473**  
**EAN 4042146769942**  
 Tool cabinet with 7 drawers and 473 tools

**473**  
 pcs.

**BT053208**  
 Bit set

**208**  
 pcs.

**649,- €**

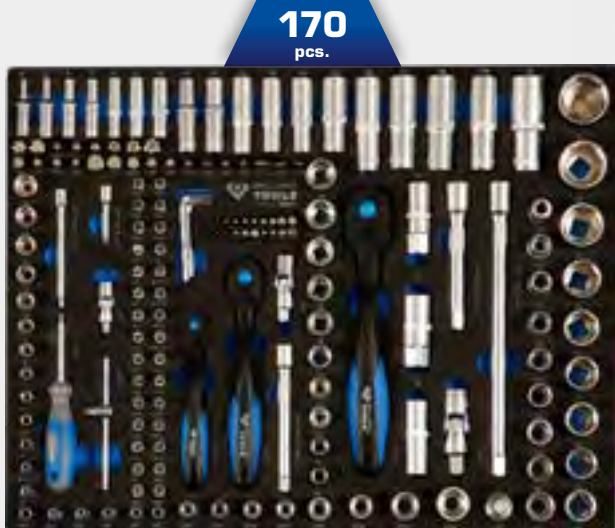

**170**  
 pcs.

**BT158170**  
 Sockets

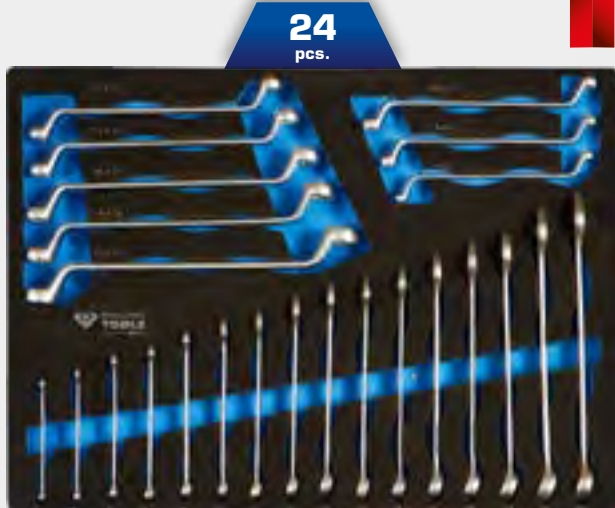

**24**  
 pcs.

**BT158024**  
 combination and double-end ring spanner



**Drawer internal dimensions**  
 5 x 528 x 398 x 75 mm  
 2 x 528 x 398 x 150 mm

**Ball-bearing** ✓





**18**  
pcs.

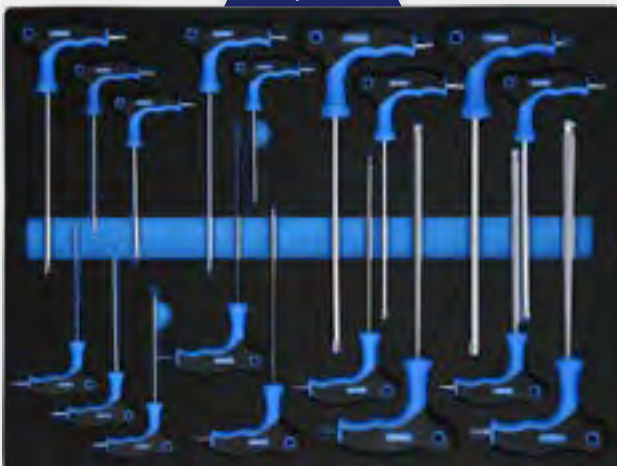

**BT158018**  
T-handle angled key wrench

**16**  
pcs.



**BT158016**  
Ratchet spanners



**21**  
pcs.



**BT158021**  
Screwdrivers

**16**  
pcs.



**BT159016**  
Inset with circlip pliers, pliers, hammer and chisel



170  
pcs.

BT158170  
EAN 4042146833193  
Inset with sockets

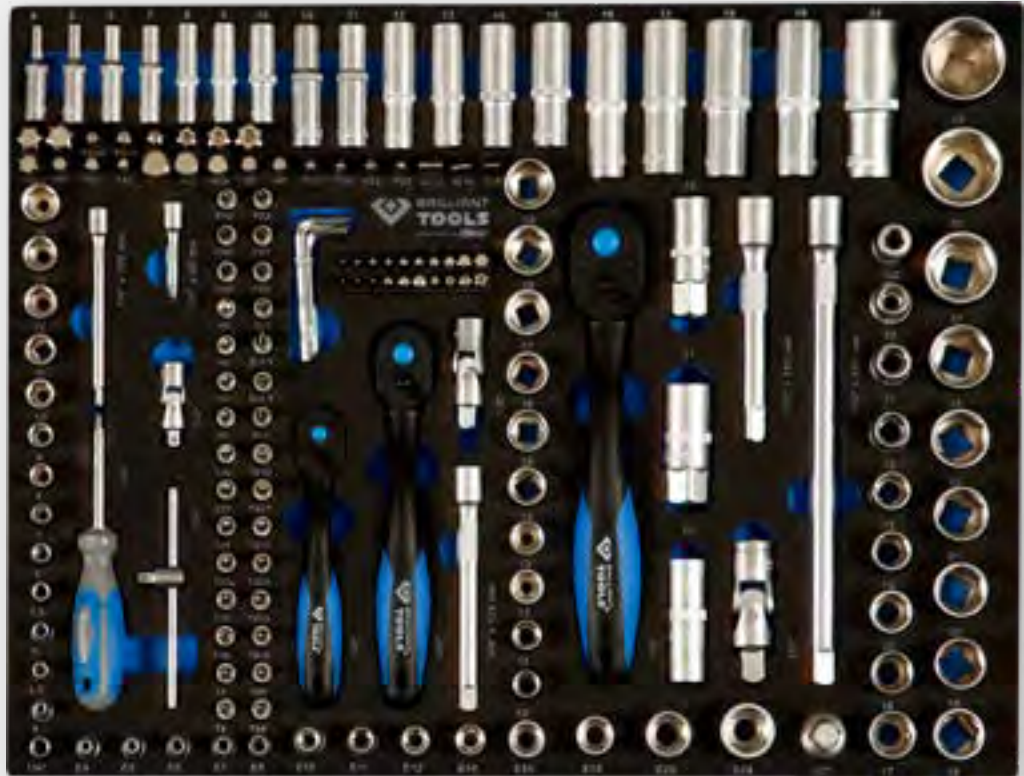

13x		4 • 4,5 • 5 • 5,5 • 6 • 7 • 8 • 9 • 10 • 11 • 12 • 13 • 14 mm	17x		10 • 11 • 12 • 13 • 14 • 15 • 16 • 17 • 18 • 19 • 20 • 21 • 22 • 24 • 27 • 30 • 32 mm
5x		E4 • E5 • E6 • E7 • E8	2x		E20 • E24
7x		4 • 5 • 6 • 7 • 8 • 9 • 10	5x		16 • 17 • 18 • 19 • 22 mm
2x		50 • 100 mm	2x		16 • 21 mm
8x		T8 • T9 • T10 • T15 • T20 • T25 • T27 • T30	2x		125 • 250 mm
8x		TB8 • TB9 • TB10 • TB15 • TB20 • TB25 • TB27 • TB30	1x		
3x		PH0 • PH1 • PH2	1x		75 mm
3x		PZ0 • PZ1 • PZ2	1x		44 mm
4x		3 • 4 • 5 • 6 mm	1x		250 mm
4x		4 • 5,5 • 6,5 • 7 mm	3x		M5 • M6 • M8
1x		40 mm	3x		T5 • T6 • T7
1x		150 mm	1x		TB7
1x		145 mm	5x		M5 • M6 • M7 • M8 • M9
1x		110 mm	8x		TS10 • TS15 • TS20 • TS25 • TS27 • TS30 • TS40 • TS45
10x		10 • 11 • 12 • 13 • 14 • 15 • 16 • 17 • 18 • 19 mm	6x		T40 • T45 • T50 • T55 • T60 • T70
6x		E10 • E11 • E12 • E14 • E16 • E18	6x		TB40 • TB45 • TB50 • TB55 • TB60 • TB70
6x		10 • 11 • 12 • 13 • 14 • 15 mm	5x		7 • 8 • 10 • 12 • 14 mm
1x		18 mm	2x		PH3 • PH4
1x		125 mm	2x		PZ3 • PZ4
1x		50 mm	3x		8 • 10 • 12 mm
1x		205 mm	7x		1,27 • 1,5 • 2 • 2,5 • 3 • 4 • 5 mm

**24**  
pcs.

**BT158024**  
**EAN 4042146833186**  
Inset with spanners

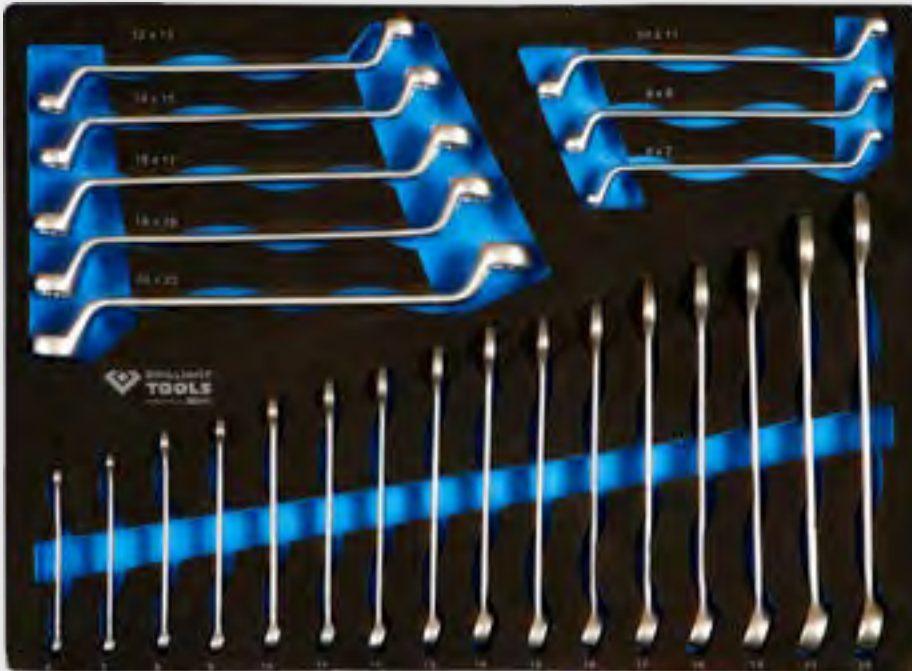

16x



6 • 7 • 8 • 9 • 10  
11 • 12 • 13 • 14  
15 • 16 • 17 • 18  
19 • 21 • 22 mm

8x



6x7 • 8x9 • 10x11  
12x13 • 14x15  
16x17 • 18x19  
20x22 mm



**13**  
pcs.

**BT158013**  
**EAN 4042146833179**  
Inset with screwdrivers, pliers



5x



2,0 • 3,0  
• 4,0 • 5,5  
• 6,5 mm

3x



PH0 • PH1  
• PH2

1x



180 mm

1x



180 mm

1x



200 mm

1x





250 mm



18  
pcs.



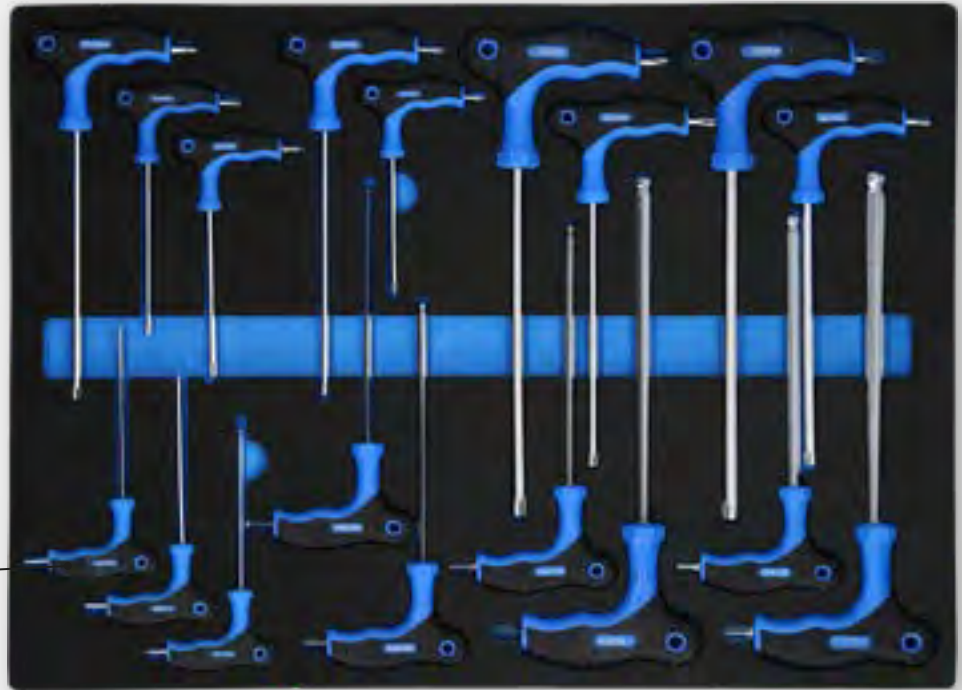
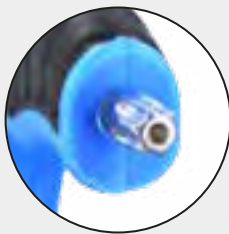

**BT158018**  
**EAN 4042146859131**  
Inset with angled key wrench

9x ⬢		2 • 2,5 • 3 • 4 • 5 • 6 • 7 • 8 • 10 mm
9x ⬢ ⬢		T10 • T15 • T20 • T25 • T27 • T30 • T40 • T45 • T 50



21  
pcs.

**BT158021**  
**EAN 4042146859148**  
Inset with screwdrivers

4x ⬢		3 x 100 • 5 x 7 • 6 x 100 • 8 x 150 mm
1x ⬢		5,5 x 38 mm
4x ⊕		PH0 x 100 • PH1 x 80 • PH2 x 100 • PH3 x 150 mm
1x ⊕		PH2 x 38 mm
11x ⬢		T6 • T7 • T8 • T9 • T10 • T15 • T20 • T25 x 100 mm  • T27 • T30 x 115 mm  • T40 x 150 mm

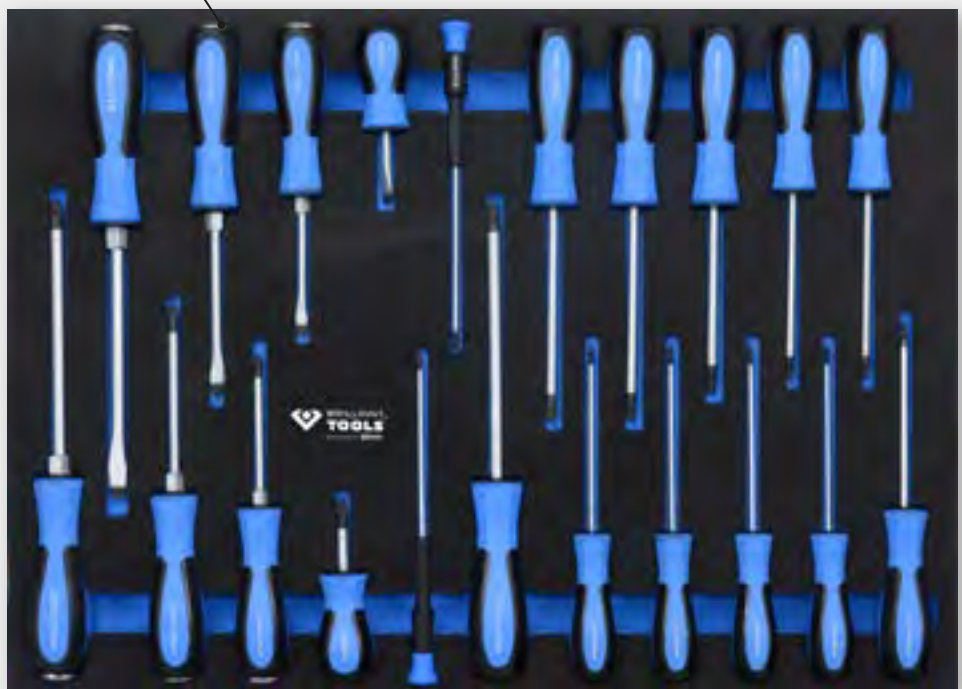

**16**  
pcs.

**BT158016**

**EAN 4042146858899**

Inset with ratchet spanners

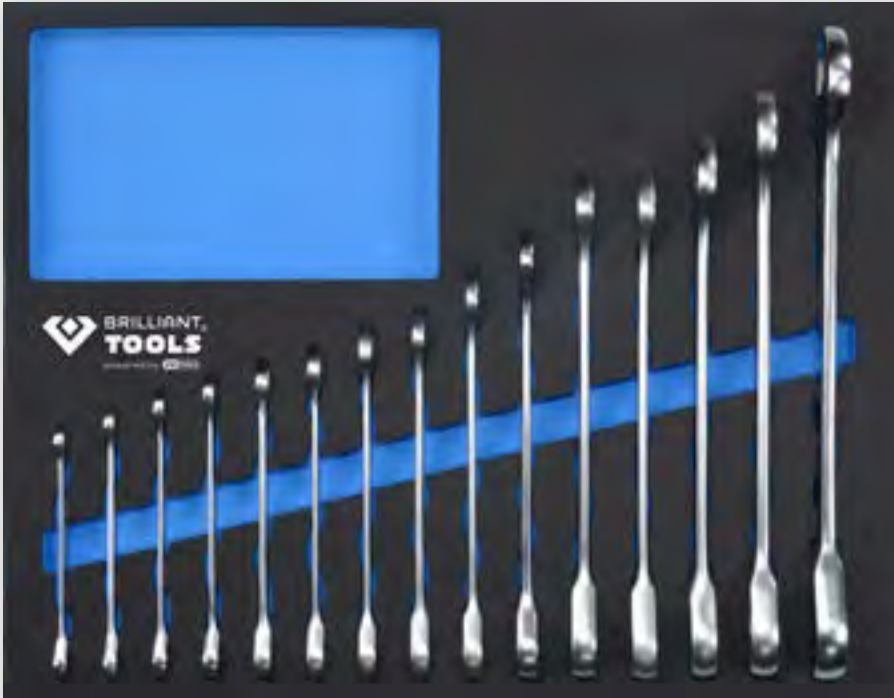

16x



8 • 9 • 10 • 11  
• 12 • 13 • 14  
• 15 • 17 • 19  
• 21 • 22 • 24  
• 27 • 30 mm



**16**  
pcs.

**BT159016**

**EAN 4042146859124**

Inset with circlip pliers, pliers,  
hammer and chisel



4x



125 mm

1x



180 mm

1x



180 mm

1x



200 mm

1x



250 mm

1x



300 g

6x



1,5 • 3 • 4 • 5  
• 6 • 8 mm

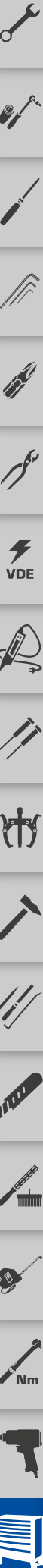



**WORK  
BRILLIANT**



BRILLIANT<sup>®</sup>  
**TOOLS**

powered by **KSTOOLS**



# AUTOMOTIVE SPECIAL TOOLS

CATALOG 2022

# CONTENTS



Page 218



Page 260

<b>Body</b> .....	<b>202</b>	<b>Spark plugs and glow plugs</b> .....	<b>246</b>
<b>Cooling</b> .....	<b>214</b>	<b>Auxiliary belts / Aluminator</b> .....	<b>250</b>
<b>Fuel system</b> .....	<b>224</b>	<b>Diagnostic tools</b> .....	<b>256</b>
<b>Cylinder head / Engine block</b> .....	<b>228</b>	<b>Exhaust system / Catalysts</b> .....	<b>262</b>
<b>Injection system</b> .....	<b>238</b>	<b>Transmission</b> .....	<b>266</b>



Page 236

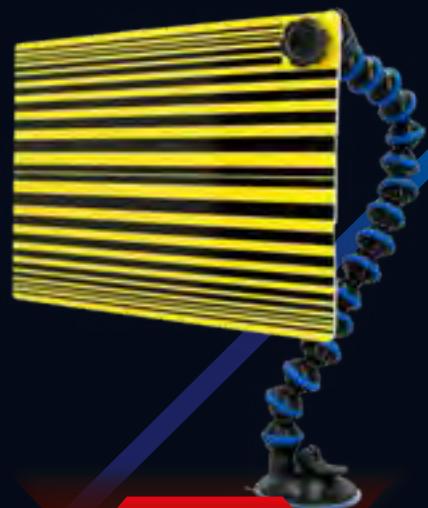

Page 203





**Page 306**



**Page 327**

<b>Clutch</b> .....	<b>268</b>	<b>Wheel and tyre mounting</b> .....	<b>298</b>
<b>Strut / Shock absorbers</b> .....	<b>272</b>	<b>Braking service</b> .....	<b>312</b>
<b>Steering</b> .....	<b>276</b>	<b>Oil service</b> .....	<b>320</b>
<b>Axis</b> .....	<b>280</b>	<b>Index</b> .....	<b>468</b>
<b>Car glass</b> .....	<b>294</b>		



**Page 261**



**Page 280**

## BODY

**BT511005**  
**EAN 4042146778791**

Extra long TORX® screwdriver set, 9 pcs

**9**  
pcs.

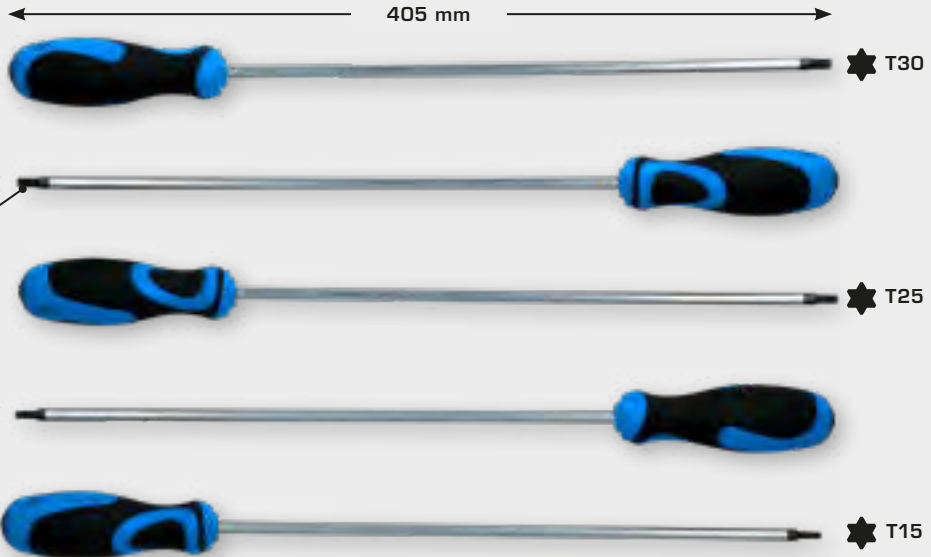

T15  
T20  
T25  
T27  
T30

**29,- €**

**BT101935**  
**EAN 4042146868683**  
Japan spatula set, plastic,  
4 pcs

**4**  
pcs.



**4,- €**

**BT101940**  
**EAN 4042146868690**  
Japan spatula set,  
metal, 4 pcs

**4**  
pcs.

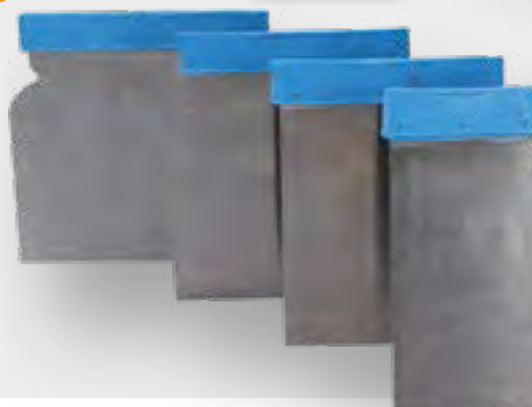

**4,- €**



**BT516000**  
**EAN 4042146778784**  
PDR Line board

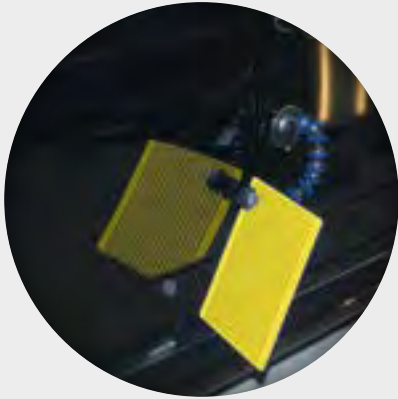

**14,- €**

**BT511000**  
**EAN 4042146778722**  
Universal lock out tool kit, 9 pcs

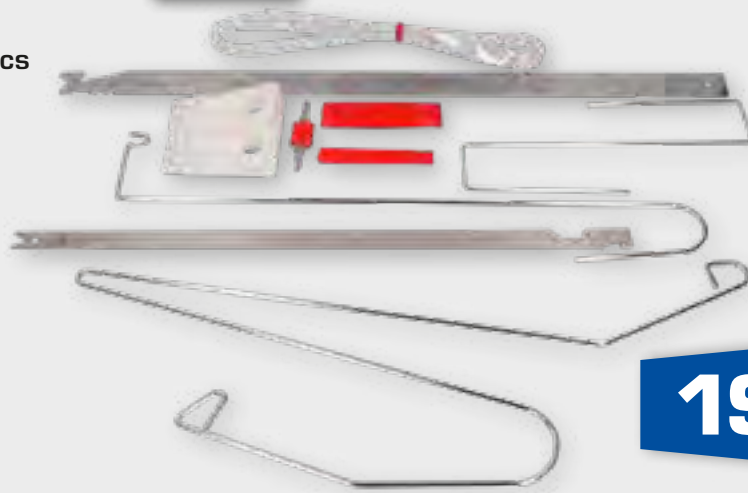
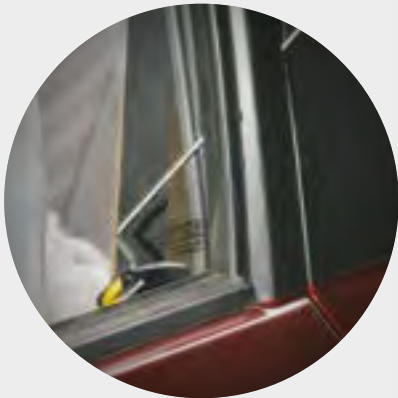

**9  
pcs.**

**19,- €**

**BT516002**  
**EAN 4042146778777**  
Welding point drill

U/min:  
600-670

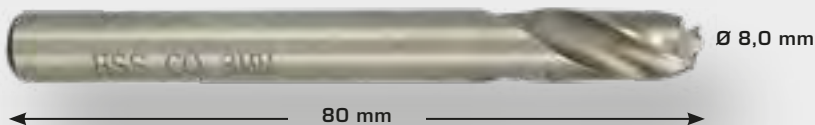

**HSS-Co**

**5,- €**

**BT516001**  
**EAN 4042146778760**  
Spot weld cutter

U/min:  
700-2000

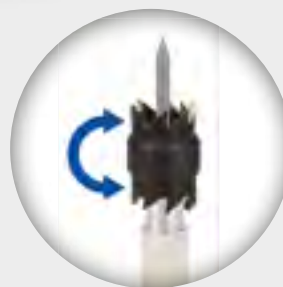

**5,- €**

**12**  
pcs.

Volkswagen | Audi | BMW | Mercedes  
Opel | Renault | Seat | Škoda

**BT511150**  
**EAN 4042146778753**  
Air bag removal tool set, 12 pcs

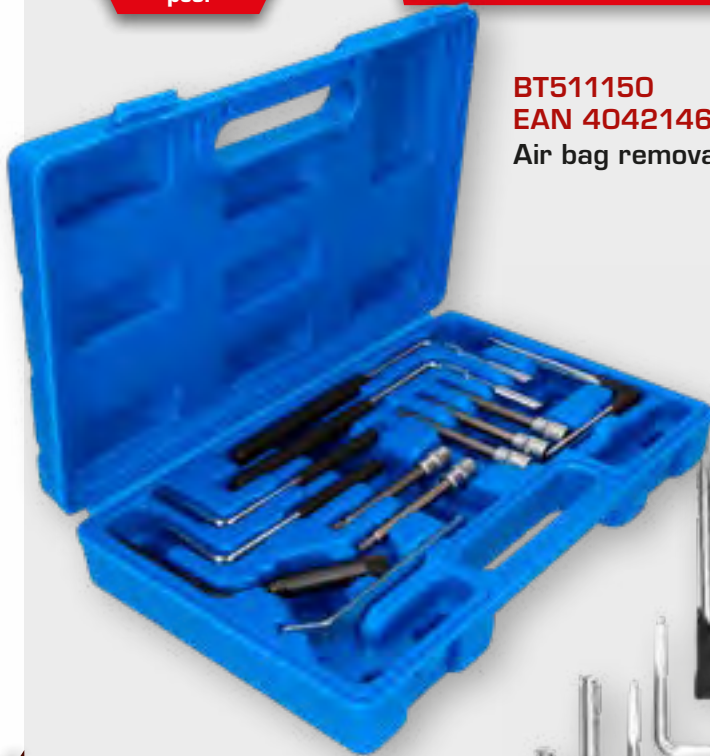
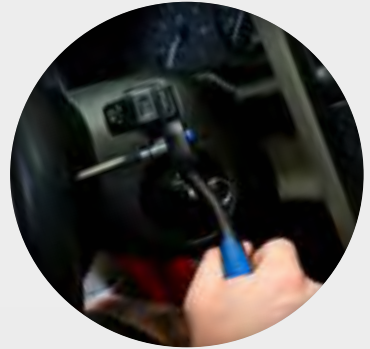

**22,- €**

**20**  
pcs.

Porsche | Mercedes | Audi | Ford  
BMW | Opel | VW | Škoda

**BT511200**  
**EAN 4042146778746**  
Radio removal tool set, 20 pcs

**9,- €**

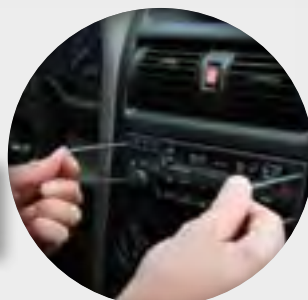

















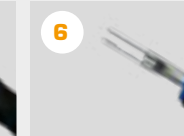

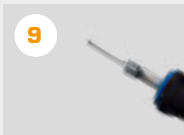

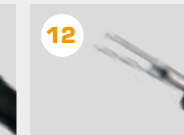

**23**  
pcs.

**BT511100**  
**EAN 4042146778821**

**Master terminal release tool kit, 23 pcs universal**

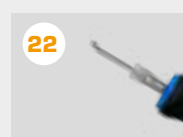

**84,- €**

<p><b>1</b></p>  <p>BMW, Mercedes, Audi/VW, Opel</p>	<p><b>2</b></p>  <p>BMW, Jaguar, Mercedes, Porsche, Saab, Seat, Sko</p>	<p><b>3</b></p>  <p>BMW, Mercedes, Opel, Porsche, VW/Audi</p>	<p><b>4</b></p>  <p>Ford</p>	<p><b>5</b></p>  <p>BMW, Ford, Mercedes, Opel, Porsche, Seat, Skoda, VW/Audi</p>	<p><b>6</b></p>  <p>BMW, Ford, Jaguar, Mercedes, Opel, Porsche, Seat, Skoda, VW/Audi</p>
<p><b>7</b></p>  <p>Mercedes</p>	<p><b>8</b></p>  <p>Ford, Jaguar, Mercedes, Opel, Porsche, VW/Audi</p>	<p><b>9</b></p>  <p>Ford, Mercedes</p>	<p><b>10</b></p>  <p>Mercedes</p>	<p><b>11</b></p>  <p>BMW, Ford, Jaguar, Mercedes, Opel, Porsche, Saab, Seat, Skoda, VW/Audi</p>	<p><b>12</b></p>  <p>Opel, Renault, Skoda, VW/Audi</p>
<p><b>13</b></p>  <p>Ford, Mercedes</p>	<p><b>14</b></p>  <p>Ford, Jaguar, Porsche</p>	<p><b>15</b></p>  <p>BMW, Ford, Mercedes, Opel, Seat, Skoda, VW/Audi</p>	<p><b>16</b></p>  <p>BMW, Ford, Jaguar, Mercedes, Opel, Porsche, VW/Audi</p>	<p><b>17</b></p>  <p>BMW</p>	<p><b>18</b></p>  <p>Mercedes</p>
<p><b>19</b></p>  <p>Citroën, Chrysler, Fiat, Ford, Honda, Mazda, Mercedes, Mitsubishi, Opel, Porsche, Renault, Seat, Toyota, VW/Audi</p>	<p><b>20</b></p>  <p>Ford</p>	<p><b>21</b></p>  <p>BMW, Ford, Jaguar, Mercedes, Opel, Porsche, Saab, Seat, Skoda, VW/Audi</p>	<p><b>22</b></p>  <p>Honda, Opel, Toyota, VW/Audi</p>	<p><b>23</b></p>  <p>Opel, VW/Audi</p>	

36  
pcs.

BT511230  
EAN 4042146867228  
Unlocking tool, 36 pcs

15,- €

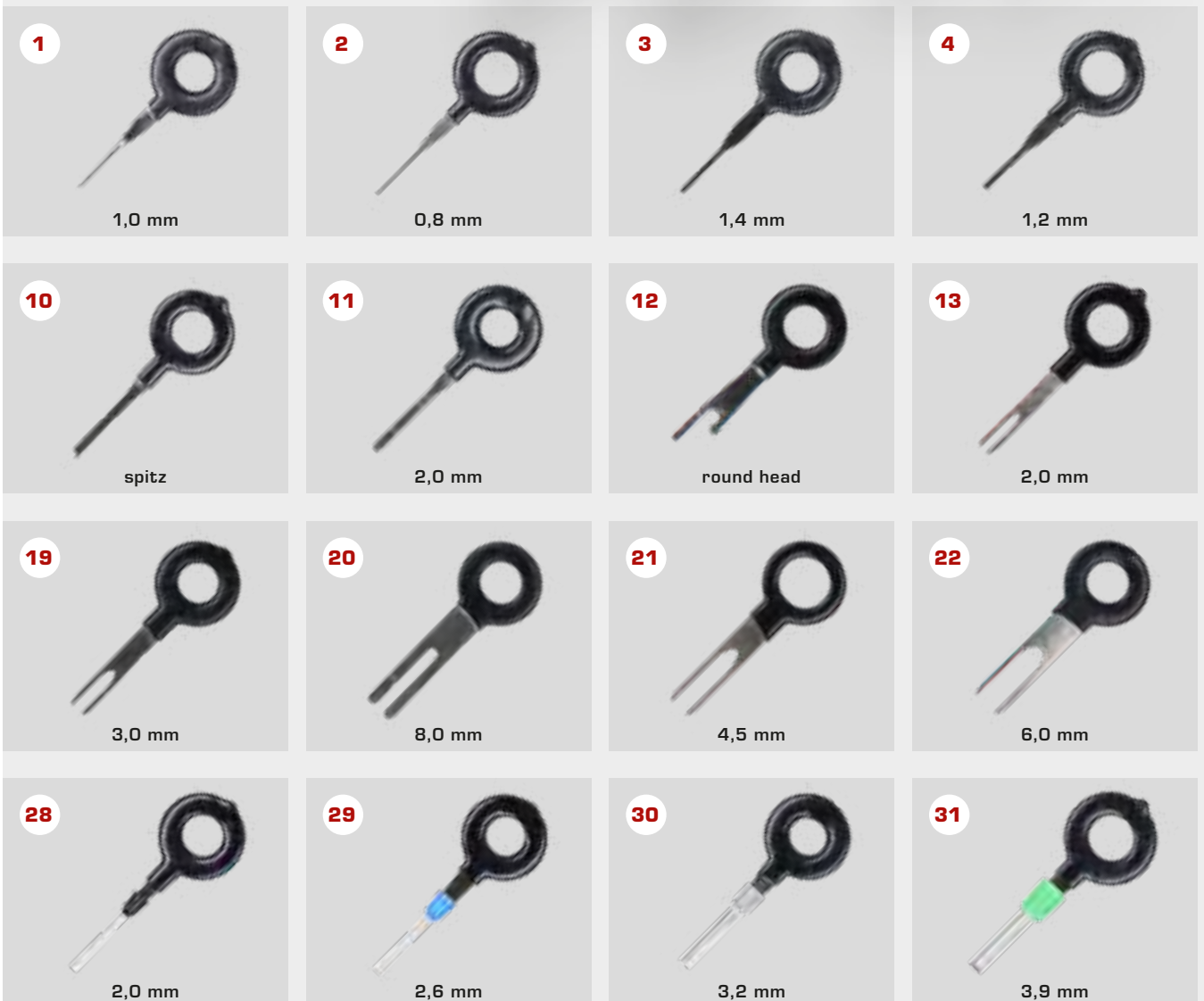



<p><b>5</b></p> <p>4,9 mm</p>	<p><b>6</b></p> <p>6,2 mm</p>	<p><b>7</b></p> <p>three needles</p>	<p><b>8</b></p> <p>three needles</p>	<p><b>9</b></p> <p>0,8 mm</p>
<p><b>14</b></p> <p>2,0 mm</p>	<p><b>15</b></p> <p>2,0 mm</p>	<p><b>16</b></p> <p>1,0 mm</p>	<p><b>17</b></p> <p>0,8 mm</p>	<p><b>18</b></p> <p>3,0 mm</p>
<p><b>23</b></p> <p>1,0 mm</p>	<p><b>24</b></p> <p>1,4 mm</p>	<p><b>25</b></p> <p>1,4 mm</p>	<p><b>26</b></p> <p>1,4 mm</p>	<p><b>27</b></p> <p>8,0 mm</p>
<p><b>32</b></p> <p>8,0 mm</p>	<p><b>33</b></p> <p>Spitz</p>	<p><b>34</b></p> <p>6,0 mm</p>	<p><b>35</b></p> <p>4,5 mm</p>	<p><b>36</b></p> <p>3,0 mm</p>

**BT516003**  
**EAN 4042146778708**  
 Clip removal plier

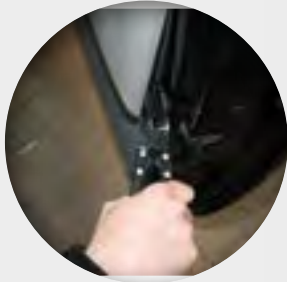

**13,- €**

**BT516010**  
**EAN 4042146813423**  
 Set of compressed cushions, 4 pcs

**4**  
 pcs.

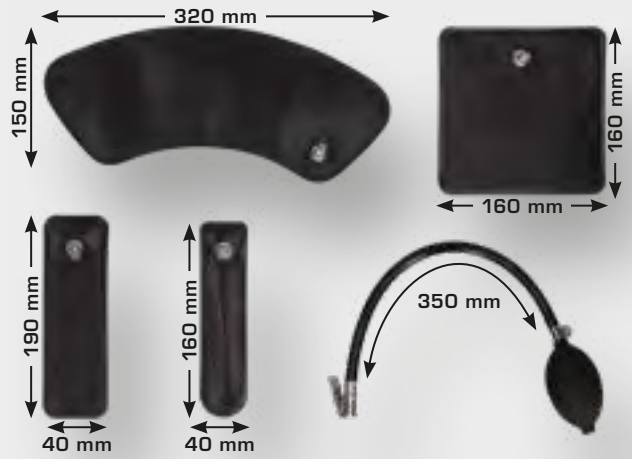

**49,- €**

**6**  
 pcs.

4 + 8 + 10 mm

**BT511045**  
**EAN 4042146778715**  
 Panel/trim removal tool set,  
 6 pcs

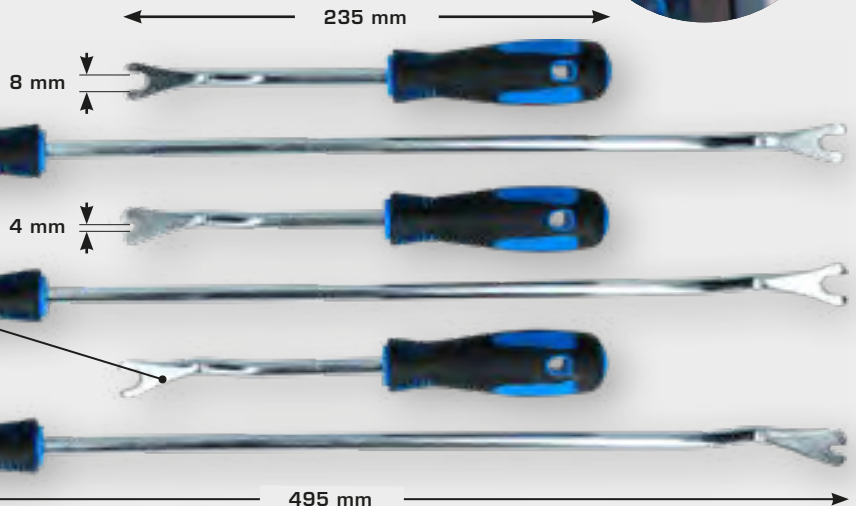
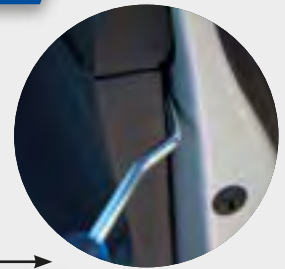

10 mm

**25,- €**





**BT511035**  
**EAN 4042146778678**  
Trim removal set, 5 pcs

**5**  
pcs.

**10,- €**

**BT511025**  
**EAN 4042146778685**  
Trim removal set, 6 pcs

**6**  
pcs.

**11,- €**

**BT511015**  
**EAN 4042146778739**  
Trim and removal set, 6 pcs

**6**  
pcs.

**15,- €**

11  
pcs.

BT511065  
EAN 4042146778661  
Trim removal set, 11 pcs

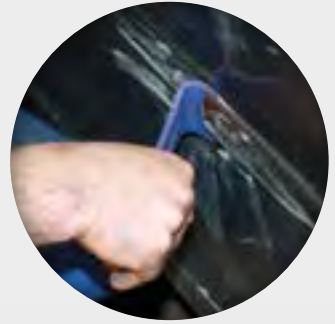

22,- €



12  
pcs.

BT511075  
EAN 4042146778814  
Trim remover kit, 12 pcs

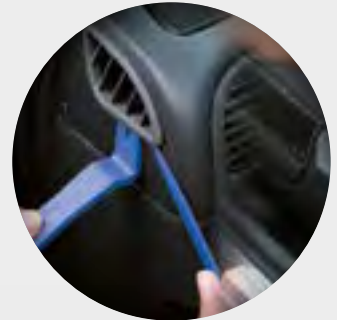

22,- €





**27**  
pcs.



BT511055  
EAN 4042146778692  
Trim removal set, 27 pcs



**34,- €**

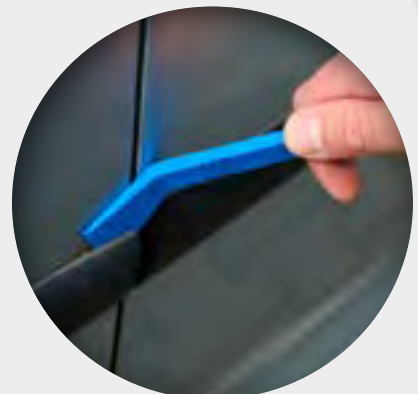

5  
pcs.

BT511080  
EAN 4042146866788  
Panel lever and cutting set, 5 pcs



40,- €

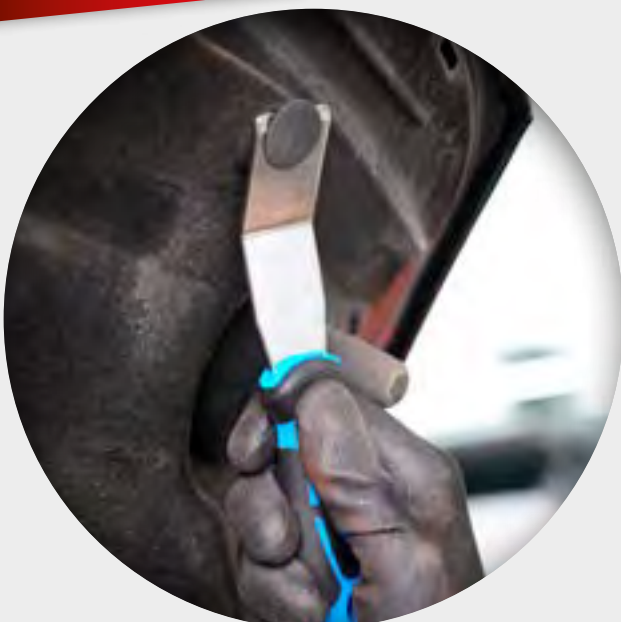



**6**  
pcs.

**BT511130**  
**EAN 4042146844724**  
Pneumatic vacuum cleaner, 6 pcs



**37,- €**

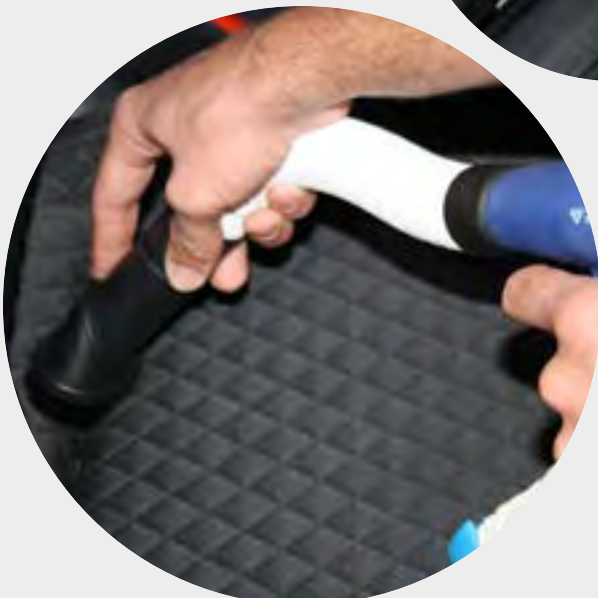
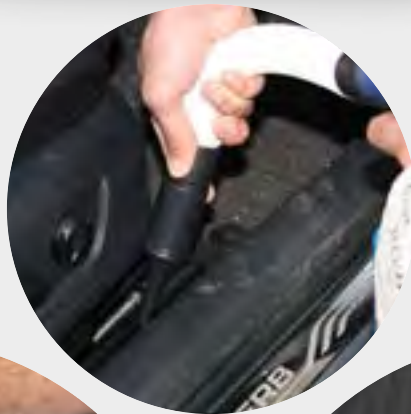

COOLING

-50 - 500°C

**BT521030**  
**EAN 4042146867259**  
 Infrared thermometer, -50°-500°

**29,- €**



**BATTERY INCLUSIVE**  
 2 X 1,5 V AAA

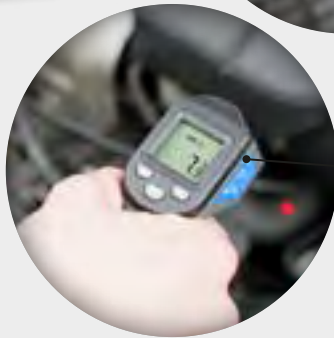

**BT536010**  
**EAN 4042146864340**  
 Refractometer



**34,- €**

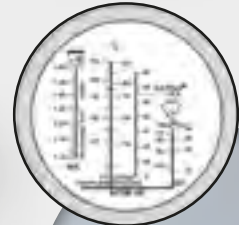
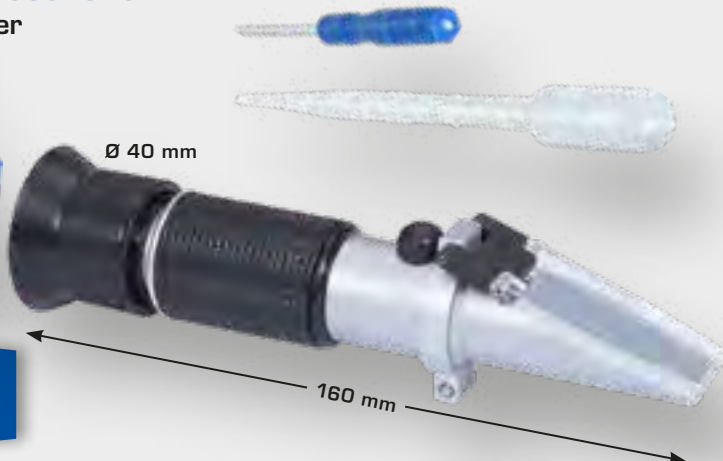

VAG

1/2"

**BT526007**  
**EAN 4042146778999**  
 Audi/VW Belt pulley reaction wrench

**15,- €**





**11**  
pcs.

BMW | Ford | Mercedes

**BT521250**  
**EAN 4042146778890**

Mercedes & BMW Fan clutch tool set, 11 pcs



**89,- €**

**3**  
pcs.

Volkswagen T5 | Touareg 2,5 L Diesel

**BT521300**  
**EAN 4042146778845**

water pump removal tool for Volkswagen

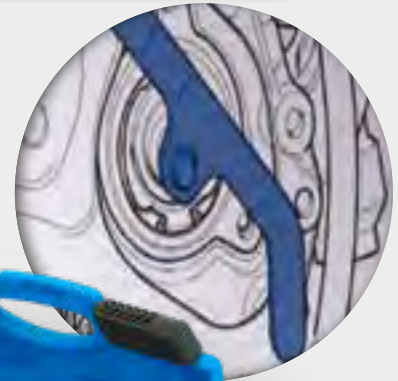

**59,- €**

## COOLING

Alfa Romeo | Chevrolet | Opel | Saab

**BT526008**  
**EAN 4042146778838**  
 Petrol engine coolant  
 pump sprocket,  
 Retainer -  
 Vauxhall/Opel  
 2.2-chain  
 drive



**29,- €**

Opel

**BT526009**  
**EAN 4042146822517**  
 water pump wheel  
 holding tool for Opel  
 Ecotec engines



**29,- €**

**2**  
 pcs.



**BT521100**  
**EAN 4042146778876**  
 Cooling system vacuum  
 purge & refill kit, 2 pcs



**69,- €**

**6**  
 pcs.



**BT521050**  
**EAN 4042146778883**  
 Cooling system vacuum  
 purge & refill kit, 6 pcs

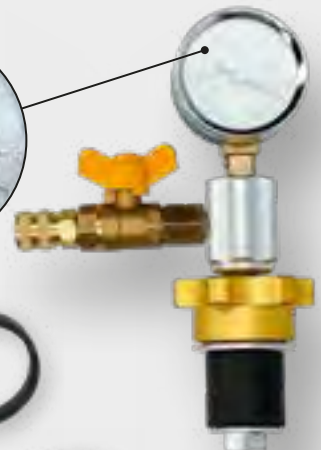

**79,- €**





**18**  
pcs.

**BT521200**  
**EAN 4042146778852**  
**Water tank leak detector, 18 pcs**



**129,- €**

**Anwendungsliste**

	R123, R124		Alfa Romeo, Citroen, Fiat, Mini Cooper, Peugeot, Renault, Saab, Sterling, Jeep, Volvo		Mercedes Benz (C-, E, S-Class), W140, W124, W210, W211, W215, W216, W220, R230
	R123, R125		Alfa Romeo, Citroen, Fiat, Mini Cooper, Peugeot, Renault, Saab, Sterling, Jeep, Volvo		Ford Mondeo, Focus, C-Max
	Mercedes Benz W123, W 126, W124, W201, Buick, Chrysler, Chevrolet, Dodge, Jeep, Oldsmobile, Pontiac		Audi A4, A5, A6, BMW 345, VW Passat 1997-2002, Porsche Cayenne		Mazda (M3)
	Acura, Chevrolet, Chrysler, Dodge, Ford, GM, Honda, Hyundai, Infiniti, Isuzu, Kia, Lexus, Mazda, Mercury, Mitsubishi, Mercedes Benz, Nissan, Subaru, Suzuki, Peugeot, Toyota		BMW E32, E34, E36, E38, E39, E46, E90		0 - 200° C 30 - 400° F
	Acura, Chevrolet, Dodge, Eagle, Honda, Lexus, Mercedes Benz M-Class, Mitsubishi, Suzuki, Toyota		Audi 1975-1993, VW 1975-1993		0 - 2,5 Bar 0 - 36 PSI
	Cadillac, Daewoo, Ford, GM, Jaguar, Jeep, Land Rover, Mercedes Benz, Mercury, Pontiac, Porsche, Saab, Saturn		Ford Mondeo, International, Land Rover, Opel, Ssangyong		

COOLING

28  
pcs.

**BT521150**  
**EAN 4042146778869**

Master cooling radiator  
pressure tester with  
vacuum purge and  
refill kit,  
28 pcs



**199,- €**

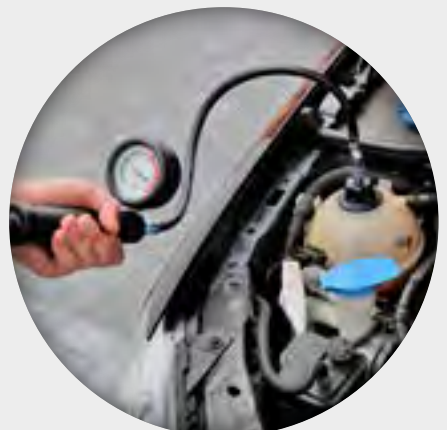
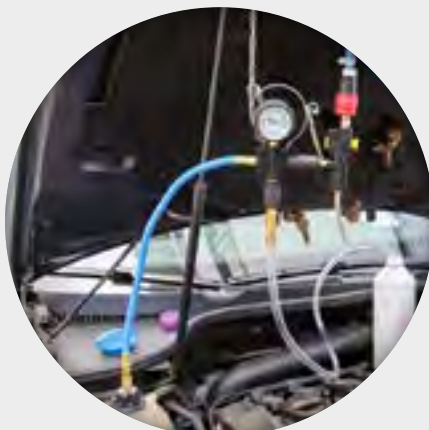



### Anwendungsliste

	Cooling system filling tube with suction head, 1 600 mm		Audi A4, A5, A6, BMW 345, VW Passat 1997-2002, Porsche Cayenne		VW Sharan 1,8T, 2,8
	R123, R124		BMW E32, E34, E36, E38, E39, E46, E90		Toyota Celica, RAV4, Previa, MR2
	R123, R125		Audi 1975-1993, VW 1975-1993		Saab
	Mercedes Benz W123, W 126, W124, W201, Buick, Chrysler, Chevrolet, Dodge, Jeep, Oldsmobile, Pontiac		Ford Mondeo, International, Land Rover, Opel, Ssangyong		Opel, Fiat, Chevrolet, Buick, Cadillac, Ford (USA), Saab, GMC, Suzuki, Vauxhall, Mazda, Lincoln, Oldsmobile, Isuzu, Hummer
	Acura, Chevrolet, Chrysler, Dodge, Ford, GM, Honda, Hyundai, Infiniti, Isuzu, Kia, Lexus, Mazda, Mercury, Mitsubishi, Mercedes Benz, Nissan, Subaru, Suzuki, Peugeot, Toyota		Mercedes Benz (C-, E, S-Class), W140, W124, W210, W211, W215, W216, W220, R230		BMW, Land Rover, Mini
	Acura, Chevrolet, Dodge, Eagle, Honda, Lexus, Mercedes Benz M-Class, Mitsubishi, Suzuki, Toyota		Ford Mondeo, Focus, C-Max		Cooling system vacuum filling unit / manometer to 76cmHG
	Cadillac, Daewoo, Ford, GM, Jaguar, Jeep, Land Rover, Mercedes Benz, Mercury, Pontiac, Porsche, Saab, Saturn		Mazda (M3)		0 - 200° C 30 - 400° F
	Alfa Romeo, Citroen, Fiat, Mini Cooper, Peugeot, Renault, Saab, Sterling, Jeep, Volvo		Mercedes Benz A-Class, W168, Vito		0 - 2.5 Bar 0 - 36 PSI
	Alfa Romeo, Citroen, Fiat, Mini Cooper, Peugeot, Renault, Saab, Sterling, Jeep, Volvo		BMW E60, E63, E64, E65		 

## COOLING

Ø 0 - 70 mm

**BT526000**  
**EAN 4042146778920**  
Hose clamp plier

**11,- €**



Ø 0 - 48 mm

**BT526001**  
**EAN 4042146778937**  
Hose clamp plier

**9,- €**



Ø 0 - 65 mm

**BT526002**  
**EAN 4042146778944**  
Hose clamp plier

**9,- €**



Ø 0 - 45 mm

**BT526006**  
**EAN 4042146778913**  
Hose clamp plier

**9,- €**



Ø 0 - 38 mm

**BT526003**  
**EAN 4042146778951**  
Hose clamp plier,  
forged

**12,- €**





Ø 0 - 30 mm

**BT526004**  
**EAN 4042146778968**  
Hose clamp plier

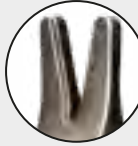

**8,- €**

Ø 0 - 70 mm

**BT526005**  
**EAN 4042146778975**  
Hose clamp plier with bowdengrip

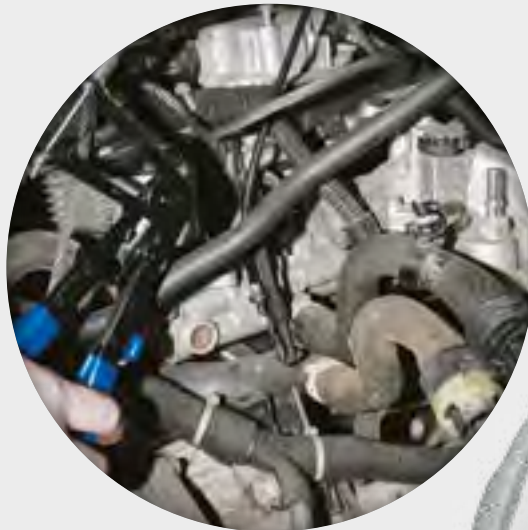

**20,- €**

BT521000  
EAN 4042146778906  
Hose clamp plier set, 9 pcs

9  
pcs.

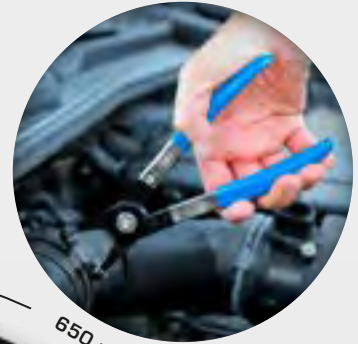

650 mm

83,- €



**3**  
pcs.

Ø 15 - 60 mm

**BT521010**  
**EAN 4042146778982**

Flexible hose clamps set, straight, 3 pcs

max. Ø 60 mm



max. Ø 30 mm

max. Ø 15 mm



**13,- €**

**3**  
pcs.

Ø 15 - 60mm

**BT521015**  
**EAN 4042146779019**

Hose clamp pliers set, 90° angle, 3 pcs

max. Ø 60 mm

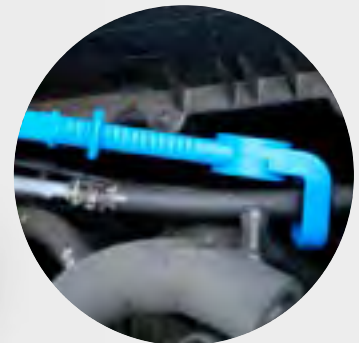

max. Ø 30 mm

max. Ø 15 mm



**15,- €**

## FUEL SYSTEM

BT536004  
EAN 4042146779101  
Fuel feed pipe plier

Ø 0 - 105 mm

VAG, Fiat, GM, Opel,  
Vauxall, Mercedes Benz

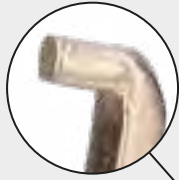

13,- €

BT536001  
EAN 4042146779064  
Fuel line unlocking tool for Ford

2  
pcs.

Ford, GM

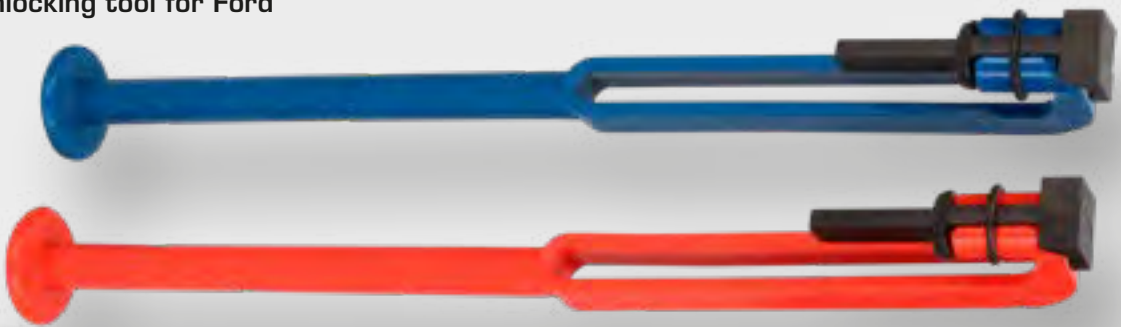

19,- €

BT531000  
EAN 4042146779071  
Fuel line unlocking pliers set, 3 pcs

3  
pcs.

Audi, Citroen, Fiat, Ford GM, Mercedes,  
Peugeot, Opel, Renault, Volkswagen

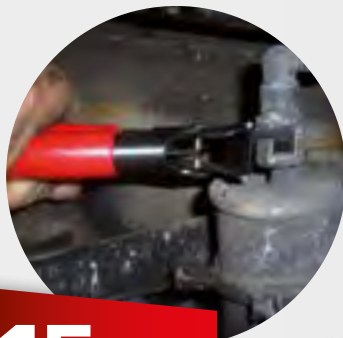

15,- €





**22**  
pcs.

**BT531050**  
**EAN 4042146779088**  
Conditioning disconnection  
tool set fuel air, 22 pcs



5/16"    5/16"    3/8"    1/2"    5/8"    3/4"    7/8"    5/16" x 3/8"



7/8"    5/8"    1/2"    3/8"    3/8"    5/16"    1/4"



5/16"    3/4"    1/2"    5/8"    3/8"

**56,- €**

**2**  
pcs.

Alfa Romeo, Chevrolet, Citroen, Fiat,  
Lancia, Peugeot, Opel, Saab, Suzuki

**BT536000**  
**EAN 4042146779033**  
Fuel filter tool set for JTD  
engines, 2 pcs

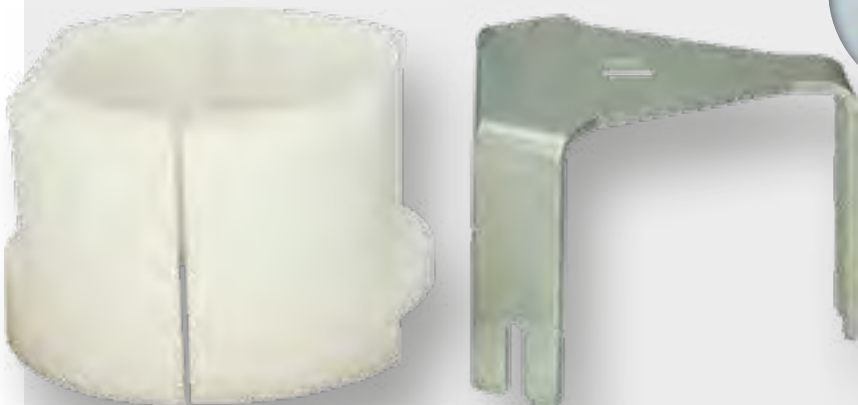

**17,- €**

## FUEL SYSTEM

**BT536008**  
**EAN 4042146779040**  
 Fuel tank sender  
 spanner, 2 leg

Ø 80 - 120 mm

**15,- €**



**BT536007**  
**EAN 4042146779057**  
 Fuel tank sender spanner,  
 3 leg

Ø 75 - 160 mm

**19,- €**



**BT536006**  
**EAN 4042146779118**  
 Universal fuel sender lid  
 remover and installer

Ø 87 - 170 mm

**29,- €**



**BT536009**  
**EAN 4042146813393**  
 Tank filler wrench for BMW

1/2"  
 12,5 mm

BMW

**57,- €**





**BT531150**  
**EAN 4042146779026**  
Diesel fuel pump  
timing set

**10**  
pcs.

Bosch VE, Kikki, Lucas,  
CAV-Roto, Nippon Denso



**83,- €**

**BT581200**  
**EAN 4042146779590**  
Fuel synchronisation kit,  
26 pcs

**26**  
pcs.

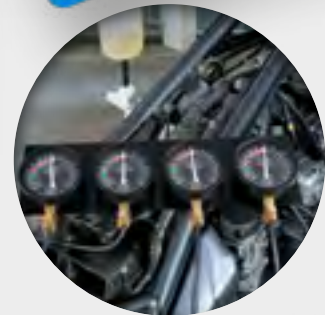

**169,- €**

## CYLINDER HEAD / ENGINE BLOCK

**BT541061**  
**EAN 4042146845714**  
Bit insert, length 54 mm,  
12.5 mm square drive for VAG Polydrive®

1/2"  
12,5 mm

VAG



4,- €

# EVERYTHING FOR THE DRIVE

**BT546001**  
**EAN4042146779217**  
Torque angle gauge

1/2"  
12,5 mm

0 - 360°

Ø 100 mm



10,- €

Ø 3,2 • 4,8 • 6,4 • 8,0 • 8,7 mm

**25**  
pcs.

**BT541900**  
**EAN 4042146779248**

Screw extractor / drill and guide kit, 25 pcs

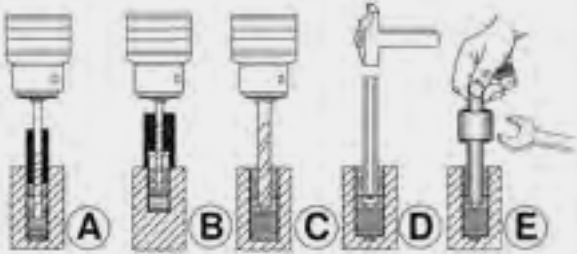

5x		3,2 • 4,8 • 6,4 • 8,0 • 8,7 mm
5x		3,2 • 4,8 • 6,4 • 8,0 • 8,7 mm
10x		4 x 3,2 • 4 x 4,8 • 2 x 6,4 mm
5x		3,2 • 4,8 • 6,4 • 8,0 • 8,7 mm

**32,50** €

**BT542000**  
**EAN 4042146779255**

Stud removal & installer set, 9 pcs

**9**  
pcs.

M6 x 1,0 • M8 x 1,25  
M10 x 1,25 • M10 x 1,5

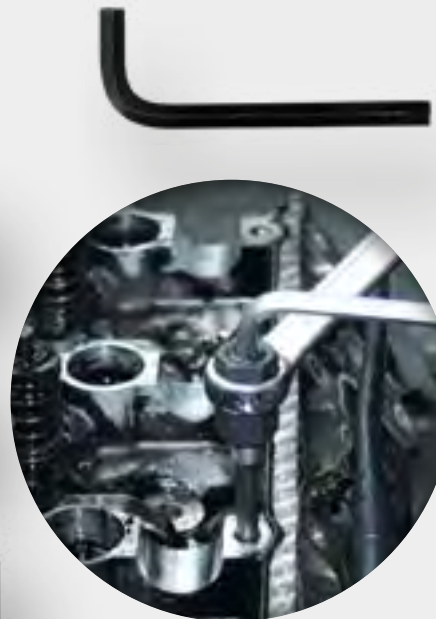

**28,-** €

CYLINDER HEAD / ENGINE BLOCK

**146**  
pcs.

21,5 - 64 mm

BT541150

EAN 4042146779224

Thread repair set, 146 pcs



**89,- €**

<b>5x</b>		• M5 x 0,8 mm • M6 x 1,0 mm • M8 x 1,25mm • M10 x 1,5 mm • M12 x 1,75 mm	<b>25x</b>		M5 x 0,8 mm
<b>5x</b>		• M5 x 0,8 mm • M6 x 1,0 mm • M8 x 1,25 mm • M10 x 1,5 mm • M12 x 1,75 mm	<b>25x</b>		M6 x 1,0 mm
<b>5x</b>		• M5 x 0,8 mm • M6 x 1,0 mm • M8 x 1,25 mm • M10 x 1,5 mm • M12 x 1,75 mm	<b>25x</b>		M8 x 1,25 mm
<b>5x</b>		• M5 x 0,8 mm • M6 x 1,0 mm • M8 x 1,25 mm • M10 x 1,5 mm • M12 x 1,75 mm	<b>25x</b>		M10 x 1,5 mm
			<b>25x</b>		M12 x 1,75 mm
			<b>1x</b>		-

**SO YOU GET  
THE HANG OF IT**



**9  
pcs.**

**BT541050**  
**EAN 4042146779125**  
Valve spring compressor set, 9 pcs

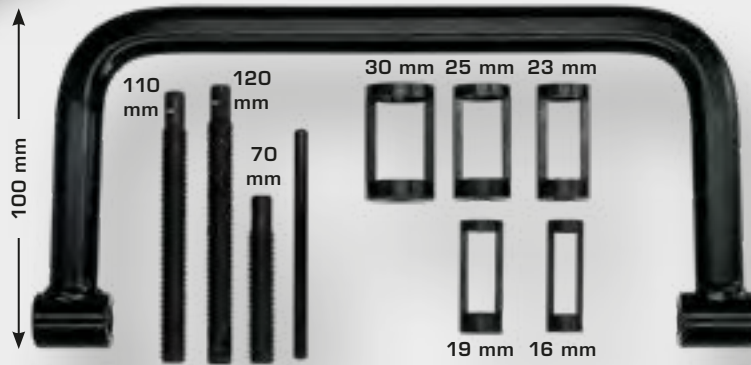
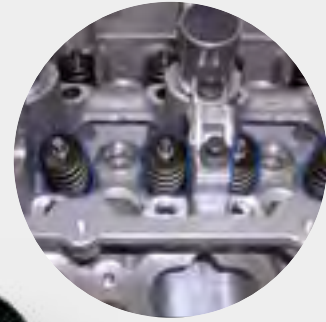

**31,- €**



**11  
pcs.**

**BT541100**  
**EAN 4042146779132**  
Valve stem seal assembly and disassembly tool set, 11 pcs



**38,- €**

## CYLINDER HEAD / ENGINE BLOCK

**BT541070**  
**EAN 4042146813188**  
Pneumatic valve spring assembly tool  
set, 8 pcs

**8**  
pcs.



**125,- €**



**BT546000**  
**EAN 4042146779149**  
Double cup valve grinder set, 2 pcs

**2**  
pcs.

**5,- €**

Ø 21 mm



Ø 16 mm

Ø 34 mm



Ø 28 mm



**BT541060**  
**EAN 4042146845721**  
camshaft assembly tool for  
BMW N53, N54

**6**  
pcs.

**BMW N53, N54**

**125,- €**





**BMW N51, N52**

**BT541120**  
**EAN 4042146822005**  
camshaft assembly tool  
for BMW N51, N52

**249,- €**



**6**  
pcs.

**BT541080**  
**EAN 4042146844731**  
Camshaft sprocket puller set,  
6 pcs

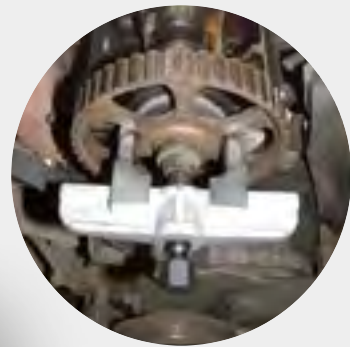
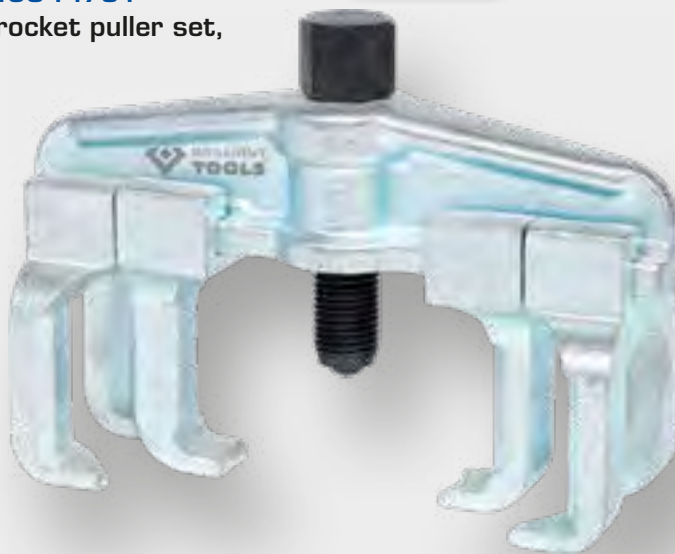

**67,- €**

**VAG 2.0 TFSI**

**BT546003**  
**EAN 4042146845738**  
crankshaft radial seal  
assembly tool for VAG 2.0  
TFSI



**7,- €**

**8360.46/f3a/f3b**

**BT541062**  
**EAN 4042146845776**  
crankshaft lathe tool for Iveco

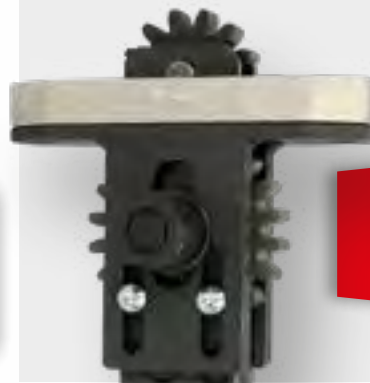

**99,- €**

## CYLINDER HEAD / ENGINE BLOCK

**BT542025**  
**EAN 4042146866726**  
Scrapers set, 3 pcs

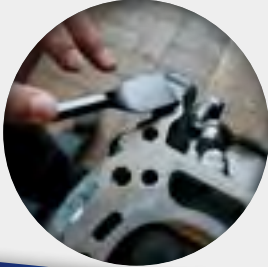

**3**  
pcs.

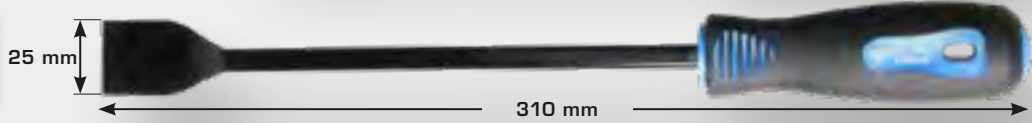
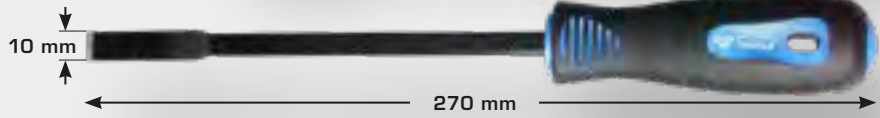

**17,- €**

**BT546002**  
**EAN 4042146779187**  
Seal puller

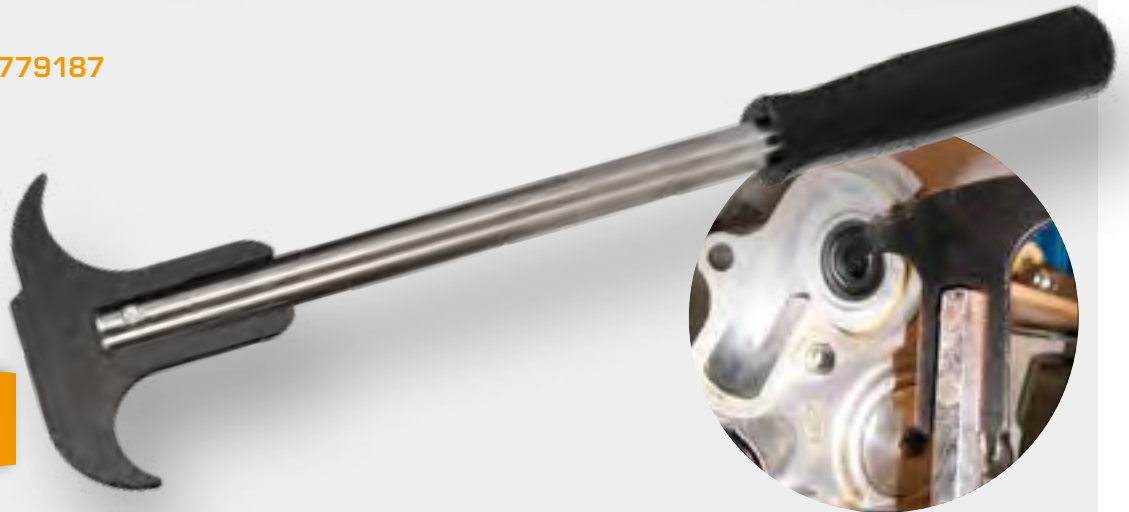

**8,- €**

**BT542020**  
**EAN 4042146779194**  
Mini pick and hook set,  
4 pcs

**4**  
pcs.

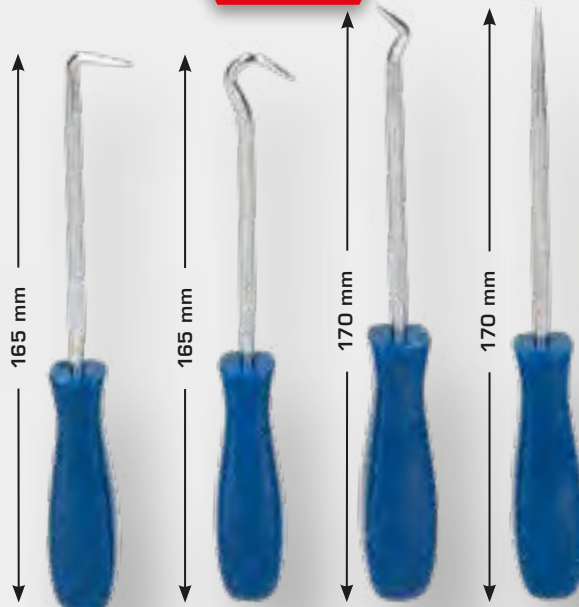

**5,- €**



**9**  
pcs.

**BT542010**  
**EAN 4042146779200**

Scraper, hook & pick set, 9 pcs



**19,- €**

**7**  
pcs.

**BT542060**  
**EAN 4042146779170**

Seal remover & hose pick it, 7 pcs



**45,- €**

# CYLINDER HEAD / ENGINE BLOCK

**BT542070**  
**EAN 4042146845745**  
crank/camshaft radial seal extraction  
set for VAG

**7**  
pcs.

VAG



**189,- €**





Ø 21,5 - 64 mm

**24**  
pcs.

**BT542030**  
**EAN 4042146779163**  
Crank seal remover and installer  
kit, 24 pcs



**80,- €**

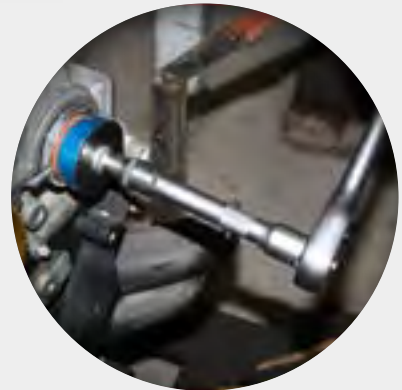
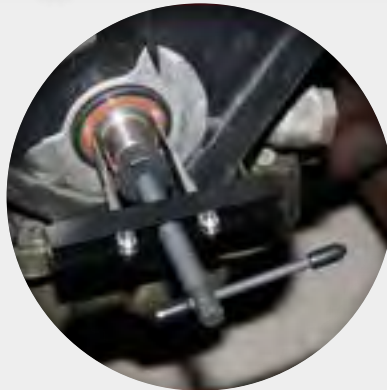
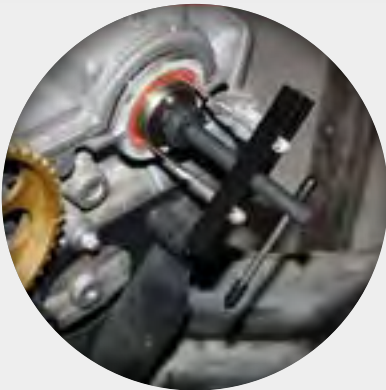

VAG 1.4 & 1.6 16V

**BT546004**  
**EAN 4042146845769**  
crankshaft sealing ring assembly tool for  
VAG 1.4 and 1.6 16V



**130,- €**

VAG Benzin- & Diesel

**BT542078**  
**EAN 4042146845752**  
crankshaft seal assembly device for VAG  
petrol & diesel engines



**149,- €**

## INJECTION SYSTEM

Mercedes-Benz CDI

**BT551122**  
**EAN 4042146822432**  
Pre-chamber insert for  
Mercedes-Benz CDI



**13,- €**

**2**  
pcs.

BMW

**BT551008**  
**EAN 4042146821961**  
Assembly tool for injection pump  
wheel for BMW



**15,- €**

**6**  
pcs.

BMW

**BT551330**  
**EAN 4042146813430**  
Injection nozzle assembly and disassembly  
tool for BMW, 6 pcs



**249,- €**

**Mercedes-Benz**

**BT551121**  
**EAN 4042146822418**  
Diesel pump locking pin for  
Mercedes-Benz



**8,- €**

**BMW**

**BT551340**  
**EAN 4042146822715**  
Alignment and O-ring assembly set  
for VAG pump/nozzle unit



**60,- €**

**BT551360**  
**EAN 4042146821923**  
FSI nozzle assembly and  
disassembly set

**15  
pcs.**

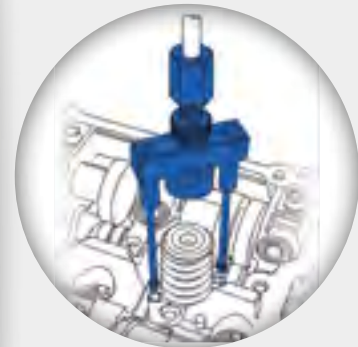
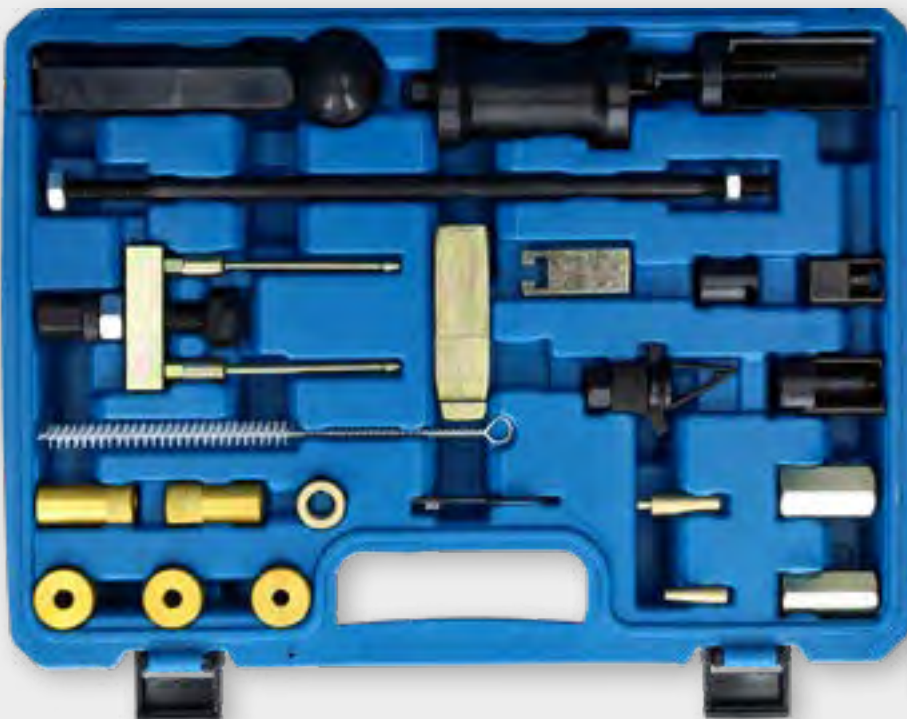

**89,- €**

## INJECTION SYSTEM

2  
pcs.

Ford

**BT551110**  
**EAN 4042146822319**  
Injector alignment tool for Ford  
Duratorq

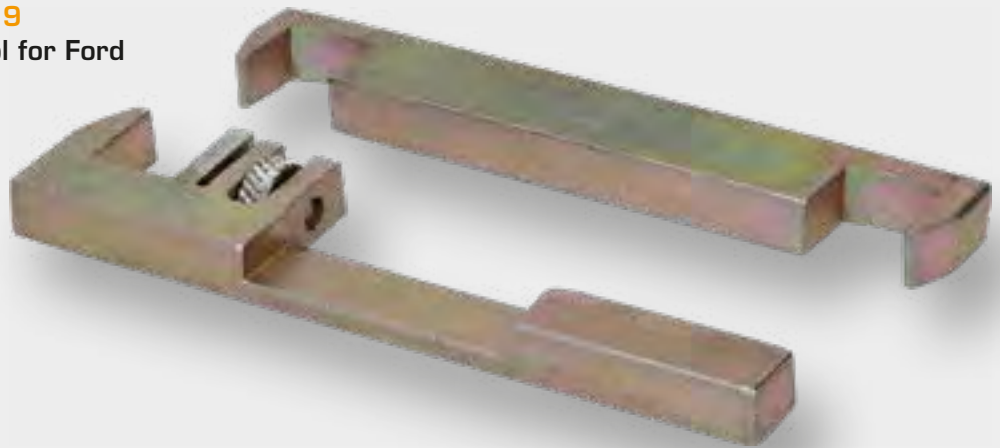

**25,- €**

7  
pcs.

1/2"  
12,5 mm

**BT551000**  
**EAN 4042146779330**  
Special injector socket set, 7 pcs



25 mm

27 mm

28 mm

30 mm

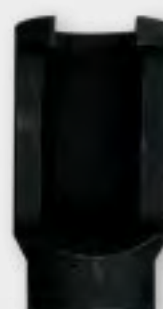

Ø30 / Ø46

30 mm

Ø46 / Ø27

**95,- €**

**Bosch, Lucas**  
**M8 x 0,75 / M12 x 1,5 / M14 x 1,5**

**BT551120**  
**EAN 4042146779279**  
Diesel injector puller



1,0 kg

230mm

**26,- €**





**BT551100**  
**EAN 4042146779309**  
Injector extractor, 3 pcs

**3**  
pcs.

**Mercedes Benz CDI**  
**OM611, OM612, OM613**

M16 x 1,5mm

M27 x 1,0mm



15,5mm

70mm

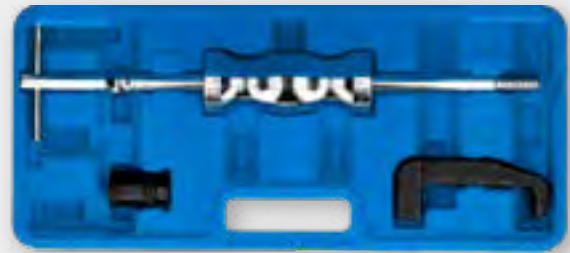

1,85 kg

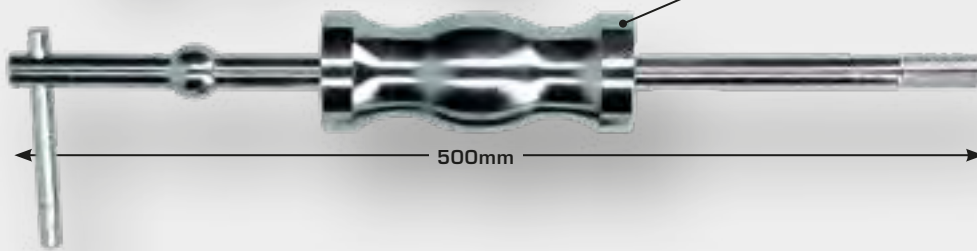

500mm

**64,- €**

**1/2"**  
12,5 mm

**9**  
pcs.

**Toyota, Mazda, Hyndai, Citroen,**  
**Peugot 2.0 HDI, DW10 / DW12**

**BT551180**  
**EAN 4042146779316**  
HDI injector extractor set, 9 pcs

25 cm

29 cm



**99,- €**

# INJECTION SYSTEM

**41**  
pcs.

**BT551010**  
**EAN 4042146779347**

**Diesel injector extractor master set, 41 pcs**



**399,- €**

	1,6 kg / 160 mm		M14 x 1,5 mm
	2,7 kg / 460 mm		M16 x 2 mm
	5,1 kg / 600 mm		M12 x 1,5 mm
	13,7 x 18 mm, 105 mm 12,7 x 19 mm, 130 mm		M16 x 1,5 mm
	• 25 • 27 • 28 • 29 • 30 mm		M14 x 1,5 mm
	35 mm / 29 mm / M17		M22 x 1,5 mm
	M14 x 1,5 mm		M22 x 25G
	M14 x 1,5 mm		M26 x 25G
			M26 x 25G



Ø 7,5 - 10,0 mm

**BT551250**  
**EAN 4042146779354**  
Copper washer remover  
install tool diesel injector

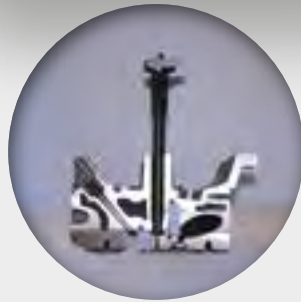

**32,- €**

**14**  
pcs.

**BT551380**  
**EAN 4042146877548**  
Injector seat and manhole  
cleaning set, 14 pcs



**49,- €**

## INJECTION SYSTEM

**BT551300**  
**EAN 4042146779262**  
Injector seat and manhole  
cleaning set, 21 pcs

**21**  
pcs.

**99,- €**



**BT551105**  
**EAN 4042146845790**  
Timing case cover alignment  
and pump wheel removal tool  
set for Ford 1.8 TDDi / TDCi

**2**  
pcs.

**Ford 1.8 TDDi / TDCi**

**26,- €**





VAG

**BT551350**

**EAN 4042146822708**

Setting gauges for VAG pump-nozzle-units on  
3- and 4-cylinder engines



**90,- €**

BMW

**BT551376**

**EAN 4042146845783**

Petrol injection nozzle  
tool for BMW



**65,- €**

Renault, Mitsubishi, Opel

**BT551400**

**EAN 4042146822463**

Adjustment and locking tool for diesel  
pumps for Renault, Mitsubishi, Opel

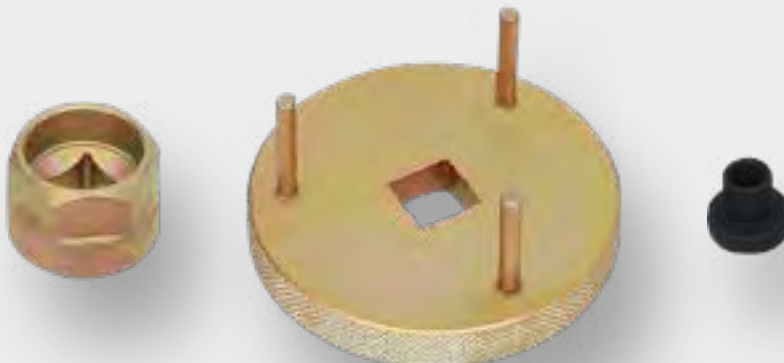

**23,- €**

## SPARK PLUGS AND GLOW PLUGS

**BT566000**  
**EAN 4042146779422**  
Ignition cable extractor

**11,- €**



VAG

**BT561005**  
**4042146845806**  
Ignition coil disassembly tool for VAG

**16,- €**



VAG

**BT561006**  
**EAN 4042146845813**  
Ignition coil extractor for VAG

**23,- €**



**4**  
pcs.

VAG

**BT561000**  
**EAN 4042146779378**  
Ignition coil disassembly  
tool set for VAG,  
4 pcs

**38,- €**





**BT566001**  
**EAN 4042146779385**  
Spark plug thread chasers ,  
2 pcs



**8,- €**

**BT566002**  
**EAN 4042146779439**  
Glow plug connector pliers -  
straight jaw



**13,- €**

**BT566003**  
**EAN 4042146779446**  
Glow plug connector pliers -  
angled jaw



**13,- €**

## SPARK PLUGS AND GLOW PLUGS

**BT561020**  
**EAN 4042146779392**

Glow plug puller & removal kit,  
3 pcs



**3**  
pcs.

M10 x 1,0 / M12 x 1,25



M10



M12



**45,- €**

**BT561010**  
**EAN 4042146779415**

Glow plug tool set, 7 pcs

**7**  
pcs.

Ø 2,7 - 6,0 mm



**52,- €**





**BT561030**  
**EAN 4042146779408**  
Glow plug removal kit, 16 pcs

**16**  
pcs.

M8 x 1,0 / M10 x 1,0  
6,3 mm (1/4") - 28 UNF



**91,- €**

# ONLY THE BEST SETS

## AUXILIARY BELTS / ALTERNATOR

**BT571080**  
**EAN 4042146813195**

V-belt assembly and disassembly  
 tool set, 5 pcs

**5**  
 pcs.

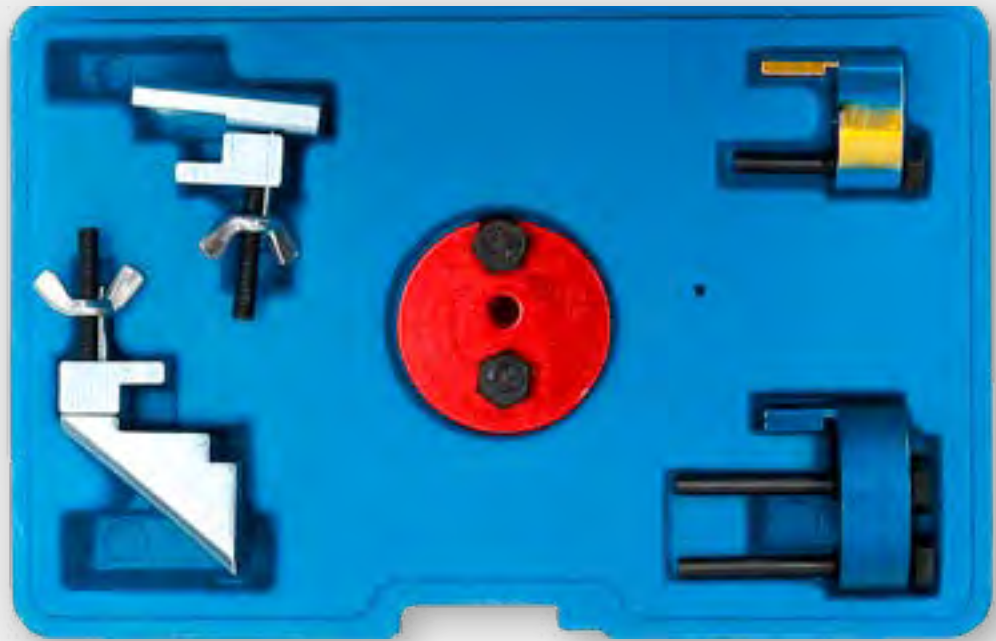
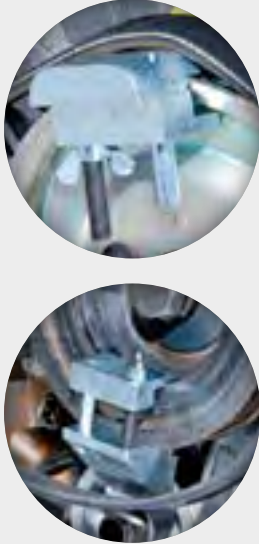

**75,- €**

**18**  
 pcs.

**Bosch + Magneti Marelli:**  
 Audi / BMW / Fiat / Ford / Mercedes / Opel / Porsche /  
 Renault / Peugeot / Seat / Škoda / Volkswagen etc.

**BT571020**  
**EAN 4042146779477**

Alternator pulley kit, 18 pcs



**56,- €**

**11**  
pcs.

Ø 40 - 220 mm

**BT595750**  
**EAN 4042146780657**  
Universal pulley holder fan clutch  
set, 11 pcs

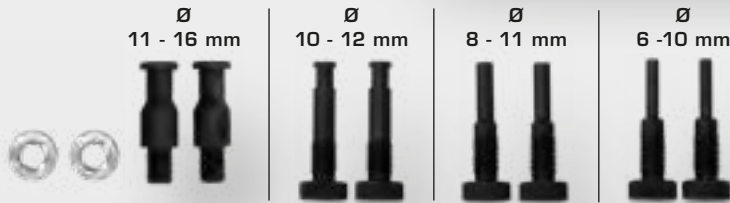

**46,- €**

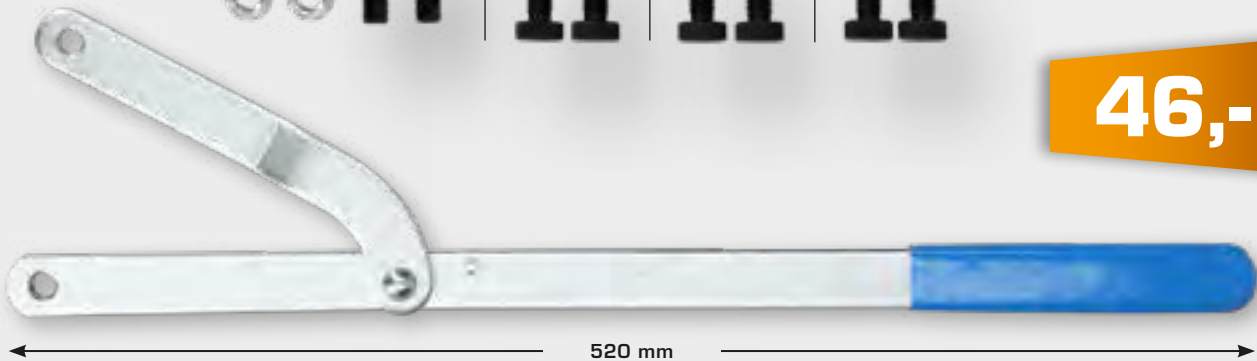

**15**  
pcs.

**BT571060**  
**EAN 4042146779507**  
Interchangeable belt tensioner  
wrench set, 15 pcs

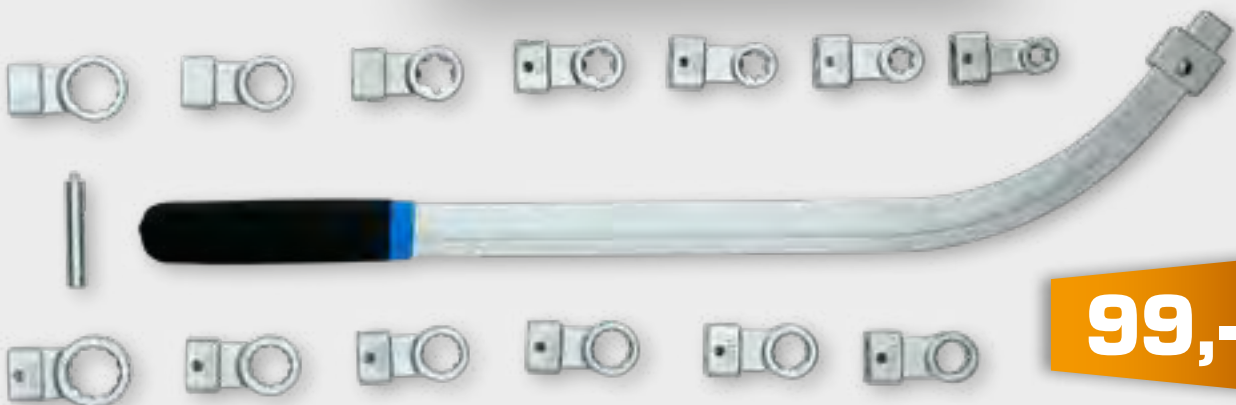

**99,- €**

## AUXILIARY BELTS / ALTERNATOR

**BT571050**  
**EAN 4042146779491**  
Serpentine belt tool, 8 pcs

**8**  
pcs.



**24,- €**



15 mm



16 mm



18 mm



13 mm



14 mm



15 mm

**VAG**

**BT571015**  
**EAN 4042146813201**  
Crank shaft retaining key for VAG

**29,- €**

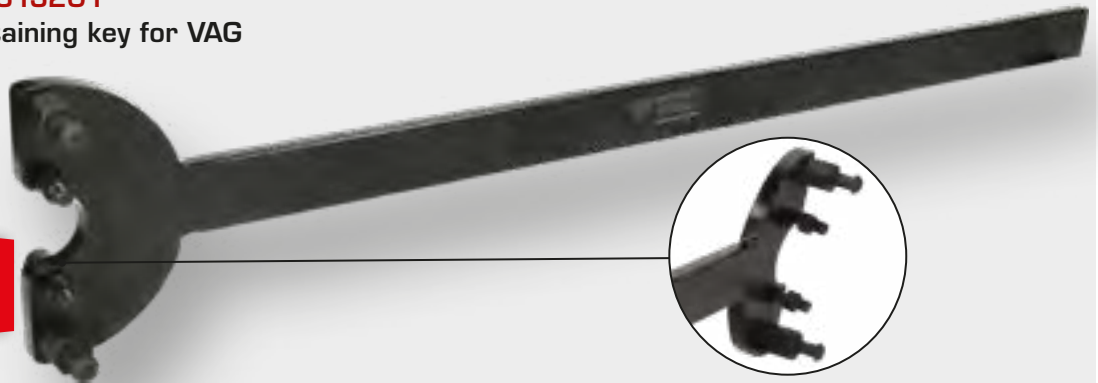

**1/2"**  
12,5 mm

**Volvo**

**BT571090**  
**EAN 4042146813355**  
Vibration damper holding key  
for Ford and Volvo

**30,- €**



Ford

**BT571013**  
**EAN 4042146845820**  
Crankshaft holding key for  
Ford

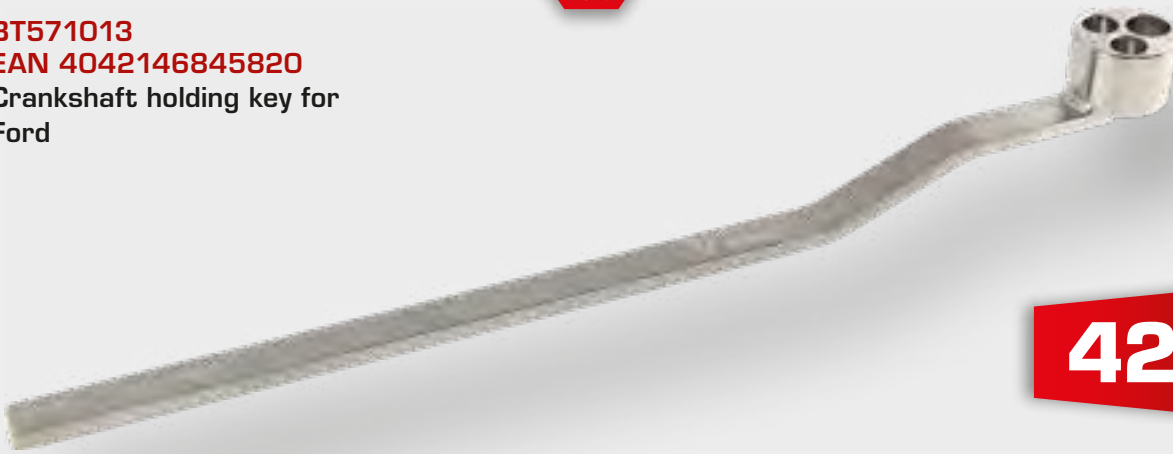

**42,- €**

Ford, Volvo

**BT571014**  
**EAN 4042146845837**  
Crankshaft vibration damper  
alignment tool for Ford, Volvo

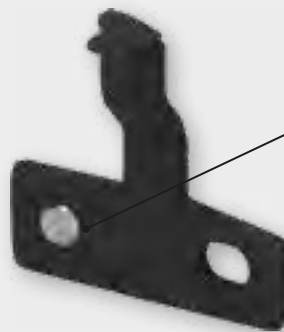

**6,- €**

Mercedes-Benz W169 und W245

**BT571016**  
**EAN 4042146845844**  
V-ribbed belt tensioning element for Mercedes-Benz  
W169 and W245



**29,- €**

Ford

**BT571091**  
**EAN 4042146822302**  
Belt tensioner wrench for Ford  
Duratorq engines



**23,- €**

AUXILIARY BELTS / ALTERNATOR

**BT616000**  
**EAN 4042146780787**  
 Puller for ribbed drive pulley

3/8"  
 10 mm

Ø 40 - 165 mm



**49,- €**



**12**  
 pcs.

Fs6 / C171 / 6P / 148 / GM R4 i A6 / Hr6 / Da-6 i V5 / Sanden  
 Sd505 / 507 / 510 / 507 / 510 / 575 / 708 709 etc.

**BT611000**  
**EAN 4042146780770**  
 A/C Compressor clutch  
 remover kit, 12 pcs

**49,- €**



# EVERYTHING AT A GLANCE WITH 360° VIEWS

EVEN IF A PICTURE IS WORTH A THOUSAND WORDS:  
YOU WILL ALSO FIND DETAILED ARTICLE DESCRIPTIONS  
ON OUR WEBSITE!



**7 DAYS,  
24 HOURS**

**WWW.BRILLIANT-TOOLS.COM**



DIAGNOSTIC TOOLS

**BT611020**  
**EAN 4042146813409**  
 UV leak search torch set, 8 pcs

**8**  
 pcs.



**129,- €**

**BT586000**  
**EAN 4042146779620**  
 Mechanic's stethoscope

**8**  
 pcs.



**8,- €**

**BT581150**  
**EAN 4042146779521**  
 Petrol engine  
 compression tester set,  
 2 pcs

**2**  
 pcs.



**29,- €**



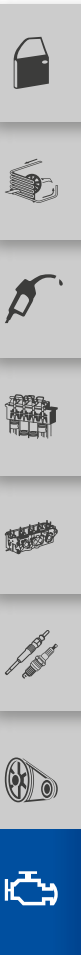

**8**  
pcs.

**BT581100**  
**EAN 4042146779538**

Petrol engine compression tester set, 8 pcs

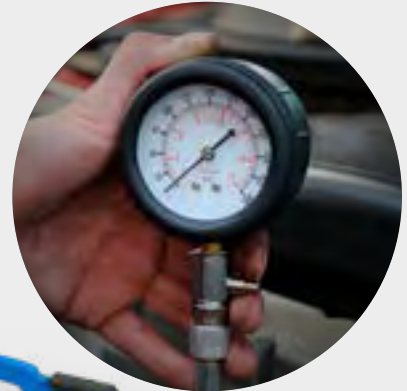

**45,- €**

**13**  
pcs.

**BT581050**  
**EAN 4042146779576**

Diesel engine compression test set, 13 pcs

	M24 x 2,0
	M20 x 1,5
	M12 x 1,25
	M10 x 1,25
	-
	M10 x 1,0
	M10 x 1,25
	M14 x 1,5
	-

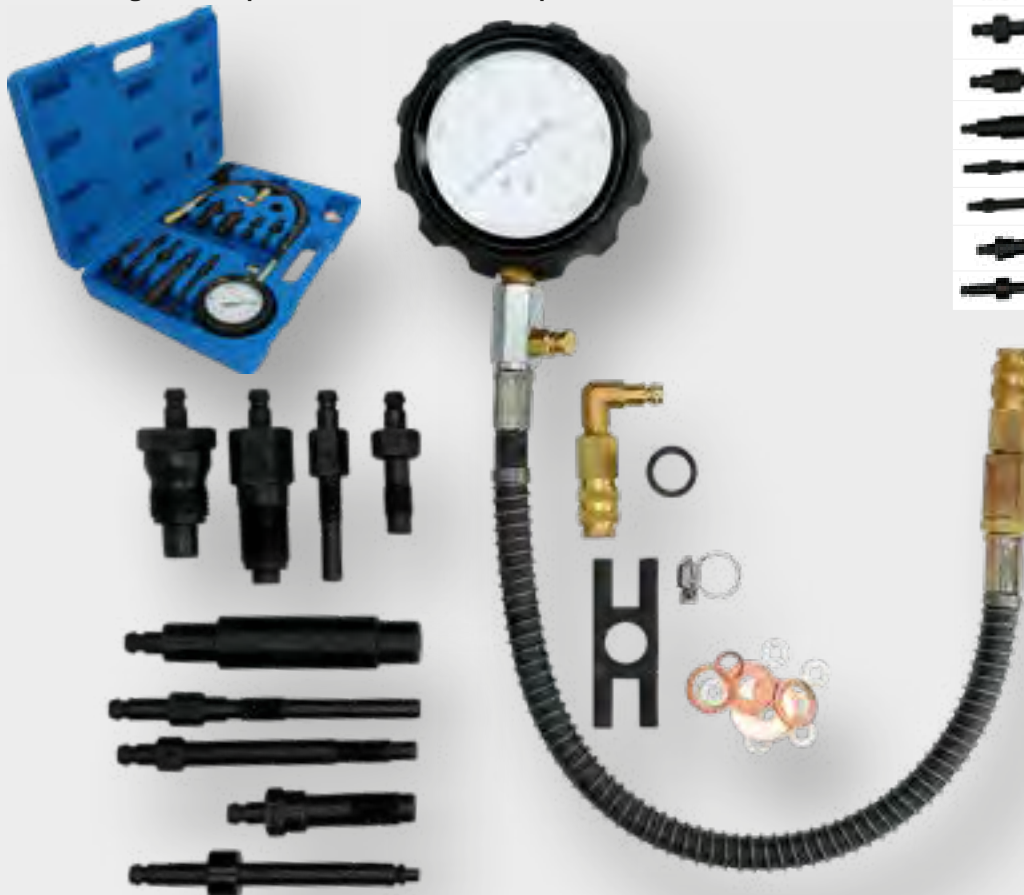

**79,- €**

## DIAGNOSTIC TOOLS

**BT581000**  
**EAN 4042146779606**

Diesel engine compression test set, 18 pcs

	M20 x 1,5 • M16 x 1,5
	M24 x 1,5 • M24 x 2,0
	• M8 x 1,0 • M10 x 1,0 • M10 x 1,25 • M12 x 1,25

**18**  
pcs.

**89,- €**



**BT581530**  
**EAN 4042146813447**  
Common rail tester

**41**  
pcs.

**BOSCH, DENSO, DELPHI**

**59,- €**

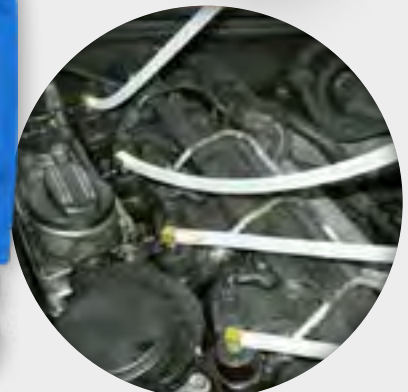
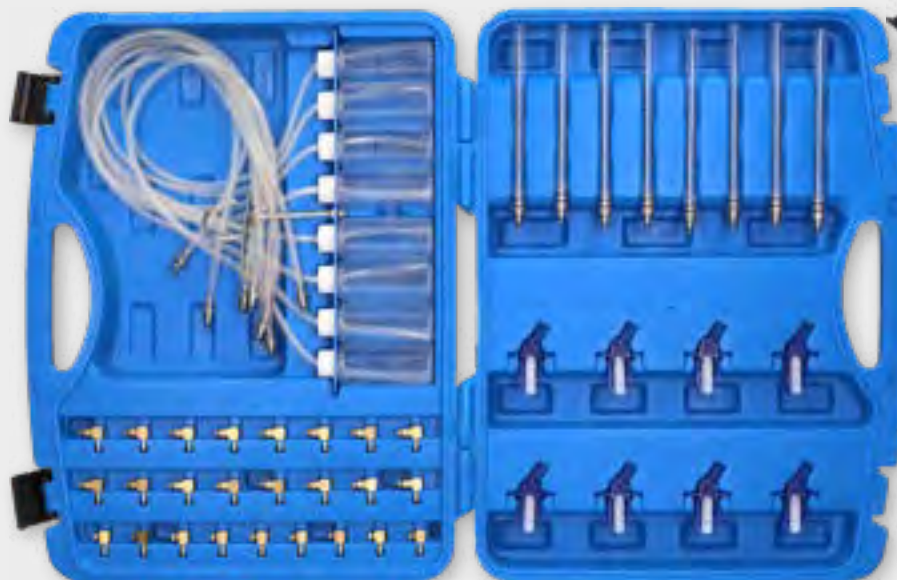



**BT581250**  
**EAN 4042146779545**

Fuel injection pump pressure  
tester kit, 9 pcs

**9**  
pcs.

0 - 7 bar



**40,- €**

**BT581350**  
**EAN 4042146779552**

Fuel injection test set, 20 pcs

**20**  
pcs.

0 - 10 bar



**69,- €**

**44**  
pcs.

0 - 8 bar

Mercedes Benz, BMW, Audi,  
Honda, Mazda, Renault, Peugeot

BT581400  
EAN 4042146779569  
Fuel pressure meter, 44 pcs

# THE FULL SERVICE PACKAGE

**169,- €**



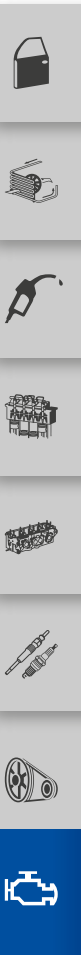

**BT581500**  
**EAN 4042146779613**  
Vacuum/pressure test kit, 21 pcs

**21**  
pcs.

0 - 0,7 bar



**99,- €**

**BT581450**  
**EAN 4042146779583**  
Engine oil pressure tester, 12 pcs

**12**  
pcs.

0 - 10 bar

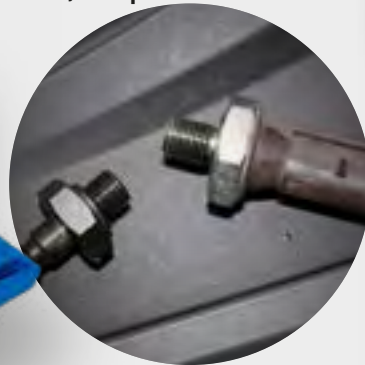

**59,- €**

## EXHAUST SYSTEM / CATALYSTS

**BT601006**  
**EAN 4042146821862**  
special wrench for  
turbo charger for  
VAG, 12 mm

**8**  
pcs.

VAG

**20,- €**

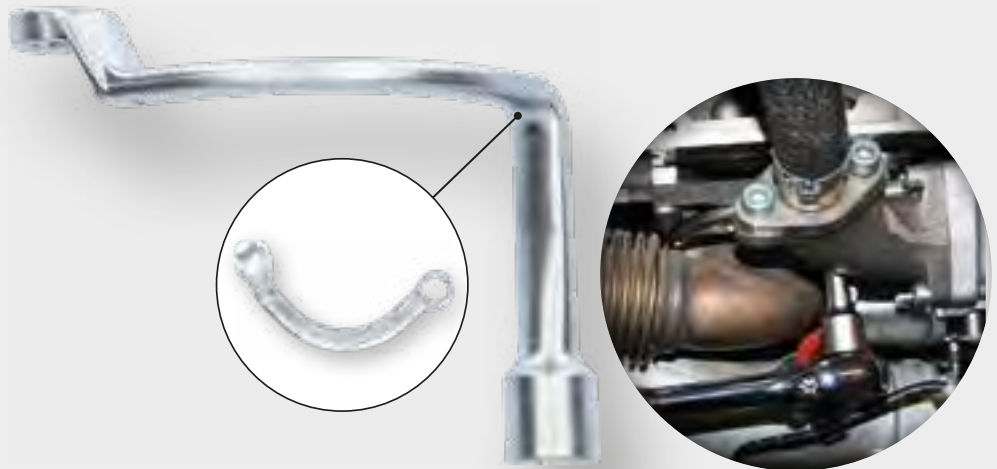

**BT601007**  
**EAN 4042146845394**  
exhaust gas recirculation valve  
dismantling tool for Hyundai and Kia

**38,- €**

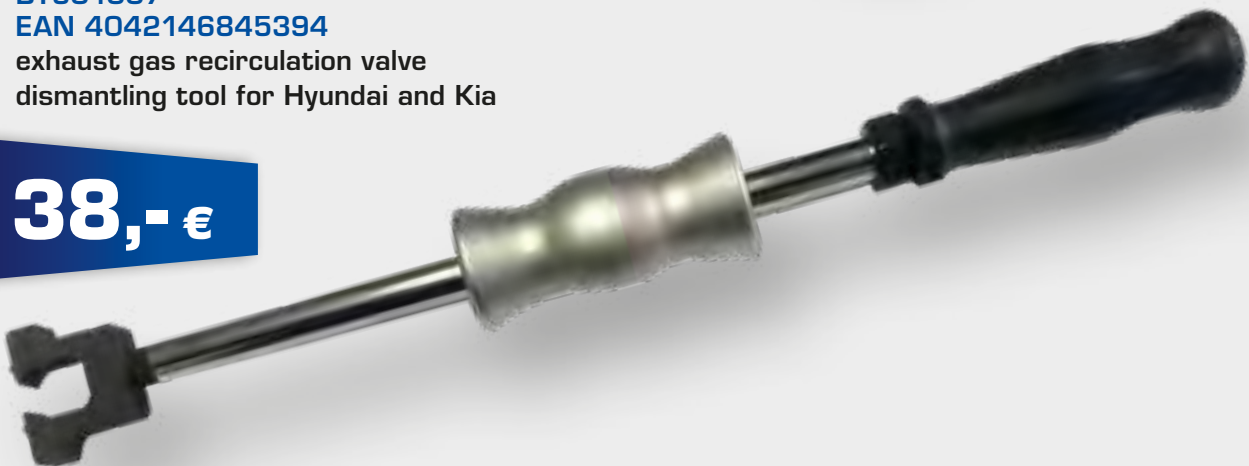

**BT606004**  
**EAN 4042146845134**  
special spanner for exhaust gas temperature  
sensor for VAG, 19 mm

**28,- €**

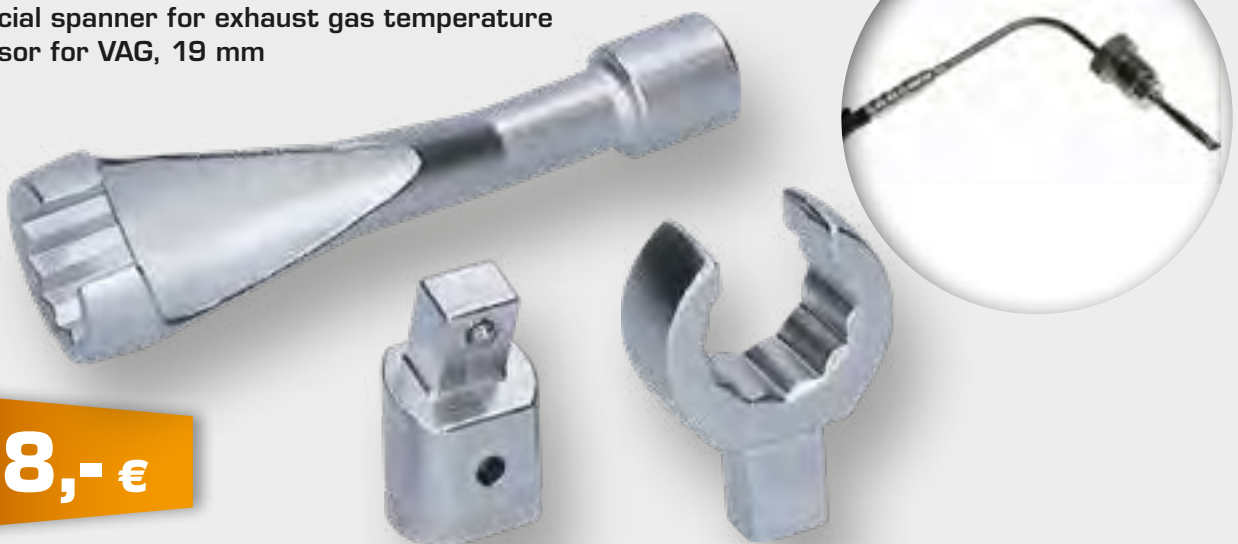



**22 mm**

**BT606000**  
**EAN 4042146780688**  
1/2" Drive oxygen sensor wrench, extra flat

**1/2"**  
12,5 mm

22 mm

**6,- €**

**22 mm**

**BT606001**  
**EAN 4042146780695**  
1/2" Drive oxygen sensor wrench, flat

**1/2"**  
12,5 mm

22 mm

**7,- €**

**22 mm**

**BT606002**  
**EAN 4042146780701**  
3/8" Drive oxygen sensor socket, long

**3/8"**  
10 mm

8 mm

**8,- €**

**22 mm**

**BT606003**  
**EAN 4042146780718**  
3/8" Drive oxygen sensor socket, long

**3/8"**  
10 mm

22 mm

**8,- €**

## EXHAUST SYSTEM / CATALYSTS

**BT601000**  
**EAN 4042146780725**

Oxygen sensor socket and thread chaser set, 5 pcs

**5**  
 pcs.

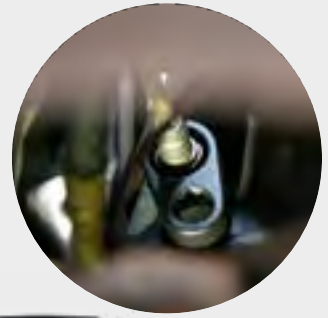

**3/8"**  
 10 mm  
**1/2"**  
 12,5 mm



22,0 mm



22,0 mm



M12 x 1,25 mm



22,0 mm



M18 x 1,5 mm



**30,- €**

**BT601020**  
**EAN 4042146780732**  
 Sensor socket set, 7 pcs

**7**  
 pcs.

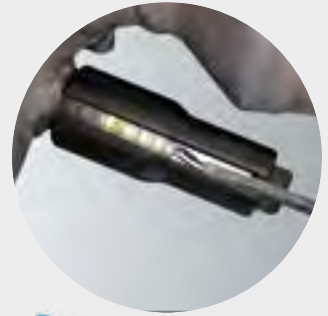

**3/8"**  
 10 mm  
**1/2"**  
 12,5 mm

29 mm



22 mm



27 mm



22 mm



27 mm



**57,- €**

22 mm



22 mm







**BT601040**  
**EAN 4042146780749**  
Repair tool for Lambda probe thread,  
M18 x 1.5 mm, M12 x 1.25 mm, 2 pcs

**2**  
pcs.

**3/8"**  
10 mm

M18 x 1,5 mm

M12 x 1,25 mm

**7,- €**

**BT601050**  
**EAN 4042146780756**  
Exhaust puller  
set, 2 pcs

**2**  
pcs.

200 mm

+

200 mm

**8,- €**

**BT601060**  
**EAN 4042146780763**  
Tail pipe expander, 3 pcs

**7**  
pcs.

28 - 87 mm

Ø  
54,0 - 87,0 mm

Ø  
38,0 - 62,0 mm

Ø  
28,0 - 44,0 mm

**46,- €**

## TRANSMISSION

**BT626000**  
**EAN 4042146780794**  
**VAG7 Speed DSG**  
**mechatronic unit remover**

VAG 0 AM

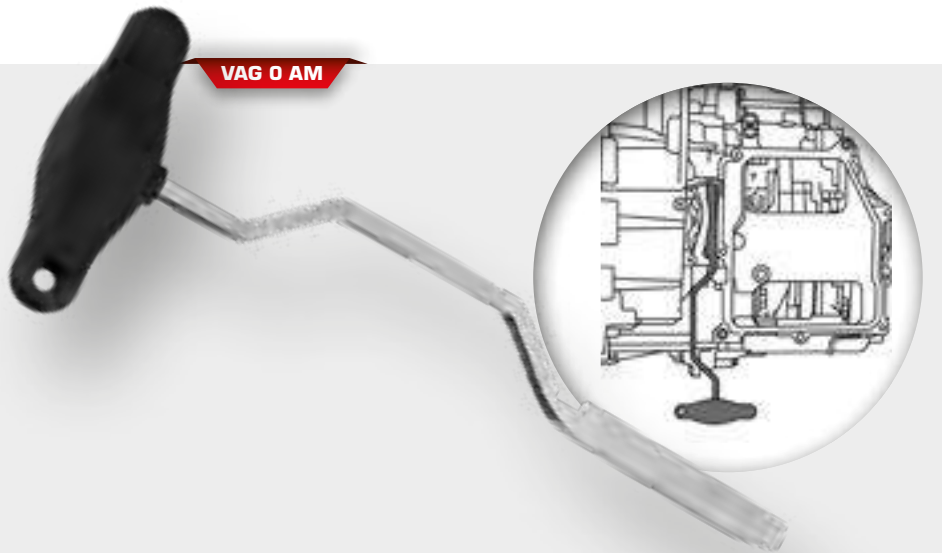

**17,- €**

**BT621000**  
**EAN 4042146780800**  
**Pneumatic fluid extractor/dispenser**  
**with adapter set**

**17**  
 tlg.

Audi, Ford, BMW, Mercedes, Volkswagen  
 Skoda, Volvo, Toyota, Lexus, Nissan



6 L



**159,- €**

	Ford 1/8" - 27 NPT
	15° Universal
	29° VAG
	29° VAG / Porsche
	VAG, BMW, Mini M10 x 1,0
	Mercedes 722.9, M12 x 1,5
	VAG DSG M24 x 1,5
	VAG CVT M22 x 1,5
	Skoda M18 x 1,5
	VAG / Skoda M30 x 1,5
	Universal, 300mm
	Volvo 5/16" - 24 UNF
	90° Toyota / Lexus M18 x 1,5



**BT626050**  
**EAN 4042146877562**

Automatic transmission fluid  
changer / flusher including  
adapter set 35 pcs

**TECHNICAL DATA:**

Volume of waste oil containers	15 L
Volume of new oil containers	15 L
Volume of production membrane pumps	50 L/min.
Length connection hoses	2500 mm
Pressure	4-7 bar
Ambient temperature	+10°C bis +50°C
Grid voltage	230V AC / 50 H
Power consumption	0,25 kW

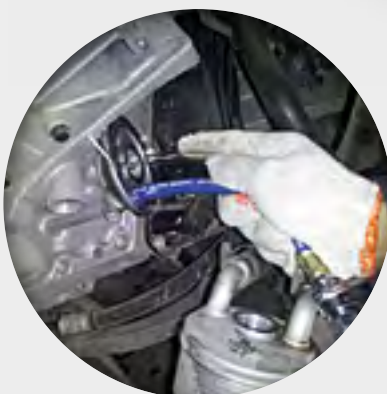

**599,- €**

# CLUTCH

**12**  
pcs.

**BT641220**  
**EAN 4042146813218**  
DSG coupling tool set, 12 pcs



**199,- €**



**Ford, Volvo**

**BT641240**  
**EAN 4042146813386**  
Dual clutch tool for Volvo, Ford, Chrysler  
and Dodge

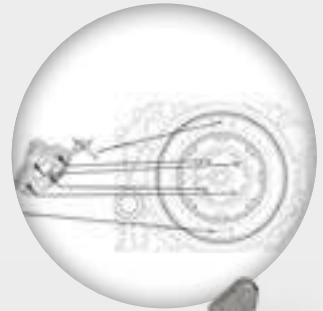

**109,- €**



**BT641050**  
**EAN 4042146780862**  
Diesel/petrol engine flywheel holding Tool for BMW Mini

**7 pcs.** **BMW Mini**

**M47T2m, M47TU, M57T2, M57TU, M67, N45, N45T, N46, N46T, N51, N52, N53, N54, W17**

**92,- €**

**Citroën, Fiat, Peugeot**

**BT641060**  
**EAN 4042146822128**  
fly wheel locking tool for, Citroen, Fiat, Peugeot

**4,- €**

**3 pcs.** **Ø 15 - 28 mm**

**BT641000**  
**EAN 4042146780909**  
Universal clutch alignment tool, 3 pcs

**10,- €**

**BT641100**  
**EAN 4042146780879**  
Clutch alignment/adjustment set, 11 pcs

**11 pcs.** **Ø 14,9 - 19,7 • 19,8 - 27,2  
22,8 - 36,0 mm**

**Ø 12,0 mm** **Ø 14,0 mm** **Ø 15,0 mm** **Ø 16,0 mm** **Ø 17,0 mm** **Ø 18,0 mm** **Ø 19,0 mm** **Ø 20,0 mm**

**+**

**80,- €**

# CLUTCH

BT641150  
EAN 4042146780886  
SAC Clutch alignment tool, 39 pcs

**39**  
pcs.

Audi, BMW, Fiat, Mercedes, Renault  
Opel, Seat, Skoda, Volvo, Volkswagen



**259,- €**



# STRUT / SHOCK ABSORBER

**BT651000**  
**EAN 4042146780923**  
 Strut nut kit, 8 pcs

**8**  
 pcs.

Audi, Seat, Skoda, Volkswagen, Mercedes

**1/2"**  
 12,5 mm

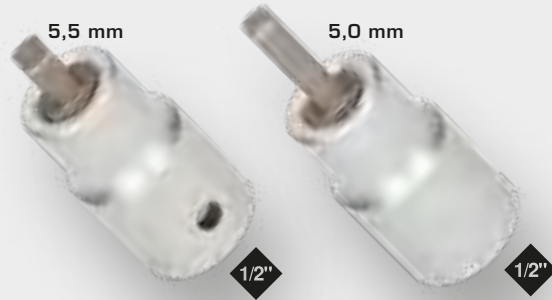

**33,- €**

**BT651250**  
**EAN 4042146780961**  
 Shock absorber remover/  
 installer kit, 18 pcs

**18**  
 pcs.

**1/2"**  
 12,5 mm



**99,- €**

		• 16 • 17 • 18 • 19 • 21 • 22 • 24 mm		6 • 7 • 8 mm
		5 x 8 • 6 x 8 • 7,1 x 9,6 mm		7 • 8 • 9 mm
		T50		250 mm



**39**  
pcs.

**BT651050**  
**EAN 4042146780916**  
Strut/shock installation  
tool kit, 39 pcs



	• 14 • 16 • 17 • 18 • 19 • 21 • 22 • 24 • 27 mm
	• 4 • 5,2 • 6 • 6,3 • 7 • 8 • 9 • 10 • 12 mm
	3 • 3,5 • 4 mm
	T50 • T60
	M12
	D5 • D10
	5 • 6 • 7 • 8 mm
	8 • 9 • 10 • 11 mm
	• 10,5 • 12,5 • 14 • 14,5 • 14,5 mm

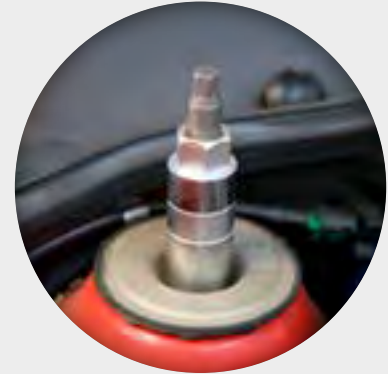

**175,- €**

**15**  
pcs.

McPherson: BMW, Toyota, Ford, Opel, VW, Audi,  
Saab, Nissan, Honda, Subaru, Volvo, Mitsubishi

**BT651150**  
**EAN 4042146780947**  
Strut coil clamp spring compressor set, Universal, 15 pcs



1,5 T

**179,- €**

# STRUT / SHOCK ABSORBER

**15**  
pcs.

McPherson: BMW, Toyota, Ford,  
Opel, VW, Audi, Saab, Nissan, Honda,  
Subaru, Volvo, Mitsubishi

**BT651200**  
**EAN 4042146780954**  
Strut coil clamp spring  
compressor set, 15 pcs  
plastic protective, universal

**219,- €**

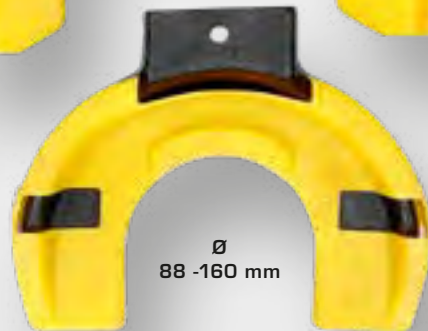

**8  
pcs.**

**BT651100**  
**EAN 4042146780930**  
Macpherson strut expander tool set, 8 pcs



**87,- €**

**5  
pcs.**

**BT651010**  
**EAN 4042146844809**  
Telescopic internal spring compressor set,  
5 pcs

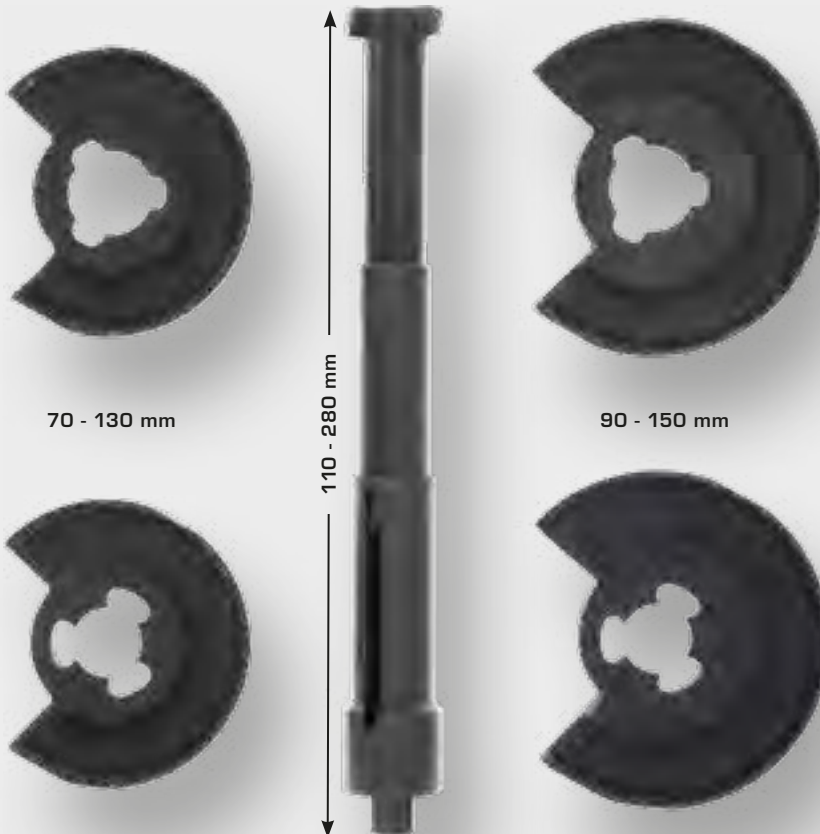

**136,- €**

# STEERING

18  
pcs.

BT651017  
EAN 4042146844816  
Universal ball joint pusher

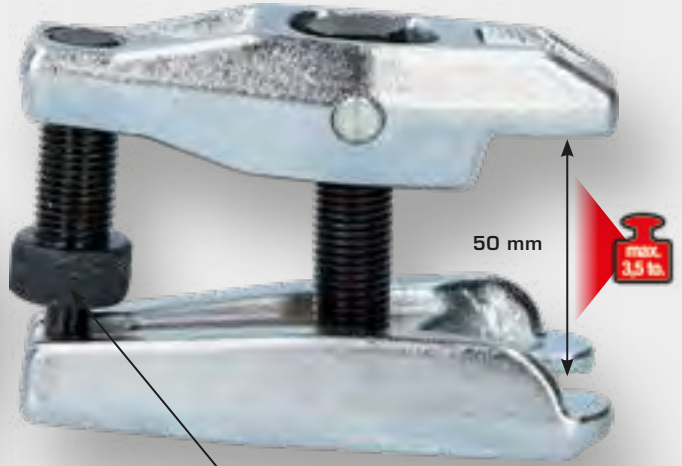

M14x1,5x48 mm

18-22 mm

19,- €

3  
pcs.

23 / 28 / 34 mm

BT661000  
EAN 4042146781012  
Ball joint remover, 3 pcs



63 mm



55 mm



55 mm

96,- €

**7**  
pcs.

**BT661300**  
**EAN 4042146781036**  
Clamping and splaying  
tool set, 7 pcs

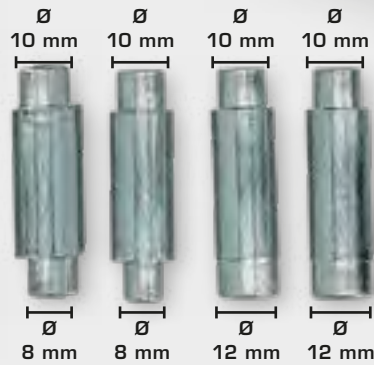
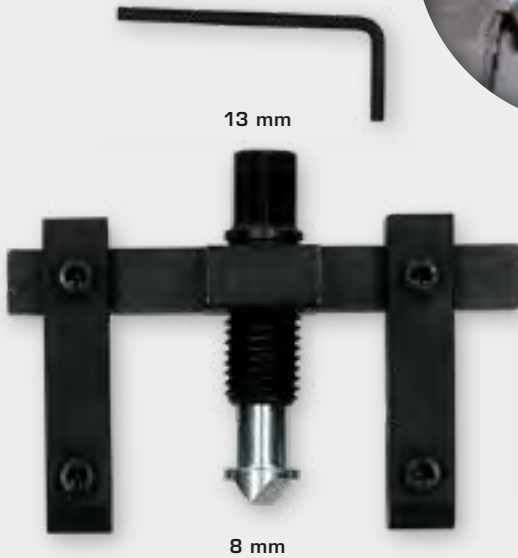

**46,- €**

**5**  
pcs.

**BT661250**  
**EAN 4042146781050**  
Ball joint tool, for BMW 3 Series, 5 pcs



**180,- €**

# STEERING

**BT661050**  
**EAN 4042146781005**  
 Front upper ball joint remover/  
 installer tool - VW T4, 6 pcs

**6**  
 pcs.

**VW T4**

**199,- €**



**BT661100**  
**EAN 4042146780978**  
 4in1 Ball joint service tool set, 9 pcs

**9**  
 pcs.

**W220, W211, W230**

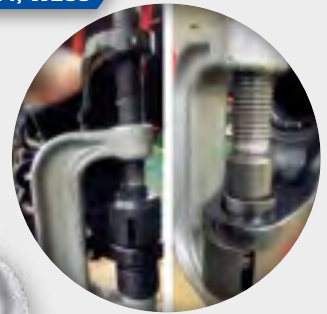

**145,- €**



**4**  
pcs.

Ø 30 - 35, 35 - 40, 40 - 45 mm

**BT661350**  
**EAN 4042146781029**

Track rod end remover/installer, 4 pcs



Ø 30 - 35 mm



Ø 35 - 40 mm



Ø 40 - 45 mm

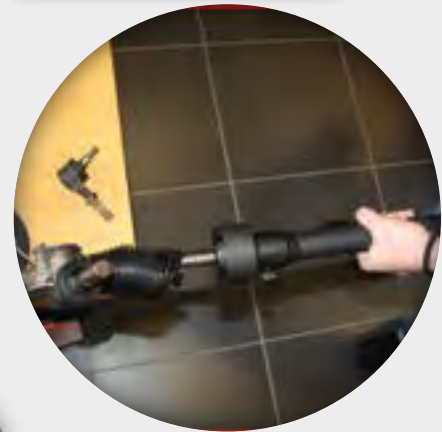

1/2"  
32 mm



**109,- €**

1/2"  
12,5 mm

Ø 36 - 41 mm

**BT666000**  
**EAN 4042146781043**

Universal tie rod wrench  
36-41mm

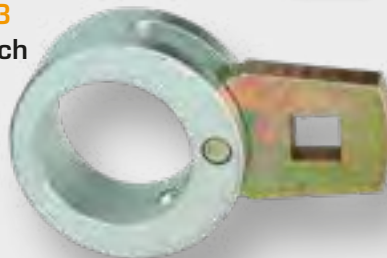

**12,- €**

**5**  
pcs.

**BT666010**  
**EAN 4042146871386**

Ball joint puller set, 5 pcs



20-22  
mm

155 mm

**96,- €**

**BT671000**  
**EAN 4042146781210**  
 Axle nut socket set, 9 pcs

**9**  
 pcs.

29, 30, 31, 32, 33, 34, 35, 36, 38 mm

**1/2"**  
 12,5 mm



**77,- €**

9x



29 • 30 • 31 • 32 • 33 • 34  
 • 35 • 36 • 38 mm

**BT671250**  
**EAN 4042146781142**  
 Hydraulic wheel hub puller,  
 98 to 125 mm

**3**  
 pcs.

Ø 98 - 125 mm

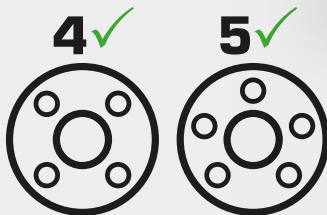

1.1/2"x16G

10 to.



**165,- €**







**8**  
pcs.

Ø 98 - 125 mm

**BT671200**  
**EAN 4042146781159**  
Hydraulic wheel hub puller,  
8 pcs

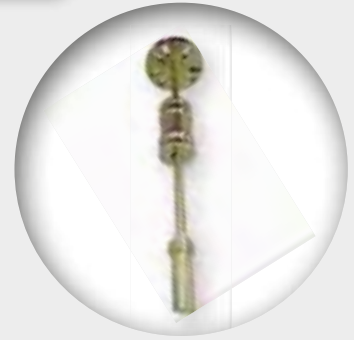
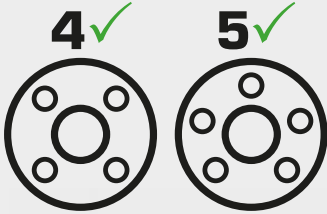

**259,- €**

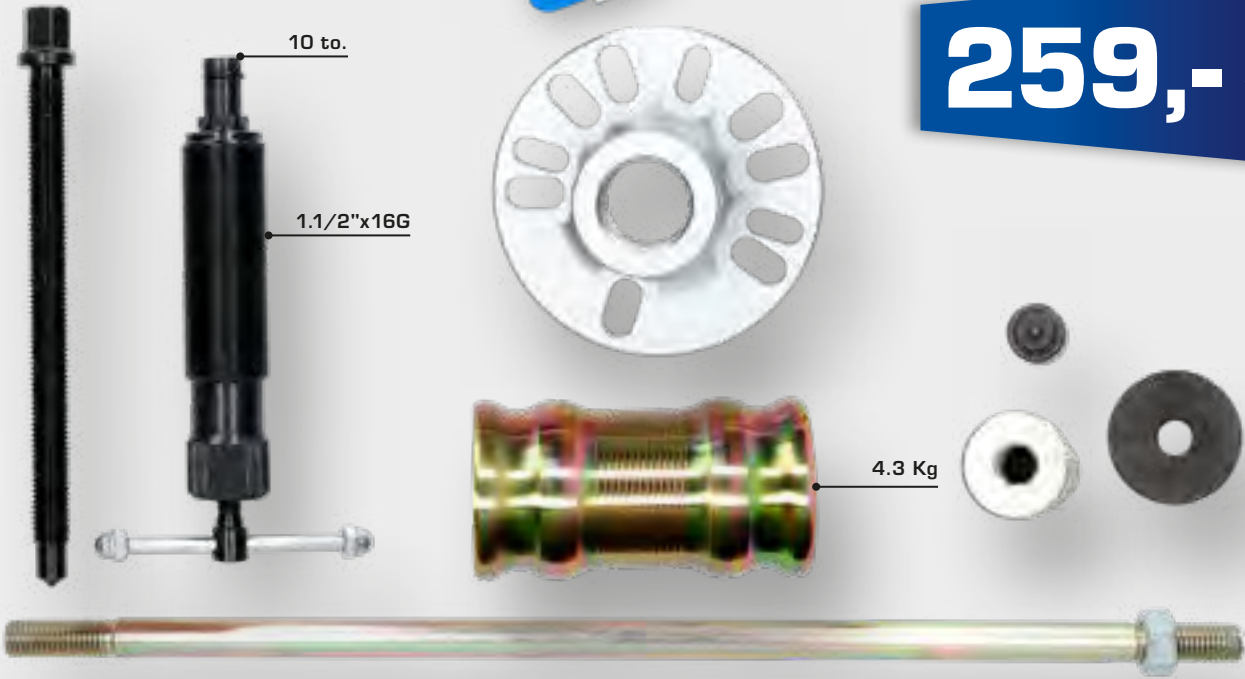

**BT676003**  
**EAN 4042146781258**  
CV joint assembly removal tool

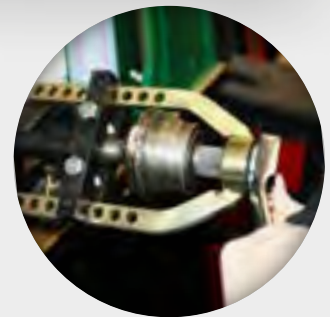
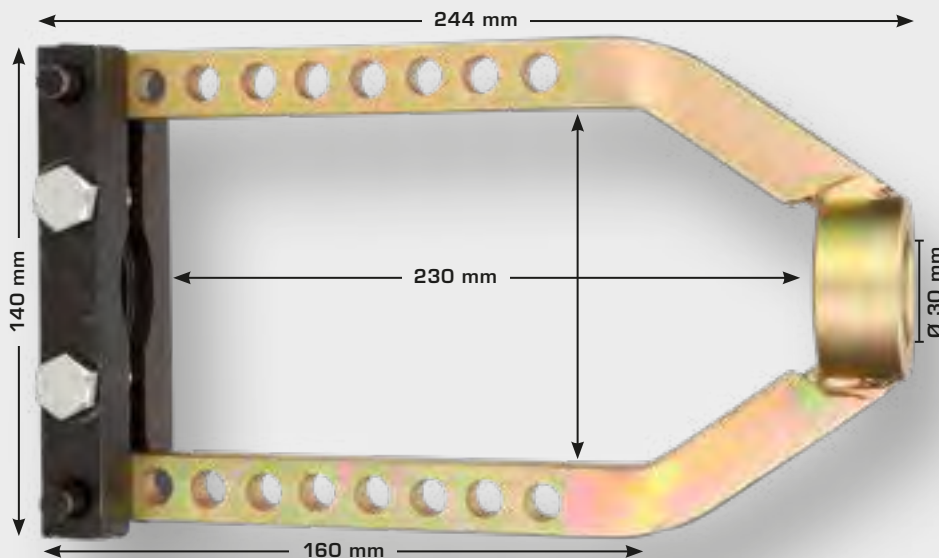

**37,- €**

**AXIS**

**BT676000**  
**EAN 4042146781227**  
 CV boot clamp pliers

**9,- €**



**BT676002**  
**EAN 4042146781241**  
 CV boot band plier

**40,- €**



**BT676001**  
**EAN 4042146781234**  
 CV joint clamp banding tool

**13,- €**



**7**  
 pcs.

**VW Beetle, Touareg, Porsche Cayenne, BMW E30, E32, E34, E36, E38, E39, E46, X5, Mercedes W203**

**BT671050**  
**EAN 4042146781180**  
 drive shaft retractor set

**89,- €**

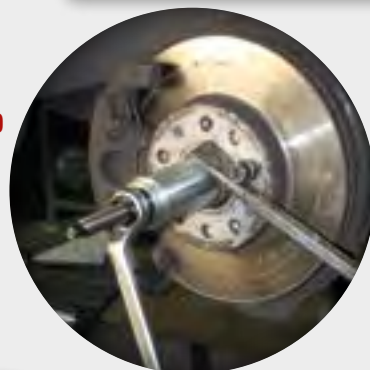

	M16: Subaru		M22: BMW E30, E46		M27: BMW E32, E34, E38, E39, X5
	M20: VW Touareg, Beetle/Porsche Cayenne		M24: BMW E36/Mercedes W203		M30: BMW E32, E34, E36



**BT671300**  
**EAN 4042146781197**  
Slide hammer/puller set,  
14 pcs

**14**  
pcs.



**109,- €**

**BT671350**  
**EAN 4042146781203**  
Slide hammer/puller set,  
16 pcs

**16**  
pcs.



**120,- €**

**30**  
pcs.

Ø 98 - 125 mm

**BT671100**  
**EAN 4042146780893**  
Heavy duty wheel hub puller set,  
30 pcs



M12 x 1,5 mm

M14 x 1,5 mm

M12 x 1,5 mm

M12 x 1,25 mm

M18 x 2,5 mm

260 mm

M14 x 1,5 mm

4.3 Kg

**255,- €**

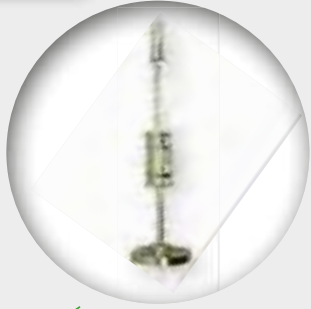

BT671450  
EAN 4042146781098  
Front wheel bearing tool - 72mm

16  
pcs.

Ø 72 mm



163,- €

BT671600  
EAN 4042146781128  
Front wheel hub bearing tool - 85mm

17  
pcs.

VAG T5 / Ø 85 mm



159,- €



**BT671650**  
**EAN 4042146781067**

Wheel bearing removal tool kit,  
31 pcs



**31**  
pcs.

Ø 50 • 55 • 59 • 63,3 • 66,6 • 70,3  
• 71,5 • 73,1 • 73,4 • 74,8 • 77,5  
• 81,5 • 83,4 mm



**169,- €**

**BT671750**  
**EAN 4042146781401**

Bushing/bearing/seal drivers,  
36 pcs

Stk.	Ø
1x	26, 28, 30, 37, 40, 55, 60, 68, 75, 82, 85, 100, 110 mm
2x	32, 42, 52, 72, 80, 90 mm
3x	35, 47, 62 mm

**36**  
pcs.

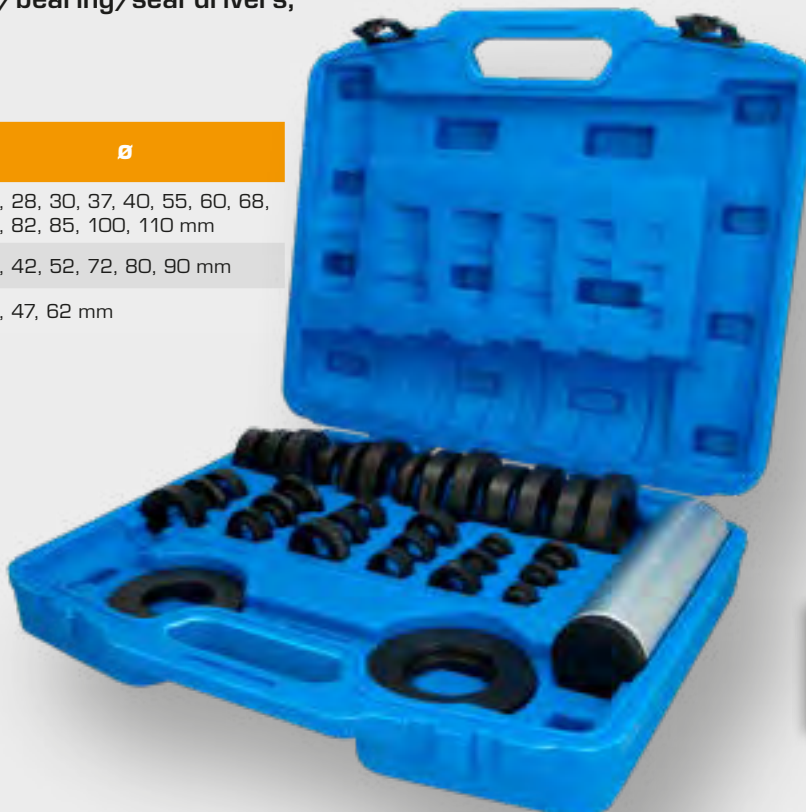

**129,- €**

# AXIS

**BT671900**  
**EAN 4042146781289**  
front axle transverse link  
bush tool for VAG

**5**  
pcs.

VAG



**65,- €**



**BT671800**  
**EAN 4042146781319**  
Brush extractor with  
mechanical - VW Polo, 8 pcs

**8**  
pcs.

VAG

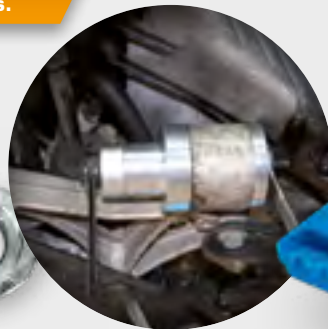

**65,- €**



**BT671850**  
**EAN 4042146781296**  
Front suspension bush tool  
- BMW Mini, 8 pcs

**8**  
pcs.

R50, R52, R53, R55, R56, R57, R58, R59



**49,- €**



**14**  
pcs.

**BMW E36 / E46 / E38 / E39  
E60 / E61 / E31 / E90 / E91**

**BT672050  
EAN 4042146781326**

Differential axle bush tool kit - BMW,  
E36/E46/E38/E39/E60/E61/E31/  
E90/E91, 14 pcs

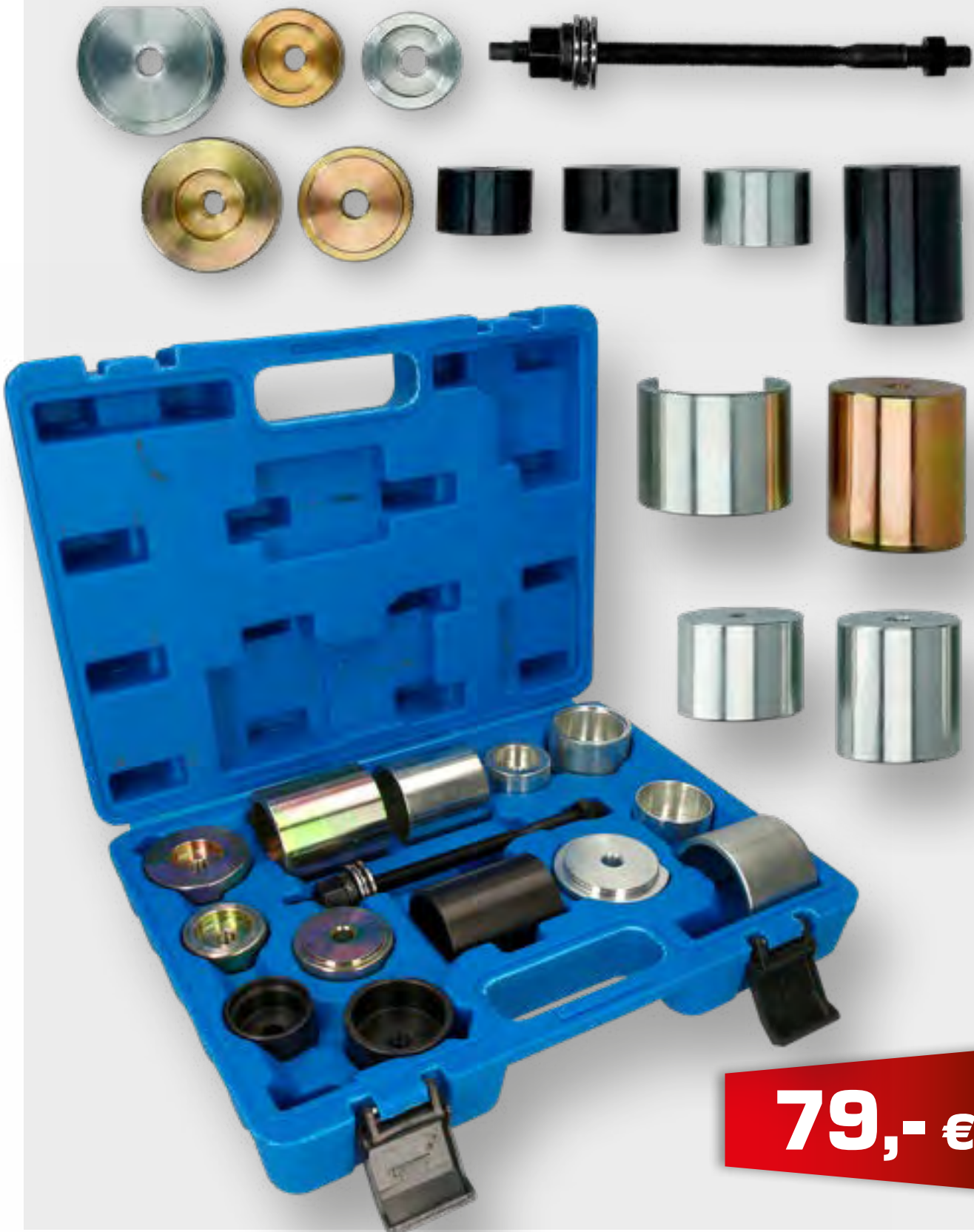

**79,- €**

**BT672350**  
**EAN 4042146781364**  
Rear bush tool - Ford Focus MK1  
1998-2004, 3 pcs

**3**  
pcs.

Ford, Mazda, Volvo

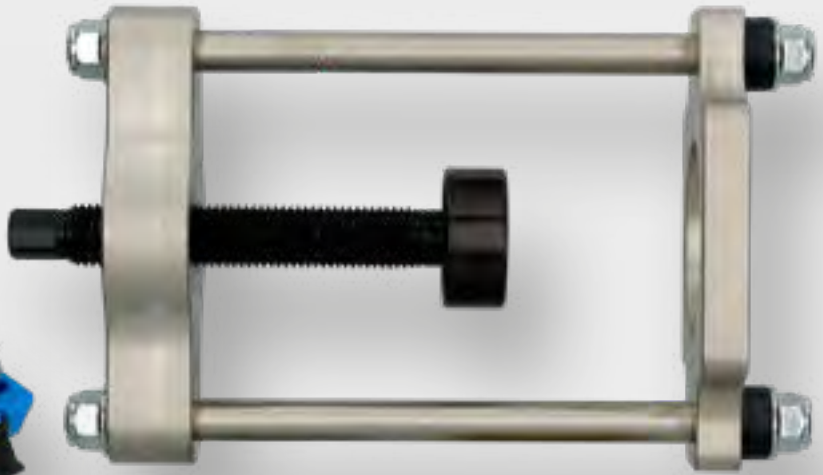

**119,- €**

**4**  
pcs.

Ford Mondeo

**BT672150**  
**EAN 4042146781265**  
Rear sub frame bush kit -  
Ford Mondeo, 4 pcs



**37,- €**



**4**  
pcs.

Renault Laguna II

**BT672100**  
**EAN 4042146781302**  
Rear sub frame bushing kit -  
Renault, 4 pcs

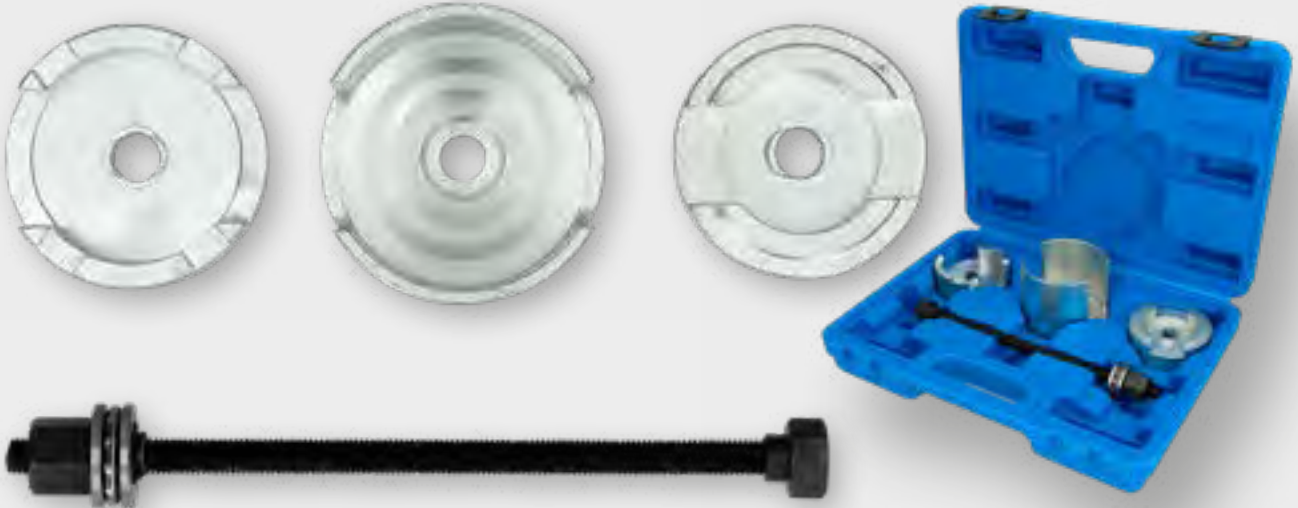

**77,- €**

**6**  
pcs.

Ford Fiesta/Ka

**BT672400**  
**EAN 4042146781272**  
Rear axle bush tool - Ford, 6 pcs



**65,- €**

7  
pcs.

Fiat Stilo/Bravo

**BT672250**  
**EAN 4042146781371**  
 Mounting tool f. rear axle  
 silent blocks, Fiat, 7 pcs



**44,- €**



10  
pcs.

BMW E81, E82, E83, E85, E86, E87,  
 E88, E90, E91, E92, E93, F20

**BT672200**  
**EAN 4042146781388**  
 BMW Rearflower control arm bush,  
 Installer/remover (E90), 10 pcs



**129,- €**





**BT672450**  
**EAN 4042146781074**  
Press and pull sleeve kit,  
26 pcs

**26**  
pcs.



22 x



Ø1: 34 - 80 mm  
Ø2: 44 - 90 mm

1 x



1 x



4 x



M10 x 1,5  
M12 x 1,75  
M14 x 2,0  
M16 x 2,0

**219,- €**

**BT676007**  
**EAN 4042146781357**  
Universal press support, 24 pcs

**24**  
pcs.

20 t.

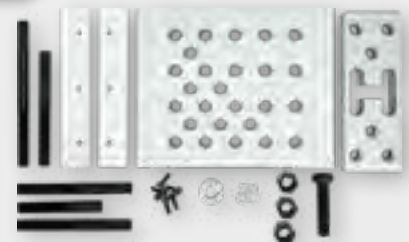

**179,- €**

## CAR GLASS

16 mm

**BT686001**  
**EAN 4042146781494**  
Wiper arm removal tool,  
16mm

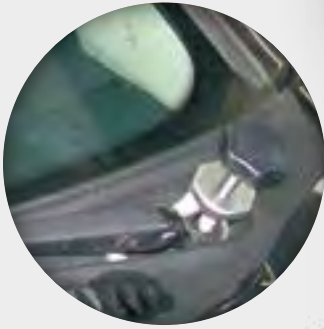

**5,- €**

23 mm

**BT686002**  
**EAN 4042146781500**  
Wiper arm removal tool,  
23mm

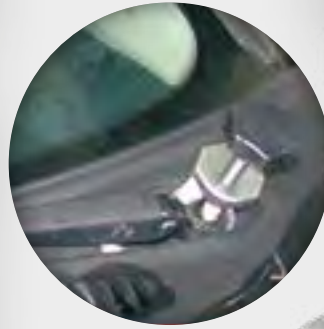

**5,- €**

**BT686000**  
**EAN 4042146781487**  
Battery terminal  
wiper arm puller



**12,- €**

**8**  
pcs.

Alfa Romeo, BMW, Citroen, Fiat, Ford, Honda, Jaguar, Mazda,  
MG-Rover, MB, Mitsubishi, Opel, Vauxhall, Peugeot, Renault, Saab,  
Seat, Skoda, VAG, Mercedes Benz, Land Rover, Hyundai

**BT681000**

**EAN 4042146781517**

Wiper arm removal set, 8 pcs

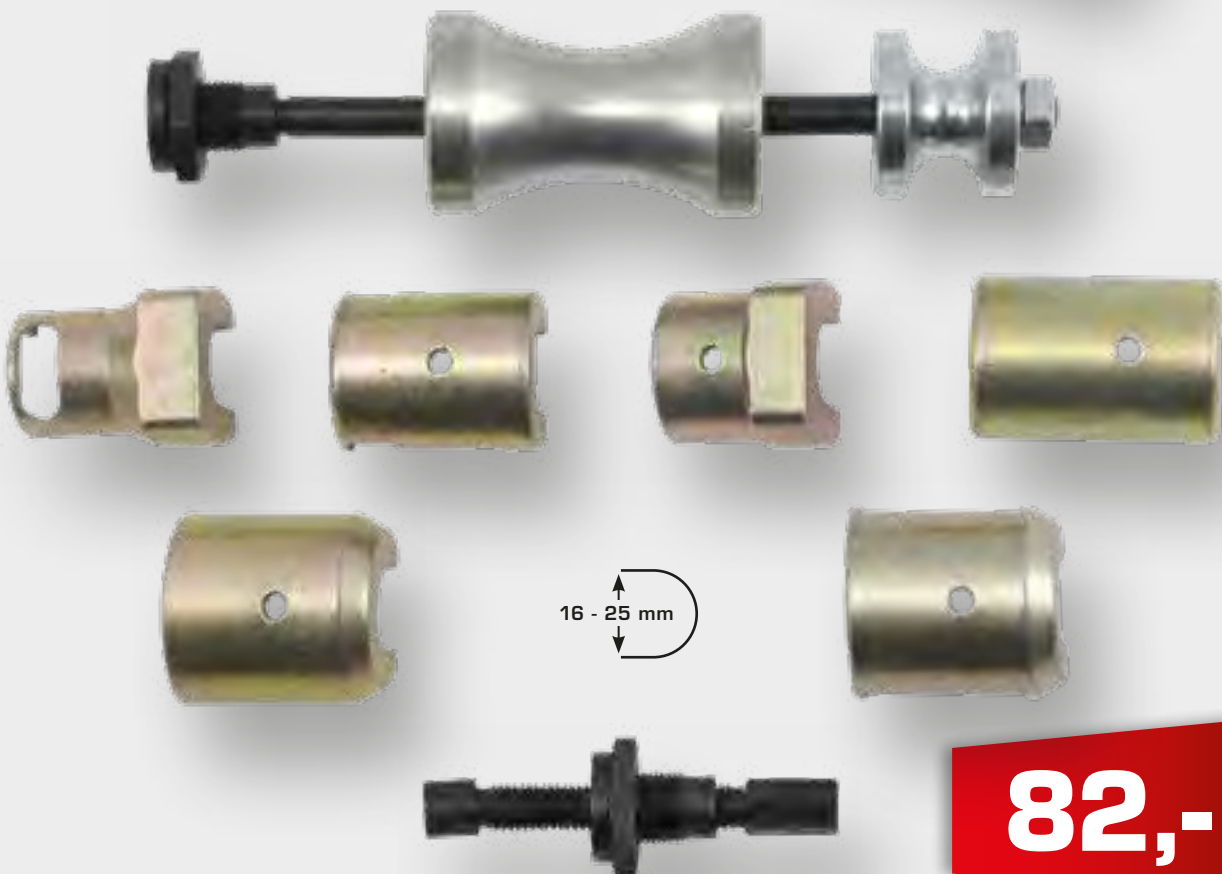
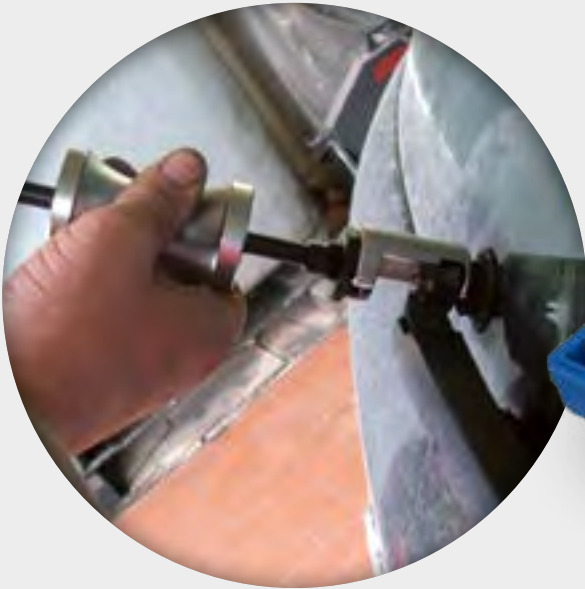

**82,- €**

## CAR GLASS

**BT686003**  
**EAN 4042146781456**  
Draw knife for glued disks



**12,- €**

**BT681150**  
**EAN 4042146781463**  
Handles with pull wire, 3 pcs



**3**  
pcs.

**12,- €**

**BT681100**  
**EAN 4042146781449**  
Windshield removal tool set, 7 pcs



**7**  
pcs.

**39,- €**



**6**  
pcs.

**BT681050**  
**EAN 4042146781470**  
Wiper arm puller set, 6 pcs



20 - 40 mm



20 - 60 mm



18 mm



23,5 mm



26 mm



26,5 mm

**95,- €**

## WHEEL AND TYRE MOUNTING

2  
pcs.

BT691011  
EAN 4042146844823  
1/2" 4in1 impact socket set



21,- €

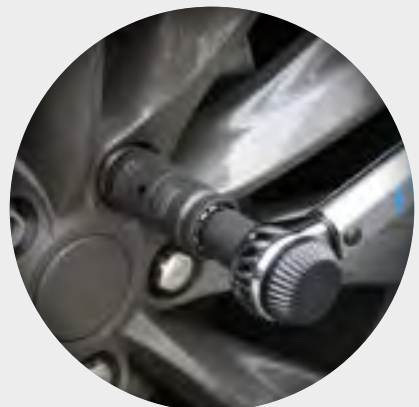
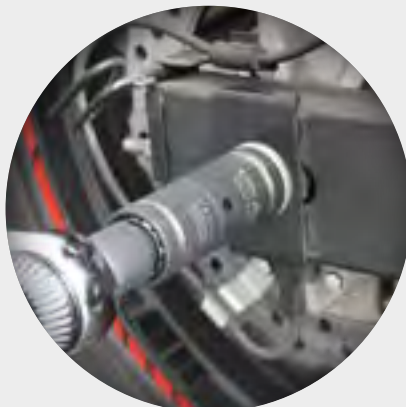
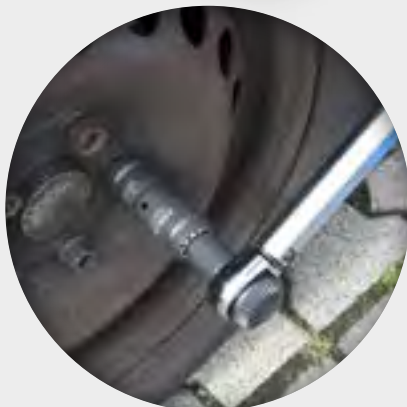

SW 15 mm

**BT691004**  
**EAN 4042146844670**  
1/2" impact socket for aluminium rims,  
15 mm

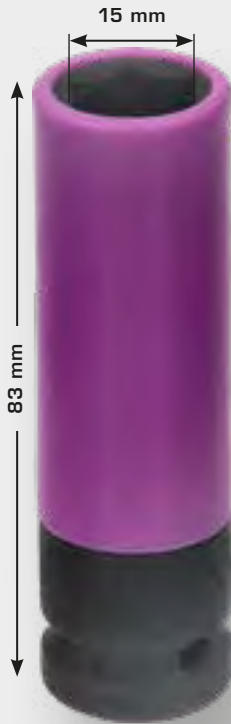

**6,- €**

SW 17 mm

**BT691006**  
**EAN 4042146844236**  
1/2" impact socket for aluminium rims,  
17 mm



**6,- €**

SW 19 mm

**BT691007**  
**EAN 4042146844243**  
1/2" impact socket for  
aluminium rims, 19 mm



**6,- €**

SW 21 mm

**BT691008**  
**EAN 4042146844250**  
1/2" impact socket for  
aluminium rims, 21 mm



**7,- €**

SW 22 mm

**BT691009**  
**EAN 4042146844687**  
1/2" impact socket for  
aluminium rims, 22 mm



**8,- €**

## WHEEL AND TYRE MOUNTING

**BT691005**  
**EAN 4042146844229**  
1/2" impact socket set for aluminium rims



**3**  
pcs.



17 mm



19 mm



21 mm

**15,- €**

**BT691010**  
**EAN 4042146844663**  
1/2" impact socket set for aluminium rims  
15 / 17 / 19 / 21 / 22 mm

**5**  
pcs.



**25,- €**



15 mm



17 mm



19 mm



21 mm



22 mm

Ø 110 mm

**BT691159**

**EAN 4042146856277**

Plastic magnetic cup / half shell Ø 11 cm



Ø 110 mm



**5,- €**

Ø 150 mm

**BT691160**

**EAN 4042146813065**

Stainless steel magnetic tray / shell Ø 15 cm

Ø 150 mm



**6,- €**

140 x 240 mm

**BT691165**

**EAN 4042146813072**

Stainless steel magnetic tray / shell 140 x 240 mm

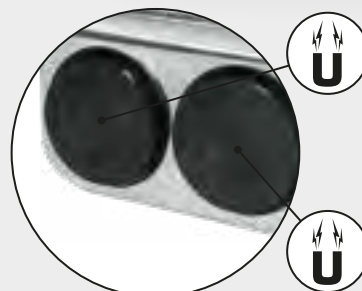

**11,- €**

## WHEEL AND TYRE MOUNTING

**BT691166**  
**EAN 4042146868393**

Stainless steel magnetic tray /  
shell with plastic frame  
140 x 240 mm

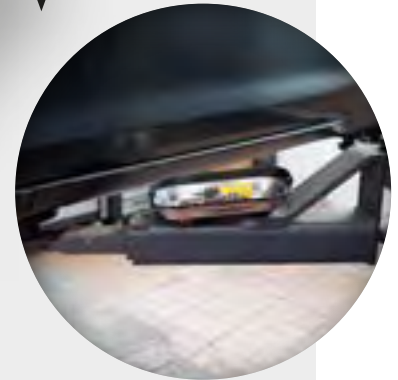

**16,- €**

**2**  
pcs.

**BT691155**  
**EAN 4042146863718**

Stainless steel magnetic tray /  
shell set 65 x 226 mm, 2 pcs

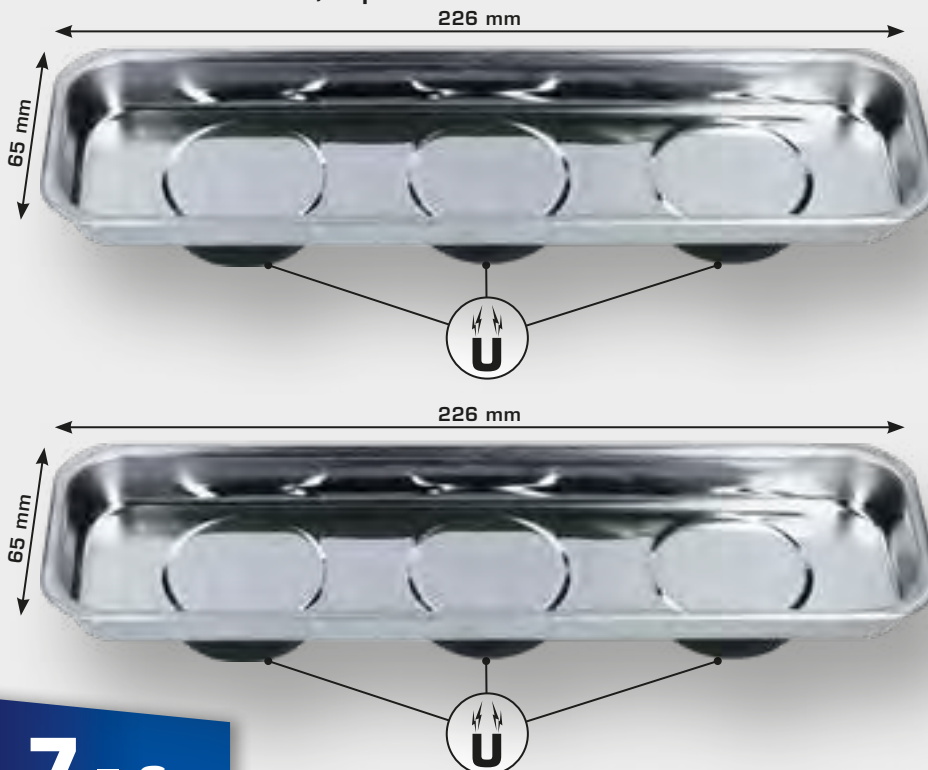

**7,- €**



**22**  
pcs.

**Audi**



**BT691360**  
**EAN 4042146849149**  
Wheel locking key set for  
Audi, 22 pcs

**100,- €**



**10**  
pcs.

**BMW**



**BT691170**  
**EAN 4042146813232**  
Wheel locking key set for  
BMW 10 pcs

**45,- €**



## WHEEL AND TYRE MOUNTING

**10**  
pcs.

BMW



**BT691290**  
**EAN 4042146813287**  
Wheel locking key set for  
BMW 10 pcs

**45,- €**



**21**  
pcs.

BMW



**BT691230**  
**EAN 4042146813263**  
Wheel locking key set for BMW  
21 pcs

**109,- €**





**BMW**

**22  
pcs.**



**BT691050**  
**EAN 4042146781548**  
Wheel locking key set for  
BMW, 22 pcs



**105,- €**

**Mercedes**

**12  
pcs.**



**BT691210**  
**EAN 4042146813256**  
Wheel locking key set for  
Mercedes, 12 pcs

**59,- €**

## WHEEL AND TYRE MOUNTING



**21**  
pcs.

Porsche

BT691330  
EAN 4042146813300  
Wheel locking key set for  
Porsche 20 pcs

**109,- €**



**23**  
pcs.

VW

BT691260  
EAN 4042146813270  
Wheel locking key set for  
VW 23 pcs

**109,- €**



VW

**10**  
pcs.



**BT691310**  
**EAN 4042146813294**  
Wheel locking key set  
for VW 10 pcs



**45,- €**



VW

**12**  
pcs.



**BT691190**  
**EAN 4042146813249**  
Wheel locking key set for  
VW 12 pcs



**49,- €**

## WHEEL AND TYRE MOUNTING



**22**  
pcs.

VW

**BT691390**  
**EAN 4042146849156**  
Wheel locking key set for  
VW, 22 pcs



**100,- €**

**4**  
pcs.

**BT691100**  
**EAN 4042146781531**  
Tyre lever set, 4 pcs

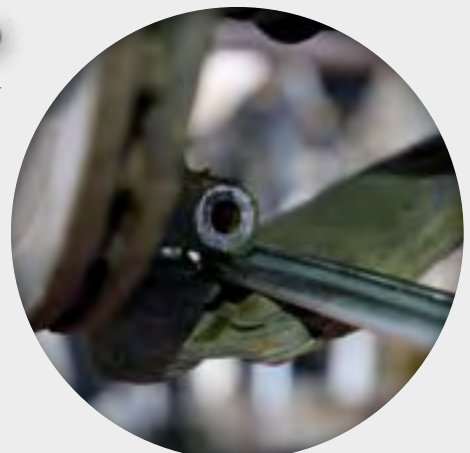
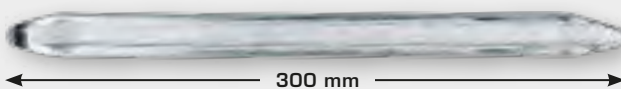
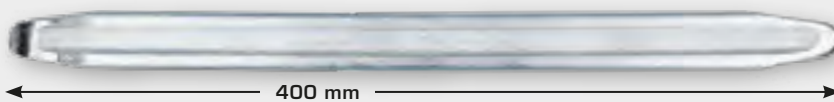

**28,- €**

**BT691012**  
**EAN 4042146844854**  
Valve retractor



**9,- €**

**BT691013**  
**EAN 4042146868546**  
Pliers for balancing weights



**13,- €**

**4**  
pcs.

**BT691150**  
**EAN 4042146781524**  
Plastic scraper set, 4 pcs

38 mm



25 mm



22 mm



19 mm



**18,- €**

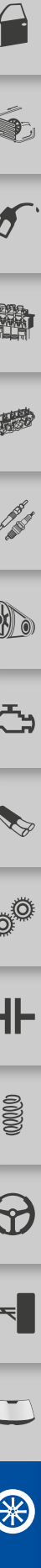

## WHEEL AND TYRE MOUNTING

0 - 16 bar

**BT691019**

**EAN 4042146844687**

Tyre inflation gauge, 0-16 bar



**12,- €**

1/2" x 17 x 19 x 22

**BT691015**

**EAN 4042146867969**

Wheel brace, 1/2" x 17 x 19 x 22 mm



**12,- €**

# WITH THIS YOU MAKE A LOT OF PRESSURE!

**1.450 Nm**

**BRILLIANT<sup>®</sup>  
TOOLS**  
powered by **KSTOOLS**

**59,- €**

BT160100  
EAN 4042146844403  
1/2" Pneumatic impact wrench 1.450 Nm



## BRAKING SERVICE

**BT706001**  
**EAN 4042146781616**  
Electronic brake fluid tester

INCLUDED  
1 X 1,5V  
AAA  
BATTERY

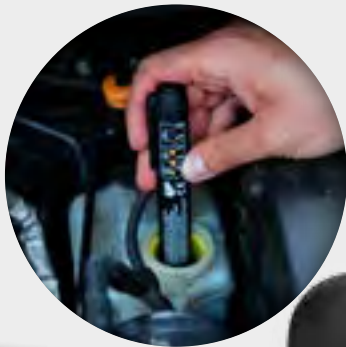

**15,- €**



**BT706004**  
**EAN 4042146844861**  
Mini pipe cutter

Ø 3 - 16 mm

Titan HSS



**7,- €**

**BT706008**  
**EAN 4042146868386**  
Universal brake line flaring  
tool 4,75 mm



**29,- €**





**2**  
pcs.

**BT701260**  
**EAN 4042146878255**  
**Brake venting device**

**TECHNICAL DATA**

Work pressure 2,7 bar  
Length of hose 6 meter  
Tank volume 5 liter



**129,- €**



## BRAKING SERVICE

**BT701220**  
**EAN 4042146876718**  
 Bleed nozzle adaptor set  
 for brake bleeding



**20**  
 pcs.

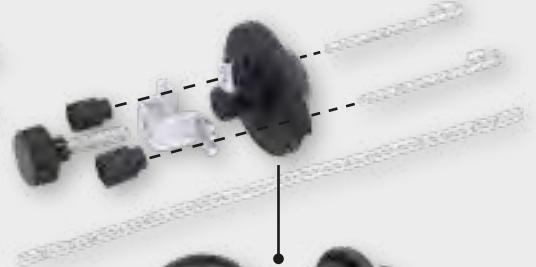
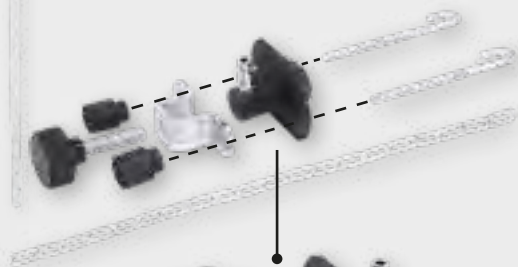

**69,- €**

**BT701200**  
**EAN 4042146781562**  
 Pneumatic brake fluid bleeder kit

**6**  
 pcs.

0,7 L

1,0 L

**36,- €**



**BT706000**  
**EAN 4042146781579**  
Brake piston wind  
back tool



**17,- €**

**BT706006**  
**EAN 4042146844885**  
Universal brake piston  
reset tool, 15-90 mm



**19,- €**

**BT706007**  
**EAN 4042146867211**  
Ratchet brake piston  
resetter, reversible



**23,- €**

## BRAKING SERVICE

**BT701150**  
**EAN 4042146781623**

Adjustable brake caliper rewind  
 tool kit, 6 pcs

**6**  
 pcs.

**31,- €**

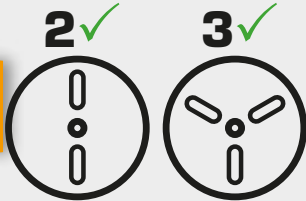

**BT701000**  
**EAN 4042146781586**

Universal caliper wind back kit,  
 13 pcs

**13**  
 pcs.

### INDICATIONS

Citroën XM, Xantia, u.a.

Alfa Romeo, Audi, Austin,  
 BMW, Ford, Honda, Jaguar

Alfa Romeo 164 2.0, Ford,  
 Mazda, Saab 9000, Subaru

Nissan Primera, Volkswagen  
 Golf IV, Opel Astra

Audi 80/90/100/V8, Ford  
 Sierra ABS + Scorpio ab 85,  
 Honda Prelude, Nissan Silvia  
 1.8 Turbo, Rover

General Motors, Renault

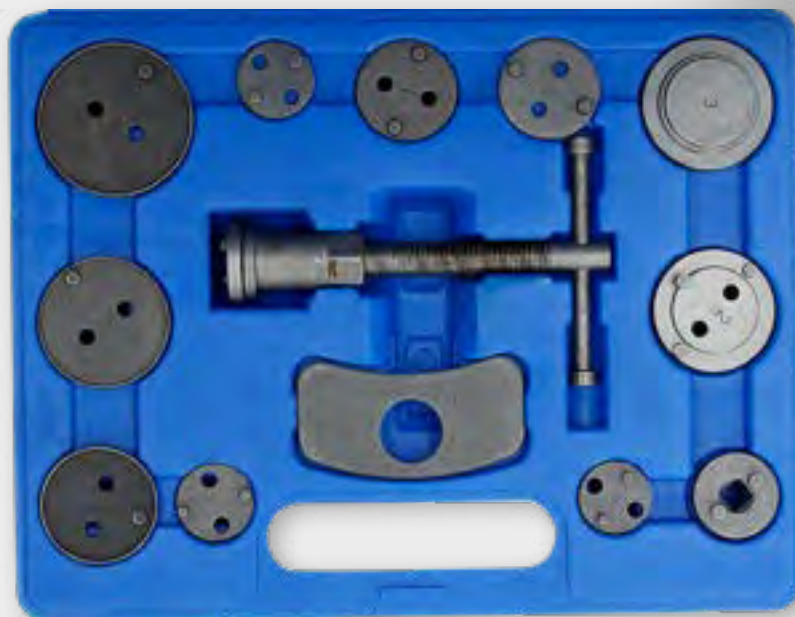

**39,- €**

**41**  
pcs.

**BT701050**  
**EAN 4042146781593**  
Brake piston caliper wind back kit,  
41 pcs



**INDICATIONS**

Alfa Romeo, Audi, BMW,  
BMW Mini, Citroen, Fiat

Ford (Australia), Ford  
(Europa), Ford (USA)

General Motors (GM),  
Honda, Isuzu, Jaguar,  
Lancia

Mazda, Mercedes Benz,  
Mini Austin, Mitsubishi

Nissan, Opel, Peugeot,  
Proton, Renault, Rover,  
Saab

Seat, Subaru, Toyota,  
Volkswagen, Volvo



**119,- €**

## BRAKING SERVICE

BT706010  
EAN 4042146867419  
Hook Set, 2 pcs

2  
pcs.

6,- €

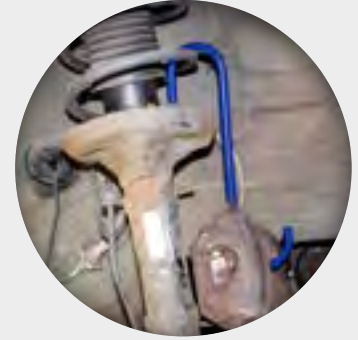

BT701250  
EAN 4042146781630  
Universal brake drum and disc tool set,  
15 pcs

15  
pcs.

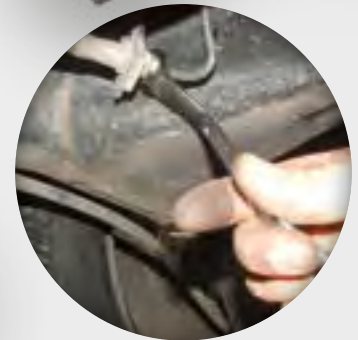

145,- €



**BT701100**  
**EAN 4042146781609**  
Brake thread repair kit  
M9x1.25, 16 pcs

**16**  
pcs.

VAG, Opel, Vauxhall, Ford



**54,- €**

**BT676005**  
**EAN 4042146781173**  
Ford Transit Rear  
hub puller

Ford Transit



**189,- €**

## OIL SERVICE

**BT711108...109**

Band wrench for oil filter casing

Ø 65 - 155 mm



start from **7,- €**

BT No.	Ø mm	EAN 4042146+	PRICE
BT711108	65 - 110	871294	7,00
BT711109	110 - 155	871300	9,00

**BT711003...004**

Universal oil filter spanner



start from **9,- €**

BT No.	Ø mm	EAN 4042146+	PRICE
BT711003	60 - 90	844892	9,00
BT711004	80 - 120	844908	10,00

**BT711105...107**

Oil filter spanner, 3-arm

Ø 60 - 150 mm

1/2" 12,5 mm



start from **11,- €**

BT No.	Ø mm	EAN 4042146+	PRICE
BT711105	60 - 110	866672	11,00
BT711106	80 - 135	866689	15,00
BT711107	95 - 150	866696	20,00







**19**  
pcs.





3/8" 1/2"  
10 mm 12,5 mm





**BT711010**  
**EAN 4042146813416**  
Oil filter spanner set, 19 pcs



**136,- €**

<b>1x</b>		63/ 64 mm x 14-kant for Toyota
<b>1x</b>		66,5 mm x 14-kant for Ford / Mazda
<b>1x</b>		70 / 64,5 mm x 14-kant for Toyota Auris, Corolla, Premio, Prius with 1.8 L and 2.0 L Benzin-Motoren
<b>1x</b>		74 mm x 14-kant for BMW / Audi / VW / Opel,
<b>1x</b>		79 mm x 15-kant for Ford / Daihatsu

<b>1x</b>		79,5 / 64,5 mm x 14-kant for Toyota / Lexus
<b>1x</b>		84 mm x 14-kant for Mercedes Vito and Sprinter with V6 and V8 Diesel-Motoren (OM 642 and OM 920)
<b>1x</b>		87 mm x 16-kant for BMW / Volvo
<b>1x</b>		92 mm x 15-kant for Honda Civic /Toyota,
<b>1x</b>		94,5 mm x 15-kant for Alfa Romeo / Chrysler / Ford / GM / Toyota

<b>1x</b>		100,5 mm x 15-kant for Daihatsu / Mazda / Withsubishi / Toyota
<b>1x</b>		Oil filter cap Ø 67 - 10 cm
<b>6x</b>		Socket 24 mm / 27 mm 30 mm / 32,5 mm / 36 mm / 38 mm
<b>1x</b>		Socket spanner adapter   internal square drive 10 mm (3/8") - external square drive 12.5 mm (1/2")



**BT711050**  
**EAN 4042146781708**  
 Oil filter cap wrench set,  
 30 pcs

**30**  
 pcs.

**3/8"**  
 10 mm



**109,- €**

 Ø 65 mm x 14F	 Ø 74 / 76 mm x 15F	 Ø 78 mm x 15F	 Ø 92 mm x 10F	 Ø 100 mm x 15F
 Ø 66/68 mm x 14F	 Ø 75 / 77 mm x 15F	 Ø 80 mm x 15F	 Ø 93 mm x 15F	 Ø 106 mm x 15F
 Ø 66 mm x 6F	 Ø 76 mm x 8F	 Ø 80 / 82 mm x 15F	 Ø 93 mm x 36F	 Ø 108 mm x 15F
 Ø 68 mm x 14F	 Ø 76 mm x 12F	 Ø 86 mm x 16F	 Ø 93 mm x 45F	 Ø 108 mm x 18F
 Ø 73 mm x 14F	 Ø 76 mm x 14F	 Ø 86 mm x 18F	 Ø 95 mm x 15F	 10 mm (3/8") x 12,5 mm (1/2")
 Ø 74 mm x 15F	 Ø 76 mm x 30F	 Ø 90 mm x 15F	 Ø 96 mm x 18F	 Ø 65 - 120 mm

**BT716000**  
**EAN 4042146781647**  
Haldex Filter service tool 46mm

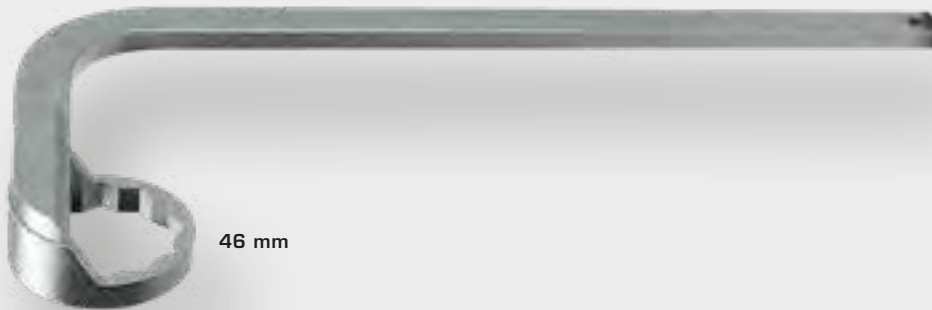

46 mm



**20,- €**

**12**  
pcs.

**BT711150**  
**EAN 4042146781661**  
Oil drain sump plug key socket set, 12 pcs

**3/8"**  
10 mm

<b>7 x</b> ●		3/8" • 8 • 9 • 10 • 12 • 14 • 17 mm
<b>4 x</b> ■		5/16" • 3/8" • 11 • 13 mm
<b>1 x</b>		Slider



**31,- €**



## OIL SERVICE

5 - 13 L

**BT716003...005**

Oil drip tray / multifunctional tray



start from **7,- €**

BT No.	L	EAN 4042146+	€
BT716003	5	870570	7,00
BT716004	8	870587	9,00
BT716005	13	870594	12,00

16 L

**BT716002**

**EAN 4042146781722**

Portable oil drain pan 16 L

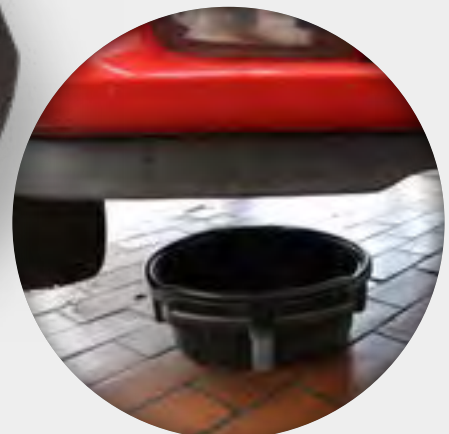
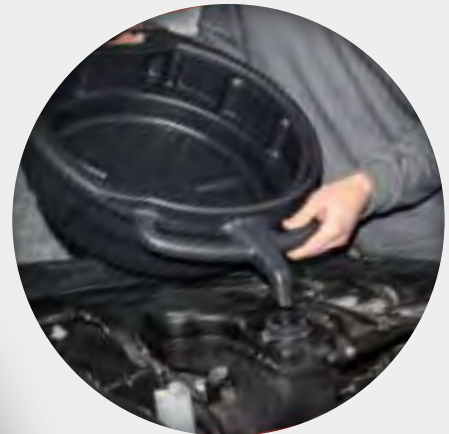













**15,- €**

**543**  
pcs.

**BT711200**  
**EAN 4042146781678**  
Oil pan plug screws and O-ring set,  
543 pcs



<b>5x</b>		M10 x 1,0	<b>50x</b>		Interior diameter 6,5 mm / Dicke 1,5 mm
<b>5x</b>		M12 x 1,5	<b>50x</b>		Interior diameter 8,3 mm / Dicke 1,5 mm
<b>5x</b>		M13 x 1,5	<b>50x</b>		Interior diameter 10,3 mm / Dicke 1,5 mm
<b>5x</b>		M14 x 1,5	<b>50x</b>		Interior diameter 12,4 mm / Dicke 1,5 mm
<b>5x</b>		M15 x 1,5	<b>50x</b>		Interior diameter 13,3 mm / Dicke 1,5 mm
<b>5x</b>		M15 x 1,5	<b>50x</b>		Interior diameter 14,4 mm / Dicke 1,5 mm
<b>3x</b>		M16 x 1,5	<b>50x</b>		Interior diameter 15,4 mm / Dicke 1,5 mm
<b>3x</b>		M18 x 1,5	<b>50x</b>		Interior diameter 16,3 mm / Dicke 1,5 mm
<b>3x</b>		M20 x 1,5	<b>50x</b>		Interior diameter 18,4 mm / Dicke 1,5 mm
<b>3x</b>		M20 x 1,5	<b>50x</b>		Interior diameter 20,4 mm / Dicke 1,5 mm

**76,- €**



**BT711250**  
**EAN 4042146781685**  
Repair set for oil drain  
screw thread, 64 pcs

**64**  
pcs.

M13 x 1,25 • M15 x 1,5  
M17 x 1,5 • M20 x 1,5



**49,- €**

<b>1x</b>		M20 x 1,5	<b>1x</b>		M13 x 1,25	<b>5x</b>		M15 x 1,5
<b>1x</b>		M17 x 1,5	<b>5x</b>		M20 x 1,5	<b>5x</b>		M13 x 1,25
<b>1x</b>		M15 x 1,5	<b>5x</b>		M17 x 1,5	<b>20x</b>		5 x M13 • 5 x M15 • 5 x M17 • 5 x M20

**114**  
pcs.

M13 x 1,25 • M13 x 1,5 • M15 • 1,5  
M17 x 1,5 • M20 • 1,5 • M22 X 1,5

**BT711300**  
**EAN 4042146781692**

Repair set for oil drain screw thread,  
114 pcs



<b>1x</b>		M22 x 1,5	<b>6x</b>		M22 x 1,5
<b>1x</b>		M20 x 1,5	<b>6x</b>		M20 x 1,5
<b>1x</b>		M17 x 1,5	<b>6x</b>		M17 x 1,5
<b>1x</b>		M15 x 1,5	<b>6x</b>		M15 x 1,5
<b>1x</b>		M13 x 1,5	<b>6x</b>		M13 x 1,5
<b>1x</b>		M13 x 1,25	<b>6x</b>		M13 x 1,25
			<b>36x</b>		12 x M13, 6 x M15, 6 x M17, 6 x M20, 6 x M22

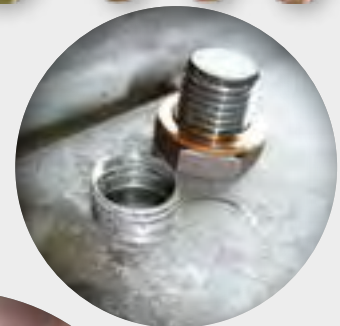
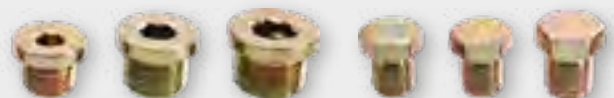

**69,- €**

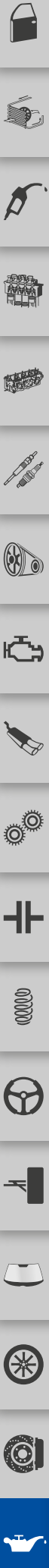

**BT711130**  
**EAN 4042146853504**  
Oil funnel with adaptor for  
VAG, 2 pcs

**2**  
pcs.

VAG

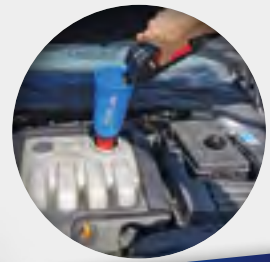

**12,- €**

**BT711110**  
**EAN 4042146853511**  
MASTER oil filler funnel set with rotatable,  
15 pcs

**15**  
pcs.



<b>1</b>		<b>Bayonet thread adapter</b> for Dodge
<b>2</b>		<b>Bayonett-adaptor</b> for Audi, BMW, Mercedes, Porsche, Škoda, Seat, Volvo, Volkswagen
<b>3</b>		<b>Bayonett-adaptor</b> for Toyota, Lexus
<b>4</b>		<b>M37x3,0 adapter</b> for Lotus, Pontiac, Lexus, Toyota
<b>5</b>		<b>Bayonet thread adapter</b> for Volkswagen, Audi, Seat, Škoda
<b>6</b>		<b>Bayonet thread adapter</b> for Cadillac, Chevrolet, Ford, Hyandai, Jaguar, Land Rover, Mazda, Sastart from
<b>7</b>		<b>M35x4,0 adapter</b> for Ford, Jaguar, Land Rover, Mazda
<b>8</b>		<b>Bayonet thread adapter</b> for Mazda, Volvo
<b>9</b>		<b>M37x3,0 adapter for</b> Lotus, Pontiac, Scion, Toyota
<b>10</b>		<b>M32x3,5 adapter</b> for Dodge, Ford, Honda, Jaguar, Jeep, Land Rover, Mazda, Nissan
<b>11</b>		<b>M30x3,0 adapter</b> for Dodge
<b>12</b>		<b>M42x4,5 adapter</b> for Subaru



**59,- €**



**WORK  
BRILLIANT**





BRILLIANT®  
**TOOLS**

powered by **KSTOOLS**



# ENGINE ADJUSTMENT TOOLS

CATALOG 2022





# CONTENTS













Page 343



Page 354

	Alfa Romeo	332
	Audi	336
	BMW	348
	Chevrolet	356
	Chrysler	358

	Citroën	360
	Fiat	366
	Ford	374
	Iveco	382
	Jaguar	384





	Jeep	386
	Lancia	388
	Land Rover	392
	Mercedes	400
	MG	404

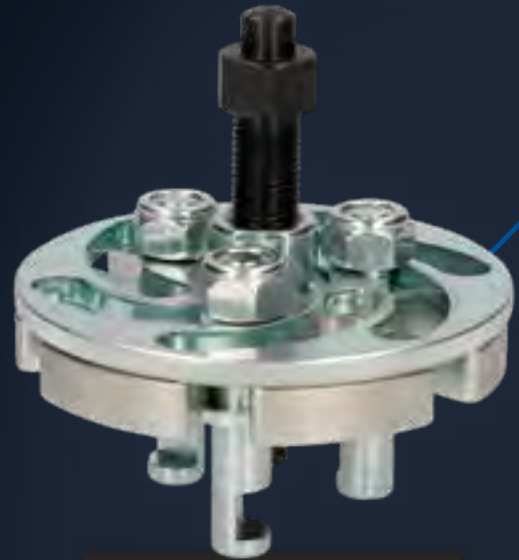







Page 346



Page 346

	Mini	406
	Mitsubishi	408
	Nissan	410
	Opel	412
	Peugeot	420

	Porsche	428
	Renault	430
	Saab	434
	Seat	436
	Škoda	442

	Subaru	450
	Volvo	452
	Volkswagen	456

# ALFA ROMEO

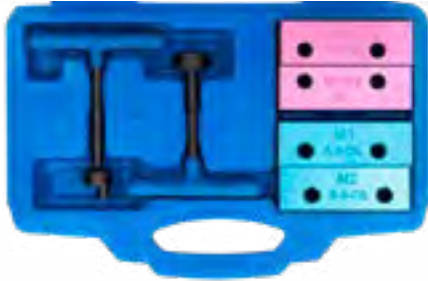

**FITS FOR:**

ART.NR	ITEM NAME	PRICE
<b>BT591250</b>	Engine adjustment tool set for Alfa Romeo 1.4, 1.6, 1.8, 2.0 Twin-Spark	<b>49,00 €</b>

#### DESCRIPTION

For adjusting engine timing when replacing the toothed belt, repairing the cylinder head, replacing the cylinder head seal, etc.

Suitable for Alfa Romeo models 145, 146, 147, 155, 156, 166, Spider, GTV

Fits Twin Spark engines 1.4, 1.6, 1.8, 2.0 | 16V Twin Cam, engine code 162.01, 322.01, 323.01, 323.10 / 335.03, 671.06, 672.04, 676.01

#### DELIVERY SCOPE

- Tool for toothed belt tensioner, use as OEM 1822149000
- Tool for balance shaft, use as OEM 1822154000
- Camshaft interlock (purple), use as OEM 1825042000
- Camshaft interlock (blue), use as OEM 1825041000



**FITS FOR:**

ART.NR	ITEM NAME	PRICE
<b>BT591350</b>	Engine adjustment tool set for Fiat, Lancia, Alfa Romeo	<b>249,00 €</b>

#### FOR THE FOLLOWING MODELS

Alfa Romeo 145 1.4, 1.6 16V Step A – 146 1.4, 1.6 16V Step A – 147 1.6 16V Step A – 147 105 PS – 147 1.6 eco 103 PS – 155 1.4, 1.6 16V Step A – 156 1.6 16V Step A – 156 1.8, 2.0 16V – 156 2.0 JTS – 166 2.0 – GTV 2.0 JTS – Spider GT 2.0 JTS 16V 165 PS

Lancia K5 2.0 20V, 4-cylinder, VIS engines start from year of construction 1996 onwards, Delta 1.8 16V Step A, Dedra 1.8 16V Step A, Y10 1.4 12V

Fiat Bravo 1.4 12V, 2.0 20V – Brava 1.4 12V, 2.0 20V – Marea 2.0 20V, Coupe 1.8 16V, Barchetta 1.8 16V, Punto 1.8 16V

#### DESCRIPTION

Special insert, drive square socket 12.5 mm (1/2") for dismantling the phaser

23 precisely fitting locking devices for the feed and discharge camshaft

prevent the camshafts start from twisting after assembly and position them in assembly position for the toothed belt.

The locking devices are labelled with numbers and additionally colour-coded to avoid confusion

The OT point adjustment mandrel and a micrometer clock (not scope of delivery) makes a precise alignment of the crankshaft possible

#### DELIVERY SCOPE

Cam shaft locking devices, use as OEM 1 825 041 000, 1 825 042 000, 1 860 096 100, 1 860 819 000, 1 860 847 000, 1 860 892 000, 1 860 899 000, 1 870 797 000

Bracket for dial gauge for adjusting the piston OT (requires dial gauge), use as 1 860 895 000, 1 895 879 000, 1 825 013 000

Insert for phaser, use as OEM 1 822 110 000, 1 852 161 000



**FITS FOR:**

ART.NR	ITEM NAME	PRICE
<b>BT595703</b>	Camshaft locking tool for Opel 1.6, 1.8	<b>7,00 €</b>

#### DESCRIPTION

Contains important tools for inspecting and adjusting the engine timing

Suitable for Opel Astra G/H, Corsa D, Insignia, Meriva, Signum, Tigra, Vectra C, Zafira B (2003-2012) with engine codes A16LET, A16XER, Z16LEL, Z16LER, Z16LET, Z16XE, Z16XE1, Z16XEP, Z16XER, Z18XER, A18XER

Also suitable for Alfa Romeo 159, Fiat Croma with engine code 939A4.000

#### DELIVERY SCOPE

- Camshaft interlock, use as OEM KM-6340, EN-6340, 2000012100
- Tensioning element interlock, use as OEM KM-6333, EN-6333



**FITS FOR:**

ART.NR	ITEM NAME	PRICE
<b>BT591215</b>	Engine adjustment tool set for Alfa Romeo 2.0 JTS	<b>31,00 €</b>

#### FOR THE FOLLOWING MODELS

Alfa Romeo 156, GT, GTV, Spider 2.0 JTS (165 PS) with engine codes: 937A1000, 932A2000

#### DESCRIPTION

For checking and adjusting the camshaft timing  
Needed when replacing the toothed belt

#### DELIVERY SCOPE

- Balance shaft belt clamping tool, use as OEM 1822154000
- Toothed belt clamping tool, use as OEM 1822149000
- Intake camshaft locking block, use as OEM 1860856001
- Exhaust camshaft locking block, use as OEM 1860831002

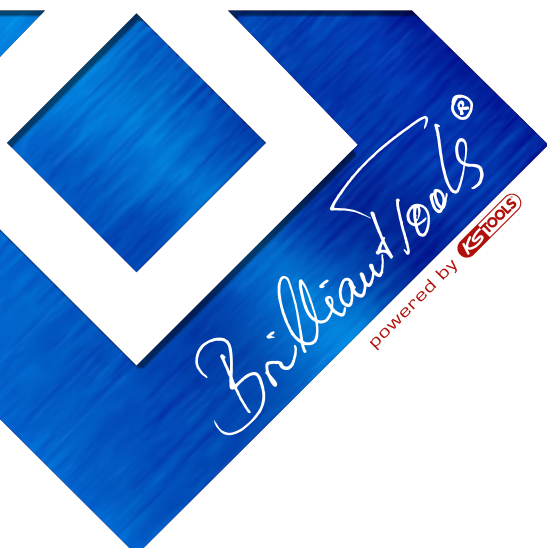



ART.NR	ITEM NAME	PRICE
BT594450	Engine adjustment tool set for Fiat, Opel, Alfa 1.9, 2.4 16V Diesel	40,00 €

#### FOR THE FOLLOWING MODELS

Opel 1.9 CDTi Z19DT, Z19DTH, Z19DTJ

Alfa-Romeo 1.9 and 2.4 L diesel with engine code: 323.02, 371.01, 342.02, 325.01, 362.02, 182B9.000, 937A2.000, 937A3.000, 192A5.000, 192B1.000, 937A4.000, 937A5.000, 939A2.000, 939A1.000, 939A7.000, 939A8.000, 839A6.000, 841C.000

Fiat 1.9 and 2.4 L diesel with engine code: 182B4.000, 182B9.000, 185A6.000, 186A6.000, 186A8.000, 186A9.000, 188A2.000, 188A7.000, 188B2.000, 192A1.000, 192A3.000, 192A5.000, 192A8.000, 192A9.000, 192B4.000, 192B5.000, 198A2.000, 198A3.000, 198A6.000, 199A5.000, 223A7.000, 937A5.000, 939A1.000, 939A2.000, 939A3.000, 939A7.000

#### DESCRIPTION

For adjusting the engine timing e.g. when replacing the toothed belt, repairing the cylinder head, etc.

#### DELIVERY SCOPE

Crankshaft interlock, use as OEM Opel EN-4678B, Fiat 1.860.905.000, 1.860.905.010

Flywheel interlock, use as OEM Fiat 1.860.898.000

Camshaft interlock, use as OEM Opel EN-46789, Fiat 1.870.896.900

Marking mandrel Ø 3.7mm x 70mm, use as OEM Opel KM 6130, KM 6349



ART.NR	ITEM NAME	PRICE
BT592700	Engine adjustment tool set for Alfa Romeo, Fiat 1.4 MultiAir	69,00 €

#### FOR THE FOLLOWING MODELS

Alfa Romeo Giulietta, Mito, Fiat Punto, Punto Evo 1.4 (Turbo) MultiAir (105/135/163/170PS)

Engine codes: 940A2.000, 940A2.000, 955A8.000, 955A8.000, 940A2.000, 955A8.000, 955A2.000, 955A7.000, 955A6.000, 955A8.000

#### DESCRIPTION

For adjusting the engine timing when replacing the toothed belt

#### DELIVERY SCOPE

Camshaft adjustment tool including 3 fastening screws, use as OEM 2000034400

Crankshaft locking tool including 4 fastening screws, use as OEM 2000004500

Tension roller key, use as OEM 1860987000

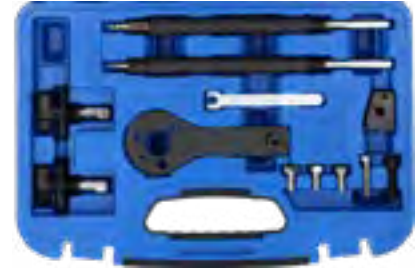

ART.NR	ITEM NAME	PRICE
BT591320	Engine adjustment tool set for Fiat, Alfa Romeo, Lancia 1.2 16V, 1.4 16V, T-Jet	35,00 €

#### FOR THE FOLLOWING MODELS

Adjustment tool for piston height, use as OEM 1.860.992.000

#### DESCRIPTION

For adjusting engine timing when replacing the toothed belt, repairing the cylinder head, replacing the cylinder head seal, etc.

Suitable for Alfa Romeo, Fiat and Lancia 1.2 16V, 1.4 16v, 1.4 T-Jet

Engine codes e.g. 169A3000, 179B9000, 182B2000, 188A5000, 192B2000, 198A1000, 198A4000, 199A6000, 199A8000, 843A1000

#### DELIVERY SCOPE

Crankshaft interlock (with screws M6x30 and 3 pcs M8x16), use as OEM 2.000.004.500

Camshaft adjustment tools (1 pair), use as OEM 1.860.985.000

Adjustment tool for piston height, use as OEM 1.860.992.000

Adjustment spanner for toothed belt tensioner, use as OEM 1.860.987.000

Interlock tool for camshaft sprockets (with M8x30 screw), use as OEM 2.000.015.800





FITS FOR:

ART.NR	ITEM NAME	PRICE
<b>BT591245</b>	Camshaft locking tool set for Alfa Romeo, Lancia 3.0 V6 24V	<b>34,00 €</b>

**FOR THE FOLLOWING MODELS**

Alfa Romeo, Lancia 3.0L V6 24V

**DESCRIPTION**

For checking and adjusting the camshaft timing  
Use as OEM 1825040000

**DELIVERY SCOPE**

Camshaft adjustment tool for intake cam 1-cylinder  
Camshaft adjustment tool for exhaust cam 1-cylinder  
Camshaft adjustment tool for intake cam 6-cylinder  
Camshaft adjustment tool for exhaust cam 4-cylinder



FITS FOR:

ART.NR	ITEM NAME	PRICE
<b>BT591235</b>	Camshaft locking tool set for Alfa Romeo 2.0l 16V JTS	<b>17,00 €</b>

**FOR THE FOLLOWING MODELS**

Alfa Romeo 147, 156, 166, GTV, Spider GT with 2.0 16V JTS (165 PS) engine

**DESCRIPTION**

For checking and adjusting the camshaft timing  
Use as OEM 1870859000

**DELIVERY SCOPE**

Camshaft adjustment tool for intake cam 2-cylinder  
Camshaft adjustment tool for exhaust cam 3-cylinder



FITS FOR:

ART.NR	ITEM NAME	PRICE
<b>BT591240</b>	Camshaft locking tool set for Alfa Romeo 1.8l, 2.0l 16V	<b>17,00 €</b>

**FOR THE FOLLOWING MODELS**

Alfa Romeo 147, 156 1.8 16V (140 PS), 1.8 16V (144 PS), 2.0 16V (150 PS), 2.0 16V (155 PS)

**DESCRIPTION**

For checking and adjusting the camshaft timing  
Use as OEM 1825041000

**DELIVERY SCOPE**

Camshaft adjustment tool for intake cam 2-cylinder  
Camshaft adjustment tool for exhaust cam 3-cylinder



FITS FOR:

ART.NR	ITEM NAME	PRICE
<b>BT591225</b>	Camshaft locking tool set for Fiat, Lancia 1.8l 130 hp	<b>17,00 €</b>

**FOR THE FOLLOWING MODELS**

Fiat, Lancia 1.8L 16V 130PS

**DESCRIPTION**

For checking and adjusting the camshaft timing  
Use as OEM 1860847000

**DELIVERY SCOPE**

Camshaft adjustment tool for intake cam 2-cylinder  
Camshaft adjustment tool for exhaust cam 3-cylinder



FITS FOR:

ART.NR	ITEM NAME	PRICE
<b>BT591230</b>	Camshaft locking tool set for Alfa Romeo 1.6l 16V	<b>17,00 €</b>

**FOR THE FOLLOWING MODELS**

Alfa Romeo 145, 146, 147, 156 1.6 16V (Step "A")

**DESCRIPTION**

For checking and adjusting the camshaft timing  
Use as OEM 1870734000

**DELIVERY SCOPE**

Camshaft adjustment tool for intake cam 2-cylinder  
Camshaft adjustment tool for exhaust cam 3-cylinder



FITS FOR:

ART.NR	ITEM NAME	PRICE
<b>BT591220</b>	Camshaft locking tool set for Alfa Romeo 147 1.6 105 hp	<b>17,00 €</b>

**FOR THE FOLLOWING MODELS**

Alfa Romeo 147 1.6 105 PS

**DESCRIPTION**

For checking and adjusting the camshaft timing  
Needed when replacing the toothed belt

**DELIVERY SCOPE**

Intake and exhaust camshaft locking block, use as OEM 1870797000



FITS FOR:

ART.NR	ITEM NAME	PRICE
BT591210	Camshaft locking tool set for Alfa Romeo 1.6I ECO	17,00 €

**FOR THE FOLLOWING MODELS**

Alfa Romeo 147 (937) 1.6L 77KW ECO Twin Spark

**DESCRIPTION**

For adjusting and checking the engine timing  
Use as OEM 1870797000

**DELIVERY SCOPE**

Camshaft adjustment tool for intake cam 3-cylinder  
Camshaft adjustment tool for exhaust cam 2-cylinder

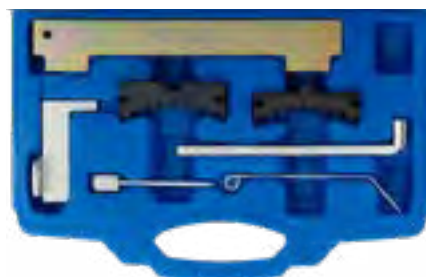

FITS FOR:

ART.NR	ITEM NAME	PRICE
BT591300	Engine adjustment tool set for Opel 1.6, 1.8	33,00 €

**DESCRIPTION**

Contains tools for locking the camshaft and crankshaft  
Suitable for 1.6 and 1.8 L engines with toothed belt control, installed in models start from Opel, Vauxhall, Chevrolet, Fiat, Alfa Romeo (2003-2012), e.g. Astra G, H, Corsa D, Insignia, Meriva, Signum, Vectra C, Zafira B (2003-2011)

Suitable for Chevrolet Cruze, Orlando 1.4 1.6 1.8 and Fiat Croma, Alfa Romeo 159 with 939A4.000 engines  
Use as OEM tools KM-6628-A, 2000012000, KM-6340, 2000012100, KM-6333, KM-6625, 2000012800, KM-6349, KM 6130, KM-911



FITS FOR:

ART.NR	ITEM NAME	PRICE
BT591260	Camshaft sprocket locking tool set, universal	72,50 €

**FOR THE FOLLOWING MODELS**

Can be used universally on vehicles start from the following manufacturers: Audi, Alfa Romeo, Chrysler, Citroen, Ford, Honda, Hyundai, Isuzu, Land Rover, Lexus, Mazda, Mitsubishi, Peugeot, Renault, MG, Seat, Skoda, Subaru, Toyota, Opel, Volkswagen, Volvo

**DESCRIPTION**

For locking the camshaft sprockets e.g. when replacing the toothed belt  
Suitable for engines with 1, 2 and 4 camshafts (V engines); also suitable for locking between the camshaft sprocket and diesel injection pump wheel in some diesel engines

**DELIVERY SCOPE**

Double camshaft locking tool with short and long connecting arm  
Single camshaft locking tool with short and long locking screw

1/4" 6,3 mm

**BT020023**  
**EAN 4042146774281**  
1/4 mm socket set,  
23 pcs



12x	1/4"	4 • 4,5 • 5 • 5,5 • 6 • 7 • 8 • 9 • 10 • 11 • 12 • 13 mm
4x		T15 • T20 • T25 • T30
2x		PH1 • PH2
2x		PZ1 • PZ2
1x	1/4"	110 mm
1x	1/4"	100 mm
1x	1/4"	25 mm



**23**  
pcs.

**20,- €**

# AUDI



FITS FOR:

ART.NR	ITEM NAME	PRICE
<b>BT551340</b>	Alignment and O-ring assembly set for VAG pump/nozzle unit	<b>60,00 €</b>

### FOR THE FOLLOWING MODELS

5-cylinder and 10-cylinder VW Phaeton, Touareg from year of construction 2003 onwards, T5 from year of construction 2004 onwards, etc.

4-cylinder VW Golf, Touareg, Audi A3 from year of construction 2004 onwards, etc.

### DESCRIPTION

Enables precise positioning of the pump/nozzle unit and damage-free fitting of the O-rings

An incorrectly installed pump/nozzle unit entails a risk of damage to the cylinder head and the pump/nozzle unit itself

### DELIVERY SCOPE

Adjustment gauge, steel, use as OEM T10210

O-ring fitting sleeve, brass, use as OEM T10056/1

O-ring fitting sleeve, brass, use as OEM T10056/2

O-ring fitting sleeve, brass, use as OEM T10056/3

O-ring fitting sleeve, brass, use as OEM T10164/1

O-ring fitting sleeve, brass, use as OEM T10164/2



FITS FOR:

ART.NR	ITEM NAME	PRICE
<b>BT551350</b>	Setting gauges for VAG pump-nozzle-units on 3- and 4-cylinder engines	<b>90,00 €</b>

### DESCRIPTION

For adjusting the pump/nozzle units

Suitable for 3-cylinder and 4-cylinder engines and for pump/nozzle units with old and new solenoid valve nut



FITS FOR:

ART.NR	ITEM NAME	PRICE
<b>BT596002</b>	Universal camshaft wheel puller	<b>63,00 €</b>

### DESCRIPTION

For pulling the pulley and camshaft gear

Gripping arms are connected with each other via adjusting disk, thus the gripping arms can be set easily and exactly

Continuous adjustment range of the gripping arms from 42 – 82 mm

Gripping arm depth is 27 mm

### DELIVERY SCOPE

3 x gripping arms, Ø 12 mm, M10 x 1.5, suitable for material thickness up to max. 10 mm

6-groove puller body with adjusting disc

Spindle, M14 x 1.5, 19 mm hex, with centring cone



FITS FOR:

ART.NR	ITEM NAME	PRICE
<b>BT591040</b>	Camshaft locking tool for VAG W8 and W12	<b>40,00 €</b>

### DESCRIPTION

For aligning the camshafts

Suitable for V6 R32 3.2L FSI W8 and 6.0L W12

2 alignment rules

Use as OEM T10068, T10068A



FITS FOR:

ART.NR	ITEM NAME	PRICE
<b>BT561006</b>	ignition coil extractor for VAG	<b>23,00 €</b>

### DESCRIPTION

For pulling off ignition coils on VAG models from year of construction 2013 onwards

Pin-shaped for insertion into the ignition coil fixing hole

Suitable for 4-cylinder 1.2, 1.4, 1.8, 2.0 FSI, TFSI engines, installed in e.g. VW Golf, Audi A3, Seat Leon, Skoda Octavia

Use as OEM T10530



FITS FOR:

ART.NR	ITEM NAME	PRICE
<b>BT541061</b>	Bit insert, length 54 mm, 12.5 mm square drive (1/2") for VAG Polydrive	<b>4,00 €</b>

### DESCRIPTION

Special insert for loosening and tightening the fixing screw of the camshaft adjuster for VAG 4-cylinder fuel injection engine (2.0 l direct injection engine)

Special spline profile

Use as OEM: T40080

With knurled grip

Dimensions: M10

### DELIVERY SCOPE

3 special inserts, 10 mm (3/8") drive

Special insert for camshaft control valves, use as OEM T10352, OEM T10352/1, OEM T10352/2



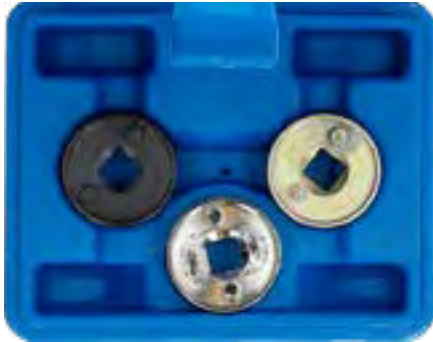

ART.NR	ITEM NAME	PRICE
<b>BT595850</b>	Camshaft control valve inserts for VAG 1.8, 2.0 TFSI, TSI	<b>14,00 €</b>

**FOR THE FOLLOWING MODELS**

Audi A3, A4, A5, Q5, TT, Seat Altea, Leon, Toledo, Exeo, Skoda Octavia II, Superb II, Yeti, Volkswagen Eos, Golf, Jetta, Passat, Scirocco, Sharan, Tiguan

**DESCRIPTION**

For fitting/removal of the 4/3-way central valve of the camshaft adjustment

Suitable for 1.8, 2.0 L 4-cylinder fuel injection and direct injection engines with timing chain.



ART.NR	ITEM NAME	PRICE
<b>BT591080</b>	Engine adjustment tool set for VAG	<b>10,00 €</b>

**DESCRIPTION**

VAG 2.0 L TDI and some 1.9L TDI with oval crankshaft wheel

**DELIVERY SCOPE**

Interlock tool for crankshaft wheel, use as OEM T10100  
Interlock mandrel for pump wheel, use as OEM 3359  
Interlock plate for tensioning roll, use as OEM T10008

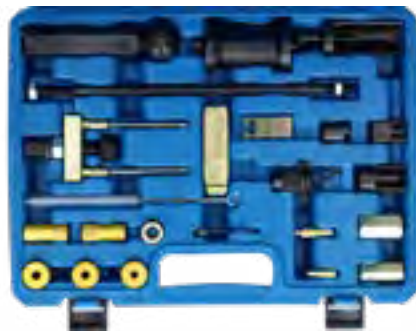

ART.NR	ITEM NAME	PRICE
<b>BT551360</b>	FSI nozzle assembly/disassembly kit	<b>89,00 €</b>

**DESCRIPTION**

Suitable for VW, Audi, Seat, Skoda with petrol direct injection and engines with a pump/nozzle unit

Use as tools OEM T10133 + T10163

**DELIVERY SCOPE**

Puller for dismantling FSI nozzles, use as T10133/1  
Extractor claw for dismantling FSI nozzles, use as T10133/2  
Slide hammer, use as T10133/3  
Assembly cone for fitting the combustion chamber sealing rings, use as T10133/5  
Calibration sleeves for fitting the combustion chamber sealing rings, use as T10133/6, T10133/7, T10133/8  
Fitting mandrel for fitting the FSI nozzles, use as T10133/9  
Puller for removing pump/nozzle units



ART.NR	ITEM NAME	PRICE
<b>BT606004</b>	Special spanner for exhaust gas temperature sensor for VAG, SW 19 mm	<b>28,00 €</b>

**DESCRIPTION**

For assembling/disassembling exhaust gas temperature sensors

Suitable for e.g. the following VAG engines: 1.8 TFSI, 2.0 TFSI, 2.0 FSI, 1.6 CRTdi, 2.0 common rail

Spanner width 19 mm

Use as OEM T10395/8, T10395/9, T10395/10



ART.NR	ITEM NAME	PRICE
<b>BT561005</b>	Ignition coil disassembly tool for VAG	<b>16,00 €</b>

**DESCRIPTION**

For disassembling ignition coils mounted directly on the spark plug

Suitable for e.g. the following models from year of construction 2013 onwards: VW Golf, Audi A3, Seat Leon, Skoda Octavia with FSI engines 1.2, 1.4, 2.0 with timing chain



ART.NR	ITEM NAME	PRICE
<b>BT591960</b>	Vibration damper tool set for VAG 1.8, 2.0 TFSI	<b>145,00 €</b>

**ENGINE CODES**

Engine codes for 1.8L TFSI: BZB, CDAA, BPU, BYT, CABA, CABB, CDHA, CDHB, CABD, DAJB, CJSA, CJSB, CJEB, CJEE, CJED, CYGA, CDAC, CJSK, CGYA, DAJA

Engine codes for 2.0L TFSI: CAWB, CCZA, CBFA, CCTA, CDNB, CDNC, CDND, CJXA, CJXE, CJXH, CHHB, CHHA, CULA, CFKA, DEDA, CHJA, CAWA, CCZC, CCZD, CPSA, CJKA, CJKB, CESA, CETA, CFPA, CNCD, CPLA, CYRB, CYRC, CNCE, CYNB, CYPB, CULB, CULC, CNCB, CWZA, CJXF, CJXC, CJXB, CJXG, CHHC, CCZB

**DESCRIPTION**

Prevents the timing chain sprocket from turning when the vibration damper is being removed or installed

Suitable for Volkswagen, Audi, Skoda and Seat models with 1.8 and 2.0L TFSI engine with chain drive

**DELIVERY SCOPE**

Vibration damper holding tool, use as OEM T10531/1  
Crankshaft wheel clamping bolt, use as OEM T10531/2  
Nut for crankshaft wheel holding tool, use as OEM T10531/3  
Adapter piece for crankshaft wheel holding tool, use as OEM T10531/4



FITS FOR:

ART.NR	ITEM NAME	PRICE
BT597152	Locking tool for crankshaft timing belt pulleys for VAG	5,00 €

**DESCRIPTION**

VAG 1.2, 1.4, 1.9 L TDI with round crankshaft wheel  
Use as OEM T10050



FITS FOR:

ART.NR	ITEM NAME	PRICE
BT597151	Locking tool for crankshaft timing belt pulleys for VAG	6,00 €

**DESCRIPTION**

VAG 2.0 L TDI and 1.9 L with oval crankshaft wheel  
Use as OEM T10100



FITS FOR:

ART.NR	ITEM NAME	PRICE
BT597100	Engine adjustment tool set for VAG	11,00 €

**DESCRIPTION**

VAG 1.2 1.4 1.9 L TDI with round crankshaft wheel

**DELIVERY SCOPE**

Interlock tool for crankshaft wheel, use as OEM T10050  
Interlock mandrel for pump wheel, use as OEM 3359  
Interlock plate for tensioning roll, use as OEM T10008



FITS FOR:

ART.NR	ITEM NAME	PRICE
BT597450	Engine adjustment tool set for VAG	40,00 €

**FOR THE FOLLOWING MODELS**

VW Passat, Sharan  
AUDI A4, A6, A8, Allroad (1997-2006), A8  
SKODA Superb 2.5 (2002-2006)

**ENGINE CODES**

AFB, AKN, AKE, AYM, BAU, BCZ, BDG, BDH, BFC

**DESCRIPTION**

For inspecting and adjusting the camshaft control times

**DELIVERY SCOPE**

Interlock plate with chain, use as OEM 3458  
Special spanner, spanner width 22 mm, 1/2" drive, use as OEM 3078  
Propping aid for front masks, use as OEM 3369  
Crankshaft locking pin, use as OEM 3242  
Marking pin of injection pump wheel, use as OEM 3359



FITS FOR:

ART.NR	ITEM NAME	PRICE
BT591090	camshaft adjustment tool set for VAG	42,00 €

**FOR THE FOLLOWING MODELS**

Installed in e.g. the following models: Audi A1 (2013-), A3 (2013-), Q3 (2014-), Volkswagen Passat (2012), Golf (2012-), Polo (2015-), Seat Leon (2014-), Ibiza (2013-), Skoda Superb (2015-)

**DESCRIPTION**

For fixing the camshafts in place when checking and adjusting the valve timing  
Suitable for 1.2, 1.4 TSi, TFSi engines with active cylinder management ACT or COD  
Engine codes: CPTA, CZEA

**DELIVERY SCOPE**

Camshaft adjustment tool, use as OEM T10504  
Camshaft adjustment pin, use as OEM T10504/1  
Camshaft testing pin, use as OEM T10504/2

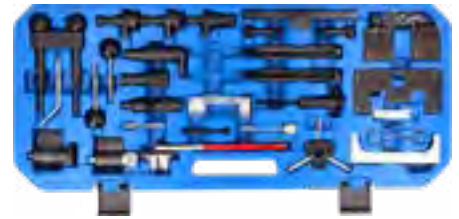

FITS FOR:

ART.NR	ITEM NAME	PRICE
BT597800	Engine adjustment tool set for VAG	139,00 €

**FOR THE FOLLOWING MODELS**

1.9L, 2.0L TDI pump/nozzle  
1.9L TDI  
2.5L V6-TDI  
3.3L V8-TDI  
1.2L 3-cylinder and 1.4, 1.6L petrol engines

**ENGINE CODES**

OE-Code Audi: 2065A, T10008, T10016, T10020, T10050, T10060A, T10098, T10100, T10120, T10121, T10264, T10265, T40011, 2064, 3242, 3359, 3366, 3369, 3418, 3458, T10123

OE-Code Seat: 2065A, T10008, T10016, T10020, T10050, T10060A, T10098, T10100, T10120, T10121, T10264, T10265, T40011, 2064, 3242, 3359, 3366, 3369, 3418, 3458, T10123

OE-Code Skoda: 2065A, T10008, T10016, T10020, T10050, T10060A, T10098, T10100, T10120, T10121, T10264, T10265, T40011, 2064, 3242, 3359, 3366, 3369, 3418, 3458, T10123

OE-Code Volkswagen: 2065A, T10008, T10016, T10020, T10050, T10060A, T10098, T10100, T10120, T10121, T10264, T10265, T40011, 2064, 3242, 3359, 3366, 3369, 3418, 3458, T10123

**DELIVERY SCOPE**

Camshaft adjustment gauge (e.g. VW 1.9 l TDI)  
Toothed belt pulley interlock tool (e.g. VW, Skoda 1.9L, 2.0L TDI pump/nozzle)  
Camshaft interlock tool (e.g. VW, Audi 2.5L V6 TDI)  
3-way adjustable toothed belt tension roller spanner (universal, for VW, Audi)  
Interlock mandrel for injection pump wheel (e.g. VW, Audi, Seat, Skoda amongst others)  
Retaining plate for toothed belt tensioning device (VW, Skoda 4-cylinder TDI pump/nozzle)  
Open plug-in unit SW22 for assembly and disassembly of diesel injection nozzles  
Camshaft adjustment tools, use as OEM T10123, T10120, 3458, 3418, 2065A, 3366, T10098, 3418  
Crankshaft adjustment tools, use as OEM T10121, 3242, T10050, T10100  
Tensioning roller interlock tools, use as OEM T10060A, T10020, T10008, T40011  
Injection pump interlock tools, use as OEM 3359, 2064



FITS FOR:

ART.NR	ITEM NAME	PRICE
BT591011	Camshaft fixing tool for Audi, VW	39,00 €

**DESCRIPTION**

Needed for changing the toothed belt in Audi and VW models with 2-valve V6 engines, e.g. Audi 80, 90, A4, A6 1994-97 ABC, AFC engine

The camshaft cannot turn while the toothed belt is being fitted

The fixing hook ensures a secure fit

Easy, accurate fitting of the toothed belt



FITS FOR:

ART.NR	ITEM NAME	PRICE
BT591015	Camshaft retainer for Audi 8-cylinder engines	44,00 €

**DESCRIPTION**

Suitable for Audi A4 models up to 2001 and A6 up to 1998 with 8-cylinder engines

For checking the engine timing or adjusting the camshafts

Use as OEM T40046



FITS FOR:

ART.NR	ITEM NAME	PRICE
BT591110	Camshaft adjustment tools for Audi V8 4.2	47,00 €

**FOR THE FOLLOWING MODELS**

Suitable for vehicles with 4.2L V8 engines AUDI A6 (2005, 2006), A8 (2004, 2006), Quattro (2003, 2005), S4 (2004, 2009), VW Phaeton (2004, 2006) with engine code BNK, BFM, BGK, BAS, BHF, BGH

**DESCRIPTION**

For adjusting the camshafts

Use as OEM T40047

Enables correct adjustment of the Hall sensor covers; incorrect adjustment can lead to rough idling and slow responses



FITS FOR:

ART.NR	ITEM NAME	PRICE
BT596007	Camshaft fixing tool for VAG, adjustable, 12V, 30V	75,00 €

**FOR THE FOLLOWING MODELS**

Needed for changing the toothed belt in Audi and VW models with the following engines: AUDI A4 2.4 2.8 year of construction 1997, 2002, A6 2.4 year of construction 1997, 2002, A6 2.8 year of construction 1997, 2002, A8 2.8 year of construction 1997, 2002, S4 2.7 Turbo year of construction 1997, 2001, Volkswagen with ACK, ALG, APR, AQD engines, Passat 2.4 year of construction 1996, 2002, Passat 2.8 30v year of construction 1996, 2001, 2-valve V6 engines e.g. Audi 80, 90, A4, A6 year of construction 1994, 1997 ABC, AFC engine

**DESCRIPTION**

Large range of use thanks to adjustable camshaft fixing tool, use as OEM 3391 or OEM 3243

Crankshaft locking bolt, use as OEM 3242

The camshaft cannot turn while the toothed belt is being fitted

Easy, accurate fitting of the toothed belt



FITS FOR:

ART.NR	ITEM NAME	PRICE
BT591010	Camshaft fixing tool for Audi, VW	39,00 €

**DESCRIPTION**

Needed for changing the toothed belt in Audi and VW models with the following engines: AUDI A4 2.4 2.8 year of construction 1997, 2002, A6 2.4 year of construction 1997, 2002, A6 2.8 year of construction 1997, 2002, A8 2.8 year of construction 1997, 2002, S4 2.7 Turbo year of construction 1997, 2001 or Volkswagen with ACK, ALG, APR, AQD engines, and Passat 2.4 year of construction 1996, 2002, Passat 2.8 30v year of construction 1996, 2001

The camshaft cannot turn while the toothed belt is being fitted

Easy, accurate fitting of the toothed belt



FITS FOR:

ART.NR	ITEM NAME	PRICE
BT595800	Engine adjustment tool set for Volkswagen 1.2	11,00 €

**DELIVERY SCOPE**

Can also be used as a replacement for Art. BT597800  
Use as OEM T10123



FITS FOR:

ART.NR	ITEM NAME	PRICE
BT591018	Front mask propping aid for Audi A4	17,00 €

**DESCRIPTION**

For pushing the front mask into the service position, e.g. for Audi A4, Passat from 1997 onwards

Allows for timing belt changes or the renewal of the water pump

Use as T10093

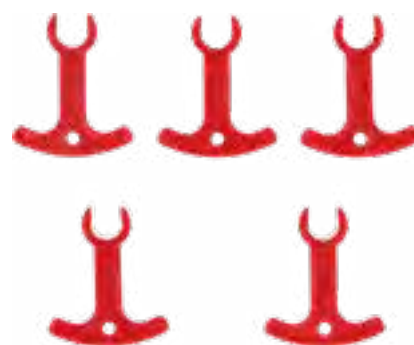

FITS FOR:

ART.NR	ITEM NAME	PRICE
BT591020	Camshaft spacers for VAG	25,00 €

**DESCRIPTION**

For positioning the camshaft slide elements

Suitable for 4-cylinder petrol direct injection, 2.0 turbo, 4-valve engines, e.g. in the Audi A4 up to year of construction 2008, Audi G5 up to year of construction 2009

Use as OEM T40191



FITS FOR:

ART.NR	ITEM NAME	PRICE
<b>BT595850</b>	Camshaft control valve inserts for VAG 1.8, 2.0 TFSI, TSI	<b>14,00 €</b>

**FOR THE FOLLOWING MODELS**

Audi A3, A4, A5, Q5, TT, Seat Altea, Leon, Toledo, Exeo, Skoda Octavia II, Superb II, Yeti, Volkswagen Eos, Golf, Jetta, Passat, Scirocco, Sharan, Tiguan

**DESCRIPTION**

For fitting/removal of the 4/3-way central valve of the camshaft adjustment

Suitable for 1.8, 2.0 L 4-cylinder fuel injection and direct injection engines with timing chain.



FITS FOR:

ART.NR	ITEM NAME	PRICE
<b>BT591019</b>	Camshaft assembly tool for VAG 6 and 8-cylinder TDI	<b>119,00 €</b>

**DESCRIPTION**

For installing the camshaft in the cylinder head

Suitable for the following VAG models: VW Tiguan 2008, Passat CC 2009, Touareg 2003, Phaeton 2003, Audi A3 2004, A4 2001, A4 2008, A5 2008, Q5 2008, A6 2005, Q7 2007, A8 2003

6-cylinder TDI common rail 2.7, 3.0 4-valve engines

8-cylinder TDI common rail 4.0 4-valve engines

Use as VAG OEM T40095



FITS FOR:

ART.NR	ITEM NAME	PRICE
<b>BT591030</b>	Engine adjustment tool set for VAG	<b>59,00 €</b>

**FOR THE FOLLOWING MODELS**

Audi A3 1.8 Turbo (AGN AGU AJQ APG APP AQA ARX ARY ARZ AUM AUG) 1996-2003, A3 1.6 FSI (BAG) 2003-2006, S3 1.8 Turbo (AMK APY BAM) 1996, A4 1.8 Turbo (ADR AEB AJL AJP ANB APU AVJ AWT) 1994-2006, A6 1.8 Turbo (ADR AEB AJL AJP ANB APU AVJ AWT) 1994-2006, Cabriolet 1.8 (ADR) 1997-2000, TT 1.8 Turbo (AJQ APP APX AUM AUG BAM) 1998-2006

Volkswagen Beetle 1.8 Turbo (AVC) 1999-2006, Touran 1.6 FSI (BAG BLP) 2003-2007, Golf 1.8 Turbo (AGN AGU AQA ARZ AUM AUG) 1997-2005, Bora 1.8 Turbo (AGN AGU AQA ARZ AUM AUG) 1997-2005, Passat 1.8 Turbo (ADR AEB ANB APT APU ARG AWT) 1996-2005, Sharan 1.8 Turbo (AJH AWC) 1997-2007

Skoda Octavia 1.8 FSI Turbo (AGN AGU ARX ARZ AUM) 1996-2005, Octavia 1.8 Turbo 20V RS (AUG) 2000-2006, Octavia 1.6 FSI (BLF) 2004-2007

**DESCRIPTION**

Suitable for 1.8 L turbo and 1.6 L FSI engines

**DELIVERY SCOPE**

Counter support for crankshaft, use as OEM 3036

Camshaft fixing tool, use as OEM T10171

Counter support for drive sprockets of oil pump gear, camshaft, vibration damper, use as OEM T10172

Adapter pieces for counter support, use as OEM T10172

Chain tensioner bracket for installation and removal of the chain tensioner, use as OEM T20018, 3366

Tension roller element fixing pin, use as OEM T40011



FITS FOR:

ART.NR	ITEM NAME	PRICE
<b>BT591014</b>	Timing chain adjustment spanner for VAG	<b>28,00 €</b>

**DESCRIPTION**

Needed for tensioning the timing chain

Suitable for Audi A6 from year of construction 2005 onwards, 4,2L direct injection, 8-cylinder, 4-valve

Use as OEM T40079



FITS FOR:

ART.NR	ITEM NAME	PRICE
<b>BT591150</b>	Engine adjustment tool set for Audi 2.4, 2.8, 3.0 TFSI	<b>49,00 €</b>

**DESCRIPTION**

For adjusting the engine timing when replacing the cylinder head seal, camshaft etc.

Suitable for e.g. Audi A6, Q5

**DELIVERY SCOPE**

2 camshaft interlocks, use as OEM T40133

Crankshaft locking pin, use as OEM T40069

Chain tensioner interlock, use as OEM T40071

Crankshaft turning tool, use as OEM T40058



ART.NR	ITEM NAME	PRICE
<b>BT597010</b>	Engine adjustment tool set for VAG FSI, TSI 1.4, 1.6 (with timing chain)	<b>29,00 €</b>

**FOR THE FOLLOWING MODELS**

Audi A3 (2003-2010)  
 Seat Ibiza, Leon, Altea  
 Skoda Octavia (2004-2009), Fabia (2007-2009), Superb (2009-2010), Roomster (2006-2009)  
 Volkswagen Golf (2003-2009), Golf Plus (2005-2009), Jetta (2006-2009), Passat (2005-2009), Polo (2002-2008), Scirocco (2009-2010), Tiguan (2007-2009), Touran (2003-2009), Eos (2006-2009)

**ENGINE CODES**

Engine code AXU, BLG, BAG, BMY, BKG, BMK, BLF, CAVA, BLN, CAVB, BLP, CAVC, CAVE, CAVF, CAVD, CAXA, CAXC, CDGA, BTS

**DESCRIPTION**

For checking and adjusting the timing  
 Needed e.g. when replacing the timing chain  
 Suitable for VAG FSI and TFSI 1.4 and 1.6 L engines

**DELIVERY SCOPE**

Camshaft locking device, use as OEM T10171  
 Dial gauge bracket, use as OEM T10170  
 Crankshaft interlock, use as OEM T10340  
 Hydraulic tensioner interlock, use as OEM T40011



ART.NR	ITEM NAME	PRICE
<b>BT597500</b>	Engine adjustment tool for VAG 1.2, 1.4, 1.6 FSI, 1.4 TSI	<b>73,00 €</b>

**FOR THE FOLLOWING MODELS**

Audi A1, A3, A3 Sportback, A3 Cabriolet  
 Seat Altea, Altea XL, Ibiza, Ibiza Sport Coupe, Leon, Toledo  
 Skoda Fabia, Fabia, Octavia, Rapid, Roomster, Yeti  
 VW New Beetle, Caddy, Golf, Golf Plus, Golf Cabriolet, Golf Variant, Jetta, Polo, Touran

**ENGINE CODES**

AXU, BAG, BKG, BLF, BLN, BLP, BMY, BTS, BLG, BWK, CAVA, CAVB, CAVC, CAVD, CAVF, CAXA, CAXC, CDGA

**DESCRIPTION**

For adjusting and checking the engine timing

**DELIVERY SCOPE**

Camshaft locking device, use as OEM T10171  
 Dial gauge, use as OEM T10170 (dial gauge holder with 274 mm total length, exterior thread M14 x 1.25 mm)  
 Crankshaft interlock, use as OEM T10340  
 Hydraulic tensioner interlock, use as OEM T40011 (8 mm tension shaft)  
 Precision dial gauge for locating the piston OT (resolution: 0.01 mm / measuring range: 0-8 mm / diameter: 41 mm)  
 2x crankshaft wheel locking pin, use as OEM T10341 (two guide bolts with 135 mm length, 24 mm long exterior thread M8 x 1.25 mm, reciprocal external hex with 6 mm width between flats)  
 Camshaft interlock, use as OEM T10414

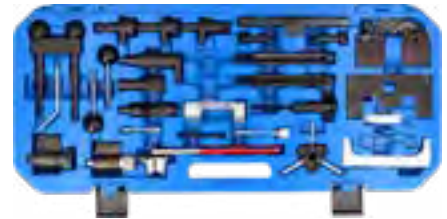

ART.NR	ITEM NAME	PRICE
<b>BT597800</b>	Engine adjustment tool set for VAG	<b>139,00 €</b>

**FOR THE FOLLOWING MODELS**

1.9L, 2.0L TDI pump/nozzle  
 1.9L TDI  
 2.5L V6-TDI  
 3.3L V8-TDI  
 1.2L 3-cylinder and 1.4, 1.6L petrol engines

**ENGINE CODES**

OE-Code Audi: 2065A, T10008, T10016, T10020, T10050, T10060A, T10098, T10100, T10120, T10121, T10264, T10265, T40011, 2064, 3242, 3359, 3366, 3369, 3418, 3458, T10123  
 OE-Code Seat: 2065A, T10008, T10016, T10020, T10050, T10060A, T10098, T10100, T10120, T10121, T10264, T10265, T40011, 2064, 3242, 3359, 3366, 3369, 3418, 3458, T10123  
 OE-Code Skoda: 2065A, T10008, T10016, T10020, T10050, T10060A, T10098, T10100, T10120, T10121, T10264, T10265, T40011, 2064, 3242, 3359, 3366, 3369, 3418, 3458, T10123  
 OE-Code Volkswagen: 2065A, T10008, T10016, T10020, T10050, T10060A, T10098, T10100, T10120, T10121, T10264, T10265, T40011, 2064, 3242, 3359, 3366, 3369, 3418, 3458, T10123

**DELIVERY SCOPE**

Camshaft adjustment gauge (e.g. VW 1.9 l TDI)  
 Toothed belt pulley interlock tool (e.g. VW, Skoda 1.9L, 2.0L TDI pump/nozzle)  
 Camshaft interlock tool (e.g. VW, Audi 2.5L V6 TDI)  
 3-way adjustable toothed belt tension roller spanner (universal, for VW, Audi)  
 Interlock mandrel for injection pump wheel (e.g. VW, Audi, Seat, Skoda amongst others)  
 Retaining plate for toothed belt tensioning device (VW, Skoda 4-cylinder TDI pump/nozzle)  
 Open plug-in unit SW22 for assembly and disassembly of diesel injection nozzles  
 Camshaft adjustment tools, use as OEM T10123, T10120, 3458, 3418, 2065A, 3366, T10098, 3418  
 Crankshaft adjustment tools, use as OEM T10121, 3242, T10050, T10100  
 Tensioning roller interlock tools, use as OEM T10060A, T10020, T10008, T40011  
 Injection pump interlock tools, use as OEM 3359, 2064



ART.NR	ITEM NAME	PRICE
<b>BT596004</b>	Tensioning spanner for VAG	<b>13,00 €</b>

**DESCRIPTION**

For adjusting the tensioner pulley  
 Use as OEM T10020



FITS FOR:

ART.NR	ITEM NAME	PRICE
<b>BT596003</b>	camshaft locking tool	<b>11,00 €</b>

**FOR THE FOLLOWING MODELS**

VAG 1.4I, 1.6I 16V

**ENGINE CODES**

ARC, AUB, AJA, AUS, APE, ATN, AVY, AFK, AHW, APE, AGQ, AJV, AKG, AZD

**DESCRIPTION**

For adjusting the camshaft e.g. when replacing the toothed belt

Use as OEM T10016

FITS FOR:

ART.NR	ITEM NAME	PRICE
<b>BT591200</b>	engine adjustment tool set for VAG	<b>59,00 €</b>

**DESCRIPTION**

suitable for 2.0 L FSI and TFSI engines, e.g. Golf, Touran, Audi A3, engine codes AWA, BMB, AXW

**DELIVERY SCOPE**

Marking mandrel, use as OEM T10060A

Marking pins, use as OEM T10115

Marking pins, use as OEM T40011

Chain adjuster, use as OEM 3366

Camshaft mount, use as OEM T10252

Tensioning bolt, use as OEM T10092

Two hole nut screw driver, use as OEM T10020

FITS FOR:

ART.NR	ITEM NAME	PRICE
<b>BT595950</b>	engine adjustment tool set for Audi A4, A6, A8	<b>105,00 €</b>

**FOR THE FOLLOWING MODELS**

Suitable for Audi A4, A6, A8 with engine code ASN, AVK, BBJ

**DESCRIPTION**

Needed for replacing the toothed belt and carrying out servicing work on the engine

Easy assembly of the toothed belt as camshaft and crankshaft are fixed

**DELIVERY SCOPE**

2 camshaft fixer, use as OEM T40030

Crankshaft interlock, use as OEM T40026

Tension roller key, use as OEM 3387

Insert for basic setting of the camshaft adjuster, use as OEM T40028

Fixing pins for tensioning element, use as OEM T40011

**BT023002**  
**EAN 4042146777770**  
Reversible ratchet set, 2 pcs

**2**  
pcs.

**1/2"**  
12,5 mm

**2K**



**29,- €**

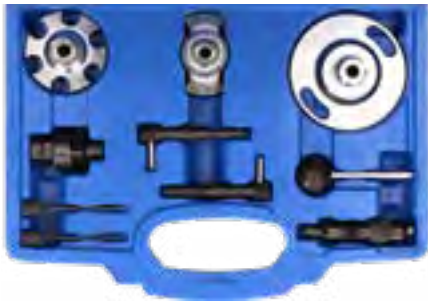

FITS FOR:

ART.NR	ITEM NAME	PRICE
<b>BT597400</b>	engine adjustment tool set VAG 2.7, 3.0 TDI	<b>79,00 €</b>

**FOR THE FOLLOWING MODELS**

Suitable for Audi A4, A5, A6, AB, Q5, Q7 and VW Touareg, Phaeton with engine code ASB, BKN, BKS, BMK, BMZ, BNG, BPP, BSG, BUG, BUN, CAMA, CAMB, CANA, CANB, CANC, CAND, CAPA, CARA, CARB, CASA, CASB, CASC, CATA, CCMA, CCWA, CCWB, CDYA, CDYB, CDYC, CEXA, CGKA, CGKB

**DESCRIPTION**

For locking the camshaft/crankshaft and fixing the tensioners

Needed for replacing the timing chain or carrying out other work on engine timing

**DELIVERY SCOPE**

- Camshaft blocking, use as OEM T40062
- Camshaft tool, use as OEM T40061
- Swivel adapter for crankshaft, use as OEM T40049
- Marking mandrel for injection pump, use as OEM 3359
- Swivel adapter for crankshaft, use as OEM T40058
- 2 camshaft interlocks, use as OEM T40060
- Crankshaft marking mandrel, use as OEM 3242
- 2 chain tensioner interlocks

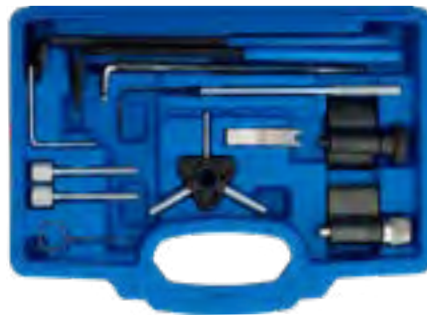

FITS FOR:

ART.NR	ITEM NAME	PRICE
<b>BT597700</b>	engine adjustment tool set for VAG	<b>45,00 €</b>

**FOR THE FOLLOWING MODELS**

Audi A1 (2010-2012), A2 (2001-2006), A3 (2001-2012), A4/Allroad (1999-2012), A5 (2008-2012), A6/Allroad (1998-2011), TT (2008-2010), Q5 (2008-2012)

Seat Alhambra (1999-2010), Altea/Altea XL (2004-2012), Arosa (1999-2005), Cordoba (2002-2009), Ibiza (2002-2010), Leon (2000-2012), Toledo (2004-2011)

Skoda Fabia (2000-2007), Fabia II (2007-2012), Octavia (2000-2010), Octavia II (2004-2012), Roomster (07-12), Superb (2002-2008), Superb II (2008-2012), Yeti (2009-2012)

VW Amarok (2010-2012), Beetle (2000-2011), Bora (1998-2008), Caddy/Maxi (2003-2012), Eos (06-10), Fox (2005-2011), Golf (1998-2012), Golf Plus (2005-2012), Jetta (2005-2011), Lupo (1999-2005), Passat/CC (1998-2012), Polo (1999-2012), Scirocco (2008-2012), Sharan (1999-2010), Tiguan (2007-2012), Touran (2003-2012), Transporter (2003-2012)

Dodge Caliber (2006-2011)  
Ford Galaxy (1999-2006)  
Mitsubishi Grandis (2005-2010), Lancer (2005-2010), Outlander (2007-2010)

**DESCRIPTION**

For inspecting and adjusting the camshaft control times  
1.2, 2.0 TDI PD, 1.2, 1.6, 2.0 TDI CR



FITS FOR:

ART.NR	ITEM NAME	PRICE
<b>BT596005</b>	tension pulley spanner, 12-point, SW 32 mm	<b>6,00 €</b>

**FOR THE FOLLOWING MODELS**

Audi 100 from 1991 onwards, A4, A6 2.5 TDI 5-cylinder  
VW Polo Diesel, Lupo from 1999 onwards, LT and T4 2.5 TDI

**DESCRIPTION**

For actuating the automatic tension roller while replacing the toothed belt



FITS FOR:

ART.NR	ITEM NAME	PRICE
<b>BT597650</b>	engine adjustment tool set for VAG 1.7, 1.9 D, SDI, TDI, 1.6, 1.8, 1.8T, 2.0	<b>61,00 €</b>

**FOR THE FOLLOWING MODELS**

VW Beetle (1998-2002), Bora (1994-2005), Caddy (1996-2004), Golf (1994-2005), Lupo (1998-2005), Passat (1996-2000), Polo (1995-2006), Sharan (1995-2000), Touran (2003-2008), Transporter (1990-2003)

Audi 80 (1991-1996), A3 (1996-2003), S3 (1999-2003), A4 (1995-2001) Cabriolet (1991-2000), A6 (1994-2002), TT (1998-2005)

Seat Alhambra (1996-2000), Arosa (1998-2005), Altea (2004-2008), Cordoba (1993-2006), Ibiza (1993-2006), Inca (1994-2004), Leon (1999-2005), Toledo (1994-2005)

Skoda Fabia (1999-2006), Felicia (1995-2001), Octavia (1996-2006), Superb (2002-2008)

**ENGINE CODES**

Diesel: 1.7 SDI: AHB, AHG, AKU, AKW, 1.9D: 1Y, AAZ, ABL, AEF, 1.9 SDI: EAF, AEY, AGD, AGP, AGM, ASX, ASY, AYQ, 1.9 TDI: 1Z, AAZ, AFF, AFN, AGR, AHF, AHH, AHU, ALE, ALH, ASV, AVG

Petrol: 1.6: 1F, ABM, ADA, ADP, AEH, AEK, AFT, AHL, AKL, AKS, ALZ, ANA, APF, ARM, AJR, AVU, AYD, BFG, BFS, BFQ, BGU, BSE, BSF, 1.8: ABS, ADR, ADZ, AGN, AJP, APG, APT, APX, ARG, 1.8T: AEB, AGU, AJH, AJL, AJQ, AMK, ANB, APP, APU, APY, AQA, AGX, ARX, ARY, ARZ, AUM, AVC, AVVC, AWV, AVU, AUQ, AYP, BAM, 1.8 16v: ADL, 2.0: 2E, AAC, AAE, ABF, ABK, ABT, ACE, ADY, AEG, AGG, AKT, APK, AGY, ATM, ATU, AWF, AWG, AXA, AZH, AZJ, AZL, AZM, BEH, 2.0 16v: ABF, 2.0FSI/TFSI: AXW, AXX, BGB, BHD, BLR, BLY, BMB, BPJ, BPY, BWA

**DESCRIPTION**

For inspecting and adjusting the camshaft control times  
Use as 3359, 2064/15-046/U20003/U40074, 2065A/U40021, T20038/MP1-312/T10098, MP1302/V159, T10020, T10092, T40011, 3366/T20044



FITS FOR:

ART.NR	ITEM NAME	PRICE
<b>BT597760</b>	engine adjustment tool set for VAG 1.8, 2.0 FSI, TFSI	<b>190,00 €</b>

**DESCRIPTION**

For checking and adjusting the engine timing  
Suitable for 1.8, 2.0L VAG engines with engine code BYT, BZB, CABA, CABB, CABD, CADA, CAEA, CAEB, CAWA, CAWB, CBFA, CCTA, CCZA, CCZB, CCZC, CCZD, CDA, CDAB, CDHA, CDHB, CDNB, CDNC, CDND, CESA, CETA, CFKA, CFPA, CGYA, CHHA, CHHB, CJBA, CJEB, CJK, CJKB, CJS, CJSB, CNCD, CPLA, CPSA  
Installed e.g. in Audi A4, A5 (from 2008 onwards), A6 (from 2012 onwards)

**DELIVERY SCOPE**

- Crankshaft counter support tool, use as OEM T10355
- Crankshaft thrust piece, use as OEM T10368
- Crankshaft thrust piece, use as OEM T10354
- Camshaft interlock bolt (4x), use as OEM T40196
- Chain adjuster interlocking clamp (2x), use as OEM T40267
- Drive sprocket blocking tool (2x), use as OEM T40271, T20208
- Camshaft valve tool, use as OEM T10352
- Camshaft valve tool, use as OEM T10352/1
- Camshaft valve tool, use as OEM T10352/2
- Tensioning marking pin, use as OEM T10060A
- Tensioning marking pin (2x), use as OEM T40011
- Marking pin for oil pump, use as OEM T40265



FITS FOR:

ART.NR	ITEM NAME	PRICE
<b>BT591070</b>	engine adjustment tool set for VAG 1.6, 2.0 CR TDI	<b>79,00 €</b>

**FOR THE FOLLOWING MODELS**

Audi A1, A3 (8P), A4 (8B), A5A6 (C6, C7), TT (8J), Q3, Q5  
Skoda Fabia II, Roomster, Praktik, Oktavia II, Suberb II, Yeti  
Seat Ibiza (6J), Leon III, Exeo, Altea, Alhambra II  
Volkswagen Golf V, VI und Plus, Eos, Polo V Jetta V und VI, Scirocco III, Beetle II, Caddy II, Passat B6, B7 und CC, Touran, Sharan II, T5, Amarok

**ENGINE CODES**

Engine codes CAYB, CAYC, CBAB, CBBB, CBAA, CFFB, CAGA, CAHA, CAGB, CAHB, CAGC, FCA, CAAA, CAAB, CAAC, CCHA, CAVA, CBAB, CBDA, CBDD, CBAC, CBDA, CBDC, etc.

**DESCRIPTION**

Contains important tools for checking and adjusting the timing after replacing the toothed belt  
Also suitable for earlier pump/nozzle engines

**DELIVERY SCOPE**

- Injection pump interlock, use as OEM T20102, U40074, 3359
- Crankshaft interlock, use as OEM T10050, T10100
- Ball head hexagon socket 6 mm, use as OEM T10264
- 2.5 mm tension roller locking pin, use as OEM T10265
- 3.9mm tension roller locking pin, use as OEM T40098
- Toothed belt pulley holding tool, use as OEM T10051
- Puller for toothed belt pulley, use as OEM T10052
- Oil pump/balance shaft adjustment tool, use as OEM T10255



FITS FOR:

ART.NR	ITEM NAME	PRICE
<b>BT597050</b>	engine adjustment tool set for Audi, VW V6 TDI	<b>10,00 €</b>

**FOR THE FOLLOWING MODELS**

Volkswagen Passat 2.5 V6 TDI  
Audi A4 2.5 V6 TDI  
Audi A6 2.5 V6 TDI  
Audi A8 2.5 V6 TDI  
Skoda Superb 2.5 V6 TDI

**ENGINE CODES**

Engine code: AFB, AKN, AKE, AYM, BAU, BCZ, BDG, BDH, BFC

**DESCRIPTION**

For locking the crankshaft/camshaft, and for carrying out work on the engine control, e.g. replacing the toothed belt, removing the cylinder heads etc.

**DELIVERY SCOPE**

- Crankshaft fixing mandrel, use as OEM 3242
- Camshaft interlock plates, use as OEM 3458



FITS FOR:

ART.NR	ITEM NAME	PRICE
<b>BT591086</b>	balancer shaft pul- ler for Audi, VW	<b>23,00 €</b>

**DESCRIPTION**

Makes it easier to remove balancer shafts  
Suitable for vehicles and engines with 4 cylinders 1.8, 2.0 L fuel injection engines with timing chain: Volkswagen Golf (from 2004 onwards), Passat (from 2006 onwards), Passat CC (from 2009 onwards), Tiguan (from 2008 onwards), Eos (from 2006 onwards), Audi A3 (from 2004 onwards), A4 (from 2008 onwards), A5 (from 2008 onwards), TT (from 2007 onwards)  
Use as OEM T10394  
Internal thread M8 x 1.25 mm for hammer  
Ideal as supplemental equipment for Art. BT551360



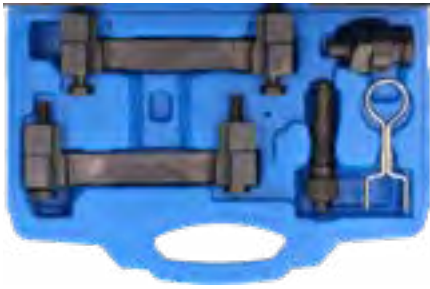

FITS FOR:

ART.NR	ITEM NAME	PRICE
BT591100	engine adjustment tool set for VAG 2.4, 2.8, 3.0 FSI	47,00 €

**DESCRIPTION**

For checking and adjusting the control times  
Suitable for Audi V6, V8 and V10 engines with chain

**DELIVERY SCOPE**

- Camshaft interlock, use as OEM T40070
- Crankshaft fixing mandrel, use as OEM T40069
- Locking pin for chain adjuster, use as OEM T40071
- Swivel adapter for crankshaft, use as OEM T40058



FITS FOR:

ART.NR	ITEM NAME	PRICE
BT591050	engine adjustment tool set for VAG 2.8, 3.0 FSI	89,00 €

**DESCRIPTION**

For checking and adjusting the control times  
Suitable for Audi V6, V8 and V10 engines with chain



FITS FOR:

ART.NR	ITEM NAME	PRICE
BT591084	crankshaft lathe tool for VAG	3,00 €

**DESCRIPTION**

Makes it easier to turn the crankshaft e.g. when checking the timing  
Suitable for Audi A6 up to year of construction 2005, Audi A8 up to year of construction 2003 with 6- and 8-cylinder engines 2.4L, 3.2L FSI, 6- and 8-cylinder TDI common rail  
Use as OEM T40058



FITS FOR:

ART.NR	ITEM NAME	PRICE
BT591088	drive gear fixing tool for VAG 3.6 FSI	10,00 €

**DESCRIPTION**

For fixing the high-pressure pump driving toothed wheel  
Needed for adjusting the valve timing  
Suitable for VAG 3.6L 6-cylinder 4-valve engines, installed in the Volkswagen Passat (357), (3C2), (3C5) from 2006 onwards, Touareg (7L6), (7LA) from 2006 onwards, Audi Q7 (4LB) from 2007 onwards  
Engine codes: BLV, BHL, BHK  
Use as OEM T10332



FITS FOR:

ART.NR	ITEM NAME	PRICE
BT597150	engine adjustment tool set for VAG 1.4, 1.6, 1.9, 2.0 SDI, TDI	18,00 €

**FOR THE FOLLOWING MODELS**

Audi A2 1.4 TDI (2002, 2006), A3 1.9, 2.0 TDI (2002, 2008), A4 1.6 TDI (2002, 2005), A4 1.9, 2.0 TDI (2004, 2008)  
Seat Altea 1.9 SDI, TDI (2005, 2008), Leon 1.9, 2.0 TDI (2005, 2008), Toledo 1.9 SDI, TDI (2005, 2008) engine codes: BJB, BKC, BLS, BMM, BXE  
Skoda Fabia 1.4 TDI (2003, 2006), OctaviaII 2.0 TDI (2003, 2006), engine codes: AMF, AZV, BKD  
Volkswagen Beetle 1.9 TDI (2002, 2008), Bora 1.9 TDI (2002, 2008), Fox 1.4 TDI (2002, 2008), Golf 1.9, 2.0 TDI (2002, 2008), Lupo 1.4 TDI (2002, 2008), Polo 1.4, 1.9 TDI (2002, 2008), Sharan 1.9 TDI (2002, 2008) engine codes: AJM, AMF, ANU, ARL, ASZ, ATD, AUJ, AVB, AVF, AVX, AXR, BAY, BMS, BNM, BNV, BWV

**DESCRIPTION**

For adjusting and checking the engine timing when replacing the toothed belt, camshaft etc.

**DELIVERY SCOPE**

- Crankshaft interlock, use as OEM T10100
- Pump wheel/camshaft interlock, use as OEM 3359, T20102, 9882, MB995206
- Crankshaft interlock, use as OEM T10050, 9883, 310-085, 23-059, MB995209
- 4 mm marking pin, use as OEM T10115, 303-1054, MB995208
- Auxiliary belt locking pin, use as OEM T10060A, T40098



FITS FOR:

ART.NR	ITEM NAME	PRICE
BT542078	crankshaft seal assembly device for VAG petrol & diesel engines	149,00 €

**FOR THE FOLLOWING MODELS**

Suitable for VAG vehicles Volkswagen Golf, Touran and Audi A3, A4 1.4i Turbo, 1.4 & 1.6 petrol direct injection, 1.9, 2.0 SDI, 2.0 common rail diesel engines

**DESCRIPTION**

For fitting the radial sealing ring on the transmission  
Attempting to fit the sealing ring without this tool may lead to leaks, destruction of the new sealing ring, and poor engine running  
Use as OEM T10134



FITS FOR:

ART.NR	ITEM NAME	PRICE
<b>BT591087</b>	camshaft turning insert for VAG 1.8, 2.0 TFSI	<b>9,00 €</b>

**DESCRIPTION**

For turning and holding the camshaft adjuster when working on the timing chain  
Suitable for 1.8, 2.0 TFSI engines (3rd generation), installed in e.g. the following models: Audi A3 (from 2012 onwards), A4 (from 2008 onwards), A5 (from 2009 onwards), A5 Coupe (from 2008 onwards), Q5 (from 2008 onwards), Seat Alhambra (from 2008 onwards), Exeo (from 2009 onwards), Altea (from 2009 onwards)  
Use as OEM T40266



FITS FOR:

ART.NR	ITEM NAME	PRICE
<b>BT542070</b>	crank/camshaft radial seal extraction set for VAG	<b>189,00 €</b>

**DESCRIPTION**

For removing radial sealing rings  
Grips the seal from the inside with its conical profile  
Suitable for most commercially available sealing rings  
Suitable for most VAG petrol engines e.g. VW Lupo and Polo 1.4i, VR6, Audi V6, etc.  
Contains the following extractors: 5 short extractors, Ø 25, 32, 35, 27, 55 mm  
1 long extractor, Ø 32 mm



FITS FOR:

ART.NR	ITEM NAME	PRICE
<b>BT591089</b>	drive gear fixing tool for VAG 3.6 FSI	<b>6,00 €</b>

**DESCRIPTION**

For fixing the high-pressure pump driving toothed wheel  
Needed for adjusting the valve timing  
Suitable for VAG 3.6L 6-cylinder 4-valve engines, installed in the Volkswagen Passat (357), (3C2), (3C5) from 2006 onwards, Touareg (7L6), (7LA) from 2006 onwards, Audi Q7 (4LB) from 2007 onwards  
Engine codes: BLV, BHL, BHK  
Use as OEM T10363



FITS FOR:

ART.NR	ITEM NAME	PRICE
<b>BT591260</b>	camshaft sprocket locking tool set, universal	<b>72,50 €</b>

**FOR THE FOLLOWING MODELS**

Can be used universally on vehicles from the following manufacturers: Audi, Alfa Romeo, Chrysler, Citroen, Ford, Honda, Hyundai, Isuzu, Land Rover, Lexus, Mazda, Mitsubishi, Peugeot, Renault, MG, Seat, Skoda, Subaru, Toyota, Opel, Volkswagen, Volvo

**DESCRIPTION**

For locking the camshaft sprockets e.g. when replacing the toothed belt  
Suitable for engines with 1, 2 and 4 camshafts (V engines); also suitable for locking between the camshaft sprocket and diesel injection pump wheel in some diesel engines

**DELIVERY SCOPE**

Double camshaft locking tool with short and long connecting arm  
Single camshaft locking tool with short and long locking screw



FITS FOR:

ART.NR	ITEM NAME	PRICE
<b>BT591094</b>	crankshaft locking tool for VAG 1.4, 1.6, 2.0 TDI (EA288)	<b>31,00 €</b>

**FOR THE FOLLOWING MODELS**

For the following vehicles: 1.4 TDI Audi A1, 1.4 TDI Seat Ibiza, Toledo IV, 1.4 TDI Skoda Fabia III, Rapid (2012), 1.4 TDI VW Polo V, 1.6 TDI Audi A1, A3 8V, A4 B9, Q2, o 1.6 TDI Seat Leon III, Toledo IV, Ateca, 1.6 TDI Skoda, Octavia III, Rapid (2012), Superb III, Karoq, o 1.6 TDI VW Beetle, Golf VII, Jetta VI, Tiguan, Touran II, T-Roc, Passat B8, CC, Scirocco III, 2.0 TDI Audi A3 8V, A4 B9, Q2, 2.0 TDI Seat Leon III, Ateca, Alhambra II, 2.0 TDI Skoda Octavia III, Superb III, Kodiak, Karoq, 2.0 TDI VW Beetle, Golf VII, Jetta VI, Tiguan, Tiguan II, Touran II, T-Roc, Sharan II, Passat B8, CC, Scirocco III, Arteon, T6, Caddy, Crafter, Amarok

**DESCRIPTION**

For adjusting and locking the crankshaft e.g. when working on the camshaft drive or replacing the cylinder head seal  
Suitable for: TDI common rail engines in the EA288 series  
Use as OEM T10490



FITS FOR:

ART.NR	ITEM NAME	PRICE
<b>BT596002</b>	universal camshaft wheel puller	<b>63,00 €</b>

**DESCRIPTION**

For pulling the pulley and camshaft gear  
Gripping arms are connected with each other via adjusting disk, thus the gripping arms can be set easily and exactly  
Continuous adjustment range of the gripping arms from 42 – 82 mm  
Gripping arm depth is 27 mm

**DELIVERY SCOPE**

3 x gripping arms, Ø 12 mm, M10 x 1.5, suitable for material thickness up to max. 10 mm  
6-groove puller body with adjusting disc  
Spindle, M14 x 1.5, 19 mm hex, with centring cone

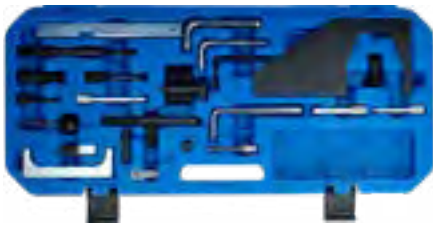

FITS FOR:



ART.NR	ITEM NAME	PRICE
BT593100	engine adjustment tool set for Ford	109,00 €

**FOR THE FOLLOWING MODELS**

Suitable for the following Ford engines: 1.4, 1.6 16V, 1.7, 1.8 16V, 2.0 16V (including Zetec), 1.4, 1.6, 1.8, 1.9 D/TD/TDCi

**DESCRIPTION**

Contains tools for: Locking the flywheel  
Locking the crankshaft, pump shaft  
Locking the injection pump shaft  
Removing the crankshaft pulley  
Tensioning the toothed belt  
Adjustment gauge for positioning the camshaft and pump shaft in relation to the crankshaft  
Use as OEM 21-162, 21-162B, 303-367, 303-376, 23-059, 310-085, 21-168, 303-393, 23-020, 23-047, 23-020, 21-163, 303-620, 23-019, 21-210, 303-507, 21-251, 303-698, 21-262, 303-734, 23-029, 303-1061, 23-058, 310-084, 21-105, 21-262, 303-734, 21-168, 303-393, 21-263, 303-735, Mazda 49JE01061, Audi 3359, T10008, T10050, 2065A, Seat 3359, T10008, T10050, 2065A, Skoda 3359, T10008, T10050, 2065A, Volkswagen 3359, T10008, T10050, 2065A



FITS FOR:



ART.NR	ITEM NAME	PRICE
BT546003	crankshaft radial seal assembly tool for VAG 2.0 TFSI	7,00 €

**DESCRIPTION**

For fitting the front crankshaft radial sealing ring  
Suitable for 4-cylinder 2.0L TFSI petrol engines, e.g. installed in the Audi A3



FITS FOR:



ART.NR	ITEM NAME	PRICE
BT595920	camshaft assembly tool set for VAG and Porsche	549,00 €

**FOR THE FOLLOWING MODELS**

Suitable for the following diesel vehicles (TDI CR) from 2003 onwards: Audi, Porsche, Seat, Skoda, Volkswagen with 1.2, 1.6, 2.0, 2.7, 3.0, 4.0, 4.2 common rail engines

**ENGINE CODES**

Engine codes ASB, ASE, BKN, BKS, BMK, BNG, BPP, BSG, BTR, BUG, BUN, BVN, CAAA, CAAB, CAAC, CAAD, CAAE, CAGA, CAGB, CAGC, CAHA, CAHB, CAMA, CAMB, CANA, CANB, CANC, CAND, CAPA, CARA, CASA, CASB, CASC, CASD, CATA, CAYA, CAYB, CAYC, CAYD, CAYE, CBAA, CBAB, CBAC, CBBA, CBBB, CBDA, CBDB, CBDC, CCFA, CCFC, CCHA, CCHB, CCLA, CCMA, CCWA, CCWB, CDBA, CDCA, CDSB, CDTA, CDTB, CDUC, CDUD, CDYA, CDYB, CDYC, CEGA, CEXA, CFCA, CFFA, CFFB, CFFD, CFFE, CFFB, CFFC, CFFD, CFHA, CFHB, CFHC, CFHD, CFHE, CFHF, CFJA, CFWA, CGKA, CGKB, CGLA, CGLB, CGLC, CGLD, CGLE, CGQB, CJAA, CJCA, CJCB, CJCC, CJCD, CJGA, CJGC, CJGD, CJMA, CKDA, CKTB, CKTC, CKUB, CKUC, CKVB, CKVC, CLAA, CLAB, CLCA, CLCB, CLJA, CLLA, CLNA, CLZB, CMEA, CMFA, CMFB, CMGB, CMHA, CNEA, CNFA, CNRB, CRCA, CSHA, M05/9D (CAS), M05/9E, M05/9E (CRCA), M05/9E (CRCB)

**DESCRIPTION**

For installing the camshafts in the correct position  
Needed when installing new or existing camshafts; attempting installation without this tool may lead to damage on the camshaft bearing bridge and the cylinder head

**DELIVERY SCOPE**

Mounting device including pre-assembled parts, use as OEM T40094  
Camshaft clamp, use as OEM T40095  
2 alignment clamps, use as OEM T40096, T40096/1  
4 camshaft brackets for mounting device, use as OEM T40094/1, T40094/2, T40094/9, T40094/10  
Interlock for camshaft bracket, use as OEM T40094/11



FITS FOR:



ART.NR	ITEM NAME	PRICE
BT595910	timing chain test tool set for VAG 1.2, 1.4 TFSi	149,00 €

**FOR THE FOLLOWING MODELS**

Audi: A1 (2012-2015), A1 Sportback (2012-2015), A3 (2013-2015), A3 (2013-2015), A3 Sportback (2012-2015)

Seat: Ibiza (2012-2017), Leon (2012-2015), Toledo (2012-2017)

Skoda: Fabia II (2010-2015), Fabia III (2014-2017), Octavia II (2010-2013), Octavia III (2010-2015), Praktik (2010-2015), Roomster (2010-2015), Rapid (2015-2017)

Volkswagen: Golf VI & VII (2008-2015), Golf VII Kombi (2008-2017), Jetta (2012-2017), Polo (2012-2017), Sportsvan (2014-2017)

**DESCRIPTION**

For checking the timing chain elongation on VAG 1.2 and 1.4L TFSi engines

Prevents costly repairs at a later stage due to the timing chain slipping

**DELIVERY SCOPE**

Timing chain test tool set, use as OEM T10550  
Comprises the following tools: Camshaft fixing tool, use as OEM T10550/1; indicator, use as OEM T10550/2; scale sleeve with crankshaft pulley plate, use as OEM T10550/3



**SUBSCRIBE TO THE NEWSLETTER NOW!**

**ALWAYS UP-TO-DATE:**

[WWW.BRILLIANT-TOOLS.COM/NEWSLETTER](http://WWW.BRILLIANT-TOOLS.COM/NEWSLETTER)

# BMW

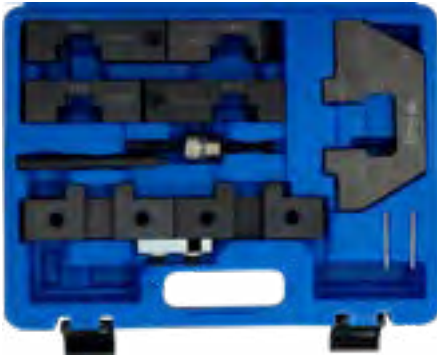

FITS FOR:



ART.NR	ITEM NAME	PRICE
<b>BT591900</b>	Engine adjustment tool set for BMW 1.6	<b>249,00 €</b>

#### FOR THE FOLLOWING MODELS

For BMW models 116 1.6 i E81, E87, 316 1.6 i E46, E90 316 1.6 Ci, E46 316 1.6 ti E46

#### DESCRIPTION

Suitable for timing-chain-driven engines with Vanos, engine code N40, N45, N45T (B16)

#### DELIVERY SCOPE

Crankshaft adjusting pin, use as OEM 119190  
Timing chain tensioning tool, use as OEM 119340, 119341  
Camshaft adjustment tool (intake), use as OEM 117252  
Camshaft adjustment tool (exhaust), use as OEM 117251  
Vanos adjustment tool, use as OEM 117260



FITS FOR:



ART.NR	ITEM NAME	PRICE
<b>BT591651</b>	Camshaft locking tool for BMW	<b>17,00 €</b>

#### DESCRIPTION

Suitable for BMW engines in the M57, M57TU, M57T2N47, M47TU, M47T2 series  
Also suitable for structurally identical engines in the Range Rover 2.5 DT, Freelander 2.0 TD4, Omega B Y25DT



FITS FOR:



ART.NR	ITEM NAME	PRICE
<b>BT591580</b>	Engine adjustment tool set for BMW, MINI, PSA	<b>69,00 €</b>

#### FOR THE FOLLOWING MODELS

BMW 1.6 (N40, N45, N45T, B16, B16A, B16AC) 1.8, 2.0 (N42, N46, N46T) 2.0, 3.0 (N51, N52, N52K, N53, N54)

PSA 1.4, 1.6 16V (EP3, EP6, EP6DT, EP6DTS)

MINI 1.4, 1.6 (N12, N14)

#### DESCRIPTION

For aligning new and old versions of balance shafts  
Prevents non-concentric engine running due to incorrectly aligned balance shafts  
Needed when changing the timing chain, replacing the crankshaft sealing ring, replacing the cylinder head seal etc.  
Use as OEM 115140, 119280, 119330

#### DELIVERY SCOPE

Balance shaft fixing tool (old and new version)  
Crankshaft counter support  
Locking pin for chain tensioner



FITS FOR:



ART.NR	ITEM NAME	PRICE
<b>BT591515</b>	Balance shaft adjustment tool for BMW N40, N42, N45, N46	<b>11,00 €</b>

#### DESCRIPTION

For aligning the balance shafts



FITS FOR:



ART.NR	ITEM NAME	PRICE
<b>BT541120</b>	Camshaft assembly tool for BMW N51, N52	<b>249,00 €</b>

#### DESCRIPTION

For assembling the discharge camshaft bearing strip  
Needed when replacing the camshaft  
For use in combination with tool Art. BT592000

#### DELIVERY SCOPE

Hold-down tool, 2-cylinder, use as OEM 114 461  
2 M7 screws, use as OEM 114 462  
6 pressure pieces, use as OEM 114 463



FITS FOR:



ART.NR	ITEM NAME	PRICE
<b>BT551008</b>	Injection pump wheel assembly tool for BMW	<b>15,00 €</b>

#### FOR THE FOLLOWING MODELS

Suitable for series E46 (318D-320D) (1988, 2005) and E60, E61 (318TD-320TD-525D-530D-530-535) (2000, 2006)

#### ENGINE CODES

Suitable for BMW engines M47, M47T2, M47TU, M57, M57TU

#### DESCRIPTION

Holds the gear in place while the injection pump is installed



FITS FOR:

ART.NR	ITEM NAME	PRICE
<b>BT591560</b>	Engine adjustment tool set for BMW M62 Vanos	<b>379,00 €</b>

**DESCRIPTION**

For inspecting and adjusting the engine control times  
Suitable for e.g. engine series: M62B35, M62B44, M62TUB44

**DELIVERY SCOPE**

- Vanos valve insert, use as OEM 11 6 420
- Chain tensioning aid, use as OEM 11 7 380
- Turning tool, use as OEM 11 6 440
- Sensor wheel tool set, use as OEM 11 6 450, consisting of: Sensor wheel tool for cylinders 1 to 4, use as OEM 11 6 451; sensor wheel tool for cylinders 5 to 8, use as OEM 11 6 452
- Camshaft interlock for cylinders 1 to 4, use as OEM 11 2 445, 11 2 441
- Camshaft interlock for cylinders 5 to 8, use as OEM 11 2 442, 11 2 446
- Chain tensioner, use as OEM 11 3 390
- Crankshaft interlock, use as OEM 11 2 300

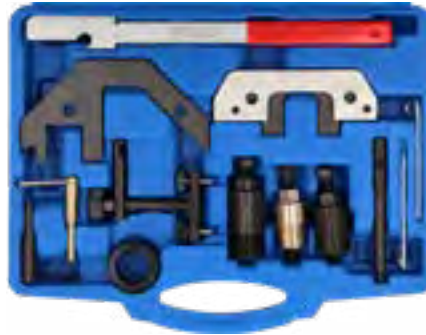

FITS FOR:

ART.NR	ITEM NAME	PRICE
<b>BT591650</b>	Engine adjustment tool set for BMW Diesel	<b>129,00 €</b>

**FOR THE FOLLOWING MODELS**

BMW 1, 3, 5, 6, 7, X3, X 5 (series E34-36-38-39-66-83-90-91-92-93)  
Land Rover, Range Rover, Freelander  
Rover 75, MG, MG ZT  
Vauxhall, Opel Omega-B

**ENGINE CODES**

M41, M51, M47 M47 TU/T2, M57 TU/T2 2.0i/3.0i (1998-2008)  
204D3, Td4, Td 6  
M47R

**DELIVERY SCOPE**

- Timing chain counter support, use as OEM BMW 113360, Range Rover LRT-12-115
- Camshaft alignment tool, use as OEM BMW 116321 (116320), Opel KM6267
- Securing bracket alignment tool, use as OEM BMW 116322 (116320)
- Injection pump extractor (long), use as OEM BMW 135120
- Injection pump extractor, use as OEM BMW 135120, Range Rover LRT-12-119
- Injection pump extractor (short), use as OEM BMW 135191, 135192 (135190), Opel KM6270
- Threaded ring, use as OEM BMW 135191, 135192 (135190), Opel KM6270
- Camshaft securing bridge, use as OEM BMW 113320, Rover LRT-12-112
- Crankshaft marking pin, use as OEM BMW 115180
- Crankshaft marking pin, use as OEM BMW 116080
- Tension roller marking pins, use as OEM BMW 113340, Range Rover LRT-12-114, Opel KM-823
- Crankshaft marking pin, use as OEM BMW 112300, Range Rover LRT-12-108

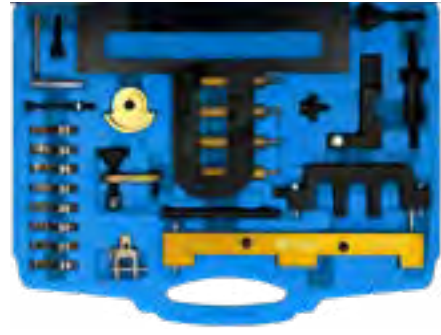

FITS FOR:

ART.NR	ITEM NAME	PRICE
<b>BT592100</b>	Engine adjustment tool set for BMW petrol engines	<b>199,00 €</b>

**FOR THE FOLLOWING MODELS**

BMW 1, 3, 5, X3, Z4 (series E87-46-60-85-83-90-91)

**ENGINE CODES**

N42, N46, B18-A, B20-A/B

**DESCRIPTION**

For e.g. installing and removing the camshafts  
Checking and adjusting the engine timing

**DELIVERY SCOPE**

- Clips for intermediate lever, use as OEM 119310
- Bearing bridge clamp, use as OEM 119320
- Knurled screw, use as OEM 119302
- Bracket of eccentric shaft, use as OEM 119301
- Camshaft interlock, use as OEM 119290
- Camshaft interlock (intake), use as OEM 119302
- Clamping tool, use as OEM 119340
- Torsion spring holder, use as OEM 119390
- Camshaft sensor tool, use as OEM 119350
- Retaining screw, use as OEM 119390
- Camshaft key, use as OEM 119270
- Crankshaft marking mandrel (straight), use as OEM 112300
- 3x assembly bolts, use as OEM 119320
- Retaining screw, use as OEM 119290
- Camshaft interlock, use as OEM 119290
- Crankshaft marking mandrel (bent), use as OEM 119190
- Assembly bolt, use as OEM 119320
- Balance shaft rule, use as OEM 119330



FITS FOR:



ART.NR	ITEM NAME	PRICE
<b>BT591830</b>	Engine adjustment tool set for BMW, M52, M54, M60, M62	<b>269,00 €</b>

**FOR THE FOLLOWING MODELS**

320 E46, 323 E46, 325 E46, 328 E46, 330 E46, 520 E39, 520 E60, 520 E39, 523 E39, 525 E39, 525 E60, 528 E39, 530 E34, 540 E34, 535 E39, 530 E39, 530 E60, 728 E38, 730 E65, 730 E35, 730 E32, 735 E38, 740 E32, 740 E38- X3 E83, X5 E53, Z3, Z4 E85

**DESCRIPTION**

For adjusting and checking the engine timing

**DELIVERY SCOPE**

Camshaft adjustment tool (M52, M54), use as OEM 11 6 150  
 Vanos inspection gauge (M52, M54), use as OEM 11 3 450  
 Locking block cylinder 1-4 (M60, M62), use as OEM 11 2 445 or OEM 11 2 441  
 Locking block cylinder 5-8 (M60, M62), use as OEM 11 2 442 or OEM 11 2 446  
 Chain tensioner (M52, M54), use as OEM 11 4 220  
 Chain tensioner (M60, M62), use as OEM 11 4 230  
 Crankshaft interlock use as OEM 11 2 300  
 Test adapter (M52, M54)  
 Chain tensioner pin (M60, M62)

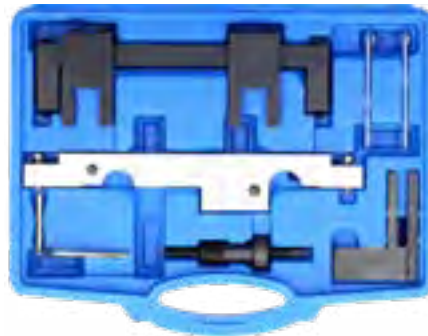

FITS FOR:



ART.NR	ITEM NAME	PRICE
<b>BT591570</b>	Engine adjustment tool set for BMW N43	<b>149,00 €</b>

**FOR THE FOLLOWING MODELS**

1-Series E81, E82, E87, E88 (2006, 2012)  
 3-Series E90, E91, E92, E93 (2006, 2012)  
 5-Series E60, E61 (2007, 2010)

**ENGINE CODES**

Engine codes: N43 (B16A/AA), N43 (B20A), N43 (B20AA), N43 (B20AY), N43 (B20KO), N43 (B20UO)

**DESCRIPTION**

For checking and adjusting the engine timing

Use as OEM tools 113340, 118690, 118691, 118692, 118693, 119340, 119341, 119342, 118710, 118711, 118712, 118700, 115120

**DELIVERY SCOPE**

Tool for chain tensioner  
 Cam shaft fixing tool  
 Balance shaft fixing tool  
 Crankshaft fixing tool

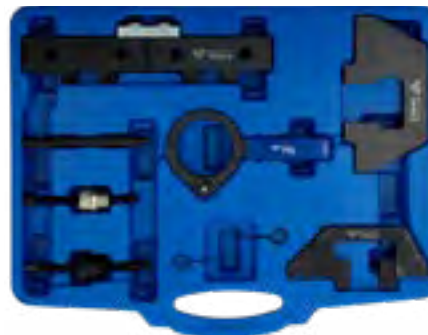

FITS FOR:



ART.NR	ITEM NAME	PRICE
<b>BT591950</b>	Engine adjustment tool set for BMW M42, M50	<b>179,00 €</b>

**DESCRIPTION**

For adjusting the camshaft e.g. after replacing the timing chain and cylinder head seal  
 Suitable for BMW engines in the M42 and M50 series  
 Use as OEM 113240 and 112300

**DELIVERY SCOPE**

Camshaft interlock  
 Flywheel interlock

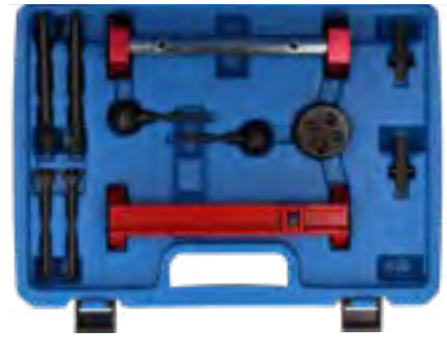

FITS FOR:



ART.NR	ITEM NAME	PRICE
<b>BT592260</b>	Engine adjustment tool set for BMW S54	<b>169,00 €</b>

**FOR THE FOLLOWING MODELS**

BMW M3 Cabriolet (2000-2006), Sports Coupe (1999-2006), CSL Sport Coupe (2003-2004)

**DESCRIPTION**

For checking and adjusting the camshaft timing when installing the Vanos adjustment unit on S54 engines  
 Use as OEM 119140, 119130, 119170, 117340, 115100, 17160, 112300, 110480



FITS FOR:



ART.NR	ITEM NAME	PRICE
<b>BT591580</b>	Engine adjustment tool set for BMW, MINI, PSA	<b>69,00 €</b>

**FOR THE FOLLOWING MODELS**

BMW 1.6 (N40, N45, N45T, B16, B16A, B16AC) 1.8, 2.0 (N42, N46, N46T) 2.0, 3.0 (N51, N52, N52K, N53, N54)  
 PSA 1.4, 1.6 16V (EP3, EP6, EP6DT, EP6DTS)  
 MINI 1.4, 1.6 (N12, N14)

**DESCRIPTION**

For aligning new and old versions of balance shafts  
 Prevents non-concentric engine running due to incorrectly aligned balance shafts  
 Needed when changing the timing chain, replacing the crankshaft sealing ring, replacing the cylinder head seal etc.  
 Use as OEM 115140, 119280, 119330

**DELIVERY SCOPE**

Balance shaft fixing tool (old and new version)  
 Crankshaft counter support  
 Locking pin for chain tensioner

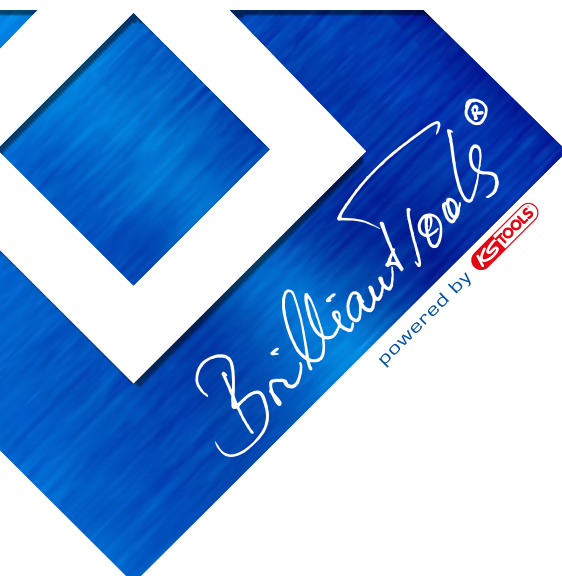

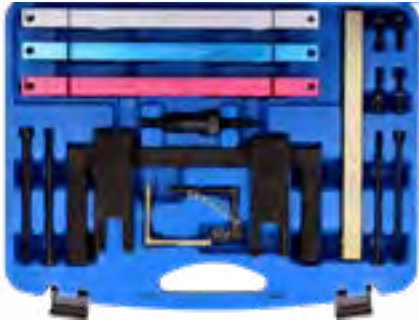

FITS FOR:



ART.NR	ITEM NAME	PRICE
<b>BT592000</b>	engine adjustment tool set for BMW N51, N52, N52K, N53, N54, N55	<b>269,00 €</b>

**FOR THE FOLLOWING MODELS**

E60 523i, 523Li, 525i, 525Li, 525xi, 528i, 528xi, 530i, 530Li, 530xi, 535i, 535xi  
 E61/E63 523i, 525i, 525xi, 530i, 530xi, 535xi, 630i  
 E64/E65 630i, 730i  
 E66/E70 730Li, X5 3.0Si  
 E81/E82 130i, 135is  
 E93 325i, 328i, 330i, 335i  
 E83 X3 2.5i, 2.5Si, 3.0i, 3.0S  
 E85/E86 Z4 2.5i, 2.5Si, 3.0i, 3.0Si, Z4 3.0Si  
 E87/E90 130i, 323i, 325i, 325xi, 328i, 328xi, 330i, 330xi, 335i, 335xi  
 E91 323i, 325i, 325xi, 328i, 328xi, 330i, 330xi, 335i, 335xi  
 E92 323i, 325i, 325xi, 328i, 328xi, 330i, 330xi, 335i

**DESCRIPTION**

Contains important tools for e.g. installing and removing the camshafts, replacing the toothed belt, checking and adjusting the timing

**DELIVERY SCOPE**

Flywheel docking tool, use as OEM 110300  
 Camshaft fixing tool, use as OEM 114280, 114281, 114282, 114283  
 Camshaft sensor wheel retainer, use as OEM 118520  
 Camshaft sensor wheel retainer, use as OEM 114290



FITS FOR:



ART.NR	ITEM NAME	PRICE
<b>BT596000</b>	Engine adjustment tools for BMW	<b>15,00 €</b>

**ENGINE CODES**

M50, M52 TU, M54, S50, S52

**DESCRIPTION**

For turning the drive sprocket during dismantling and installation of the Vanos adjusting unit  
 Use as OEM 11 5 490

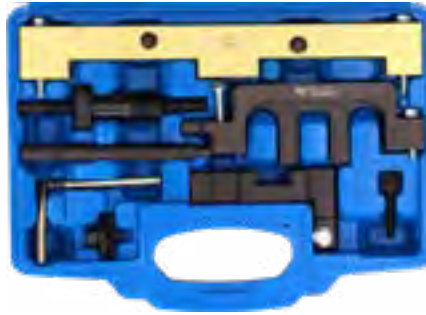

FITS FOR:



ART.NR	ITEM NAME	PRICE
<b>BT592200</b>	Engine adjustment tool set for BMW N42, N46, N46T	<b>79,00 €</b>

**FOR THE FOLLOWING MODELS**

E81 (116i, 118i, 120i) E87 (118i, 120i)  
 E88 (120i) E46 (316i, 316ti, 316i, 318ci, 318ti)  
 E90 (318i, 320i) E91 (318i, 320i) E92 (320i)  
 E93 (320i) E60 (520i) E83 (X3 2.0) E85 (Z4 2.0)

**DESCRIPTION**

For adjusting/checking the engine timing and Vanos unit

**DELIVERY SCOPE**

Clamping tool, use as OEM 119340  
 Sensor wheel adjustment tool, use as OEM 119350  
 E-camshaft interlock, use as OEM 119292  
 A-camshaft interlock, use as OEM 119291  
 Flywheel interlock, use as OEM 115120  
 Camshaft alignment, use as OEM 119270  
 Screw for interlock tool, use as OEM 119293  
 Crankshaft locking bolt, use as OEM 119190



ART.NR	ITEM NAME	PRICE
<b>BT551376</b>	Petrol injection nozzle tool for BMW	<b>65,00 €</b>

**DESCRIPTION**

For installing and removing petrol injection nozzles  
 Suitable for BMW straight-six turbo engines with petrol direct injection from 2009 onwards  
 use as BMW OEM 13 0 270



FITS FOR:



ART.NR	ITEM NAME	PRICE
<b>BT591810</b>	Engine adjustment tool set for BMW N62, N73	<b>189,00 €</b>

**FOR THE FOLLOWING MODELS**

E60, E61, E63, E64, E65, E66, E53  
 540i, 545i, 550i, 645i, 650i, 735i, 740i, 745i, 750i, 760i, X5

**ENGINE CODES**

With engines of the following series: N62 B40A, B44A, B48B (year of construction 2003, 2010), N62 B44A, B48B (year of construction 2003, 2010), N62 B36A, B40A, B44A, B48B, N73 B60A (year of construction 2002, 2008), N62 B44A, B48A (year of construction 2003, 2007)

**DESCRIPTION**

For checking and adjusting the engine timing

**DELIVERY SCOPE**

Holder, Timing chain tensioner, Intake camshaft interlock, Discharge camshaft interlock, Crankshaft interlock, Graduated disc segment, Spacer, Socket, Special ring with indicator, Crankshaft marking pin



FITS FOR:



ART.NR	ITEM NAME	PRICE
<b>BT591520</b>	Engine adjustment tool set for BMW N13, N18	<b>119,00 €</b>

**FOR THE FOLLOWING MODELS**

114i (F20) (N13B16) from 07/2012 onwards  
 116i (F20) (N13B16) from 09/2011 onwards  
 316i (F30) (N13B16) from 11/2012 onwards  
 118i (F20) (N13B16) from 09/2011 onwards  
 320i EfficientDynamics (F30) (N13B16) from 11/2012 onwards

**DESCRIPTION**

For checking and adjusting the camshaft timing e.g. when working on the valve train, replacing the cylinder head seal etc.  
 Use as BMW OEM 11 7 440, 11 9 340, 49 6 709, 11 9 590, 2299362



FITS FOR:



ART.NR	ITEM NAME	PRICE
<b>BT593750</b>	Engine adjustment tool set for MINI	<b>145,00 €</b>

**FOR THE FOLLOWING MODELS**

Suitable for the following models: MINI One, Cooper, Cooper S, Cooper S JC Cooper S JCW (series R50, 52, 53, 55, 56, 57)

**ENGINE CODES**

For engine codes W10, W11, N14

**DESCRIPTION**

For working on intake and exhaust camshafts

**DELIVERY SCOPE**

Fixing of camshafts, use as OEM 119551 and 119552

Fixing of crankshaft, use as OEM 119590

Tools for chain tensioner, use as OEM 119340

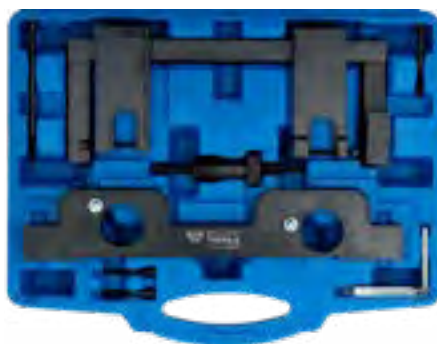

FITS FOR:



ART.NR	ITEM NAME	PRICE
<b>BT591750</b>	Engine adjustment tool set for BMW N20, N26	<b>179,00 €</b>

**FOR THE FOLLOWING MODELS**

For the following BMW models: 320i (F30) (2.0 l N20B20) from 2012, 328i (F30) (2.0 l N20B20) from 2012 onwards, X1 xDrive20i, sDrive20i (E84) (2.0 l N20B20) 2010-2012

**DESCRIPTION**

For checking and adjusting the camshaft timing e.g. when working on the valve train, replacing the cylinder head seal etc.

Use as OEM 119340, 2212830, 2212831, 2219548



FITS FOR:



ART.NR	ITEM NAME	PRICE
<b>BT591830</b>	Engine adjustment tool set for BMW, M52, M54, M60, M62	<b>269,00 €</b>

**FOR THE FOLLOWING MODELS**

320 E46, 323 E46, 325 E46, 328 E46, 330 E46, 520 E39, 520 E60, 520 E39, 523 E39, 525 E39, 525 E60, 528 E39, 530 E34, 540 E34, 535 E39, 530 E39, 530 E60, 728 E38, 730 E65, 730 E35, 730 E32, 735 E38, 740 E32, 740 E38- X3 E83, X5 E53, Z3, Z4 E85

**DESCRIPTION**

For adjusting and checking the engine timing

**DELIVERY SCOPE**

Camshaft adjustment tool (M52, M54), use as OEM 11 6 150

Vanos inspection gauge (M52, M54), use as OEM 11 3 450

Locking block cylinder 1-4 (M60, M62), use as OEM 11 2 445 or OEM 11 2 441

Locking block cylinder 5-8 (M60, M62), use as OEM 11 2 442 or OEM 11 2 446

Chain tensioner (M52, M54), use as OEM 11 4 220

Chain tensioner (M60, M62), use as OEM 11 4 230

Crankshaft interlock use as OEM 11 2 300

Test adapter (M52, M54)

Chain tensioner pin (M60, M62)



FITS FOR:



ART.NR	ITEM NAME	PRICE
<b>BT591556</b>	Balancing shaft fixing tool for BMW	<b>9,00 €</b>

**DESCRIPTION**

For fixing/adjusting the balancing shafts

L-shaped with 9 mm slit

Use as OEM 118700





FITS FOR:

ART.NR	ITEM NAME	PRICE
BT591550	Engine adjustment tool set for BMW N47, N47S, N57	35,00 €

**FOR THE FOLLOWING MODELS**

Installed in the following vehicles: 116d 118d 120d 123d, product line E81 E82 E87 E88 F20, 316d 318d 320d 325d 330d product line E90 E91 E92 E93 F30, 520d 525d 530d 530d GT 535d 535d GT M550d, product line E60 E61 F07 F10 F11, 640d product line F12, 730d 740d 750d, product line F01, X1 1.8d 2.0d 2.3d, product line E84, X3 1.8d 2.0d 3.0d, 3.5d product line E83 F25, X5 3.0d 4.0d M5.0d, product line E70, X6 3.0d 4.0d M5.0d, product line E71

**DESCRIPTION**

For adjusting and checking the engine timing  
Used when installing or removing the camshaft, replacing the timing chain, replacing the cylinder head seal

**DELIVERY SCOPE**

Crankshaft lathe tool, use as OEM 116480  
Camshaft interlock, use as OEM 118760  
Sprocket support sleeve, use as OEM 118740, 118741, 118742  
Crankshaft gear locking pin, use as OEM 115320



FITS FOR:

ART.NR	ITEM NAME	PRICE
BT591822	Crankshaft holding tool for BMW N47, N57	12,00 €

**DESCRIPTION**

For holding the crankshaft in place  
Use as OEM 114320  
Required when replacing the secondary drive chain  
Supplementary tool for engine adjustment tool set for BMW Art. BT591550



FITS FOR:

ART.NR	ITEM NAME	PRICE
BT591850	Engine adjustment tool set for BMW N63	119,00 €

**DESCRIPTION**

For adjusting the engine timing when replacing the timing belt, repairing the cylinder head, replacing the cylinder head seal, etc.

**DELIVERY SCOPE**

Crankshaft interlock, use as OEM 118570, 119190  
Camshaft interlock, use as OEM 119890  
Knurled screw, use as OEM 119891  
Hold-down bar, use as OEM 119892  
Snap gauge for intake and discharge camshaft, use as OEM 119893  
Spacer, use as OEM 119894



FITS FOR:

ART.NR	ITEM NAME	PRICE
BT591824	Crankshaft counter holder for BMW M52TU, M54, M56	89,00 €

**DESCRIPTION**

For holding the crankshaft pulley while loosening or tightening the middle pulley screw  
Enables safe, damage-free assembly/disassembly  
Use with 12.5 mm (1/2") ratchet, slide grip etc.



FITS FOR:

ART.NR	ITEM NAME	PRICE
BT591823	Crankshaft turning tool for BMW M52, M54, M56	12,00 €

**DESCRIPTION**

For holding the crankshaft pulley while loosening or tightening the middle pulley screw  
Enables safe, damage-free assembly/disassembly  
Use as OEM 116480



FITS FOR:

ART.NR	ITEM NAME	PRICE
BT591840	Crankshaft counter holder for BMW M52TU, M54, M56	129,00 €

**DESCRIPTION**

For holding the crankshaft pulley while loosening or tightening the middle pulley screw  
Enables safe, damage-free assembly/disassembly



**ALWAYS UP-TO-DATE:**

**WWW.BRILLIANT-TOOLS.COM**



ART.NR	ITEM NAME	PRICE
<b>BT591870</b>	Engine adjustment tool set for MINI, Citroen, Peugeot 1.6L diesel	<b>15,00 €</b>

**FOR THE FOLLOWING MODELS**

BMW MINI, MINI Clubman, series R55, R56, R57  
Citroen C2, C3, C4, C5, Grand Picasso, Berlingo (MK3), Xsara Picasso  
Peugeot 206, 206cc, 207, 207cc, 1007, 307, 308, 308cc, 3008, 5008, Partner (MK3)

**ENGINE CODES**

Engine codes: BMW: W16D16 (9HZ), W16D16UO, PSA: 9HZ, 9HX, 9HY (DV6TED4)

**DESCRIPTION**

For adjusting and checking the engine timing  
Suitable for the following models with a 1.6L diesel engine

**DELIVERY SCOPE**

Crankshaft marking pin, use as OEM PSA 0194A, BMW 119790  
Marking pins for camshaft and high-pressure pump, use as OEM PSA 0194B, BMW 110300  
Flywheel interlock, use as OEM PSA 0194C, BMW 119850, 119851, 119852



ART.NR	ITEM NAME	PRICE
<b>BT591880</b>	Engine adjustment tool set for BMW, Land Rover V8	<b>179,00 €</b>

**FOR THE FOLLOWING MODELS**

BMW 530i (1994, 1995), 540i (1997, 2003), 740i (1993, 1995), 740iL (1993, 2001), 840Ci (1995, 1996), X5 (2000, 2003)  
Range Rover with M60, M62 and M62TU V8 engines

**DESCRIPTION**

For adjusting and checking the engine timing  
Needed e.g. when working on the valve train and replacing the cylinder head seal

**DELIVERY SCOPE**

Discharge camshaft adjustment tool (cylinders 1-4), use as OEM BMW 112445, Rover LRT 12-223/2  
Intake camshaft adjustment tool (cylinders 1-4), use as OEM BMW 112441, Rover LRT 12-223/1  
Intake camshaft adjustment tool (cylinders 5-8), use as OEM BMW 112442, Rover LRT 12-223/3  
Discharge camshaft adjustment tool (cylinders 5-8), use as OEM BMW 112446, LRT 12-223/4  
Fixing tools for camshaft adjuster (A-D)  
Crankshaft locking pin, use as OEM 112300  
Timing chain tensioner, use as OEM 113390

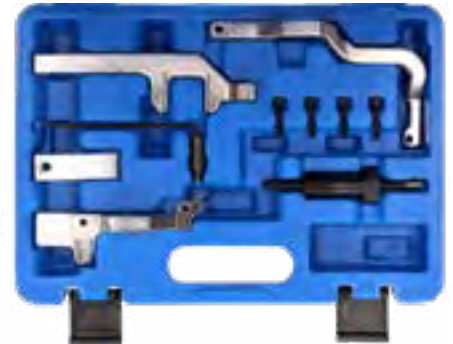

ART.NR	ITEM NAME	PRICE
<b>BT593800</b>	Engine adjustment tool set for MINI, PSA	<b>119,00 €</b>

**FOR THE FOLLOWING MODELS**

MINI One, Cooper HB, Cooper (R55-56) N12 engine  
Citroen C4 (year of construction 2008, 2009), C4 Picasso (year of construction 2008, 2009)  
Peugeot 207 (year of construction 2006, 2009), 207CC (year of construction 2007, 2009), 308 (year of construction 2001, 2009)

Engines: 1.4, 1.6 VTi, EP3 (8FS) EP6 (5FW), EP6C 1.6 THP, EP6DT (5FX) EP6DTS (5FY)

**DESCRIPTION**

Needed when replacing the cylinder head seal and when working on the engine timing

**DELIVERY SCOPE**

Crankshaft fixer, use as OEM 119590, 0197-BZ  
Camshaft fixer, use as OEM 119540, 0197-A1, 0197-A3  
Chain tensioner, use as OEM 119340, 0197-M



ART.NR	ITEM NAME	PRICE
<b>BT591825</b>	Timing chain tensioning tool for BMW N63	<b>75,00 €</b>

**DESCRIPTION**

Needed for adjusting the engine timing  
Calibrating the timing without this tool may result in faulty settings  
Use as OEM 119900





**FITS FOR:**

ART.NR	ITEM NAME	PRICE
<b>BT671050</b>	Drive shaft retractor set	<b>89,00 €</b>

**FOR THE FOLLOWING MODELS**

- M16 x 1.5 mm: for Subaru
- M20 x 1.5 mm: for VW Beetle, Touareg, Porsche Cayenne
- M22 x 1.5 mm: for BMW E30, E46
- M24 x 1.5 mm: for BMW E36, Mercedes W203
- M27 x 1.5 mm: for BMW E32, E34, E38, E39, X5
- M30 x 1.5 mm: for BMW E32, E34, E36

**DESCRIPTION**

For pulling the drive shaft into the wheel hub  
In a standardised industrial bearing  
Contains 6 pulling sleeves with various threads



**FITS FOR:**

ART.NR	ITEM NAME	PRICE
<b>BT593750</b>	Engine adjustment tool set for MINI	<b>145,00 €</b>

**FOR THE FOLLOWING MODELS**

Suitable for the following models: MINI One, Cooper, Cooper S, Cooper S JC Cooper S JCW (series R50, 52, 53, 55, 56, 57)

**ENGINE CODES**

For engine codes W10, W11, N14

**DESCRIPTION**

For working on intake and exhaust camshafts

**DELIVERY SCOPE**

Fixing of camshafts, use as OEM 119551 and 119552  
Fixing of crankshaft, use as OEM 119590  
Tools for chain tensioner, use as OEM 119340



**FITS FOR:**

ART.NR	ITEM NAME	PRICE
<b>BT541060</b>	Camshaft assembly tool for BMW N53, N54	<b>125,00 €</b>

**DESCRIPTION**

For holding down the valve springs when fitting the camshafts  
Prevents breakage of the camshaft

**DELIVERY SCOPE**

Camshaft assembly tool, use as OEM 11 8 550, consisting of:  
Valve spring hold-down device, use as OEM 11 8 551  
Fixing bolt, use as OEM 11 8 552



**FITS FOR:**

ART.NR	ITEM NAME	PRICE
<b>BT591500</b>	Engine adjustment tool set for BMW M60, M62	<b>109,00 €</b>

**DESCRIPTION**

For adjusting the camshaft e.g. after replacing the timing chain and cylinder head seal  
Suitable for BMW engines in the M60 and M62 series  
Use as OEM 112441, 112442, 112445, 112446, 112300, 113390

**DELIVERY SCOPE**

Camshaft interlock  
Flywheel interlock



**FITS FOR:**

ART.NR	ITEM NAME	PRICE
<b>BT591860</b>	Balancing shaft locking tool for BMW N20	<b>37,00 €</b>

**DESCRIPTION**

For locking the balancing shaft and securing the sprocket  
Needed e.g. when carrying out repairs on the chain drive

**DELIVERY SCOPE**

1 balancing shaft fixing mandrel, use as OEM 2212825  
1 sprocket holder, use as OEM 2318117  
2 screws PH3 M6 x 1.0 drive external hex SW 10 (length: 26mm)



**FITS FOR:**

ART.NR	ITEM NAME	PRICE
<b>BT641060</b>	Flywheel locking tool for Citroen, Fiat, Peugeot	<b>4,00 €</b>

**FOR THE FOLLOWING MODELS**

for Citroen, Fiat, Peugeot  
Also suitable for structurally identical engines in BMW, Renault, Mercedes-Benz

**DELIVERY SCOPE**

Flywheel interlock, use as OEM BMW 119260, Renault MOT 582-01, PSA 0153A, 6012T, 9765.54, Fiat 1860161000, 1867030000, Mercedes-Benz 607589014000

# CHEVROLET



FITS FOR:



ART.NR	ITEM NAME	PRICE
<b>BT593815</b>	Engine adjustment tool set for Opel, Saab, Buick, Cadillac, Chevrolet 2.8, 3.6 V6	<b>54,00 €</b>

#### FOR THE FOLLOWING MODELS

Buick Enclave 3.6, engine code: LY7  
 Cadillac SRX, STS, CTS 3.6, engine code: LY7, LLT  
 Chevrolet Camaro 2.8, engine code: LTT, LFX  
 Opel Insignia 2.8 V6 Turbo, engine code: LAU/A28NER  
 Opel Antara 3.2 V6 (from 2007 onwards), engine code: Z32SE  
 Saab 9-5 2.8 (2009-2013), engine code: LAU/A28NER

#### DESCRIPTION

For adjusting and checking the engine timing

#### DELIVERY SCOPE

Camshaft adjustment tools, use as OEM EN-48383-1, EN-48383-2, EN-48383-3  
 Flywheel locking tools, use as OEM EN-46106  
 Crankshaft turning tool, use as OEM EN-46111



FITS FOR:



ART.NR	ITEM NAME	PRICE
<b>BT593870</b>	Engine adjustment tool set for Opel, Saab, Chevrolet 2.0, 2.4	<b>209,00 €</b>

#### FOR THE FOLLOWING MODELS

Opel Astra, Insignia, Antara  
 Chevrolet Captiva, HHR, Malibu  
 Saab 9-5  
 With engines: OPC, OPC/VXR, Turbo, E85, Turbo T-B

#### ENGINE CODES

2.0L > LHU, A20NFT, LTG, A20NHT, LDK, A20NHT  
 2.4L > A24XE, A24XF, LE5, LE9

#### DESCRIPTION

For adjusting the engine timing when replacing the timing chain etc.  
 Suitable for 2.0 L and 2.4 L petrol turbo engines with dual camshafts

#### DELIVERY SCOPE

Crankshaft wheel alignment tool, use as OEM EN-48585  
 Flywheel locking tool, use as OEM EN-43653, J43653  
 Tensioning element locking pin, 2.5 mm, use as OEM EN-955-10, KM 955  
 Tensioning element locking pin, 4.0 mm, use as OEM EN-955-20, KM 955-20  
 Tensioning tappet resetting tool, use as EN-45027-1, J-45027-1  
 Tensioning tappet holder, use as OEM J45027-2, EN45027-2, EN-45027  
 Camshaft interlock (left-hand side), use as OEM EN-49212, EN-49212-1  
 Camshaft interlock (right-hand side), use as OEM EN-49212, EN-49212-2  
 Camshaft adjuster holding tool, use as OEM EN-48953

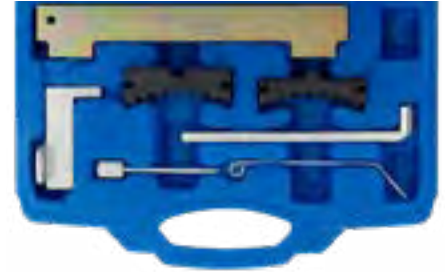

FITS FOR:



ART.NR	ITEM NAME	PRICE
<b>BT591300</b>	Engine adjustment tool set for Opel 1.6, 1.8	<b>33,00 €</b>

#### DESCRIPTION

Contains tools for locking the camshaft and crankshaft  
 Suitable for 1.6 and 1.8 L engines with toothed belt control, installed in models from Opel, Vauxhall, Chevrolet, Fiat, Alfa Romeo (2003-2012), e.g. Astra G, H, Corsa D, Insignia, Meriva, Signum, Vectra C, Zafira B (2003-2011)  
 Suitable for Chevrolet Cruze, Orlando 1.4 1.6 1.8 and Fiat Croma, Alfa Romeo 159 with 939A4.000 engines  
 Use as OEM tools KM-6628-A, 2000012000, KM-6340, 2000012100, KM-6333, KM-6625, 2000012800, KM-6349, KM 6130, KM-911



FITS FOR:



ART.NR	ITEM NAME	PRICE
<b>BT594300</b>	Engine adjustment tool set for Opel, Chevrolet 2.0 CDI	<b>32,00 €</b>

#### DESCRIPTION

For replacing the toothed belt and checking the timing  
 Holds the camshaft and crankshaft in the correct position  
 Suitable for 2.0 L common rail diesel engines with engine code Z20DM, Z20DMH, LLWZ20DMH, RA420, Z20SI, Z20S3, Z20S4, Z20S5

#### DELIVERY SCOPE

Camshaft interlock, use as OEM EN-48245  
 Crankshaft interlock, use as OEM EN-48246





# INNOVATIVE TOOLS FOR SMART SCREWDRIVERS

# CHRYSLER



**FITS FOR:**

ART.NR	ITEM NAME	PRICE
<b>BT593560</b>	Engine adjustment tool set for Mercedes-Benz, Chrysler	<b>71,00 €</b>

### FOR THE FOLLOWING MODELS

Mercedes-Benz 190, C, CLK, E, S, SL, SLK, G, M, Vito, Sprinter, Viano, PT Cruiser, Grand Cherokee

Petrol engines: 1.8, 2.0, 2.2, 2.3, 2.5, 2.8, 3.0, 3.2, 3.3, 4.2, 5.0, 6.0 with engine code 102, 111, 104 (apart from AMG), 119, 120

Diesel engines: 2.0D, 2.2D, 2.3D, 2.5D, 2.5DT, 2.9D, 2.9TD, 3.0D, 3.0DT, 3.5D, 3.5DT, 2.0 CDI, 2.2 CDI, 2.3 CDI, 2.7 CDI, 3.2 CDI, 3.5 CDI, 3.9 CDI, 4.0 CDI, 2.2 CRD, 2.7 CRD • with engine code 601, 604, 605, 611, 646, 612, 602, 603, 606, 612, 613, 646, 647, 648, 628, 603, 613, 628, 648, 646, 602, 603, EDJ

### DESCRIPTION

Contains tools for adjusting the camshaft and blocking the crankshaft (flywheel)

### DELIVERY SCOPE

Flywheel blocking tool, including 2x M6 x 90mm, use as OEM 601589024000, 8933

Flywheel blocking tool, use as OEM 112589034000

Camshaft locking pin set, use as OEM 602589004000, 8929



**FITS FOR:**

ART.NR	ITEM NAME	PRICE
<b>BT593890</b>	Engine adjustment tool set for Chrysler 2.5 CRD	<b>54,00 €</b>

### FOR THE FOLLOWING MODELS

Chrysler Voyager, Grand Voyager R2516C, R2516L, R2816K engines

Jeep Cherokee (year of construction 2001, 2008) 2.5, 2.8 engines

LDV Maxus (year of construction 2005, 2008) VM2516L engines

### DESCRIPTION

For checking and adjusting the engine timing

### DELIVERY SCOPE

Camshaft locking pin (intake), use as OEM VM1052

Camshaft locking pin (exhaust), use as OEM VM1053

Flywheel locking pin (Voyager, Grand Voyager 2.5, 2.8 and LDV Maxus), use as OEM VM1068, VM1089

Flywheel locking pin (Jeep Cherokee 2.8), use as OEM VM1080

Flywheel locking pin (Jeep Cherokee 2.5), use as OEM VM8873

Tensioning spanner, use as OEM VM9660

Balance shaft locking pin

Flywheel locking pin

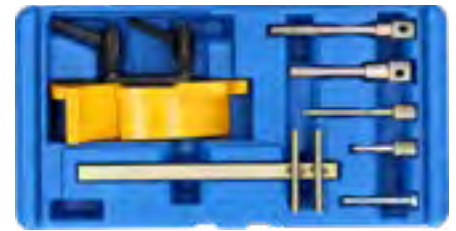

**FITS FOR:**

ART.NR	ITEM NAME	PRICE
<b>BT594570</b>	Engine adjustment tool set for Renault, Opel, Volvo, Mitsubishi, Chrysler	<b>41,00 €</b>

### FOR THE FOLLOWING MODELS

Renault: Clio (1990-2013), Espace, Grand Espace (1996-2002), Extra, Rapid, Express (1991-2002), Kangoo (1998-2009), Laguna (1994-2001), Megane (1995-2003), Scenic (1996-2003), Modus, Grand Modus II (2004-2013), Safrane (1992-2001), Trafic (1997-2000), Master II (2000-2003), Twingo (2000-2013), Wind (2011-2013)

Opel: Arena (1997-2001), Movano-A (1999-2006), Vivaro (2001-2007)

Volvo: S40 (1996-2004), V40 (1996-2004)

Mitsubishi: Carisma (2001-2005), Space Star (2000-2006)

Chrysler: Cherokee (1984-1995), Wrangler (1988-1995)

### ENGINE CODES

E7F 1.2: 700, 704, 706, 708, 750

D4F 1.2 16v: 702, 704, 706, 708, 712, 714, 716, 722, 728, 730, 740, 742, 764, 772, 780, 782, 784, 786

E7J 1.4: 601, 624, 626, 634, 635, 710, 711, 716, 718, 719, 754, 756, 757, 764, 780

F3P 1.8: 674, 676, 678, 710, 712, 714, 720, 724, 755, 758, 8670, Q7, R7, S724

F7P 1.8 16v: 720, 722

F8Q 1.9D/Di/Turbo: 600, 606, 620, 622, 624, 630, 632, 644, 646, 648, 662, 672/676, 678, 680, 682, 684, 692/696, 714, 722, 724, 730, 732, 776, 784, 786, 788, 790, B640

F9Q 1.9D dTi: F9Q1, F9Q2, 710, 716, 717, 720, 722, 730, 731, 734, 736, 744, 760, 762, 770, 774, 780, 782, 790 D4192T, D4191T2 D4192T3, D4192T4

F3R 2.0: 611, 722, 723, 742, 750, 751, 752, 768, 769, 791, 796, 797, 798

J7R 2.0: 732, 733, 734, 735

F7R 2.0 16V: 700, 714, D710

J7T 2.2 16V: 760, 761

G8T 2.2D/Turbo: 706, 714, 716, 740, 752, 760, 790, 792, 794

### DESCRIPTION

For adjusting the engine timing on Renault petrol and diesel engines

### DELIVERY SCOPE

Camshaft locking tool, adjustable for DOHC engines

Injection pump wheel fixing mandrel, use as OEM Mot.910

Tension roller key, use as OEM Mot1135-01

Crankshaft fixing mandrel, use as OEM Mot.1318

Crankshaft fixing mandrel, use as OEM Mot.1054

Crankshaft fixing mandrel, use as OEM Mot.910





ART.NR	ITEM NAME	PRICE
BT591260	Camshaft sprocket locking tool set, universal	72,50 €

**FOR THE FOLLOWING MODELS**

Can be used universally on vehicles from the following manufacturers: Audi, Alfa Romeo, Chrysler, Citroen, Ford, Honda, Hyundai, Isuzu, Land Rover, Lexus, Mazda, Mitsubishi, Peugeot, Renault, MG, Seat, Skoda, Subaru, Toyota, Opel, Volkswagen, Volvo

**DESCRIPTION**

For locking the camshaft sprockets e.g. when replacing the toothed belt

Suitable for engines with 1, 2 and 4 camshafts (V engines); also suitable for locking between the camshaft sprocket and diesel injection pump wheel in some diesel engines

**DELIVERY SCOPE**

Double camshaft locking tool with short and long connecting arm

Single camshaft locking tool with short and long locking screw



**FITS FOR:** **Universal**

ART.NR	ITEM NAME	PRICE
BT596002	Universal camshaft wheel puller	63,00 €

**DESCRIPTION**

For pulling the pulley and camshaft gear

Gripping arms are connected with each other via adjusting disk, thus the gripping arms can be set easily and exactly

Continuous adjustment range of the gripping arms from 42 – 82 mm

Gripping arm depth is 27 mm

**DELIVERY SCOPE**

3 x gripping arms, Ø 12 mm, M10 x 1.5, suitable for material thickness up to max. 10 mm

6-groove puller body with adjusting disc

Spindle, M14 x 1.5, 19 mm hex, with centring cone

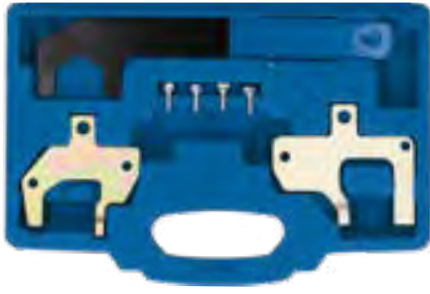

**FITS FOR:** Mercedes-Benz

ART.NR	ITEM NAME	PRICE
BT593660	Engine adjustment tool set for Mercedes-Benz M112 + M113	71,00 €

**FOR THE FOLLOWING MODELS**

Mercedes-Benz C-Klasse 240, 280 (202) (1997-)

Mercedes-Benz C-Klasse 240, 320 (203) (2000-)

Mercedes-Benz CL 500 (215) (1999-2006)

Mercedes-Benz CLK 320, 430 (208) (1997-2003)

Mercedes-Benz CLK 240, 320, 500, 55AMG (209) (2002-2006)

Mercedes-Benz E-Klasse 240, 280, 320, 430 (210) (1997-2002)

Mercedes-Benz E-Klasse 240, 320, 500, E55AMG (211) (2003-2006)

Mercedes-Benz M-Klasse ML320, 350, 430, 500, 55AMG (163) (1997-2005)

Mercedes-Benz M-Klasse 500 (164) (2005-2007)

Mercedes-Benz S-Klasse 280, 320, 350, 430, 500 (220) (1998-2005)

Mercedes-Benz SL 280, 320, 500 (129) (1998-2002)

Mercedes-Benz SL 350, 500, 55AMG (230) (2001-2008)

Mercedes-Benz SLK 320K (170) (2000-2004)

Mercedes-Benz SLK 55AMG (171) (2004-2010)

Mercedes-Benz R-Klasse 500 (2006-2007)

Mercedes-Benz Viano 3.0, 3.2, 3.5 (2003-2008)

Mercedes-Benz Vito 123 (639) (2004-2008)

Chrysler Crossfire (SRT-6) (2003-2007)

**DESCRIPTION**

Needed when working on the timing chain or adjusting the engine timing

Holds the left and right camshafts in the adjustment position

**DELIVERY SCOPE**

Camshaft interlock (right-hand side), use as OEM 112589003200

Camshaft interlock (left-hand side), use as OEM 112589013200

Camshaft spanner, use as OEM 112589000100



**FITS FOR:** Chrysler Jeep

ART.NR	ITEM NAME	PRICE
BT593670	engine adjustment tool set for Chrysler, Jeep, Dodge 2.8l Diesel	54,00 €

**FOR THE FOLLOWING MODELS**

Grand Voyager

Jeep Cherokee

Wrangler

Dodge Nitro

**ENGINE CODES**

Engine codes: VM64C, ENS, ENS (51C), 49C, 50C, ENS VM10D, ENS VM11D

**DESCRIPTION**

For checking and adjusting the engine timing

**DELIVERY SCOPE**

Camshaft locking tool, use as OEM VM9991

Crankshaft locking tool, use as OEM VM9992

**OUR PLANS: BIG.**  
**OUR GROWTH: RAPID**

# CITROËN



FITS FOR:



ART.NR	ITEM NAME	PRICE
<b>BT595700</b>	Camshaft locking tool set for VAG, Ford, Opel, Saab	<b>34,00 €</b>

### DESCRIPTION

Universal set for a wide range of models

### DELIVERY SCOPE

Camshaft interlock for Opel Calibra, Omega, Sintra, Vectra -1.8, 2.0, use as OEM KM-852, 18G1570

Camshaft interlock for Opel Calibra, Omega, Sintra, Vectra -1.4, 1.6, use as OEM KM-853

Right camshaft with Saab 900, 900 -2.5, 3.0, Opel Calibra, Sintra, Vectra -2.5, 3.0, use as OEM KM-800-2

Left camshaft with Saab 900.900 -2.5, 3.0, Opel Calibra, Sintra, Vectra -2.5, 3.0, use as OEM KM-800-1

Crankshaft toothed belt pulley interlock tool for TDI pump-injection engines with VW, Audi, Skoda, Seat and Ford, use as VAG T10050

Flywheel interlock tools for Citroën, Fiat and Peugeot, use as OEM 153A, 6012T, 9765.54

Flywheel holder unit for Isuzu 1.5 and 1.7 diesel, Opel 1.6, 1.7 diesel engines, Opel 1.2, 1.4, 1.6, 1.8, 2.0 OHC petrol engines, use as OEM KM-517-B

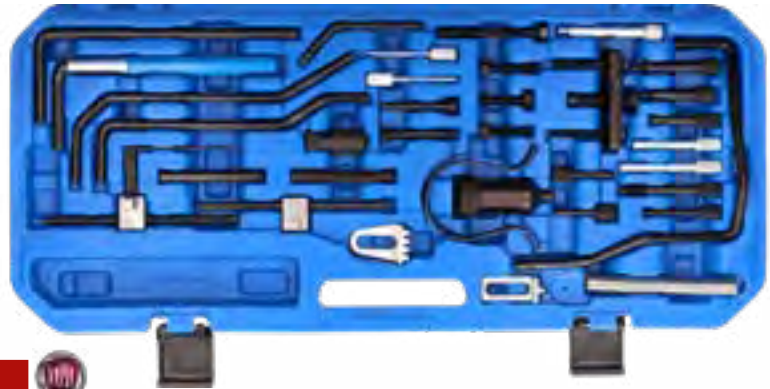

FITS FOR:



ART.NR	ITEM NAME	PRICE
<b>BT592250</b>	Engine adjustment tool set for PSA	<b>99,00 €</b>

### FOR THE FOLLOWING MODELS

Petrol 1.0, 1.1, 1.4, 1.5, 1.6, 1.6 16V, 1.8, 1.8 16V, 1.9, 2.0, 2.0 16V, 2.0 Turbo

Diesel 1.4D, 1.4HDI, 1.5D, 1.7D, 1.7TD, 1.9D, 1.9TD, 2.0Hdi, 2.1TD 2.1TD, 2.2D, 2.5TD, 2.2Hdi

Suitable for structurally identical engines in Toyota and Fiat

### ENGINE CODES

159A, 161A, 171B, 171C, 171D, 180A, 180Z, 3FZ (EW12J4), 4HX (DW12ATED), 4HZ (DW12ATED) 6FZ (EW7J4), A8A, A9A, AJZ, B1A /E /F, B2C, B4A, B6D, B6E, BAY, BDY, BFZ, C1A, CDY, CDZ, D2A /C /E /F, D6A /B /D /E, D8A /B /C, D9B, DDZ, DFZ, DHV /W /X /Y, DJ5 (T9A), DJ5T (T8A), DJY, DJZ, DKZ, EW10J4D, EW7J4, H1A, HDY, HDZ, K1A, K1F, K1G, K2A, K2B, K2D, K3A, K6B, KDX, KDY, KDZ, KFW, KFX, KFY, KFZ, L6A, LFW, LFX, LFY (XU7JP4), LFZ, M4A, NFU, NFX (TU5J4/L3), P8A, P8B, P8C, P9A, PHZ (XUD11), R2A, R6A, R6D, RDZ, RFR, RFN (EW10J4), RFS, RFT, RFU, RFV, RFW, RFX, RFY, RFZ, RGX, RGY, RHW (DW10ATED4), RHY (DW10ATD), RHZ (DW10ATED/L), RLZ(EW10J4D), T8A/THZ (DJ5T), T9A (DJ5), THX (DJ5TED), THY (DK5ATE), TU1/2/3/5/9, TU1/3/5 (HFY, HFZ, KFX, NFZ), TU5J4/L3 (NFX), TU5JP4 (NFU), WJY (DW8B), WJZ (DW8), XU10J2C/Z, XU10J2C/TE/L3, XU10J2TE/Z, XU10J4R/S (RFV/R6E/RFS), XU10J4RS (RFS), XU10J4RS (RFS), XU10-R2A, R5A, R6A, RDZ, XU5-171B, 180A, B1E, XU5-B6D/E, B1A, B1E, B2A, B2B, BDY, BDZ, XU5JP (BFZ), XU7JP4 (LFY), XU7-L6A, LFW, LFX, LFZ, XU9.D2H, D6A, D6B, D6D, DDZ, DKZ, DFZ, XU9-D2A/D, XU9J4, XUD 11 BTE (P8C), XUD11A, XUD11ATE, XUD7 (A9A), XUD7TE, XUD9 (DHY), XUD9A (D9B/DJY), XUD9AU (D8C), XUD9SD (DHW), XUD9TF (D8B), XUD9UTF (DHX), XUD9Y (DJZ)

### DESCRIPTION

For adjusting the engine timing e.g. when replacing the toothed belt

### DELIVERY SCOPE

Clamping tool, use as OEM 4507-TJ, 9767.89, 0188Q1, 0132X1Z, 0188Q1, 0132X1Z, 0132X

Camshaft adjustment pin 6 mm, use as OEM 4507-TA, 0132Z, 0132QZ

2 crankshaft/camshaft adjustment pins, use as OEM 0153ZY, 4507-TB, 0153AB, 9041-TZ, 0132R, 9767.27

Flywheel locking pins, use as OEM 4507-TL, 0189C

Adjustment tool, angled, 8 mm, use as OEM 0188D, 7004TG, 9767-34, 0153G, 7014-TJ, 1 860 863 000, 0153N

### DELIVERY SCOPE

Bolts M8 x 35 mm / M8 x 40 mm / M8 x 70 mm

Flywheel adjustment pin, 7 mm, use as OEM 7017-TR

Flywheel adjustment pin, 8 mm, use as OEM 1 860 863 000, OUT0000127, 0153N, 0288D, 7099-TM, 0188Y, 0188D

Flywheel adjustment pin with spring, use as OEM 0188X, 0189X

Camshaft adjustment pin, use as OEM 18G 1580, 11 9 790, 5711-TD, 21-260, 07744-1110400, 303-732, 4527-T.52, 07744-00104-00, 1 860 617 000, 0132AB, 999 7169, 0178D

Injection pump adjustment pin, use as OEM 0188H

Crankshaft/camshaft adjustment pin, use as OEM 0188M, 0187B, 0194B, 303-1277, MOT1430, 0189B, 303-735, 49JE01 061, 21-263

Injection pump adjustment pin, use as OEM 4527-T.51

Camshaft adjustment pin (CA1), use as OEM 4533-TAC1, 0132AJ1

Camshaft adjustment pin (CA2), use as OEM 0132AJ2, 2000 023 000, 0188M, 4533-TAC2

2 camshaft adjustment pins, use as OEM 9041-TZ, 5711-TC

Camshaft adjustment pin, use as OEM 0189A, 1 871 008 100

Camshaft adjustment pin, use as OEM 0189AZ

Intake camshaft adjustment pin (VTC), use as OEM 0189L

Tension lever, use as OEM 5711-TE, 0178E, 0188J/J1

Flywheel locking tool, use as OEM 0188F, 0134Q, 1 870 765 001, 1 870 827 000, 0134AF, 9044-T, 1 871 000 400

Hdi tension lever, use as OEM 0188J2

Tensioning spanner, 8 mm, use as OEM 7017-TW

Toothed belt retaining clip, use as OEM 0189K, MOT1436, 4533-TAX, 0188K, 0187J, 0132AK, 0153AK, 1 870 00 100

Flywheel locking tool, use as OEM 1 867 030 000, 0153A, 9765.54, 6012T, 1 860 161 000

Roller extractor, use as OEM 0174, 0188P, 018892, 7015-T





ART.NR	ITEM NAME	PRICE
<b>BT592860</b>	Engine adjustment tool set for Ford TDCi, PSA HdI, Mazda D 1.4, 1.6	<b>5,00 €</b>

**FOR THE FOLLOWING MODELS**

Citroen 1.4HDi DV4TD (8HT/8HW/8HX/8HZ), 1.4HDi DV4TED4 (8HV/8HY), 1.6HDi DV6TED4 (9HY/9HZ), 1.6HDi DV6ATED4 (9HW/9HX), 1.6HDi DV6UT-ED4(9HU)  
Mazda 1.4CITD F6JA, F6JB 1.6CITD Y6  
Peugeot 1.4HDi DV4TD (8HT/8HW/8HX/8HZ), 1.4HDi DV4TED4 (8HV/8HY), 1.6HDi DV6TED4 (9HY/9HZ), 1.6HDi DV6ATED4 (9HW/9HX), 1.6HDi DV6UT-ED4(9HU)  
Ford 1.4TDCi F6JA, F6JB, F6JC, F6JD 1.6TDCi G8DA, G8DB, HHDA 1.6TDCi HHDB, HHJA, HHJB, HHJD  
Volvo 1.6D D4164T

**DESCRIPTION**

For adjusting the engine timing when replacing the camshaft, cylinder head seal etc.

**DELIVERY SCOPE**

Flywheel locking bolt, use as OEM PSA 0194-C, Ford 303-734 (21-262), Volvo 999-7169, Mazda 49 JE02 020  
Crankshaft and high-pressure pump wheel locking pin, 2 pcs, use as OEM PSA 0194-A, Ford 303-732 (21-260), Volvo 999-7233, Mazda 49 JE02 018  
Crankshaft and high-pressure pump wheel locking pin, 2 pcs, use as OEM PSA 0194-A, Ford 303-732 (21-260), Volvo 999-7233, Mazda 49 JE02 018

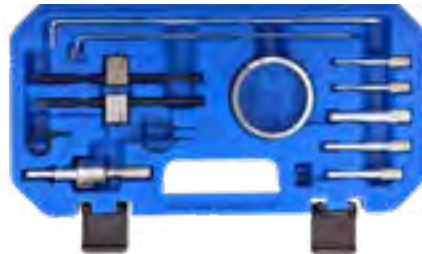

ART.NR	ITEM NAME	PRICE
<b>BT592300</b>	Engine adjustment tool set for PSA 1.8, 2.0 16V petrol	<b>45,00 €</b>

**FOR THE FOLLOWING MODELS**

Citroen C5 1.8, 2.0 HPi (2002, 2005) Xsara 2.0 16V (2002, 2005) Xsara, Picasso 1.8, 2.0 16V (2002, 2005)  
Peugeot 406 1.8 16V (2000, 2004), 807 2.0 16V (2002, 2005)  
Engine codes 6FZ (EW7J4) FRN (EW10J4, L4, 5) RLZ (EW10D)

**DESCRIPTION**

Contains important tools for checking and adjusting the engine timing when replacing the toothed belt and carrying out repairs on the engine

**DELIVERY SCOPE**

Tension roller locking tools, use as OEM 0189S2  
Tool for tensioner, use as OEM 0178E, 5711TE, 178J/J2  
Tools for tensioner, use as OEM 0188J2  
Adjustment tools for tensioning unit, use as OEM 0189S1  
Locking pins, use as OEM 0132AB, 0194A, 0178D  
Locking pin, use as OEM 0194B  
Locking pin, use as OEM 0188M  
Locking pin, use as OEM 0189B  
Flywheel locking tools, use as OEM 0189R  
Interlock for tensioning unit, use as OEM 7017TR, 0153U  
Adjustment tools for crankshaft wheel, use as OEM 0188AH



ART.NR	ITEM NAME	PRICE
<b>BT592520</b>	Engine adjustment tool set for Fiat Ducato, Peugeot Boxer, Citroën Jumper 2.3 D JTD, 3.0 JTD, HDi	<b>50,00 €</b>

**FOR THE FOLLOWING MODELS**

Citroen Relay/Jumper III  
Fiat Ducato  
Iveco Daily (03-10), Daily/EcoDaily (2009-2011)  
Peugeot Boxer III (2006-2012)  
2.3D, 2.3 JTD F1AE0418A, F1AE0481B, F1AE0481C, F1AE0418D, F1AE0481F, F1AE0481FA, F1AE0481G, F1AE0481H, F1AE0481HA, F1AE0481N, F1AE-0481UA.F1AE0481VA  
3.0JTD F1CE0481A, F1CE0481B, F1CE0481D, F1CE0481F, F1CE0481H, F1CE3481M  
3.0HDi F30DTE, F1CE0481D, F1CE3481DM, F1CE3481N

**DESCRIPTION**

Use as OEM Fiat 99360187, 99360614, 99360615, 1860617000, 1860815000, 20000180200, Citroën/Peugeot 0191-2A, 0191-2B, 0191-2J, 0191-2K

**DELIVERY SCOPE**

2 camshaft fixing mandrels  
1 crankshaft fixing mandrel

**OUR CUSTOMERS:  
EVERYONE WHOSE HEART BEATS FOR QUALITY.**



**FITS FOR:**

ART.NR	ITEM NAME	PRICE
<b>BT593750</b>	Engine adjustment tool set for MINI	<b>145,00 €</b>

**FOR THE FOLLOWING MODELS**

Suitable for the following models: MINI One, Cooper, Cooper S, Cooper S JC Cooper S JCW (series R50, 52, 53, 55, 56, 57)

**ENGINE CODES**

For engine codes W10, W11, N14

**DESCRIPTION**

For working on intake and exhaust camshafts

**DELIVERY SCOPE**

Fixing of camshafts, use as OEM 119551 and 119552  
Fixing of crankshaft, use as OEM 119590  
Tools for chain tensioner, use as OEM 119340



**FITS FOR:**

ART.NR	ITEM NAME	PRICE
<b>BT594460</b>	Engine adjustment tool set for PSA 2.5, 2.8 l diesel	<b>12,00 €</b>

**FOR THE FOLLOWING MODELS**

Citroen, Peugeot, Fiat, Iveco Traffic (1980-2000), Master (1980-2007), Mascot (1999-2007)

Fiat, PSA, Renault Daily (1991-2005), Turbo Daily (1994-2000), Relay, Jumper (2001-2002) Boxer (2000-2006), Arena (1997-2001), Movano (1998-2003)

**DESCRIPTION**

Use as OEM Fiat 1 870 667 000, 1 870 765 001, 1 860 617 000, Renault MOT861, MOT1054, MOT863, Opel KM6031, Ford 21-260, 303-732, Peugeot 0132AB, 5711TD, 4527TS2, 0178D, 0194A, 119790, Citroen 0132AB, 5711TD, 4527TS2, 0178D, 0194A, 119790, Mazda 49 JE 02018, 0991246510, Volvo 999-7169

**DELIVERY SCOPE**

2 locking bolts  
Flywheel locking bolt  
Holding tool for toothed belt tensioner



**FITS FOR:**

ART.NR	ITEM NAME	PRICE
<b>BT591580</b>	Engine adjustment tool set for BMW, MINI, PSA	<b>69,00 €</b>

**FOR THE FOLLOWING MODELS**

BMW 1.6 (N40, N45, N45T, B16, B16A, B16AC) 1.8, 2.0 (N42, N46, N46T) 2.0, 3.0 (N51, N52, N52K, N53, N54)

PSA 1.4, 1.6 16V (EP3, EP6, EP6DT, EP6DTS)  
MINI 1.4, 1.6 (N12, N14)

**DESCRIPTION**

For aligning new and old versions of balance shafts  
Prevents non-concentric engine running due to incorrectly aligned balance shafts  
Needed when changing the timing chain, replacing the crankshaft sealing ring, replacing the cylinder head seal etc.  
Use as OEM 115140, 119280, 119330

**DELIVERY SCOPE**

Balance shaft fixing tool (old and new version)  
Crankshaft counter support  
Locking pin for chain tensioner

**BT022992**  
**EAN 4042146844960**  
**1/2" telescopic reversible ratchet**

**22,- €**

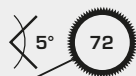



FITS FOR:



FITS FOR:



ART.NR	ITEM NAME	PRICE
<b>BT592320</b>	Balance shaft adjustment tool set for Land Rover, Citroen, Mitsubishi, Peugeot, Ford 2.2 DOHC diesel engines	<b>42,00 €</b>

**FOR THE FOLLOWING MODELS**

Land Rover Discovery, Discovery Sport, Freelander 2, eD4, TD4, TD4e (2009-2015) engine codes: 224DT, DW12CTED4/224DT, DW12BTED4/224DT

Citroen C5, C5 II, C5 III, C6, C8, C-Crosser HDi (200-2015) engine codes: 4HX (DW12CTED4), 4HP (DW12BTED4), 4HX (DW12TED4), 4HW (DW12TED4/L4)

Mitsubishi Outlander Di-D, Di-DC (2007-2013) engine codes: 4HK, 4HN

Peugeot 4007, 407, 607, 807, 406, 508, 607, HDi, GT HDi (2000-2015) engine codes: DW12MTED4 (4HK), DW12MTED4 (4HN), DW12BTED4 (4HP), DW12BTED4 (4HR), DW12BTED4 (4HT), DW12TED4/L4 (4HW), DW12BTED4 (4HS), DW12ATED (4HZ), DW12ATED4 (4HX), DW12ATED (4HZ), DW12CTED4 (4HL)

Ford Galaxy, Mondeo, S-Max, TDCI, TCI (2008-2015) engine codes: KNBB, KNBA, KNWA, G4BA

**DESCRIPTION**

For adjusting the balance shaft

**DELIVERY SCOPE**

Balance shaft fixing tool, use as OEM 303-1329

Balancing tool, use as OEM 303-1330

Balance shaft adjustment tool, use as OEM 303-1328, 0190D

ART.NR	ITEM NAME	PRICE
<b>BT597940</b>	Engine adjustment tool set for Peugeot, Citroën, PSA	<b>89,00 €</b>

**FOR THE FOLLOWING MODELS**

Citroën AX, Berlingo, BX, C5, C15, C25, Dispatch, Evasion, Jumper, Jumpy, Relay, Saxo, Synergie, Visa, Xsara, Xantia, XM, XJR, ZX, etc.

Peugeot 106, 205, 306, 405, 406, 605, 806, J5, Boxer, Expert, Partner, Solara, Talbot Express, Talbot Horizon, etc.

PSA petrol engines 1.9, 1.1, 1.4, 1.6, 1.8, 1.9, 2.0, 1.6, 1.8, 2.0, 2.2 16V (turbo and dual camshafts)

PSA diesel engines 1.4, 1.5, 1.7, 1.8, 1.9, 2.1, 2.5 D, TD, TDI, 1.4, 1.6, 2.0, 2.2 HDI

Suitable for structurally identical engines in Fiat, Ford, Nissan, Renault, Rover, Toyota, etc.

**DESCRIPTION**

For checking and adjusting the engine timing

**DELIVERY SCOPE**

Flywheel adjustment pin with spring, use as OEM 0188X, 0189X

Tensioning spanner, 8 mm, use as OEM 7017-TW

Flywheel fixing mandrel, 7 mm, use as OEM 7017-TR

Angled adjustment pin, 8 mm, use as OEM 0188D, 7004TG, 9767-34, 0153G, 7014-TJ, 1 860 863 000, 0153N

Clamping tool, use as OEM 4507-TJ, 9767.89, 0188Q1, 0132X1Z, 0132X

Camshaft marking mandrel, use as OEM 0189A, 1 871 008 100

Hdi tension roller lever, use as OEM 0188J2

Tension roller lever, use as OEM 5711-TE, 0178E, 0188J/J1

Flywheel disc extractor, use as OEM 0174.0188P, 018892, 7015-T

Toothed belt retaining clamp, use as OEM 0189K, MOT1436, 4533-TAX, 0188K, 0187J, 0132AK, 0153AK, 1 870 00 100

Flywheel retainer, use as OEM 0195K, 4507-TL

Clamping tool, use as OEM 0189S1

Flywheel retainer, use as OEM 1867030000, 0153A, 9765.54, 6012T, 1860161000

Tension lever, use as OEM 0189S2

Angled locking pin, 5 mm

Flywheel fixing mandrel (for automatic transmission), use as OEM 0189R

Camshaft marking mandrel, use as OEM 0189AZ

Crankshaft retainer, use as OEM 0288D, 0188Y, 7014

Flywheel fixing mandrel (manual transmission), use as OEM 0189C

Flywheel interlock, use as OEM 0188F, 0134Q, 1870765001.1870827000, 0134AF, 9044-T, 1871000400

Camshaft marking mandrel (CA1), use as OEM 4533-TAC1, 0132AJ1

Camshaft and crankshaft retainer, use as OEM 0188M, 0187B, 0194B, 303-1277, MOT1430, 0189B, 303-735, 49JE01061, 21-263

Camshaft marking mandrel (CA2), use as OEM 0132AJ2, 2000023000, 0188M, 4533-TAC2

Marking mandrel for injection pump, use as OEM 4527-TS1

Injection pump fixing mandrel, use as OEM 0188H, 1 860 965 000

Flywheel fixing mandrel, use as OEM 49JE02020, 0194C, 21-262, 999-7121, 999-7169, 303-734

2 camshaft and crankshaft marking mandrels, use as OEM 4507-TB.7014-TN, 0132-R, 0153-AB, 0158-G

2 camshaft and crankshaft interlocks, use as OEM KM-955, 7014-TM

2 camshaft marking mandrels, use as OEM 9041-TZ, 5711-TC

2 crankshaft fixing mandrels, use as OEM 5711-TD, 119790, 0194A, 1860617000, 303-732, 07744-00104-00, 49JE02018, 0178D, 9997169, 4527-TS2, 21-260, 999-7169, 0132AB

Camshaft fixing mandrel, use as OEM 0189L

Screw M8 x 80 mm

Pin for clamping device, 3 mm, use as OEM 0153AL, 4200TA

Centring clip for crankshaft pulley, use as OEM 0188AH

Crankshaft marking mandrel, 6 mm, use as OEM 4507-TA, 0132Z, 0132QZ



FITS FOR:

ART.NR	ITEM NAME	PRICE
BT593750	Engine adjustment tool set for MINI	145,00 €

**FOR THE FOLLOWING MODELS**

Suitable for the following models: MINI One, Cooper, Cooper S, Cooper S JCW Cooper S JCW (series R50, 52, 53, 55, 56, 57)

**ENGINE CODES**

For engine codes W10, W11, N14

**DESCRIPTION**

For working on intake and exhaust camshafts

**DELIVERY SCOPE**

Fixing of camshafts, use as OEM 119551 and 119552  
Fixing of crankshaft, use as OEM 119590  
Tools for chain tensioner, use as OEM 119340



FITS FOR:

ART.NR	ITEM NAME	PRICE
BT596002	Universal camshaft wheel puller	63,00 €

**DESCRIPTION**

For pulling the pulley and camshaft gear  
Gripping arms are connected with each other via adjusting disk, thus the gripping arms can be set easily and exactly  
Continuous adjustment range of the gripping arms start from 42 – 82 mm  
Gripping arm depth is 27 mm

**DELIVERY SCOPE**

3 x gripping arms, Ø 12 mm, M10 x 1.5, suitable for material thickness up to max. 10 mm  
6-groove puller body with adjusting disc  
Spindle, M14 x 1.5, 19 mm hex, with centring cone

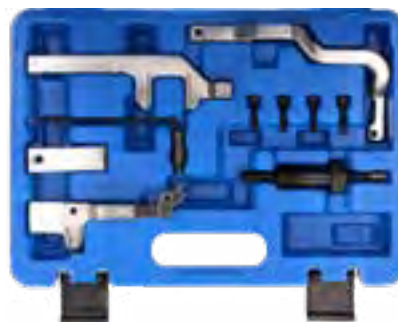

FITS FOR:

ART.NR	ITEM NAME	PRICE
BT593800	Engine adjustment tool set for MINI, PSA	119,00 €

**FOR THE FOLLOWING MODELS**

MINI One, Cooper HB, Cooper (R55-56) N12 engine  
Citroen C4 (year of construction 2008, 2009), C4 Picasso (year of construction 2008, 2009)  
Peugeot 207 (year of construction 2006, 2009), 207CC (year of construction 2007, 2009), 308 (year of construction 2001, 2009)  
Engines: 1.4, 1.6 VTI, EP3 (8FS) EP6 (5FW), EP6C 1.6 THP, EP6DT (5FX) EP6DTS (5FY)

**DESCRIPTION**

Needed when replacing the cylinder head seal and when working on the engine timing

**DELIVERY SCOPE**

Crankshaft fixer, use as OEM 119590, 0197-BZ  
Camshaft fixer, use as OEM 119540, 0197-A1, 0197-A3  
Chain tensioner, use as OEM 119340, 0197-M



FITS FOR:

ART.NR	ITEM NAME	PRICE
BT591260	Camshaft sprocket locking tool set, universal	72,50 €

**FOR THE FOLLOWING MODELS**

Can be used universally on vehicles start from the following manufacturers: Audi, Alfa Romeo, Chrysler, Citroen, Ford, Honda, Hyundai, Isuzu, Land Rover, Lexus, Mazda, Mitsubishi, Peugeot, Renault, MG, Seat, Skoda, Subaru, Toyota, Opel, Volkswagen, Volvo

**DESCRIPTION**

For locking the camshaft sprockets e.g. when replacing the toothed belt  
Suitable for engines with 1, 2 and 4 camshafts (V engines); also suitable for locking between the camshaft sprocket and diesel injection pump wheel in some diesel engines

**DELIVERY SCOPE**

Double camshaft locking tool with short and long connecting arm  
Single camshaft locking tool with short and long locking screw



FITS FOR:

ART.NR	ITEM NAME	PRICE
BT597990	Engine adjustment tool set for Peugeot, Citroën 1.0, 1.2 Vti	105,00 €

**FOR THE FOLLOWING MODELS**

Peugeot 208, 2008 (2012 to 2014)  
Citroen C3 (III)

**ENGINE CODES**

EBO (ZMZ), EB2 (HMZ)

**DESCRIPTION**

For checking and adjusting the engine timing  
Needed e.g. when working on the valve train and replacing the cylinder head seal

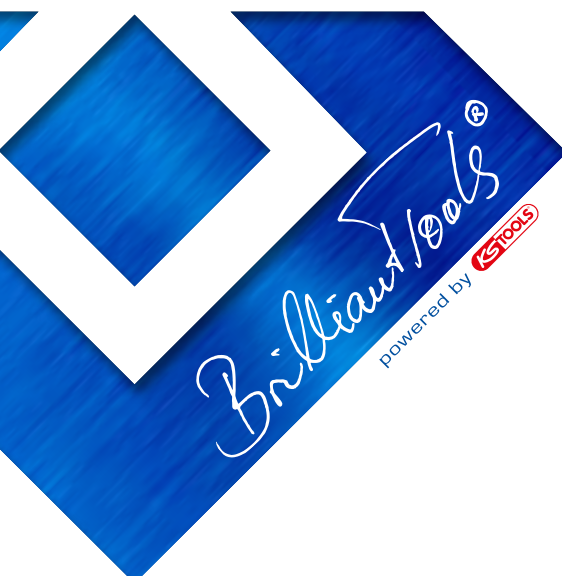



FITS FOR:



FITS FOR:



ART.NR	ITEM NAME	PRICE
<b>BT593160</b>	Engine adjustment tool set for Jaguar, Land Rover, Ford, Citroën 2.0, 2.2, 2.4, 3.2 diesel	<b>105,00 €</b>

#### FOR THE FOLLOWING MODELS

Ford Mondeo (2000 - 2007), Transit (2000 - 2011)  
 Citroën Relay (2006 - 2011), Jumper III  
 Fiat Ducato (2006 - 2011)  
 Jaguar X-Type (2001 - 2010)  
 Land Rover Defender (2007 - 2011)  
 LDV Convoy (2002 - 2006)  
 with DURATORQ (PUMA) diesel engines

#### ENGINE CODES

2.0L engine code ABFA, D3FA, D5BA, D6BA, F3FA, F1FA, FMBA, HJBA, HJBB, HJBC, HJBE, N7BA, N7BB  
 2.2L (with chain-driven high-pressure pump), engine code QJBA (BG), QJBB, QJBC, QJBD  
 2.2L (high-pressure pump driven via camshaft), engine code 4HM, 4HU, 4HV, P8FA, P22DTE, QVFA, QWFA  
 2.4L with engine code 244DT, DOFA, D2FA, D2FB, D4FA, F4FA, FXFA, H9FA, H9FB, HE FA, HFFA, JXFA, PHFA, ZSD 424  
 3.2L with engine code SAFA (timing only)

#### DESCRIPTION

For checking and adjusting the engine timing  
 Needed e.g. when working on the valve train and replacing the cylinder head seal

#### DELIVERY SCOPE

Engine cover adjustment tool, use as OEM 303-682  
 Tool for engine cover/crankshaft radial sealing ring, use as OEM 303-679A  
 High-pressure pump wheel holding tool, use as OEM 303-1151  
 High-pressure pump wheel disassembly tool, use as OEM 303-249  
 Flywheel locking bolt, use as OEM 303-675  
 Flywheel locking bolt, use as OEM 303-698  
 Locking pin set, 3 pcs, 6 mm  
 Tensioner locking pin, 2 mm

ART.NR	ITEM NAME	PRICE
<b>BT593180</b>	Engine adjustment tool set for Jaguar, Land Rover 2.7, 3.0 TD V6	<b>67,00 €</b>

#### FOR THE FOLLOWING MODELS

Citroën C5 III (2007 - 2009), C6 (2005 - 2009)  
 Jaguar S-Type (2004 - 2008), XF (2008 - 2012), XJ (2010 - 2012), XJ6 (2005 - 2010)  
 Range Rover Sport (2005 - 2009)  
 Peugeot 407 (2004 - 2009), 407 Coupe (2006 - 2009), 607 (2004 - 2011) 2.7TD V6, TDVi (276DT) 2.7D HDi (DT17BTED4) (JHZ) 3.0D HDi (D20CTED4) (X8Z) 3.0D SD V6, TD V6 (306DT) (AJ-V6D)

#### DESCRIPTION

For checking and adjusting the engine timing  
 Needed e.g. when working on the valve train and replacing the cylinder head seal

#### DELIVERY SCOPE

Flywheel interlock (manual), use as OEM (Rover) 303-1116  
 Flywheel interlock (automatic), use as OEM (Rover) 303-1117  
 Camshaft sprocket adjustment pin, use as OEM (Rover) 303-1132  
 Camshaft sprocket adjustment pin, 2 pcs, use as OEM (Rover) 303-1126, (PSA) 0195H  
 Water pump locking pin, use as OEM (PSA) 0195-C  
 Flywheel locking tool, use as OEM (PSA) 0195-K  
 Toothed belt retaining clip, use as OEM (PSA) 0188-K



# FIAT

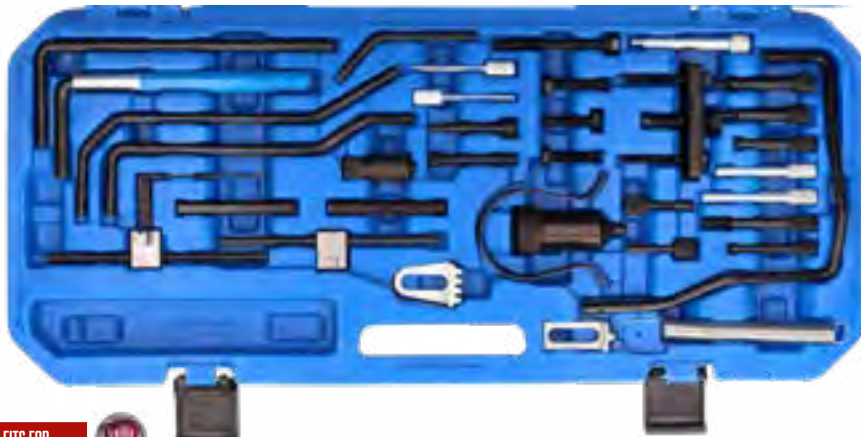

FITS FOR:



ART.NR	ITEM NAME	PRICE
<b>BT592250</b>	Engine adjustment tool set for PSA	<b>99,00 €</b>

### FOR THE FOLLOWING MODELS

Petrol 1.0, 1.1, 1.4, 1.5, 1.6, 1.6 16V, 1.8, 1.8 16V, 1.9, 2.0, 2.0 16V, 2.0 Turbo

Diesel 1.4D, 1.4HDI, 1.5D, 1.7D, 1.7TD, 1.9D, 1.9TD, 2.0Hdi, 2.1TD 2.1TD, 2.2D, 2.5TD, 2.2Hdi

Suitable for structurally identical engines in Toyota and Fiat

### ENGINE CODES

159A, 161A, 171B, 171C, 171D, 180A, 180Z, 3FZ (EW12J4), 4HX (DW12ATED), 4HZ (DW12ATED) 6FZ (EW7J4), A8A, A9A, AJZ, B1A /E /F, B2C, B4A, B6D, B6E, BAY, BDY, BFZ, C1A, CDY, CDZ, D2A /C /E /F, D6A /B /D /E, D8A /B /C, D9B, DDZ, DFZ, DHV /W /X /Y, DJ5 (T9A), DJ5T (T8A), DJY, DJZ, DKZ, EW10J4D, EW7J4, H1A, HDY, HDZ, K1A, K1F, K1G, K2A, K2B, K2D, K3A, K6B, KDX, KDY, KDZ, KFW, KFX, KFY, KFZ, L6A, LFW, LFX, LFY (XU7JP4), LFZ, M4A, NFU, NFX (TU5J4/L3), P8A, P8B, P8C, P9A, PHZ (XUD11), R2A, R6A, R6D, RDZ, RFR, RFN (EW10J4), RFS, RFT, RFU, RFV, RFW, RFX, RFY, RFZ, RGX, RGY, RHW (DW10ATED4), RHY (DW10ATD), RHZ (DW10ATED/L), RLZ(EW10J4D), T8A/THZ (DJ5T), T9A (DJ5), THX (DJ5TED), THY (DK5ATE), TU1/2/3/5/9, TU1/3/5 (HFY, HFZ, KFX, NFZ), TU5J4/L3 (NFX), TU5JP4 (NFU), WJY (DW8B), WJZ (DW8), XU10J2C/Z, XU10J2CTE/L3, XU10J2TE/Z, XU10J4R/S (RFV/R6E/RFS), XU10J4RS (RFS), XU10J4RS (RFS), XU10-R2A, R5A, R6A, RDZ, XU5-171B, 180A, B1E, XU5-B6D/E, B1A, B1E, B2A, B2B, BDY, BDZ, XU5JP (BFZ), XU7JP4 (LFY), XU7-L6A, LFW, LFX, LFZ, XU9.D2H, D6A, D6B, D6D, DDZ, DKZ, DFZ, XU9-D2A/D, XU9J4, XUD 11 BTE (P8C), XUD11A, XUD11ATE, XUD7 (A9A), XUD7TE, XUD9 (DHY), XUD9A (D9B/DJY), XUD9AU (D8C), XUD9SD (DHW), XUD9TF (D8B), XUD9UTF (DHX), XUD9Y (DJZ)

### DESCRIPTION

For adjusting the engine timing e.g. when replacing the toothed belt

### DELIVERY SCOPE

Clamping tool, use as OEM 4507-TJ, 9767.89, 0188Q1, 0132X1Z, 0188Q1, 0132X1Z, 0132X

Camshaft adjustment pin 6 mm, use as OEM 4507-TA, 0132Z, 0132QZ

2 crankshaft/camshaft adjustment pins, use as OEM 0153ZY, 4507-TB, 0153AB, 9041-TZ, 0132R, 9767.27

Flywheel locking pins, use as OEM 4507-TL, 0189C

Adjustment tool, angled, 8 mm, use as OEM 0188D, 7004TG, 9767-34, 0153G, 7014-TJ, 1 860 863 000, 0153N

Bolts M8 x 35 mm / M8 x 40 mm / M8 x 70 mm

Flywheel adjustment pin, 7 mm, use as OEM 7017-TR

Flywheel adjustment pin, 8 mm, use as OEM 1 860 863 000, OUT0000127, 0153N, 0288D, 7099-TM, 0188Y, 0188D

Flywheel adjustment pin with spring, use as OEM 0188X, 0189X

Camshaft adjustment pin, use as OEM 18G 1580, 11 9 790, 5711-TD, 21-260, 07744-1110400, 303-732, 4527-T.S2, 07744-00104-00, 1 860 617 000, 0132AB, 999 7169, 0178D

Injection pump adjustment pin, use as OEM 0188H

Crankshaft/camshaft adjustment pin, use as OEM 0188M, 0187B, 0194B, 303-1277, MOT1430, 0189B, 303-735, 49JED1 061, 21-263

Injection pump adjustment pin, use as OEM 4527-T.S1

Camshaft adjustment pin (CA1), use as OEM 4533-TAC1, 0132AJ1

Camshaft adjustment pin (CA2), use as OEM 0132AJ2, 2000 023 000, 0188M, 4533-TAC2

2 camshaft adjustment pins, use as OEM 9041-TZ, 5711-TC

Camshaft adjustment pin, use as OEM 0189A, 1 871 008 100

Camshaft adjustment pin, use as OEM 0189AZ

Intake camshaft adjustment pin (VTC), use as OEM 0189L

Tension lever, use as OEM 5711-TE, 0178E, 0188J/J1

Flywheel locking tool, use as OEM 0188F, 0134G, 1 870 765 001, 1 870 827 000, 0134AF, 9044-T, 1 871 000 400

Hdi tension lever, use as OEM 0188J2

Tensioning spanner, 8 mm, use as OEM 7017-TW

Toothed belt retaining clip, use as OEM 0189K, MOT1436, 4533-TAX, 0188K, 0187J, 0132AK, 0153AK, 1 870 00 100

Flywheel locking tool, use as OEM 1 867 030 000, 0153A, 9765.54, 6012T, 1 860 161 000

Roller extractor, use as OEM 0174, 0188P, 018892, 7015-T



FITS FOR:



ART.NR	ITEM NAME	PRICE
<b>BT592700</b>	Engine adjustment tool set for Alfa Romeo, Fiat 1.4 MultiAir	<b>69,00 €</b>

### FOR THE FOLLOWING MODELS

Alfa Romeo Giulietta, Mito, Fiat Punto, Punto Evo 1.4 (Turbo) MultiAir (105/135/163/170PS)

Engine codes: 940A2.000, 940A2.000, 955A8.000, 955A8.000, 940A2.000, 955A8.000, 955A2.000, 955A7.000, 955A6.000, 955A8.000

### DESCRIPTION

For adjusting the engine timing when replacing the toothed belt

### DELIVERY SCOPE

Camshaft adjustment tool including 3 fastening screws, use as OEM 2000034400

Crankshaft locking tool including 4 fastening screws, use as OEM 2000004500

Tension roller key, use as OEM 1860987000



FITS FOR:

ART.NR	ITEM NAME	PRICE
<b>BT592520</b>	Engine adjustment tool set for Fiat Ducato, Peugeot Boxer, Citroën Jumper 2.3 D JTD, 3.0 JTD, HDi	<b>50,00 €</b>

**FOR THE FOLLOWING MODELS**

- Citroen Relay/Jumper III
- Fiat Ducato
- Iveco Daily (03-10), Daily/EcoDaily (2009-2011)
- Peugeot Boxer III (2006-2012)
- 2.3D, 2.3 JTD F1AE0418A, F1AE0481B, F1AE0481C, F1AE0418D, F1AE0481F, F1AE0481FA, F1AE0481G, F1AE0481H, F1AE0481HA, F1AE0481N, F1AE0481UA, F1AE0481VA
- 3.0JTD F1CE0481A, F1CE0481B, F1CE0481D, F1CE0481F, F1CE0481H, F1CE3481M
- 3.OHD: F30DTE, F1CE0481D, F1CE3481DM, F1CE3481N

**DESCRIPTION**

Use as OEM Fiat 99360187, 99360614, 99360615, 1860617000, 1860815000, 20000180200, Citroën/Peugeot 0191-2A, 0191-2B, 0191-2J, 0191-2K

**DELIVERY SCOPE**

- 2 camshaft fixing mandrels
- 1 crankshaft fixing mandrel



FITS FOR:

ART.NR	ITEM NAME	PRICE
<b>BT594460</b>	Engine adjustment tool set for PSA 2.5, 2.8 l diesel	<b>12,00 €</b>

**FOR THE FOLLOWING MODELS**

- Citroen, Peugeot, Fiat, Iveco Traffic (1980-2000), Master (1980-2007), Mascot (1999-2007)
- Fiat, PSA, Renault Daily (1991-2005), Turbo Daily (1994-2000), Relay, Jumper (2001-2002) Boxer (2000-2006), Arena (1997-2001), Movano (1998-2003)

**DESCRIPTION**

Use as OEM Fiat 1 870 667 000, 1 870 765 001, 1 860 617 000, Renault MOT861, MOT1054, MOT863, Opel KM6031, Ford 21-260, 303-732, Peugeot 0132AB, 5711TD, 4527TS2, 0178D, 0194A, 119790, Citroen 0132AB, 5711TD, 4527TS2, 0178D, 0194A, 119790, Mazda 49 JE 02018, 0991246510, Volvo 999-7169

**DELIVERY SCOPE**

- 2 locking bolts
- Flywheel locking bolt
- Holding tool for toothed belt tensioner



FITS FOR:

ART.NR	ITEM NAME	PRICE
<b>BT591310</b>	Engine adjustment tool set for Alfa Romeo, Lancia, Fiat 0.9	<b>33,00 €</b>

**FOR THE FOLLOWING MODELS**

- Alfa Romeo Mito start from 2012 onwards
- Fiat 500 start from 2010 onwards
- Fiat Panda start from 2012 onwards
- Fiat Punto start from 2012 onwards
- Lancia Ypsilon start from 2012 onwards

**DESCRIPTION**

For adjusting the engine timing, e.g. when replacing the timing chain, repairing the cylinder head, etc.

**DELIVERY SCOPE**

- Crankshaft locking mandrel, use as OEM 2000035300
- Pulley locking mandrel, use as OEM 2000035200
- Camshaft interlock plate, use as OEM 2000035100

**12 pcs.**

Volkswagen | Audi | BMW | Mercedes  
Opel | Renault | Seat | Škoda

**BT511150**  
**EAN 4042146778753**  
**Air bag removal tool set,**  
**12 pcs**

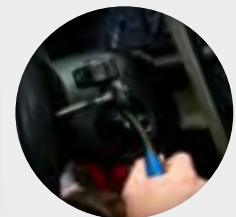
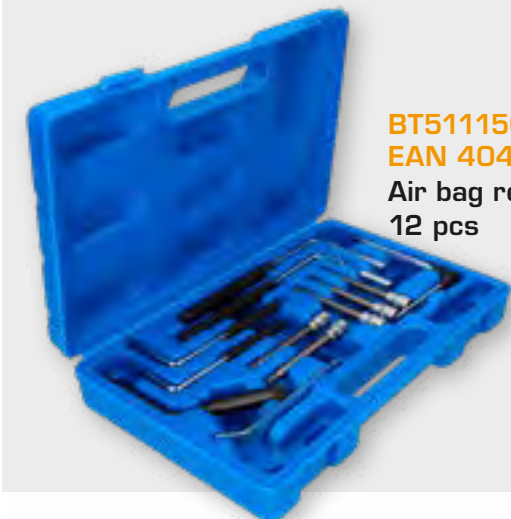

**22,- €**

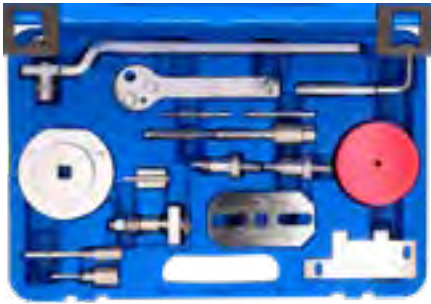

FITS FOR:



ART.NR	ITEM NAME	PRICE
<b>BT592750</b>	Engine adjustment tool set for Fiat, PSA	<b>169,00 €</b>

**DESCRIPTION**

For checking and adjusting the engine timing  
Suitable for Fiat engines: 2.2 JTD 4HV - 2.3 JTD F1AE0481D 120PS - 2.3 JTD F1AE0481D 127PS - 3.0 JTD  
Suitable for PSA engines: Puma 22DT 4HV 100PS - Puma 22DT 4HV 120PS - F30DT

**DELIVERY SCOPE**

Crankshaft sealing ring installation and dismantling tool, use as OEM 2000016900, 303-679 / 303-679A, 0198D  
Crankshaft fixing tools, use as OEM 2000018700, 303-1587  
Holding/lathe tools for crankshaft, use as OEM 2000018400 / 2000010000, 303-1177  
Flywheel docking tool, use as OEM 2000019200  
Centring of control housing, use as OEM 2000017000, 303-682, 0198G  
Crankshaft fixing mandrel, use as OEM 2000017100, 303-698 / 21-251, 0198A  
Camshaft wheel fixing mandrel, use as OEM 2000016500, 0198.B2  
Holding and lathe tools for crankshaft, use as OEM 1860815000, 0191-2K  
Oil pump gauge, use as OEM 2000016700, 303-705 / 303-1093, 0198H  
Tools for water sensor, use as OEM 2000017300  
Flywheel docking tool, use as OEM 1860846000  
Crankshaft fixing mandrel, use as OEM 99360615, 2000018200, 0191-2A  
Camshaft fixing tools, use as OEM 99360614, 0191-2B  
Camshaft fixing tools, use as OEM 1860617000, 2000018200



FITS FOR:



ART.NR	ITEM NAME	PRICE
<b>BT594450</b>	Engine adjustment tool set for Fiat, Opel, Alfa 1.9, 2.4 16V Diesel	<b>40,00 €</b>

**FOR THE FOLLOWING MODELS**

Opel 1.9 CDTi Z19DT, Z19DTH, Z19DTH  
Alfa-Romeo 1.9 and 2.4 L diesel with engine code: 323.02, 371.01, 342.02, 325.01, 362.02, 182B9.000, 937A2.000, 937A3.000, 192A5.000, 192B1.000, 937A4.000, 937A5.000, 939A2.000, 939A1.000, 939A7.000, 939A8.000, 839A6.000, 841C.000  
Fiat 1.9 and 2.4 L diesel with engine code: 182B4.000, 182B9.000, 185A6.000, 186A6.000, 186A8.000, 186A9.000, 188A2.000, 188A7.000, 188B2.000, 192A1.000, 192A3.000, 192A5.000, 192A8.000, 192A9.000, 192B4.000, 192B5.000, 198A2.000, 198A3.000, 198A6.000, 199A5.000, 223A7.000, 937A5.000, 939A1.000, 939A2.000, 939A3.000, 939A7.000

**DESCRIPTION**

For adjusting the engine timing e.g. when replacing the toothed belt, repairing the cylinder head, etc.

**DELIVERY SCOPE**

Crankshaft interlock, use as OEM Opel EN-46788, Fiat 1.860.905.000, 1.860.905.010  
Flywheel interlock, use as OEM Fiat 1.860.898.000  
Camshaft interlock, use as OEM Opel EN-46789, Fiat 1.870.896.900  
Marking mandrel Ø 3.7mm x 70mm, use as OEM Opel KM 6130, KM 6349

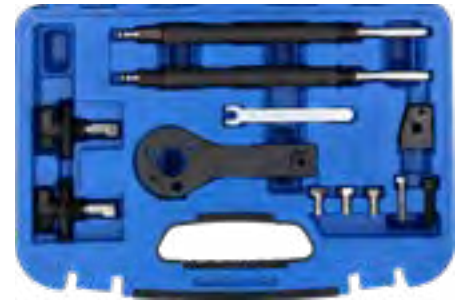

FITS FOR:



ART.NR	ITEM NAME	PRICE
<b>BT591320</b>	Engine adjustment tool set for Fiat, Alfa Romeo, Lancia 1.2 16V, 1.4 16V, T-Jet	<b>35,00 €</b>

**FOR THE FOLLOWING MODELS**

Adjustment tool for piston height, use as OEM 1.860.992.000

**DESCRIPTION**

For adjusting engine timing when replacing the toothed belt, repairing the cylinder head, replacing the cylinder head seal, etc.

Suitable for Alfa Romeo, Fiat and Lancia 1.2 16V, 1.4 16v, 1.4 T-Jet

Engine codes e.g. 169A3000, 179B9000, 182B2000, 188A5000, 192B2000, 198A1000, 198A4000, 199A6000, 199A8000, 843A1000

**DELIVERY SCOPE**

Crankshaft interlock (with screws M6x30 and 3 pcs M8x16), use as OEM 2.000.004.500  
Camshaft adjustment tools (1 pair), use as OEM 1.860.985.000  
Adjustment tool for piston height, use as OEM 1.860.992.000  
Adjustment spanner for toothed belt tensioner, use as OEM 1.860.987.000  
Interlock tool for camshaft sprockets (with M8x30 screw), use as OEM 2.000.015.800

**BT511045**  
**EAN 4042146778715**  
**Panel/trim removal tool set,**  
**6 pcs**

**6**  
pcs.

**4 + 8 + 10 mm**

**25,- €**





FITS FOR:



ART.NR	ITEM NAME	PRICE
<b>BT592530</b>	Engine adjustment tool set for Fiat, Peugeot, Citroen 1.8, 2.0 8V petrol	<b>10,00 €</b>

**DESCRIPTION**

For checking and adjusting the engine timing  
Suitable for engine codes LFW, RFU, RGX, RFW  
Use as OEM 0132Q, 0132QZ, 0132Z, 0132R, 1053AA, 1053AB, 1053ZY, 0153G, 4507TA, 4507TB, 5711TA, 7014TN, 9767.27, 7014TM, 0132X, 0132X1Z, 4507T, 4507TJ, 1860755000, 1860161000, KM955

**DELIVERY SCOPE**

Crankshaft interlock, 6 mm  
Camshaft interlock, 10 mm  
Camshaft locking pins, 2x  
Tool for toothed belt tensioner



FITS FOR:



ART.NR	ITEM NAME	PRICE
<b>BT592540</b>	Engine adjustment tool set for Fiat, Ford, Opel, Suzuki 1.3 diesel	<b>45,00 €</b>

**FOR THE FOLLOWING MODELS**

Fiat Punto 1.3 JTD Multi-Jet 188A9.000, 2003 – 2007, Panda 1.3 JTD Multi-Jet 169A1.000, 188A8.000, 2003 – 2009, Idea 1.3 JTD Multi-Jet 199A3.000, 188A9.000, 2004 – 2006, Doblo 1.3 JTD Multi-Jet 188A9.000, 2004 – 2006, Doblo Cargo 1.3 JTD 188A9.000, 2004 – 2006  
Opel/Vauxhall Agila 1.3 CDTi Z13DT, 2003 – 2008, Corsa-C 1.3 CDTi Z13DT, 2003 – 2007, Combo-C 1.3 CDTi Z13DT, 2003 – 2009, Corsa-D 1.3 CDTi Z13DTH, Z13DTJ, 2006 – 2009, Astra-H 1.3 CDTi Z13DTH, 2004 – 2009, Tigra-B 1.3 CDTi Z13DT, 2004 – 2009, Meriva 1.3 CDTi Z13DT, Z13DTJ, 2004 – 2009  
Suzuki: Ingis 1.3 CDTi Z13DT, 2003 – 2009, Wagon R 1.3 CDTi Z13DT, 2003 – 2009, Swift 1.3 CDTi Z13DT, 2003 - 2010  
Ford Ka 1.3 TDCi

**DESCRIPTION**

For checking and adjusting the engine timing

**DELIVERY SCOPE**

Counter-support spanner for crankshaft pulley, use as Fiat OEM 1871000200 - Ford OEM 303-1469 - Opel/Vauxhall OEM KM-662-C  
Crankshaft adjustment tool, use as Opel/Vauxhall OEM EN 46785, OEM KM 955 - Suzuki 09912-38300  
Camshaft adjustment tool, use as Fiat OEM 1871000900, 1860985000 - Ford OEM 303-1472 - Opel/Vauxhall OEM EN 46781 - Suzuki OEM 09917-68610  
Chain tension lever, use as Fiat OEM 1870900400  
Crankshaft interlock tool, use as Fiat OEM 1870900300 - Ford OEM 303-1468  
Crankshaft adjustment tool, Fiat 8 mm

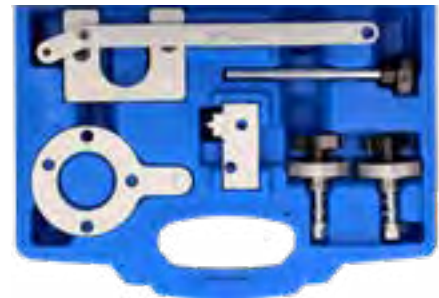

FITS FOR:



ART.NR	ITEM NAME	PRICE
<b>BT592650</b>	Engine adjustment tool set for Fiat 1.3 Multijet	<b>45,00 €</b>

**FOR THE FOLLOWING MODELS**

Fiat 500, Albea (TR), Doblo (Cargo), Fiorino, Grande Punto, Idea, Linea, Panda, Punto Evo  
Lancia Musa, Ypsilon  
Suzuki Splash, Swift, Wagon R+ Ignis  
Opel Agila, Agila B, Astra-H, Astra-J, Combo-C, Corsa-C, Corsa-D, Meriva-A, Meriva-B, Tigra-B

**ENGINE CODES**

169A1.000, 188A8.000, 188A9.000, 199A2.000, 199A3.000, 199A9.000, 199B1.000, 199B2.000, 223A9.000  
D13A, Z13DT, Z13DTJ, A13DTC, A13DTE, A13DTR, D13A, LDV/ A13DTC, LSF/A13DTE, Y13DT, Y13DTH, Z13DT, Z13DTi, Z13DTH, Z13DTJ, Z13DTR

**DESCRIPTION**

For checking and adjusting the engine timing



FITS FOR:



ART.NR	ITEM NAME	PRICE
<b>BT592560</b>	Engine adjustment tool set Fiat 1.7, 1.9 Diesel	<b>119,00 €</b>

**FOR THE FOLLOWING MODELS**

Suitable for Fiat models 1.7D / TD, Tipo 1.9D, Ducato 1.9D / TD, Tempra 1.9TD with adjustable camshaft sprocket

**ENGINE CODES**

176B3.000, 176A3.000, 176A5.000, 149B1.000, 160A6.000, 160A7.000, 160D1.000, 230A2.000, 230A3.000, 230A4.000, 280 A1.000

**DESCRIPTION**

For checking and adjusting the engine timing

**DELIVERY SCOPE**

Camshaft retainer, use as OEM 1860932000  
Camshaft retainer, use as OEM 1860934000  
Camshaft retainer, use as OEM 1860931000  
Crankshaft retainer, use as OEM 1860933000



FITS FOR:



ART.NR	ITEM NAME	PRICE
<b>BT591300</b>	Engine adjustment tool set for Opel 1.6, 1.8	<b>33,00 €</b>

**DESCRIPTION**

Contains tools for locking the camshaft and crankshaft  
Suitable for 1.6 and 1.8 L engines with toothed belt control, installed in models start from Opel, Vauxhall, Chevrolet, Fiat, Alfa Romeo (2003-2012), e.g. Astra G, H, Corsa D, Insignia, Meriva, Signum, Vectra C, Zafira B (2003-2011)  
Suitable for Chevrolet Cruze, Orlando 1.4 1.6 1.8 and Fiat Croma, Alfa Romeo 159 with 939A4.000 engines  
Use as OEM tools KM-6628-A, 2000012000, KM-6340, 2000012100, KM-6333, KM-6625, 2000012800, KM-6349, KM 6130, KM-911

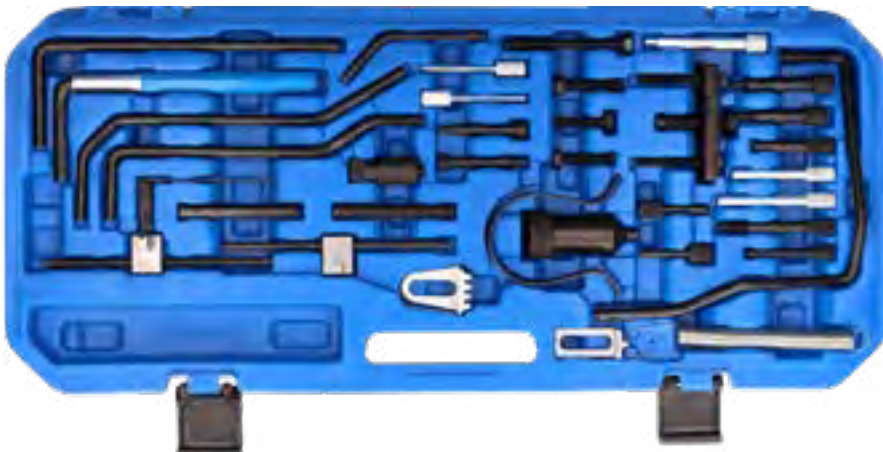

FITS FOR:



ART.NR	ITEM NAME	PRICE
<b>BT592250</b>	Engine adjustment tool set for PSA	<b>99,00 €</b>

**FOR THE FOLLOWING MODELS**

Petrol 1.0, 1.1, 1.4, 1.5, 1.6, 1.6 16V, 1.8, 1.8 16V, 1.9, 2.0, 2.0 16V, 2.0 Turbo  
 Diesel 1.4D, 1.4HDI, 1.5D, 1.7D, 1.7TD, 1.9D, 1.9TD, 2.0Hdi, 2.1TD 2.1TD, 2.2D, 2.5TD, 2.2Hdi  
 Suitable for structurally identical engines in Toyota and Fiat

**ENGINE CODES**

159A, 161A, 171B, 171C, 171D, 180A, 180Z, 3FZ (EW12J4), 4HX (DW12ATED), 4HZ (DW12ATED) 6FZ (EW7J4), A8A, A9A, AJZ, B1A /E /F, B2C, B4A, B6D, B6E, BAY, BDY, BFZ, C1A, CDY, CDZ, D2A /C /E /F, D6A /B /D /E, D8A /B /C, D9B, DDZ, DFZ, DHV /W /X /Y, DJ5 (T9A), DJ5T (T8A), DJY, DJZ, DKZ, EW10J4D, EW7J4, H1A, HDY, HDZ, K1A, K1F, K1G, K2A, K2B, K2D, K3A, K6B, KDX, KDY, KDZ, KFW, KFX, KFY, KFZ, L6A, LFW, LFX, LFY (XU7JP4), LFZ, M4A, NFU, NFX (TU5J4L3), P8A, P8B, P8C, P9A, PHZ (XUD11), R2A, R6A, R6D, RDZ, RFR, RFN (EW10J4), RFS, RFT, RFU, RFV, RFW, RFX, RFY, RFZ, RGX, RGY, RHW (DW10ATED4), RHY (DW10ATD), RHZ (DW10ATED/L), RLZ(EW10J4D), T8A/THZ (DJ5T), T9A (DJ5), THX (DJ5TED), THY (DK5ATE), TU1/2/3/5/9, TU1/3/5 (HFY, HFZ, KFX, NFZ), TU5J4/L3 (NFX), TU5JP4 (NFU), WJY (DW8B), WJZ (DW8), XU10J2C/Z, XU10J2CTE/L3, XU10J2TE/Z, XU10J4R/S (RFV/R6E/RFS), XU10J4RS (RFS), XU10J4RS (RFS), XU10-R2A, R5A, R6A, RDZ, XU5-171B, 180A, B1E, XU5-B6D/E, B1A, B1E, B2A, B2B, BDY, BDZ, XU5JP (BFZ), XU7JP4 (LFY), XU7-L6A, LFW, LFX, LFZ, XU9.D2H, D6A, D6B, D6D, DDZ, DKZ, DFZ, XU9-D2A/D, XU9J4, XUD 11 BTE (P8C), XUD11A, XUD11ATE, XUD7 (A9A), XUD7TE, XUD9 (DHY), XUD9A (D9B/DJY), XUD9AU (D8C), XUD9SD (DHW), XUD9TF (D8B), XUD9UTF (DHX), XUD9Y (DJZ)

**DESCRIPTION**

For adjusting the engine timing e.g. when replacing the toothed belt

**DELIVERY SCOPE**

Clamping tool, use as OEM 4507-TJ, 9767.89, 0188G1, 0132X1Z, 0188G1, 0132X1Z, 0132X  
 Camshaft adjustment pin 6 mm, use as OEM 4507-TA, 0132Z, 0132QZ  
 2 crankshaft/camshaft adjustment pins, use as OEM 0153ZY, 4507-TB, 0153AB, 9041-TZ, 0132R, 9767.27  
 Flywheel locking pins, use as OEM 4507-TL, 0189C  
 Adjustment tool, angled, 8 mm, use as OEM 0188D, 7004TG, 9767-34, 0153G, 7014-TJ, 1 860 863 000, 0153N

Bolts M8 x 35 mm / M8 x 40 mm / M8 x 70 mm  
 Flywheel adjustment pin, 7 mm, use as OEM 7017-TR  
 Flywheel adjustment pin, 8 mm, use as OEM 1 860 863 000, OUT0000127, 0153N, 0288D, 7099-TM, 0188Y, 0188D  
 Flywheel adjustment pin with spring, use as OEM 0188X, 0189X  
 Camshaft adjustment pin, use as OEM 18G 1580, 11 9 790, 5711-TD, 21-260, 07744-1110400, 303-732, 4527-T.S2, 07744-00104-00, 1 860 617 000, 0132AB, 999 7169, 0178D  
 Injection pump adjustment pin, use as OEM 0188H  
 Crankshaft/camshaft adjustment pin, use as OEM 0188M, 0187B, 0194B, 303-1277, MOT1430, 0189B, 303-735, 49JED1 061, 21-263  
 Injection pump adjustment pin, use as OEM 4527-T.S1  
 Camshaft adjustment pin (CA1), use as OEM 4533-TAC1, 0132AJ1  
 Camshaft adjustment pin (CA2), use as OEM 0132AJ2, 2000 023 000, 0188M, 4533-TAC2  
 2 camshaft adjustment pins, use as OEM 9041-TZ, 5711-TC  
 Camshaft adjustment pin, use as OEM 0189A, 1 871 008 100  
 Camshaft adjustment pin, use as OEM 0189AZ  
 Intake camshaft adjustment pin (VTC), use as OEM 0189L  
 Tension lever, use as OEM 5711-TE, 0178E, 0188J/J1  
 Flywheel locking tool, use as OEM 0188F, 0134Q, 1 870 765 001, 1 870 827 000, 0134AF, 9044-T, 1 871 000 400  
 Hdi tension lever, use as OEM 0188J2  
 Tensioning spanner, 8 mm, use as OEM 7017-TW  
 Toothed belt retaining clip, use as OEM 0189K, MOT1436, 4533-TAX, 0188K, 0187J, 0132AK, 0153AK, 1 870 00 100  
 Flywheel locking tool, use as OEM 1 867 030 000, 0153A, 9765.54, 6012T, 1 860 161 000  
 Roller extractor, use as OEM 0174, 0188P, 018892, 7015-T



FITS FOR:



ART.NR	ITEM NAME	PRICE
<b>BT592600</b>	Engine adjustment tool set for Fiat 1.2 16V	<b>49,00 €</b>

**FOR THE FOLLOWING MODELS**

Fiat 500 1.2 (2007), Brava 1.2, Bravo 1.2 16V (1995-2002), Grande Punto 1.2, Idea 1.2, Idea 1.2 16V, Marea 1.2, Marea Weekend, Marengo 1.2, Palio Weekend 1.2 16V (1993-1999), Punto 1.2 (1993-1999), Punto Classic 1.2 16V (1999), Stilo 1.2  
 Lancia Ypsilon 1.2 16V (1996 - 2003)

**ENGINE CODES**

Engine codes: 17689.000, 169A4.000, 182B2.000, 188A5.000

**DESCRIPTION**

For checking and adjusting the engine timing

**DELIVERY SCOPE**

Measurement adapter for piston height (2 x), use as OEM 1860992000  
 Camshaft adjustment tools (2 x), use as OEM 1860985000  
 Tension roller key, use as OEM 1860987000



FITS FOR:



ART.NR	ITEM NAME	PRICE
<b>BT592660</b>	Camshaft interlock tool for Fiat, Alfa, Lancia	<b>12,00 €</b>

**DESCRIPTION**

Suitable for Fiat DOHC 1.6L 12V/16V petrol engines, installed in the Fiat models Brava, Bravo, Coupe, Marea, StiloWeekend, Multipla, Palio



ART.NR	ITEM NAME	PRICE
BT595700	Camshaft locking tool set for VAG, Ford, Opel, Saab	34,00 €

DESCRIPTION
Universal set for a wide range of models
DELIVERY SCOPE
Camshaft interlock for Opel Calibra, Omega, Sintra, Vectra -1.8, 2.0, use as OEM KM-852, 18G1570
Camshaft interlock for Opel Calibra, Omega, Sintra, Vectra -1.4, 1.6, use as OEM KM-853
Right camshaft with Saab 900, 900 -2.5, 3.0, Opel Calibra, Sintra, Vectra -2.5, 3.0, use as OEM KM-800-2
Left camshaft with Saab 900.900 -2.5, 3.0, Opel Calibra, Sintra, Vectra -2.5, 3.0, use as OEM KM-800-1
Crankshaft toothed belt pulley interlock tool for TDI pump-injection engines with VW, Audi, Skoda, Seat and Ford, use as VAG T10050
Flywheel interlock tools for Citroen, Fiat and Peugeot, use as OEM 153A, 6012T, 9765.54
Flywheel holder unit for Isuzu 1.5 and 1.7 diesel, Opel 1.6, 1.7 diesel engines, Opel 1.2, 1.4, 1.6, 1.8, 2.0 OHC petrol engines, use as OEM KM-517-B



ART.NR	ITEM NAME	PRICE
BT592800	Engine adjustment tool set for Fiat, Lancia	149,00 €

DESCRIPTION
For checking and adjusting the engine timing
Locking the flywheel
Locking the crankshaft
Locking the camshaft
Locking the injection pump shaft
Removing the crankshaft pulley
Spannen des Zahnriemens



ART.NR	ITEM NAME	PRICE
BT592700	Engine adjustment tool set for Alfa Romeo, Fiat 1.4 MultiAir	69,00 €

FOR THE FOLLOWING MODELS
Alfa Romeo Giulietta, Mito, Fiat Punto, Punto Evo 1.4 (Turbo) MultiAir (105/135/163/170PS)
Engine codes: 940A2.000, 940A2.000, 955A8.000, 955A8.000, 940A2.000, 955A8.000, 955A2.000, 955A7.000, 955A6.000, 955A8.000

DESCRIPTION
For adjusting the engine timing when replacing the toothed belt

DELIVERY SCOPE
Camshaft adjustment tool including 3 fastening screws, use as OEM 2000034400
Crankshaft locking tool including 4 fastening screws, use as OEM 2000004500
Tension roller key, use as OEM 1860987000



ART.NR	ITEM NAME	PRICE
BT591350	Engine adjustment tool set for Fiat, Lancia, Alfa Romeo	249,00 €

FOR THE FOLLOWING MODELS
Alfa Romeo 145 1.4, 1.6 16V Step A – 146 1.4, 1.6 16V Step A – 147 1.6 16V Step A – 147 105 PS – 147 1.6 eco 103 PS – 155 1.4, 1.6 16V Step A – 156 1.6 16V Step A – 156 1.8, 2.0 16V – 156 2.0 JTS – 166 2.0 – GTV 2.0 JTS – Spider GT 2.0 JTS 16V 165 PS
Lancia K5 2.0 20V, 4-cylinder, VIS engines start from year of construction 1996 onwards, Delta 1.8 16V Step A, Dedra 1.8 16V Step A, Y10 1.4 12V
Fiat Bravo 1.4 12V, 2.0 20V – Brava 1.4 12V, 2.0 20V – Marea 2.0 20V, Coupe 1.8 16V, Barchetta 1.8 16V, Punto 1.8 16V

DESCRIPTION
Special insert, drive square socket 12.5 mm (1/2") for dismantling the phaser
23 precisely fitting locking devices for the feed and discharge camshaft
prevent the camshafts start from twisting after assembly and position them in assembly position for the toothed belt.
The locking devices are labelled with numbers and additionally colour-coded to avoid confusion
The OT point adjustment mandrel and a micrometer clock (not scope of delivery) makes a precise alignment of the crankshaft possible

DELIVERY SCOPE
Cam shaft locking devices, use as OEM 1 825 041 000, 1 825 042 000, 1 860 096 100, 1 860 819 000, 1 860 847 000, 1 860 892 000, 1 860 899 000, 1 870 797 000
Bracket for dial gauge for adjusting the piston OT (requires dial gauge), use as 1 860 895 000, 1 895 879 000, 1 825 013 000
Insert for phaser, use as OEM 1 822 110 000, 1 852 161 000



ART.NR	ITEM NAME	PRICE
BT592801	Tightening wrench for Fiat	6,00 €



FITS FOR:



ART.NR	ITEM NAME	PRICE
BT592550	Engine adjustment tool for Fiat for 1.4 16V	79,00 €

**FOR THE FOLLOWING MODELS**

Fiat Stilo 1.6 16V, Brava, Bravo, Marea, Weekend, Stilo, Multipla, Palio Weekend (1995-2004)

**ENGINE CODES**

178B3.000, 182A4.000, 182A6.000, 182B6.000

**DESCRIPTION**

For checking and adjusting the engine timing

**DELIVERY SCOPE**

Camshaft interlock tool, intake side, use as OEM 1860874000

Camshaft interlock tool, exhaust side, use as OEM 1860874000

Tension roller interlock, use as OEM 1860876000, including M8 to M10 adapter for models start from 2000 onwards

Dial gauge adapter for determining OT on the first cylinder with M14 thread, total length 270mm, use as OEM 1860895000 / 1895879000 / 1825013000



FITS FOR:



ART.NR	ITEM NAME	PRICE
BT592570	Engine adjustment tool set for Fiat 1.4 12V	46,00 €

**FOR THE FOLLOWING MODELS**

Fiat: Brava, Bravo, Marea, Weekend  
Lancia Ypsilon

**ENGINE CODES**

Engine code: 182 A3.000, 182 A5.000

**DESCRIPTION**

For checking and adjusting the engine timing

**DELIVERY SCOPE**

Camshaft adjustment tool, use as OEM 1860899000

Crankshaft adjustment tool, use as OEM 1860901000

Pin for crankshaft adjustment tool, use as OEM 1860901000



FITS FOR:



ART.NR	ITEM NAME	PRICE
BT592575	Camshaft locking block for Fiat, Lancia 1.4 12V	12,00 €

**FOR THE FOLLOWING MODELS**

Fiat Bravo, Brava, Lancia Y10 1.4 12V

**ENGINE CODES**

Engine code: 182A3.000, 182A5.000

**DESCRIPTION**

For locking the camshafts when adjusting the engine timing

Use as OEM 1860899000



FITS FOR:



ART.NR	ITEM NAME	PRICE
BT592580	Camshaft locking tool set for Fiat 2.0 20V	17,00 €

**FOR THE FOLLOWING MODELS**

Fiat Bravo, Brava, Marea 2.0 20V, 5-Zylinder

**DESCRIPTION**

For checking and adjusting the engine timing

Use as OEM 1860892000

**DELIVERY SCOPE**

Camshaft adjustment tool for intake cam 3-cylinder

Camshaft adjustment tool for exhaust cam 2-cylinder



FITS FOR:



ART.NR	ITEM NAME	PRICE
BT591225	Camshaft locking tool set for Fiat, Lancia 1.8l 130 hp	17,00 €

**FOR THE FOLLOWING MODELS**

Fiat, Lancia 1.8L 16V 130PS

**DESCRIPTION**

For checking and adjusting the camshaft timing

Use as OEM 1860847000

**DELIVERY SCOPE**

Camshaft adjustment tool for intake cam 2-cylinder

Camshaft adjustment tool for exhaust cam 3-cylinder



FITS FOR:



ART.NR	ITEM NAME	PRICE
BT592585	Camshaft locking tool set for Fiat, Lancia 1.8, 115 hp	17,00 €

**FOR THE FOLLOWING MODELS**

Fiat Bravo, Brava, Marea 1800 16V, 115 PS

Lancia Delta, Dedra 1800 16V, 115 PS

**DESCRIPTION**

For checking and adjusting the engine timing

Use as OEM 1860875000

**DELIVERY SCOPE**

Camshaft adjustment tool for intake cam 2-cylinder

Camshaft adjustment tool for exhaust cam 3-cylinder



FITS FOR:



ART.NR	ITEM NAME	PRICE
BT592590	Camshaft locking tool set for Fiat, Lancia 1.8 16V	17,00 €

**FOR THE FOLLOWING MODELS**

Fiat Coupe, Barchetta, Punto (HJT), Barchetta (HJT)

Lancia Delta, Dedra Step"A"

**DESCRIPTION**

For checking and adjusting the engine timing

Use as OEM 1870697000

**DELIVERY SCOPE**

Camshaft adjustment tool for intake cam 2-cylinder

Camshaft adjustment tool for exhaust cam 3-cylinder



ART.NR	ITEM NAME	PRICE
<b>BT597940</b>	Engine adjustment tool set for Peugeot, Citroën, PSA	<b>89,00 €</b>

**FOR THE FOLLOWING MODELS**

Citroën AX, Berlingo, BX, C5, C15, C25, Dispatch, Evasion, Jumper, Jumpy, Relay, Saxo, Synergie, Visa, Xsara, Xantia, XM, XJR, ZX, etc.

Peugeot 106, 205, 306, 405, 406, 605, 806, J5, Boxer, Expert, Partner, Solara, Talbot Express, Talbot Horizon, etc.

PSA petrol engines 1.9, 1.1, 1.4, 1.6, 1.8, 1.9, 2.0, 1.6, 1.8, 2.0, 2.2 16V (turbo and dual camshafts)

PSA diesel engines 1.4, 1.5, 1.7, 1.8, 1.9, 2.1, 2.5 D, TD, TDI, 1.4, 1.6, 2.0, 2.2 HDI

Suitable for structurally identical engines in Fiat, Ford, Nissan, Renault, Rover, Toyota, etc.

**DESCRIPTION**  
For checking and adjusting the engine timing

**DELIVERY SCOPE**

Flywheel adjustment pin with spring, use as OEM 0188X, 0189X

Tensioning spanner, 8 mm, use as OEM 7017-TW

Flywheel fixing mandrel, 7 mm, use as OEM 7017-TR

Angled adjustment pin, 8 mm, use as OEM 0188D, 7004TG, 9767-34, 0153G, 7014-TJ, 1 860 863 000, 0153N

Clamping tool, use as OEM 4507-TJ, 9767.89, 0188Q1, 0132X1Z, 0132X

Camshaft marking mandrel, use as OEM 0189A, 1 871 008 100

Hdi tension roller lever, use as OEM 0188J2

Tension roller lever, use as OEM 5711-TE, 0178E, 0188J/J1

Flywheel disc extractor, use as OEM 0174.0188P, 018892, 7015-T

Toothed belt retaining clamp, use as OEM 0189K, MOT1436, 4533-TAX, 0188K, 0187J, 0132AK, 0153AK, 1 870 00 100

Flywheel retainer, use as OEM 0195K, 4507-TL

Clamping tool, use as OEM 0189S1

Flywheel retainer, use as OEM 1867030000, 0153A, 9765.54, 6012T, 1860161000

Tension lever, use as OEM 0189S2

Angled locking pin, 5 mm

Flywheel fixing mandrel (for automatic transmission), use as OEM 0189R

Camshaft marking mandrel, use as OEM 0189AZ

Crankshaft retainer, use as OEM 0288D, 0188Y, 7014

Flywheel fixing mandrel (manual transmission), use as OEM 0189C

Flywheel interlock, use as OEM 0188F, 0134Q, 1870765001, 1870827000, 0134AF, 9044-T, 1871000400

Camshaft marking mandrel (CA1), use as OEM 4533-TAC1, 0132AJ1

Camshaft and crankshaft retainer, use as OEM 0188M, 0187B, 0194B, 303-1277, MOT1430, 0189B, 303-735, 49JE01061, 21-263

Camshaft marking mandrel (CA2), use as OEM 0132AJ2, 2000023000, 0188M, 4533-TAC2

Marking mandrel for injection pump, use as OEM 4527-TS1

Injection pump fixing mandrel, use as OEM 0188H, 1 860 965 000

Flywheel fixing mandrel, use as OEM 49JE02020, 0194C, 21-262, 999-7121, 999-7169, 303-734

2 camshaft and crankshaft marking mandrels, use as OEM 4507-TB, 7014-TN, 0132-R, 0153-AB, 0158-G

2 camshaft and crankshaft interlocks, use as OEM KM-955, 7014-TM

2 camshaft marking mandrels, use as OEM 9041-TZ, 5711-TC

2 crankshaft fixing mandrels, use as OEM 5711-TD, 119790, 0194A, 1860617000, 303-732, 07744-00104-00, 49JE02018, 0178D, 9997169, 4527-TS2, 21-260, 999-7169, 0132AB

Camshaft fixing mandrel, use as OEM 0189L

Screw M8 x 80 mm

Pin for clamping device, 3 mm, use as OEM 0153AL, 4200TA

Centring clip for crankshaft pulley, use as OEM 0188AH

Crankshaft marking mandrel, 6 mm, use as OEM 4507-TA, 0132Z, 0132QZ

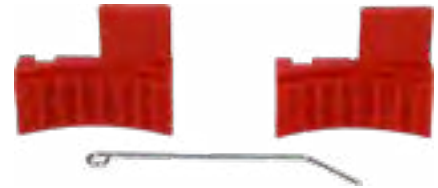

ART.NR	ITEM NAME	PRICE
<b>BT595703</b>	Camshaft locking tool for Opel 1.6, 1.8	<b>7,00 €</b>

**DESCRIPTION**

Contains important tools for inspecting and adjusting the engine timing

Suitable for Opel Astra G/H, Corsa D, Insignia, Meriva, Signum, Tigra, Vectra C, Zafira B (2003-2012) with engine codes A16LET, A16XER, Z16LEL, Z16LER, Z16LET, Z16XE, Z16XE1, Z16XEP, Z16XER, Z18XER, A18XER

Also suitable for Alfa Romeo 159, Fiat Croma with engine code 939A4.000

**DELIVERY SCOPE**

Camshaft interlock, use as OEM KM-6340, EN-6340, 2000012100

Tensioning element interlock, use as OEM KM-6333, EN-6333



ART.NR	ITEM NAME	PRICE
<b>BT592578</b>	Camshaft locking tool for 1.3l PSA Diesel	<b>16,00 €</b>

**DESCRIPTION**

For holding the camshaft when loosening and tightening the bolts on the camshaft sprocket

Needed when working on the camshaft drive

Suitable for Citroën, Peugeot, Fiat, Ford, Alfa Romeo 1.3 JTD

Recommended accessory for BGS engine adjustment set Art. BT592540

Use as Ford OEM 303-1475 / Fiat OEM 1871008600

# FORD



FITS FOR:

ART.NR	ITEM NAME	PRICE
<b>BT593050</b>	engine adjustment tool set for Ford	<b>14,00 €</b>

### DESCRIPTION

Suitable for petrol engines 1.25 L, 1.4 L, 1.6 L, 1.8 L, 2.0 L, e.g. for Zetec, Zetec SE, etc.

### DELIVERY SCOPE

Crankshaft interlocks, use as OEM 303-748, 999-7152 21-259, 303-574, 21-163, 303-620, 49J E02 024, 999-7201, 303-507, 21-210  
Camshaft rule, use as 303-376, 303-376B, 999-7151



FITS FOR:

ART.NR	ITEM NAME	PRICE
<b>BT595700</b>	camshaft locking tool set for VAG, Ford, Opel, Saab	<b>34,00 €</b>

### DESCRIPTION

Universal set for a wide range of models

### DELIVERY SCOPE

Camshaft interlock for Opel Calibra, Omega, Sintra, Vectra -1.8, 2.0, use as OEM KM-852, 18G1570  
Camshaft interlock for Opel Calibra, Omega, Sintra, Vectra -1.4, 1.6, use as OEM KM-853  
Right camshaft with Saab 900, 900 -2.5, 3.0, Opel Calibra, Sintra, Vectra -2.5, 3.0, use as OEM KM-800-2  
Left camshaft with Saab 900.900 -2.5, 3.0, Opel Calibra, Sintra, Vectra -2.5, 3.0, use as OEM KM-800-1  
Crankshaft toothed belt pulley interlock tool for TDI pump-injection engines with VW, Audi, Skoda, Seat and Ford, use as VAG T10050  
Flywheel interlock tools for Citroen, Fiat and Peugeot, use as OEM 153A, 6012T, 9765.54  
Flywheel holder unit for Isuzu 1.5 and 1.7 diesel, Opel 1.6, 1.7 diesel engines, Opel 1.2, 1.4, 1.6, 1.8, 2.0 OHC petrol engines, use as OEM KM-517-B



FITS FOR:

ART.NR	ITEM NAME	PRICE
<b>BT592900</b>	engine adjustment tool set for Ford Focus	<b>41,00 €</b>

### DESCRIPTION

For replacing the toothed belt in Ford Focus 1.6 TI-VCT engines, engine code HXDA (2003-2007) and 2.0 TDCI engine code G6DA, G6DB, G6DC 2003-2007

### DELIVERY SCOPE

Holder for camshaft wheel, use as OEM 303-1097  
Locking pin for tension roller, use as OEM 303-1054  
Locking pin for flywheel, use as OEM 303-1059, 303-1270, 0188X, 999-7121  
Locking pin for crankshaft, use as OEM 303-748, 999-7152, 21-259  
Locking pin for camshaft wheel, use as OEM 303-735, 999 7122, 0187B, 0189B, 0132AJ1, 21-263, 0188M, MOT 1430, 303-1277, 0194B



FITS FOR:

ART.NR	ITEM NAME	PRICE
<b>BT551110</b>	injector alignment tool for Ford Duratorq	<b>25,00 €</b>

### DESCRIPTION

For aligning injectors with the fuel lines  
Aligning the injectors with the fuel lines eliminates the risk of fuel line breakage that could occur during operation  
Suitable for Ford Duratorq engines 2.0 / 2.2 / 2.4 DI / TDCI / TDDI, installed in the Ford Mondeo, year of construction 2000 - 2007 / Ford Transit, year of construction 2000 - 2006 / Jaguar X-Type  
Tool for simultaneous alignment of two injectors, use as OEM 303-67B  
Tool for aligning injectors, adjustable, use as OEM 303-711



FITS FOR:

ART.NR	ITEM NAME	PRICE
<b>BT592320</b>	balance shaft adjustment tool set for Land Rover, Citroen, Mitsubishi, Peugeot, Ford 2.2 DOHC diesel engines	<b>42,00 €</b>

### FOR THE FOLLOWING MODELS

Land Rover Discovery, Discovery Sport, Freelander 2, eD4, TD4, TD4e (2009-2015) engine codes: 224DT, DW12CTED4/224DT, DW12BTED4/224DT  
Citroen C5, C5 II, C5 III, C6, C8, C-Crosser HDi (200-2015) engine codes: 4HX (DW12CTED4), 4HP (DW12BTED4), 4HX (DW12TED4), 4HW (DW12TED4/L4)  
Mitsubishi Outlander DI-D, DI-DC (2007-2013) engine codes: 4HK, 4HN  
Peugeot 4007, 407, 607, 807, 406, 508, 607, HDi, GT HDi (2000-2015) engine codes: DW12MTED4 (4HK), DW12MTED4 (4HN), DW12BTED4 (4HP), DW12BTED4 (4HR), DW12BTED4 (4HT), DW12TED4/L4 (4HW), DW12BTED4 (4HS), DW12ATED (4HZ), DW12ATED4 (4HX), DW12ATED (4HZ), DW12CTED4 (4HL)  
Ford Galaxy, Mondeo, S-Max, TDCI, TCI (2008-2015) engine codes: KNBB, KNBA, KNWA, Q4BA

### DESCRIPTION

For adjusting the balance shaft

### DELIVERY SCOPE

Balance shaft fixing tool, use as OEM 303-1329  
Balancing tool, use as OEM 303-1330  
Balance shaft adjustment tool, use as OEM 303-1328, 0190D



FITS FOR:

ART.NR	ITEM NAME	PRICE
<b>BT571013</b>	crankshaft holding key for Ford	<b>42,00 €</b>

### DESCRIPTION

Mondeo and Transit with 2.0, 2.2, 2.4, 3.2 Duratorq Di, TDDi, TDCi diesel and 2.3 Duratec HE petrol  
Use as OEM 303-1310  
Length: 665 mm



ART.NR	ITEM NAME	PRICE
BT592860	engine adjustment tool set for Ford TDCi, PSA Hdi, Mazda D 1.4, 1.6	5,00 €

**FOR THE FOLLOWING MODELS**

Citroen 1.4Hdi DV4TD (8HT/8HW/8HX/8HZ), 1.4Hdi DV4TED4 (8HV/8HY), 1.6Hdi DV6TED4 (9HY/9HZ), 1.6Hdi DV6ATED4 (9HW/9HX), 1.6Hdi DV6UT-ED4(9HU)

Mazda 1.4CiTD F6JA, F6JB 1.6CiTD Y6

Peugeot 1.4Hdi DV4TD (8HT/8HW/8HX/8HZ), 1.4Hdi DV4TED4 (8HV/8HY), 1.6Hdi DV6TED4 (9HY/9HZ), 1.6Hdi DV6ATED4 (9HW/9HX), 1.6Hdi DV6UT-ED4(9HU)

Ford 1.4TDCi F6JA, F6JB, F6JC, F6JD 1.6TDCi G8DA, G8DB, HHDA 1.6TDCi HHDB, HHJA, HHJB, HHJD

Volvo 1.6D D4164T

**DESCRIPTION**

For adjusting the engine timing when replacing the camshaft, cylinder head seal etc.

**DELIVERY SCOPE**

Flywheel locking bolt, use as OEM PSA 0194-C, Ford 303-734 (21-262), Volvo 999-7169, Mazda 49 JE02 020

Crankshaft and high-pressure pump wheel locking pin, 2 pcs, use as OEM PSA 0194-A, Ford 303-732 (21-260), Volvo 999-7233, Mazda 49 JE02 018

Crankshaft and high-pressure pump wheel locking pin, 2 pcs, use as OEM PSA 0194-A, Ford 303-732 (21-260), Volvo 999-7233, Mazda 49 JE02 018



ART.NR	ITEM NAME	PRICE
BT592951	camshaft pump wheel puller for Ford	13,00 €

**DESCRIPTION**

Also suitable for removing the pump wheel

Jaw depth: 30 mm

Hook foot depth: 7.5 mm

Hook length: 15.5 mm

Spindle length: 80 mm

Spanner width of actuation hex: SW 19

Hook foot thickness at the tip: 8 mm



ART.NR	ITEM NAME	PRICE
BT551105	timing case cover alignment and pump wheel removal tool set for Ford 1.8 TDDi / TDCi	26,00 €

**FOR THE FOLLOWING MODELS**

Ford

Focus 1.8 TDCi (2004 - 2011), engine codes: KKDA, KKDB

C-Max 1.8 TDCi (2003 - 2007), engine codes: KKDA, BHPA, HCPA

Tourneo Connect 1.8 TDCi (2002 - 2013), engine codes: HCPA, HCPB (2002 - 2006), RWPA, R2PA, P7PA, P9PA, R3PA (2006-2013), P9PB, RWPC (2009 - 2013)

Tourneo Connect 1.8 TDDi (2002 - 2006), engine code: BHPA

Mondeo 1.8 TDCi (2007 - 2010), engine codes: FFBA, QYBA, KHBA

Mondeo 1.8 TDCi ECOnetic (2008 - 2010), engine code: KHBA

Transit Connect 1.8 TDCi (2002 - 2013), engine codes: HCPA, HCPB (2002 - 2006), RWPA, P7PA, R2PA, P9PA, R3PA (2006 - 2013), P9PB, RWPC (2009 - 2013)

Transit Connect 1.8 TDDi (2002 - 2006), engine code: BHPA

**DESCRIPTION**

For aligning the timing case cover and for removing the high-pressure pump wheel

When working on e.g. the high-pressure pump chain

Supplementary tool for engine adjustment tool set Art. BT593100

**DELIVERY SCOPE**

Alignment tool for timing case cover, use as OEM 303-652 (21-230)

Disassembly tool for high-pressure pump wheel, use as OEM 303-095 (23-067)



ART.NR	ITEM NAME	PRICE
BT592540	engine adjustment tool set for Fiat, Ford, Opel, Suzuki 1.3 diesel	45,00 €

**FOR THE FOLLOWING MODELS**

Fiat Punto 1.3 JTD Multi-Jet 188A9.000, 2003 - 2007, Panda 1.3 JTD Multi-Jet 169A1.000, 188A8.000, 2003 - 2009, Idea 1.3 JTD Multi-Jet 199A3.000, 188A9.000, 2004 - 2006, Doblo 1.3 JTD Multi-Jet 188A9.000, 2004 - 2006, Doblo Cargo 1.3 JTD 188A9.000, 2004 - 2006

Opel/Vauxhall Agila 1.3 CDTi Z13DT, 2003 - 2008, Corsa-C 1.3 CDTi Z13DT, 2003 - 2007, Combo-C 1.3 CDTi Z13DT, 2003 - 2009, Corsa-D 1.3 CDTi Z13DTH, Z13DTJ, 2006 - 2009, Astra-H 1.3 CDTi Z13DTH, 2004 - 2009, Tigra-B 1.3 CDTi Z13DT, 2004 - 2009, Meriva 1.3 CDTi Z13DT, Z13DTJ, 2004 - 2009

Suzuki: Ingis 1.3 CDTi Z13DT, 2003 - 2009, Wagon R 1.3 CDTi Z13DT, 2003 - 2009, Swift 1.3 CDTi Z13DT, 2003 - 2010

Ford Ka 1.3 TDCi

**DESCRIPTION**

For checking and adjusting the engine timing

**DELIVERY SCOPE**

Counter-support spanner for crankshaft pulley, use as Fiat OEM 1871000200 - Ford OEM 303-1469 - Opel/Vauxhall OEM KM-662-C

Crankshaft adjustment tool, use as Opel/Vauxhall OEM EN 46785, OEM KM 955 - Suzuki 09912-38300

Camshaft adjustment tool, use as Fiat OEM 1871000900, 1860985000 - Ford OEM 303-1472 - Opel/Vauxhall OEM EN 46781 - Suzuki OEM 09917-68610

Chain tension lever, use as Fiat OEM 1870900400

Crankshaft interlock tool, use as Fiat OEM 1870900300 - Ford OEM 303-1468

Crankshaft adjustment tool, Fiat 8 mm

**ON THE MARKET SINCE 2018.  
THANKS TO KS TOOLS WITH  
THE EXPERIENCE OF 30 YEARS.**



FITS FOR:



ART.NR	ITEM NAME	PRICE
<b>BT593030</b>	crankshaft locking tool for Ford Transit 2.2.	<b>40,00 €</b>

**DESCRIPTION**

Suitable for Ford Transit 2.2 up until 2006  
Used to lock the crankshaft and the flywheel  
Makes it possible to adjust the OT sensor position after working on the timing chain

**DELIVERY SCOPE**

Crankshaft interlock, use as OEM 303-1587  
Flywheel interlock, use as OEM 21-251 / 303-698  
Pump locking pin, use as OEM 0188H / 1860965000

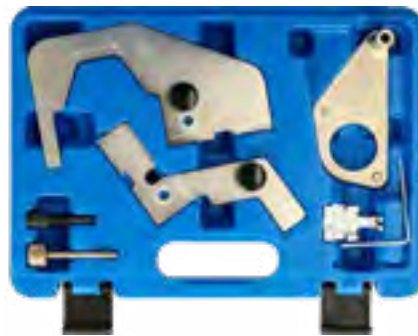

FITS FOR:



ART.NR	ITEM NAME	PRICE
<b>BT592970</b>	engine adjustment tool set for Ford 2.0 Ecoboost	<b>84,00 €</b>

**FOR THE FOLLOWING MODELS**

Installed in the models Galaxy / Mondeo / S-MAX / Focus

**ENGINE CODES**

Engine code: TNWA, TNBA, TPWA, MGDA, XGDA

**DESCRIPTION**

For adjusting the timing on chain-driven 2.0L petrol direct injection engines with variable valve control

**DELIVERY SCOPE**

Crankshaft interlock, use as OEM 303-748  
Camshaft adjustment plate (up until 05/2011), use as OEM 303-1504  
Camshaft adjustment plate (start from 05/2011 onwards), use as OEM 303-1565  
Adjustment tool for crankshaft position sensor, use as OEM 303-1521  
2.5 mm belt tensioner locking pin



FITS FOR:



ART.NR	ITEM NAME	PRICE
<b>BT592700</b>	engine adjustment tool set for Alfa Romeo, Fiat 1.4 MultiAir	<b>69,00 €</b>

**FOR THE FOLLOWING MODELS**

Alfa Romeo Giulietta, Mito, Fiat Punto, Punto Evo 1.4 (Turbo) MultiAir (105/135/163/170PS)

Engine codes: 940A2.000, 940A2.000, 955A8.000, 955A8.000, 940A2.000, 955A8.000, 955A2.000, 955A7.000, 955A6.000, 955A8.000

**DESCRIPTION**

For adjusting the engine timing when replacing the toothed belt

**DELIVERY SCOPE**

Camshaft adjustment tool including 3 fastening screws, use as OEM 2000034400  
Crankshaft locking tool including 4 fastening screws, use as OEM 2000004500  
Tension roller key, use as OEM 1860987000

**BT034012**  
**EAN 4042146844267**

**Screwdriver set with striking cap, 12 pcs**

**12**  
pcs.

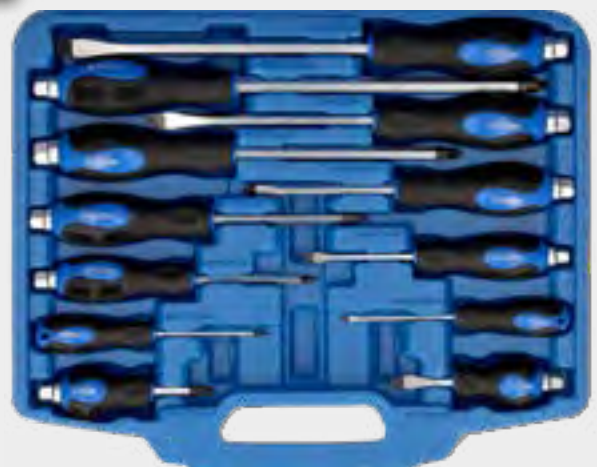

**25,- €**

<b>5x</b>		<ul style="list-style-type: none"> <li>3 x 75 mm • 5 x 75 mm</li> <li>6 x 100 mm • 8 x 150 mm</li> <li>9,5 x 200 mm</li> </ul>
<b>5x</b>		<ul style="list-style-type: none"> <li>PH0 x 75 mm • PH1 x 75 mm</li> <li>PH2 x 100 mm • PH3 x 150 mm</li> <li>PH4 x 200 mm</li> </ul>

<b>1x</b>		6 x 38 mm
<b>1x</b>		PH2 x 38 mm





FITS FOR:



ART.NR	ITEM NAME	PRICE
BT592980	engine adjustment tool set for Ford 2.0, 2.4 TDCi, TDDi	75,00 €

**ENGINE CODES**

Engine code: FMBA/B, D5BA, ABFA, D3FA, F3FA, D2FA, D4FA, F4FA

**DESCRIPTION**

For locking or positioning the camshaft, injection pump shaft and crankshaft

Needed when replacing the chain, repairing the engine and working on the injection pump

Suitable for Ford 2.0, 2.4 16V TDCi and TDCi engines, installed in e.g. Mondeo, Transit (year of construction 2001 - 2004) etc.



FITS FOR:



ART.NR	ITEM NAME	PRICE
BT592870	engine adjustment tool set Ford Duratorq 2.0, 2.4 Diesel	6,00 €

**ENGINE CODES**

ABFA, D2FA, D3FA, D5BA, D6BA, D0FA, F1FA, F3FA, F4FA, FMBA/B, FXFA, H9FA, H9FB, HJBA/B, HJBC, HJBE, JXFA, N7BA/B, PHFA, SDBA

**DESCRIPTION**

Needed for working on the timing chain, cylinder head etc.

Contains a locking pin for the flywheel, pump, camshaft and chain tensioner, use as OEM 21-234, 21-251

Suitable for Ford Mondeo and Transit 2.0 I / 2.4 I Duratorq 16V (TDDi and TDCi)

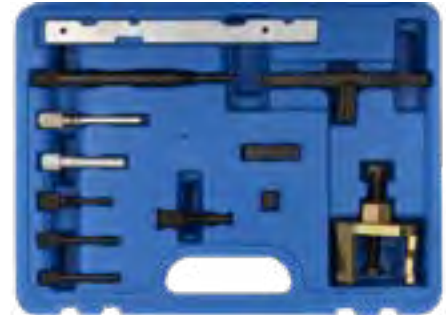

FITS FOR:



ART.NR	ITEM NAME	PRICE
BT592850	Engine adjustment tool for Ford, Mazda	55,00 €

**FOR THE FOLLOWING MODELS**

Ford Fiesta, Fusion, Focus, C-Max, Mondeo, Mondeo S-Max, Galaxy, Tourneo Connect, Transit Connect

Mazda 2, 3, 5, 121

**ENGINE CODES**

F6JA, F6JB, F6JC, HHJA, HHJB, G8DA, HHDA, HHDB, RTN, RTQ, RTP, C9DC, BHDA/B, BHPA, C9DA/B, C9DC, HXDA, G6DA, AZWA, G6DB, QXWA, G6DC, F9DA/B, FFBA, FFDA, HCPA, HCPB, KKDA, P7PA, P9PA, QYWA, R2PA, R3PA and RWPA

4HB, F6JA, F6JB, RTJ, Y6, MZ-CD 1.6 (Y6)

**DESCRIPTION**

For checking and adjusting the engine timing

**DELIVERY SCOPE**

Camshaft interlocks, use as 303-732

Crankshaft interlocks, use as 303-193

Crankshaft interlock, use as OEM 303-507

Crankshaft interlock, use as OEM 303-574

Crankshaft interlock, use as OEM 303-748

Flywheel interlocks, use as OEM 303-1602, 303-393-01 and 303-393-02

Flywheel interlocks, use as OEM 303-734

Camshaft rule, use as OEM 303-376

Camshaft wheel puller, use as OEM 303-651



FITS FOR:



ART.NR	ITEM NAME	PRICE
BT596002	Universal camshaft wheel puller	63,00 €

**DESCRIPTION**

For pulling the pulley and camshaft gear

Gripping arms are connected with each other via adjusting disk, thus the gripping arms can be set easily and exactly

Continuous adjustment range of the gripping arms start from 42 – 82 mm

Gripping arm depth is 27 mm

**DELIVERY SCOPE**

3 x gripping arms, Ø 12 mm, M10 x 1.5, suitable for material thickness up to max. 10 mm

6-groove puller body with adjusting disc

Spindle, M14 x 1.5, 19 mm hex, with centring cone



FITS FOR:



ART.NR	ITEM NAME	PRICE
BT571014	Crankshaft vibration damper alignment tool for Ford, Volvo	6,00 €

**DESCRIPTION**

For aligning the crankshaft vibration damper (crankshaft pulley)

Needed for e.g. 1.6 L EcoBoost engines

Use as OEM Ford 303-1550 or Volvo 9997431



ART.NR	ITEM NAME	PRICE
<b>BT591260</b>	Camshaft sprocket locking tool set, universal	<b>72,50 €</b>

**FOR THE FOLLOWING MODELS**

Can be used universally on vehicles start from the following manufacturers: Audi, Alfa Romeo, Chrysler, Citroën, Ford, Honda, Hyundai, Isuzu, Land Rover, Lexus, Mazda, Mitsubishi, Peugeot, Renault, MG, Seat, Skoda, Subaru, Toyota, Opel, Volkswagen, Volvo

**DESCRIPTION**

For locking the camshaft sprockets e.g. when replacing the toothed belt  
Suitable for engines with 1, 2 and 4 camshafts (V engines); also suitable for locking between the camshaft sprocket and diesel injection pump wheel in some diesel engines

**DELIVERY SCOPE**

Double camshaft locking tool with short and long connecting arm  
Single camshaft locking tool with short and long locking screw

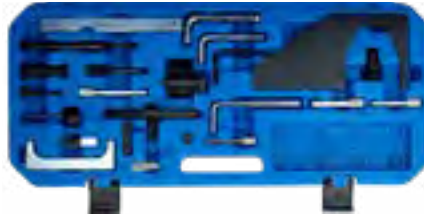

FITS FOR:

ART.NR	ITEM NAME	PRICE
<b>BT593100</b>	Engine adjustment tool set for Ford	<b>109,00 €</b>

**FOR THE FOLLOWING MODELS**

Suitable for the following Ford engines: 1.4, 1.6 16V, 1.7, 1.8 16V, 2.0 16V (including Zetec), 1.4, 1.6, 1.8, 1.9 D/TD/TDCi

**DESCRIPTION**

Contains tools for: Locking the flywheel  
Locking the crankshaft, pump shaft  
Locking the injection pump shaft  
Removing the crankshaft pulley  
Tensioning the toothed belt

Adjustment gauge for positioning the camshaft and pump shaft in relation to the crankshaft  
Use as OEM 21-162, 21-162B, 303-367, 303-376, 23-059, 310-085, 21-168, 303-393, 23-020, 23-047, 23-020, 21-163, 303-620, 23-019, 21-210, 303-507, 21-251, 303-698, 21-262, 303-734, 23-029, 303-1061, 23-058, 310-084, 21-105, 21-262, 303-734, 21-168, 303-393, 21-263, 303-735, Mazda 49JE01061, Audi 3359, T10008, T10050, 2065A, Seat 3359, T10008, T10050, 2065A, Skoda 3359, T10008, T10050, 2065A, Volkswagen 3359, T10008, T10050, 2065A



FITS FOR:

ART.NR	ITEM NAME	PRICE
<b>BT592976</b>	Camshaft adjustment tool for Ford 1.6 EcoBoost	<b>17,00 €</b>

**FOR THE FOLLOWING MODELS**

Ford Galaxy, S-Max, Mondeo, C-Max, Focus, Fiesta, Kuga, Transit, Tourneo Connect  
1.6L EcoBoost (Sigma)

**DESCRIPTION**

For locking the camshafts when removing/replacing the timing chain

**DELIVERY SCOPE**

Camshaft adjustment tool, use as OEM 303-1552



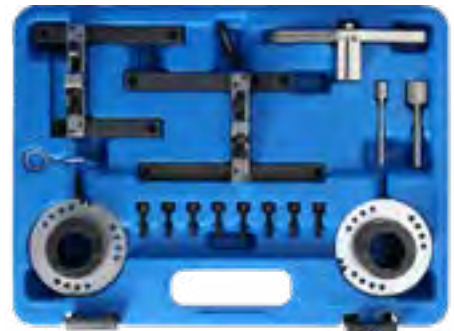
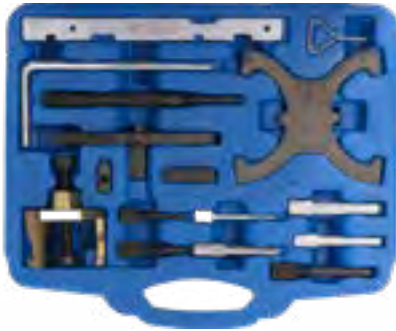

FITS FOR:



ART.NR	ITEM NAME	PRICE
BT592950	Engine adjustment tool for Ford	72,00 €

**FOR THE FOLLOWING MODELS**

Ford Fiesta (1995-2008), Fusion (2002-2008), Puma (1997-2002), Focus (1998-2008), Focus C-Max (2003-2008), Mondeo (1993-2008), Cougar (1998-2001), S-Max (2006-2008), Galaxy (2006-2008), Courier (1995-2008), Tourneo Connect (2002-2006), Transit Connect (2002-2006)

**ENGINE CODES**

Petrol: DHA, DHB, DHC, DHD, DHE, DHF, DHG, F8JA, F8JB, FUJA, FUJB, M7JA, M7JB, ASDA, ASDB, FHA, FHD, FHE, FHF, FXDA/C, FXDB/D, FXJA, FXJB, BHPA, C9DA/B, C9DC, HXDA, G6DA, AZWA, G6DB, QXWA, G6DC, F9DA/B, FFBA, FFDA, HCPA, HCPB, KKDA, P7PA, P9PA, QYWA, R2PA, R3PA, RWPA, FYDA/C, FYDB/D, FYJA, FYJB, L1F, L1J, L1L, L1N, L1O, L1T, L1V, L1W, HWDA, HWDB, MHA, MHB, EYDB, EYDC, EYDD, EYDE, EYDF, EYDG, EYDI, EYDJ, EYPA, EYPC, RKA, RKB, RKF, RKH, RKJ, RKK, CDBB, CGBA/B, CHBA/B, CSDA, CSDB, QGDA, QGDB, QGDC, EDDB, EDBD, EDDB, EDDC, EDDD, EDDF, NGA, NGB, NGC, NGD, ALDA, HMDA, AODA, AODB, AOWA, CJBAB

Diesel: F6JA, F6JB, F6JC, HHJA, HHJB, G8DA, G8DB, HHDA, HHDB, RTN, RTO, RTP, C9DC, BHDAB, BHPA, C9DA/B, C9DC, F9DA/B, FFBA, FFDA, HCPA, HCPB, KKDA, P7PA, P9PA, QYWA, R2PA, R3PA, RWPA, G6DA, AZWA, G6DB, QXWA, G6DC

1.25 16V, 1.4 16V, 1.6 16V, 1.7 16V, 1.8 16V, 1.8 16V with timing chain, 2.0 16V, 2.0 RS/ ST170, 2.0 with timing chain

1.4 TDCi, 1.6 TDCi, 1.8 D Turbo, 1.8 TdDi, 1.8 TDCi and 2.0 TDCi

**DESCRIPTION**

For checking and adjusting the engine timing

FITS FOR:



ART.NR	ITEM NAME	PRICE
BT594670	Engine adjustment tool set for Renault, Volvo, Ford 16V, 20V petrol	29,00 €

**FOR THE FOLLOWING MODELS**

Renault Laguna (1996, 1999), Safrane (1996, 2001) with engine codes: N7Q 704, 710, 711 N7U 700, 701

Ford Kuga (start from 02/2008 onwards), Focus ST RS (start from 07/2004 onwards), S-Max (start from 03/2006 onwards), Galaxy (start from 03/2006 onwards), Mondeo (start from 02/2007 onwards) with engine codes: JZDA, HYDB, HYDC, HUWA

Volvo 850 (1992, 1997), C70 (1998, 2002), S40 (1996, 2004), V40 (1996, 2004), S60 (2001, 2005), S70 (1997, 2000), S80 (1999, 2005) with engine codes: B4164 S/S2, B4184 S/S2/S3/S9/S10, B4194 T/T2, B4204 S/S2/T/T2/T3/T5, B5202 FS, B5204 FT/T2/T3/T4/T5, B5234 T3/T4/T5/T6/T7/T8/T9, B5244 S/S2/S6/S62/T3/T4/T5/T7, B5252 FS, B5254 T/T2/T4

**DESCRIPTION**

Contains important tools for adjusting the engine timing 1.6, 1.8, 1.9, 2.0, 2.3, 2.4, 2.5L DOHC engines

**DELIVERY SCOPE**

Camshaft retainer, use as OEM MOT1337, 999-5452, 303-1178

Tension roller key, use as OEM MOT1348

Flywheel retainer, use as OEM MOT1340, 999-5451, 303-1182

FITS FOR:



ART.NR	ITEM NAME	PRICE
BT593010	Motor-Einstellwerkzeug-Satz für Ford 1.0, 3-Zylinder EcoBoost	259,00 €

**ENGINE CODES**

Engine code: M1DD, M1JA, M1JC, M1JE, M1JHM1JJ, M1DA, M2DA, M2DB, M2DC, SFDBSFJA, SFJB, SFJC, SFJD

**DESCRIPTION**

For checking and adjusting the engine timing Suitable for Ford engines 1.0L 3-cylinder, with 74 KW, 88 KW, 92 KW, 103 KW, installed in e.g. Fiesta, Focus, B-MAX, EcoSport

**DELIVERY SCOPE**

Camshaft fixing tool, use as OEM 303-1605 (x 2)

Adjustment tool for camshaft adjuster, use as OEM 303-1606 (x 2)

Crankshaft fixing mandrel, use as OEM 303-1604

Flywheel fixing tool, use as OEM 303-1602, 303-393A, 21-168

Tension roller fixing pin, use as OEM 303-1054



WWW.BRILLIANT-TOOLS.COM

**360° IMAGES OF ALMOST ANY PRODUCT**



ART.NR	ITEM NAME	PRICE
<b>BT592578</b>	Camshaft locking tool for 1.3l PSA diesel	<b>16,00 €</b>

**DESCRIPTION**

For holding the camshaft when loosening and tightening the bolts on the camshaft sprocket

Needed when working on the camshaft drive

Suitable for Citroën, Peugeot, Fiat, Ford, Alfa Romeo 1.3 JTD

Recommended accessory for BGS engine adjustment set Art. BT592540

Use as Ford OEM 303-1475 / Fiat OEM 1871008600



ART.NR	ITEM NAME	PRICE
<b>BT594460</b>	Engine adjustment tool set for PSA 2.5, 2.8 l diesel	<b>12,00 €</b>

**FOR THE FOLLOWING MODELS**

Citroen, Peugeot, Fiat, Iveco Traffic (1980-2000), Master (1980-2007), Mascot (1999-2007)

Fiat, PSA, Renault Daily (1991-2005), Turbo Daily (1994-2000), Relay, Jumper (2001-2002) Boxer (2000-2006), Arena (1997-2001), Movano (1998-2003)

**DESCRIPTION**

Use as OEM Fiat 1 870 667 000, 1 870 765 001, 1 860 617 000, Renault MOT861, MOT1054, MOT863, Opel KM6031, Ford 21-260, 303-732, Peugeot 0132AB, 5711TD, 4527TS2, 0178D, 0194A, 119790, Citroen 0132AB, 5711TD, 4527TS2, 0178D, 0194A, 119790, Mazda 49 JE 02018, 0991246510, Volvo 999-7169

**DELIVERY SCOPE**

- 2 locking bolts
- Flywheel locking bolt
- Holding tool for toothed belt tensioner



ART.NR	ITEM NAME	PRICE
<b>BT593040</b>	Engine adjustment tool set for Ford 2.5, Volvo 1.6, 2.5 and 2.4D	<b>132,00 €</b>

**FOR THE FOLLOWING MODELS**

Ford Focus 2.5 RS, ST, Mondeo 2.5, S-Max 2.5, Galaxy 2.5 ST (start from 2005 onwards)

Volvo C30 (2006, 2010), C70 (1998, 2010), S40 (1996, 2010), S60 (2000, 2009), S70 (1997, 2007), S80 (1998, 2006), V40 (1996, 2010), V50 (2004, 2010), V70 (1997, 2007), XC70 (2002, 2007), XC90 (2002, 2010)

**ENGINE CODES**

Ford engine codes: 2.5 Turbo (Euro 4), HUBA, HUWA, HYDA, JZDA

Engine codes: 1.6 (B4164S), 1.8 (B4184S), 1.9T (B4194T), 2.0 (B4204S, B4204T), 2.0T (B5204T3, B5204T4, B5204T5), 2.3 (B5234FS), 2.3T (B5234T3, B5234T7, B5234T9), 2.4 (B5244S, B5244S2, B5244S4, B5244S5, B5244S7), 2.4T (B5244T, B5244T3, B5244T4, B5244T5, B5244T7), 2.5R (B5254FS), 2.4D (D5244T9, D5244T8, D5244T13)

**DESCRIPTION**

For adjusting the camshaft and crankshaft when replacing the cylinder head seal

**DELIVERY SCOPE**

- Crankshaft pulley holding tool, use as OEM 999 5433, 303-1179
- Camshaft alignment tool, use as OEM 303-1178
- Crankshaft alignment tool, use as OEM 303-1182
- Camshaft holder, use as OEM 303-1183

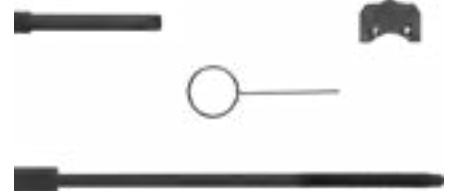

ART.NR	ITEM NAME	PRICE
<b>BT593130</b>	Engine adjustment tool set for Hyundai, Mitsubishi	<b>21,00 €</b>

**FOR THE FOLLOWING MODELS**

Hyundai 1.6, 1.8, 2.0, 2.4 DOHC and Mitsubishi 1.8 to 3.5 16V and V6

Mitsubishi Colt (1989, 1995), Lancer (1989, 1995), Carisma (1996, 2005), Galant (1993, 2003), Sigma (1991, 1996), Eclipse (1991, 1995), 3000DTG (1993, 2000), Space Star (1999, 2006) with engines 1.8 16V GDI (4G63, 4G94), 2.0 16V GDI (4G63, 4G94, 6A12), 2.4 GDI (4G64, 4G69), 3.5 GDI V6 (6G74), 2.5 V6 (6G73, 6a13), 3.0 V6 (6G72)

Hyundai Lantra (1991, 1996), Sonata (1993, 2001), Trajet (2000, 2005), Santa Fe 6.1 with engine G4-N, G4-CP, 4JP, G4-P-, G4-R-, G4-JS

**DESCRIPTION**

Contains important tools for checking the engine control and replacing the toothed belt



ART.NR	ITEM NAME	PRICE
<b>BT593029</b>	Crankshaft locking pin for Ford Zetec, Duratec engines	<b>5,00 €</b>

**DESCRIPTION**

Suitable for Ford Zetec SE and Duratec 1.25, 1.4, 1.6l engines, installed in the Fiesta, Fusion and Focus



**FITS FOR:**

**FITS FOR:**

ART.NR	ITEM NAME	PRICE
<b>BT597940</b>	Engine adjustment tool set for Peugeot, Citroën, PSA	<b>89,00 €</b>

ART.NR	ITEM NAME	PRICE
<b>BT593160</b>	Engine adjustment tool set for Jaguar, Land Rover; Ford, Citroën 2.0, 2.2, 2.4, 3.2 diesel	<b>105,00 €</b>

**FOR THE FOLLOWING MODELS**

Citroën AX, Berlingo, BX, C5, C15, C25, Dispatch, Evasion, Jumper, Jumpy, Relay, Saxo, Synergie, Visa, Xsara, Xantia, XM, XJR, ZX, etc.

Peugeot 106, 205, 306, 405, 406, 605, 806, J5, Boxer, Expert, Partner, Solara, Talbot Express, Talbot Horizon, etc.

PSA petrol engines 1.9, 1.1, 1.4, 1.6, 1.8, 1.9, 2.0, 1.6, 1.8, 2.0, 2.2 16V (turbo and dual camshafts)

PSA diesel engines 1.4, 1.5, 1.7, 1.8, 1.9, 2.1, 2.5 D, TD, TDI, 1.4, 1.6, 2.0, 2.2 HDI

Suitable for structurally identical engines in Fiat, Ford, Nissan, Renault, Rover, Toyota, etc.

**FOR THE FOLLOWING MODELS**

Ford Mondeo (2000 - 2007), Transit (2000 - 2011)

Citroen Relay (2006 - 2011), Jumper III

Fiat Ducato (2006 - 2011)

Jaguar X-Type (2001 - 2010)

Land Rover Defender (2007 - 2011)

Peugeot Boxer III (2006 - 2011)

LDV Convoy (2002 - 2006)

with DURATORQ (PUMA) diesel engines

**DESCRIPTION**

For checking and adjusting the engine timing

**ENGINE CODES**

2.0L engine code ABFA, D3FA, D5BA, D6BA, F3FA, F1FA, FMBA, HJBA, HJBB, HJBC, HJBE, N7BA, N7BB

2.2L (with chain-driven high-pressure pump), engine code QJBA (BG), QJBB, QJBC, QJBD

2.2L (high-pressure pump driven via camshaft), engine code 4HM, 4HU, 4HV, P8FA, P22DTE, QVFA, QWFA

2.4L with engine code 244DT, DOFA, D2FA, D2FB, D4FA, F4FA, FXFA, H9FA, H9FB, HE FA, HFFA, JXFA, PHFA, ZSD 424

3.2L with engine code SAFA (timing only)

**DELIVERY SCOPE**

- Flywheel adjustment pin with spring, use as OEM 0188X, 0189X
- Tensioning spanner, 8 mm, use as OEM 7017-TW
- Flywheel fixing mandrel, 7 mm, use as OEM 7017-TR
- Angled adjustment pin, 8 mm, use as OEM 0188D, 7004TG, 9767-34, 0153G, 7014-TJ, 1 860 863 000, 0153N
- Clamping tool, use as OEM 4507-TJ, 9767.89, 0188Q1, 0132X1Z, 0132X
- Camshaft marking mandrel, use as OEM 0189A, 1 871 008 100
- Hdi tension roller lever, use as OEM 0188J2
- Tension roller lever, use as OEM 5711-TE, 0178E, 0188J1
- Flywheel disc extractor, use as OEM 0174.0188P, 018892, 7015-T
- Toothed belt retaining clamp, use as OEM 0189K, MOT1436, 4533-TAX, 0188K, 0187J, 0132AK, 0153AK, 1 870 00 100
- Flywheel retainer, use as OEM 0195K, 4507-TL
- Clamping tool, use as OEM 0189S1
- Flywheel retainer, use as OEM 1867030000, 0153A, 9765.54, 6012T, 1860161000
- Tension lever, use as OEM 0189S2
- Angled locking pin, 5 mm

- Flywheel fixing mandrel (for automatic transmission), use as OEM 0189R
- Camshaft marking mandrel, use as OEM 0189AZ
- Crankshaft retainer, use as OEM 0288D, 0188Y, 7014
- Flywheel fixing mandrel (manual transmission), use as OEM 0189C
- Flywheel interlock, use as OEM 0188F, 0134Q, 1870765001.1870827000, 0134AF, 9044-T, 1871000400
- Camshaft marking mandrel (CA1), use as OEM 4533-TAC1, 0132AJ1
- Camshaft and crankshaft retainer, use as OEM 0188M, 0187B, 0194B, 303-1277, MOT1430, 0189B, 303-735, 49JED1061, 21-263
- Camshaft marking mandrel (CA2), use as OEM 0132AJ2, 2000023000, 0188M, 4533-TAC2
- Marking mandrel for injection pump, use as OEM 4527-TS1
- Injection pump fixing mandrel, use as OEM 0188H, 1 860 965 000
- Flywheel fixing mandrel, use as OEM 49JED2020, 0194C, 21-262, 999-7121, 999-7169, 303-734
- 2 camshaft and crankshaft marking mandrels, use as OEM 4507-TB.7014-TN, 0132-R, 0153-AB, 0158-G
- 2 camshaft and crankshaft interlocks, use as OEM KM-955, 7014-TM
- 2 camshaft marking mandrels, use as OEM 9041-TZ, 5711-TC
- 2 crankshaft fixing mandrels, use as OEM 5711-TD, 119790, 0194A, 1860617000, 303-732, 07744-00104-00, 49JED2018, 0178D, 9997169, 4527-TS2, 21-260, 999-7169, 0132AB
- Camshaft fixing mandrel, use as OEM 0189L
- Screw M8 x 80 mm
- Pin for clamping device, 3 mm, use as OEM 0153AL, 4200TA
- Centring clip for crankshaft pulley, use as OEM 0188AH
- Crankshaft marking mandrel, 6 mm, use as OEM 4507-TA, 0132Z, 0132QZ

**DESCRIPTION**

For checking and adjusting the engine timing

Needed e.g. when working on the valve train and replacing the cylinder head seal

**DELIVERY SCOPE**

- Engine cover adjustment tool, use as OEM 303-682
- Tool for engine cover/crankshaft radial sealing ring, use as OEM 303-679A
- High-pressure pump wheel holding tool, use as OEM 303-1151
- High-pressure pump wheel disassembly tool, use as OEM 303-249
- Flywheel locking bolt, use as OEM 303-675
- Flywheel locking bolt, use as OEM 303-698
- Locking pin set, 3 pcs, 6 mm
- Tensioner locking pin, 2 mm

# IVECO



ART.NR	ITEM NAME	PRICE
<b>BT592520</b>	Engine adjustment tool set for Fiat Ducato, Peugeot Boxer, Citroën Jumper 2.3 D JTD, 3.0 JTD, HDi	<b>50,00 €</b>

#### FOR THE FOLLOWING MODELS

Citroen Relay/Jumper III  
Fiat Ducato  
Iveco Daily (03-10), Daily/EcoDaily (2009-2011)  
Peugeot Boxer III (2006-2012)  
2.3D, 2.3 JTD F1AE0418A, F1AE0481B, F1AE0481C, F1AE0418D, F1AE0481F, F1AE0481FA, F1AE0481G, F1AE0481H, F1AE0481HA, F1AE0481N, F1AE-0481UA.F1AE0481VA

3.0JTD F1CE0481A, F1CE0481B, F1CE0481D, F1CE0481F, F1CE0481H, F1CE3481M  
3.0HDi F30DTE, F1CE0481D, F1CE3481DM, F1CE3481N

#### DESCRIPTION

Use as OEM Fiat 99360187, 99360614, 99360615, 1860617000, 1860815000, 20000180200, Citroën/Peugeot 0191-2A, 0191-2B, 0191-2J, 0191-2K

#### DELIVERY SCOPE

2 camshaft fixing mandrels  
1 crankshaft fixing mandrel



ART.NR	ITEM NAME	PRICE
<b>BT594460</b>	Engine adjustment tool set for PSA 2.5, 2.8 l diesel	<b>12,00 €</b>

#### FOR THE FOLLOWING MODELS

Citroen, Peugeot, Fiat, Iveco Traffic (1980-2000), Master (1980-2007), Mascot (1999-2007)  
Fiat, PSA, Renault Daily (1991-2005), Turbo Daily (1994-2000), Relay, Jumper (2001-2002) Boxer (2000-2006), Arena (1997-2001), Movano (1998-2003)

#### DESCRIPTION

Use as OEM Fiat 1 870 667 000, 1 870 765 001, 1 860 617 000, Renault: MOT861, MOT1054, MOT863, Opel KM6031, Ford 21-260, 303-732, Peugeot 0132AB, 5711TD, 4527TS2, 0178D, 0194A, 119790, Citroen 0132AB, 5711TD, 4527TS2, 0178D, 0194A, 119790, Mazda 49 JE 02018, 0991246510, Volvo 999-7169

#### DELIVERY SCOPE

2 locking bolts  
Flywheel locking bolt  
Holding tool for toothed belt tensioner



ART.NR	ITEM NAME	PRICE
<b>BT541062</b>	Crankshaft turning tool for Iveco	<b>99,00 €</b>

#### FOR THE FOLLOWING MODELS

Euro Cargo, Cargo 150E27R PR, FPR, 320E27T, PT Euro Tech, Eurostar

#### ENGINE CODES

Engine code: 8360.46/F3A/F3B

#### DESCRIPTION

For turning the crankshaft when adjusting the engine or carrying out other repairs  
Attached to the transmission bell housing and engages in the starter sprocket

#### DELIVERY SCOPE

Crankshaft lathe tool, use as OEM 99360321



ART.NR	ITEM NAME	PRICE
<b>BT596002</b>	Universal camshaft wheel puller	<b>63,00 €</b>

#### DESCRIPTION

For pulling the pulley and camshaft gear  
Gripping arms are connected with each other via adjusting disk, thus the gripping arms can be set easily and exactly  
Continuous adjustment range of the gripping arms start from 42 – 82 mm  
Gripping arm depth is 27 mm

#### DELIVERY SCOPE

3 x gripping arms, Ø 12 mm, M10 x 1.5, suitable for material thickness up to max. 10 mm  
6-groove puller body with adjusting disc  
Spindle, M14 x 1.5, 19 mm hex, with centring cone





**HERE YOUR PROJECTS ARE IN  
THE BEST HANDS**

# JAGUAR



FITS FOR:

ART.NR	ITEM NAME	PRICE
<b>BT593300</b>	Crankshaft pulley tool set I for Jaguar, Land Rover	<b>99,00 €</b>

DESCRIPTION
Non-destructive removal and fitting of the crankshaft pulley
Needed when working on the camshaft drive
Crankshaft pulley counter support, use as OEM 303-893
2 fastening screws, use as OEM 303-588

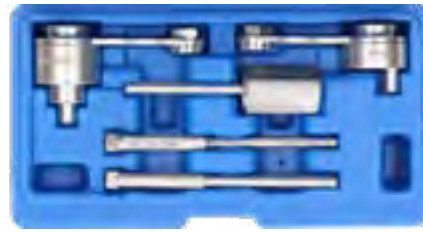

FITS FOR:

ART.NR	ITEM NAME	PRICE
<b>BT593150</b>	Engine adjustment tool set for Land Rover, Jaguar 2.7	<b>34,00 €</b>

FOR THE FOLLOWING MODELS
Jaguar S-Type TDVi (2004, 2009)
Land Rover TDV6 Discovery
Range Rover Sport TDV6 (2004, 2006)

ENGINE CODES
Engine code: 276DT

DESCRIPTION
For adjusting and checking the engine timing
Needed when working on the valve train and replacing the cylinder head seal

DELIVERY SCOPE
Flywheel interlock (manual tension roller), use as OEM 303-1116
Flywheel interlock (automatic tension roller), use as OEM 303-1117
Camshaft wheel adjustment tool, use as OEM 303-1132
Camshaft wheel adjustment pin, 2 pieces, use as OEM 303-1126 (PSA 0195H)

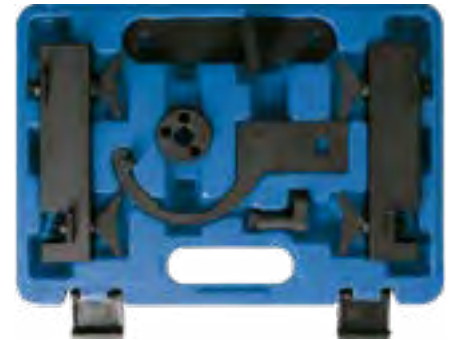

FITS FOR:

ART.NR	ITEM NAME	PRICE
<b>BT593190</b>	Engine adjustment tool set for Jaguar, Land Rover 5.0 V8	<b>189,00 €</b>

FOR THE FOLLOWING MODELS
Suitable for the following models with a 5L V8 engine: X150-XK (10MY), X250-XF (10MY), X351-XJ (10MY)

DESCRIPTION
For adjusting and checking the engine timing
Needed when working on the valve train and replacing the cylinder head seal

DELIVERY SCOPE
Camshaft adjustment tool, use as OEM 303-1445
Crankshaft locking bolt, use as OEM 303-1447
Flywheel locking tool, use as OEM 303-1448
Crankshaft turning tool, use as OEM 303-1452
Timing chain tensioning tool, use as OEM 303-1482

**1 - 200 Nm**

**BT141901...905**

Torque wrench with rotary mushroom ratchet head



**2K**

9x12 mm	1/4" - 1/2"	
14x18 mm	1/4" - 1"	

from **79,- €**



BT No.	"	Nm	EAN 4042146+	€
BT141905	1/4	1 - 25	865569	79,00
BT141903	3/8	5 - 50	863749	79,00
BT141904	1/2	10 - 100	863756	79,00
BT141901	1/2	20 - 200	813140	79,00
BT141902	1/2	40 - 200	863633	89,00





ART.NR	ITEM NAME	PRICE
<b>BT593160</b>	Engine adjustment tool set for Jaguar, Land Rover, Ford, Citroën 2.0, 2.2, 2.4, 3.2 diesel	<b>105,00 €</b>

**FOR THE FOLLOWING MODELS**

Ford Mondeo (2000 - 2007), Transit (2000 - 2011)
Citroen Relay (2006 - 2011), Jumper III
Fiat Ducato (2006 - 2011)
Jaguar X-Type (2001 - 2010)
Land Rover Defender (2007 - 2011)
Peugeot Boxer III (2006 - 2011)
LDV Convooy (2002 - 2006)
with DURATORQ (PUMA) diesel engines

**ENGINE CODES**

2.0L engine code ABFA, D3FA, D5BA, D6BA, F3FA, F1FA, FMBA, HJBA, HJBB, HJBC, HJBE, N7BA, N7BB
2.2L (with chain-driven high-pressure pump), engine code QJBA (BG), QJBB, QJBC, QJBD
2.2L (high-pressure pump driven via camshaft), engine code 4HM, 4HU, 4HV, P8FA, P22DTE, QVFA, QWFA
2.4L with engine code 244DT, DOFA, D2FA, D2FB, D4FA, F4FA, FXFA, H9FA, H9FB, HE FA, HFFA, JXFA, PHFA, ZSD 424
3.2L with engine code SAFA (timing only)

**DESCRIPTION**

For checking and adjusting the engine timing
Needed e.g. when working on the valve train and replacing the cylinder head seal

**DELIVERY SCOPE**

Engine cover adjustment tool, use as OEM 303-682
Tool for engine cover/crankshaft radial sealing ring, use as OEM 303-679A
High-pressure pump wheel holding tool, use as OEM 303-1151
High-pressure pump wheel disassembly tool, use as OEM 303-249
Flywheel locking bolt, use as OEM 303-675
Flywheel locking bolt, use as OEM 303-698
Locking pin set, 3 pcs, 6 mm
Tensioner locking pin, 2 mm



ART.NR	ITEM NAME	PRICE
<b>BT593180</b>	Engine adjustment tool set for Jaguar, Land Rover 2.7, 3.0 TD V6	<b>67,00 €</b>

**FOR THE FOLLOWING MODELS**

Citroen C5 III (2007 - 2009), C6 (2005 - 2009)
Jaguar S-Type (2004 - 2008), XF (2008 - 2012), XJ (2010 - 2012), XJ6 (2005 - 2010)
Range Rover Sport (2005 - 2009)
Peugeot 407 (2004 - 2009), 407 Coupe (2006 - 2009), 607 (2004 - 2011) 2.7TD V6, TDVi (276DT) 2.7D HDi (DT17BTEd4) (UHZ) 3.0D HDi (D20CTED4) (X8Z) 3.0D SD V6, TD V6 (306DT) (AJ-V6D)

**DESCRIPTION**

For checking and adjusting the engine timing
Needed e.g. when working on the valve train and replacing the cylinder head seal

**DELIVERY SCOPE**

Flywheel interlock (manual), use as OEM (Rover) 303-1116
Flywheel interlock (automatic), use as OEM (Rover) 303-1117
Camshaft sprocket adjustment pin, use as OEM (Rover) 303-1132
Camshaft sprocket adjustment pin, 2 pcs, use as OEM (Rover) 303-1126, (PSA) 0195H
Water pump locking pin, use as OEM (PSA) 0195-C
Flywheel locking tool, use as OEM (PSA) 0195-K
Toothed belt retaining clip, use as OEM (PSA) 0188-K

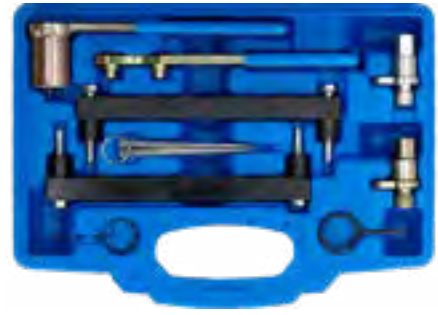

ART.NR	ITEM NAME	PRICE
<b>BT593250</b>	Engine adjustment tool set for Land Rover, Jaguar V8	<b>85,00 €</b>

**FOR THE FOLLOWING MODELS**

Suitable for 3.2 3.5 4.0 4.2 4.4L engines in the following models: Jaguar XJ8 (1997, 2009), engine AJ26 AC, BC, LC, 1B, 5G, SB, Jaguar XJR (1997, 2009), engine AJ27 KB, CC, MA, 2B, 9G, TB, Jaguar S-Type (1999, 2008), engine AJ28 KC, CE, MB, 3B, HB, PC, Jaguar XF (2008, 2009), engine AJ34 3.5, DC, NB, 1G, HG, Jaguar XK8 (1997, 2009), engine RB, EC, NC, Jaguar XKR (1998, 2009), engine GB, PA, Range Rover (2006, 2009), 4.2L engine (428PS), Range Rover (2005, 2009), 4.2L engine (428PS), Land Rover Discovery III (2005, 2009)

**DESCRIPTION**

For adjusting and checking the engine timing
Needed e.g. when working on the valve train and replacing the cylinder head seal

**DELIVERY SCOPE**

Flywheel locking bolt (silver), use as OEM 303-531
Flywheel locking bolt (gold), use as OEM 303-645
2 camshaft adjustments plate, use as OEM 303-530
Camshaft sprocket holding tool, use as OEM 303-532
2 wedges, use as OEM 303-533
Primary tensioner locking pin, use as OEM T40011
Adjustment tool for VVT unit, use as OEM 303-654
Tensioner locking pin

**ALWAYS UP-TO-DATE:**  
[WWW.BRILLIANT-TOOLS.COM/NEWSLETTER](http://WWW.BRILLIANT-TOOLS.COM/NEWSLETTER)



**REGISTER FOR THE NEWSLETTER NOW!**

**JEEP**



FITS FOR: **Jeep**

ART.NR	ITEM NAME	PRICE
<b>BT593310</b>	Engine adjustment tool set for Jeep 3.0 V6 diesel	<b>76,00 €</b>

**FOR THE FOLLOWING MODELS**

Jeep Grand Cherokee 3.0 V6 CRD (2011, 2015), engine code: EXF VM23D

Jeep Grand Cherokee 3.0 Multijet (2011, 2015), engine code: EXF VM44D

**DESCRIPTION**

For adjusting the engine timing when replacing the timing chain or the cylinder head seal

**DELIVERY SCOPE**

Camshaft locking tool for the right cylinder head, use as OEM VM10338-1

Camshaft locking tool for the left cylinder head, use as OEM VM10338-2

Chain tensioner locking pin, use as OEM VM1039a

Crankshaft locking pin, use as OEM VM10339



FITS FOR: **Jeep** 

ART.NR	ITEM NAME	PRICE
<b>BT593670</b>	Engine adjustment tool set for Chrysler, Jeep, Dodge 2.8l Diesel	<b>54,00 €</b>

**FOR THE FOLLOWING MODELS**

Grand Voyager

Jeep Cherokee

Wrangler

Dodge Nitro

**ENGINE CODES**

Engine codes: VM64C, ENS, ENS (51C), 49C, 50C, ENS VM10D, ENS VM11D

**DESCRIPTION**

For checking and adjusting the engine timing

**DELIVERY SCOPE**

Camshaft locking tool, use as OEM VM9991

Crankshaft locking tool, use as OEM VM9992



FITS FOR: **Jeep** 

ART.NR	ITEM NAME	PRICE
<b>BT593890</b>	Engine adjustment tool set for Chrysler 2.5 CRD	<b>54,00 €</b>

**FOR THE FOLLOWING MODELS**

Chrysler Voyager, Grand Voyager R2516C, R2516L, R2816K engines

Jeep Cherokee (year of construction 2001, 2008) 2.5, 2.8 engines

LDV Maxus (year of construction 2005, 2008) VM2516L engines

**DESCRIPTION**

For checking and adjusting the engine timing

**DELIVERY SCOPE**

Camshaft locking pin (intake), use as OEM VM1052

Camshaft locking pin (exhaust), use as OEM VM1053

Flywheel locking pin (Voyager, Grand Voyager 2.5, 2.8 and LDV Maxus), use as OEM VM1068, VM1089

Flywheel locking pin (Jeep Cherokee 2.8), use as OEM VM1080

Flywheel locking pin (Jeep Cherokee 2.5), use as OEM VM8873

Tensioning spanner, use as OEM VM9660

Balance shaft locking pin

Flywheel locking pin

**BT521300**  
**EAN 4042146778845**

**water pump removal tool for Volkswagen**

**3**  
pcs.

**Volkswagen T5 | Touareg 2,5 L Diesel**



**59,- €**



# GREAT PERFORMANCE IS ALSO AVAILABLE FOR A SMALL PRICE!



**LANCIA**



FITS FOR:



ART.NR	ITEM NAME	PRICE
<b>BT592700</b>	Engine adjustment tool set for Alfa Romeo, Fiat 1.4 MultiAir	<b>69,00 €</b>

**FOR THE FOLLOWING MODELS**

Alfa Romeo Giulietta, Mito, Fiat Punto, Punto Evo 1.4 (Turbo) MultiAir (105/135/163/170PS)

Engine codes: 940A2.000, 940A2.000, 955A8.000, 955A8.000, 940A2.000, 955A8.000, 955A2.000, 955A7.000, 955A6.000, 955A8.000

**DESCRIPTION**

For adjusting the engine timing when replacing the toothed belt

**DELIVERY SCOPE**

Camshaft adjustment tool including 3 fastening screws, use as OEM 2000034400

Crankshaft locking tool including 4 fastening screws, use as OEM 2000004500

Tension roller key, use as OEM 1860987000

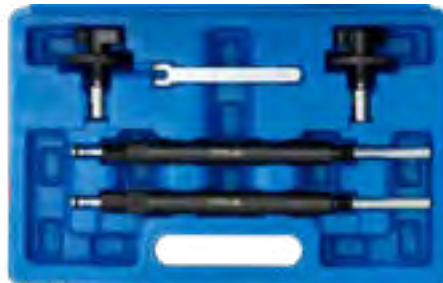

FITS FOR:



ART.NR	ITEM NAME	PRICE
<b>BT592600</b>	Engine adjustment tool set for Fiat 1.2 16V	<b>49,00 €</b>

**FOR THE FOLLOWING MODELS**

Fiat 500 1.2 (2007), Brava 1.2, Bravo 1.2 16V (1995-2002), Grande Punto 1.2, Idea 1.2, Idea 1.2 16V, Mareta 1.2, Marea Weekend, Marengo 1.2, Palio Weekend 1.2 16V (1993-1999), Punto 1.2 (1993-1999), Punto Classic 1.2 16V (1999), Stilo 1.2

Lancia Ypsilon 1.2 16V (1996 - 2003)

**ENGINE CODES**

Engine codes: 176B9.000, 169A4.000, 182B2.000, 188A5.000

**DESCRIPTION**

For checking and adjusting the engine timing

**DELIVERY SCOPE**

Measurement adapter for piston height (2 x), use as OEM 1860992000

Camshaft adjustment tools (2 x), use as OEM 1860985000

Tension roller key, use as OEM 1860987000



FITS FOR:



ART.NR	ITEM NAME	PRICE
<b>BT591310</b>	Engine adjustment tool set for Alfa Romeo, Lancia, Fiat 0.9	<b>33,00 €</b>

**FOR THE FOLLOWING MODELS**

Alfa Romeo Mito from 2012 onwards

Fiat 500 from 2010 onwards

Fiat Panda from 2012 onwards

Fiat Punto from 2012 onwards

Lancia Ypsilon from 2012 onwards

**DESCRIPTION**

For adjusting the engine timing, e.g. when replacing the timing chain, repairing the cylinder head, etc.

**DELIVERY SCOPE**

Crankshaft locking mandrel, use as OEM 2000035300

Pulley locking mandrel, use as OEM 2000035200

Camshaft interlock plate, use as OEM 2000035100



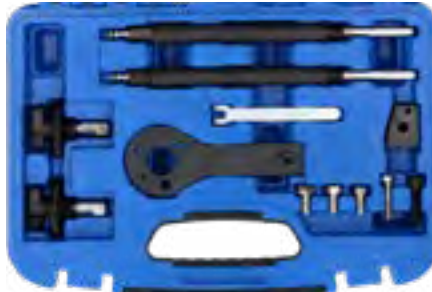

**FITS FOR:**

ART.NR	ITEM NAME	PRICE
<b>BT592570</b>	Engine adjustment tool set for Fiat 1.4 12V	<b>46,00 €</b>

**FOR THE FOLLOWING MODELS**

Fiat: Brava, Bravo, Marea, Weekend  
Lancia Ypsilon

**ENGINE CODES**

Engine code: 182 A3.000, 182 A5.000

**DESCRIPTION**

For checking and adjusting the engine timing

**DELIVERY SCOPE**

Camshaft adjustment tool, use as OEM 1860899000  
Crankshaft adjustment tool, use as OEM 1860901000  
Pin for crankshaft adjustment tool, use as OEM 1860901000

**FITS FOR:**

ART.NR	ITEM NAME	PRICE
<b>BT591320</b>	Engine adjustment tool set for Fiat, Alfa Romeo, Lancia 1.2 16V, 1.4 16V, T-Jet	<b>35,00 €</b>

**FOR THE FOLLOWING MODELS**

Adjustment tool for piston height, use as OEM 1.860.992.000

**DESCRIPTION**

For adjusting engine timing when replacing the toothed belt, repairing the cylinder head, replacing the cylinder head seal, etc.

Suitable for Alfa Romeo, Fiat and Lancia 1.2 16V, 1.4 16V, 1.4 T-Jet

Engine codes e.g. 169A3000, 179B9000, 182B2000, 188A5000, 192B2000, 198A1000, 198A4000, 199A6000, 199A8000, 843A1000

**DELIVERY SCOPE**

Crankshaft interlock (with screws M6x30 and 3 pcs M8x16), use as OEM 2.000.004.500  
Camshaft adjustment tools (1 pair), use as OEM 1.860.985.000  
Adjustment tool for piston height, use as OEM 1.860.992.000  
Adjustment spanner for toothed belt tensioner, use as OEM 1.860.987.000  
Interlock tool for camshaft sprockets (with M8x30 screw), use as OEM 2.000.015.800

**FITS FOR:**

ART.NR	ITEM NAME	PRICE
<b>BT591350</b>	Engine adjustment tool set for Fiat, Lancia, Alfa Romeo	<b>249,00 €</b>

**FOR THE FOLLOWING MODELS**

Alfa Romeo 145 1.4, 1.6 16V Step A – 146 1.4, 1.6 16V Step A – 147 1.6 16V Step A – 147 105 PS – 147 1.6 eco 103 PS – 155 1.4, 1.6 16V Step A – 156 1.6 16V Step A – 156 1.8, 2.0 16V – 156 2.0 JTS – 166 2.0 – GTV 2.0 JTS – Spider GT 2.0 JTS 16V 165 PS

Lancia K5 2.0 20V, 4-cylinder, VIS engines from year of construction 1996 onwards, Delta 1.8 16V Step A, Dedra 1.8 16V Step A, Y10 1.4 12V

Fiat Bravo 1.4 12V, 2.0 20V – Brava 1.4 12V, 2.0 20V – Marea 2.0 20V, Coupe 1.8 16V, Barchetta 1.8 16V, Punto 1.8 16V

**DESCRIPTION**

Special insert, drive square socket 12.5 mm (1/2") for dismantling the phaser  
23 precisely fitting locking devices for the feed and discharge camshaft  
prevent the camshafts from twisting after assembly and position them in assembly position for the toothed belt.  
The locking devices are labelled with numbers and additionally colour-coded to avoid confusion  
The OT point adjustment mandrel and a micrometer clock (not scope of delivery) makes a precise alignment of the crankshaft possible

**DELIVERY SCOPE**

Cam shaft locking devices, use as OEM 1 825 041 000, 1 825 042 000, 1 860 096 100, 1 860 819 000, 1 860 847 000, 1 860 892 000, 1 860 899 000, 1 870 797 000  
Bracket for dial gauge for adjusting the piston OT (requires dial gauge), use as 1 860 895 000, 1 895 879 000, 1 825 013 000  
Insert for phaser, use as OEM 1 822 110 000, 1 852 161 000

**OUR IDEA IS BRILLIANT:  
AN ASSORTMENT FULL  
OF TOP SELLERS**



FITS FOR:

ART.NR	ITEM NAME	PRICE
<b>BT592800</b>	Engine adjustment tool set for Fiat, Lancia	<b>149,00 €</b>

**DESCRIPTION**

For checking and adjusting the engine timing  
 Locking the flywheel  
 Locking the crankshaft  
 Locking the camshaft  
 Locking the injection pump shaft  
 Removing the crankshaft pulley

**DELIVERY SCOPE**

Locking the flywheel  
 Locking the crankshaft  
 Locking the camshaft  
 Locking the injection pump shaft  
 Removing the crankshaft pulley  
 Tensioning the toothed belt



FITS FOR:

ART.NR	ITEM NAME	PRICE
<b>BT592660</b>	Camshaft interlock tool for Fiat, Alfa, Lancia	<b>12,00 €</b>

**DESCRIPTION**

Suitable for Fiat DOHC 1.6L 12V/16V petrol engines, installed in the Fiat models Brava, Bravo, Coupe, Marea, StiloWeekend, Multipla, Palio



FITS FOR:

ART.NR	ITEM NAME	PRICE
<b>BT592801</b>	Tensioning spanner for Fiat	<b>6,00 €</b>



FITS FOR:

ART.NR	ITEM NAME	PRICE
<b>BT591245</b>	Camshaft locking tool set for Alfa Romeo, Lancia 3.0 V6 24V	<b>34,00 €</b>

**FOR THE FOLLOWING MODELS**

Alfa Romeo, Lancia 3.0L V6 24V

**DESCRIPTION**

For checking and adjusting the camshaft timing  
 Use as OEM 1825040000

**DELIVERY SCOPE**

Camshaft adjustment tool for intake cam 1-cylinder  
 Camshaft adjustment tool for exhaust cam 1-cylinder  
 Camshaft adjustment tool for intake cam 6-cylinder  
 Camshaft adjustment tool for exhaust cam 4-cylinder



FITS FOR:

ART.NR	ITEM NAME	PRICE
<b>BT592575</b>	Camshaft locking block for Fiat, Lancia 1.4 12V	<b>12,00 €</b>

**FOR THE FOLLOWING MODELS**

Fiat Bravo, Brava, Lancia Y10 1.4 12V

**ENGINE CODES**

Engine code: 182A3.000, 182A5.000

**DESCRIPTION**

For locking the camshafts when adjusting the engine timing  
 Use as OEM 1860899000



FITS FOR:

ART.NR	ITEM NAME	PRICE
BT591280	Camshaft locking tool set for Lancia 2.0 VIS 4 cylinder	20,00 €

**FOR THE FOLLOWING MODELS**  
Lancia Kappa 2.0. 2.4 20V (1994, 1997)

**DESCRIPTION**  
For adjusting and checking the engine timing  
Use as OEM 1860819000

**DELIVERY SCOPE**  
Camshaft adjustment tool for intake cam 3-cylinder  
Camshaft adjustment tool for exhaust cam 2-cylinder



FITS FOR:

ART.NR	ITEM NAME	PRICE
BT591225	Camshaft locking tool set for Fiat, Lancia 1.8l 130 PS	17,00 €

**FOR THE FOLLOWING MODELS**  
Fiat, Lancia 1.8L 16V 130PS

**DESCRIPTION**  
For checking and adjusting the camshaft timing  
Use as OEM 1860847000

**DELIVERY SCOPE**  
Camshaft adjustment tool for intake cam 2-cylinder  
Camshaft adjustment tool for exhaust cam 3-cylinder



FITS FOR:

ART.NR	ITEM NAME	PRICE
BT592590	Camshaft locking tool set for Fiat, Lancia 1.8 16V	17,00 €

**FOR THE FOLLOWING MODELS**  
Fiat Coupe, Barchetta, Punto (HGT), Barchetta (HGT)  
Lancia Delta, Dedra Step "A"

**DESCRIPTION**  
For checking and adjusting the engine timing  
Use as OEM 1870697000

**DELIVERY SCOPE**  
Camshaft adjustment tool for intake cam 2-cylinder  
Camshaft adjustment tool for exhaust cam 3-cylinder



FITS FOR:

ART.NR	ITEM NAME	PRICE
BT591270	Camshaft locking tool set for Lancia 2.4 20V	17,00 €

**FOR THE FOLLOWING MODELS**  
Lancia 2.4L 20V 5-cylinder (up until 1996)

**DESCRIPTION**  
For adjusting and checking the engine timing  
Use as OEM 1860818000

**DELIVERY SCOPE**  
Camshaft adjustment tool for intake cam 3-cylinder  
Camshaft adjustment tool for exhaust cam 2-cylinder



FITS FOR:

ART.NR	ITEM NAME	PRICE
BT592585	Camshaft locking tool set for Fiat, Lancia 1.8, 115 PS	17,00 €

**FOR THE FOLLOWING MODELS**  
Fiat Bravo, Brava, Marea 1800 16V, 115 PS  
Lancia Delta, Dedra 1800 16V, 115 PS

**DESCRIPTION**  
For checking and adjusting the engine timing  
Use as OEM 1860875000

**DELIVERY SCOPE**  
Camshaft adjustment tool for intake cam 2-cylinder  
Camshaft adjustment tool for exhaust cam 3-cylinder



FITS FOR:

ART.NR	ITEM NAME	PRICE
BT591275	Camshaft locking tool set for Lancia K 2.0l 20V	20,00 €

**FOR THE FOLLOWING MODELS**  
Lancia 2.0L 20V 5-cylinder VIS (from 1996 onwards)

**DESCRIPTION**  
For adjusting and checking the engine timing  
Use as OEM 1860961000

**DELIVERY SCOPE**  
Camshaft adjustment tool for intake cam 2-cylinder  
Camshaft adjustment tool for exhaust cam 3-cylinder

# LAND ROVER



FITS FOR:



ART.NR	ITEM NAME	PRICE
<b>BT592880</b>	Engine adjustment tool set for Rover, Peugeot, Ford, Volvo 2.0, 2.2i D	<b>12,00 €</b>

#### FOR THE FOLLOWING MODELS

Peugeot 807 (2005, 2011), 407 (2005, 2011), 607 (2005, 2009), engine DW10UTED4 (RHK), DW10BTED4 (RHR)DW12BTED4 (4HS), (4HP), (4HT), (4HR)  
Citroën C4 (2004, 2010), C5 II (2004, 2010), engine DW10BTED4 (RHR)  
Land Rover Freelander (2006, 2010), engine DW12BTED4, 224DT  
Volvo S40 (2003, 2010), V50 (2006, 2010), C70 (2006, 2010), S80 (2007, 2010), C30 (2006, 2010), V70 (2007, 2010), engine D420T 2.0D  
Ford S-Max 2.2 (2008, 2010), Galaxy 2.2 (2008, 2010), Mondeo 2.2, 2.0 (2007, 2010)

#### ENGINE CODES

Engine codes: GXBA(2.2), GXWA(2.0), GXBB(2.0), Q4BA(2.2), GXWA(2.0), GXWB(2.0), AZBA(2.0), AZBC(2.0), AZWA(2.0)

#### DESCRIPTION

Makes it easier to check and adjust the engine timing

#### DELIVERY SCOPE

Camshaft interlock, use as OEM PSA 0188.M, Ford 303-735, 303-1277, Volvo 999-7122  
Crankshaft interlock, use as OEM PSA 0188.X, Ford 303-1059, 303-1270, Volvo 999-7121  
Flywheel interlock, use as PSA 0188.F, Ford 303-393A, 303-393-01, 303-1272, Volvo 999-7119/7120



FITS FOR:



ART.NR	ITEM NAME	PRICE
<b>BT591650</b>	Engine adjustment tool set for BMW diesel engines	<b>129,00 €</b>

#### FOR THE FOLLOWING MODELS

BMW 1, 3, 5, 6, 7, X3, X 5 (series E34-36-38-39-66-83-90-91-92-93)  
Land Rover, Range Rover, Freelander  
Rover 75, MG, MG ZT  
Vauxhall, Opel Omega-B

#### ENGINE CODES

M41, M51, M47 M47 TU/T2, M57 TU/T2 2.0I/3.0I (1998-2008)  
204D3, Td4, Td 6  
M47R

#### DELIVERY SCOPE

Timing chain counter support, use as OEM BMW 113360, Range Rover LRT-12-115  
Camshaft alignment tool, use as OEM BMW 116321 (116320), Opel KM6267  
Securing bracket alignment tool, use as OEM BMW 116322 (116320)  
Injection pump extractor (long), use as OEM BMW 135120  
Injection pump extractor, use as OEM BMW 135120, Range Rover LRT-12-119  
Injection pump extractor (short), use as OEM BMW 135191, 135192 (135190), Opel KM6270  
Threaded ring, use as OEM BMW 135191, 135192 (135190), Opel KM6270  
Camshaft securing bridge, use as OEM BMW 113320, Rover LRT-12-112  
Crankshaft marking pin, use as OEM BMW 115180  
Crankshaft marking pin, use as OEM BMW 116080  
Tension roller marking pins, use as OEM BMW 113340, Range Rover LRT-12-114, Opel KM-823  
Crankshaft marking pin, use as OEM BMW 112300, Range Rover LRT-12-108



FITS FOR:



ART.NR	ITEM NAME	PRICE
<b>BT592320</b>	Balance shaft adjustment tool set for Land Rover, Citroën, Mitsubishi, Peugeot, Ford 2.2 DOHC diesel engines	<b>42,00 €</b>

#### FOR THE FOLLOWING MODELS

Land Rover Discovery, Discovery Sport, Freelander 2, eD4, TD4, TD4e (2009-2015) engine codes: 224DT, DW12CTED4/224DT, DW12BTED4/224DT  
Citroën C5, C5 II, C5 III, C6, C8, C-Crosser HDi (200-2015) engine codes: 4HX (DW12CTED4), 4HP (DW12BTED4), 4HX (DW12TED4), 4HW (DW12TED4/L4)  
Mitsubishi Outlander DI-D, DI-DC (2007-2013) engine codes: 4HK, 4HN  
Peugeot 4007, 407, 607, 807, 406, 508, 607, HDi, GT HDi (2000-2015) engine codes: DW12MTED4 (4HK), DW12MTED4 (4HN), DW12BTED4 (4HP), DW12BTED4 (4HR), DW12BTED4 (4HT), DW12TED4/L4 (4HW), DW12BTED4 (4HS), DW12ATED (4HZ), DW12ATED4 (4HX), DW12ATED (4HZ), DW12CTED4 (4HL)  
Ford Galaxy, Mondeo, S-Max, TDCI, TCI (2008-2015) engine codes: KNBB, KNBA, KNWA, Q4BA

#### DESCRIPTION

For adjusting the balance shaft

#### DELIVERY SCOPE

Balance shaft fixing tool, use as OEM 303-1329  
Balancing tool, use as OEM 303-1330  
Balance shaft adjustment tool, use as OEM 303-1328, 0190D





FITS FOR:



ART.NR	ITEM NAME	PRICE
<b>BT597940</b>	Engine adjustment tool set for Peugeot, Citroën, PSA	<b>89,00 €</b>

#### FOR THE FOLLOWING MODELS

Citroën AX, Berlingo, BX, C5, C15, C25, Dispatch, Evasion, Jumper, Jumpy, Relay, Saxo, Synergie, Visa, Xsara, Xantia, XM, XJR, ZX, etc.

Peugeot 106, 205, 306, 405, 406, 605, 806, J5, Boxer, Expert, Partner, Solara, Talbot Express, Talbot Horizon, etc.

PSA petrol engines 1.9, 1.1, 1.4, 1.6, 1.8, 1.9, 2.0, 1.6, 1.8, 2.0, 2.2 16V (turbo and dual camshafts)

PSA diesel engines 1.4, 1.5, 1.7, 1.8, 1.9, 2.1, 2.5 D, TD, TDI, 1.4, 1.6, 2.0, 2.2 HDI

Suitable for structurally identical engines in Fiat, Ford, Nissan, Renault, Rover, Toyota, etc.

#### DESCRIPTION

For checking and adjusting the engine timing

#### DELIVERY SCOPE

Flywheel adjustment pin with spring, use as OEM 0188X, 0189X

Tensioning spanner, 8 mm, use as OEM 7017-TW

Flywheel fixing mandrel, 7 mm, use as OEM 7017-TR

Angled adjustment pin, 8 mm, use as OEM 0188D, 7004TG, 9767-34, 0153G, 7014-TJ, 1 860 863 000, 0153N

Clamping tool, use as OEM 4507-TJ, 9767-89, 0188Q1, 0132X1Z, 0132X

Camshaft marking mandrel, use as OEM 0189A, 1 871 008 100

Hdi tension roller lever, use as OEM 0188J2

Tension roller lever, use as OEM 5711-TE, 0178E, 0188J/J1

Flywheel disc extractor, use as OEM 0174.0188P, 018892, 7015-T

Toothed belt retaining clamp, use as OEM 0189K, MOT1436, 4533-TAX, 0188K, 0187J, 0132AK, 0153AK, 1 870 00 100

Flywheel retainer, use as OEM 0195K, 4507-TL

Clamping tool, use as OEM 0189S1

Flywheel retainer, use as OEM 1867030000, 0153A, 9765.54, 6012T, 1860161000

Tension lever, use as OEM 0189S2

Angled locking pin, 5 mm

Flywheel fixing mandrel (for automatic transmission), use as OEM 0189R

Camshaft marking mandrel, use as OEM 0189AZ

Crankshaft retainer, use as OEM 0288D, 0188Y, 7014

Flywheel fixing mandrel (manual transmission), use as OEM 0189C

Flywheel interlock, use as OEM 0188F, 0134Q, 1870765001, 1870827000, 0134AF, 9044-T, 1871000400

Camshaft marking mandrel (CA1), use as OEM 4533-TAC1, 0132AJ1

Camshaft and crankshaft retainer, use as OEM 0188M, 0187B, 0194B, 303-1277, MOT1430, 0189B, 303-735, 49JE01061, 21-263

Camshaft marking mandrel (CA2), use as OEM 0132AJ2, 2000023000, 0188M, 4533-TAC2

Marking mandrel for injection pump, use as OEM 4527-TS1

Injection pump fixing mandrel, use as OEM 0188H, 1 860 965 000

Flywheel fixing mandrel, use as OEM 49JE02020, 0194C, 21-262, 999-7121, 999-7169, 303-734

2 camshaft and crankshaft marking mandrels, use as OEM 4507-TB, 7014-TN, 0132-R, 0153-AB, 0158-G

2 camshaft and crankshaft interlocks, use as OEM KM-955, 7014-TM

2 camshaft marking mandrels, use as OEM 9041-TZ, 5711-TC

2 crankshaft fixing mandrels, use as OEM 5711-TD, 119790, 0194A, 1860617000, 303-732, 07744-00104-00, 49JE02018, 0178D, 9997169, 4527-TS2, 21-260, 999-7169, 0132AB

Camshaft fixing mandrel, use as OEM 0189L

Screw M8 x 80 mm

Pin for clamping device, 3 mm, use as OEM 0153AL, 4200TA

Centring clip for crankshaft pulley, use as OEM 0188AH

Crankshaft marking mandrel, 6 mm, use as OEM 4507-TA, 0132Z, 0132QZ

FITS FOR:



ART.NR	ITEM NAME	PRICE
<b>BT593000</b>	Engine adjustment tool for Ford 1.8 TDDI, TDCI	<b>57,00 €</b>

#### FOR THE FOLLOWING MODELS

Ford C-MAX (2007-2010), Courier (2000-2002), Fiesta (2000-2002), Focus (1998-2011), Focus C-MAX (2003-2007), Galaxy (2006-2010), Mondeo (2007-2010), S-MAX (2006-2014), Tourneo Connect (2002-2013), Transit Connect (2002-2013)

#### ENGINE CODES

BHPA, F9DA, F9DB, FFBA, FFDA, FFWA, HCPA, HCPB, KHBA, KKDA, KKDB, P7PA, P9PA, P9PB, QYBA, QYWA, R2PA, R3PA, RWPA, RWPC, KHBA, BHDA, BHDB, BHPA, C9DA, C9DB, C9DC, RTN, RTP, RTQ

#### DESCRIPTION

For checking and adjusting the engine timing  
Use as OEM Ford 303-193 (21-104), 303-393 (21-168), 303-376 (21-162B), 303-652 (21-230), 310-095 (23-067)



FITS FOR:



ART.NR	ITEM NAME	PRICE
<b>BT593360</b>	Camshaft locking tool for Rover, MG	<b>4,00 €</b>

#### DESCRIPTION

Suitable for Rover and MG models



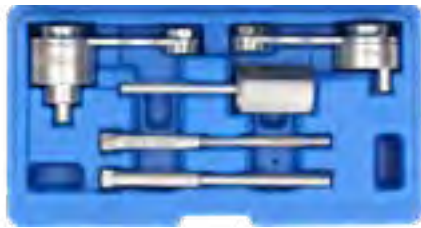

FITS FOR: **LAND-ROVER** **JAGUAR**

ART.NR	ITEM NAME	PRICE
<b>BT593150</b>	Engine adjustment tool set for Land Rover, Jaguar 2.7	<b>34,00 €</b>

**FOR THE FOLLOWING MODELS**

Jaguar S-Type TDVi (2004, 2009)  
Land Rover TDV6 Discovery  
Range Rover Sport TDV6 (2004, 2006)

**ENGINE CODES**

Engine code: 276DT

**DESCRIPTION**

For adjusting and checking the engine timing  
Needed when working on the valve train and replacing the cylinder head seal

**DELIVERY SCOPE**

Flywheel interlock (manual tension roller), use as OEM 303-1116  
Flywheel interlock (automatic tension roller), use as OEM 303-1117  
Camshaft wheel adjustment tool, use as OEM 303-1132  
Camshaft wheel adjustment pin, 2 pieces, use as OEM 303-1126 (PSA D195H)

FITS FOR: **CITROËN** **Ford** **HYUNDAI** **LAND-ROVER** **MAZDA** **SEAT** **SKODA** **SUBARU** **OPHEL** **Volvo** **VW** **Alfa Romeo** **Audi** **Chrysler**



ART.NR	ITEM NAME	PRICE
<b>BT591260</b>	Camshaft sprocket locking tool set, universal	<b>72,50 €</b>

**FOR THE FOLLOWING MODELS**

Can be used universally on vehicles from the following manufacturers: Audi, Alfa Romeo, Chrysler, Citroen, Ford, Honda, Hyundai, Isuzu, Land Rover, Lexus, Mazda, Mitsubishi, Peugeot, Renault, MG, Seat, Skoda, Subaru, Toyota, Opel, Volkswagen, Volvo

**DESCRIPTION**

For locking the camshaft sprockets e.g. when replacing the toothed belt  
Suitable for engines with 1, 2 and 4 camshafts (V engines); also suitable for locking between the camshaft sprocket and diesel injection pump wheel in some diesel engines

**DELIVERY SCOPE**

Double camshaft locking tool with short and long connecting arm  
Single camshaft locking tool with short and long locking screw

FITS FOR: **Universal**

ART.NR	ITEM NAME	PRICE
<b>BT596002</b>	Universal camshaft wheel puller	<b>63,00 €</b>

**DESCRIPTION**

For pulling the pulley and camshaft gear  
Gripping arms are connected with each other via adjusting disk, thus the gripping arms can be set easily and exactly  
Continuous adjustment range of the gripping arms from 42 – 82 mm  
Gripping arm depth is 27 mm

**DELIVERY SCOPE**

3 x gripping arms, Ø 12 mm, M10 x 1.5, suitable for material thickness up to max. 10 mm  
6-groove puller body with adjusting disc  
Spindle, M14 x 1.5, 19 mm hex, with centring cone



**BT521150**  
**EAN 4042146778869**

**Master cooling radiator pressure tester with vacuum purge and refill kit**



**199,- €**

**28**  
pcs.

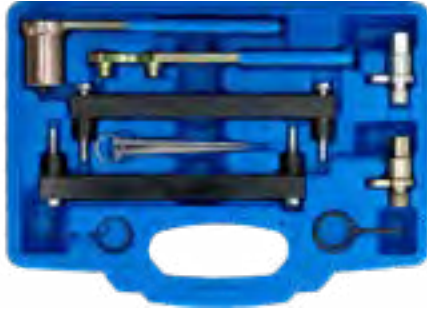

FITS FOR:

ART.NR	ITEM NAME	PRICE
BT593250	Engine adjustment tool set for Land Rover; Jaguar V8	85,00 €

#### FOR THE FOLLOWING MODELS

Suitable for 3.2 3.5 4.0 4.2 4.4L engines in the following models: Jaguar XJ8 (1997, 2009), engine AJ26 AC, BC, LC, 1B, 5G, SB, Jaguar XJR (1997, 2009), engine AJ27 KB, CC, MA, 2B, 9G, TB, Jaguar S-Type (1999, 2008), engine AJ28 KC, CE, MB, 3B, HB, PC, Jaguar XF (2008, 2009), engine AJ34 3.5, DC, NB, 1G, HG, Jaguar XK8 (1997, 2009), engine RB, EC, NC, Jaguar XKR (1998, 2009), engine GB, PA, Range Rover (2006, 2009), 4.2L engine (428PS), Range Rover (2005, 2009), 4.2L engine (428PS), Land Rover Discovery III (2005, 2009)

#### DESCRIPTION

For adjusting and checking the engine timing  
Needed e.g. when working on the valve train and replacing the cylinder head seal

#### DELIVERY SCOPE

Flywheel locking bolt (silver), use as OEM 303-531  
Flywheel locking bolt (gold), use as OEM 303-645  
2 camshaft adjustments plate, use as OEM 303-530  
Camshaft sprocket holding tool, use as OEM 303-532  
2 wedges, use as OEM 303-533  
Primary tensioner locking pin, use as OEM T40011  
Adjustment tool for VVT unit, use as OEM 303-654  
Tensioner locking pin



FITS FOR:

ART.NR	ITEM NAME	PRICE
BT591880	Engine adjustment tool set for BMW, Land Rover V8	179,00 €

#### FOR THE FOLLOWING MODELS

BMW 530i (1994, 1995), 540i (1997, 2003), 740i (1993, 1995), 740iL (1993, 2001), 840Ci (1995, 1996), X5 (2000, 2003)  
Range Rover with M60, M62 and M62TU V8 engines

#### DESCRIPTION

For adjusting and checking the engine timing  
Needed e.g. when working on the valve train and replacing the cylinder head seal

#### DELIVERY SCOPE

Discharge camshaft adjustment tool (cylinders 1-4), use as OEM BMW 112445, Rover LRT 12-223/2  
Intake camshaft adjustment tool (cylinders 1-4), use as OEM BMW 112441, Rover LRT 12-223/1  
Intake camshaft adjustment tool (cylinders 5-8), use as OEM BMW 112442, Rover LRT 12-223/3  
Discharge camshaft adjustment tool (cylinders 5-8), use as OEM BMW 112446, LRT 12-223/4  
Fixing tools for camshaft adjuster (A-D)  
Crankshaft locking pin, use as OEM 112300  
Timing chain tensioner, use as OEM 113390



FITS FOR:

ART.NR	ITEM NAME	PRICE
BT593160	Engine adjustment tool set for Jaguar, Land Rover; Ford, Citroën 2.0, 2.2, 2.4, 3.2 diesel	105,00 €

#### FOR THE FOLLOWING MODELS

Ford Mondeo (2000 - 2007), Transit (2000 - 2011)  
Citroen Relay (2006 - 2011), Jumper III  
Fiat Ducato (2006 - 2011)  
Jaguar X-Type (2001 - 2010)  
Land Rover Defender (2007 - 2011)  
Peugeot Boxer III (2006 - 2011)  
LDV Convoy (2002 - 2006)  
with DURATORQ (PUMA) diesel engines

#### ENGINE CODES

2.0L engine code ABFA, D3FA, D5BA, D6BA, F3FA, F1FA, FMBA, HJBA, HJBB, HJBC, HJBE, N7BA, N7BB  
2.2L (with chain-driven high-pressure pump), engine code QJBA (BG), QJBB, QJBC, QJBD  
2.2L (high-pressure pump driven via camshaft), engine code 4HM, 4HU, 4HV, P8FA, P22DTE, QVFA, QWFA  
2.4L with engine code 244DT, DOFA, D2FA, D2FB, D4FA, F4FA, FXFA, H9FA, H9FB, HE FA, HFFA, JXFA, PHFA, ZSD 424  
3.2L with engine code SAFA (timing only)

#### DESCRIPTION

For checking and adjusting the engine timing  
Needed e.g. when working on the valve train and replacing the cylinder head seal

#### DELIVERY SCOPE

Engine cover adjustment tool, use as OEM 303-682  
Tool for engine cover/crankshaft radial sealing ring, use as OEM 303-679A  
High-pressure pump wheel holding tool, use as OEM 303-1151  
High-pressure pump wheel disassembly tool, use as OEM 303-249  
Flywheel locking bolt, use as OEM 303-675  
Flywheel locking bolt, use as OEM 303-698  
Locking pin set, 3 pcs, 6 mm  
Tensioner locking pin, 2 mm

# PRODUCTION: INTERNATIONAL QUALITY: MADE IN GERMANY





FITS FOR:

ART.NR	ITEM NAME	PRICE
<b>BT593200</b>	Engine adjustment tool for Jaguar	<b>73,00 €</b>

**FOR THE FOLLOWING MODELS**

Land Rover 200Tdi 300Tdi 2.5D (12J) 2.5TD

**DESCRIPTION**

For adjusting and checking the engine timing

**DELIVERY SCOPE**

- Puller for crankshaft vibration damper
- Blocking tool of the injection pump
- Blocking tool of the injection pump 200/300 Tdi
- Flywheel blocking tool 200/300 Tdi
- DPS pump tapping tool 2.5
- Flywheel blocking tool 2.5
- EDC tapping tool 30Q gearbox
- Crankshaft puller



FITS FOR:

ART.NR	ITEM NAME	PRICE
<b>BT593320</b>	Engine adjustment tool set for Land Rover 3.6 TD V8	<b>145,00 €</b>

**FOR THE FOLLOWING MODELS**

Range Rover (L332) 3.6 TD V8 (2006-2011), engine code: 368DT

Rover Sport L320 3.6 TD V8 (2006-2011), engine code: 369DT

**DESCRIPTION**

For adjusting the engine timing when replacing the timing chain or the cylinder head seal

**DELIVERY SCOPE**

- Camshaft adjustment tool (2x) with fastening screws, use as OEM 303-1236
- Flywheel locking tool, use as OEM 303-1243
- Crankshaft adjustment pin, use as OEM 303-1238
- Camshaft turning pin, use as OEM 303-1239



FITS FOR:

ART.NR	ITEM NAME	PRICE
<b>BT593190</b>	Engine adjustment tool set for Jaguar, Land Rover 5.0 V8	<b>189,00 €</b>

**FOR THE FOLLOWING MODELS**

Suitable for the following models with a 5L V8 engine: X150-XK (10MY), X250-XF (10MY), X351-XJ (10MY)

**DESCRIPTION**

For adjusting and checking the engine timing  
Needed when working on the valve train and replacing the cylinder head seal

**DELIVERY SCOPE**

- Camshaft adjustment tool, use as OEM 303-1445
- Crankshaft locking bolt, use as OEM 303-1447
- Flywheel locking tool, use as OEM 303-1448
- Crankshaft turning tool, use as OEM 303-1452
- Timing chain tensioning tool, use as OEM 303-1482





FITS FOR:



ART.NR	ITEM NAME	PRICE
<b>BT592860</b>	Engine adjustment tool set for Ford TDCi, PSA HdI, Mazda D 1.4, 1.6	<b>5,00 €</b>

**FOR THE FOLLOWING MODELS**

Citroen 1.4Hdi DV4TD (8HT/8HW/8HX/8HZ), 1.4Hdi DV4TED4 (8HV/8HY), 1.6Hdi DV6TED4 (9HY/9HZ), 1.6Hdi DV6ATED4 (9HW/9HX), 1.6Hdi DV6UT-ED4(9HU)  
 Mazda 1.4CITD F6JA, F6JB 1.6CITD Y6  
 Peugeot 1.4Hdi DV4TD (8HT/8HW/8HX/8HZ), 1.4Hdi DV4TED4 (8HV/8HY), 1.6Hdi DV6TED4 (9HY/9HZ), 1.6Hdi DV6ATED4 (9HW/9HX), 1.6Hdi DV6UT-ED4(9HU)  
 Ford 1.4TDCi F6JA, F6JB, F6JC, F6JD 1.6TDCi G8DA, G8DB, HHDA 1.6TDCi HHDB, HHJA, HHJB, HHJD  
 Volvo 1.6D D4164T

**DESCRIPTION**

For adjusting the engine timing when replacing the camshaft, cylinder head seal etc.

**DELIVERY SCOPE**

Flywheel locking bolt, use as OEM PSA 0194-C, Ford 303-734 (21-262), Volvo 999-7169, Mazda 49 JE02 020  
 Crankshaft and high-pressure pump wheel locking pin, 2 pcs, use as OEM PSA 0194-A, Ford 303-732 (21-260), Volvo 999-7233, Mazda 49 JE02 018  
 Crankshaft and high-pressure pump wheel locking pin, 2 pcs, use as OEM PSA 0194-A, Ford 303-732 (21-260), Volvo 999-7233, Mazda 49 JE02 018



FITS FOR:



ART.NR	ITEM NAME	PRICE
<b>BT593350</b>	Engine adjustment tool for Land Rover, BMW, Opel 1.8, 2.5 with timing chain	<b>127,00 €</b>

**FOR THE FOLLOWING MODELS**

BMW, Land Rover, Opel, Rover

**ENGINE CODES**

17 4 T1 / 25 6 T1

**DESCRIPTION**

For adjusting and checking the engine timing

**DELIVERY SCOPE**

Crankshaft tapping tool, OEM: 11 2 300, KM 813, LRT12108, LRT12171  
 Crankshaft alignment tool – diesel, OEM: 11 3 320, KM 811, LRT12112  
 Locking pin (2) OEM: 11 3 340, LRT12172  
 Crankshaft holding tool, OEM: KM 819, KM819  
 Cam chain tensioner, OEM: 11 3 360, KM 822, LRT12115  
 Puller for injection pump, OEM: KM 825, 13 5 120I, LRT12119  
 Puller for injection pump shaft, OEM: KM 826, KM826



FITS FOR:



ART.NR	ITEM NAME	PRICE
<b>BT593180</b>	Engine adjustment tool set for Jaguar, Land Rover 2.7, 3.0 TD V6	<b>67,00 €</b>

**FOR THE FOLLOWING MODELS**

Citroen C5 III (2007 - 2009), C6 (2005 - 2009)  
 Jaguar S-Type (2004 - 2008), XF (2008 - 2012), XJ (2010 - 2012), XJ6 (2005 - 2010)  
 Range Rover Sport (2005 - 2009)  
 Peugeot 407 (2004 - 2009), 407 Coupe (2006 - 2009), 607 (2004 - 2011) 2.7TD V6, TDVi (276DT) 2.7D HDi (DT17BTD4) (UHZ) 3.0D HDi (D20CTED4) (X8Z) 3.0D SD V6, TD V6 (306DT) (AJ-V6D)

**DESCRIPTION**

For checking and adjusting the engine timing  
 Needed e.g. when working on the valve train and replacing the cylinder head seal

**DELIVERY SCOPE**

Flywheel interlock (manual), use as OEM (Rover) 303-1116  
 Flywheel interlock (automatic), use as OEM (Rover) 303-1117  
 Camshaft sprocket adjustment pin, use as OEM (Rover) 303-1132  
 Camshaft sprocket adjustment pin, 2 pcs, use as OEM (Rover) 303-1126, (PSA) 0195H  
 Water pump locking pin, use as OEM (PSA) 0195-C  
 Flywheel locking tool, use as OEM (PSA) 0195-K  
 Toothed belt retaining clip, use as OEM (PSA) 0188-K

**TRUST YOUR EYES:  
OUR UNBOXING VIDEOS**





FITS FOR: **Universal**

ART.NR	ITEM NAME	PRICE
<b>BT596002</b>	Universal camshaft wheel puller	<b>63,00 €</b>

**DESCRIPTION**

For pulling the pulley and camshaft gear  
Gripping arms are connected with each other via adjusting disk, thus the gripping arms can be set easily and exactly  
Continuous adjustment range of the gripping arms from 42 – 82 mm  
Gripping arm depth is 27 mm

**DELIVERY SCOPE**

3 x gripping arms, Ø 12 mm, M10 x 1.5, suitable for material thickness up to max. 10 mm  
6-groove puller body with adjusting disc  
Spindle, M14 x 1.5, 19 mm hex, with centring cone



FITS FOR:



ART.NR	ITEM NAME	PRICE
<b>BT594460</b>	Engine adjustment tool set for PSA 2.5, 2.8 l diesel	<b>12,00 €</b>

**FOR THE FOLLOWING MODELS**

Citroen, Peugeot, Fiat, Iveco Traffic (1980-2000), Master (1980-2007), Mascot (1999-2007)  
Fiat, PSA, Renault Daily (1991-2005), Turbo Daily (1994-2000), Relay, Jumper (2001-2002) Boxer (2000-2006), Arena (1997-2001), Movano (1998-2003)

**DESCRIPTION**

Use as OEM Fiat 1 870 667 000, 1 870 765 001, 1 860 617 000, Renault: MOT861, MOT1054, MOT863, Opel KM6031, Ford 21-260, 303-732, Peugeot 0132AB, 5711TD, 4527TS2, 0178D, 0194A, 119790, Citroen 0132AB, 5711TD, 4527TS2, 0178D, 0194A, 119790, Mazda 49 JE 02018, 0991246510, Volvo 999-7169

**DELIVERY SCOPE**

2 locking bolts  
Flywheel locking bolt  
Holding tool for toothed belt tensioner



FITS FOR: **Ford**

ART.NR	ITEM NAME	PRICE
<b>BT593029</b>	Crankshaft locking pin for Ford Zetec, Duratec engines	<b>5,00 €</b>

**DESCRIPTION**

Suitable for Ford Zetec SE and Duratec 1.25, 1.4, 1.6l engines, installed in the Fiesta, Fusion and Focus





ART.NR	ITEM NAME	PRICE
BT591260	Camshaft sprocket locking tool set, universal	72,50 €

#### FOR THE FOLLOWING MODELS

Can be used universally on vehicles from the following manufacturers: Audi, Alfa Romeo, Chrysler, Citroën, Ford, Honda, Hyundai, Isuzu, Land Rover, Lexus, Mazda, Mitsubishi, Peugeot, Renault, MG, Seat, Skoda, Subaru, Toyota, Opel, Volkswagen, Volvo

#### DESCRIPTION

For locking the camshaft sprockets e.g. when replacing the toothed belt

Suitable for engines with 1, 2 and 4 camshafts (V engines); also suitable for locking between the camshaft sprocket and diesel injection pump wheel in some diesel engines

#### DELIVERY SCOPE

Double camshaft locking tool with short and long connecting arm

Single camshaft locking tool with short and long locking screw



ART.NR	ITEM NAME	PRICE
BT593300	Crankshaft pulley tool set I for Jaguar, Land Rover	99,00 €

#### DESCRIPTION

Non-destructive removal and fitting of the crankshaft pulley

Needed when working on the camshaft drive

Crankshaft pulley counter support, use as OEM 303-893

2 fastening screws, use as OEM 303-588

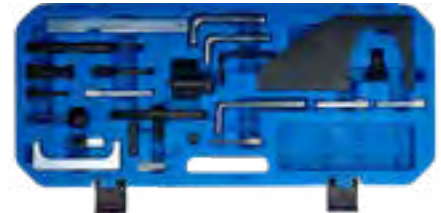

ART.NR	ITEM NAME	PRICE
BT593100	Engine adjustment tool set for Ford	109,00 €

#### FOR THE FOLLOWING MODELS

Suitable for the following Ford engines: 1.4, 1.6 16V, 1.7, 1.8 16V, 2.0 16V (including Zetec), 1.4, 1.6, 1.8, 1.9 D/TD/TDCi

#### DESCRIPTION

Contains tools for: Locking the flywheel

Locking the crankshaft, pump shaft

Locking the injection pump shaft

Removing the crankshaft pulley

Tensioning the toothed belt

Adjustment gauge for positioning the camshaft and pump shaft in relation to the crankshaft

Use as OEM 21-162, 21-162B, 303-367, 303-376, 23-059, 310-085, 21-168, 303-393, 23-020, 23-047, 23-020, 21-163, 303-620, 23-019, 21-210, 303-507, 21-251, 303-698, 21-262, 303-734, 23-029, 303-1061, 23-058, 310-084, 21-105, 21-262, 303-734, 21-168, 303-393, 21-263, 303-735, Mazda 49JE01061, Audi 3359, T10008, T10050, 2065A, Seat 3359, T10008, T10050, 2065A, Skoda 3359, T10008, T10050, 2065A, Volkswagen 3359, T10008, T10050, 2065A

**207**  
pcs.

**BT153207**  
**EAN 4042146831878**

Tool cabinet with 7 drawers and 207 tools

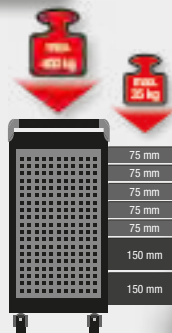

**449,- €**

**PROFESSIONAL WORKSHOP TROLLEY INCLUDING 207 PREMIUM TOOLS!**

# MERCEDES



**FITS FOR:**  Mercedes-Benz

ART.NR	ITEM NAME	PRICE
<b>BT551121</b>	Diesel pump locking pin for Mercedes-Benz	<b>8,00 €</b>

#### FOR THE FOLLOWING MODELS

Mercedes-Benz 200D, TD, 250D, TD, 300D, TD

#### ENGINE CODES

Engine codes: 601.912, 602.912, 602.962 603.913, 606.910, 603.963

#### DESCRIPTION

For locking Bosch in-line injection pumps in the assembly position

Use as OEM 601 589 05 21 00



**FITS FOR:**  Mercedes-Benz

ART.NR	ITEM NAME	PRICE
<b>BT551122</b>	Pre-chamber insert for Mercedes-Benz CDI	<b>13,00 €</b>

#### FOR THE FOLLOWING MODELS

Suitable for engines in the 601, 602, 602.91, 603, 604, 605, 606, 661, 662 series

#### DESCRIPTION

Notched tooth insert 1.5 x 58 mm, 12.5 mm (1/2") drive

Makes it possible to replace the diesel pre-chamber

Suitable for Mercedes-Benz engines start from 1989 onwards

Use as OEM 603589000900, 603589010900



**FITS FOR:**  Mercedes-Benz

ART.NR	ITEM NAME	PRICE
<b>BT593380</b>	Engine adjustment tool set for Mercedes-Benz M271	<b>139,00 €</b>

#### FOR THE FOLLOWING MODELS

Mercedes-Benz CLK 200K (W209), C 180K, C200K.C 230K (W203), C Sportcoupe C 160K.C 180K, C 200K, C 230K, E 200K (W211).SLK 200K (R171), C 180K (W204), CLC 180K.CLC 200K, C 180 CGI, C 200CGI, C 250CGI (W204).E 200CGI, E 250CGI (W212, C207)

#### ENGINE CODES

Engine codes: M271 E18ML (2002-), DE18ML (2003, 2005), E16ML (2008-), DE18LA (2009-)

#### DESCRIPTION

Needed when replacing the timing chain

#### DELIVERY SCOPE

Timing chain retaining device, use as OEM 271589014000

Camshaft interlock, use as OEM 271589006100

Fixing pin, use as OEM 271589001500

Timing chain strain reliever, use as OEM 271589003100



**FITS FOR:**  Mercedes-Benz

ART.NR	ITEM NAME	PRICE
<b>BT571016</b>	V-ribbed belt tensioning element for Mercedes-Benz W169 and W245	<b>29,00 €</b>

#### FOR THE FOLLOWING MODELS

Mercedes-Benz A-Class W169 2004-2012 (A150, A160, A170, A180, A200, A200T), B-Class W245 2005-2011 (B150, B160, B170, B180, B200, B200T) with start/stop function and/or air conditioning

#### DESCRIPTION

For tensioning and slackening the damper spring

Prevents damage to the tensioning element and injuries

Pressure spindle with ball head, drive: internal hex 10 mm

Use as OEM 266589003100



**FITS FOR:**  Mercedes-Benz

ART.NR	ITEM NAME	PRICE
<b>BT593530</b>	Timing chain riveting tool	<b>149,00 €</b>

#### DESCRIPTION

For replacing or riveting timing chains

Old timing chain is withdrawn using the new chain, often eliminating the need to take apart the timing chain case

Suitable for Mercedes-Benz models with Simplex and Duplex timing chains with 4 mm chain pins

Use as Mercedes-Benz OEM tools 112589096300, 602589003900, 602589023300, 602589024000, 602589056300, 602589056301



**FITS FOR:**  Mercedes-Benz

ART.NR	ITEM NAME	PRICE
<b>BT593545</b>	Adapter for Art. BT593530	<b>8,00 €</b>

#### DESCRIPTION

Makes it possible to use the tool on Simplex timing chains

Suitable for the timing chain riveting tool Art. BT593530



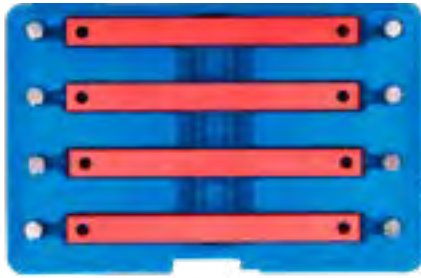

**FITS FOR:** Mercedes-Benz

ART.NR	ITEM NAME	PRICE
<b>BT593600</b>	Engine adjustment tool set for Mercedes-Benz M276, M157, M278	<b>45,00 €</b>

**FOR THE FOLLOWING MODELS**

Mercedes-Benz CL 500, 63 AMG (C 216) 2010 – 2013, S 500, 63 AMG (C 217) start from 2014 onwards, CLS 300 (C 218) start from 2012 onwards, E 300, 350, 400 (C/A 207) start from 2011 onwards, CLS 350, 400, 500, 63 AMG (C/X 218) 2011 – 2014, SLK 350 (R 172) start from 2011 onwards, SL 350, 400, 500, 63 AMG (R 231) start from 2012 onwards, S 500 PLUG-IN HYBRID (V 222) start from 2014 onwards, ML 300, 350, 500, 63 AMG (W 166) start from 2011 onwards, C 400 (W 205) start from 2014 onwards, E 400 HYBRID (W 212) start from 2012 onwards, G 63 AMG (W 463) start from 2012 onwards, E 300, 350, 400, 500, 63 AMG (W/S 212) start from 2011 onwards, C 350 (W/S/C 204) start from 2011 onwards, S 350, 500, 63 AMG (W/V 221) start from 2010 onwards, S 400, 63 AMG (W/V 222) start from 2013 onwards, R 350 BlueEFFICIENCY (W/V 251) start from 2012 onwards, GL 450, 500 (X 166) start from 2012 onwards, GLK 350 (X 204) start from 2011 onwards

**DESCRIPTION**

For adjusting the camshaft in setting position

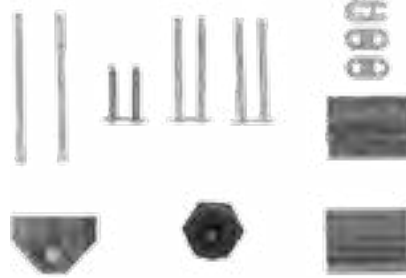

**FITS FOR:** Mercedes-Benz

ART.NR	ITEM NAME	PRICE
<b>BT593570</b>	Supplementary set for timing chain riveting tool (Art. BT593530), suitable for 3 mm chain bolts	<b>38,00 €</b>

**DESCRIPTION**

Suitable for 3 mm Mercedes-Benz Duplex timing chains in petrol and diesel engines of the newer generation

Use as OEM 103589016300, 602589024000 and 602589046300



**FITS FOR:** Mercedes-Benz CHRYSLER

ART.NR	ITEM NAME	PRICE
<b>BT593560</b>	Motor-Einstellwerkzeug-Satz, für Mercedes-Benz, Chrysler	<b>71,00 €</b>

**FOR THE FOLLOWING MODELS**

Mercedes-Benz 190, C, CLK, E, S, SL, SLK, G, M, Vito, Sprinter, Viano, PT Cruiser, Grand Cherokee

Petrol engines: 1.8, 2.0, 2.2, 2.3, 2.5, 2.8, 3.0, 3.2, 3.3, 4.2, 5.0, 6.0 with engine code 102, 111, 104 (apart start from AMG), 119, 120

Diesel engines: 2.0D, 2.2D, 2.3D, 2.5D, 2.5TD, 2.9D, 2.9TD, 3.0D, 3.0TD, 3.5D, 3.5TD, 2.0 CDI, 2.2 CDI, 2.3 CDI, 2.7 CDI, 3.2 CDI, 3.5 CDI, 3.9 CDI, 4.0 CDI, 2.2 CRD, 2.7 CRD • with engine code 601, 604, 605, 611, 646, 612, 602, 603, 606, 612, 613, 646, 647, 648, 628, 603, 613, 628, 648, 646, 602, 603, EDJ

**DESCRIPTION**

Contains tools for adjusting the camshaft and blocking the crankshaft (flywheel)

**DELIVERY SCOPE**

Flywheel blocking tool, including 2x M6 x 90mm, use as OEM 601589024000, 8933

Flywheel blocking tool, use as OEM 112589034000

Camshaft locking pin set, use as OEM 602589004000, 8929

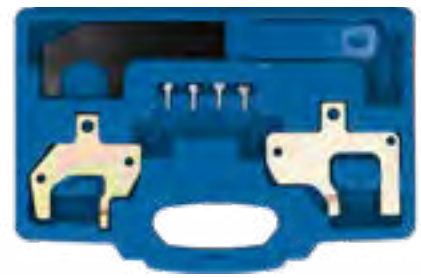

**FITS FOR:** Mercedes-Benz

ART.NR	ITEM NAME	PRICE
<b>BT593660</b>	Engine adjustment tool set for Mercedes-Benz M112 + M113	<b>71,00 €</b>

**FOR THE FOLLOWING MODELS**

- Mercedes-Benz C-Class 240, 280 (202) (1997-)
- Mercedes-Benz C-Class 240, 320 (203) (2000-)
- Mercedes-Benz CL 500 (215) (1999-2006)
- Mercedes-Benz CLK 320, 430 (208) (1997-2003)
- Mercedes-Benz CLK 240, 320, 500, 55AMG (209) (2002-2006)
- Mercedes-Benz CLS 500, 55AMG (219) (2004-2006)
- Mercedes-Benz E-Class 240, 280, 320, 430 (210) (1997-2002)
- Mercedes-Benz E-Class 240, 320, 500, E55AMG (211) (2003-2006)
- Mercedes-Benz M-Class ML320, 350, 430, 500, 55AMG (163) (1997-2005)
- Mercedes-Benz M-Class 500 (164) (2005-2007)
- Mercedes-Benz S-Class 280, 320, 350, 430, 500 (220) (1998-2005)
- Mercedes-Benz SL 280, 320, 500 (129) (1998-2002)
- Mercedes-Benz SL 350, 500, 55AMG (230) (2001-2008)
- Mercedes-Benz SLK 320K (170) (2000-2004)
- Mercedes-Benz SLK 55AMG (171) (2004-2010)
- Mercedes-Benz R-Class 500 (2006-2007)
- Mercedes-Benz Viano 3.0, 3.2, 3.5 (2003-2008)
- Mercedes-Benz Vito 123 (639) (2004-2008)
- Chrysler Crossfire (SRT-6) (2003-2007)

**DESCRIPTION**

Needed when working on the timing chain or adjusting the engine timing

Holds the left and right camshafts in the adjustment position

**DELIVERY SCOPE**

Camshaft interlock (right-hand side), use as OEM 112589003200

Camshaft interlock (left-hand side), use as OEM 112589013200

Camshaft spanner, use as OEM 112589000100



**FITS FOR:** Mercedes-Benz

ART.NR	ITEM NAME	PRICE
<b>BT593625</b>	Balance shaft adjustment tool set for Mercedes-Benz OM651	<b>72,00 €</b>

**FOR THE FOLLOWING MODELS**

Mercedes-Benz A-Class (W176) 180.200, 220 CDI, B-Class (W246) 200, 220 CDI, C-Class (W, S, C) 204 180, 200, 220, 250 CDI, C-Class (W205) 220, 250, CLA (C117) 200, 220 CDI, CLS (C, X 218) 220, 250, E-Class (W, S 212) 200, 220, 250 CDI, E-Class (C, A 207) 220, 250 CDI, E-Class (W212) 250, 300 BlueTEC, GLA (X156) 200, 220 CDI, GLK (X 204) 200, 220, 250 CDI, ML (W166) 250, SLK (R172) 250 CDI, Sprinter (W906) 210, 310, 510, 213, 313 CDI, Sprinter (W906) 513, 216, 316, 416, 516 CDI, V-Class (W, V 447) 200, 220, 250 CDI, Viano (W, V 639) 2.0, 2.2CDI, Vito (W, V 639) 110, 113, 116 CDI

**DESCRIPTION**

For adjusting the balance shafts

For use with the engine adjustment tool set for Mercedes-Benz OM651 (Art. BT593620)

**DELIVERY SCOPE**

Balance shaft locking forks

Balance shaft locking rod

Fastening screws

Use as OEM 651 589 02 63 00



**FITS FOR:** Mercedes-Benz

ART.NR	ITEM NAME	PRICE
<b>BT593585</b>	Timing chain assembly tool set for Mercedes-Benz engine 651	<b>189,00 €</b>

**FOR THE FOLLOWING MODELS**

Mercedes-Benz engine of the OM 651 series

**DESCRIPTION**

Prevents the timing chain start from slipping and the camshaft sprockets start from turning when replacing the timing chain

No need to remove the camshaft sprockets

Makes precise positioning possible

**DELIVERY SCOPE**

Timing chain guide tool, use as OEM 60831800

Camshaft interlock, use as OEM 60831830

Crankshaft lathe tool, use as OEM 60831810

Camshaft spanner, use as OEM 60831820



**FITS FOR:** Mercedes-Benz

ART.NR	ITEM NAME	PRICE
<b>BT596001</b>	Mercedes-TORX® 100 special socket	<b>10,00 €</b>

**FOR THE FOLLOWING MODELS**

C-Class (W203, W204, W205), CLK, E-Class (W211, W212), E-Class Coupé (W207), SLK (W171, W172), G-Class (W463), Sprinter (W906)

**ENGINE CODES**

- M133, 157, 176, 177, 270, 271, 271.8, 271.9, 272, 273, 274, 276, 278

**DESCRIPTION**

For works on the camshaft, control chain, or camshaft adjuster

With borehole

1/2"



**FITS FOR:** Mercedes-Benz

ART.NR	ITEM NAME	PRICE
<b>BT593620</b>	Engine adjustment tool set for Mercedes-Benz OM651	<b>125,00 €</b>

**FOR THE FOLLOWING MODELS**

Mercedes-Benz A-Class (W176) 180.200, 220 CDI, B-Class (W246) 200, 220 CDI, C-Class (W, S, C) 204 180, 200, 220, 250 CDI, C-Class (W205) 220, 250, CLA (C117) 200, 220 CDI, CLS (C, X 218) 220, 250, E-Class (W, S 212) 200, 220, 250 CDI, E-Class (C, A 207) 220, 250 CDI, E-Class (W212) 250, 300 BlueTEC, GLA (X156) 200, 220 CDI, GLK (X 204) 200, 220, 250 CDI, ML (W166) 250, SLK (R172) 250 CDI, Sprinter (W906) 210, 310, 510, 213, 313 CDI, Sprinter (W906) 513, 216, 316, 416, 516 CDI, V-Class (W, V 447) 200, 220, 250 CDI, Viano (W, V 639) 2.0, 2.2CDI, Vito (W, V 639) 110, 113, 116 CDI

**DESCRIPTION**

For adjusting and checking the engine timing

**DELIVERY SCOPE**

Camshaft adjustment tool, use as OEM 65158 901 4000

Crankshaft turning tool, use as OEM 65158 900 4000



**FITS FOR:** Mercedes-Benz

ART.NR	ITEM NAME	PRICE
<b>BT593635</b>	Engine mount ring spanner set for Mercedes-Benz	<b>20,00 €</b>

**DESCRIPTION**

Ring spanner, 10 mm square drive (3/8"), double-hex drive, SW 16 mm

Ring spanner, 10 mm square drive (3/8"), double-hex drive, SW 17 mm

Especially suited to engine bearings on Mercedes-Benz engines: W220, W210, W203, W221, W211, W204, W124, W140, W170, W126, W201, W202, W210





FITS FOR: Mercedes-Benz

ART.NR	ITEM NAME	PRICE
<b>BT593370</b>	Timing chain assembly tool for Mercedes M111	<b>41,00 €</b>

**FOR THE FOLLOWING MODELS**

Mercedes-Benz  
C-Class 180, 200, 220, 230  
E-Class 220, 230  
CLK 200, 230  
SLK 200, 230  
ML 230

**DESCRIPTION**

Makes it easier to fit the timing chain on MB M111 4-cylinder petrol engines  
Use as OEM 111 589 19 61 00

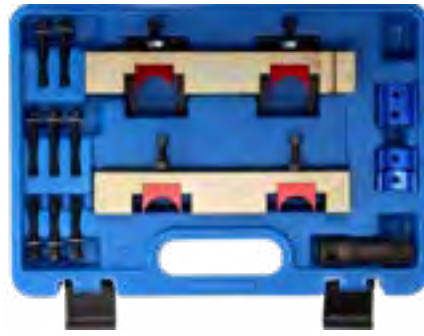

FITS FOR: Mercedes-Benz

ART.NR	ITEM NAME	PRICE
<b>BT593500</b>	Engine adjustment tool set for Mercedes-Benz M270, M274, M133	<b>159,00 €</b>

**FOR THE FOLLOWING MODELS**

Mercedes-Benz A-Class (series W176) start from 2012 onwards, model A180, A200, B-class (model W246) start from 2011 onwards, model B180, B200

**DESCRIPTION**

For adjusting and inspecting the engine control times  
Makes it possible to hold down and fix the camshaft

**DELIVERY SCOPE**

Use as OEM 270589006100



FITS FOR: Mercedes-Benz

ART.NR	ITEM NAME	PRICE
<b>BT593550</b>	Engine adjustment tool for Mercedes	<b>145,00 €</b>

**FOR THE FOLLOWING MODELS**

C63, CLK63, ML63, R63, E63, S63, SL63 M159

**ENGINE CODES**

M156, M159

**DESCRIPTION**

For adjusting and checking the engine timing

**DELIVERY SCOPE**

1x camshaft retainer, use as OEM 156 589 00 61 00  
Camshaft sensor position adjuster, OEM 156 589 00 32 00  
Adjustment tool for camshaft sprocket, OEM 156 589 01 63 00



**WE SPEAK YOUR LANGUAGE!**  
**OUR WEBSITE OFFERS**  
**28 LANGUAGE VARIANTS**



# MG



FITS FOR: **Universal**

ART.NR	ITEM NAME	PRICE
<b>BT596002</b>	Universal camshaft wheel puller	<b>63,00 €</b>

**DESCRIPTION**

For pulling the pulley and camshaft gear

Gripping arms are connected with each other via adjusting disk, thus the gripping arms can be set easily and exactly

Continuous adjustment range of the gripping arms start from 42 – 82 mm

Gripping arm depth is 27 mm

**DELIVERY SCOPE**

3 x gripping arms, Ø 12 mm, M10 x 1.5, suitable for material thickness up to max. 10 mm

6-groove puller body with adjusting disc

Spindle, M14 x 1.5, 19 mm hex, with centring cone



FITS FOR: **MG** **LAND-ROVER**

ART.NR	ITEM NAME	PRICE
<b>BT593360</b>	Camshaft locking tool for Rover, MG	<b>4,00 €</b>

**DESCRIPTION**

Suitable for Rover and MG models



FITS FOR: **BMW** **LAND-ROVER**

ART.NR	ITEM NAME	PRICE
<b>BT591651</b>	Camshaft locking tool for BMW	<b>17,00 €</b>

**DESCRIPTION**

Suitable for BMW engines in the M57, M57TU, M57T2N47, M47TU, M47T2 series

Also suitable for structurally identical engines in the Range Rover 2.5 DT, Freelander 2.0 TD4, Omega B Y25DT

**BT160100**  
**EAN 4042146844403**  
**1/2" pneumatic impact wrench**

**59,- €**

**1.450 Nm**

**1/2"**  
12,5 mm

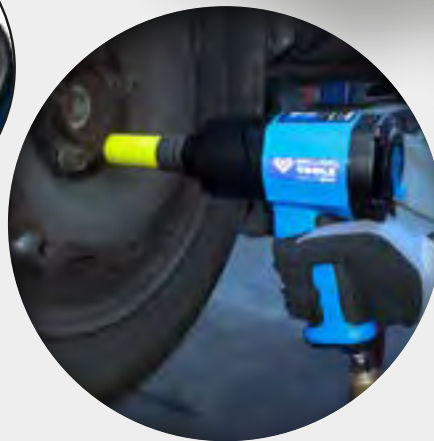

Ø	MAX. Nm	MAX. Nm	EMPFOLHEN Nm	U/min	m/s <sup>2</sup>	dbA	dbA	l/min	bar	mm	PT
1/2	470, 610, 830	1450	530	8500	<17,25	100,9	89,9	169	max. 6,3	min. 10	1/4"



**FITS FOR:**

ART.NR	ITEM NAME	PRICE
BT594500	Engine adjustment tool set for Land Rover, MG	99,00 €

**FOR THE FOLLOWING MODELS**

ROVER 45 (1999-2005), 75 (1999-2005), 825 (1996-1999) 2.0 V6 and 2.5 V6  
 MG ZT (1999-2005), ZT-T (1999-2005), ZS (1999-2005) 2.0 V6 and 2.5 V6  
 LAND ROVER Freelander (2000-2006) 2.0 V6 and 2.5 V6

**DESCRIPTION**

For adjusting and checking the engine timing

**DELIVERY SCOPE**

- Camshaft lock, use as OEM LRT12-196 / 18G 1747
- Adapter for camshafts, use as OEM LRT12-187
- Adapter for camshafts, use as OEM 18G 1747-2
- Camshaft wheel lock, use as OEM LRT12-175
- Tie rod
- Tool for camshaft wheel, use as OEM LRT12-195
- Camshaft pin, use as OEM LRT12-198 / 18G 1746A
- Camshaft locking pin, use as OEM 0189B
- Flywheel locking tool, use as OEM LRT12-232 / 18G 1747-5
- Crankshaft wheel lock, use as OEM LRT12-175 / 18G 1747-1

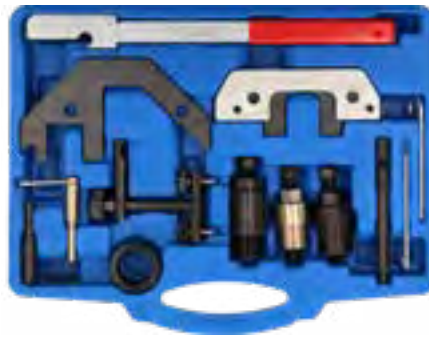

**FITS FOR:**

ART.NR	ITEM NAME	PRICE
BT591650	Engine adjustment tool set for BMW diesel engines	129,00 €

**FOR THE FOLLOWING MODELS**

BMW 1, 3, 5, 6, 7, X3, X 5 (series E34-36-38-39-66-83-90-91-92-93)  
 Land Rover, Range Rover, Freelander  
 Rover 75, MG, MG ZT  
 Vauxhall, Opel Omega-B

**ENGINE CODES**

M41, M51, M47 M47 TU/T2, M57 TU/T2 2.0I/3.0I (1998-2008)  
 204D3, Td4, Td 6  
 M47R

**DELIVERY SCOPE**

- Timing chain counter support, use as OEM BMW 113360, Range Rover LRT-12-115
- Camshaft alignment tool, use as OEM BMW 116321 (116320), Opel KM6267
- Securing bracket alignment tool, use as OEM BMW 116322 (116320)
- Injection pump extractor (long), use as OEM BMW 135120
- Injection pump extractor, use as OEM BMW 135120, Range Rover LRT-12-119
- Injection pump extractor (short), use as OEM BMW 135191, 135192 (135190), Opel KM6270
- Threaded ring, use as OEM BMW 135191, 135192 (135190), Opel KM6270
- Camshaft securing bridge, use as OEM BMW 113320, Rover LRT-12-112
- Crankshaft marking pin, use as OEM BMW 115180
- Crankshaft marking pin, use as OEM BMW 116080
- Tension roller marking pins, use as OEM BMW 113340, Range Rover LRT-12-114, Opel KM-823
- Crankshaft marking pin, use as OEM BMW 112300, Range Rover LRT-12-108



**FITS FOR:**

ART.NR	ITEM NAME	PRICE
BT591260	Camshaft sprocket locking tool set, universal	72,50 €

**FOR THE FOLLOWING MODELS**

Can be used universally on vehicles start from the following manufacturers: Audi, Alfa Romeo, Chrysler, Citroën, Ford, Honda, Hyundai, Isuzu, Land Rover, Lexus, Mazda, Mitsubishi, Peugeot, Renault, MG, Seat, Skoda, Subaru, Toyota, Opel, Volkswagen, Volvo

**DESCRIPTION**

For locking the camshaft sprockets e.g. when replacing the toothed belt  
 Suitable for engines with 1, 2 and 4 camshafts (V engines); also suitable for locking between the camshaft sprocket and diesel injection pump wheel in some diesel engines

**DELIVERY SCOPE**

- Double camshaft locking tool with short and long connecting arm
- Single camshaft locking tool with short and long locking screw

# MINI



FITS FOR:

ART.NR	ITEM NAME	PRICE
<b>BT593750</b>	Engine adjustment tool set for MINI	<b>145,00 €</b>

### FOR THE FOLLOWING MODELS

Suitable for the following models: MINI One, Cooper, Cooper S, Cooper S JC Cooper S JCW (series R50, 52, 53, 55, 56, 57)

### ENGINE CODES

For engine codes W10, W11, N14

### DESCRIPTION

For working on intake and exhaust camshafts

### DELIVERY SCOPE

Fixing of camshafts, use as OEM 119551 and 119552

Fixing of crankshaft, use as OEM 119590

Tools for chain tensioner, use as OEM 119340



FITS FOR:

ART.NR	ITEM NAME	PRICE
<b>BT593770</b>	Crankshaft pulley tool set for MINI Cooper engines W11	<b>68,00 €</b>

### DESCRIPTION

Makes it possible to safely install and remove the crankshaft pulley (vibration damper) on 1.6L MINI Cooper and MINI Cooper S engines (type W11)

Slots in the pull-off wheel make it possible to remove both types of W11 pulleys

Contains a pressure pin that prevents damage to the crankshaft nose

Use as OEM 118450, 118441, 118270

### DELIVERY SCOPE

Pull-off wheel, Assembly pressure piece, Pressure pin, Pull-off spindle, Assembly spindle

6 fastening screws



FITS FOR:

ART.NR	ITEM NAME	PRICE
<b>BT593800</b>	Engine adjustment tool set for MINI, PSA	<b>119,00 €</b>

### FOR THE FOLLOWING MODELS

MINI One, Cooper HB, Cooper (R55-56) N12 engine

Citroën C4 (year of construction 2008, 2009), C4 Picasso (year of construction 2008, 2009)

Peugeot 207 (year of construction 2006, 2009), 207CC (year of construction 2007, 2009), 308 (year of construction 2001, 2009)

Engines: 1.4, 1.6 VTI, EP3 (8FS) EP6 (5FW), EP6C 1.6 THP, EP6DT (5FX) EP6DTS (5FY)

### DESCRIPTION

Needed when replacing the cylinder head seal and when working on the engine timing

### DELIVERY SCOPE

Crankshaft fixer, use as OEM 119590, 0197-BZ

Camshaft fixer, use as OEM 119540, 0197-A1, 0197-A3

Chain tensioner, use as OEM 119340, 0197-M



FITS FOR:

ART.NR	ITEM NAME	PRICE
<b>BT596002</b>	Universal camshaft wheel puller	<b>63,00 €</b>

### DESCRIPTION

For pulling the pulley and camshaft gear

Gripping arms are connected with each other via adjusting disk, thus the gripping arms can be set easily and exactly

Continuous adjustment range of the gripping arms start from 42 – 82 mm

Gripping arm depth is 27 mm

### DELIVERY SCOPE

3 x gripping arms, Ø 12 mm, M10 x 1.5, suitable for material thickness up to max. 10 mm

6-groove puller body with adjusting disc

Spindle, M14 x 1.5, 19 mm hex, with centring cone



FITS FOR:

ART.NR	ITEM NAME	PRICE
<b>BT593130</b>	Engine adjustment tool set for Hyundai, Mitsubishi	<b>21,00 €</b>

### FOR THE FOLLOWING MODELS

Hyundai 1.6, 1.8, 2.0, 2.4 DOHC and Mitsubishi 1.8 to 3.5 16V and V6

Mitsubishi Colt (1989, 1995), Lancer (1989, 1995), Carisma (1996, 2005), Galant (1993, 2003), Sigma (1991, 1996), Eclipse (1991, 1995), 3000TG (1993, 2000), Space Star (1999, 2006) with engines 1.8 16V GDI (4G63, 4G94), 2.0 16V GDI (4G63, 4G94, 6A12), 2.4 GDI (4G64, 4G69), 3.5 GDI V6 (6G74), 2.5 V6 (6G73, 6a13), 3.0 V6 (6G72)

Hyundai Lantra (1991, 1996), Sonata (1993, 2001), Trajet (2000, 2005), Santa Fe 6.1 with engine G4-N, G4-CP, 4JP, G4-P-, G4-R-, G4-JS

### DESCRIPTION

Contains important tools for checking the engine control and replacing the toothed belt



FITS FOR:

ART.NR	ITEM NAME	PRICE
<b>BT593750</b>	Engine adjustment tool set for MINI	<b>145,00 €</b>

### FOR THE FOLLOWING MODELS

Suitable for the following models: MINI One, Cooper, Cooper S, Cooper S JC Cooper S JCW (series R50, 52, 53, 55, 56, 57)

### ENGINE CODES

For engine codes W10, W11, N14

### DESCRIPTION

For working on intake and exhaust camshafts

### DELIVERY SCOPE

Fixing of camshafts, use as OEM 119551 and 119552

Fixing of crankshaft, use as OEM 119590

Tools for chain tensioner, use as OEM 119340



FITS FOR:

ART.NR	ITEM NAME	PRICE
BT591580	Engine adjustment tool set for BMW, MINI, PSA	69,00 €

**FOR THE FOLLOWING MODELS**

BMW 1.6 (N40, N45, N45T, B16, B16A, B16AC) 1.8, 2.0 (N42, N46, N46T) 2.0, 3.0 (N51, N52, N52K, N53, N54)  
 PSA 1.4, 1.6 16V (EP3, EP6, EP6DT, EP6DTS)  
 MINI 1.4, 1.6 (N12, N14)

**DESCRIPTION**

For aligning new and old versions of balance shafts  
 Prevents non-concentric engine running due to incorrectly aligned balance shafts  
 Needed when changing the timing chain, replacing the crankshaft sealing ring, replacing the cylinder head seal etc.  
 Use as OEM 115140, 119280, 119330

**DELIVERY SCOPE**

Balance shaft fixing tool (old and new version)  
 Crankshaft counter support  
 Locking pin for chain tensioner



FITS FOR:

ART.NR	ITEM NAME	PRICE
BT591870	Engine adjustment tool set for MINI, Citroen, Peugeot 1.6L diesel	15,00 €

**FOR THE FOLLOWING MODELS**

BMW MINI, MINI Clubman, series R55, R56, R57  
 Citroen C2, C3, C4, C5, Grand Picasso, Berlingo (MK3), Xsara Picasso  
 Peugeot 206, 206cc, 207, 207cc, 1007, 307, 308, 308cc, 3008, 5008, Partner (MK3)

**ENGINE CODES**

Engine codes: BMW: W16D16 (9HZ), W16D16UO, PSA: 9HZ, 9HX, 9HY (DV6TED4)

**DESCRIPTION**

For adjusting and checking the engine timing  
 Suitable for the following models with a 1.6L diesel engine

**DELIVERY SCOPE**

Crankshaft marking pin, use as OEM PSA 0194A, BMW 119790  
 Marking pins for camshaft and high-pressure pump, use as OEM PSA 0194B, BMW 110300  
 Flywheel interlock, use as OEM PSA 0194C, BMW 119850, 119851, 119852



ART.NR	ITEM NAME	PRICE
BT591260	Camshaft sprocket locking tool set, universal	72,50 €

**FOR THE FOLLOWING MODELS**

Can be used universally on vehicles start from the following manufacturers: Audi, Alfa Romeo, Chrysler, Citroen, Ford, Honda, Hyundai, Isuzu, Land Rover, Lexus, Mazda, Mitsubishi, Peugeot, Renault, MG, Seat, Skoda, Subaru, Toyota, Opel, Volkswagen, Volvo

**DESCRIPTION**

For locking the camshaft sprockets e.g. when replacing the toothed belt  
 Suitable for engines with 1, 2 and 4 camshafts (V engines); also suitable for locking between the camshaft sprocket and diesel injection pump wheel in some diesel engines

**DELIVERY SCOPE**

Double camshaft locking tool with short and long connecting arm  
 Single camshaft locking tool with short and long locking screw

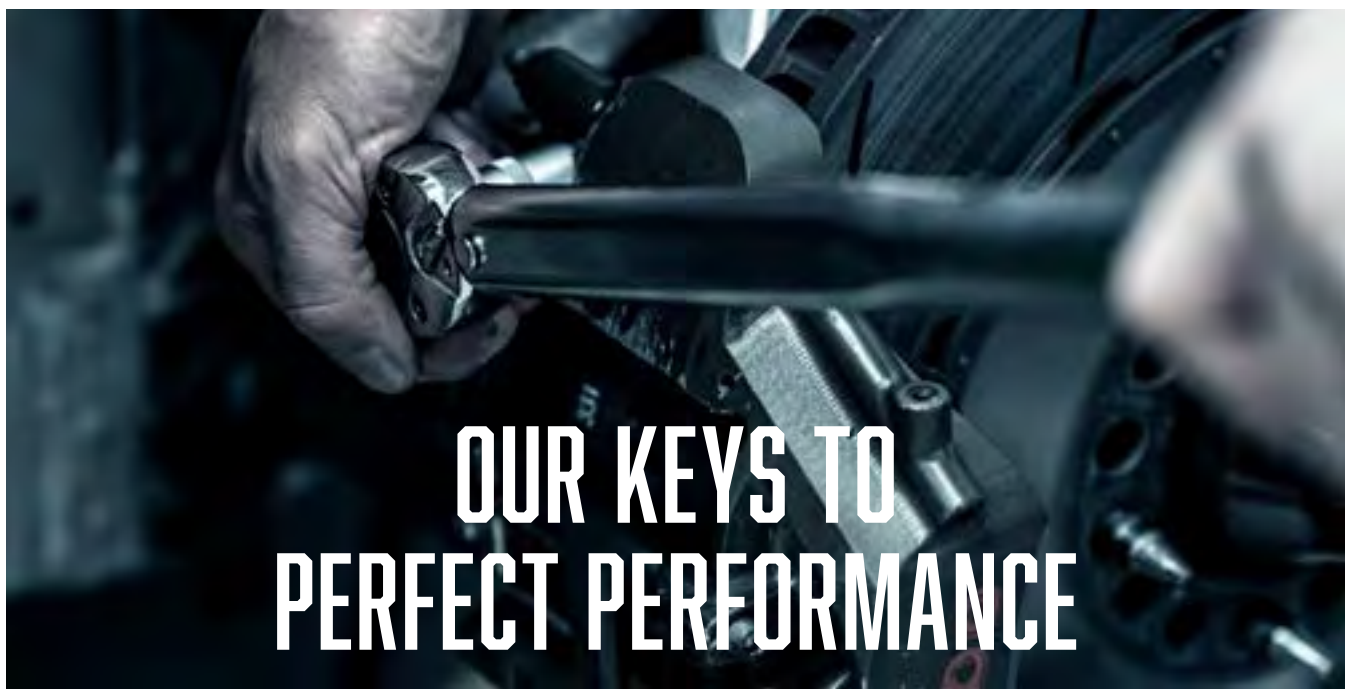

**OUR KEYS TO  
PERFECT PERFORMANCE**

# MITSUBISHI



FITS FOR:



ART.NR	ITEM NAME	PRICE
<b>BT592320</b>	Balance shaft adjustment tool set for Land Rover, Citroen, Mitsubishi, Peugeot, Ford 2.2 DOHC diesel engines	<b>42,00 €</b>

#### FOR THE FOLLOWING MODELS

Land Rover Discovery, Discovery Sport, Freelander 2, eD4, TD4, TD4e (2009-2015) engine codes: 224DT, DW12CTED4/224DT, DW12BTED4/224DT

Citroen C5, C5 II, C5 III, C6, C8, C-Crosser HDi (200-2015) engine codes: 4HX (DW12CTED4), 4HP (DW-12BTED4), 4HX (DW12TED4), 4HW (DW12TED4/L4)

Mitsubishi Outlander DI-D, DI-DC (2007-2013) engine codes: 4HK, 4HN

Peugeot 4007, 407, 607, 807, 406, 508, 607, HDi, GT Hdi (2000-2015) engine codes: DW12MTED4 (4HK), DW12MTED4 (4HN), DW12BTED4 (4HP), DW12BTED4 (4HR), DW12BTED4 (4HT), DW12TED4/L4 (4HW), DW12BTED4 (4HS), DW12ATED (4HZ), DW12ATED4 (4HX), DW12ATED (4HZ), DW12CTED4 (4HL)

Ford Galaxy, Mondeo, S-Max, TDCI, TCI (2008-2015) engine codes: KNBB, KNBA, KNWA, Q4BA

#### DESCRIPTION

For adjusting the balance shaft

#### DELIVERY SCOPE

Balance shaft fixing tool, use as OEM 303-1329

Balancing tool, use as OEM 303-1330

Balance shaft adjustment tool, use as OEM 303-1328, 0190D

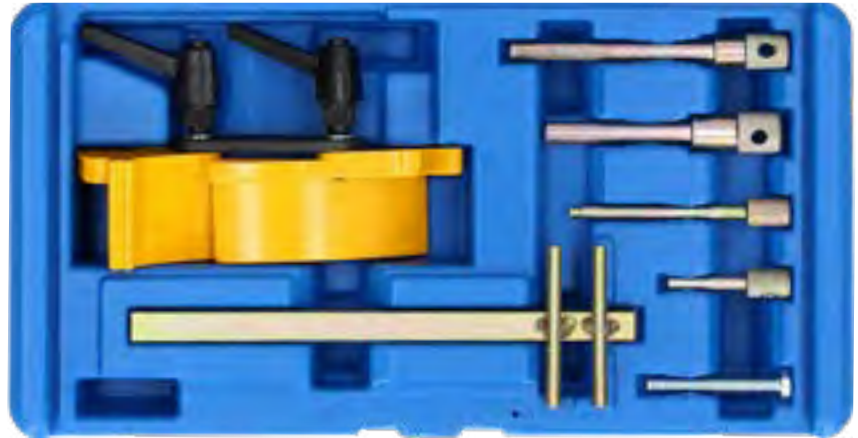

FITS FOR:



ART.NR	ITEM NAME	PRICE
<b>BT594570</b>	Engine adjustment tool set for Renault, Opel, Volvo, Mitsubishi, Chrysler	<b>41,00 €</b>

#### FOR THE FOLLOWING MODELS

Renault: Clio (1990-2013), Espace, Grand Espace (1996-2002), Extra, Rapid, Express (1991-2002), Kangoo (1998-2009), Laguna (1994-2001), Megane (1995-2003), Scenic (1996-2003), Modus, Grand Modus II (2004-2013), Safrane (1992-2001), Trafic (1997-2000), Master II (2000-2003), Twingo (2000-2013), Wind (2011-2013)

Opel: Arena (1997-2001), Movano-A (1999-2006), Vivaro (2001-2007)

Volvo: S40 (1996-2004), V40 (1996-2004)

Mitsubishi: Carisma (2001-2005), Space Star (2000-2006)

Chrysler: Cherokee (1984-1995), Wrangler (1988-1995)

#### ENGINE CODES

E7F 1.2: 700, 704, 706, 708, 750

D4F 1.2 16v: 702, 704, 706, 708, 712, 714, 716, 722, 728, 730, 740, 742, 764, 772, 780, 782, 784, 786

E7J 1.4: 601, 624, 626, 634, 635, 710, 711, 716, 718, 719, 754, 756, 757, 764, 780

F3P 1.8: 674, 676, 678, 710, 712, 714, 720, 724, 755, 758, B670, Q7, R7, S724

F7P 1.8 16v: 720, 722

F8Q 1.9D/Di/Turbo: 600, 606, 620, 622, 624, 630, 632, 644, 646, 648, 662, 672 /676, 678, 680, 682, 684, 692 /696, 714, 722, 724, 730, 732, 776, 784, 786, 788, 790, B640

F9Q 1.9D dTi: F9Q1, F9Q2, 710, 716, 717, 720, 722, 730, 731, 734, 736, 744, 760, 762, 770, 774, 780, 782, 790 D4192T, D4191T2 D4192T3, D4192T4

F3R 2.0: 611, 722, 723, 742, 750, 751, 752, 768, 769, 791, 796, 797, 798

J7R 2.0: 732, 733, 734, 735

F7R 2.0 16V: 700, 714, D710

J7T 2.2 16V: 760, 761

G8T 2.2D/Turbo: 706, 714, 716, 740, 752, 760, 790, 792, 794

#### DESCRIPTION

For adjusting the engine timing on Renault petrol and diesel engines

#### DELIVERY SCOPE

Camshaft locking tool, adjustable for DOHC engines

Injection pump wheel fixing mandrel, use as OEM Mot.910

Tension roller key, use as OEM Mot1135-01

Crankshaft fixing mandrel, use as OEM Mot.1318

Crankshaft fixing mandrel, use as OEM Mot.1054

Crankshaft fixing mandrel, use as OEM Mot.910





# WE DO WITHOUT MANY THINGS. BUT NEVER ON THE BEST QUALITY

You know what is important to you. You don't need an extravagant Marketing, complex training or costly trade fairs. That's why you can do without some things, just not on brilliant quality. We think the same way!

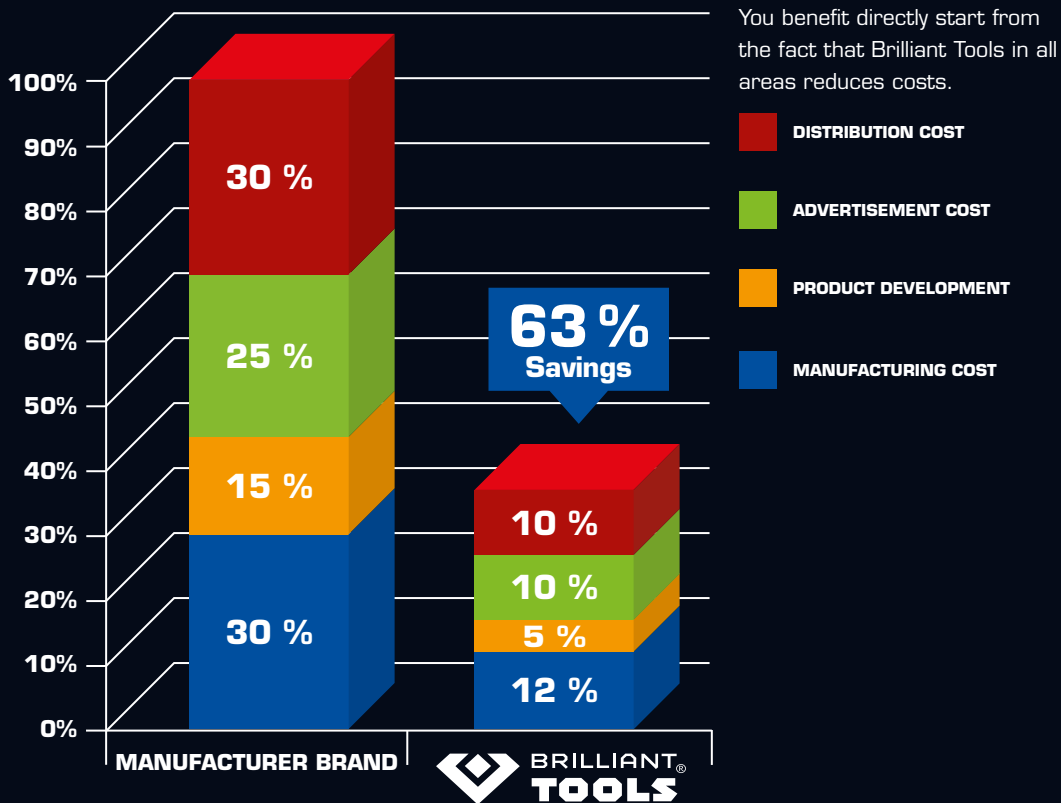

# NISSAN

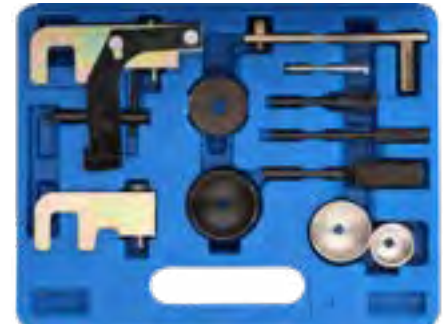
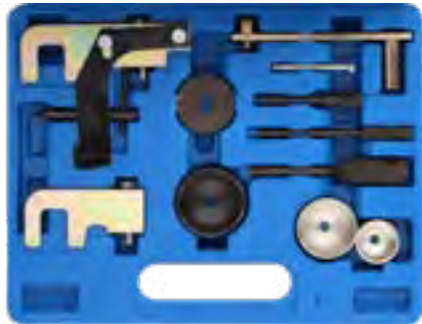

FITS FOR:

ART.NR	ITEM NAME	PRICE
<b>BT594550</b>	Engine adjustment tool set for Renault, Opel, Nissan	<b>59,00 €</b>

#### FOR THE FOLLOWING MODELS

Renault Avantime (2005, 2007), Clio (2001, 2008), Espace (2000, 2008), Kangoo (2000, 2008), Laguna (1999, 2001), Laguna II (2004, 2007), Master (2000, 2006), Megane (1999, 2008), Modus (2004, 2008), Scenic (1999, 2008), Traffic (2001, 2008), Twingo (2007, 2008)

Nissan Almera N16 (2002, 2006), Interstar (2002, 2006), Kubistar (2003, 2008), Micra K12 (2003, 2008), Note (2006, 2008), Primastar (2002, 2007), Primera P12 (2003, 2007), Qashqai (2008, 2009)

Opel Movano (2000, 2008), Vivaro (2001, 2008)

#### ENGINE CODES

Engine codes: 1.5 (K9K), 1.9 (F9Q), 2.2 (G9T), 2.5 (G9U)

#### DESCRIPTION

For positioning and locking the crankshaft and camshaft when repairing the toothed belt or engine

#### DELIVERY SCOPE

Intake camshaft interlock OEM KM6205 (MOT1534)

Discharge camshaft interlock, use as OEM KM6204 (MOT1537)

Injection pump interlock, use as OEM MOT1538

Tensioning tool set (5 pcs), use as OEM MOT1543

Locking pin, use as OEM MOT1430

Crankshaft locking pin, use as OEM MOT1536

FITS FOR:

ART.NR	ITEM NAME	PRICE
<b>BT593820</b>	Engine adjustment tool set for Nissan, Renault, Opel	<b>105,00 €</b>

#### FOR THE FOLLOWING MODELS

Nissan Primaster (2008, 2009), Qashqai (2008, 2009), X-Trail (2007, 2008)

Renault Koleos (2008, 2009), Laguna (2005, 2008), Megane (2007, 2008), Scenic (2008, 2009), Trafic (2007, 2008), Vel Satis (2008, 2009)

Opel Vivaro (2007, 2008)

#### ENGINE CODES

Nissan engine codes: M9R 780, 830, 832, 833

Nissan engine codes: M9R 700, 721, 724, 740, 742, 446, 760, 761, 780, 802, 803, 805, 830, 832, 833

Opel engine codes: M9R 780, 782, 784

#### DESCRIPTION

For adjusting and checking the engine timing



FITS FOR:

ART.NR	ITEM NAME	PRICE
<b>BT593830</b>	Retaining device for toothed belt pulley of the high-pressure pump	<b>29,00 €</b>

#### DESCRIPTION

Suitable for diesel engines with the identifier F9Q

Installed in vehicles manufactured by Opel, Renault, Nissan

Toothed belt does not need to be removed

Precise fixing of the pump wheel thanks to an accurate fit

No need to readjust the pump

FITS FOR:

ART.NR	ITEM NAME	PRICE
<b>BT594550</b>	Engine adjustment tool set for Renault, Opel, Nissan	<b>59,00 €</b>

#### FOR THE FOLLOWING MODELS

Renault Avantime (2005, 2007), Clio (2001, 2008), Espace (2000, 2008), Kangoo (2000, 2008), Laguna (1999, 2001), Laguna II (2004, 2007), Master (2000, 2006), Megane (1999, 2008), Modus (2004, 2008), Scenic (1999, 2008), Traffic (2001, 2008), Twingo (2007, 2008)

Nissan Almera N16 (2002, 2006), Interstar (2002, 2006), Kubistar (2003, 2008), Micra K12 (2003, 2008), Note (2006, 2008), Primastar (2002, 2007), Primera P12 (2003, 2007), Qashqai (2008, 2009)

Opel Movano (2000, 2008), Vivaro (2001, 2008)

#### ENGINE CODES

Engine codes: 1.5 (K9K), 1.9 (F9Q), 2.2 (G9T), 2.5 (G9U)

#### DESCRIPTION

For positioning and locking the crankshaft and camshaft when repairing the toothed belt or engine

#### DELIVERY SCOPE

Intake camshaft interlock OEM KM6205 (MOT1534)

Discharge camshaft interlock, use as OEM KM6204 (MOT1537)

Injection pump interlock, use as OEM MOT1538

Tensioning tool set (5 pcs), use as OEM MOT1543

Locking pin, use as OEM MOT1430

Crankshaft locking pin, use as OEM MOT1536



ART.NR	ITEM NAME	PRICE
<b>BT595700</b>	Camshaft locking tool set for VAG, Ford, Opel, Saab	<b>34,00 €</b>

**DESCRIPTION**

Universal set for a wide range of models

**DELIVERY SCOPE**

Camshaft interlock for Opel Calibra, Omega, Sintra, Vectra -1.8, 2.0, use as OEM KM-852, 18G1570

Camshaft interlock for Opel Calibra, Omega, Sintra, Vectra -1.4, 1.6, use as OEM KM-853

Right camshaft with Saab 900, 900 -2.5, 3.0, Opel Calibra, Sintra, Vectra -2.5, 3.0, use as OEM KM-800-2

Left camshaft with Saab 900.900 -2.5, 3.0, Opel Calibra, Sintra, Vectra -2.5, 3.0, use as OEM KM-800-1

Crankshaft toothed belt pulley interlock tool for TDI pump-injection engines with VW, Audi, Skoda, Seat and Ford, use as VAG T10050

Flywheel interlock tools for Citroen, Fiat and Peugeot, use as OEM 153A, 6012T, 9765.54

Flywheel holder unit for Isuzu 1.5 and 1.7 diesel, Opel 1.6, 1.7 diesel engines, Opel 1.2, 1.4, 1.6, 1.8, 2.0 OHC petrol engines, use as OEM KM-517-B

ART.NR	ITEM NAME	PRICE
<b>BT597940</b>	Engine adjustment tool set for Peugeot, Citroën, PSA	<b>89,00 €</b>

**FOR THE FOLLOWING MODELS**

Citroën AX, Berlingo, BX, C5, C15, C25, Dispatch, Evasion, Jumper, Jumpy, Relay, Saxo, Synergie, Visa, Xsara, Xantia, XM, XJR, ZX, etc.

Peugeot 106, 205, 306, 405, 406, 605, 806, J5, Boxer, Expert, Partner, Solara, Talbot Express, Talbot Horizon, etc.

PSA petrol engines 1.9, 1.1, 1.4, 1.6, 1.8, 1.9, 2.0, 1.6, 1.8, 2.0, 2.2 16V (turbo and dual camshafts)

PSA diesel engines 1.4, 1.5, 1.7, 1.8, 1.9, 2.1, 2.5 D, TD, TDI, 1.4, 1.6, 2.0, 2.2 HDI

Suitable for structurally identical engines in Fiat, Ford, Nissan, Renault, Rover, Toyota, etc.

**DESCRIPTION**

For checking and adjusting the engine timing

**DELIVERY SCOPE**

Flywheel adjustment pin with spring, use as OEM 0188X, 0189X

Tensioning spanner, 8 mm, use as OEM 7017-TW

Flywheel fixing mandrel, 7 mm, use as OEM 7017-TR

Angled adjustment pin, 8 mm, use as OEM 0188D, 7004TG, 9767-34, 0153G, 7014-TJ, 1 860 863 000, 0153N

Clamping tool, use as OEM 4507-TJ, 9767.89, 0188Q1, 0132X1Z, 0132X

Camshaft marking mandrel, use as OEM 0189A, 1 871 008 100

Hdi tension roller lever, use as OEM 0188J2

Tension roller lever, use as OEM 5711-TE, 0178E, 0188J/J1

Flywheel disc extractor, use as OEM 0174.0188P, 018892, 7015-T

Toothed belt retaining clamp, use as OEM 0189K, MOT1436, 4533-TAX, 0188K, 0187J, 0132AK, 0153AK, 1 870 00 100

Flywheel retainer, use as OEM 0195K, 4507-TL

Clamping tool, use as OEM 0189S1

Flywheel retainer, use as OEM 1867030000, 0153A, 9765.54, 6012T, 1860161000

Tension lever, use as OEM 0189S2
Angled locking pin, 5 mm
Flywheel fixing mandrel (for automatic transmission), use as OEM 0189R
Camshaft marking mandrel, use as OEM 0189AZ
Crankshaft retainer, use as OEM 0288D, 0188Y, 7014
Flywheel fixing mandrel (manual transmission), use as OEM 0189C
Flywheel interlock, use as OEM 0188F, 0134Q, 1870765001.1870827000, 0134AF, 9044-T, 1871000400
Camshaft marking mandrel (CA1), use as OEM 4533-TAC1, 0132AJ1
Camshaft and crankshaft retainer, use as OEM 0188M, 0187B, 0194B, 303-1277, MOT1430, 0189B, 303-735, 49JE01061, 21-263
Camshaft marking mandrel (CA2), use as OEM 0132AJ2, 2000023000, 0188M, 4533-TAC2
Marking mandrel for injection pump, use as OEM 4527-TS1
Injection pump fixing mandrel, use as OEM 0188H, 1 860 965 000
Flywheel fixing mandrel, use as OEM 49JE02020, 0194C, 21-262, 999-7121, 999-7169, 303-734
2 camshaft and crankshaft marking mandrels, use as OEM 4507-TB.7014-TN, 0132-R, 0153-AB, 0158-G
2 camshaft and crankshaft interlocks, use as OEM KM-955, 7014-TM
2 camshaft marking mandrels, use as OEM 9041-TZ, 5711-TC
2 crankshaft fixing mandrels, use as OEM 5711-TD, 119790, 0194A, 1860617000, 303-732, 07744-00104-00, 49JE02018, 0178D, 9997169, 4527-TS2, 21-260, 999-7169, 0132AB
Camshaft fixing mandrel, use as OEM 0189L
Screw M8 x 80 mm
Pin for clamping device, 3 mm, use as OEM 0153AL, 4200TA
Centring clip for crankshaft pulley, use as OEM 0188AH
Crankshaft marking mandrel, 6 mm, use as OEM 4507-TA, 0132Z, 0132QZ

# OPEL



ART.NR	ITEM NAME	PRICE
<b>BT593870</b>	Engine adjustment tool set for Opel, Saab, Chevrolet 2.0, 2.4	<b>209,00 €</b>

#### FOR THE FOLLOWING MODELS

Opel Astra, Insignia, Antara  
Chevrolet Captiva, HHR, Malibu  
Saab 9-5  
With engines: OPC, OPC/VXR, Turbo, E85, Turbo T-B

#### ENGINE CODES

2.0L > LHU, A20NFT, LTG, A20NHT, LDK, A20NHT  
2.4L > A24XE, A24XF, LE5, LE9

#### DESCRIPTION

For adjusting the engine timing when replacing the timing chain etc.  
Suitable for 2.0 L and 2.4 L petrol turbo engines with dual camshafts

#### DELIVERY SCOPE

Crankshaft wheel alignment tool, use as OEM EN-48585  
Flywheel locking tool, use as OEM EN-43653, J43653  
Tensioning element locking pin, 2.5 mm, use as OEM EN-955-10, KM 955  
Tensioning element locking pin, 4.0 mm, use as OEM EN-955-20, KM 955-20  
Tensioning tappet resetting tool, use as EN-45027-1, J-45027-1  
Tensioning tappet holder, use as OEM J45027-2, EN45027-2, EN-45027  
Camshaft interlock (left-hand side), use as OEM EN-49212, EN-49212-1  
Camshaft interlock (right-hand side), use as OEM EN-49212, EN-49212-2  
Camshaft adjuster holding tool, use as OEM EN-48953

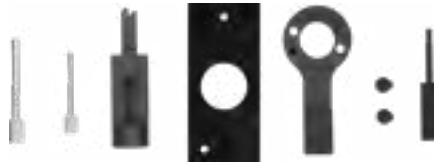

ART.NR	ITEM NAME	PRICE
<b>BT593910</b>	Engine adjustment tool set for Opel 2.0 CDTi, EcoFLEX	<b>96,00 €</b>

#### FOR THE FOLLOWING MODELS

Opel Cascada (2015, 2017), Insignia, Country Tourer (2014, 2017), Zafira C Tourer (2014, 2017) with 2.0 CDTi

#### ENGINE CODES

Engine code: LFS/B20DTH

#### DESCRIPTION

For adjusting the engine timing e.g. when replacing the toothed belt

#### DELIVERY SCOPE

Fixing tool for high-pressure pump wheel, use as OEM EN-51413  
Fixing pin for tensioner of additional equipment drive belt, use as OEM EN-955-2  
Crankshaft adjustment tool, 3 pcs, use as OEM EN-51412  
Camshaft fixing mandrel, use as OEM EN-51414  
Holding tool for crankshaft pulley (automatic transmission), use as OEM EN-51411



ART.NR	ITEM NAME	PRICE
<b>BT526009</b>	Water pump wheel holding tool for Opel Ecotec engines	<b>29,00 €</b>

#### DESCRIPTION

Suitable for Opel engines 2.2 L 16V, Z22SE  
Holds the timing chain and gear in place when the water pump is removed, eliminating the need to adjust the engine timing  
Saves time, reduces the work involved and prevents engine damage  
The crescent shape makes it easier to access the pump sprocket screws  
Tool is held in position with the cover screws



ART.NR	ITEM NAME	PRICE
<b>BT593830</b>	Retaining device for toothed belt pulley of the high-pressure pump	<b>29,00 €</b>

#### DESCRIPTION

Suitable for diesel engines with the identifier F9G  
Installed in vehicles manufactured by Opel, Renault, Nissan  
Toothed belt does not need to be removed  
Precise fixing of the pump wheel thanks to an accurate fit  
No need to readjust the pump

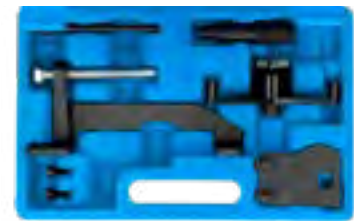

ART.NR	ITEM NAME	PRICE
<b>BT594250</b>	Engine adjustment tool set for Opel, GM 2.0, 2.2 Ecotec diesel	<b>40,00 €</b>

#### FOR THE FOLLOWING MODELS

Opel Vectra 2.0 Turbo diesel, Sintra 2.2 Turbo diesel, Zafira 2.0 Turbo diesel, Frontera 2.2 Turbo diesel  
Saab 9-3 2.2 Turbo diesel

#### ENGINE CODES

Engine codes: X20DTL, X20DTH, X22DTH, Y22DTR

#### DESCRIPTION

Makes it possible to adjust the engine timing

#### DELIVERY SCOPE

Adjustment spanner with holder, use as OEM Opel KM933, Saab 8395394  
Injection pump adjustment pin, use as OEM Opel KM927, Saab 8395337  
Crankshaft adjustment pin, use as OEM Opel KM929, Saab 8395352  
Camshaft adjustment tool, use as OEM Opel KM932, Saab 8395386



FITS FOR:

FITS FOR:

FITS FOR:

ART.NR	ITEM NAME	PRICE
<b>BT591650</b>	Engine adjustment tool set for BMW diesel engines	<b>129,00 €</b>

ART.NR	ITEM NAME	PRICE
<b>BT594450</b>	Engine adjustment tool set for Fiat, Opel, Alfa 1.9, 2.4 16V Diesel	<b>40,00 €</b>

ART.NR	ITEM NAME	PRICE
<b>BT592540</b>	Engine adjustment tool set for Fiat, Ford, Opel, Suzuki 1.3 diesel	<b>45,00 €</b>

**FOR THE FOLLOWING MODELS**

BMW 1, 3, 5, 6, 7, X3, X 5 (series E34-36-38-39-66-83-90-91-92-93)  
Land Rover, Range Rover, Freelander  
Rover 75, MG, MG ZT  
Vauxhall, Opel Omega-B

**FOR THE FOLLOWING MODELS**

Opel 1.9 CDTi Z19DT, Z19DTH, Z19DTJ  
Alfa-Romeo 1.9 and 2.4 L diesel with engine code: 323.02, 371.01, 342.02, 325.01, 362.02, 182B9.000, 937A2.000, 937A3.000, 192A5.000, 192B1.000, 937A4.000, 937A5.000, 939A2.000, 939A1.000, 939A7.000, 939A8.000, 839A6.000, 841C.000  
Fiat 1.9 and 2.4 L diesel with engine code: 182B4.000, 182B9.000, 185A6.000, 186A6.000, 186A8.000, 186A9.000, 188A2.000, 188A7.000, 188B2.000, 192A1.000, 192A3.000, 192A5.000, 192A8.000, 192A9.000, 192B4.000, 192B5.000, 198A2.000, 198A3.000, 198A6.000, 199A5.000, 223A7.000, 937A5.000, 939A1.000, 939A2.000, 939A3.000, 939A7.000

**FOR THE FOLLOWING MODELS**

Fiat Punto 1.3 JTD Multi-Jet 188A9.000, 2003 - 2007, Panda 1.3 JTD Multi-Jet 169A1.000, 188A8.000, 2003 - 2009, Idea 1.3 JTD Multi-Jet 199A3.000, 188A9.000, 2004 - 2006, Doblo 1.3 JTD Multi-Jet 188A9.000, 2004 - 2006, Doblo Cargo 1.3 JTD 188A9.000, 2004 - 2006  
Opel/Vauxhall Agila 1.3 CDTi Z13DT, 2003 - 2008, Corsa-C 1.3 CDTi Z13DT, 2003 - 2007, Combo-C 1.3 CDTi Z13DT, 2003 - 2009, Corsa-D 1.3 CDTi Z13DTH, Z13DTJ, 2006 - 2009, Astra-H 1.3 CDTi Z13DTH, 2004 - 2009, Tigra-B 1.3 CDTi Z13DT, 2004 - 2009, Meriva 1.3 CDTi Z13DT, Z13DTJ, 2004 - 2009  
Suzuki: Ingis 1.3 CDTi Z13DT, 2003 - 2009, Wagon R 1.3 CDTi Z13DT, 2003 - 2009, Swift 1.3 CDTi Z13DT, 2003 - 2010  
Ford Ka 1.3 TDCi

**ENGINE CODES**

M41, M51, M47 M47 TU/T2, M57 TU/T2 2.0/3.0i (1998-2008)  
204D3, Td4, Td 6  
M47R

**DELIVERY SCOPE**

Timing chain counter support, use as OEM BMW 113360, Range Rover LRT-12-115  
Camshaft alignment tool, use as OEM BMW 116321 (116320), Opel KM6267  
Securing bracket alignment tool, use as OEM BMW 116322 (116320)  
Injection pump extractor (long), use as OEM BMW 135120  
Injection pump extractor, use as OEM BMW 135120, Range Rover LRT-12-119  
Injection pump extractor (short), use as OEM BMW 135191, 135192 (135190), Opel KM6270  
Threaded ring, use as OEM BMW 135191, 135192 (135190), Opel KM6270  
Camshaft securing bridge, use as OEM BMW 113320, Rover LRT-12-112  
Crankshaft marking pin, use as OEM BMW 115180  
Crankshaft marking pin, use as OEM BMW 116080  
Tension roller marking pins, use as OEM BMW 113340, Range Rover LRT-12-114, Opel KM-823  
Crankshaft marking pin, use as OEM BMW 112300, Range Rover LRT-12-108

**DESCRIPTION**

For adjusting the engine timing e.g. when replacing the toothed belt, repairing the cylinder head, etc.

**DELIVERY SCOPE**

Crankshaft interlock, use as OEM Opel EN-46788, Fiat 1.860.905.000, 1.860.905.010  
Flywheel interlock, use as OEM Fiat 1.860.898.000  
Camshaft interlock, use as OEM Opel EN-46789, Fiat 1.870.896.900  
Marking mandrel Ø 3.7mm x 70mm, use as OEM Opel KM 6130, KM 6349

**DESCRIPTION**

For checking and adjusting the engine timing

**DELIVERY SCOPE**

Counter-support spanner for crankshaft pulley, use as Fiat OEM 1871000200 - Ford OEM 303-1469 - Opel/Vauxhall OEM KM-662-C  
Crankshaft adjustment tool, use as Opel/Vauxhall OEM EN 46785, OEM KM 955 - Suzuki 09912-38300  
Camshaft adjustment tool, use as Fiat OEM 1871000900, 1860985000 - Ford OEM 303-1472 - Opel/Vauxhall OEM EN 46781 - Suzuki OEM 09917-68610  
Chain tension lever, use as Fiat OEM 1870900400  
Crankshaft interlock tool, use as Fiat OEM 1870900300 - Ford OEM 303-1468  
Crankshaft adjustment tool, Fiat 8 mm



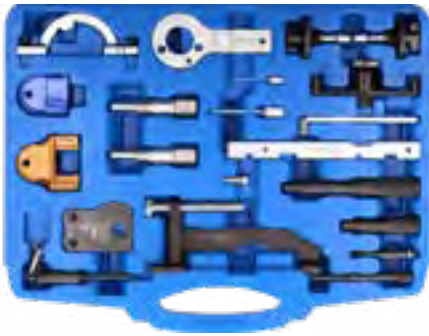

FITS FOR: 

ART.NR	ITEM NAME	PRICE
<b>BT594350</b>	Engine adjustment tool for Opel	<b>189,00 €</b>

**FOR THE FOLLOWING MODELS**

Opel Agila, Astra, Corsa, Frontera, Meriva, Omega, Signum, Sintra, Speedster, Tigra, Vectra, Zafira

**ENGINE CODES**

X10XE, X12XE, Z10XE, Z12XE, Z10XEP, Z12XEP, Z14XEP, X14XE, X16XEL, X16SEJ, X18E1, X18XE1, Y16XE, Z14XE, Z16XE, Z18XE, 18XEL, X18XE, C20SEL, X20XE, Z20LET, X22XE, Y22XE, Z22XE, Z13DT, X20DTL, X20DTH, Y20DTL, Y20DTH, X22DTH, Y22DTH, Y22DTR, Z19DT, Z19DTH

**DESCRIPTION**

For adjusting and checking the engine timing



FITS FOR:   

ART.NR	ITEM NAME	PRICE
<b>BT593820</b>	Engine adjustment tool set for Nissan, Renault, Opel	<b>105,00 €</b>

**FOR THE FOLLOWING MODELS**

Nissan Primaster (2008, 2009), Qashqai (2008, 2009), X-Trail (2007, 2008)

Renault Koleos (2008, 2009), Laguna (2005, 2008), Megane (2007, 2008), Scenic (2008, 2009), Trafic (2007, 2008), Vel Satis (2008, 2009)

Opel Vivaro (2007, 2008)

**ENGINE CODES**

Nissan engine codes: M9R 780, 830, 832, 833

Nissan engine codes: M9R 700, 721, 724, 740, 742, 446, 760, 761, 780, 802, 803, 805, 830, 832, 833

Opel engine codes: M9R 780, 782, 784

**DESCRIPTION**

For adjusting and checking the engine timing



FITS FOR: 

ART.NR	ITEM NAME	PRICE
<b>BT594240</b>	Engine adjustment tool set for Opel Vectra, Signum, Zafira	<b>69,00 €</b>

**FOR THE FOLLOWING MODELS**

Opel Astra G (2000, 2006), Speedster (Vauxhall) VX220 (2000, 2006), Vectra B, C (2000, 2008), Signum (2003, 2008), Zafira A, B (2000, 2008)

**ENGINE CODES**

Engine codes: Z22SE, Z22YH

**DESCRIPTION**

For adjusting the timing on the 2.2 L 16V engine with timing chain

**DELIVERY SCOPE**

Camshaft interlock, use as OEM KM-6148

Marking pin for chain tensioner, use as OEM KM-6077, Saab 8396392

Crankshaft counter support, use as OEM Opel KM-J-38122-A, KM-956-1, Alfa 2192261000

Water pump interlock, use as OEM Opel EN-43651, KM-J-43651, Alfa 2000012000

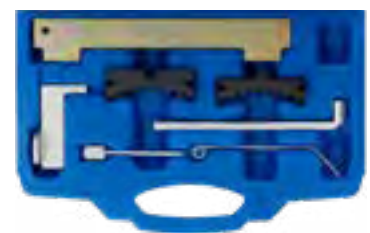

FITS FOR:    

ART.NR	ITEM NAME	PRICE
<b>BT591300</b>	Engine adjustment tool set for Opel 1.6, 1.8	<b>33,00 €</b>

**DESCRIPTION**

Contains tools for locking the camshaft and crankshaft

Suitable for 1.6 and 1.8 L engines with toothed belt control, installed in models start from Opel, Vauxhall, Chevrolet, Fiat, Alfa Romeo (2003-2012), e.g. Astra G, H, Corsa D, Insignia, Meriva, Signum, Vectra C, Zafira B (2003-2011)

Suitable for Chevrolet Cruze, Orlando 1.4 1.6 1.8 and Fiat Croma, Alfa Romeo 159 with 939A4.000 engines

Use as OEM tools KM-6628-A, 2000012000, KM-6340, 2000012100, KM-6333, KM-6625, 2000012800, KM-6349, KM 6130, KM-911



FITS FOR:

ART.NR	ITEM NAME	PRICE
BT594260	Engine adjustment tool set for Opel 1.2, 1.4	117,00 €

**FOR THE FOLLOWING MODELS**

Opel Adam 1.2 LWD 1.4 L2Z 1.4 LDD (2012), Ampera 1.4 LUJ/A14XFL (2011), Astra-J 1.4 LDD/A14XER 1.4 LDD/A14XEL 1.4 LUJ/A14NET 1.4 LUJ/A14NEL 1.4 LUJ/A14NET (2009), Corsa-D 1.0 A10XEP 1.2 A12XEL 1.2 A12XER 1.4 A14XEL, 1.4 A14XER -1.2 A12XER 1.4 A14NEL (2009), Insignia 1.4 LUJ/A14NET (2011), Meriva-B 1.4 LDD/A14XER 1.4 LUJ/A14NET 1.4 LUH/A14NEL (2010), Mokka 1.4 LUJ/A14NET (2012), Zafira-C Tourer 1.4 LUJ/A14NEL 1.4 LUJ/A14NET (2011), Aveo 1.2 L2Q/A12XEL 1.2 LDC/A12XER 1.2 LWD/A12XEL 1.4 LDD/A14XEL 1.4 LDD/A14XER (2011)

**DESCRIPTION**

For adjusting the engine timing

**DELIVERY SCOPE**

- Adjustment tool for camshaft sensor disc, use as OEM EN-49977-100
- Adjustment tool for intake camshaft, use as OEM EN-49977-200
- Camshaft sensor positioning tool, use as OEM EN-49978
- Chain tensioner pin, 4 mm, use as OEM KM-955-1
- Belt tensioner pin, 2.5 mm, use as OEM KM-955-2
- 2 camshaft interlocks, use as OEM KM-952, 953-A



FITS FOR:

ART.NR	ITEM NAME	PRICE
BT594650	Engine adjustment tool set for Renault	159,00 €

**FOR THE FOLLOWING MODELS**

Renault petrol engines 1.4, 1.6, 1.8, 2.0 l, each with 16V technology  
Renault petrol engines 2.5 l, 20V with dual camshafts  
Renault petrol engines 1.2, 1.4, 1.6, 1.7, 1.8, 2.0, 2.2 l  
Renault diesel engines 1.9, 2.5, 2.8 l  
Also for Opel Arena, Movano and Volvo V40, S40

**DESCRIPTION**

- Locking the flywheel
- Locking the crankshaft, injection pump shaft
- Removing the crankshaft pulley
- Tensioning the toothed belt
- Adjustment gauge for positioning the camshaft and pump shaft in relation to the crankshaft
- Use as OEM tools MOT1348, MOT1312, MOT1135-01, MOT1384, MOT1337, MOT1496, MOT910-1, MOT910, MOT861, MOT863, MOT1054, MOT1318, MOT1489, MOT1340, MOT1386, MOT1490, MOT1490-1, KM6031



FITS FOR:

ART.NR	ITEM NAME	PRICE
BT593850	Engine adjustment tool set for Opel 1.0, 1.2, 1.4	29,00 €

**FOR THE FOLLOWING MODELS**

Opel 1.0, 1.2, 1.4 (1997, 2007), Agila (Z10XE, Z12XE, Z10XEP, Z12XEP), Corsa B (X10XE, X12XE), Astra G, H (X12XE, Z14XEL, Z14XEP), Corsa Combo C (X10XEP, X12XEP, Z14XEP), Meriva (Z14XEP), Tigra B (Z14XEP), Agila, Corsa 1.0 12V, 1.2 16V

**DESCRIPTION**

For replacing the timing chain and other work on the valve train, work on the intake and exhaust camshaft

**DELIVERY SCOPE**

- Camshaft rule
- Crankshaft arresting pin
- Adjustment gauge for pulse generator disc
- Locking mandrel for timing chain tensioner
- Use as OEM KM953, KM952, KM954, KM955



FITS FOR:

ART.NR	ITEM NAME	PRICE
BT594654	Camshaft locking tool for Renault 1.4 and 1.6 16v	21,00 €

**FOR THE FOLLOWING MODELS**

Renault Clio II, Megane, Scenic, Laguna with 1.4 and 1.6 1V engines start from 1998 onwards

**ENGINE CODES**

Engine codes: KAJ 712, 713, 730, KAM 700, 701, 720, 724, 740

**DESCRIPTION**

For aligning the camshaft sprockets



**360° IMAGES**  
OF ALMOST ANY PRODUCT

[WWW.BRILLIANT-TOOLS.COM](http://WWW.BRILLIANT-TOOLS.COM)



FITS FOR: OPEL

ART.NR	ITEM NAME	PRICE
<b>BT595702</b>	Camshaft locking tool for Opel Astra, Corsa, Vectra	<b>4,00 €</b>

**FOR THE FOLLOWING MODELS**

Opel Tigra, Corsa, Astra, Vectra, Signum with 1.4L, 1.6L, 1.8L engines

**ENGINE CODES**

Engine codes: Z14XE, X16XE, X16XEL, Z16XE, Z18XE

**DESCRIPTION**

For arresting the cam shafts

**DELIVERY SCOPE**

Use as OEM KM-852



FITS FOR: OPEL

ART.NR	ITEM NAME	PRICE
<b>BT594200</b>	Engine adjustment tool set for Opel Ecotec V6	<b>92,00 €</b>

**FOR THE FOLLOWING MODELS**

Opel Calibra 2.5 V6 (1993, 1998), Cavalier 2.5, 2.6 V6 (1993, 1995), Omega B 2.5/2.6 V6 (1994, 2003), Omega B 3.0/3.2 V6 (1994, 2003), Signum 3.2 V6 (2003, 2005), Sintra 3.0 V6 (1996, 1999), Vectra A, B, C 2.5, 2.6, 3.2 V6 (1993, 2005)

**DESCRIPTION**

Engine adjustment tool set for V6 engines with multi-valve technology in Opel Ecotec

All the tools needed for locking the crankshaft and camshaft

**DELIVERY SCOPE**

- Crankshaft interlock, use as OEM KM-800-10
- Camshaft adjustment gauge, use as OEM KM-800-20
- Attachment, use as OEM KM 800-30
- Right camshaft interlock, use as OEM KM-800-1
- Left camshaft interlock, use as OEM KM-800-2
- Socket spanner insert E profile, square socket drive 12.5 mm (1/2"), SW E20, for deflection pulley
- Ring spanner, angled, SW 30 mm



FITS FOR: OPEL CHEVROLET

ART.NR	ITEM NAME	PRICE
<b>BT594300</b>	Engine adjustment tool set for Opel, Chevrolet 2.0 CDI	<b>32,00 €</b>

**DESCRIPTION**

For replacing the toothed belt and checking the timing

Holds the camshaft and crankshaft in the correct position

Suitable for 2.0 L common rail diesel engines with engine code Z20DM, Z20DMH, LLWZ20DMH, RA420, Z20SI, Z20S3, Z20S4, Z20S5

**DELIVERY SCOPE**

- Camshaft interlock, use as OEM EN-48245
- Crankshaft interlock, use as OEM EN-48246



FITS FOR: CITROËN PEUGEOT FIAT IVECO VOLVO MAZDA Ford OPEL

ART.NR	ITEM NAME	PRICE
<b>BT594460</b>	Engine adjustment tool set for PSA 2.5, 2.8 l diesel	<b>12,00 €</b>

**FOR THE FOLLOWING MODELS**

Citroen, Peugeot, Fiat, Iveco Traffic (1980-2000), Master (1980-2007), Mascot (1999-2007)

Fiat, PSA, Renault Daily (1991-2005), Turbo Daily (1994-2000), Relay, Jumper (2001-2002) Boxer (2000-2006), Arena (1997-2001), Movano (1998-2003)

**DESCRIPTION**

Use as OEM Fiat 1 870 667 000, 1 870 765 001, 1 860 617 000, Renault MOT861, MOT1054, MOT863, Opel KM6031, Ford 21-260, 303-732, Peugeot 0132AB, 5711TD, 4527TS2, 0178D, 0194A, 119790, Citroen 0132AB, 5711TD, 4527TS2, 0178D, 0194A, 119790, Mazda 49 JE 02018, 0991246510, Volvo 999-7169

**DELIVERY SCOPE**

- 2 locking bolts
- Flywheel locking bolt
- Holding tool for toothed belt tensioner







ART.NR	ITEM NAME	PRICE
<b>BT551400</b>	Adjustment and locking tool for diesel pumps for Renault, Mitsubishi, Opel	<b>23,00 €</b>

**FOR THE FOLLOWING MODELS**

Renault Megane Scenic, Kangoo  
Mitsubishi Carisma  
Opel Arena  
Volvo S40, V40

**DESCRIPTION**

For FBQ and F9Q diesel engines with adjustable pump wheel

**DELIVERY SCOPE**

Special insert with 27 mm internal hex and 1/2" drive  
Adjustment tool with 3x 4 mm pins for adjusting the pump  
M10 to M8 adapter for Bosch pumps



ART.NR	ITEM NAME	PRICE
<b>BT593930</b>	Camshaft adjustment tool set for Opel, Vauxhall 2.0 CDTi	<b>83,00 €</b>

**FOR THE FOLLOWING MODELS**

Opel Cascada 2.0 CDTi (2015-2017), Insignia 2.0 CDTi (2014-2017), Insignia 2.0 CDTi (2014-2017), Zafira-C Tourer 2.0 CDTi (2014-2017)

**ENGINE CODES**

Engine code: LFS/B20DTH

**DESCRIPTION**

For removing, replacing the timing chain in the cylinder head  
Suitable for 2.0 CDTi, EcoFLEX engines (start from 2014 onwards)

**DELIVERY SCOPE**

Camshaft adjustment tool, use as OEM EN-51415  
Chain tensioner locking pin, use as OEM EN-51418



ART.NR	ITEM NAME	PRICE
<b>BT593940</b>	Engine adjustment tool set for Opel, Vauxhall 1.6 CDTi ecoFLEX	<b>60,00 €</b>

**FOR THE FOLLOWING MODELS**

Opel Astra J, Astra K, Mervia B, Mokka, Zafira C Tourer

**ENGINE CODES**

Engine codes: LVL, B16DTN, LVM, B16DTC, LWG, B16DTE, LVL, B16, LVL, B16DTJ

**DESCRIPTION**

For adjusting and checking the engine timing when changing the cylinder head seal, replacing the timing chain etc.

**DELIVERY SCOPE**

Belt tensioner locking pin, use as OEM EN-6349, EN-6130  
Camshaft adjustment pin, use as OEM EN-51143  
Crankshaft alignment tool (including screws), use as OEM EN-51140  
Tensioning element locking pin, use as OEM EN-50513  
Camshaft sprocket holding tool (including screws), use as OEM EN-51188



ART.NR	ITEM NAME	PRICE
<b>BT595701</b>	Camshaft locking tool for Opel Astra, Vectra, Omega, Frontera, Sintra	<b>4,00 €</b>

**FOR THE FOLLOWING MODELS**

Opel Astra-G 2.0 16v, Vectra 1.8, 2.0 16V (start from 1995 onwards), Omega 2.0, 2.0 16V, 2.2, Frontera 2.2, Sintra 2.2 16V

**ENGINE CODES**

Engine code: C22SEL, X20SE, X20XEV, X22SE, X22XE, Y22SE, Z20LEH, Z20LEL, Z20LER, Z20LET



ART.NR	ITEM NAME	PRICE
<b>BT593920</b>	Engine adjustment tool set for Opel, Vauxhall 1.6 SIDI	<b>129,00 €</b>

**FOR THE FOLLOWING MODELS**

Opel Cascada, Astra J, Zafira C, Insignia (2013-2016) with SIDI, SIDI Turbo, SIDI Turbo EcoFLEX engines

**ENGINE CODES**

Engine codes: LVP/A16XHT, LWC/A16SHT, LVP/B16XHT, LWC/B16SHT, LWC/A16SHL

**DESCRIPTION**

For checking and adjusting the engine timing when replacing the timing chain

**DELIVERY SCOPE**

Camshaft alignment tool, use as OEM EN-51148  
Crankshaft pulley holding tool, use as OEM EN-51147  
Balance shaft holding tool, use as OEM EN-51153  
Chain tensioner locking pins, use as OEM EN-50513



ART.NR	ITEM NAME	PRICE
<b>BT595703</b>	Camshaft locking tool for Opel 1.6, 1.8	<b>7,00 €</b>

**DESCRIPTION**

Contains important tools for inspecting and adjusting the engine timing

Suitable for Opel Astra G/H, Corsa D, Insignia, Meriva, Signum, Tigra, Vectra C, Zafira B (2003-2012) with engine codes A16LET, A16XER, Z16LEL, Z16LER, Z16LET, Z16XE, Z16XE1, Z16XEP, Z16XER, Z18XER, A18XER

Also suitable for Alfa Romeo 159, Fiat Croma with engine code 939A4.000

**DELIVERY SCOPE**

Camshaft interlock, use as OEM KM-6340, EN-6340, 2000012100  
Tensioning element interlock, use as OEM KM-6333, EN-6333



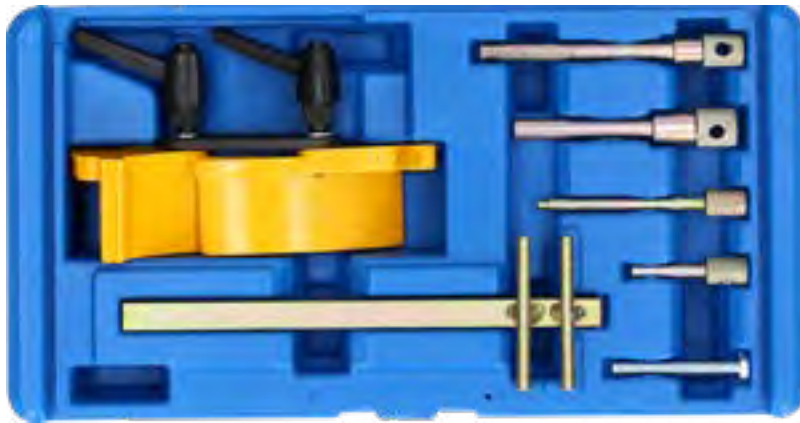

FITS FOR:



ART.NR	ITEM NAME	PRICE
<b>BT594570</b>	Engine adjustment tool set for Renault, Opel, Volvo, Mitsubishi, Chrysler	<b>41,00 €</b>

**FOR THE FOLLOWING MODELS**

Renault: Clio (1990-2013), Espace, Grand Espace (1996-2002), Extra, Rapid, Express (1991-2002), Kangoo (1998-2009), Laguna (1994-2001), Megane (1995-2003), Scenic (1996-2003), Modus, Grand Modus II (2004-2013), Safrane (1992-2001), Trafic (1997-2000), Master II (2000-2003), Twingo (2000-2013), Wind (2011-2013)

Opel: Arena (1997-2001), Movano-A (1999-2006), Vivaro (2001-2007)

Volvo: S40 (1996-2004), V40 (1996-2004)

Mitsubishi: Carisma (2001-2005), Space Star (2000-2006)

Chrysler: Cherokee (1984-1995), Wrangler (1988-1995)

**ENGINE CODES**

E7F 1.2: 700, 704, 706, 708, 750

D4F 1.2 16v: 702, 704, 706, 708, 712, 714, 716, 722, 728, 730, 740, 742, 764, 772, 780, 782, 784, 786

E7J 1.4: 601, 624, 626, 634, 635, 710, 711, 716, 718, 719, 754, 756, 757, 764, 780

F3P 1.8: 674, 676, 678, 710, 712, 714, 720, 724, 755, 758, B670, Q7, R7, S724

F7P 1.8 16v: 720, 722

F8Q 1.9D/Di/Turbo: 600, 606, 620, 622, 624, 630, 632, 644, 646, 648, 662, 672 /676, 678, 680, 682, 684, 692 /696, 714, 722, 724, 730, 732, 776, 784, 786, 788, 790, B640

F9Q 1.9D dTi: F9Q1, F9Q2, 710, 716, 717, 720, 722, 730, 731, 734, 736, 744, 760, 762, 770, 774, 780, 782, 790 D4192T, D4191T2 D4192T3, D4192T4

F3R 2.0: 611, 722, 723, 742, 750, 751, 752, 768, 769, 791, 796, 797, 798

J7R 2.0: 732, 733, 734, 735

F7R 2.0 16V: 700, 714, D710

J7T 2.2 16V: 760, 761

G8T 2.2D/Turbo: 706, 714, 716, 740, 752, 760, 790, 792, 794

**DESCRIPTION**

For adjusting the engine timing on Renault petrol and diesel engines

**DELIVERY SCOPE**

Camshaft locking tool, adjustable for DOHC engines

Injection pump wheel fixing mandrel, use as OEM Mot.910

Tension roller key, use as OEM Mot1135-01

Crankshaft fixing mandrel, use as OEM Mot.1318

Crankshaft fixing mandrel, use as OEM Mot.1054

Crankshaft fixing mandrel, use as OEM Mot.910

FITS FOR:



ART.NR	ITEM NAME	PRICE
<b>BT591260</b>	Camshaft sprocket locking tool set, universal	<b>72,50 €</b>

**FOR THE FOLLOWING MODELS**

Can be used universally on vehicles start from the following manufacturers: Audi, Alfa Romeo, Chrysler, Citroen, Ford, Honda, Hyundai, Isuzu, Land Rover, Lexus, Mazda, Mitsubishi, Peugeot, Renault, MG, Seat, Skoda, Subaru, Toyota, Opel, Volkswagen, Volvo

**DESCRIPTION**

For locking the camshaft sprockets e.g. when replacing the toothed belt

Suitable for engines with 1, 2 and 4 camshafts (V engines); also suitable for locking between the camshaft sprocket and diesel injection pump wheel in some diesel engines

**DELIVERY SCOPE**

Double camshaft locking tool with short and long connecting arm

Single camshaft locking tool with short and long locking screw





FITS FOR:

ART.NR	ITEM NAME	PRICE
<b>BT593970</b>	Engine adjustment tool set for GM, Opel, Vauxhall, Saab 2.0 Turbo	<b>51,00 €</b>

**FOR THE FOLLOWING MODELS**

Opel Signum Turbo, Vectra-C Turbo (2002-2008), Saab 9-3 1.8 Turbo (2002-2011), Saab 9-3 1.8 Turbo BioPower (2002-2011), Saab 9-3 2.0 Turbo (2002-2012), Saab 9-3 2.0 Turbo BioPower (2010-2012), Saab 9-3XT (2009-2011)

**ENGINE CODES**

Engine codes: Z20NET, B207, B207L, B207, B207L, B207, B207L, B207, B207L, B207, B207L

**DESCRIPTION**

For adjusting and checking the engine timing

**DELIVERY SCOPE**

- Crankshaft pulley holding tool, use as OEM KMJ38122-A, 8396210
- Intake camshaft alignment tool, use as OEM KM6362-1, EN-48366-001
- Discharge camshaft alignment tool, use as OEM KM6362-2, EN-48366-002
- Chain tensioner locking pin, use as OEM KM6077, 8396392



FITS FOR: **Universal**

ART.NR	ITEM NAME	PRICE
<b>BT596002</b>	Universal camshaft wheel puller	<b>63,00 €</b>

**DESCRIPTION**

For pulling the pulley and camshaft gear

Gripping arms are connected with each other via adjusting disk, thus the gripping arms can be set easily and exactly

Continuous adjustment range of the gripping arms start from 42 – 82 mm

Gripping arm depth is 27 mm

**DELIVERY SCOPE**

- 3 x gripping arms, Ø 12 mm, M10 x 1.5, suitable for material thickness up to max. 10 mm
- 6-groove puller body with adjusting disc
- Spindle, M14 x 1.5, 19 mm hex, with centring cone



FITS FOR:

ART.NR	ITEM NAME	PRICE
<b>BT593815</b>	Engine adjustment tool set for Opel, Saab, Buick, Cadillac, Chevrolet 2.8, 3.6 V6	<b>54,00 €</b>

**FOR THE FOLLOWING MODELS**

- Buick Enclave 3.6, engine code: LY7
- Cadillac SRX, STS, CTS 3.6, engine code: LY7, LLT
- Chevrolet Camaro 2.8, engine code: LTT, LFX
- Opel Insignia 2.8 V6 Turbo, engine code: LAU/A28NER
- Opel Antara 3.2 V6 (start from 2007 onwards), engine code: Z32SE
- Saab 9-5 2.8 (2009-2013), engine code: LAU/A28NER

**DESCRIPTION**

For adjusting and checking the engine timing

**DELIVERY SCOPE**

- Camshaft adjustment tools, use as OEM EN-48383-1, EN-48383-2, EN-48383-3
- Flywheel locking tools, use as OEM EN-46106
- Crankshaft turning tool, use as OEM EN-46111



# PEUGEOT



FITS FOR:



ART.NR	ITEM NAME	PRICE
<b>BT592880</b>	Engine adjustment tool set for Rover, Peugeot, Ford, Volvo 2.0, 2.2i D	<b>12,00 €</b>

#### FOR THE FOLLOWING MODELS

Peugeot 807 (2005, 2011), 407 (2005, 2011), 607 (2005, 2009), engine DW10UTED4 (RHK), DW10BTED4 (RHR)DW12BTED4 (4HS), (4HP), (4HT), (4HR)

Citroën C4 (2004, 2010), C5 II (2004, 2010), engine DW10BTED4 (RHR)

Land Rover Freelander (2006, 2010), engine DW12BTED4, 224DT

Volvo S40 (2003, 2010), V50 (2006, 2010), C70 (2006, 2010), S80 (2007, 2010), C30 (2006, 2010), V70 (2007, 2010), engine D420T 2.0D

Ford S-Max 2.2 (2008, 2010), Galaxy 2.2 (2008, 2010), Mondeo 2.2, 2.0 (2007, 2010)

#### ENGINE CODES

Engine codes: QXBA(2.2), QXWA(2.0), QXBB(2.0), Q4BA(2.2), QXWA(2.0), QXWB(2.0), AZBA(2.0), AZBC(2.0), AZWA(2.0)

#### DESCRIPTION

Makes it easier to check and adjust the engine timing

#### DELIVERY SCOPE

Camshaft interlock, use as OEM PSA 0188.M, Ford 303-735, 303-1277, Volvo 999-7122

Crankshaft interlock, use as OEM PSA 0188.X, Ford 303-1059, 303-1270, Volvo 999-7121

Flywheel interlock, use as PSA 0188.F, Ford 303-393A, 303-393-01, 303-1272, Volvo 999-7119/7120



FITS FOR:



ART.NR	ITEM NAME	PRICE
<b>BT592320</b>	Balance shaft adjustment tool set for Land Rover, Citroen, Mitsubishi, Peugeot, Ford 2.2 DOHC diesel engines	<b>42,00 €</b>

#### FOR THE FOLLOWING MODELS

Land Rover Discovery, Discovery Sport, Freelander 2, eD4, TD4, TD4e (2009-2015) engine codes: 224DT, DW12CTED4/224DT, DW12BTED4/224DT

Citroen C5, C5 II, C5 III, C6, C8, C-Crosser HDi (200-2015) engine codes: 4HX (DW12CTED4), 4HP (DW12BTED4), 4HX (DW12TED4), 4HW (DW12TED4/L4)

Mitsubishi Outlander DI-D, DI-DC (2007-2013) engine codes: 4HK, 4HN

Peugeot 4007, 407, 607, 807, 406, 508, 607, HDi, GT Hdi (2000-2015) engine codes: DW12MTED4 (4HK), DW12MTED4 (4HN), DW12BTED4 (4HP), DW12BTED4 (4HR), DW12BTED4 (4HT), DW12TED4/L4 (4HW), DW12BTED4 (4HS), DW12ATED (4HZ), DW12ATED4 (4HX), DW12ATED (4HZ), DW12CTED4 (4HL)

Ford Galaxy, Mondeo, S-Max, TDCI, TCI (2008-2015) engine codes: KNBB, KNBA, KNWA, Q4BA

#### DESCRIPTION

For adjusting the balance shaft

#### DELIVERY SCOPE

Balance shaft fixing tool, use as OEM 303-1329

Balancing tool, use as OEM 303-1330

Balance shaft adjustment tool, use as OEM 303-1328, 0190D



FITS FOR:

**Universal**

ART.NR	ITEM NAME	PRICE
<b>BT596002</b>	Universal camshaft wheel puller	<b>63,00 €</b>

#### DESCRIPTION

For pulling the pulley and camshaft gear

Gripping arms are connected with each other via adjusting disk, thus the gripping arms can be set easily and exactly

Continuous adjustment range of the gripping arms start from 42 – 82 mm

Gripping arm depth is 27 mm

#### DELIVERY SCOPE

3 x gripping arms, Ø 12 mm, M10 x 1.5, suitable for material thickness up to max. 10 mm

6-groove puller body with adjusting disc

Spindle, M14 x 1.5, 19 mm hex, with centring cone

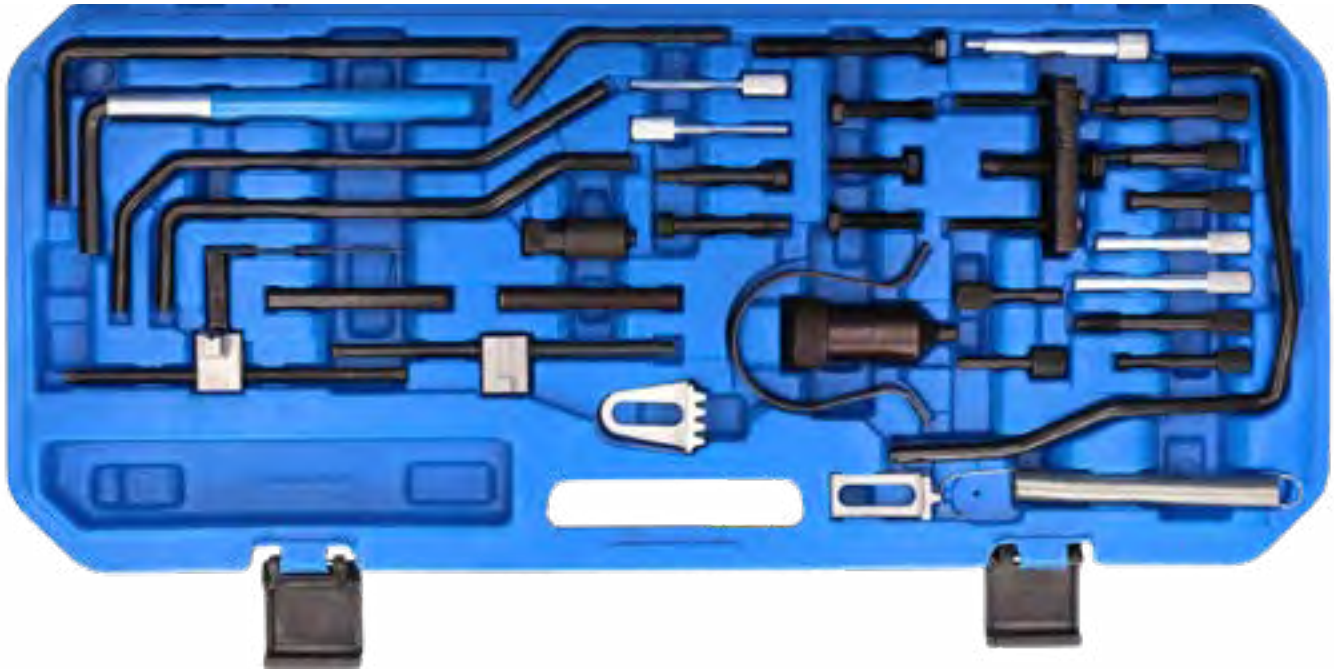

FITS FOR:



ART.NR	ITEM NAME	PRICE
<b>BT592250</b>	Engine adjustment tool set for PSA	<b>99,00 €</b>

**FOR THE FOLLOWING MODELS**

Petrol 1.0, 1.1, 1.4, 1.5, 1.6, 1.6 16V, 1.8, 1.8 16V, 1.9, 2.0, 2.0 16V, 2.0 Turbo  
 Diesel 1.4D, 1.4HDI, 1.5D, 1.7D, 1.7TD, 1.9D, 1.9TD, 2.0Hdi, 2.1TD, 2.1TD, 2.2D, 2.5TD, 2.2Hdi  
 Suitable for structurally identical engines in Toyota and Fiat

**ENGINE CODES**

159A, 161A, 171B, 171C, 171D, 180A, 180Z, 3FZ (EW12J4), 4HX (DW12ATED), 4HZ (DW12ATED) 6FZ (EW7J4), A8A, A9A, AJZ, B1A /E /F, B2C, B4A, B6D, B6E, BAY, BDY, BFZ, C1A, CDY, CDZ, D2A /C /E /F, D6A /B /D /E, D8A /B /C, D9B, DDZ, DFZ, DHV /W /X /Y, DJ5 (T9A), DJ5T (T8A), DJY, DJZ, DKZ, EW10J4D, EW7J4, H1A, HDY, HDZ, K1A, K1F, K1G, K2A, K2B, K2D, K3A, K6B, KDX, KDY, KDZ, KFW, KFX, KFY, KFZ, L6A, LFW, LFX, LFY (XU7JP4), LFZ, M4A, NFU, NFX (TU5J4/L3), P8A, P8B, P8C, P9A, PHZ (XUD11), R2A, R6A, R6D, RDZ, RFR, RFN (EW10J4), RFS, RFT, RFU, RFV, RFW, RFX, RFY, RFZ, RGX, RGY, RHW (DW10ATED4), RHY (DW10ATD), RHZ (DW10ATED/L), RLZ(EW10J4D), T8A/THZ (DJ5T), T9A (DJ5), THX (DJ5TED), THY (DK5ATE), TU1/2/3/5/9, TU1/3/5 (HFY, HFZ, KFX, NFZ), TU5J4/L3 (NFX), TU5JP4 (NFU), WJY (DW8B), WJZ (DW8), XU10J2C/Z, XU10J2CTE/L3, XU10J2TE/Z, XU10J4R/S (RFV/R6E/RFS), XU10J4RS (RFS), XU10J4RS (RFS), XU10-R2A, R5A, R6A, RDZ, XU5-171B, 180A, B1E, XU5-B6D/E, B1A, B1E, B2A, B2B, BDY, BDZ, XU5JP (BFZ), XU-7JP4 (LFY), XU7-L6A, LFW, LFX, LFZ, XU9-D2H, D6A, D6B, D6D, DDZ, DKZ, DFZ, XU9-D2A/D, XU9J4, XUD 11 BTE (P8C), XUD11A, XUD11ATE, XUD7 (A9A), XUD7TE, XUD9 (DHY), XUD9A (D9B/DJY), XUD9AU (D8C), XUD9SD (DHW), XUD9TF (D8B), XUD9UTF (DHX), XUD9Y (DJZ)

DESCRIPTION
For adjusting the engine timing e.g. when replacing the toothed belt

**DELIVERY SCOPE**

- Clamping tool, use as OEM 4507-TJ, 9767.89, 0188Q1, 0132X1Z, 0188Q1, 0132X1Z, 0132X
- Camshaft adjustment pin 6 mm, use as OEM 4507-TA, 0132Z, 0132QZ
- 2 crankshaft/camshaft adjustment pins, use as OEM 0153ZY, 4507-TB, 0153AB, 9041-TZ, 0132R, 9767.27
- 2 crankshaft/camshaft adjustment pins, use as OEM 0153ZY, 4507-TB, 0153AB, 9041-TZ, 0132R, 9767.27
- Flywheel locking pins, use as OEM 4507-TL, 0189C
- Adjustment tool, angled, 8 mm, use as OEM 0188D, 7004TG, 9767-34, 0153G, 7014-TJ, 1 860 863 000, 0153N
- Bolts M8 x 35 mm / M8 x 40 mm / M8 x 70 mm
- Flywheel adjustment pin, 7 mm, use as OEM 7017-TR
- Flywheel adjustment pin, 8 mm, use as OEM 1 860 863 000, OUT0000127, 0153N, 0288D, 7099-TM, 0188Y, 0188D
- Flywheel adjustment pin with spring, use as OEM 0188X, 0189X
- Camshaft adjustment pin, use as OEM 18G 1580, 11 9 790, 5711-TD, 21-260, 07744-1110400, 303-732, 4527-T.S2, 07744-00104-00, 1 860 617 000, 0132AB, 999 7169, 0178D
- Injection pump adjustment pin, use as OEM 0188H

- Crankshaft/camshaft adjustment pin, use as OEM 0188M, 0187B, 0194B, 303-1277, MOT1430, 0189B, 303-735, 49JE01 061, 21-263
- Injection pump adjustment pin, use as OEM 4527-T.S1
- Camshaft adjustment pin (CA1), use as OEM 4533-TAC1, 0132AJ1
- Camshaft adjustment pin (CA2), use as OEM 0132AJ2, 2000 023 000, 0188M, 4533-TAC2
- 2 camshaft adjustment pins, use as OEM 9041-TZ, 5711-TC
- Camshaft adjustment pin, use as OEM 0189A, 1 871 008 100
- Camshaft adjustment pin, use as OEM 0189AZ
- Intake camshaft adjustment pin (VTC), use as OEM 0189L
- Tension lever, use as OEM 5711-TE, 0178E, 0188J/J1
- Flywheel locking tool, use as OEM 0188F, 0134Q, 1 870 765 001, 1 870 827 000, 0134AF, 9044-T, 1 871 000 400
- Hdi tension lever, use as OEM 0188J2
- Tensioning spanner, 8 mm, use as OEM 7017-TW
- Toothed belt retaining clip, use as OEM 0189K, MOT1436, 4533-TAX, 0188K, 0187J, 0132AK, 0153AK, 1 870 00 100
- Flywheel locking tool, use as OEM 1 867 030 000, 0153A, 9765.54, 6012T, 1 860 161 000
- Roller extractor, use as OEM 0174, 0188P, 018892, 7015-T



ART.NR	ITEM NAME	PRICE
<b>BT597940</b>	Engine adjustment tool set for Peugeot, Citroën, PSA	<b>89,00 €</b>

**FOR THE FOLLOWING MODELS**

Citroën AX, Berlingo, BX, C5, C15, C25, Dispatch, Evasion, Jumper, Jumpy, Relay, Saxo, Synergie, Visa, Xsara, Xantia, XM, XJR, ZX, etc.

Peugeot 106, 205, 306, 405, 406, 605, 806, J5, Boxer, Expert, Partner, Solara, Talbot Express, Talbot Horizon, etc.

PSA petrol engines 1.9, 1.1, 1.4, 1.6, 1.8, 1.9, 2.0, 1.6, 1.8, 2.0, 2.2 16V (turbo and dual camshafts)

PSA diesel engines 1.4, 1.5, 1.7, 1.8, 1.9, 2.1, 2.5 D, TD, TDI, 1.4, 1.6, 2.0, 2.2 HDI

Suitable for structurally identical engines in Fiat, Ford, Nissan, Renault, Rover, Toyota, etc.

**DESCRIPTION**

For checking and adjusting the engine timing

**DELIVERY SCOPE**

Flywheel adjustment pin with spring, use as OEM 0188X, 0189X

Tensioning spanner, 8 mm, use as OEM 7017-TW

Flywheel fixing mandrel, 7 mm, use as OEM 7017-TR

Angled adjustment pin, 8 mm, use as OEM 0188D, 70Q4TG, 9767-34, 0153G, 7014-TJ, 1 860 863 000, 0153N

Clamping tool, use as OEM 4507-TJ, 9767.89, 0188Q1, 0132X1Z, 0132X

Camshaft marking mandrel, use as OEM 0189A, 1 871 008 100

Hdi tension roller lever, use as OEM 0188J2

Tension roller lever, use as OEM 5711-TE, 0178E, 0188JJ1

Flywheel disc extractor, use as OEM 0174.0186P, 018892, 7015-T

Toothed belt retaining clamp, use as OEM 0189K, MOT1436, 4533-TAX, 0188K, 0187J, 0132AK, 0153AK, 1 870 00 100

Flywheel retainer, use as OEM 0195K, 4507-TL

Clamping tool, use as OEM 0189S1

Flywheel retainer, use as OEM 1867030000, 0153A, 9765.54, 6012T, 1860161000

Tension lever, use as OEM 0189S2

Angled locking pin, 5 mm

Flywheel fixing mandrel (for automatic transmission), use as OEM 0189R

Camshaft marking mandrel, use as OEM 0189AZ

Crankshaft retainer, use as OEM 0288D, 0188Y, 7014

Flywheel fixing mandrel (manual transmission), use as OEM 0189C

Flywheel interlock, use as OEM 0186F, 0134G, 1870765001.1870827000, 0134AF, 9044-T, 1871000400

Camshaft marking mandrel (CA1), use as OEM 4533-TAC1, 0132AJ1

Camshaft and crankshaft retainer, use as OEM 0188M, 0187B, 0194B, 303-1277, MOT1430, 0189B, 303-735, 49JE01061, 21-263

Camshaft marking mandrel (CA2), use as OEM 0132AJ2, 2000023000, 0188M, 4533-TAC2

Marking mandrel for injection pump, use as OEM 4527-TS1

Injection pump fixing mandrel, use as OEM 0188H, 1 860 965 000

Flywheel fixing mandrel, use as OEM 49JE02020, 0194C, 21-262, 999-7121, 999-7169, 303-734

2 camshaft and crankshaft marking mandrels, use as OEM 4507-TB.7014-TN, 0132-R, 0153-AB, 0158-G

2 camshaft and crankshaft interlocks, use as OEM KM-955, 7014-TM

2 camshaft marking mandrels, use as OEM 9041-TZ, 5711-TC

2 crankshaft fixing mandrels, use as OEM 5711-TD, 119790, 0194A, 1860617000, 303-732, 07744-00104-00, 49JE02018, 0178D, 9997169, 4527-TS2, 21-260, 999-7169, 0132AB

Camshaft fixing mandrel, use as OEM 0189L

Screw M8 x 80 mm

Pin for clamping device, 3 mm, use as OEM 0153AL, 4200TA

Centring clip for crankshaft pulley, use as OEM 0188AH

Crankshaft marking mandrel, 6 mm, use as OEM 4507-TA, 0132Z, 0132QZ

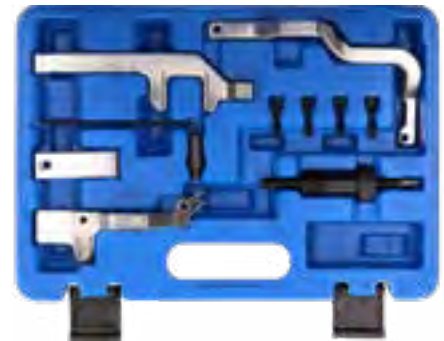
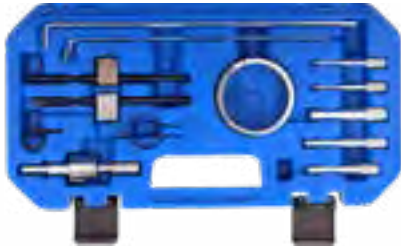

FITS FOR:



FITS FOR:



FITS FOR:



ART.NR	ITEM NAME	PRICE
<b>BT592300</b>	Engine adjustment tool set for PSA 1.8, 2.0 16V petrol	<b>45,00 €</b>

**FOR THE FOLLOWING MODELS**

Citroen C5 1.8, 2.0 HPI (2002, 2005) Xsara 2.0 16V (2002, 2005) Xsara, Picasso 1.8, 2.0 16V (2002, 2005)  
 Peugeot 406 1.8 16V (2000, 2004), 807 2.0 16V (2002, 2005)  
 Engine codes 6FZ (EW7J4) FRN (EW10J4, L4, 5) RLZ (EW10D)

**DESCRIPTION**

Contains important tools for checking and adjusting the engine timing when replacing the toothed belt and carrying out repairs on the engine

**DELIVERY SCOPE**

- Tension roller locking tools, use as OEM 0189S2
- Tool for tensioner, use as OEM 0178E, 5711TE, 178/J2
- Tools for tensioner, use as OEM 0188J2
- Adjustment tools for tensioning unit, use as OEM 0189S1
- Locking pins, use as OEM 0132AB, 0194A, 0178D
- Locking pin, use as OEM 0194B
- Locking pin, use as OEM 0188M
- Locking pin, use as OEM 0189B
- Flywheel locking tools, use as OEM 0189R
- Interlock for tensioning unit, use as OEM 7017TR, 0153U
- Adjustment tools for crankshaft wheel, use as OEM 0188AH

ART.NR	ITEM NAME	PRICE
<b>BT592520</b>	Engine adjustment tool set for Fiat Ducato, Peugeot Boxer, Citroën Jumper 2.3 D JTD, 3.0 JTD, HDi	<b>50,00 €</b>

**FOR THE FOLLOWING MODELS**

Citroen Relay/Jumper III  
 Fiat Ducato  
 Iveco Daily (03-10), Daily/EcoDaily (2009-2011)  
 Peugeot Boxer III (2006-2012)  
 2.3D, 2.3 JTD F1AE0418A, F1AE0481B, F1AE0481C, F1AE0481D, F1AE0481F, F1AE0481FA, F1AE0481G, F1AE0481H, F1AE0481HA, F1AE0481N, F1AE-0481UA.F1AE0481VA  
 3.0JTD F1CE0481A, F1CE0481B, F1CE0481D, F1CE0481F, F1CE0481H, F1CE3481M  
 3.0HDi F30DTE, F1CE0481D, F1CE3481DM, F1CE3481N

**DESCRIPTION**

Use as OEM Fiat 99360187, 99360614, 99360615.1860617000, 1860815000, 20000180200, Citroën/Peugeot 0191-2A, 0191-2B, 0191-2J, 0191-2K

**DELIVERY SCOPE**

- 2 camshaft fixing mandrels
- 1 crankshaft fixing mandrel

ART.NR	ITEM NAME	PRICE
<b>BT593800</b>	Engine adjustment tool set for MINI, PSA	<b>119,00 €</b>

**FOR THE FOLLOWING MODELS**

MINI One, Cooper HB, Cooper (R55-56) N12 engine  
 Citroen C4 (year of construction 2008, 2009), C4 Picasso (year of construction 2008, 2009)  
 Peugeot 207 (year of construction 2006, 2009), 207CC (year of construction 2007, 2009), 308 (year of construction 2001, 2009)  
 Engines: 1.4, 1.6 VTi, EP3 (8FS) EP6 (5FW), EP6C 1.6 THP, EP6DT (5FX) EP6DTS (5FY)

**DESCRIPTION**

Needed when replacing the cylinder head seal and when working on the engine timing

**DELIVERY SCOPE**

- Crankshaft fixer, use as OEM 119590, 0197-BZ
- Camshaft fixer, use as OEM 119540, 0197-A1, 0197-A3
- Chain tensioner, use as OEM 119340, 0197-M

**OUR PACE: HIGH**  
**OUR TECHNOLOGY: INNOVATIVE**



ART.NR	ITEM NAME	PRICE
<b>BT595700</b>	Camshaft locking tool set for VAG, Ford, Opel, Saab	<b>34,00 €</b>

DESCRIPTION	
Universal set for a wide range of models	
DELIVERY SCOPE	
Camshaft interlock for Opel Calibra, Omega, Sintra, Vectra -1.8, 2.0, use as OEM KM-852, 18G1570	
Camshaft interlock for Opel Calibra, Omega, Sintra, Vectra -1.4, 1.6, use as OEM KM-853	
Right camshaft with Saab 900, 900 -2.5, 3.0, Opel Calibra, Sintra, Vectra -2.5, 3.0, use as OEM KM-800-2	
Left camshaft with Saab 900, 900 -2.5, 3.0, Opel Calibra, Sintra, Vectra -2.5, 3.0, use as OEM KM-800-1	
Crankshaft toothed belt pulley interlock tool for TDI pump-injection engines with VW, Audi, Skoda, Seat and Ford, use as VAG T10050	
Flywheel interlock tools for Citroen, Fiat and Peugeot, use as OEM 153A, 6012T, 9765.54	
Flywheel holder unit for Isuzu 1.5 and 1.7 diesel, Opel 1.6, 1.7 diesel engines, Opel 1.2, 1.4, 1.6, 1.8, 2.0 OHC petrol engines, use as OEM KM-517-B	



ART.NR	ITEM NAME	PRICE
<b>BT594460</b>	Engine adjustment tool set for PSA 2.5, 2.8 l diesel	<b>12,00 €</b>

FOR THE FOLLOWING MODELS	
Citroen, Peugeot, Fiat, Iveco Traffic (1980-2000), Master (1980-2007), Mascot (1999-2007)	
Fiat, PSA, Renault Daily (1991-2005), Turbo Daily (1994-2000), Relay, Jumper (2001-2002) Boxer (2000-2006), Arena (1997-2001), Movano (1998-2003)	
DESCRIPTION	
Use as OEM Fiat 1 870 667 000, 1 870 765 001, 1 860 617 000, Renault MOT861, MOT1054, MOT863, Opel KM6031, Ford 21-260, 303-732, Peugeot 0132AB, 5711TD, 4527TS2, 0178D, 0194A, 119790, Citroen 0132AB, 5711TD, 4527TS2, 0178D, 0194A, 119790, Mazda 49 JE 02018, 0991246510, Volvo 999-7169	
DELIVERY SCOPE	
2 locking bolts	
Flywheel locking bolt	
Holding tool for toothed belt tensioner	



ART.NR	ITEM NAME	PRICE
<b>BT592860</b>	Engine adjustment tool set for Ford TDCi, PSA Hdi, Mazda D 1.4, 1.6	<b>5,00 €</b>

FOR THE FOLLOWING MODELS	
Citroen 1.4HDi DV4TD (8HT/8HW/8HX/8HZ), 1.4HDi DV4TED4 (8HV/8HY), 1.6HDi DV6TED4 (9HY/9HZ), 1.6HDi DV6ATED4 (9HW/9HX), 1.6HDi DV6UT-ED4(9HU)	
Mazda 1.4CiTD F6JA, F6JB 1.6CiTD Y6	
Peugeot 1.4HDi DV4TD (8HT/8HW/8HX/8HZ), 1.4HDi DV4TED4 (8HV/8HY), 1.6HDi DV6TED4 (9HY/9HZ), 1.6HDi DV6ATED4 (9HW/9HX), 1.6HDi DV6UT-ED4(9HU)	
Ford 1.4TDCi F6JA, F6JB, F6JC, F6JD 1.6TDCi G8DA, G8DB, HHDA 1.6TDCi HHDB, HHJA, HHJB, HHJD	
Volvo 1.6D D4164T	
DESCRIPTION	
For adjusting the engine timing when replacing the camshaft, cylinder head seal etc.	
DELIVERY SCOPE	
Flywheel locking bolt, use as OEM PSA 0194-C, Ford 303-734 (21-262), Volvo 999-7169, Mazda 49 JE02 020	
Crankshaft and high-pressure pump wheel locking pin, 2 pcs, use as OEM PSA 0194-A, Ford 303-732 (21-260), Volvo 999-7233, Mazda 49 JE02 018	
Crankshaft and high-pressure pump wheel locking pin, 2 pcs, use as OEM PSA 0194-A, Ford 303-732 (21-260), Volvo 999-7233, Mazda 49 JE02 018	

**BT023172**  
**EAN 4042146777688**  
Socket set, 172 pcs.

**172**  
pcs.



**1/4"**  
6,3 mm  
**3/8"**  
10 mm  
**1/2"**  
12,5 mm



**79,- €**





FITS FOR:

ART.NR	ITEM NAME	PRICE
BT593750	Engine adjustment tool set for MINI	145,00 €

**FOR THE FOLLOWING MODELS**

Suitable for the following models: MINI One, Cooper, Cooper S, Cooper S JC Cooper S JCW (series R50, 52, 53, 55, 56, 57)

**ENGINE CODES**

For engine codes W10, W11, N14

**DESCRIPTION**

For working on intake and exhaust camshafts

**DELIVERY SCOPE**

- Fixing of camshafts, use as OEM 119551 and 119552
- Fixing of crankshaft, use as OEM 119590
- Tools for chain tensioner, use as OEM 119340



FITS FOR:

ART.NR	ITEM NAME	PRICE
BT592530	Engine adjustment tool set for Fiat, Peugeot, Citroën 1.8, 2.0 8V petrol	10,00 €

**DESCRIPTION**

For checking and adjusting the engine timing  
Suitable for engine codes LFW, RFU, RGX, RFW

Use as OEM 0132Q, 0132QZ, 0132Z, 0132R, 1053AA, 1053AB, 1053ZY, 0153G, 4507TA, 4507TB, 5711TA, 7014TN, 9767.27, 7014TM, 0132X, 0132X1Z, 4507T, 4507TJ, 1860755000, 1860161000, KM955

**DELIVERY SCOPE**

- Crankshaft interlock, 6 mm
- Camshaft interlock, 10 mm
- Camshaft locking pins, 2x
- Tool for toothed belt tensioner



FITS FOR:

ART.NR	ITEM NAME	PRICE
BT597990	Engine adjustment tool set for Peugeot, Citroën 1.0, 1.2 Vti	105,00 €

**FOR THE FOLLOWING MODELS**

Peugeot 208, 2008 (2012 to 2014)  
Citroën C3 (III)

**ENGINE CODES**

EBO (ZMZ), EB2 (HMZ)

**DESCRIPTION**

For checking and adjusting the engine timing

Needed e.g. when working on the valve train and replacing the cylinder head seal



FITS FOR:

ART.NR	ITEM NAME	PRICE
BT591870	Engine adjustment tool set for MINI, Citroën, Peugeot 1.6L diesel	15,00 €

**FOR THE FOLLOWING MODELS**

BMW MINI, MINI Clubman, series R55, R56, R57  
Citroën C2, C3, C4, C5, Grand Picasso, Berlingo (MK3), Xsara Picasso  
Peugeot 206, 206cc, 207, 207cc, 1007, 307, 308, 308cc, 3008, 5008, Partner (MK3)

**ENGINE CODES**

Engine codes: BMW: W16D16 (9HZ), W16D16UO, PSA: 9HZ, 9HX, 9HY (DV6TED4)

**DESCRIPTION**

For adjusting and checking the engine timing

Suitable for the following models with a 1.6L diesel engine

**DELIVERY SCOPE**

- Crankshaft marking pin, use as OEM PSA 0194A, BMW 119790
- Marking pins for camshaft and high-pressure pump, use as OEM PSA 0194B, BMW 110300
- Flywheel interlock, use as OEM PSA 0194C, BMW 119850, 119851, 119852

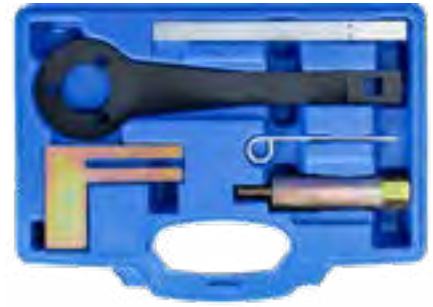

FITS FOR:

ART.NR	ITEM NAME	PRICE
BT591580	Engine adjustment tool set for BMW, MINI, PSA	69,00 €

**FOR THE FOLLOWING MODELS**

BMW 1.6 (N40, N45, N45T, B16, B16A, B16AC) 1.8, 2.0 (N42, N46, N46T) 2.0, 3.0 (N51, N52, N52K, N53, N54)

PSA 1.4, 1.6 16V (EP3, EP6, EP6DT, EP6DTS)

MINI 1.4, 1.6 (N12, N14)

**DESCRIPTION**

For aligning new and old versions of balance shafts

Prevents non-concentric engine running due to incorrectly aligned balance shafts

Needed when changing the timing chain, replacing the crankshaft sealing ring, replacing the cylinder head seal etc.

Use as OEM 115140, 119280, 119330

**DELIVERY SCOPE**

- Balance shaft fixing tool (old and new version)
- Crankshaft counter support
- Locking pin for chain tensioner



FITS FOR:



ART.NR	ITEM NAME	PRICE
BT591260	Camshaft sprocket locking tool set, universal	72,50 €

**FOR THE FOLLOWING MODELS**

Can be used universally on vehicles start from the following manufacturers: Audi, Alfa Romeo, Chrysler, Citroën, Ford, Honda, Hyundai, Isuzu, Land Rover, Lexus, Mazda, Mitsubishi, Peugeot, Renault, MG, Seat, Skoda, Subaru, Toyota, Opel, Volkswagen, Volvo

**DESCRIPTION**

For locking the camshaft sprockets e.g. when replacing the toothed belt  
Suitable for engines with 1, 2 and 4 camshafts (V engines); also suitable for locking between the camshaft sprocket and diesel injection pump wheel in some diesel engines

**DELIVERY SCOPE**

Double camshaft locking tool with short and long connecting arm  
Single camshaft locking tool with short and long locking screw



**WORK  
BRILLIANT:**  
**WWW.BRILLIANT-TOOLS.COM**

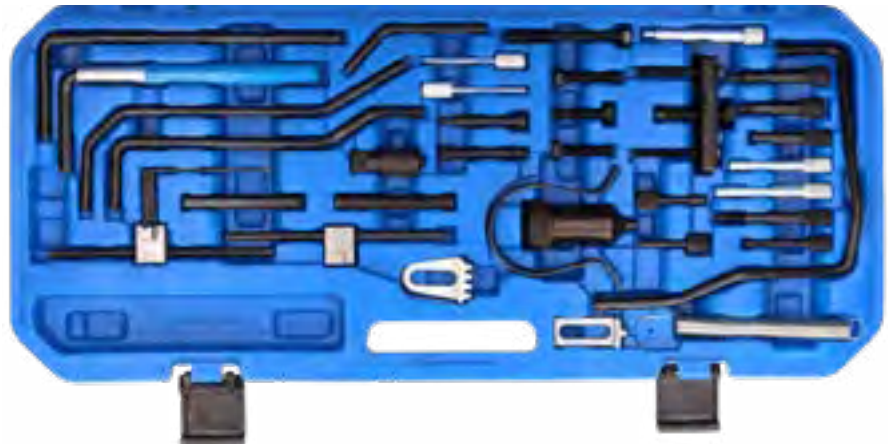

FITS FOR:



ART.NR	ITEM NAME	PRICE
BT592250	Engine adjustment tool set for PSA	99,00 €

**FOR THE FOLLOWING MODELS**

Petrol 1.0, 1.1, 1.4, 1.5, 1.6, 1.6 16V, 1.8, 1.8 16V, 1.9, 2.0, 2.0 16V, 2.0 Turbo  
Diesel 1.4D, 1.4HDI, 1.5D, 1.7D, 1.7TD, 1.9D, 1.9TD, 2.0Hdi, 2.1TD, 2.1TD, 2.2D, 2.5TD, 2.2Hdi  
Suitable for structurally identical engines in Toyota and Fiat

**ENGINE CODES**

159A, 161A, 171B, 171C, 171D, 180A, 180Z, 3FZ (EW12J4), 4HX (DW12ATED), 4HZ (DW12ATED) 6FZ (EW7J4), A8A, A9A, AJZ, B1A /E /F, B2C, B4A, B6D, B6E, BAY, BDY, BFZ, C1A, CDY, CDZ, D2A /C /E /F, D6A /B /D /E, D8A /B /C, D9B, DDZ, DFZ, DHV /W /X /Y, DJ5 (T9A), DJ5T (T8A), DJY, DJZ, DKZ, EW10J4D, EW7J4, H1A, HDY, HDZ, K1A, K1F, K1G, K2A, K2B, K2D, K3A, K6B, KDX, KDY, KDZ, KFW, KFX, KFY, KFZ, L6A, LFW, LFX, LFY (XU7JP4), LFZ, M4A, NFU, NFX (TU5J4/L3), P8A, P8B, P8C, P9A, PHZ (XUD11), R2A, R6A, R6D, RDZ, RFR, RFN (EW10J4), RFS, RFT, RFU, RFV, RFW, RFX, RFY, RFZ, RGX, RGY, RHW (DW10ATED4), RHY (DW10ATD), RHZ (DW10ATED/L), RLZ(EW10J4D), T8A/THZ (DJ5T), T9A (DJ5), THX (DJ5TED), THY (DK5ATE), TU1/2/3/5/9, TU1/3/5 (HFY, HFZ, KFX, NFZ), TU5J4/L3 (NFX), TU5JP4 (NFU), WJY (DW8B), WJZ (DW8), XU10J2C/Z, XU10J2CTE/L3, XU10J2TE/Z, XU10J4R/S (RFV/R6E/RFS), XU10J4RS (RFS), XU10J4RS (RFS), XU10-R2A, R5A, R6A, RDZ, XU5-171B, 180A, B1E, XU5-B6D/E, B1A, B1E, B2A, B2B, BDY, BDZ, XU5JP (BFZ), XU-7JP4 (LFY), XU7-L6A, LFW, LFX, LFZ, XU9-D2H, D6A, D6B, D6D, DDZ, DKZ, DFZ, XU9-D2A/D, XU9J4, XUD 11 BTE (P8C), XUD11A, XUD11ATE, XUD7 (A9A), XUD7TE, XUD9 (DHY), XUD9A (D9B/DJY), XUD9AU (D8C), XUD9SD (DHW), XUD9TF (D8B), XUD9UTF (DHX), XUD9Y (DJZ)

**DESCRIPTION**

For adjusting the engine timing e.g. when replacing the toothed belt

**DELIVERY SCOPE**

Clamping tool, use as OEM 4507-TJ, 9767.89, 0188Q1, 0132X1Z, 0188Q1, 0132X1Z, 0132X  
Camshaft adjustment pin 6 mm, use as OEM 4507-TA, 0132Z, 0132QZ  
2 crankshaft/camshaft adjustment pins, use as OEM 0153ZY, 4507-TB, 0153AB, 9041-TZ, 0132R, 9767.27  
2 crankshaft/camshaft adjustment pins, use as OEM 0153ZY, 4507-TB, 0153AB, 9041-TZ, 0132R, 9767.27

Flywheel locking pins, use as OEM 4507-TL, 0189C

Adjustment tool, angled, 8 mm, use as OEM 0188D, 7004TG, 9767-34, 0153G, 7014-TJ, 1 860 863 000, 0153N

Bolts M8 x 35 mm / M8 x 40 mm / M8 x 70 mm

Flywheel adjustment pin, 7 mm, use as OEM 7017-TR

Flywheel adjustment pin, 8 mm, use as OEM 1 860 863 000, OUT0000127, 0153N, 0288D, 7099-TM, 0188Y, 0188D

Flywheel adjustment pin with spring, use as OEM 0188X, 0189X

Camshaft adjustment pin, use as OEM 18G 1580, 11 9 790, 5711-TD, 21-260, 07744-1110400, 303-732, 4527-T.S2, 07744-00104-00, 1 860 617 000, 0132AB, 999 7169, 0178D

Injection pump adjustment pin, use as OEM 0188H

Crankshaft/camshaft adjustment pin, use as OEM 0188M, 0187B, 0194B, 303-1277, MOT1430, 0189B, 303-735, 49JE01 061, 21-263

Injection pump adjustment pin, use as OEM 4527-T.S1

Camshaft adjustment pin (CA1), use as OEM 4533-TAC1, 0132AJ1

Camshaft adjustment pin (CA2), use as OEM 0132AJ2, 2000 023 000, 0188M, 4533-TAC2

2 camshaft adjustment pins, use as OEM 9041-TZ, 5711-TC

Camshaft adjustment pin, use as OEM 0189A, 1 871 008 100

Camshaft adjustment pin, use as OEM 0189AZ

Intake camshaft adjustment pin (VTC), use as OEM 0189L

Tension lever, use as OEM 5711-TE, 0178E, 0188J/J1

Flywheel locking tool, use as OEM 0188F, 0134Q, 1 870 765 001, 1 870 827 000, 0134AF, 9044-T, 1 871 000 400

Hdi tension lever, use as OEM 0188J2

Tensioning spanner, 8 mm, use as OEM 7017-TW

Toothed belt retaining clip, use as OEM 0189K, MOT1436, 4533-TAX, 0188K, 0187J, 0132AK, 0153AK, 1 870 00 100

Flywheel locking tool, use as OEM 1 867 030 000, 0153A, 9765.54, 6012T, 1 860 161 000

Roller extractor, use as OEM 0174, 0188P, 018892, 7015-T



FITS FOR:



ART.NR	ITEM NAME	PRICE
BT593180	Engine adjustment tool set for Jaguar, Land Rover 2.7, 3.0 TD V6	67,00 €

FOR THE FOLLOWING MODELS

Citroen C5 III (2007 - 2009), C6 (2005 - 2009)  
 Jaguar S-Type (2004 - 2008), XF (2008 - 2012), XJ (2010 - 2012), XJ6 (2005 - 2010)  
 Range Rover Sport (2005 - 2009)  
 Peugeot 407 (2004 - 2009), 407 Coupe (2006 - 2009), 607 (2004 - 2011) 2.7TD V6, TDVi (276DT) 2.7D HDi (DT17BTED4) (UHZ) 3.0D HDi (D2OCTED4) (X8Z) 3.0D SD V6, TD V6 (306DT) (AJ-V6D)

DESCRIPTION

For checking and adjusting the engine timing  
 Needed e.g. when working on the valve train and replacing the cylinder head seal

DELIVERY SCOPE

Flywheel interlock (manual), use as OEM (Rover) 303-1116  
 Flywheel interlock (automatic), use as OEM (Rover) 303-1117  
 Camshaft sprocket adjustment pin, use as OEM (Rover) 303-1132  
 Camshaft sprocket adjustment pin, 2 pcs, use as OEM (Rover) 303-1126, (PSA) 0195H  
 Water pump locking pin, use as OEM (PSA) 0195-C  
 Flywheel locking tool, use as OEM (PSA) 0195-K  
 Toothed belt retaining clip, use as OEM (PSA) 0188-K



FITS FOR:



ART.NR	ITEM NAME	PRICE
BT593160	Engine adjustment tool set for Jaguar, Land Rover, Ford, Citroën 2.0, 2.2, 2.4, 3.2 diesel	105,00 €

FOR THE FOLLOWING MODELS

Ford Mondeo (2000 - 2007), Transit (2000 - 2011)  
 Citroen Relay (2006 - 2011), Jumper III  
 Fiat Ducato (2006 - 2011)  
 Jaguar X-Type (2001 - 2010)  
 Land Rover Defender (2007 - 2011)  
 Peugeot Boxer III (2006 - 2011)  
 LDV Convoy (2002 - 2006)  
 with DURATORQ (PUMA) diesel engines

ENGINE CODES

2.0L engine code ABFA, D3FA, D5BA, D6BA, F3FA, F1FA, FMBA, HJBA, HJBB, HJBC, HJBE, N7BA, N7BB  
 2.2L (with chain-driven high-pressure pump), engine code QJBA (BG), QJBB, QJBC, QJBD  
 2.2L (high-pressure pump driven via camshaft), engine code 4HM, 4HU, 4HV, P8FA, P22DTE, QVFA, QWFA

2.4L with engine code 244DT, DOFA, D2FA, D2FB, D4FA, F4FA, FXFA, H9FA, H9FB, HE FA, HFFA, JXFA, PHFA, ZSD 424

3.2L with engine code SAFA (timing only)

DESCRIPTION

For checking and adjusting the engine timing  
 Needed e.g. when working on the valve train and replacing the cylinder head seal

DELIVERY SCOPE

Engine cover adjustment tool, use as OEM 303-682  
 Tool for engine cover/crankshaft radial sealing ring, use as OEM 303-679A  
 High-pressure pump wheel holding tool, use as OEM 303-1151  
 High-pressure pump wheel disassembly tool, use as OEM 303-249  
 Flywheel locking bolt, use as OEM 303-675  
 Flywheel locking bolt, use as OEM 303-698  
 Locking pin set, 3 pcs, 6 mm  
 Tensioner locking pin, 2 mm

2 pcs.

BT546000  
 EAN 4042146779149

Double cup valve grinder set



Ø 21 mm

Ø 16 mm



Ø 34 mm

Ø 28 mm

5,- €

# PORSCHE



FITS FOR:



ART.NR	ITEM NAME	PRICE
<b>BT598100</b>	Engine adjustment tools for Porsche Panamera, Cayenne V8	<b>275,00 €</b>

#### DESCRIPTION

For adjusting the camshaft timing

Needed when changing the cylinder head seal, replacing the camshafts etc.

#### DELIVERY SCOPE

Camshaft adjustment tool, suitable for Panamera, Cayenne after 2008, use as OEM 9678/1

Camshaft adjustment tool, suitable for Cayenne, use as OEM 9678

Auxiliary chain tensioner, suitable for Cayenne after 2008, use as OEM 9683/1

27 mm socket spanner, 10 mm (3/8") drive, 30 mm long, suitable for Cayenne, use as OEM 9714

Crankshaft alignment tool, use as OEM 9595/1



FITS FOR:



ART.NR	ITEM NAME	PRICE
<b>BT598130</b>	Engine adjustment tool set for Porsche Boxster, 911	<b>329,00 €</b>

#### FOR THE FOLLOWING MODELS

Porsche Boxster (986, 987) 2.5L (start from 1998 onwards), 2.7L (start from 2000 onwards), 3.2L (start from 2000 onwards)

Porsche 911 (996, 997) 3.6L (start from 2002 onwards), 3.4L (start from 2002 onwards)

#### DESCRIPTION

For adjusting the engine timing

#### DELIVERY SCOPE

Pin driver, extension, use as OEM 9602

Alignment tool, use as OEM 9608

OT adjustment pin, use as OEM 9595

Camshaft interlock, use as OEM 9612

Camshaft support, use as OEM 9611

Camshaft holding tool, use as OEM 9634



FITS FOR:



ART.NR	ITEM NAME	PRICE
<b>BT598120</b>	Engine adjustment tool set for Porsche Macan 3.0S, 3.6 Turbo	<b>71,00 €</b>

#### FOR THE FOLLOWING MODELS

Porsche Macan 3.0S, 3.6 Turbo

#### ENGINE CODES

Engine codes: MCT.M, MCT.L

#### DESCRIPTION

Needed when changing the timing chain, replacing the cylinder head seal etc.

Supplementary set for Art. BT598100

#### DELIVERY SCOPE

Camshaft adjustment tools, use as OEM 9861

**BT011021**  
**EAN 4042146782002**  
**Ring open-ended spanner set**

**21**  
pcs.



**69,00 €**

**21x**



6 • 7 • 8 • 9 • 10 • 11 • 12 •  
13 • 14 • 15 • 16 • 17 • 18 •  
19 • 20 • 21 • 22 • 24 • 27 •  
30 • 32 mm



FITS FOR:



ART.NR	ITEM NAME	PRICE
BT594420	Engine adjustment tool set for Porsche 911, Cayman, Boxster with MA1 engine	309,00 €

**FOR THE FOLLOWING MODELS**

Porsche 911 Coupe, Cabrio, Targa 3.6 (997) (253 KW), engine code MA1/02, 911 Coupe S, Cabrio S, Targa S 3.8 (997) (283 KW), engine code MA1/01, 911 Coupe, Cabrio, Targa 3.6 (997) (254 KW), engine code MA1/02, 911 Coupe S, Cabrio S, Targa S 3.8 (997) (283, 300 KW), engine code MA1/01, 911 Turbo 3.8 (997) (368 KW), engine code MA1/70, 911 Turbo 3.8 (997) (368, 390 KW), engine code MA1/70, 911 S 3.8 (991) (294 KW), engine code MA1/03, 911 3.4 (991) (257 KW), engine code MA1/04, 911 GT3 3.8 (991) (350 KW), engine code MA1/75, 911 GT3 RS 4.0 (991) (373 KW), engine code MA1/76, 911 Turbo 3.8 (991) (383 KW), engine code MA1/71, 911 Carrera 3.6 (997) (239 KW), engine code MA1/02, 911 Carrera S 3.8 (997) (283, 300 KW), engine code MA1/01, MA1/01S, 911 Turbo, Turbo S 3.8 (997) (368, 390 KW), engine code MA1/70, MA1/70S, Boxster 2.9 (987) (155, 188 KW), engine code MA1/20, Boxster S, Spyder 3.4 (987) (228, 235 KW), engine code MA1/21, MA1/21C, Boxster 2.7 (981) (155, 195 KW), engine code MA1/22, Boxster 3.4 (981) (232 KW), engine code MA1/3, Boxster 3.4 (981) (232 KW), engine code MA1/23, Cayman, S 2.9, 3.4 (987) (155, 195 KW), engine code MA1/20C, Cayman 2.7 (981) (155, 202 KW), engine code MA1/22C, Cayman S 3.4 (981) (239 KW), engine code MA1/23C

**DESCRIPTION**

For turning and aligning the crankshaft and camshaft when removing or replacing the timing chain

**DELIVERY SCOPE**

- Camshaft adjustment tool, use as OEM 9772
- Crankshaft pulley turning tool, use as OEM 9773
- Crankshaft locking pin, use as OEM 9595/1
- Pulley holding tool, use as OEM 9775



FITS FOR:



ART.NR	ITEM NAME	PRICE
BT598110	Engine adjustment tool set for Porsche 911 (996, 997)	129,00 €

**DESCRIPTION**

For adjusting the camshaft timing  
Needed when changing the cylinder head seal, replacing the camshafts etc.

**DELIVERY SCOPE**

- 1 camshaft holding tool, suitable for engine M96/03, use as OEM 9685
- 1 camshaft retainer, suitable for engines M97/01 and M96/03, use as OEM 9686
- 2 centring pins, suitable for engines M97/01 and M96/03, use as OEM 9595, 9595/1



FITS FOR:



ART.NR	ITEM NAME	PRICE
BT594410	Crankshaft fixing tool, for Porsche Boxster, 911 M96	32,00 €

**FOR THE FOLLOWING MODELS**

Porsche Boxster (986) 2.5, Boxster (986) 2.7, Boxster (986) 3.2, 911 (996) 3.4

**ENGINE CODES**

Engine codes: M96/20, M96/22, M96/21, M96/01, M96/01S

**DESCRIPTION**

Suitable for fixing the crankshaft and bracing the camshaft adjustment

**DELIVERY SCOPE**

- Fixing pin for crankshaft pulley, use as OEM 9595/1, 00072195951
- 2 clamping screws (left-hand thread), use as OEM 9632/1, 00072196321
- 2 clamping screws (right-hand thread), use as OEM 9632, 00072196320



# RENAULT

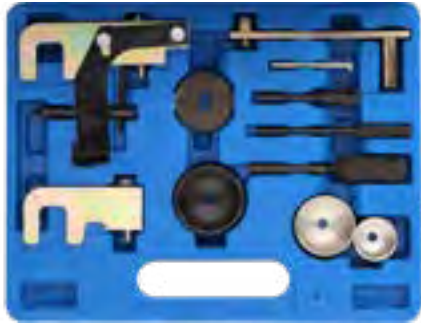

ART.NR	ITEM NAME	PRICE
<b>BT594550</b>	Engine adjustment tool set for Renault, Opel, Nissan	<b>59,00 €</b>

#### FOR THE FOLLOWING MODELS

Renault Avantime (2005, 2007), Clio (2001, 2008), Espace (2000, 2008), Kangoo (2000, 2008), Laguna (1999, 2001), Laguna II (2004, 2007), Master (2000, 2006), Megane (1999, 2008), Modus (2004, 2008), Scenic (1999, 2008), Traffic (2001, 2008), Twingo (2007, 2008)

Nissan Almera N16 (2002, 2006), Interstar (2002, 2006), Kubistar (2003, 2008), Micra K12 (2003, 2008), Note (2006, 2008), Primastar (2002, 2007), Primera P12 (2003, 2007), Qashqai (2008, 2009)

Opel Movano (2000, 2008), Vivaro (2001, 2008)

#### ENGINE CODES

Engine codes: 1.5 (K9K), 1.9 (F9Q), 2.2 (G9T), 2.5 (G9U)

#### DESCRIPTION

For positioning and locking the crankshaft and camshaft when repairing the toothed belt or engine

#### DELIVERY SCOPE

- Intake camshaft interlock OEM KM6205 (MOT1534)
- Discharge camshaft interlock, use as OEM KM6204 (MOT1537)
- Injection pump interlock, use as OEM MOT1538
- Tensioning tool set (5 pcs), use as OEM MOT1543
- Locking pin, use as OEM MOT1430
- Crankshaft locking pin, use as OEM MOT1536



ART.NR	ITEM NAME	PRICE
<b>BT594670</b>	Engine adjustment tool set for Renault, Volvo, Ford 16V, 20V petrol	<b>29,00 €</b>

#### FOR THE FOLLOWING MODELS

Renault Laguna (1996, 1999), Safrane (1996, 2001) with engine codes: N7Q 704, 710, 711 N7U 700, 701

Ford Kuga (start from 02/2008 onwards), Focus ST RS (start from 07/2004 onwards), S-Max (start from 03/2006 onwards), Galaxy (start from 03/2006 onwards), Mondeo (start from 02/2007 onwards) with engine codes: JZDA, HYDB, HYDC, HUWA

Volvo 850 (1992, 1997), C70 (1998, 2002), S40 (1996, 2004), V40 (1996, 2004), S60 (2001, 2005), S70 (1997, 2000), S80 (1999, 2005) with engine codes: B4164 S/S2, B4184 S/S2/S3/S9/S10, B4194 T/T2, B4204 S/S2/T/T2/T3/T5, B5202 FS, B5204 FT/T2/T3/T4/T5, B5234 T3/T4/T5/T6/T7/T8/T9, B5244 S/S2/SG/SG2/T3/T4/T5/T7, B5252 FS, B5254 T/T2/T4

#### DESCRIPTION

Contains important tools for adjusting the engine timing  
1.6, 1.8, 1.9, 2.0, 2.3, 2.4, 2.5L DOHC engines

#### DELIVERY SCOPE

- Camshaft retainer, use as OEM MOT1337, 999-5452, 303-1178
- Tension roller key, use as OEM MOT1348
- Flywheel retainer, use as OEM MOT1340, 999-5451, 303-1182



ART.NR	ITEM NAME	PRICE
<b>BT594652</b>	Crankshaft fixing mandrel for Renault	<b>4,00 €</b>

#### FOR THE FOLLOWING MODELS

Renault, Nissan, Mercedes

#### DESCRIPTION

For locking the crankshaft when working on the engine control unit.

#### DELIVERY SCOPE

to be used like OEM tools MOT1489, KV113B0130, 0991958110, W607589001500



ART.NR	ITEM NAME	PRICE
<b>BT594460</b>	Engine adjustment tool set for PSA 2.5, 2.8 l diesel	<b>12,00 €</b>

#### FOR THE FOLLOWING MODELS

Citroen, Peugeot, Fiat, Iveco Traffic (1980-2000), Master (1980-2007), Mascot (1999-2007)

Fiat, PSA, Renault Daily (1991-2005), Turbo Daily (1994-2000), Relay, Jumper (2001-2002) Boxer (2000-2006), Arena (1997-2001), Movano (1998-2003)

#### DESCRIPTION

Use as OEM Fiat 1 870 667 000, 1 870 765 001, 1 860 617 000, Renault MOT861, MOT1054, MOT863, Opel KM6031, Ford 21-260, 303-732, Peugeot 0132AB, 5711TD, 4527TS2, 0178D, 0194A, 119790, Citroen 0132AB, 5711TD, 4527TS2, 0178D, 0194A, 119790, Mazda 49 JE 02018, 0991246510, Volvo 999-7169

#### DELIVERY SCOPE

- 2 locking bolts
- Flywheel locking bolt
- Holding tool for toothed belt tensioner



ART.NR	ITEM NAME	PRICE
<b>BT594653</b>	Flywheel fixing pin for Renault	<b>3,00 €</b>

#### FOR THE FOLLOWING MODELS

Renault, Nissan, Mercedes

#### DESCRIPTION

For locking the crankshaft when working on the engine control unit.

#### DELIVERY SCOPE

to be used like OEM tools MOT1054, KV113B0110, 0991246510, W607589011500



FITS FOR:

ART.NR	ITEM NAME	PRICE
BT593830	Retaining device for toothed belt pulley of the high-pressure pump	29,00 €

DESCRIPTION
Suitable for diesel engines with the identifier F9Q
Installed in vehicles manufactured by Opel, Renault, Nissan
Toothed belt does not need to be removed
Precise fixing of the pump wheel thanks to an accurate fit
No need to readjust the pump



FITS FOR:

ART.NR	ITEM NAME	PRICE
BT594580	Camshaft locking tool for Renault 1.8, 2.0 16V	49,00 €

FOR THE FOLLOWING MODELS
Renault Laguna II (2001, 2009), Megane II (2002, 2009), Scenic (2002, 2009)

ENGINE CODES
Engine codes: 700, 701, 712, 713, 714, 715, 720, 721, 722, 722, 730, 732, 736, 738, 740, 741, 744, 746, 747, 760, 761, 762, 763, 764, 765, 766, 767, 770, 771, 773, 774, 774, 775, 776, 784, 786, 787, 790, 792, 794, 797, 830, F4P, F4R

DESCRIPTION
For locking the camshaft sprockets
Use as MOT 1509-01, 1509



FITS FOR:

ART.NR	ITEM NAME	PRICE
BT594650	Engine adjustment tool set for Renault	159,00 €

FOR THE FOLLOWING MODELS
Renault petrol engines 1.4, 1.6, 1.8, 2.0 l, each with 16V technology
Renault petrol engines 2.5 l, 20V with dual camshafts
Renault petrol engines 1.2, 1.4, 1.6, 1.7, 1.8, 2.0, 2.2 l
Renault diesel engines 1.9, 2.5, 2.8 l
Also for Opel Arena, Movano and Volvo V40, S40

DESCRIPTION
Locking the flywheel
Locking the crankshaft, injection pump shaft
Removing the crankshaft pulley
Tensioning the toothed belt
Adjustment gauge for positioning the camshaft and pump shaft in relation to the crankshaft
Use as OEM tools MOT1348, MOT1312, MOT1135-01, MOT1384, MOT1337, MOT1496, MOT910-1, MOT910, MOT861, MOT863, MOT1054, MOT1318, MOT1489, MOT1340, MOT1386, MOT1490, MOT1490-1, KM6031



FITS FOR:

ART.NR	ITEM NAME	PRICE
BT594651	Camshaft tool for Renault	20,00 €

FOR THE FOLLOWING MODELS
Renault 1.4, 1.6, 1.8, 2.0 l, jewels mit 16V-technology
MOTORCODES
Renault: D4F, K4J, K4M, F4P, F4R, F4Rt, F5R740, K9K

DESCRIPTION
Adjusting gauge for locking the camshaft when working on the engine control unit.

DELIVERY SCOPE
to be used like OEM tool MOT1496



FITS FOR:

ART.NR	ITEM NAME	PRICE
BT551400	Adjustment and locking tool for diesel pumps for Renault, Mitsubishi, Opel	23,00 €

FOR THE FOLLOWING MODELS
Renault Megane Scenic, Kangoo
Mitsubishi Carisma
Opel Arena
Volvo S40, V40

DESCRIPTION
For F8Q and F9Q diesel engines with adjustable pump wheel

DELIVERY SCOPE
Special insert with 27 mm internal hex and 1/2" drive
Adjustment tool with 3x 4 mm pins for adjusting the pump
M10 to M8 adapter for Bosch pumps



FITS FOR:

ART.NR	ITEM NAME	PRICE
BT594655	Clamping tool for Renault	11,00 €

FOR THE FOLLOWING MODELS
Renault
DESCRIPTION
For adjusting the tensioning pulley when changing the toothed belt

DELIVERY SCOPE
to be used like OEM tool MOT1384



FITS FOR:



ART.NR	ITEM NAME	PRICE
<b>BT594610</b>	Flywheel/crankshaft pulley blocking and end cover disconnection tool set for Renault, Nissan	<b>109,00 €</b>

**FOR THE FOLLOWING MODELS**

Renault 1.4, 1.6, 2.0, 2.5, 3.5L petrol engines with timing chain

Petrol engines 1.4 L (H4JT), 1.6 L ( M5M), 2.0L (M4R), 2.5 L (2TR), 3.5 L (V4Y)

For locking the flywheel on diesel engines 2.0 L (M9R), 2.3 L (M9T), in conjunction with Art. BT593820

**DESCRIPTION**

For locking the flywheel and the crankshaft pulley and for disconnecting the end cover when replacing the timing chain

**DELIVERY SCOPE**

Crankshaft pulley holder, use as OEM MOT 2019, MOT 1789

Flywheel blocking tool, use as OEM MOT 919-02

Flywheel blocking tool, use as OEM MOT 1431

End cover disconnection tool, use as OEM MOT 1716



FITS FOR:



ART.NR	ITEM NAME	PRICE
<b>BT594592</b>	Injection pump wheel interlock for Renault	<b>9,00 €</b>

**FOR THE FOLLOWING MODELS**

Renault Clio, Megane, Laguna, Kangoo with 1.9 TDI

**ENGINE CODES**

Engine code: F9Q

**DESCRIPTION**

For locking the pump wheel when replacing the toothed belt and carrying out other work that requires dismantling of the toothed belt

Use as OEM 1200-01



FITS FOR:



ART.NR	ITEM NAME	PRICE
<b>BT594570</b>	Engine adjustment tool set for Renault, Opel, Volvo, Mitsubishi, Chrysler	<b>41,00 €</b>

**FOR THE FOLLOWING MODELS**

Renault: Clio (1990-2013), Espace, Grand Espace (1996-2002), Extra, Rapid, Express (1991-2002), Kangoo (1998-2009), Laguna (1994-2001), Megane (1995-2003), Scenic (1996-2003), Modus, Grand Modus II (2004-2013), Safrane (1992-2001), Trafic (1997-2000), Master II (2000-2003), Twingo (2000-2013), Wind (2011-2013)

Opel: Arena (1997-2001), Movano-A (1999-2006), Vivaro (2001-2007)

Volvo: S40 (1996-2004), V40 (1996-2004)

Mitsubishi: Carisma (2001-2005), Space Star (2000-2006)

Chrysler: Cherokee (1984-1995), Wrangler (1988-1995)

**ENGINE CODES**

E7F 1.2: 700, 704, 706, 708, 750

D4F 1.2 16v: 702, 704, 706, 708, 712, 714, 716, 722, 728, 730, 740, 742, 764, 772, 780, 782, 784, 786

E7J 1.4: 601, 624, 626, 634, 635, 710, 711, 716, 718, 719, 754, 756, 757, 764, 780

F3P 1.8: 674, 676, 678, 710, 712, 714, 720, 724, 755, 758, B670, Q7, R7, S724

F7P 1.8 16v: 720, 722

F8Q 1.9D/Di/Turbo: 600, 606, 620, 622, 624, 630, 632, 644, 646, 648, 662, 672 /676, 678, 680, 682, 684, 692 /696, 714, 722, 724, 730, 732, 776, 784, 786, 788, 790, B640

F9Q 1.9D dTi: F9Q1, F9Q2, 710, 716, 717, 720, 722, 730, 731, 734, 736, 744, 760, 762, 770, 774, 780, 782, 790 D4192T, D4191T2 D4192T3, D4192T4

F3R 2.0: 611, 722, 723, 742, 750, 751, 752, 768, 769, 791, 796, 797, 798

J7R 2.0: 732, 733, 734, 735

F7R 2.0 16V: 700, 714, D710

J7T 2.2 16V: 760, 761

G8T 2.2D/Turbo: 706, 714, 716, 740, 752, 760, 790, 792, 794

**DESCRIPTION**

For adjusting the engine timing on Renault petrol and diesel engines

**DELIVERY SCOPE**

Camshaft locking tool, adjustable for DOHC engines

Injection pump wheel fixing mandrel, use as OEM Mot.910

Tension roller key, use as OEM Mot1135-01

Crankshaft fixing mandrel, use as OEM Mot.1318

Crankshaft fixing mandrel, use as OEM Mot.1054

Crankshaft fixing mandrel, use as OEM Mot.910



FITS FOR:



ART.NR	ITEM NAME	PRICE
<b>BT593820</b>	Engine adjustment tool set for Nissan, Renault, Opel	<b>105,00 €</b>

**FOR THE FOLLOWING MODELS**

Nissan Primaster (2008, 2009), Gashqai (2008, 2009), X-Trail (2007, 2008)

Renault Koleos (2008, 2009), Laguna (2005, 2008), Megane (2007, 2008), Scenic (2008, 2009), Trafic (2007, 2008), Vel Satis (2008, 2009)

Opel Vivaro (2007, 2008)

**ENGINE CODES**

Nissan engine codes: M9R 780, 830, 832, 833

Nissan engine codes: M9R 700, 721, 724, 740, 742, 446, 760, 761, 780, 802, 803, 805, 830, 832, 833

Opel engine codes: M9R 780, 782, 784

**DESCRIPTION**

For adjusting and checking the engine timing



FITS FOR:



ART.NR	ITEM NAME	PRICE
<b>BT594680</b>	Engine adjustment tool set for Renault 1.5, 1.9 DCI	<b>5,00 €</b>

**FOR THE FOLLOWING MODELS**

Renault Laguna, Kangoo, Clio

**DESCRIPTION**

For replacing the toothed belt

Suitable for Renault Laguna, Kangoo, Clio with 1.5, 1.9 DCi engines

**DELIVERY SCOPE**

Crankshaft adjustment pin, use as OEM MOT 1489

Camshaft and crankshaft adjustment bolt, use as OEM 0194B, 999-7122, 21-263, MOT 1430, 0187B, 0189B, 607589011500

Crankshaft adjustment bolt, use as OEM KM603, MOT 1054, MOT 861, MOT 863



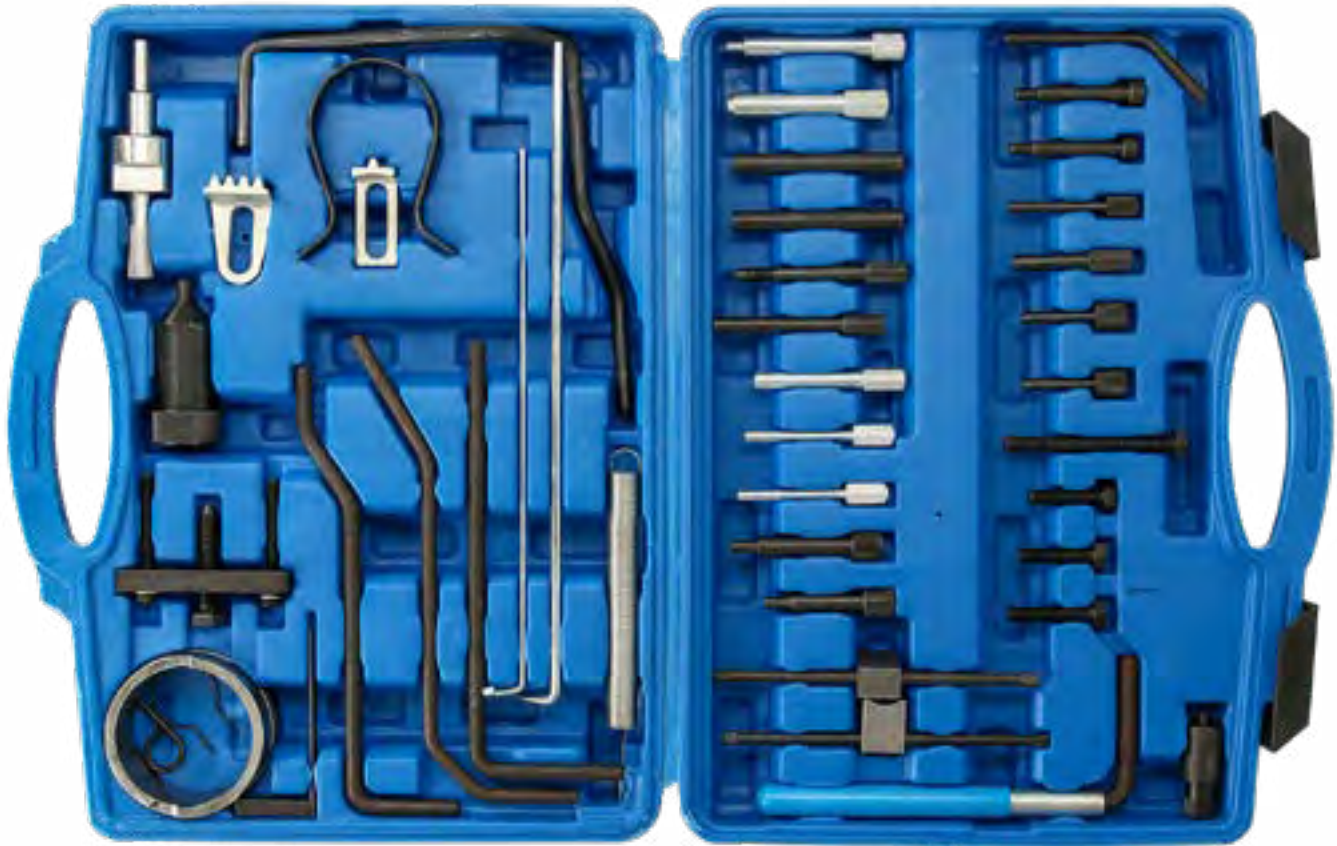

**FITS FOR:**

ART.NR	ITEM NAME	PRICE
<b>BT597940</b>	Engine adjustment tool set for Peugeot, Citroën, PSA	<b>89,00 €</b>

**FOR THE FOLLOWING MODELS**

- Citroën AX, Berlingo, BX, C5, C15, C25, Dispatch, Evasion, Jumper, Jumpy, Relay, Saxo, Synergie, Visa, Xsara, Xantia, XM, XJR, ZX, etc.
- Peugeot 106, 205, 306, 405, 406, 605, 806, J5, Boxer, Expert, Partner, Solara, Talbot Express, Talbot Horizon, etc.
- PSA petrol engines 1.9, 1.1, 1.4, 1.6, 1.8, 1.9, 2.0, 1.6, 1.8, 2.0, 2.2 16V (turbo and dual camshafts)
- PSA diesel engines 1.4, 1.5, 1.7, 1.8, 1.9, 2.1, 2.5 D, TD, TDI, 1.4, 1.6, 2.0, 2.2 HDI
- Suitable for structurally identical engines in Fiat, Ford, Nissan, Renault, Rover, Toyota, etc.

**DESCRIPTION**  
For checking and adjusting the engine timing

**DELIVERY SCOPE**

- Flywheel adjustment pin with spring, use as OEM 0188X, 0189X
- Tensioning spanner, 8 mm, use as OEM 7017-TW
- Flywheel fixing mandrel, 7 mm, use as OEM 7017-TR
- Angled adjustment pin, 8 mm, use as OEM 0188D, 7004TG, 9767-34, 0153G, 7014-TJ, 1 860 863 000, 0153N
- Clamping tool, use as OEM 4507-TJ, 9767.89, 0188Q1, 0132X1Z, 0132X

Camshaft marking mandrel, use as OEM 0189A, 1 871 008 100	Camshaft and crankshaft retainer, use as OEM 0188M, 0187B, 0194B, 303-1277, MOT1430, 0189B, 303-735, 49JE01061, 21-263
Hdi tension roller lever, use as OEM 0188J2	Camshaft marking mandrel (CA2), use as OEM 0132AJ2, 2000Q23000, 0188M, 4533-TAC2
Tension roller lever, use as OEM 5711-TE, 0178E, 0188JJ1	Marking mandrel for injection pump, use as OEM 4527-TS1
Flywheel disc extractor, use as OEM 0174.0188P, 018892, 7015-T	Injection pump fixing mandrel, use as OEM 0188H, 1 860 965 000
Toothed belt retaining clamp, use as OEM 0189K, MOT1436, 4533-TAX, 0188K, 0187J, 0132AK, 0153AK, 1 870 00 100	Flywheel fixing mandrel, use as OEM 49JE02020, 0194C, 21-262, 999-7121, 999-7169, 303-734
Flywheel retainer, use as OEM 0195K, 4507-TL	2 camshaft and crankshaft marking mandrels, use as OEM 4507-TB.7014-TN, 0132-R, 0153-AB, 0158-G
Clamping tool, use as OEM 0189S1	2 camshaft and crankshaft interlocks, use as OEM KM-955, 7014-TM
Flywheel retainer, use as OEM 1867030000, 0153A, 9765.54, 6012T, 1860161000	2 camshaft marking mandrels, use as OEM 9041-TZ, 5711-TC
Tension lever, use as OEM 0189S2	2 crankshaft fixing mandrels, use as OEM 5711-TD, 119790, 0194A, 1860617000, 303-732, 07744-00104-00, 49JE02018, 0178D, 9997169, 4527-TS2, 21-260, 999-7169, 0132AB
Angled locking pin, 5 mm	Camshaft fixing mandrel, use as OEM 0189L
Flywheel fixing mandrel (for automatic transmission), use as OEM 0189R	Screw M8 x 80 mm
Camshaft marking mandrel, use as OEM 0189AZ	Pin for clamping device, 3 mm, use as OEM 0153AL, 4200TA
Crankshaft retainer, use as OEM 0288D, 0188Y, 7014	Centring clip for crankshaft pulley, use as OEM 0188AH
Flywheel fixing mandrel (manual transmission), use as OEM 0189C	Crankshaft marking mandrel, 6 mm, use as OEM 4507-TA, 0132Z, 0132QZ
Flywheel interlock, use as OEM 0188F, 0134Q, 1870765001.1870827000, 0134AF, 9044-T, 1871000400	
Camshaft marking mandrel (CA1), use as OEM 4533-TAC1, 0132AJ1	

# SAAB



ART.NR	ITEM NAME	PRICE
<b>BT593815</b>	Engine adjustment tool set for Opel, Saab, Buick, Cadillac, Chevrolet 2.8, 3.6 V6	<b>54,00 €</b>

### FOR THE FOLLOWING MODELS

Buick Enclave 3.6, engine code: LY7  
 Cadillac SRX, STS, CTS 3.6, engine code: LY7, LLT  
 Chevrolet Camaro 2.8, engine code: LTT, LFX  
 Opel Insignia 2.8 V6 Turbo, engine code: LAU/A28NER  
 Opel Antara 3.2 V6 (start from 2007 onwards), engine code: Z32SE  
 Saab 9-5 2.8 (2009-2013), engine code: LAU/A28NER

### DESCRIPTION

For adjusting and checking the engine timing

### DELIVERY SCOPE

Camshaft adjustment tools, use as OEM EN-48383-1, EN-48383-2, EN-48383-3  
 Flywheel locking tools, use as OEM EN-46106  
 Crankshaft turning tool, use as OEM EN-46111

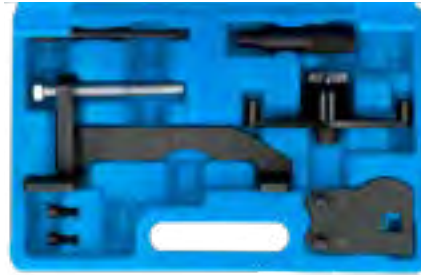

ART.NR	ITEM NAME	PRICE
<b>BT594250</b>	Engine adjustment tool set for Opel, GM 2.0, 2.2 Ecotec diesel	<b>40,00 €</b>

### FOR THE FOLLOWING MODELS

Opel Vectra 2.0 Turbo diesel, Sintra 2.2 Turbo diesel, Zafira 2.0 Turbo diesel, Frontera 2.2 Turbo diesel  
 Saab 9-3 2.2 Turbo diesel

### ENGINE CODES

Engine codes: X20DTL, X20DTH, X22DTH, Y22DTR

### DESCRIPTION

Makes it possible to adjust the engine timing

### DELIVERY SCOPE

Adjustment spanner with holder, use as OEM Opel KM933, Saab 8395394  
 Injection pump adjustment pin, use as OEM Opel KM927, Saab 8395337  
 Crankshaft adjustment pin, use as OEM Opel KM929, Saab 8395352  
 Camshaft adjustment tool, use as OEM Opel KM932, Saab 8395386



ART.NR	ITEM NAME	PRICE
<b>BT594350</b>	Engine adjustment tool for Opel	<b>189,00 €</b>

### FOR THE FOLLOWING MODELS

Opel Agila, Astra, Corsa, Frontera, Meriva, Omega, Signum, Sintra, Speedster, Tigra, Vectra, Zafira

### ENGINE CODES

X10XE, X12XE, Z10XE, Z12XE, Z10XEP, Z12XEP, Z14XEP, X14XE, X16XEL, X16SEJ, X18E1, X18XE1, Y16XE, Z14XE, Z16XE, Z18XE, 18XEL, X18XE, C20SEL, X20XEV, Z20LET, X22XE, Y22XE, Z22XE, Z13DT, X20DTL, X20DTH, Y20DTL, Y20DTH, X22DTH, Y22DTH, Y22DTR, Z19DT, Z19DTH

### DESCRIPTION

For adjusting and checking the engine timing



ART.NR	ITEM NAME	PRICE
<b>BT593320</b>	Engine adjustment tool set for Land Rover 3.6 TD V8	<b>145,00 €</b>

### FOR THE FOLLOWING MODELS

Range Rover (L332) 3.6 TD V8 (2006-2011), engine code: 368DT  
 Rover Sport L320 3.6 TD V8 (2006-2011), engine code: 369DT

### DESCRIPTION

For adjusting the engine timing when replacing the timing chain or the cylinder head seal

### DELIVERY SCOPE

Camshaft adjustment tool (2x) with fastening screws, use as OEM 303-1236  
 Flywheel locking tool, use as OEM 303-1243  
 Crankshaft adjustment pin, use as OEM 303-1238  
 Camshaft turning pin, use as OEM 303-1239



ART.NR	ITEM NAME	PRICE
<b>BT593970</b>	Engine adjustment tool set for GM, Opel, Vauxhall, Saab 2.0 Turbo	<b>51,00 €</b>

### FOR THE FOLLOWING MODELS

Opel Signum Turbo, Vectra-C Turbo (2002-2008), Saab 9-3 1.8 Turbo (2002-2011), Saab 9-3 1.8 Turbo BioPower (2002-2011), Saab 9-3 2.0 Turbo (2002-2012), Saab 9-3 2.0 Turbo BioPower (2010-2012), Saab 9-3XT (2009-2011)

### ENGINE CODES

Engine codes: Z20NET, B207, B207L, B207, B207L, B207, B207L, B207, B207L, B207, B207L

### DESCRIPTION

For adjusting and checking the engine timing

### DELIVERY SCOPE

Crankshaft pulley holding tool, use as OEM KMJ38122-A, 8396210  
 Intake camshaft alignment tool, use as OEM KM6362-1, EN-48366-001  
 Discharge camshaft alignment tool, use as OEM KM6362-2, EN-48366-002  
 Chain tensioner locking pin, use as OEM KM6077, 8396392

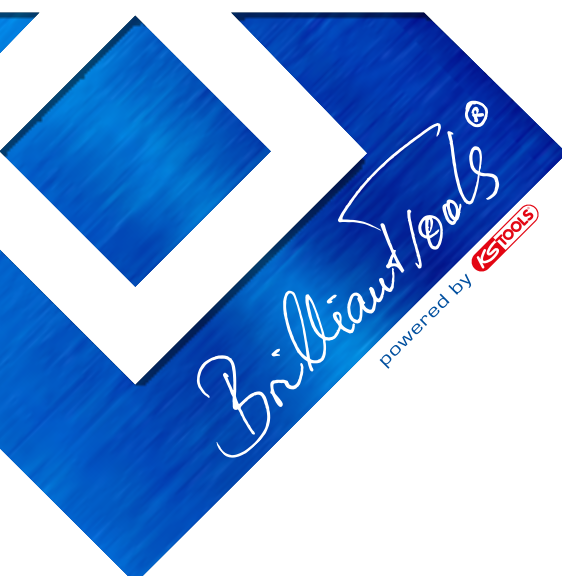



ART.NR	ITEM NAME	PRICE
BT591030	Engine adjustment tool set for VAG	59,00 €

ART.NR	ITEM NAME	PRICE
BT594240	Engine adjustment tool set for Opel Vectra, Signum, Zafira	69,00 €

ART.NR	ITEM NAME	PRICE
BT595700	Camshaft locking tool set for VAG, Ford, Opel, Saab	34,00 €

**FOR THE FOLLOWING MODELS**

Audi A3 1.8 Turbo (AGN AGU AJQ APG APP AQA ARX ARY ARZ AUM AUQ) 1996-2003, A3 1.6 FSI (BAG) 2003-2006, S3 1.8 Turbo (AMK APY BAM) 1996, A4 1.8 Turbo (ADR AEB AJL AJP ANB APU AVJ AWT) 1994-2006, A6 1.8 Turbo (ADR AEB AJL AJP ANB APU AVJ AWT) 1994-2006, Cabriolet 1.8 (ADR) 1997-2000, TT 1.8 Turbo (AJQ APP APX AUM AUQ BAM) 1998-2006

**FOR THE FOLLOWING MODELS**

Opel Astra G (2000, 2006), Speedster (Vauxhall) VX220 (2000, 2006), Vectra B, C (2000, 2008), Signum (2003, 2008), Zafira A, B (2000, 2008)

**DESCRIPTION**

Universal set for a wide range of models

**ENGINE CODES**

Engine codes: Z22SE, Z22YH

**DELIVERY SCOPE**

- Camshaft interlock for Opel Calibra, Omega, Sintra, Vectra -1.8, 2.0, use as OEM KM-852, 18G1570
- Camshaft interlock for Opel Calibra, Omega, Sintra, Vectra -1.4, 1.6, use as OEM KM-853
- Right camshaft with Saab 900, 900 -2.5, 3.0, Opel Calibra, Sintra, Vectra -2.5, 3.0, use as OEM KM-800-2
- Left camshaft with Saab 900.900 -2.5, 3.0, Opel Calibra, Sintra, Vectra -2.5, 3.0, use as OEM KM-800-1
- Crankshaft toothed belt pulley interlock tool for TDI pump-injection engines with VW, Audi, Skoda, Seat and Ford, use as VAG T10050
- Flywheel interlock tools for Citroen, Fiat and Peugeot, use as OEM 153A, 6012T, 9765.54
- Flywheel holder unit for Isuzu 1.5 and 1.7 diesel, Opel 1.6, 1.7 diesel engines, Opel 1.2, 1.4, 1.6, 1.8, 2.0 OHC petrol engines, use as OEM KM-517-B

**FOR THE FOLLOWING MODELS**

Volkswagen Beetle 1.8 Turbo (AVC) 1999-2006, Touran 1.6 FSI (BAG BLP) 2003-2007, Golf 1.8 Turbo (AGN AGU AQA ARZ AUM AUQ) 1997-2005, Bora 1.8 Turbo (AGN AGU AQA ARZ AUM AUQ) 1997-2005, Passat 1.8 Turbo (ADR AEB ANB APT APU ARG AWT) 1996-2005, Sharan 1.8 Turbo (AJH AWC) 1997-2007

**DESCRIPTION**

For adjusting the timing on the 2.2 L 16V engine with timing chain

**ENGINE CODES**

Seat Ibiza 1.8 Turbo (AQX AYP) 1999-2002, Cordoba 1.8 Turbo (AQX AYP) 1999-2002, Leon 1.8 Turbo (AJQ AQN APG APP APT ARYAUG) 1999-2005, Toledo Turbo (AQN APG APT ARY AUQ) 1999-2005, Alhambra 1.8 Turbo (AJW AWC) 1997-2007

**DELIVERY SCOPE**

- Camshaft interlock, use as OEM KM-6148
- Marking pin for chain tensioner, use as OEM KM-6077, Saab 8396392
- Crankshaft counter support, use as OEM Opel KM-J-38122-A, KM-956-1, Alfa 2192261000
- Water pump interlock, use as OEM Opel EN-43651, KM-J-43651, Alfa 2000012000

**ENGINE CODES**

Suitable for 1.8 L turbo and 1.6 L FSI engines

**DELIVERY SCOPE**

- Counter support for crankshaft, use as OEM 3036
- Camshaft fixing tool, use as OEM T10171
- Counter support for drive sprockets of oil pump gear, camshaft, vibration damper, use as OEM T10172
- Adapter pieces for counter support, use as OEM T10172
- Chain tensioner bracket for installation and removal of the chain tensioner, use as OEM T20018, 3366
- Tension roller element fixing pin, use as OEM T40011



# SEAT



ART.NR	ITEM NAME	PRICE
<b>BT597010</b>	Engine adjustment tool set for VAG FSI, TSI 1.4, 1.6 (with timing chain)	<b>29,00 €</b>

### FOR THE FOLLOWING MODELS

Audi A3 (2003-2010)  
 Seat Ibiza, Leon, Altea  
 Skoda Octavia (2004-2009), Fabia (2007-2009), Superb (2009-2010), Roomster (2006-2009)  
 Volkswagen Golf (2003-2009), Golf Plus (2005-2009), Jetta (2006-2009), Passat (2005-2009), Polo (2002-2008), Scirocco (2009-2010), Tiguan (2007-2009), Touran (2003-2009), Eos (2006-2009)

### ENGINE CODES

Engine code AXU, BLG, BAG, BMY, BKG, BMK, BLF, CAVA, BLN, CAVB, BLP, CAVC, CAVE, CAVF, CAVD, CAXA, CAXC, CDGA, BTS

### DESCRIPTION

For checking and adjusting the timing  
 Needed e.g. when replacing the timing chain  
 Suitable for VAG FSI and TFSI 1.4 and 1.6 L engines

### DELIVERY SCOPE

Camshaft locking device, use as OEM T10171  
 Dial gauge bracket, use as OEM T10170  
 Crankshaft interlock, use as OEM T10340  
 Hydraulic tensioner interlock, use as OEM T40011



ART.NR	ITEM NAME	PRICE
<b>BT597500</b>	Engine adjustment tool for VAG 1.2, 1.4, 1.6 FSI, 1.4 TSI	<b>73,00 €</b>

### FOR THE FOLLOWING MODELS

Audi A1, A3, A3 Sportback, A3 Cabriolet  
 Seat Altea, Altea XL, Ibiza, Ibiza Sport Coupe, Leon, Toledo  
 Skoda Fabia, Fabia, Octavia, Rapid, Roomster, Yeti  
 VW New Beetle, Caddy, Golf, Golf Plus, Golf Cabriolet, Golf Variant, Jetta, Polo, Touran

### ENGINE CODES

AXU, BAG, BKG, BLF, BLN, BLP, BMY, BTS, BLG, BWK, CAVA, CAVB, CAVC, CAVD, CAVF, CAXA, CAXC, CDGA

### DESCRIPTION

For adjusting and checking the engine timing

### DELIVERY SCOPE

Camshaft locking device, use as OEM T10171  
 Dial gauge, use as OEM T10170 (dial gauge holder with 274 mm total length, exterior thread M14 x 1.25 mm)  
 Crankshaft interlock, use as OEM T10340  
 Hydraulic tensioner interlock, use as OEM T40011 (8 mm tension shaft)  
 Precision dial gauge for locating the piston OT (resolution: 0.01 mm / measuring range: 0-8 mm / diameter: 41 mm)  
 2x crankshaft wheel locking pin, use as OEM T10341 (two guide bolts with 135 mm length, 24 mm long exterior thread M8 x 1.25 mm, reciprocal external hex with 6 mm width between flats)  
 Camshaft interlock, use as OEM T10414



ART.NR	ITEM NAME	PRICE
<b>BT591070</b>	Engine adjustment tool set for VAG 1.6 2.0 CR TDI	<b>79,00 €</b>

### FOR THE FOLLOWING MODELS

Audi A1, A3 (8P), A4 (B8), A5A6 (C6, C7), TT (8J), Q3, Q5  
 Skoda Fabia II, Roomster, Praktik, Oktavia II, Superb II, Yeti  
 Seat Ibiza (6J), Leon III, Exeo, Altea, Alhambra II  
 Volkswagen Golf V, VI und Plus, Eos, Polo VJetta V und VI, Scirocco III, Beetle II, Caddy II, Passat B6, B7 und CC, Touran, Sharan II, T5, Amarok

### ENGINE CODES

Engine codes CAYB, CAYC, CBAB, CBBB, CBAA, CFFB, CAGA, CAHA, CAGB, CAHB, CAGC, FCA, CAAA, CAAB, CAAC, CCHA, CAVA, CBAB, CBDA, CBDD, CBAC, CBDA, CBDC, etc.

### DESCRIPTION

Contains important tools for checking and adjusting the timing after replacing the toothed belt  
 Also suitable for earlier pump/nozzle engines

### DELIVERY SCOPE

Injection pump interlock, use as OEM T20102, U40074, 3359  
 Crankshaft interlock, use as OEM T10050, T10100  
 Ball head hexagon socket 6 mm, use as OEM T10264  
 2.5 mm tension roller locking pin, use as OEM T10265  
 3.9mm tension roller locking pin, use as OEM T40098  
 Toothed belt pulley holding tool, use as OEM T10051  
 Puller for toothed belt pulley, use as OEM T10052  
 Oil pump/balance shaft adjustment tool, use as OEM T10255

**BT511200**  
**EAN 4042146778746**  
**Radio removal tool set**

**20**  
pcs.

Porsche | Mercedes | Audi | Ford  
 BMW | Opel | VW | Škoda

**9,00 €**





FITS FOR:



ART.NR	ITEM NAME	PRICE
BT561005	Ignition coil disassembly tool for VAG	16,00 €

**DESCRIPTION**

For disassembling ignition coils mounted directly on the spark plug

Suitable for e.g. the following models from year of construction 2013 onwards: VW Golf, Audi A3, Seat Leon, Skoda Octavia with FSI engines 1.2, 1.4, 2.0 with timing chain



FITS FOR:



ART.NR	ITEM NAME	PRICE
BT606004	Special spanner for exhaust gas temperature sensor for VAG, SW 19 mm	28,00 €

**DESCRIPTION**

For assembling/disassembling exhaust gas temperature sensors

Suitable for e.g. the following VAG engines: 1.8 TFSI, 2.0 TFSI, 2.0 FSI, 1.6 CRTdi, 2.0 common rail

Spanner width 19 mm

Use as OEM T10395/8, T10395/9, T10395/10



FITS FOR:



ART.NR	ITEM NAME	PRICE
BT541061	Bit insert, length 54 mm, 12.5 mm square drive (1/2") for VAG Polydrive	4,00 €

**DESCRIPTION**

Special insert for loosening and tightening the fixing screw of the camshaft adjuster for VAG 4-cylinder fuel injection engine (2.0 l direct injection engine)

Special spline profile

Use as OEM: T40080

With knurled grip

Dimensions: M10

**DELIVERY SCOPE**

3 special inserts, 10 mm (3/8") drive

Special insert for camshaft control valves, use as OEM T10352

Special insert for camshaft control valves, use as OEM T10352/1

Special insert for camshaft control valves, use as OEM T10352/2



FITS FOR:



ART.NR	ITEM NAME	PRICE
BT561006	Ignition coil extractor for VAG	23,00 €

**DESCRIPTION**

For pulling off ignition coils on VAG models from year of construction 2013 onwards

Pin-shaped for insertion into the ignition coil fixing hole

Suitable for 4-cylinder 1.2, 1.4, 1.8, 2.0 FSI, TFSI engines, installed in e.g. VW Golf, Audi A3, Seat Leon, Skoda Octavia

Use as OEM T10530

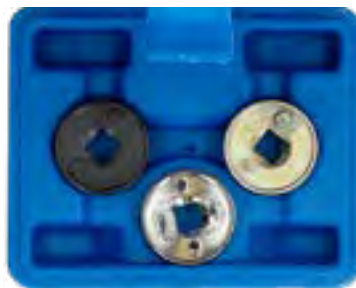

FITS FOR:



ART.NR	ITEM NAME	PRICE
BT595850	Camshaft control valve inserts for VAG 1.8, 2.0 TFSI, TSI	14,00 €

**DESCRIPTION**

For fitting/removal of the 4/3-way central valve of the camshaft adjustment

Suitable for 1.8, 2.0 L 4-cylinder fuel injection and direct injection engines with timing chain, installed in the following models:

Audi A3, A4, A5, Q5, TT, Seat Altea, Leon, Toledo, Exeo, Skoda Octavia II, Superb II, Yeti, Volkswagen Eos, Golf, Jetta, Passat, Scirocco, Sharan, Tiguan



FITS FOR:



ART.NR	ITEM NAME	PRICE
BT595800	Engine adjustment tool set for Volkswagen 1.2	11,00 €

**DELIVERY SCOPE**

Can also be used as a replacement for Art. BT597800

Use as OEM T10123



ART.NR	ITEM NAME	PRICE
<b>BT591960</b>	Vibration damper tool set for VAG 1.8, 2.0 TFSI	<b>145,00 €</b>

**ENGINE CODES**

Engine codes for 1.8L TFSI: BZB, CDA, BPU, BYT, CABA, CABB, CDHA, CDHB, CABD, DAJB, CJS, CJSB, CJEB, CJEE, CJED, CYGA, CDAC, CJSC, CGYA, DAJA

Engine codes for 2.0L TFSI: CAWB, CCZA, CBFA, CCTA, CDNB, CDNC, CDND, CJXA, CJXE, CJXH, CHHB, CHHA, CULA, CFKA, DEDA, CHJA, CAWA, CCZC, CCZD, CP, CJKA, CJKB, CESA, CETA, CFPA, CNCD, CPLA, CYRB, CYRC; CNCE, CYNB, CYP, CULB, CULC, CNCB, CWZA, CJXF, CJXC, CJXB, CJXG, CHHC, CCZB

**DESCRIPTION**

Prevents the timing chain sprocket from turning when the vibration damper is being removed or installed

Suitable for Volkswagen, Audi, Skoda and Seat models with 1.8 and 2.0L TFSI engine with chain drive

**DELIVERY SCOPE**

- Vibration damper holding tool, use as OEM T10531/1
- Crankshaft wheel clamping bolt, use as OEM T10531/2
- Nut for crankshaft wheel holding tool, use as OEM T10531/3
- Adapter piece for crankshaft wheel holding tool, use as OEM T10531/4

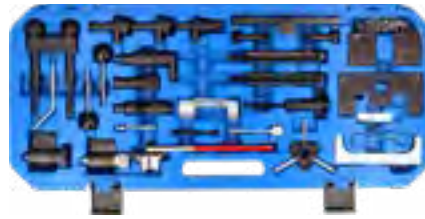

ART.NR	ITEM NAME	PRICE
<b>BT597800</b>	Engine adjustment tool set for VAG	<b>139,00 €</b>

**DESCRIPTION**

- 1.9L, 2.0L TDI pump/nozzle
- 1.9L TDI
- 2.5L V6-TDI
- 3.3L V8-TDI
- 1.2L 3-cylinder and 1.4, 1.6L petrol engines

**ENGINE CODES**

OE-Code Audi: 2065A, T10008, T10016, T10020, T10050, T10060A, T10098, T10100, T10120, T10121, T10264, T10265, T40011, 2064, 3242, 3359, 3366, 3369, 3418, 3458, T10123

OE-Code Seat: 2065A, T10008, T10016, T10020, T10050, T10060A, T10098, T10100, T10120, T10121, T10264, T10265, T40011, 2064, 3242, 3359, 3366, 3369, 3418, 3458, T10123

OE-Code Škoda: 2065A, T10008, T10016, T10020, T10050, T10060A, T10098, T10100, T10120, T10121, T10264, T10265, T40011, 2064, 3242, 3359, 3366, 3369, 3418, 3458, T10123

OE-Code Volkswagen: 2065A, T10008, T10016, T10020, T10050, T10060A, T10098, T10100, T10120, T10121, T10264, T10265, T40011, 2064, 3242, 3359, 3366, 3369, 3418, 3458, T10123

**DELIVERY SCOPE**

- Camshaft adjustment gauge (e.g. VW 1.9 l TDI)
- Toothed belt pulley interlock tool (e.g. VW, Skoda 1.9L, 2.0L TDI pump/nozzle)
- Camshaft interlock tool (e.g. VW, Audi 2.5L V6 TDI)
- 3-way adjustable toothed belt tension roller spanner (universal, for VW, Audi)
- Interlock mandrel for injection pump wheel (e.g. VW, Audi, Seat, Skoda amongst others)
- Retaining plate for toothed belt tensioning device (VW, Skoda 4-cylinder TDI pump/nozzle)
- Open plug-in unit SW22 for assembly and disassembly of diesel injection nozzles
- Camshaft adjustment tools, use as OEM T10123, T10120, 3458, 3418, 2065A, 3366, T10098, 3418
- Crankshaft adjustment tools, use as OEM T10121, 3242, T10050, T10100
- Tensioning roller interlock tools, use as OEM T10060A, T10020, T10008, T40011
- Injection pump interlock tools, use as OEM 3359, 2064



ART.NR	ITEM NAME	PRICE
<b>BT596004</b>	Tensioning spanner for VAG	<b>13,00 €</b>

**DESCRIPTION**

For adjusting the tensioner pulley  
Use as OEM T10020



ART.NR	ITEM NAME	PRICE
<b>BT596005</b>	Tension pulley spanner, 12-point, SW 32 mm	<b>6,00 €</b>

**FOR THE FOLLOWING MODELS**

Audi 100 from 1991 onwards, A4, A6 2.5 TDI 5-cylinder  
VW Polo Diesel, Lupo from 1999 onwards, LT and T4 2.5 TDI

**DESCRIPTION**

For actuating the automatic tension roller while replacing the toothed belt



ART.NR	ITEM NAME	PRICE
<b>BT596003</b>	Cam shaft arresting tool	<b>11,00 €</b>

**FOR THE FOLLOWING MODELS**

VAG 1.4l, 1.6l 16V

**ENGINE CODES**

ARC, AUB, AUA, AUS, APE, ATN, AVY, AFK, AHW, APE, AGQ, AJV, AKQ, AZD

**DESCRIPTION**

For adjusting the camshaft e.g. when replacing the toothed belt  
Use as OEM T10016





FITS FOR:

ART.NR	ITEM NAME	PRICE
BT546004	Crankshaft sealing ring assembly tool for VAG 1.4 and 1.6 16V	130,00 €

**FOR THE FOLLOWING MODELS**

Seat Arosa, Ibiza, Cordoba, Leon, Toledo, Inca  
Skoda Fabia, Octavia, Roomster  
VW Lupo, Polo, Golf, Bora, Beetle, Caddy

**ENGINE CODES**

Engine codes: CHYA, CHYB, CPGA

**DESCRIPTION**

For fitting the radial sealing ring on the transmission  
Attempting to fit the sealing ring without this tool may lead to leaks, destruction of the new sealing ring, and poor engine running  
Suitable for VAG vehicles with 1.4 and 1.6 16V engines  
Use as OEM T10017



FITS FOR:

ART.NR	ITEM NAME	PRICE
BT596002	Universal camshaft wheel puller	63,00 €

**DESCRIPTION**

For pulling the pulley and camshaft gear  
Gripping arms are connected with each other via adjusting disk, thus the gripping arms can be set easily and exactly  
Continuous adjustment range of the gripping arms from 42 – 82 mm  
Gripping arm depth is 27 mm

**DELIVERY SCOPE**

3 x gripping arms, Ø 12 mm, M10 x 1.5, suitable for material thickness up to max. 10 mm  
6-groove puller body with adjusting disc  
Spindle, M14 x 1.5, 19 mm hex, with centring cone



FITS FOR:



ART.NR	ITEM NAME	PRICE
BT591260	Camshaft sprocket locking tool set, universal	72,50 €

**FOR THE FOLLOWING MODELS**

Can be used universally on vehicles from the following manufacturers: Audi, Alfa Romeo, Chrysler, Citroen, Ford, Honda, Hyundai, Isuzu, Land Rover, Lexus, Mazda, Mitsubishi, Peugeot, Renault, MG, Seat, Skoda, Subaru, Toyota, Opel, Volkswagen, Volvo

**DESCRIPTION**

For locking the camshaft sprockets e.g. when replacing the toothed belt  
Suitable for engines with 1, 2 and 4 camshafts (V engines); also suitable for locking between the camshaft sprocket and diesel injection pump wheel in some diesel engines

**DELIVERY SCOPE**

Double camshaft locking tool with short and long connecting arm  
Single camshaft locking tool with short and long locking screw



FITS FOR:

ART.NR	ITEM NAME	PRICE
BT596006	Camshaft sprocket locking tool for VAG 1.0	4,00 €

**FOR THE FOLLOWING MODELS**

Seat Mii 1.0 (3-cylinder)  
Skoda Citigo 1.0 (3-cylinder)  
Volkswagen Up 1.0 (3-cylinder)

**DESCRIPTION**

For locking the camshafts in the adjustment position  
Needed when checking and adjusting the engine timing  
Use as OEM T10476



FITS FOR:



ART.NR	ITEM NAME	PRICE
BT595700	Camshaft locking tool set for VAG, Ford, Opel, Saab	34,00 €

**DESCRIPTION**

Universal set for a wide range of models

**DELIVERY SCOPE**

Camshaft interlock for Opel Calibra, Omega, Sintra, Vectra -1.8, 2.0, use as OEM KM-852, 18G1570  
Camshaft interlock for Opel Calibra, Omega, Sintra, Vectra -1.4, 1.6, use as OEM KM-853  
Right camshaft with Saab 900, 900 -2.5, 3.0, Opel Calibra, Sintra, Vectra -2.5, 3.0, use as OEM KM-800-2  
Left camshaft with Saab 900.900 -2.5, 3.0, Opel Calibra, Sintra, Vectra -2.5, 3.0, use as OEM KM-800-1  
Crankshaft toothed belt pulley interlock tool for TDI pump-injection engines with VW, Audi, Skoda, Seat and Ford, use as VAG T10050  
Flywheel interlock tools for Citroen, Fiat and Peugeot, use as OEM 153A, 6012T, 9765.54  
Flywheel holder unit for Isuzu 1.5 and 1.7 diesel, Opel 1.6, 1.7 diesel engines, Opel 1.2, 1.4, 1.6, 1.8, 2.0 OHC petrol engines, use as OEM KM-517-B



ART.NR	ITEM NAME	PRICE
<b>BT595910</b>	Timing chain test tool set for VAG 1.2, 1.4 TFSi	<b>149,00 €</b>

**FOR THE FOLLOWING MODELS**

Audi: A1 (2012-2015), A1 Sportback (2012-2015), A3 (2013-2015), A3 (2013-2015), A3 Sportback (2012-2015)

Seat: Ibiza (2012-2017), Leon (2012-2015), Toledo (2012-2017)

Skoda: Fabia II (2010-2015), Fabia III (2014-2017), Octavia II (2010-2013), Octavia III (2010-2015), Praktik (2010-2015), Roomster (2010-2015), Rapid (2015-2017)

Volkswagen: Golf VI & VII (2008-2015), Golf VII Kombi (2008-2017), Jetta (2012-2017), Polo (2012-2017), Sportsvan (2014-2017)

**DESCRIPTION**

For checking the timing chain elongation on VAG 1.2 and 1.4L TFSi engines

Prevents costly repairs at a later stage due to the timing chain slipping

**DELIVERY SCOPE**

Timing chain test tool set, use as OEM T10550

Comprises the following tools: Camshaft fixing tool, use as OEM T10550/1; indicator, use as OEM T10550/2; scale sleeve with crankshaft pulley plate, use as OEM T10550/3



ART.NR	ITEM NAME	PRICE
<b>BT591094</b>	Crankshaft locking tool for VAG 1.4, 1.6, 2.0 TDI (EA288)	<b>31,00 €</b>

**FOR THE FOLLOWING MODELS**

For the following vehicles: 1.4 TDI Audi A1, 1.4 TDI Seat Ibiza, Toledo IV, 1.4 TDI Skoda Fabia III, Rapid (2012), 1.4 TDI VW Polo V, 1.6 TDI Audi A1, A3 8V, A4 B9, Q2.o 1.6 TDI Seat Leon III, Toledo IV, Ateca.o, 1.6 TDI Skoda, Octavia III, Rapid (2012), Superb III, Karoq, o 1.6 TDI VW Beetle, Golf VII, Jetta VI, Tiguan, Touran II, T-Roc, Passat B8, CC, Scirocco III, 2.0 TDI Audi A3 8V, A4 B9, Q2, 2.0 TDI Seat Leon III, Ateca, Alhambra II, 2.0 TDI Skoda Octavia III, Superb III, Kodiak, Karoq, 2.0 TDI VW Beetle, Golf VII, Jetta VI, Tiguan, Tiguan II, Touran II, T-Roc, Sharan II, Passat B8, CC, Scirocco III, Arteon, T6, Caddy, Crafter, Amarok

**DESCRIPTION**

For adjusting and locking the crankshaft e.g. when working on the camshaft drive or replacing the cylinder head seal

Suitable for: TDI common rail engines in the EA288 series

Use as OEM T10490



ART.NR	ITEM NAME	PRICE
<b>BT596015</b>	Timing chain tension lever for VAG 1.8, 2.0 TFSi	<b>32,00 €</b>

**FOR THE FOLLOWING MODELS**

Audi A3, A3 Cabrio, TT, Q3

Seat Alhambra, Altea Free Track, Exeo, Leon FR, Toledo

Skoda Octavia II, Superb III (3T), Yeti

Volkswagen Eos, Golf VII, Passat (B6), Passat CC, Passat Variant, Sharan, Beetle, Scirocco, Tiguan

**ENGINE CODES**

Engine codes: (1.8 L engines): CDAA, CDHA, CDHB, CJEB, CDAB, CGYA

Engine codes (2.0 L engines): CCZA, CDNB, CDNC, CFKA, CCZC, CPSA, CESA, CETA, CCZB, CDND, CCZD

**DESCRIPTION**

For pushing back the timing chain tensioner without removing the front engine cover

Needed when replacing the timing chain



ART.NR	ITEM NAME	PRICE
<b>BT591090</b>	Camshaft adjustment tool set for VAG	<b>42,00 €</b>

**FOR THE FOLLOWING MODELS**

Camshaft adjustment tool, use as OEM T10504

Camshaft adjustment pin, use as OEM T10504/1

Camshaft testing pin, use as OEM T10504/2

**DESCRIPTION**

For fixing the camshafts in place when checking and adjusting the valve timing

Suitable for 1.2, 1.4 TSi, TFSi engines with active cylinder management ACT or COD

Engine codes: CPTA, CZEA

Installed in e.g. the following models: Audi A1 (2013-), A3 (2013-), Q3 (2014-), Volkswagen Passat (2012), Golf (2012-), Polo (2015-), Seat Leon (2014-), Ibiza (2013-), Skoda Superb (2015-)

**32**  
pcs.

**1/2"**  
12,5 mm

**BT022032**  
**EAN 4042146775912**  
**1/2" bit socket set,**  
**RIBE profile**

**69,- €**

<b>9x</b>	55	M5 • M6 • M7 • M8 • M9 • M10 • M12 • M13 • M14
<b>9x</b>	100	M5 • M6 • M7 • M8 • M9 • M10 • M12 • M13 • M14
<b>7x</b>	140	M8 • M9 • M10 • M10,3 • M12 • M13 • M14
<b>7x</b>	200	M8 • M9 • M10 • M10,3 • M12 • M13 • M14





ART.NR	ITEM NAME	PRICE
<b>BT595920</b>	Camshaft assembly tool set for VAG and Porsche	<b>549,00 €</b>

**FOR THE FOLLOWING MODELS**

Suitable for the following diesel vehicles (TDI CR) from 2003 onwards: Audi, Porsche, Seat, Skoda, Volkswagen with 1.2, 1.6, 2.0, 2.7, 3.0, 4.0, 4.2 common rail engines

**ENGINE CODES**

Engine codes ASB, ASE, BKN, BKS, BMK, BNG, BPP, BSG, BTR, BUG, BUN, BVN, CAAA, CAAB, CAAC, CAAD, CAAE, CAGA, CAGB, CAGC, CAHA, CAHB, CAMA, CAMB, CANA, CANB, CANS, CAND, CAPA, CARA, CASA, CASB, CASC, CASD, CATA, CAYA, CAYB, CAYC, CAYD, CAYE, CBAA, CBAB, CBAC, CBBA, CBBB, CBDA, CBDB, CBDC, CCFA, CCFC, CCHA, CCHB, CCLA, CCMA, CCWA, CCWB, CDBA, CDCA, CDSB, CDTA, CDTB, CDUC, CDUD, CDYA, CDYB, CDYC, CEGA, CEXA, CFCA, CFFA, CFFB, CFFD, CFFE, CFGB, CFGC, CFGD, CFHA, CFHB, CFHC, CFHD, CFHE, CFHF, CFJA, CFWA, CGKA, CGKB, CGLA, CGLB, CGLC, CGLD, CGLE, CGQB, CJAA, CJCA, CJCB, CJCC, CJCD, CJGA, CJGC, CJGD, CJMA, CKDA, CKTB, CKTC, CKUB, CKUC, CKVB, CKVC, CLAA, CLAB, CLCA, CLCB, CLJA, CLLA, CLNA, CLZB, CMEA, CMFA, CMFB, CMGB, CMHA, CNEA, CNFA, CNRB, CRCA, CSHA, M05/9D (CAS), M05/9E, M05/9E (CRCA), M05/9E (CRCB)

**DESCRIPTION**

For installing the camshafts in the correct position  
Needed when installing new or existing camshafts; attempting installation without this tool may lead to damage on the camshaft bearing bridge and the cylinder head

**DELIVERY SCOPE**

- Mounting device including pre-assembled parts, use as OEM T40094
- Camshaft clamp, use as OEM T40095
- 2 alignment clamps, use as OEM T40096, T40096/1
- 4 camshaft brackets for mounting device, use as OEM T40094/1, T40094/2, T40094/9, T40094/10
- Interlock for camshaft bracket, use as OEM T40094/11



ART.NR	ITEM NAME	PRICE
<b>BT597150</b>	Engine adjustment tool set for VAG 1.4, 1.6, 1.9, 2.0 SDI, TDI	<b>18,00 €</b>

**FOR THE FOLLOWING MODELS**

Audi A2 1.4 TDI (2002, 2006), A3 1.9, 2.0 TDI (2002, 2008), A4 1.6 TDI (2002, 2005), A4 1.9, 2.0 TDI (2004, 2008)

Seat Altea 1.9 SDI, TDI (2005, 2008), Leon 1.9, 2.0 TDI (2005, 2008), Toledo 1.9 SDI, TDI (2005, 2008) engine codes: BJB, BKC, BLS, BMM, BXE

Skoda Fabia 1.4 TDI (2003, 2006), Octavia 1.4 TDI (2003, 2006), engine codes: AMF, AZV, BKD

Volkswagen Beetle 1.9 TDI (2002, 2008), Bora 1.9 TDI (2002, 2008), Fox 1.4 TDI (2002, 2008), Golf 1.9, 2.0 TDI (2002, 2008), Lupo 1.4 TDI (2002, 2008), Polo 1.4, 1.9 TDI (2002, 2008), Sharan 1.9 TDI (2002, 2008) engine codes: AJM, AMF, ANU, ARL, ASZ, ATD, AUJ, AVB, AVF, AWX, AXR, BAY, BMS, BNM, BNV, BVW

**ENGINE CODES**

AMF, ASZ, ATD, AVB, AVF, AWX, AXR, AZV, BHC, BKC, BKD, BKE, BLB, BMN, BNA, BPW, BRB, BRC, BRD, BRE, BUY, BVA, BVF, BVG"

**DESCRIPTION**

For adjusting and checking the engine timing when replacing the toothed belt, camshaft etc.

**DELIVERY SCOPE**

- Crankshaft interlock, use as OEM T10100
- Pump wheel/camshaft interlock, use as OEM 3359, T20102, 9882, MB995206
- Crankshaft interlock, use as OEM T10050, 9883, 310-085, 23-059, MB995209
- 4 mm marking pin, use as OEM T10115, 303-1054, MB995208
- Auxiliary belt locking pin, use as OEM T10060A, T40098

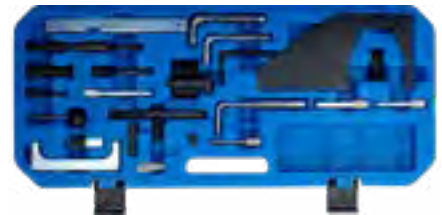

ART.NR	ITEM NAME	PRICE
<b>BT593100</b>	Engine adjustment tool set for Ford	<b>109,00 €</b>

**FOR THE FOLLOWING MODELS**

Suitable for the following Ford engines: 1.4, 1.6 16V, 1.7, 1.8 16V, 2.0 16V (including Zetec), 1.4, 1.6, 1.8, 1.9 D/TD/TDCi

**DESCRIPTION**

- Contains tools for: Locking the flywheel
- Locking the crankshaft, pump shaft
- Locking the injection pump shaft
- Removing the crankshaft pulley
- Tensioning the toothed belt
- Adjustment gauge for positioning the camshaft and pump shaft in relation to the crankshaft
- Use as OEM 21-162, 21-162B, 303-367, 303-376, 23-059, 310-085, 21-168, 303-393, 23-020, 23-047, 23-020, 21-163, 303-620, 23-019, 21-210, 303-507, 21-251, 303-698, 21-262, 303-734, 23-029, 303-1061, 23-058, 310-084, 21-105, 21-262, 303-734, 21-168, 303-393, 21-263, 303-735, Mazda 49JE01061, Audi 3359, T10008, T10050, 2065A, Seat 3359, T10008, T10050, 2065A, Skoda 3359, T10008, T10050, 2065A, Volkswagen 3359, T10008, T10050, 2065A



**REGISTER FOR THE NEWSLETTER NOW!**

**ALWAYS UP-TO-DATE:**

[WWW.BRILLIANT-TOOLS.COM/NEWSLETTER](http://WWW.BRILLIANT-TOOLS.COM/NEWSLETTER)



# ŠKODA



ART.NR	ITEM NAME	PRICE
<b>BT591070</b>	Engine adjustment tool set for VAG 1.6, 2.0 CR TDI	<b>79,00 €</b>

### FOR THE FOLLOWING MODELS

Audi A1, A3 (8P), A4 (B8), A5/A6 (C6, C7), TT (8J), Q3, Q5  
 Skoda Fabia II, Roomster, Praktik, Octavia II, Superb II, Yeti  
 Seat Ibiza (6J), Leon III, Exeo, Altea, Alhambra II  
 Volkswagen Golf V, VI und Plus, Eos, Polo V/Jetta V und VI, Scirocco III, Beetle II, Caddy II, Passat B6, B7 und CC, Touran, Sharan II, T5, Amarok

### ENGINE CODES

Engine codes CAYB, CAYC, CBAB, CBBB, CBAA, CFFB, CAGA, CAHA, CAGB, CAHB, CAGC, FCA, CAAA, CAAB, CAAC, CCHA, CAVA, CBAB, CBDA, CBDD, CBAC, CBDA, CBDC, etc.

### DESCRIPTION

Contains important tools for checking and adjusting the timing after replacing the toothed belt  
 Also suitable for earlier pump/nozzle engines

### DELIVERY SCOPE

Injection pump interlock, use as OEM T20102, U40074, 3359  
 Crankshaft interlock, use as OEM T10050, T10100  
 Ball head hexagon socket 6 mm, use as OEM T10264  
 2.5 mm tension roller locking pin, use as OEM T10265  
 3.9mm tension roller locking pin, use as OEM T40098  
 Toothed belt pulley holding tool, use as OEM T10051  
 Puller for toothed belt pulley, use as OEM T10052  
 Oil pump/balance shaft adjustment tool, use as OEM T10255



ART.NR	ITEM NAME	PRICE
<b>BT606004</b>	Special spanner for exhaust gas temperature sensor for VAG, SW 19 mm	<b>28,00 €</b>

### DESCRIPTION

For assembling/disassembling exhaust gas temperature sensors  
 Suitable for e.g. the following VAG engines: 1.8 TFSI, 2.0 TFSI, 2.0 FSI, 1.6 CRTdi, 2.0 common rail  
 Spanner width 19 mm  
 Use as OEM T10395/8, T10395/9, T10395/10

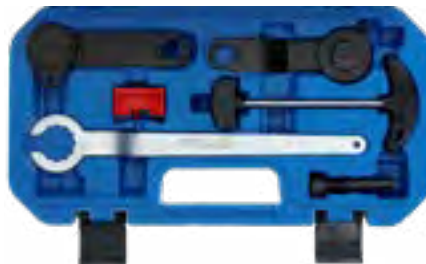

ART.NR	ITEM NAME	PRICE
<b>BT597300</b>	Engine adjustment tool set for VAG 1.0, 1.2, 1.4	<b>72,00 €</b>

### FOR THE FOLLOWING MODELS

Suitable for the following VAG (EA211) engines with toothed belt: 1.0 MPI 3-cylinder, engine code CHYA, 1.0 TSI 3-cylinder, engine code CHZE, CHZC, CHZA, CHZB, CHZC, CHZD, CHZJ, 1.2 TSI 4-cylinder, engine code CJZB, CJZC, CYVA, CJZA, CJZD, CYVB, 1.4 TSI 4-cylinder, engine code CZCC, CMBA, CZCA, CHPA, CPTA (with ACT), CZDA, CVNA, CZEA (with ACT)

### DESCRIPTION

For adjusting and checking the engine timing

### DELIVERY SCOPE

Crankshaft interlock bolt, use as OEM T10340  
 Camshaft adjustment plate, use as OEM T10477  
 Camshaft wheel interlock, use as OEM T10476  
 Tensioning insert spanner, use as OEM T10499  
 Camshaft adjustment plate, use as OEM T10494  
 Assembly tool, use as OEM T10487



ART.NR	ITEM NAME	PRICE
<b>BT595850</b>	Camshaft control valve inserts for VAG 1.8, 2.0 TFSI, TSI	<b>14,00 €</b>

### DESCRIPTION

For fitting/removal of the 4/3-way central valve of the camshaft adjustment  
 Suitable for 1.8, 2.0 L 4-cylinder fuel injection and direct injection engines with timing chain, installed in the following models:  
 Audi A3, A4, A5, Q5, TT, Seat Altea, Leon, Toledo, Exeo, Skoda Octavia II, Superb II, Yeti, Volkswagen Eos, Golf, Jetta, Passat, Scirocco, Sharan, Tiguan



ART.NR	ITEM NAME	PRICE
<b>BT541061</b>	Bit insert, length 54 mm, 12.5 mm square drive (1/2") for VAG Polydrive	<b>4,00 €</b>

### DESCRIPTION

Special insert for loosening and tightening the fixing screw of the camshaft adjuster for VAG 4-cylinder fuel injection engine (2.0 l direct injection engine)  
 Special spline profile  
 Use as OEM: T40080  
 With knurled grip  
 Dimensions: M10

### DELIVERY SCOPE

3 special inserts, 10 mm (3/8") drive  
 Special insert for camshaft control valves, use as OEM T10352  
 Special insert for camshaft control valves, use as OEM T10352/1  
 Special insert for camshaft control valves, use as OEM T10352/2



**FITS FOR:** Audi Volkswagen SKODA SEAT

ART.NR	ITEM NAME	PRICE
BT591960	Vibration damper tool set for VAG 1.8, 2.0 TFSI	145,00 €

**ENGINE CODES**

Engine codes for 1.8L TFSI: BZB, CDAA, BPU, BYT, CABA, CABB, CDHA, CDHB, CABD, DAJB, CJSA, CJSB, CJEB, CJEE, CJED, CYGA, CDAC, CJSC, CGYA, DAJA

Engine codes for 2.0L TFSI: CAWB, CCZA, CBFA, CGTA, CDNB, CDNC, CDND, CJXA, CJXE, CJXH, CHHB, CHHA, CULA, CFKA, DEDA, CHJA, CAWA, CCZC, CCZD, CPSA, CJKA, CJKB, CESA, CETA, CFPA, CNCD, CPLA, CYRB, CYRC; CNCE, CYNB, CYP A, CULB, CULC, CNCB, CWZA, CJXF, CJXC, CJXB, CJXG, CHHC, CCZB

**DESCRIPTION**

Prevents the timing chain sprocket from turning when the vibration damper is being removed or installed

Suitable for Volkswagen, Audi, Skoda and Seat models with 1.8 and 2.0L TFSI engine with chain drive

**DELIVERY SCOPE**

Vibration damper holding tool, use as OEM T10531/1

Crankshaft wheel clamping bolt, use as OEM T10531/2

Nut for crankshaft wheel holding tool, use as OEM T10531/3

Adapter piece for crankshaft wheel holding tool, use as OEM T10531/4



**FITS FOR:** Audi Volkswagen SKODA SEAT

ART.NR	ITEM NAME	PRICE
BT561005	Ignition coil disassembly tool for VAG	16,00 €

**DESCRIPTION**

For disassembling ignition coils mounted directly on the spark plug

Suitable for e.g. the following models from year of construction 2013 onwards: VW Golf, Audi A3, Seat Leon, Škoda Octavia with FSI engines 1.2, 1.4, 2.0 with timing chain



**FITS FOR:** SKODA Audi Volkswagen

ART.NR	ITEM NAME	PRICE
BT591030	Engine adjustment tool set for VAG	59,00 €

**FOR THE FOLLOWING MODELS**

Audi A3 1.8 Turbo (AGN AGU AJQ APG APP AGA ARX ARY ARZ AUM AUG) 1996-2003, A3 1.6 FSI (BAG) 2003-2006, S3 1.8 Turbo (AMK APY BAM) 1996, A4 1.8 Turbo (ADR AEB AJL AJP ANB APU AVJ AWT) 1994-2006, A6 1.8 Turbo (ADR AEB AJL AJP ANB APU AVJ AWT) 1994-2006, Cabriolet 1.8 (ADR) 1997-2000, TT 1.8 Turbo (AJQ APP APX AUM AUG BAM) 1998-2006

Volkswagen Beetle 1.8 Turbo (AVC) 1999-2006, Touran 1.6 FSI (BAG BLP) 2003-2007, Golf 1.8 Turbo (AGN AGU AQA ARZ AUM AUQ) 1997-2005, Bora 1.8 Turbo (AGN AGU AQA ARZ AUM AUQ) 1997-2005, Passat 1.8 Turbo (ADR AEB ANB APT APU ARG AWT) 1996-2005, Sharan 1.8 Turbo (AJH AWC) 1997-2007

Seat Ibiza 1.8 Turbo (AQX AYP) 1999-2002, Cordoba 1.8 Turbo (AQX AYP) 1999-2002, Leon 1.8 Turbo (AJQ AQN APG APP APT ARYAUG) 1999-2005, Toledo Turbo (AQN APG APT ARY AUQ) 1999-2005, Alhambra 1.8 Turbo (AJW AWC) 1997-2007

Skoda Octavia 1.8 FSI Turbo (AGN AGU ARX ARZ AUM) 1996-2005, Octavia 1.8 Turbo 20V RS (AUG) 2000-2006, Octavia 1.6 FSI (BLF) 2004-2007

**ENGINE CODES**

Suitable for 1.8 L turbo and 1.6 L FSI engines

**DELIVERY SCOPE**

Counter support for crankshaft, use as OEM 3036

Camshaft fixing tool, use as OEM T10171

Counter support for drive sprockets of oil pump gear, camshaft, vibration damper, use as OEM T10172

Adapter pieces for counter support, use as OEM T10172

Chain tensioner bracket for installation and removal of the chain tensioner, use as OEM T20018, 3366

Tension roller element fixing pin, use as OEM T40011



**FITS FOR:** Audi Volkswagen SKODA SEAT

ART.NR	ITEM NAME	PRICE
BT597010	Engine adjustment tool set for VAG FSI, TSI 1.4, 1.6 (with timing chain)	29,00 €

**FOR THE FOLLOWING MODELS**

Audi A3 (2003-2010)

Seat Ibiza, Leon, Altea

Skoda Octavia (2004-2009), Fabia (2007-2009), Superb (2009-2010), Roomster (2006-2009)

Volkswagen Golf (2003-2009), Golf Plus (2005-2009), Jetta (2006-2009), Passat (2005-2009), Polo (2002-2008), Scirocco (2009-2010), Tiguan (2007-2009), Touran (2003-2009), Eos (2006-2009)

**ENGINE CODES**

Engine code AXU, BLG, BAG, BMY, BKG, BMK, BLF, CAVA, BLN, CAVB, BLP, CAVC, CAVE, CAVF, CAVD, CAXA, CAXC, CDGA, BTS

**DESCRIPTION**

For checking and adjusting the timing

Needed e.g. when replacing the timing chain

Suitable for VAG FSI and TFSI 1.4 and 1.6 L engines

**DELIVERY SCOPE**

Camshaft locking device, use as OEM T10171

Dial gauge bracket, use as OEM T10170

Crankshaft interlock, use as OEM T10340

Hydraulic tensioner interlock, use as OEM T40011





ART.NR	ITEM NAME	PRICE
<b>BT597500</b>	Engine adjustment tool for VAG 1.2, 1.4, 1.6 FSI, 1.4 TSI	<b>73,00 €</b>

**FOR THE FOLLOWING MODELS**

Audi A1, A3, A3 Sportback, A3 Cabriolet  
Seat Altea, Altea XL, Ibiza, Ibiza Sport Coupe, Leon, Toledo  
Skoda Fabia, Fabia, Octavia, Rapid, Roomster, Yeti  
VW New Beetle, Caddy, Golf, Golf Plus, Golf Cabriolet, Golf Variant, Jetta, Polo, Touran

**ENGINE CODES**

AXU, BAG, BKG, BLF, BLN, BLP, BMY, BTS, BLG, BWK, CAVA, CAVB, CAVC, CAVD, CAVF, CAXA, CAXC, CDGA

**DESCRIPTION**

For adjusting and checking the engine timing

**DELIVERY SCOPE**

Camshaft locking device, use as OEM T10171  
Dial gauge, use as OEM T10170 (dial gauge holder with 274 mm total length, exterior thread M14 x 1.25 mm)  
Crankshaft interlock, use as OEM T10340  
Hydraulic tensioner interlock, use as OEM T40011 (8 mm tension shaft)  
Precision dial gauge for locating the piston OT (resolution: 0.01 mm / measuring range: 0-8 mm / diameter: 41 mm)  
2x crankshaft wheel locking pin, use as OEM T10341 (two guide bolts with 135 mm length, 24 mm long exterior thread M8 x 1.25 mm, reciprocal external hex with 6 mm width between flats)  
Camshaft interlock, use as OEM T10414



ART.NR	ITEM NAME	PRICE
<b>BT596004</b>	Tensioning spanner for VAG	<b>13,00 €</b>

**DESCRIPTION**

For adjusting the tensioner pulley  
Use as OEM T10020



ART.NR	ITEM NAME	PRICE
<b>BT597000</b>	Engine adjustment tool set for VAG	<b>29,00 €</b>

**FOR THE FOLLOWING MODELS**

Volkswagen: Polo 1.2 L, 6V, 3-cylinder, engine code AWY, BMD, BBM, Polo 1.2 L, 12V, 3-cylinder, engine code AZQ, BME, BZG, CGPA, CGPB  
Skoda: Fabia 1.2 L, 6V, 3-cylinder, engine code AWY, BMD, Fabia 1.2 L, 12V, 3-cylinder, engine code AZQ, BME, BZG, CEVA, CGPA, CGPB, Rapid 1.2 L, 12V, 3-cylinder, engine code CGPC, Roomster 1.2 L, 12V, 3-cylinder, engine code BME, BZG, CGPA, Praktik Rapid 1.2 L, 12V, 3-cylinder, engine code BZG, CGPA  
Seat: Ibiza 1.2 L, 12V, 3-cylinder, engine code AZQ, BME, BXV, BZG, CGPA, CGPB, Cordoba 1.2 L, 12V, 3-cylinder, engine code AZQ, BME, BXV

**DELIVERY SCOPE**

Camshaft interlock, use as OEM T10123  
Camshaft interlock, use as OEM T10120  
Crankshaft interlock, use as OEM T10121



ART.NR	ITEM NAME	PRICE
<b>BT596003</b>	Cam shaft arresting tool	<b>11,00 €</b>

**FOR THE FOLLOWING MODELS**

VAG 1.4i, 1.6i 16V

**ENGINE CODES**

ARC, AUB, AUA, AUS, APE, ATN, AVY, AFK, AHW, APE, AQQ, AJV, AKQ, AZD

**DESCRIPTION**

For adjusting the camshaft e.g. when replacing the toothed belt  
Use as OEM T10016



ART.NR	ITEM NAME	PRICE
<b>BT597800</b>	Engine adjustment tool set for VAG	<b>139,00 €</b>

**FOR THE FOLLOWING MODELS**

1.9L, 2.0L TDI pump/nozzle  
1.9L TDI  
2.5L V6-TDI  
3.3L V8-TDI  
1.2L 3-cylinder and 1.4, 1.6L petrol engines

**DELIVERY SCOPE**

Camshaft adjustment gauge (e.g. VW 1.9 I TDI)  
Toothed belt pulley interlock tool (e.g. VW, Skoda 1.9L, 2.0L TDI pump/nozzle)  
Camshaft interlock tool (e.g. VW, Audi 2.5L V6 TDI)  
3-way adjustable toothed belt tension roller spanner (universal, for VW, Audi)  
Interlock mandrel for injection pump wheel (e.g. VW, Audi, Seat, Skoda amongst others)  
Retaining plate for toothed belt tensioning device (VW, Skoda 4-cylinder TDI pump/nozzle)  
Open plug-in unit SW22 for assembly and disassembly of diesel injection nozzles  
Camshaft adjustment tools, use as OEM T10123, T10120, 3458, 3418, 2065A, 3366, T10098, 3418  
Crankshaft adjustment tools, use as OEM T10121, 3242, T10050, T10100  
Tensioning roller interlock tools, use as OEM T10060A, T10020, T10008, T40011  
Injection pump interlock tools, use as OEM 3359, 2064



ART.NR	ITEM NAME	PRICE
BT595700	Camshaft locking tool set for VAG, Ford, Opel, Saab	34,00 €

**DESCRIPTION**  
Universal set for a wide range of models

**DELIVERY SCOPE**

- Camshaft interlock for Opel Calibra, Omega, Sintra, Vectra -1.8, 2.0, use as OEM KM-852, 18G1570
- Camshaft interlock for Opel Calibra, Omega, Sintra, Vectra -1.4, 1.6, use as OEM KM-853
- Right camshaft with Saab 900, 900 -2.5, 3.0, Opel Calibra, Sintra, Vectra -2.5, 3.0, use as OEM KM-800-2
- Left camshaft with Saab 900.900 -2.5, 3.0, Opel Calibra, Sintra, Vectra -2.5, 3.0, use as OEM KM-800-1
- Crankshaft toothed belt pulley interlock tool for TDI pump-injection engines with VW, Audi, Skoda, Seat and Ford, use as VAG T10050
- Flywheel interlock tools for Citroen, Fiat and Peugeot, use as OEM 153A, 6012T, 9765.54
- Flywheel holder unit for Isuzu 1.5 and 1.7 diesel, Opel 1.6, 1.7 diesel engines, Opel 1.2, 1.4, 1.6, 1.8, 2.0 OHC petrol engines, use as OEM KM-517-B



ART.NR	ITEM NAME	PRICE
BT596005	Tension pulley spanner, 12-pointal, SW 32 mm	6,00 €

**FOR THE FOLLOWING MODELS**

- Audi 100 from 1991 onwards, A4, A6 2.5 TDI 5-cylinder
- VW Polo Diesel, Lupo from 1999 onwards, LT and T4 2.5 TDI

**DESCRIPTION**

For actuating the automatic tension roller while replacing the toothed belt



ART.NR	ITEM NAME	PRICE
BT595900	Engine adjustment tool set for VAG 1.2 TSI, TFSI	21,00 €

**FOR THE FOLLOWING MODELS**

- VAG 1.2 TSI, TFSI with engine codes CBZA, CBZB, CBZC
- Audi models A1 and A3
- VW New Beetle, Caddy, Golf, Jetta, Polo, Touran
- Skoda Fabia II, Octaviall, Praktik, Rapid, Roomster, Yeti
- Seat Altea, Ibiza, Leon, Toledo

**DESCRIPTION**

For locking the camshaft and crankshaft while changing the timing chain, replacing the cylinder head seal etc.

**DELIVERY SCOPE**

- Crankshaft lock, use as OEM T10340
- Camshaft interlock, use as OEM T10414
- Guide bolt, use as OEM-T10341



ART.NR	ITEM NAME	PRICE
BT596006	Camshaft sprocket locking tool for VAG 1.0	4,00 €

**FOR THE FOLLOWING MODELS**

- Seat Mii 1.0 (3-cylinder)
- Skoda Citigo 1.0 (3-cylinder)
- Volkswagen Up 1.0 (3-cylinder)

**DESCRIPTION**

For locking the camshafts in the adjustment position  
Needed when checking and adjusting the engine timing  
Use as OEM T10476



ART.NR	ITEM NAME	PRICE
BT671900	Front axle transverse link bush tool for VAG	65,00 €

**FOR THE FOLLOWING MODELS**

- Seat Cordoba III (from 2003 onwards), Skoda Fabia (from 2000 onwards), VW Polo IV (from 2002 onwards)

**DESCRIPTION**

For disassembly/assembly of the rear bush at the lower front axle transverse link  
Suitable for application on the vehicle without disassembly of the transverse link  
Spindle nut with 24 mm hex



ART.NR	ITEM NAME	PRICE
BT546004	Crankshaft sealing ring assembly tool for VAG 1.4 and 1.6 16V	130,00 €

**FOR THE FOLLOWING MODELS**

- Seat Arosa, Ibiza, Cordoba, Leon, Toledo, Inca
- Skoda Fabia, Octavia, Roomster
- VW Lupo, Polo, Golf, Bora, Beetle, Caddy

**ENGINE CODES**

Engine codes: CHYA, CHYB, CPGA

**DESCRIPTION**

For fitting the radial sealing ring on the transmission  
Attempting to fit the sealing ring without this tool may lead to leaks, destruction of the new sealing ring, and poor engine running  
Suitable for VAG vehicles with 1.4 and 1.6 16V engines  
Use as OEM T10017



ART.NR	ITEM NAME	PRICE
<b>BT591260</b>	Camshaft sprocket locking tool set, universal	<b>72,50 €</b>

**FOR THE FOLLOWING MODELS**

Can be used universally on vehicles from the following manufacturers: Audi, Alfa Romeo, Chrysler, Citroen, Ford, Honda, Hyundai, Isuzu, Land Rover, Lexus, Mazda, Mitsubishi, Peugeot, Renault, MG, Seat, Skoda, Subaru, Toyota, Opel, Volkswagen, Volvo

**DESCRIPTION**

For locking the camshaft sprockets e.g. when replacing the toothed belt

Suitable for engines with 1, 2 and 4 camshafts (V engines); also suitable for locking between the camshaft sprocket and diesel injection pump wheel in some diesel engines

**DELIVERY SCOPE**

Double camshaft locking tool with short and long connecting arm

Single camshaft locking tool with short and long locking screw



ART.NR	ITEM NAME	PRICE
<b>BT561006</b>	Ignition coil extractor for VAG	<b>23,00 €</b>

**DESCRIPTION**

For pulling off ignition coils on VAG models from year of construction 2013 onwards

Pin-shaped for insertion into the ignition coil fixing hole

Suitable for 4-cylinder 1.2, 1.4, 1.8, 2.0 FSI, TFSI engines, installed in e.g. VW Golf, Audi A3, Seat Leon, Skoda Octavia

Use as OEM T10530



ART.NR	ITEM NAME	PRICE
<b>BT595800</b>	Engine adjustment tool set for Volkswagen 1.2	<b>11,00 €</b>

**DELIVERY SCOPE**

Can also be used as a replacement for Art. BT597800

Use as OEM T10123



ART.NR	ITEM NAME	PRICE
<b>BT591090</b>	Camshaft adjustment tool set for VAG	<b>42,00 €</b>

**FOR THE FOLLOWING MODELS**

Camshaft adjustment tool, use as OEM T10504

Camshaft adjustment pin, use as OEM T10504/1

Camshaft testing pin, use as OEM T10504/2

**DESCRIPTION**

For fixing the camshafts in place when checking and adjusting the valve timing

Suitable for 1.2, 1.4 TSi, TFSi engines with active cylinder management ACT or COD

Engine codes: CPTA, CZEA

Installed in e.g. the following models: Audi A1 (2013-), A3 (2013-), Q3 (2014-), Volkswagen Passat (2012), Golf (2012-), Polo (2015-), Seat Leon (2014-), Ibiza (2013-), Skoda Superb (2015-)



ART.NR	ITEM NAME	PRICE
<b>BT596015</b>	Timing chain tension lever for VAG 1.8, 2.0 TFSi	<b>32,00 €</b>

**FOR THE FOLLOWING MODELS**

Audi A3, A3 Cabrio, TT, Q3

Seat Alhambra, Altea Free Track, Exeo, Leon FR, Toledo

Skoda Octavia II, Superb III (3T), Yeti

Volkswagen Eos, Golf VII, Passat (B6), Passat CC, Passat Variant, Sharan, Beetle, Scirocco, Tiguan

**ENGINE CODES**

Engine codes (1.8 L engines): CDAA, CDHA, CDHB, CJEB, CDAB, CGYA

Engine codes (2.0 L engines): CCZA, CDNB, CDNC, CFKA, CCZC, CPSA, CESA, CETA, CCZB, CDND, CCZD

**DESCRIPTION**

For pushing back the timing chain tensioner without removing the front engine cover

Needed when replacing the timing chain





**FITS FOR:** ŠKODA SEAT Audi Volkswagen

ART.NR	ITEM NAME	PRICE
BT595910	Timing chain test tool set for VAG 1.2, 1.4 TFSi	149,00 €

**FOR THE FOLLOWING MODELS**

Audi: A1 (2012-2015), A1 Sportback (2012-2015), A3 (2013-2015), A3 (2013-2015), A3 Sportback (2012-2015)  
 Seat: Ibiza (2012-2017), Leon (2012-2015), Toledo (2012-2017)  
 Skoda: Fabia II (2010-2015), Fabia III (2014-2017), Octavia II (2010-2013), Octavia III (2010-2015), Praktik (2010-2015), Roomster (2010-2015), Rapid (2015-2017)  
 Volkswagen: Golf VI & VII (2008-2015), Golf VII Kombi (2008-2017), Jetta (2012-2017), Polo (2012-2017), Sportsvan (2014-2017)

**DESCRIPTION**

For checking the timing chain elongation on VAG 1.2 and 1.4L TFSi engines

Prevents costly repairs at a later stage due to the timing chain slipping

**DELIVERY SCOPE**

Timing chain test tool set, use as OEM T10550

Comprises the following tools: Camshaft fixing tool, use as OEM T10550/1; indicator, use as OEM T10550/2; scale sleeve with crankshaft pulley plate, use as OEM T10550/3



**FITS FOR:** ŠKODA Audi Volkswagen

ART.NR	ITEM NAME	PRICE
BT597050	Engine adjustment tool set for Audi, VW V6 TDI	10,00 €

**FOR THE FOLLOWING MODELS**

Volkswagen Passat 2.5 V6 TDI  
 Audi A4 2.5 V6 TDI  
 Audi A6 2.5 V6 TDI  
 Audi A8 2.5 V6 TDI  
 Skoda Superb 2.5 V6 TDI

**ENGINE CODES**

Engine code: AFB, AKN, AKE, AYM, BAU, BCZ, BDG, BDH, BFC

**DESCRIPTION**

For locking the crankshaft/camshaft, and for carrying out work on the engine control, e.g. replacing the toothed belt, removing the cylinder heads etc.

**DELIVERY SCOPE**

Crankshaft fixing mandrel, use as OEM 3242  
 Camshaft interlock plates, use as OEM 3458

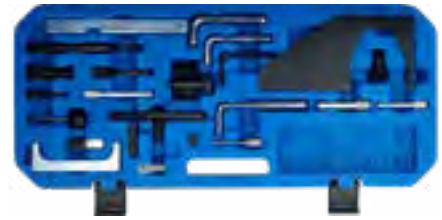

**FITS FOR:** SEAT Audi Mazda Volkswagen Ford

ART.NR	ITEM NAME	PRICE
BT593100	Engine adjustment tool set for Ford	109,00 €

**FOR THE FOLLOWING MODELS**

Suitable for the following Ford engines: 1.4, 1.6 16V, 1.7, 1.8 16V, 2.0 16V (including Zetec), 1.4, 1.6, 1.8, 1.9 D/TD/TDCi

**DESCRIPTION**

Contains tools for: Locking the flywheel

Locking the crankshaft, pump shaft

Locking the injection pump shaft

Removing the crankshaft pulley

Tensioning the toothed belt

Adjustment gauge for positioning the camshaft and pump shaft in relation to the crankshaft

Use as OEM 21-162, 21-162B, 303-367, 303-376, 23-059, 310-085, 21-168, 303-393, 23-020, 23-047, 23-020, 21-163, 303-620, 23-019, 21-210, 303-507, 21-251, 303-698, 21-262, 303-734, 23-029, 303-1061, 23-058, 310-084, 21-105, 21-262, 303-734, 21-168, 303-393, 21-263, 303-735, Mazda 49JED1061, Audi 3359, T10008, T10050, 2065A, Seat 3359, T10008, T10050, 2065A, Skoda 3359, T10008, T10050, 2065A, Volkswagen 3359, T10008, T10050, 2065A



**FITS FOR:** Universal

ART.NR	ITEM NAME	PRICE
BT596002	Universal camshaft wheel puller	63,00 €

**DESCRIPTION**

For pulling the pulley and camshaft gear

Gripping arms are connected with each other via adjusting disk, thus the gripping arms can be set easily and exactly

Continuous adjustment range of the gripping arms from 42 – 82 mm

Gripping arm depth is 27 mm

**DELIVERY SCOPE**

3 x gripping arms, Ø 12 mm, M10 x 1.5, suitable for material thickness up to max. 10 mm

6-groove puller body with adjusting disc

Spindle, M14 x 1.5, 19 mm hex, with centring cone



**9 pcs.**

**BT521000**  
**EAN 4042146778906**  
**Hose clamp plier set**

**83,- €**



ART.NR	ITEM NAME	PRICE
<b>BT591260</b>	Camshaft sprocket locking tool set, universal	<b>72,50 €</b>

**FOR THE FOLLOWING MODELS**

Can be used universally on vehicles from the following manufacturers: Audi, Alfa Romeo, Chrysler, Citroen, Ford, Honda, Hyundai, Isuzu, Land Rover, Lexus, Mazda, Mitsubishi, Peugeot, Renault, MG, Seat, Skoda, Subaru, Toyota, Opel, Volkswagen, Volvo

**DESCRIPTION**

For locking the camshaft sprockets e.g. when replacing the toothed belt

Suitable for engines with 1, 2 and 4 camshafts (V engines); also suitable for locking between the camshaft sprocket and diesel injection pump wheel in some diesel engines

**DELIVERY SCOPE**

Double camshaft locking tool with short and long connecting arm

Single camshaft locking tool with short and long locking screw



ART.NR	ITEM NAME	PRICE
<b>BT597806</b>	Crankshaft fixing tool for VAG 6-cylinder and 8-cylinder for Art. BT597800	<b>6,00 €</b>

**DELIVERY SCOPE**

Suitable for VW and Audi models with V6 TDI and V8 engines

For adjusting the crankshaft

Use as OEM 3242



ART.NR	ITEM NAME	PRICE
<b>BT597150</b>	Engine adjustment tool set for VAG 1.4, 1.6, 1.9, 2.0 SDI, TDI	<b>18,00 €</b>

**FOR THE FOLLOWING MODELS**

Audi A2 1.4 TDI (2002, 2006), A3 1.9, 2.0 TDI (2002, 2008), A4 1.6 TDI (2002, 2005), A4 1.9, 2.0 TDI (2004, 2008)

Seat Altea 1.9 SDI, TDI (2005, 2008), Leon 1.9, 2.0 TDI (2005, 2008), Toledo 1.9 SDI, TDI (2005, 2008) engine codes: BJB, BKC, BLS, BMM, BXE

Skoda Fabia 1.4 TDI (2003, 2006), Octavia II 2.0 TDI (2003, 2006), engine codes: AMF, AZV, BKD

Volkswagen Beetle 1.9 TDI (2002, 2008), Bora 1.9 TDI (2002, 2008), Fox 1.4 TDI (2002, 2008), Golf 1.9, 2.0 TDI (2002, 2008), Lupo 1.4 TDI (2002, 2008), Polo 1.4, 1.9 TDI (2002, 2008), Sharan 1.9 TDI (2002, 2008) engine codes: AJM, AMF, ANJ, ARL, ASZ, ATD, AUY, AVB, AVF, AWX, AXR, BAY, BMS, BNM, BNV, BWV

**ENGINE CODES**

AMF, ASZ, ATD, AVB, AVF, AWX, AXR, AZV, BHC, BKC, BKD, BKE, BLB, BMN, BNA, BPW, BRB, BRC, BRD, BRE, BUY, BVA, BVF, BVG\*

**DESCRIPTION**

For adjusting and checking the engine timing when replacing the toothed belt, camshaft etc.

**DELIVERY SCOPE**

Crankshaft interlock, use as OEM T10100

Pump wheel/camshaft interlock, use as OEM 3359, T20102, 9882, MB995206

Crankshaft interlock, use as OEM T10050, 9883, 310-085, 23-059, MB995209

4 mm marking pin, use as OEM T10115, 303-1054, MB995208

Auxiliary belt locking pin, use as OEM T10060A, T40098

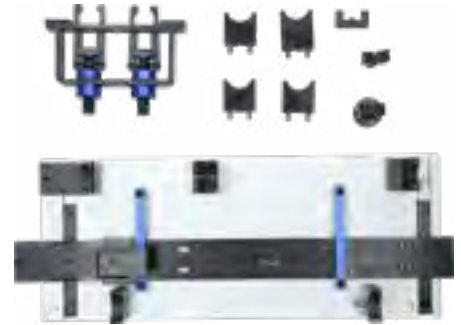

ART.NR	ITEM NAME	PRICE
<b>BT595920</b>	Camshaft assembly tool set for VAG and Porsche	<b>549,00 €</b>

**FOR THE FOLLOWING MODELS**

Suitable for the following diesel vehicles (TDI CR) from 2003 onwards: Audi, Porsche, Seat, Skoda, Volkswagen with 1.2, 1.6, 2.0, 2.7, 3.0, 4.0, 4.2 common rail engines

**ENGINE CODES**

Engine codes ASB, ASE, BKN, BKS, BMK, BNG, BPP, BSG, BTR, BUG, BUN, BVN, CAAA, CAAB, CAAC, CAAD, CAE, CAGA, CAGB, CAGC, CAHA, CAHB, CAMA, CAMB, CANA, CANB, CANC, CAND, CAPA, CARA, CASA, CASB, CASC, CASD, CATA, CAYA, CAYB, CAYC, CAYD, CAYE, CBAA, CBAB, CBAC, CBBA, CBBB, CBDA, CBDB, CBDC, CCFA, CCFC, CCHA, CCHB, CCLA, CCMA, CCWA, CCWB, CDBA, CDCA, CDSB, CDTA, CDTB, CDUC, CDUD, CDYA, CDYB, CDYC, CEGA, CEXA, CFCA, CFFA, CFFB, CFFD, CFFE, CFGB, CFGC, CFGD, CFHA, CFHB, CFHC, CFHD, CFHE, CFHF, CFJA, CFWA, CGKA, CGKB, CGLA, CGLB, CGLC, CGLD, CGLE, CGQB, CJAA, CJCA, CJCB, CJCC, CJCD, CJGA, CJGC, CJGD, CJMA, CKDA, CKTB, CKTC, CKUB, CKUC, CKVB, CKVC, CLAA, CLAB, CLCA, CLCB, CLJA, CLLA, CLNA, CLZB, CMFA, CMFB, CMGB, CMHA, CNEA, CNFA, CNRB, CRCA, CSHA, M05/9D (CAS), M05/9E, M05/9E (CRCA), M05/9E (CRCB)

**DESCRIPTION**

For installing the camshafts in the correct position

Needed when installing new or existing camshafts; attempting installation without this tool may lead to damage on the camshaft bearing bridge and the cylinder head

**DELIVERY SCOPE**

Mounting device including pre-assembled parts, use as OEM T40094

Camshaft clamp, use as OEM T40095

2 alignment clamps, use as OEM T40096, T40096/1

4 camshaft brackets for mounting device, use as OEM T40094/1, T40094/2, T40094/9, T40094/10

Interlock for camshaft bracket, use as OEM T40094/11



# OUTSIDE HUI, INSIDE TOO!



# SUBARU



ART.NR	ITEM NAME	PRICE
<b>BT671050</b>	Drive shaft retractor set	<b>89,00 €</b>

**FOR THE FOLLOWING MODELS**

- M16 x 1.5 mm: for Subaru
- M20 x 1.5 mm: for VW Beetle, Touareg, Porsche Cayenne
- M22 x 1.5 mm: for BMW E30, E46
- M24 x 1.5 mm: for BMW E36, Mercedes W203
- M27 x 1.5 mm: for BMW E32, E34, E38, E39, X5
- M30 x 1.5 mm: for BMW E32, E34, E36

**DESCRIPTION**

For pulling the drive shaft into the wheel hub  
In a standardised industrial bearing  
Contains 6 pulling sleeves with various threads



ART.NR	ITEM NAME	PRICE
<b>BT591260</b>	Camshaft sprocket locking tool set, universal	<b>72,50 €</b>

**FOR THE FOLLOWING MODELS**

Can be used universally on vehicles from the following manufacturers: Audi, Alfa Romeo, Chrysler, Citroen, Ford, Honda, Hyundai, Isuzu, Land Rover, Lexus, Mazda, Mitsubishi, Peugeot, Renault, MG, Seat, Skoda, Subaru, Toyota, Opel, Volkswagen, Volvo

**DESCRIPTION**

For locking the camshaft sprockets e.g. when replacing the toothed belt  
Suitable for engines with 1, 2 and 4 camshafts (V engines); also suitable for locking between the camshaft sprocket and diesel injection pump wheel in some diesel engines

**DELIVERY SCOPE**

Double camshaft locking tool with short and long connecting arm  
Single camshaft locking tool with short and long locking screw



ART.NR	ITEM NAME	PRICE
<b>BT596002</b>	Universal camshaft wheel puller	<b>63,00 €</b>

**DESCRIPTION**

For pulling the pulley and camshaft gear  
Gripping arms are connected with each other via adjusting disk, thus the gripping arms can be set easily and exactly  
Continuous adjustment range of the gripping arms from 42 – 82 mm  
Gripping arm depth is 27 mm

**DELIVERY SCOPE**

3 x gripping arms, Ø 12 mm, M10 x 1.5, suitable for material thickness up to max. 10 mm  
6-groove puller body with adjusting disc  
Spindle, M14 x 1.5, 19 mm hex, with centring cone

**BT511005**  
**EAN 4042146778791**  
**Extra long TX screwdriver set**

**9**  
pcs.

**T15**  
**T20**  
**T25**  
**T27**  
**T30**

**29,- €**

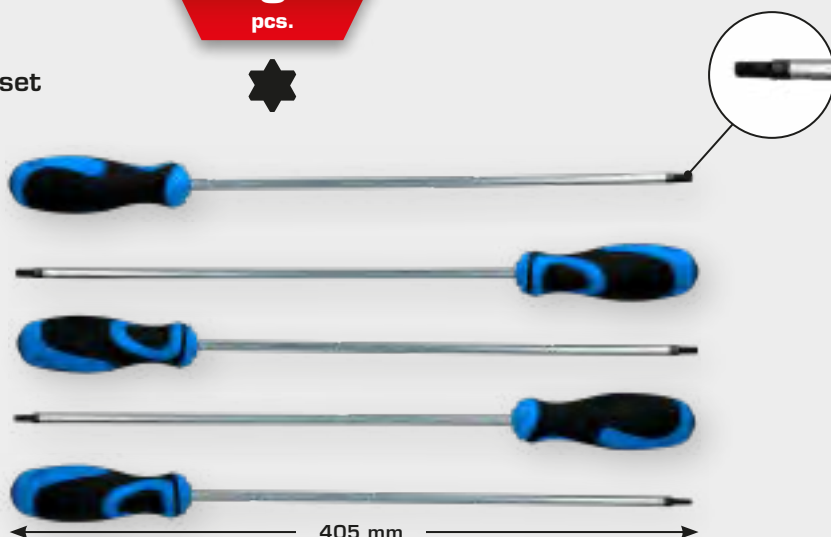



**WITH THE HIGHEST  
PRECISION TO THE GOAL**

# VOLVO

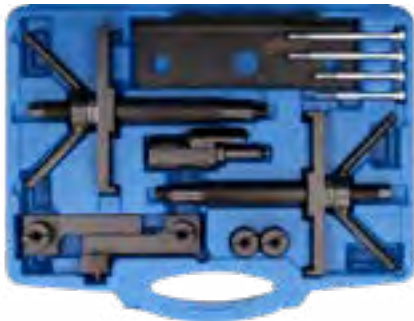

FITS FOR:

ART.NR	ITEM NAME	PRICE
<b>BT597850</b>	Engine adjustment tool set for Volvo 4/5/6-cylinder up to 2006	<b>119,00 €</b>

#### DESCRIPTION

For aligning the camshaft and crankshaft

Makes it possible to align the camshafts correctly, even when the valve cover is fitted

Suitable for 4, 5 and 6-cylinder DOHC engines (not 3.2L) up to 2006 on Volvo models 700, 800, 850, 900, 960, C70, S40, S60, S70, S80, S90, V70 -2000, V70XC, XC70, V90, XC90

#### DELIVERY SCOPE

Valve lid tool, 2 pcs, use as OEM 9995454

Crankshaft adjustment mandrel, use as OEM 9995452

Camshaft adjustment tool, use as OEM 9995451

Holder, use as OEM 9995453

2x 110 mm and 2x 85 mm screws



FITS FOR:

ART.NR	ITEM NAME	PRICE
<b>BT571014</b>	Crankshaft vibration damper alignment tool for Ford, Volvo	<b>6,00 €</b>

#### DESCRIPTION

For aligning the crankshaft vibration damper (crankshaft pulley)

Needed for e.g. 1.6 L EcoBoost engines

Use as OEM Ford 303-1550 or Volvo 9997431



FITS FOR:

ART.NR	ITEM NAME	PRICE
<b>BT597900</b>	Engine adjustment tool set for Volvo T6	<b>159,00 €</b>

#### FOR THE FOLLOWING MODELS

Suitable for Volvo S80, XC90, XC60, XC70 with 3.0T and 3.2 T6 engine from 2007 onwards

#### DESCRIPTION

For adjusting and checking the engine timing

#### DELIVERY SCOPE

Crankshaft lathe tool, use as OEM 9997257, 303-1219

Camshaft adjustment tool, use as OEM 9997261, 303-1223

Tool for assembly and disassembly of the front cover, use as OEM 9997263, 303-1225

Tool for assembly and disassembly of the front cover, use as OEM 9997264, 303-1226

T-profile insert, T60, 12.5 (1/2), use as OEM 9997272

Mounting angle, use as OEM 9997271

Front cover adjustment tool, use as OEM 9997266

Front cover adjustment tool, use as OEM 9997267



FITS FOR:

ART.NR	ITEM NAME	PRICE
<b>BT594670</b>	Engine adjustment tool set for Renault, Volvo, Ford 16V, 20V petrol	<b>29,00 €</b>

#### FOR THE FOLLOWING MODELS

Renault Laguna (1996, 1999), Safrane (1996, 2001) with engine codes: N7Q 704, 710, 711 N7U 700, 701

Ford Kuga (from 02/2008 onwards), Focus ST RS (from 07/2004 onwards), S-Max (from 03/2006 onwards), Galaxy (from 03/2006 onwards), Mondeo (from 02/2007 onwards) with engine codes: JZDA, HYDB, HYDC, HUWA

Volvo 850 (1992, 1997), C70 (1998, 2002), S40 (1996, 2004), V40 (1996, 2004), S60 (2001, 2005), S70 (1997, 2000), S80 (1999, 2005) with engine codes: B4164 S/S2, B4184 S/S2/S3/S9/S10, B4194 T/T2, B4204 S/S2/T/T2/T3/T5, B5202 FS, B5204 FT/T2/T3/T4/T5, B5234 T3/T4/T5/T6/T7/T8/T9, B5244 S/S2/S6/S62/T3/T4/T5/T7, B5252 FS, B5254 T/T2/T4

#### DESCRIPTION

Contains important tools for adjusting the engine timing

1.6, 1.8, 1.9, 2.0, 2.3, 2.4, 2.5L DOHC engines

#### DELIVERY SCOPE

Camshaft retainer, use as OEM MOT1337, 999-5452, 303-1178

Tension roller key, use as OEM MOT1348

Flywheel retainer, use as OEM MOT1340, 999-5451, 303-1182





FITS FOR:



ART.NR	ITEM NAME	PRICE
BT594650	Engine adjustment tool set for Renault	159,00 €

**FOR THE FOLLOWING MODELS**

Renault petrol engines 1.4, 1.6, 1.8, 2.0 l, each with 16V technology  
 Renault petrol engines 2.5 l, 20V with dual camshafts  
 Renault petrol engines 1.2, 1.4, 1.6, 1.7, 1.8, 2.0, 2.2 l  
 Renault diesel engines 1.9, 2.5, 2.8 l  
 Also for Opel Arena, Movano and Volvo V40, S40

**DESCRIPTION**

Locking the flywheel  
 Locking the crankshaft, injection pump shaft  
 Removing the crankshaft pulley  
 Tensioning the toothed belt  
 Adjustment gauge for positioning the camshaft and pump shaft in relation to the crankshaft  
 Use as OEM tools MOT1348, MOT1312, MOT1135-01, MOT1384, MOT1337, MOT1496, MOT910-1, MOT910, MOT861, MOT863, MOT1054, MOT1318, MOT1489, MOT1340, MOT1386, MOT1490, MOT1490-1, KM6031

FITS FOR:



ART.NR	ITEM NAME	PRICE
BT592880	Engine adjustment tool set for Rover, Peugeot, Ford, Volvo 2.0, 2.2 l D	12,00 €

**FOR THE FOLLOWING MODELS**

Peugeot 807 (2005, 2011), 407 (2005, 2011), 607 (2005, 2009), engine DW10UTED4 (RHK), DW10BTED4 (RHR)/DW12BTED4 (4HS), (4HP), (4HT), (4HR)  
 Citroën C4 (2004, 2010), C5 II (2004, 2010), engine DW10BTED4 (RHR)  
 Land Rover Freelander (2006, 2010), engine DW12BTED4, 224DT  
 Volvo S40 (2003, 2010), V50 (2006, 2010), C70 (2006, 2010), S80 (2007, 2010), C30 (2006, 2010), V70 (2007, 2010), engine D420T 2.0D  
 Ford S-Max 2.2 (2008, 2010), Galaxy 2.2 (2008, 2010), Mondeo 2.2, 2.0 (2007, 2010)

**ENGINE CODES**

Engine codes: QXBA(2.2), QXWA(2.0), QXBB(2.0), Q4BA(2.2), QXWA(2.0), QXWB(2.0), AZBA(2.0), AZBC(2.0), AZWA(2.0)

**DESCRIPTION**

Makes it easier to check and adjust the engine timing

**DELIVERY SCOPE**

Camshaft interlock, use as OEM PSA 0188.M, Ford 303-735, 303-1277, Volvo 999-7122  
 Crankshaft interlock, use as OEM PSA 0188.X, Ford 303-1059, 303-1270, Volvo 999-7121  
 Flywheel interlock, use as PSA 0188.F, Ford 303-393A, 303-393-01, 303-1272, Volvo 999-7119/7120

FITS FOR:



ART.NR	ITEM NAME	PRICE
BT597920	Engine adjustment tool set for Volvo B4204	310,00 €

**DESCRIPTION**

For adjusting and checking the engine timing  
 Needed e.g. when working on the valve train and replacing the cylinder head seal  
 Suitable for Volvo B4204 engine (8-speed gearbox)

**DELIVERY SCOPE**

Crankshaft counter support, use as OEM 9997495  
 Crankshaft wheel extractor, use as OEM 9997493  
 Radial sealing ring assembly too, use as OEM 9997496  
 Camshaft sprocket tool, use as OEM 9997497  
 Camshaft adjustment tool, use as OEM 9997490

**OUR ASSORTMENT: LARGE**  
**OUR LOGISTICS: POWERFUL**



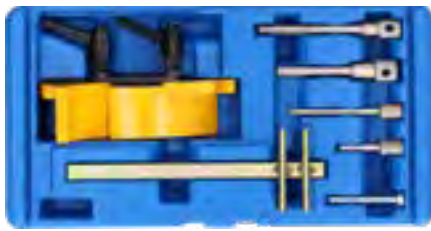

ART.NR	ITEM NAME	PRICE
<b>BT594570</b>	Engine adjustment tool set for Renault, Opel, Volvo, Mitsubishi, Chrysler	<b>41,00 €</b>

**FOR THE FOLLOWING MODELS**

Renault: Clio (1990-2013), Espace, Grand Espace (1996-2002), Extra, Rapid, Express (1991-2002), Kangoo (1998-2009), Laguna (1994-2001), Megane (1995-2003), Scenic (1996-2003), Modus, Grand Modus II (2004-2013), Safrane (1992-2001), Trafic (1997-2000), Master II (2000-2003), Twingo (2000-2013), Wind (2011-2013)

Opel: Arena (1997-2001), Movano-A (1999-2006), Vivaro (2001-2007)

Volvo: S40 (1996-2004), V40 (1996-2004)

Mitsubishi: Carisma (2001-2005), Space Star (2000-2006)

Chrysler: Cherokee (1984-1995), Wrangler (1988-1995)

**ENGINE CODES**

E7F 1.2: 700, 704, 706, 708, 750

D4F 1.2 16v: 702, 704, 706, 708, 712, 714, 716, 722, 728, 730, 740, 742, 764, 772, 780, 782, 784, 786

E7J 1.4: 601, 624, 626, 634, 635, 710, 711, 716, 718, 719, 754, 756, 757, 764, 780

F3P 1.8: 674, 676, 678, 710, 712, 714, 720, 724, 755, 758, B670, Q7, R7, S724

F7P 1.8 16v: 720, 722

F8Q 1.9D/Turbo: 600, 606, 620, 622, 624, 630, 632, 644, 646, 648, 662, 672 /676, 678, 680, 682, 684, 692 /696, 714, 722, 724, 730, 732, 776, 784, 786, 788, 790, B640

F9Q 1.9D dTi: F9Q1, F9Q2, 710, 716, 717, 720, 722, 730, 731, 734, 736, 744, 760, 762, 770, 774, 780, 782, 790 D4192T, D4191T2 D4192T3, D4192T4

F3R 2.0: 611, 722, 723, 742, 750, 751, 752, 768, 769, 791, 796, 797, 798

J7R 2.0: 732, 733, 734, 735

F7R 2.0 16V: 700, 714, D710

J7T 2.2 16V: 760, 761

G8T 2.2D/Turbo: 706, 714, 716, 740, 752, 760, 790, 792, 794

**DESCRIPTION**

For adjusting the engine timing on Renault petrol and diesel engines

**DELIVERY SCOPE**

- Camshaft locking tool, adjustable for DOHC engines
- Injection pump wheel fixing mandrel, use as OEM Mot.910
- Tension roller key, use as OEM Mot1135-01
- Crankshaft fixing mandrel, use as OEM Mot.1318
- Crankshaft fixing mandrel, use as OEM Mot.1054
- Crankshaft fixing mandrel, use as OEM Mot.910



ART.NR	ITEM NAME	PRICE
<b>BT592810</b>	Camshaft holding tool and crankshaft sealing ring tool set for Ford, Volvo 2.5 Turbo	<b>91,00 €</b>

**FOR THE FOLLOWING MODELS**

Suitable for the following vehicles: Ford Focus (2005-2011), Galaxy (2006-2010), Kuga (2009-2013), Mondeo (2007-2010), S-Max (2006-2010), Volvo C30 (2006-2013), C70 (2006-2013), S40 (2003-2012), S60 (2003-2016), S80 (2003-2012), V40 (2012-2015), V50 (2004-2012), V70 (2002-2012), XC60 (2014-2016), XC70 (2002-2007), XC90 (2002-2014)

**ENGINE CODES**

Engine codes: HYDA, HYDB, HUBA, B5254T10, B5254T11, B5254T12, B5254T14, B5254T2, B5254T3, B5254T4, B5254T5, B5254T6, B5254T7, B5254T8, B5254T9

**DESCRIPTION**

For holding the camshaft in place when checking the valve clearance and fitting the front camshaft radial sealing ring

Suitable for: Ford & Volvo 2.5L Duratec-VE (V6) Turbo petrol engines

**DELIVERY SCOPE**

- Camshaft holder, use as OEM 303-1183, 9995765
- Crankshaft sealing ring inserter, use as OEM 303-1180
- Crankshaft sealing ring guide, use as OEM 303-1180



ART.NR	ITEM NAME	PRICE
<b>BT593040</b>	Engine adjustment tool set for Ford 2.5, Volvo 1.6, 2.5 and 2.4D	<b>132,00 €</b>

**FOR THE FOLLOWING MODELS**

Ford Focus 2.5 RS, ST, Mondeo 2.5, S-Max 2.5, Galaxy 2.5 ST (from 2005 onwards)

Volvo C30 (2006, 2010), C70 (1998, 2010), S40 (1996, 2010), S60 (2000, 2009), S70 (1997, 2007), S80 (1998, 2006), V40 (1996, 2010), V50 (2004, 2010), V70 (1997, 2007), XC70 (2002, 2007), XC90 (2002, 2010)

**ENGINE CODES**

Ford engine codes: 2.5 Turbo (Euro 4), HUBA, HUWA, HYDA, JZDA

Engine codes: 1.6 (B4164S), 1.8 (B4184S), 1.9T (B4194T), 2.0 (B4204S, B4204T), 2.0T (B5204T3, B5204T4, B5204T5), 2.3 (B5234FS), 2.3T (B5234T3, B5234T7, B5234T9), 2.4 (B5244S, B5244S2, B5244S4, B5244S5, B5244S7), 2.4T (B5244T, B5244T3, B5244T4, B5244T5, B5244T7), 2.5R (B5254FS), 2.4D (D5244T9, D5244T8, D5244T13)

**DESCRIPTION**

For adjusting the camshaft and crankshaft when replacing the cylinder head seal

**DELIVERY SCOPE**

- Crankshaft pulley holding tool, use as OEM 999 5433, 303-1179
- Camshaft alignment tool, use as OEM 303-1178
- Crankshaft alignment tool, use as OEM 303-1182
- Camshaft holder, use as OEM 303-1183





FITS FOR:



FITS FOR:



ART.NR	ITEM NAME	PRICE
<b>BT592860</b>	Engine adjustment tool set for Ford TDCi, PSA Hdi, Mazda D 1.4, 1.6	<b>5,00 €</b>

DESCRIPTION
For adjusting the engine timing when replacing the camshaft, cylinder head seal etc.

ART.NR	ITEM NAME	PRICE
<b>BT594460</b>	Engine adjustment tool set for PSA 2.5, 2.8 l diesel	<b>12,00 €</b>

**FOR THE FOLLOWING MODELS**

Citroen, Peugeot, Fiat, Iveco Traffic (1980-2000), Master (1980-2007), Mascot (1999-2007)  
Fiat, PSA, Renault Daily (1991-2005), Turbo Daily (1994-2000), Relay, Jumper (2001-2002) Boxer (2000-2006), Arena (1997-2001), Movano (1998-2003)

**FOR THE FOLLOWING MODELS**

Citroen 1.4Hdi DV4TD (8HT/8HW/8HX/8HZ), 1.4Hdi DV4TED4 (8HV/8HY), 1.6Hdi DV6TED4 (9HY/9HZ), 1.6Hdi DV6ATED4 (9HW/9HX), 1.6Hdi DV6UT-ED4(9HU)  
Mazda 1.4CiTD F6JA, F6JB 1.6CiTD Y6  
Peugeot 1.4Hdi DV4TD (8HT/8HW/8HX/8HZ), 1.4Hdi DV4TED4 (8HV/8HY), 1.6Hdi DV6TED4 (9HY/9HZ), 1.6Hdi DV6ATED4 (9HW/9HX), 1.6Hdi DV6UT-ED4(9HU)  
Ford 1.4TDCi F6JA, F6JB, F6JC, F6JD 1.6TDCi G8DA, G8DB, HHDA 1.6TDCi HHDB, HHJA, HHJB, HHJD  
Volvo 1.6D D4164T

**DELIVERY SCOPE**

Flywheel locking bolt, use as OEM PSA 0194-C, Ford 303-734 (21-262), Volvo 999-7169, Mazda 49 JE02 020  
Crankshaft and high-pressure pump wheel locking pin, 2 pcs, use as OEM PSA 0194-A, Ford 303-732 (21-260), Volvo 999-7233, Mazda 49 JE02 018  
Crankshaft and high-pressure pump wheel locking pin, 2 pcs, use as OEM PSA 0194-A, Ford 303-732 (21-260), Volvo 999-7233, Mazda 49 JE02 018

**DESCRIPTION**

Use as OEM Fiat 1 870 667 000, 1 870 765 001, 1 860 617 000, Renault MOT861, MOT1054, MOT863, Opel KM6031, Ford 21-260, 303-732, Peugeot 0132AB, 5711TD, 4527TS2, 0178D, 0194A, 119790, Citroen 0132AB, 5711TD, 4527TS2, 0178D, 0194A, 119790, Mazda 49 JE 02018, 0991246510, Volvo 999-7169

**DELIVERY SCOPE**

2 locking bolts  
Flywheel locking bolt  
Holding tool for toothed belt tensioner



**OUR PACE:  
HIGH.  
OUR TECHNOLOGY:  
INNOVATIVE**



# VOLKSWAGEN



ART.NR	ITEM NAME	PRICE
<b>BT551340</b>	Alignment and O-ring assembly set for VAG pump/nozzle unit	<b>60,00 €</b>

### FOR THE FOLLOWING MODELS

5-cylinder and 10-cylinder VW Phaeton, Touareg from year of construction 2003 onwards, T5 from year of construction 2004 onwards, etc.

4-cylinder VW Golf, Touareg, Audi A3 from year of construction 2004 onwards, etc.

### DESCRIPTION

Enables precise positioning of the pump/nozzle unit and damage-free fitting of the O-rings

An incorrectly installed pump/nozzle unit entails a risk of damage to the cylinder head and the pump/nozzle unit itself

### DELIVERY SCOPE

- Adjustment gauge, steel, use as OEM T10210
- O-ring fitting sleeve, brass, use as OEM T10056/1
- O-ring fitting sleeve, brass, use as OEM T10056/2
- O-ring fitting sleeve, brass, use as OEM T10056/3
- O-ring fitting sleeve, brass, use as OEM T10164/1
- O-ring fitting sleeve, brass, use as OEM T10164/2



ART.NR	ITEM NAME	PRICE
<b>BT551350</b>	Adjustment gauges for VAG pump/nozzle unit on 3-cylinder and 4-cylinder engines	<b>90,00 €</b>

### DESCRIPTION

For adjusting the pump/nozzle units

Suitable for 3-cylinder and 4-cylinder engines and for pump/nozzle units with old and new solenoid valve nut

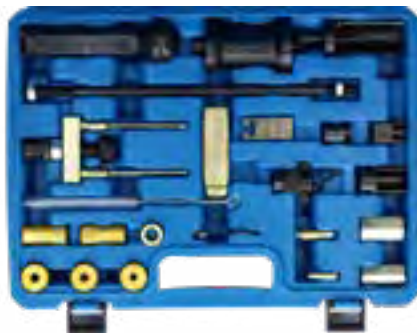

ART.NR	ITEM NAME	PRICE
<b>BT551360</b>	FSI nozzle assembly/disassembly kit	<b>89,00 €</b>

### DESCRIPTION

Suitable for VW, Audi, Seat, Skoda with petrol direct injection and engines with a pump/nozzle unit

Use as tools OEM T10133 + T10163

### DELIVERY SCOPE

- Puller for dismantling FSI nozzles, use as T10133/1
- Extractor claw for dismantling FSI nozzles, use as T10133/2
- Slide hammer, use as T10133/3
- Assembly cone for fitting the combustion chamber sealing rings, use as T10133/5
- Calibration sleeves for fitting the combustion chamber sealing rings, use as T10133/6, T10133/7, T10133/8
- Fitting mandrel for fitting the FSI nozzles, use as T10133/9
- Puller for removing pump/nozzle units



ART.NR	ITEM NAME	PRICE
<b>BT591080</b>	Engine adjustment tool set for VAG	<b>10,00 €</b>

### DESCRIPTION

VAG 2.0 L TDI and some 1.9L TDI with oval crankshaft wheel

### DELIVERY SCOPE

- Interlock tool for crankshaft wheel, use as OEM T10100
- Interlock mandrel for pump wheel, use as OEM 3359
- Interlock plate for tensioning roll, use as OEM T10008



ART.NR	ITEM NAME	PRICE
<b>BT591040</b>	Camshaft locking tool for VAG W8 and W12	<b>40,00 €</b>

### DESCRIPTION

- For aligning the camshafts
- Suitable for V6 R32 3.2L FSI W8 and 6.0L W12
- 2 alignment rules
- Use as OEM T10068, T10068A



ART.NR	ITEM NAME	PRICE
<b>BT597100</b>	Engine adjustment tool set for VAG	<b>11,00 €</b>

### DESCRIPTION

VAG 1.2 1.4 1.9 L TDI with round crankshaft wheel

### DELIVERY SCOPE

- Interlock tool for crankshaft wheel, use as OEM T10050
- Interlock mandrel for pump wheel, use as OEM 3359
- Interlock plate for tensioning roll, use as OEM T10008





**FITS FOR:** Audi Volkswagen SKODA SEAT

ART.NR	ITEM NAME	PRICE
<b>BT597010</b>	Engine adjustment tool set for VAG FSI, TSI 1.4, 1.6 (with timing chain)	<b>29,00 €</b>

**FOR THE FOLLOWING MODELS**

Audi A3 (2003-2010)  
Seat Ibiza, Leon, Altea  
Skoda Octavia (2004-2009), Fabia (2007-2009), Superb (2009-2010), Roomster (2006-2009)  
Volkswagen Golf (2003-2009), Golf Plus (2005-2009), Jetta (2006-2009), Passat (2005-2009), Polo (2002-2008), Scirocco (2009-2010), Tiguan (2007-2009), Touran (2003-2009), Eos (2006-2009)

**ENGINE CODES**

Engine code AXU, BLG, BAG, BMY, BKG, BMK, BLF, CAVA, BLN, CAVB, BLP, CAVC, CAVE, CAVF, CAVD, CAXA, CAXC, CDGA, BTS

**DESCRIPTION**

For checking and adjusting the timing  
Needed e.g. when replacing the timing chain  
Suitable for VAG FSI and TFSI 1.4 and 1.6 L engines

**DELIVERY SCOPE**

Camshaft locking device, use as OEM T10171  
Dial gauge bracket, use as OEM T10170  
Crankshaft interlock, use as OEM T10340  
Hydraulic tensioner interlock, use as OEM T40011



**FITS FOR:** Audi Volkswagen SKODA SEAT

ART.NR	ITEM NAME	PRICE
<b>BT597151</b>	Locking tool for crankshaft timing belt pulleys for VAG	<b>6,00 €</b>

**DESCRIPTION**

VAG 2.0 L TDI and 1.9 L with oval crankshaft wheel  
Use as OEM T10100

**FITS FOR:** Volkswagen Audi

ART.NR	ITEM NAME	PRICE
<b>BT597800</b>	Engine adjustment tool set for VAG	<b>139,00 €</b>

**FOR THE FOLLOWING MODELS**

1.9L, 2.0L TDI pump/nozzle  
1.9L TDI  
2.5L V6-TDI  
3.3L V8-TDI  
1.2L 3-cylinder and 1.4, 1.6L petrol engines

**DELIVERY SCOPE**

Camshaft adjustment gauge (e.g. VW 1.9 l TDI)  
Toothed belt pulley interlock tool (e.g. VW, Skoda 1.9L, 2.0L TDI pump/nozzle)  
Camshaft interlock tool (e.g. VW, Audi 2.5L V6 TDI)  
3-way adjustable toothed belt tension roller spanner (universal, for VW, Audi)  
Interlock mandrel for injection pump wheel (e.g. VW, Audi, Seat, Skoda amongst others)  
Retaining plate for toothed belt tensioning device (VW, Skoda 4-cylinder TDI pump/nozzle)  
Open plug-in unit SW22 for assembly and disassembly of diesel injection nozzles  
Camshaft adjustment tools, use as OEM T10123, T10120, 3458, 3418, 2065A, 3366, T10098, 3418  
Crankshaft adjustment tools, use as OEM T10121, 3242, T10050, T10100  
Tensioning roller interlock tools, use as OEM T10060A, T10020, T10008, T40011  
Injection pump interlock tools, use as OEM 3359, 2064



**FITS FOR:** Volkswagen Audi SEAT SKODA

ART.NR	ITEM NAME	PRICE
<b>BT597152</b>	Locking tool for crankshaft timing belt pulleys for VAG	<b>5,00 €</b>

**DESCRIPTION**

VAG 1.2, 1.4, 1.9 L TDI with round crankshaft wheel  
Use as OEM T10050

**FITS FOR:** Volkswagen Audi

ART.NR	ITEM NAME	PRICE
<b>BT591030</b>	Engine adjustment tool set for VAG	<b>59,00 €</b>

**FOR THE FOLLOWING MODELS**

Audi A3 1.8 Turbo (AGN AGU AJQ APG APP AQA ARX ARY ARZ AUM AUQ) 1996-2003, A3 1.6 FSI (BAG) 2003-2006, S3 1.8 Turbo (AMK APY BAM) 1996, A4 1.8 Turbo (ADR AEB AJL AJP ANB APU AVJ AWT) 1994-2006, A6 1.8 Turbo (ADR AEB AJL AJP ANB APU AVJ AWT) 1994-2006, Cabriolet 1.8 (ADR) 1997-2000, TT 1.8 Turbo (AJQ APP APX AUM AUQ BAM) 1998-2006

Volkswagen Beetle 1.8 Turbo (AVC) 1999-2006, Touran 1.6 FSI (BAG BLP) 2003-2007, Golf 1.8 Turbo (AGN AGU AQA ARZ AUM AUQ) 1997-2005, Bora 1.8 Turbo (AGN AGU AQA ARZ AUM AUQ) 1997-2005, Passat 1.8 Turbo (ADR AEB ANB APT APU ARG AWT) 1996-2005, Sharan 1.8 Turbo (AJH AWC) 1997-2007

Seat Ibiza 1.8 Turbo (AQX AYP) 1999-2002, Cordoba 1.8 Turbo (AQX AYP) 1999-2002, Leon 1.8 Turbo (AJQ AGN APG APP APT ARY AUQ) 1999-2005, Toledo Turbo (AGN APG APT ARY AUQ) 1999-2005, Alhambra 1.8 Turbo (AJW AWC) 1997-2007

Skoda Octavia 1.8 FSI Turbo (AGN AGU ARX ARZ AUM) 1996-2005, Octavia 1.8 Turbo 20V RS (AUQ) 2000-2006, Octavia 1.6 FSI (BLF) 2004-2007

**ENGINE CODES**

Suitable for 1.8 L turbo and 1.6 L FSI engines

**DELIVERY SCOPE**

Counter support for crankshaft, use as OEM 3036  
Camshaft fixing tool, use as OEM T10171  
Counter support for drive sprockets of oil pump gear, camshaft, vibration damper, use as OEM T10172  
Adapter pieces for counter support, use as OEM T10172  
Chain tensioner bracket for installation and removal of the chain tensioner, use as OEM T20018, 3366  
Tension roller element fixing pin, use as OEM T40011

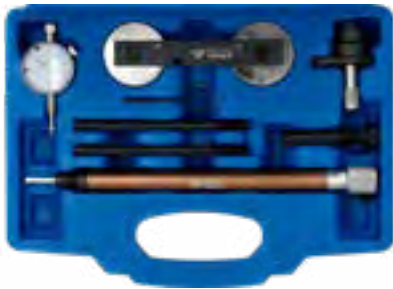

FITS FOR:

ART.NR	ITEM NAME	PRICE
<b>BT597500</b>	Engine adjustment tool for VAG 1.2, 1.4, 1.6 FSI, 1.4 TSI	<b>73,00 €</b>

**FOR THE FOLLOWING MODELS**

Audi A1, A3, A3 Sportback, A3 Cabriolet  
Seat Altea, Altea XL, Ibiza, Ibiza Sport Coupe, Leon, Toledo  
Skoda Fabia, Fabia, Octavia, Rapid, Roomster, Yeti  
VW New Beetle, Caddy, Golf, Golf Plus, Golf Cabriolet, Golf Variant, Jetta, Polo, Touran

**ENGINE CODES**

AXU, BAG, BKG, BLF, BLN, BLP, BMY, BTS, BLG, BWK, CAVA, CAVB, CAVC, CAVD, CAVF, CAXA, CAXC, CDGA

**DESCRIPTION**

For adjusting and checking the engine timing

**DELIVERY SCOPE**

Camshaft locking device, use as OEM T10171  
Dial gauge, use as OEM T10170 (dial gauge holder with 274 mm total length, exterior thread M14 x 1.25 mm)  
Crankshaft interlock, use as OEM T10340  
Hydraulic tensioner interlock, use as OEM T40011 (8 mm tension shaft)  
Precision dial gauge for locating the piston OT (resolution: 0.01 mm / measuring range: 0-8 mm / diameter: 41 mm)  
2x crankshaft wheel locking pin, use as OEM T10341 (two guide bolts with 135 mm length, 24 mm long exterior thread M8 x 1.25 mm, reciprocal external hex with 6 mm width between flats)  
Camshaft interlock, use as OEM T10414



FITS FOR:

ART.NR	ITEM NAME	PRICE
<b>BT597250</b>	Engine adjustment tool set for Volkswagen	<b>38,00 €</b>

**FOR THE FOLLOWING MODELS**

for VW Transporter 2.4D (95-03), Crafter 2.5TDI (06-09) and LT models

**ENGINE CODES**

Engine codes: AAB, AJA, BJJ, BJK, BJJ, BJM

**DELIVERY SCOPE**

Use as OEM T10025, 2065A, 2064



FITS FOR:

ART.NR	ITEM NAME	PRICE
<b>BT595800</b>	Engine adjustment tool set for Volkswagen 1.2	<b>11,00 €</b>

**DELIVERY SCOPE**

Can also be used as a replacement for Art. BT597800  
Use as OEM T10123



FITS FOR:

ART.NR	ITEM NAME	PRICE
<b>BT597802</b>	Special tool for controlling engine timing for VAG 1.2	<b>11,00 €</b>

**FOR THE FOLLOWING MODELS**

Needed when checking the engine timing and replacing the toothed belt  
Suitable for VAG 3-cylinder engines with code AMY, BMD, BBM  
Use as OEM T10120

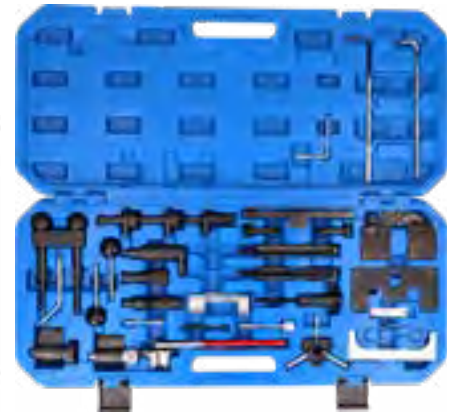

FITS FOR:

ART.NR	ITEM NAME	PRICE
<b>BT597800</b>	Engine adjustment tool set for VAG	<b>139,00 €</b>

**FOR THE FOLLOWING MODELS**

1.9L, 2.0L TDI pump/nozzle  
1.9L TDI  
2.5L V6-TDI  
3.3L V8-TDI  
1.2L 3-cylinder and 1.4, 1.6L petrol engines

**ENGINE CODES**

OE-Code Audi: 2065A, T10008, T10016, T10020, T10050, T10060A, T10098, T10100, T10120, T10121, T10264, T10265, T40011, 2064, 3242, 3359, 3366, 3369, 3418, 3458, T10123  
OE-Code Seat: 2065A, T10008, T10016, T10020, T10050, T10060A, T10098, T10100, T10120, T10121, T10264, T10265, T40011, 2064, 3242, 3359, 3366, 3369, 3418, 3458, T10123  
OE-Code Škoda: 2065A, T10008, T10016, T10020, T10050, T10060A, T10098, T10100, T10120, T10121, T10264, T10265, T40011, 2064, 3242, 3359, 3366, 3369, 3418, 3458, T10123  
OE-Code Volkswagen: 2065A, T10008, T10016, T10020, T10050, T10060A, T10098, T10100, T10120, T10121, T10123, T10264, T10265, T40011, 2064, 3242, 3359, 3366, 3369, 3418, 3458, T10123

**DELIVERY SCOPE**

Camshaft adjustment gauge (e.g. VW 1.9 I TDI)  
Toothed belt pulley interlock tool (e.g. VW, Skoda 1.9L, 2.0L TDI pump/nozzle)  
Camshaft interlock tool (e.g. VW, Audi 2.5L V6 TDI)  
3-way adjustable toothed belt tension roller spanner (universal, for VW, Audi)  
Interlock mandrel for injection pump wheel (e.g. VW, Audi, Seat, Skoda amongst others)  
Retaining plate for toothed belt tensioning device (VW, Skoda 4-cylinder TDI pump/nozzle)  
Open plug-in unit SW22 for assembly and disassembly of diesel injection nozzles  
Camshaft adjustment tools, use as OEM T10123, T10120, 3458, 3418, 2065A, 3366, T10098, 3418  
Crankshaft adjustment tools, use as OEM T10121, 3242, T10050, T10100  
Tensioning roller interlock tools, use as OEM T10060A, T10020, T10008, T40011  
Injection pump interlock tools, use as OEM 3359, 2064



FITS FOR:

ART.NR	ITEM NAME	PRICE
<b>BT597200</b>	Engine adjustment tool set for VAG 2.5 and 4.9D TDI pump/nozzle	<b>319,00 €</b>

**FOR THE FOLLOWING MODELS**

VW T5 from 2004 onwards, Touareg from 2003 onwards, VW Phaeton from 2003 onwards with 5-cylinder and 10-cylinder engines

**ENGINE CODES**

Engine codes: AXD, AXE, BAC, BLJ, BLK, BNZ, BPC, BPD, BPE

**DELIVERY SCOPE**

Camshaft interlock for checking and adjusting the timing on 5-cylinder and 10-cylinder engines, use as OEM T10193

Camshaft interlock for checking and adjusting the timing on 10-cylinder engines, use as OEM T10194

Clamp for removing and installing the camshaft sprocket of 5-cylinder and 10-cylinder engines, use as OEM T10199

Special insert, makes it possible to turn the crankshaft on 5-cylinder engines, use as OEM T10225

Crankshaft locking spanner for 5-cylinder engines, use as OEM T10226

Tensioning spanner



FITS FOR:

ART.NR	ITEM NAME	PRICE
<b>BT597210</b>	Camshaft locking tool for VAG 5-cylinder and 10-cylinder	<b>169,00 €</b>

**DELIVERY SCOPE**

Suitable for VW T5 from 2004 onwards, Touareg and Phaeton from 2003 onwards with 5-cylinder and 10-cylinder engines

Clamp for removing and installing the camshaft sprocket on 5-cylinder and 10-cylinder engines

Use as OEM T10199, OEM T10199/1



FITS FOR:

ART.NR	ITEM NAME	PRICE
<b>BT596010</b>	Crankshaft fixing tool for VAG 10-cylinder engines	<b>41,00 €</b>

**DELIVERY SCOPE**

Crankshaft fixing tool with dowel pin

Use as OEM T10226

Suitable for e.g. VW Touareg, Phaeton



FITS FOR:

ART.NR	ITEM NAME	PRICE
<b>BT595850</b>	Camshaft control valve inserts for VAG 1.8, 2.0 TFSI, TSI	<b>14,00 €</b>

**DESCRIPTION**

For fitting/removal of the 4/3-way central valve of the camshaft adjustment

Suitable for 1.8, 2.0 L 4-cylinder fuel injection and direct injection engines with timing chain, installed in the following models:

Audi A3, A4, A5, Q5, TT, Seat Altea, Leon, Toledo, Exeo, Skoda Octavia II, Superb II, Yeti, Volkswagen Eos, Golf, Jetta, Passat, Scirocco, Sharan, Tiguan



FITS FOR:

ART.NR	ITEM NAME	PRICE
<b>BT561006</b>	Ignition coil extractor for VAG	<b>23,00 €</b>

**DESCRIPTION**

For pulling off ignition coils on VAG models from year of construction 2013 onwards

Pin-shaped for insertion into the ignition coil fixing hole

Suitable for 4-cylinder 1.2, 1.4, 1.8, 2.0 FSI, TFSI engines, installed in e.g. VW Golf, Audi A3, Seat Leon, Skoda Octavia

Use as OEM T10530



FITS FOR:

ART.NR	ITEM NAME	PRICE
<b>BT606004</b>	Special spanner for exhaust gas temperature sensor for VAG, SW 19 mm	<b>28,00 €</b>

**DESCRIPTION**

For assembling/disassembling exhaust gas temperature sensors

Suitable for e.g. the following VAG engines: 1.8 TFSI, 2.0 TFSI, 2.0 FSI, 1.6 CRTdi, 2.0 common rail

Spanner width 19 mm

Use as OEM T10395/8, T10395/9, T10395/10



FITS FOR:

ART.NR	ITEM NAME	PRICE
<b>BT561005</b>	Ignition coil disassembly tool for VAG	<b>16,00 €</b>

**DESCRIPTION**

For disassembling ignition coils mounted directly on the spark plug

Suitable for e.g. the following models from year of construction 2013 onwards: VW Golf, Audi A3, Seat Leon, Skoda Octavia with FSI engines 1.2, 1.4, 2.0 with timing chain



FITS FOR:

ART.NR	ITEM NAME	PRICE
<b>BT595800</b>	Engine adjustment tool set for Volkswagen 1.2	<b>11,00 €</b>

**DELIVERY SCOPE**

Can also be used as a replacement for Art. BT597800

Use as OEM T10123



ART.NR	ITEM NAME	PRICE
<b>BT597700</b>	Engine adjustment tool set for VAG	<b>45,00 €</b>

**FOR THE FOLLOWING MODELS**

Audi A1 (2010-2012), A2 (2001-2006), A3 (2001-2012), A4/Allroad (1999-2012), A5 (2008-2012), A6/Allroad (1998-2011), TT (2008-2010), Q5 (2008-2012)

Seat Alhambra (1999-2010), Altea/Altea XL (2004-2012), Arosa (1999-2005), Cordoba (2002-2009), Ibiza (2002-2010), Leon (2000-2012), Toledo (2004-2011)

Skoda Fabia (2000-2007), Fabia II (2007-2012), Octavia (2000-2010), Octavia II (2004-2012), Roomster (07-12), Superb (2002-2008), Superb II (2008-2012), Yeti (2009-2012)

VW Amarok (2010-2012), Beetle (2000-2011), Bora (1998-2008), Caddy/Maxi (2003-2012), Eos (06-10), Fox (2005-2011), Golf (1998-2012), Golf Plus (2005-2012), Jetta (2005-2011), Lupo (1999-2005), Passat/CC (1998-2012), Polo (1999-2012), Scirocco (2008-2012), Sharan (1999-2010), Tiguan (2007-2012), Touran (2003-2012), Transporter (2003-2012)

Dodge Caliber (2006-2011)

Ford Galaxy (1999-2006)

Mitsubishi Grandis (2005-2010), Lancer (2005-2010), Outlander (2007-2010)

**DESCRIPTION**

For inspecting and adjusting the camshaft control times 1.2, 2.0 TDI PD, 1.2, 1.6, 2.0 TDI CR



ART.NR	ITEM NAME	PRICE
<b>BT596008</b>	Camshaft sprocket locking tool for Volkswagen 1.8, 2.0 TFSI	<b>67,00 €</b>

**DESCRIPTION**

For locking the intake and discharge camshafts when loosening the central screws



ART.NR	ITEM NAME	PRICE
<b>BT541061</b>	Bit insert, length 54 mm, 12.5 mm square drive (1/2") for VAG Polydrive	<b>4,00 €</b>

**DESCRIPTION**

Special insert for loosening and tightening the fixing screw of the camshaft adjuster for VAG 4-cylinder fuel injection engine (2.0 l direct injection engine)

Special spline profile

Use as OEM: T40080

With knurled grip

Dimensions: M10

**DELIVERY SCOPE**

3 special inserts, 10 mm (3/8") drive

Special insert for camshaft control valves, use as OEM T10352

Special insert for camshaft control valves, use as OEM T10352/1

Special insert for camshaft control valves, use as OEM T10352/2



ART.NR	ITEM NAME	PRICE
<b>BT596020</b>	Crankshaft fixing tool for Volkswagen Touareg, Phaeton from 2003 onwards	<b>79,00 €</b>

**DELIVERY SCOPE**

Suitable for VW Touareg from 2003 onwards, Phaeton from 2003 onwards with 10-cylinder diesel engine

Crankshaft retainer, for locking the crankshaft when adjusting the timing, use as OEM T10195

Guide pin for installing the engine control module (wheel box), use as OEM T10200

Supplementary set for Art. BT597200



ART.NR	ITEM NAME	PRICE
<b>BT591960</b>	Vibration damper tool set for VAG 1.8, 2.0 TFSI	<b>145,00 €</b>

**ENGINE CODES**

Engine codes for 1.8L TFSI: BZB, CDAA, BPU, BYT, CABA, CABB, CDHB, CDHA, CABD, DAJB, CJSB, CJSE, CJEE, CJED, CYGA, CDAC, CJSC, CGYA, DAJA

Engine codes for 2.0L TFSI: CAWB, CCZA, CBFA, CCTA, CDNB, CDNC, CDND, CJXA, CJXE, CJXH, CHHB, CHHA, CULA, CFKA, DEDA, CHJA, CAWA, CCZC, CCZD, CPJA, CJKB, CESA, CETA, CFPA, CNCB, CPLA, CYRB, CYRC; CNCE, CYNB, CYPB, CULB, CULC, CNCB, CWZA, CJKF, CJXC, CAXB, CJXG, CHHC, CCZB

**DESCRIPTION**

Prevents the timing chain sprocket from turning when the vibration damper is being removed or installed

Suitable for Volkswagen, Audi, Skoda and Seat models with 1.8 and 2.0L TFSI engine with chain drive

**DELIVERY SCOPE**

Vibration damper holding tool, use as OEM T10531/1

Crankshaft wheel clamping bolt, use as OEM T10531/2

Nut for crankshaft wheel holding tool, use as OEM T10531/3

Adapter piece for crankshaft wheel holding tool, use as OEM T10531/4



ART.NR	ITEM NAME	PRICE
<b>BT597806</b>	Crankshaft fixing tool for VAG 6-cylinder and 8-cylinder for Art. BT597800	<b>6,00 €</b>

**DELIVERY SCOPE**

Suitable for VW and Audi models with V6 TDI and V8 engines

For adjusting the crankshaft

Use as OEM 3242



FITS FOR:

ART.NR	ITEM NAME	PRICE
<b>BT597000</b>	Engine adjustment tool set for VAG	<b>29,00 €</b>

**FOR THE FOLLOWING MODELS**

Volkswagen: Polo 1.2 L, 6V, 3-cylinder, engine code AWY, BMD, BBM, Polo 1.2 L, 12V, 3-cylinder, engine code AZQ, BME, BZG, CGPA, CGPB

Skoda: Fabia 1.2 L, 6V, 3-cylinder, engine code AWY, BMD, Fabia 1.2 L, 12V, 3-cylinder, engine code AZQ, BME, BZG, CEVA, CGPA, CGPB, Rapid 1.2 L, 12V, 3-cylinder, engine code CGPC, Roomster 1.2 L, 12V, 3-cylinder, engine code BME, BZG, CGPA, Praktik Rapid 1.2 L, 12V, 3-cylinder, engine code BZG, CGPA

Seat: Ibiza 1.2 L, 12V, 3-cylinder, engine code AZQ, BME, BXV, BZG, CGPA, CGPB, Cordoba 1.2 L, 12V, 3-cylinder, engine code AZQ, BME, BXV

**DELIVERY SCOPE**

- Camshaft interlock, use as OEM T10123
- Camshaft interlock, use as OEM T10120
- Crankshaft interlock, use as OEM T10121



FITS FOR:

ART.NR	ITEM NAME	PRICE
<b>BT595900</b>	Engine adjustment tool set for VAG 1.2 TSI, TFSI	<b>21,00 €</b>

**FOR THE FOLLOWING MODELS**

VAG 1.2 TSI, TFSI with engine codes CBZA, CBZB, CBZC

Audi models A1 and A3

VW New Beetle, Caddy, Golf, Jetta, Polo, Touran

Skoda Fabia II, OctaviaII, Praktik, Rapid, Roomster, Yeti

Seat Altea, Ibiza, Leon, Toledo

**DESCRIPTION**

For locking the camshaft and crankshaft while changing the timing chain, replacing the cylinder head seal etc.

**DELIVERY SCOPE**

- Crankshaft lock, use as OEM T10340
- Camshaft interlock, use as OEM T10414
- Guide bolt, use as OEM-T10341



FITS FOR:

ART.NR	ITEM NAME	PRICE
<b>BT597050</b>	Engine adjustment tool set for Audi, VW V6 TDI	<b>10,00 €</b>

**FOR THE FOLLOWING MODELS**

Volkswagen Passat 2.5 V6 TDI

Audi A4 2.5 V6 TDI

Audi A6 2.5 V6 TDI

Audi A8 2.5 V6 TDI

Skoda Superb 2.5 V6 TDI

**ENGINE CODES**

Engine code: AFB, AKN, AKE, AYM, BAU, BCZ, BDG, BDH, BFC

**DESCRIPTION**

For locking the crankshaft/camshaft, and for carrying out work on the engine control, e.g. replacing the toothed belt, removing the cylinder heads etc.

**DELIVERY SCOPE**

- Crankshaft fixing mandrel, use as OEM 3242
- Camshaft interlock plates, use as OEM 3458



FITS FOR:

ART.NR	ITEM NAME	PRICE
<b>BT591010</b>	Camshaft fixing tool for Audi, VW	<b>39,00 €</b>

**DESCRIPTION**

Needed for changing the toothed belt in Audi and VW models with the following engines: AUDI A4 2.4 2.8 year of construction 1997, 2002, A6 2.4 year of construction 1997, 2002, A6 2.8 year of construction 1997, 2002, A8 2.8 year of construction 1997, 2002, S4 2.7 Turbo year of construction 1997, 2001 or Volkswagen with ACK, ALG, APR, AGD engines, and Passat 2.4 year of construction 1996, 2002, Passat 2.8 30v year of construction 1996, 2001

The camshaft cannot turn while the toothed belt is being fitted

Easy, accurate fitting of the toothed belt



FITS FOR:

ART.NR	ITEM NAME	PRICE
<b>BT596007</b>	Camshaft fixing tool for VAG, adjustable, 12V, 30V	<b>75,00 €</b>

**DESCRIPTION**

Large range of use thanks to adjustable camshaft fixing tool, use as OEM 3391 or OEM 3243

Crankshaft locking bolt, use as OEM 3242

Needed for changing the toothed belt in Audi and VW models with the following engines:

AUDI A4 2.4 2.8 year of construction 1997, 2002, A6 2.4 year of construction 1997, 2002, A6 2.8 year of construction 1997, 2002, A8 2.8 year of construction 1997, 2002, S4 2.7 Turbo year of construction 1997, 2001, Volkswagen with ACK, ALG, APR, AGD engines, Passat 2.4 year of construction 1996, 2002, Passat 2.8 30v year of construction 1996, 2001, 2-valve V6 engines e.g. Audi 80, 90, A4, A6 year of construction 1994, 1997 ABC, AFC engine

The camshaft cannot turn while the toothed belt is being fitted

Easy, accurate fitting of the toothed belt



FITS FOR:

ART.NR	ITEM NAME	PRICE
<b>BT591011</b>	Camshaft fixing tool for Audi, VW	<b>39,00 €</b>

**DESCRIPTION**

Needed for changing the toothed belt in Audi and VW models with 2-valve V6 engines, e.g. Audi 80, 90, A4, A6 1994-97 ABC, AFC engine

The camshaft cannot turn while the toothed belt is being fitted

The fixing hook ensures a secure fit

Easy, accurate fitting of the toothed belt





ART.NR	ITEM NAME	PRICE
BT591012	Camshaft fixing tool for Audi, Volkswagen	39,00 €

**DELIVERY SCOPE**

Needed for changing the toothed belt in Audi and VW with V8 3.3L to 4.2L 5-valve engines, installed in the Audi A6, A8 with e.g. engine code AKB, AUX, AYS, AQJ, ARS, ART, AWN, BBD, BCY and BFM (1998, 2003), as well as the VW Touareg and Phaeton

The camshaft cannot turn while the toothed belt is being fitted

Easy, accurate fitting of the toothed belt

Use as OEM T40005



ART.NR	ITEM NAME	PRICE
BT595850	Camshaft control valve inserts for VAG 1.8, 2.0 TFSI, TSI	14,00 €

**DESCRIPTION**

For fitting/removal of the 4/3-way central valve of the camshaft adjustment

Suitable for 1.8, 2.0 L 4-cylinder fuel injection and direct injection engines with timing chain, installed in the following models:

Audi A3, A4, A5, Q5, TT, Seat Altea, Leon, Toledo, Exeo, Skoda Octavia II, Superb II, Yeti, Volkswagen Eos, Golf, Jetta, Passat, Scirocco, Sharan, Tiguan



ART.NR	ITEM NAME	PRICE
BT591085	Special insert for turning the crankshaft for VAG 5-cylinder engines	13,00 €

**FOR THE FOLLOWING MODELS**

VW Lupo, Polo, New Beetle, Golf, Bora Caddy  
Seat Ibiza, Cordoba

**DELIVERY SCOPE**

Needed for adjusting the crankshaft when working on the engine timing, and can also be used as a counter support

Suitable for all 5-cylinder VW diesel engines

Installed e.g. in the Touareg from year of construction 2003 onwards and Transporter from 2004 onwards

With fixing screw for fitting on the crankshaft

Can be used as VAG OEM T10225



ART.NR	ITEM NAME	PRICE
BT591013	Camshaft rule for Volkswagen, Audi, 170 mm	9,00 €

**FOR THE FOLLOWING MODELS**

for VW and Audi

**ENGINE CODES**

Engine codes: AAA, ABV, AES, AGZ, AMY, AZX



ART.NR	ITEM NAME	PRICE
BT597215	Camshaft fixing tool for VAG 5- and 10-cylinder engines	29,00 €

**DELIVERY SCOPE**

Suitable for VW Phaeton from 2003 onwards, Touareg from 2003 onwards, Transporter from 2004 onwards with 5-cylinder and 10-cylinder diesel engine

Use as OEM T10193 or T10194

For fixing the camshafts when checking and adjusting the timing

The camshaft cannot turn, meaning that precise adjustment is possible



ART.NR	ITEM NAME	PRICE
BT596006	Camshaft sprocket locking tool for VAG 1.0	4,00 €

**FOR THE FOLLOWING MODELS**

Seat Mii 1.0 (3-cylinder)  
Skoda Citigo 1.0 (3-cylinder)  
Volkswagen Up 1.0 (3-cylinder)

**DESCRIPTION**

For locking the camshafts in the adjustment position

Needed when checking and adjusting the engine timing

Use as OEM T10476



ART.NR	ITEM NAME	PRICE
BT591019	Camshaft assembly tool for VAG 6 and 8-cylinder TDI	119,00 €

**DESCRIPTION**

For installing the camshaft in the cylinder head

Suitable for the following VAG models: VW Tiguan 2008, Passat CC 2009, Touareg 2003, Phaeton 2003, Audi A3 2004, A4 2001, A4 2008, A5 2008, Q5 2008, A6 2005, Q7 2007, A8 2003

6-cylinder TDI common rail 2.7, 3.0 4-valve engines

8-cylinder TDI common rail 4.0 4-valve engines

Use as VAG OEM T40095



FITS FOR:

ART.NR	ITEM NAME	PRICE
BT546004	Crankshaft sealing ring assembly tool for VAG 1.4 and 1.6 16V	130,00 €

**FOR THE FOLLOWING MODELS**

Seat Arosa, Ibiza, Cordoba, Leon, Toledo, Inca  
Skoda Fabia, Octavia, Roomster  
VW Lupo, Polo, Golf, Bora, Beetle, Caddy

**ENGINE CODES**

Engine codes: CHYA, CHYB, CPGA

**DESCRIPTION**

For fitting the radial sealing ring on the transmission  
Attempting to fit the sealing ring without this tool may lead to leaks, destruction of the new sealing ring, and poor engine running  
Suitable for VAG vehicles with 1.4 and 1.6 16V engines  
Use as OEM T10017



FITS FOR:

ART.NR	ITEM NAME	PRICE
BT596015	Timing chain tension lever for VAG 1.8, 2.0 TFSi	32,00 €

**FOR THE FOLLOWING MODELS**

Audi A3, A3 Cabrio, TT, Q3  
Seat Alhambra, Altea Free Track, Exeo, Leon FR, Toledo  
Skoda Octavia II, Superb III (3T), Yeti  
Volkswagen Eos, Golf VII, Passat (B6), Passat CC, Passat Variant, Sharan, Beetle, Scirocco, Tiguan

**ENGINE CODES**

Engine codes: (1.8 L engines): CDAA, CDHA, CDHB, CJEB, CDAB, CGYA

Engine codes (2.0 L engines): CCZA, CDNB, CDNC, CFKA, CCZC, CPSA, CESA, CETA, CCZB, CDND, CCZD

**DESCRIPTION**

For pushing back the timing chain tensioner without removing the front engine cover  
Needed when replacing the timing chain



FITS FOR:

ART.NR	ITEM NAME	PRICE
BT591260	Camshaft sprocket locking tool set, universal	72,50 €

**FOR THE FOLLOWING MODELS**

Can be used universally on vehicles from the following manufacturers: Audi, Alfa Romeo, Chrysler, Citroen, Ford, Honda, Hyundai, Isuzu, Land Rover, Lexus, Mazda, Mitsubishi, Peugeot, Renault, MG, Seat, Skoda, Subaru, Toyota, Opel, Volkswagen, Volvo

**DESCRIPTION**

For locking the camshaft sprockets e.g. when replacing the toothed belt  
Suitable for engines with 1, 2 and 4 camshafts (V engines); also suitable for locking between the camshaft sprocket and diesel injection pump wheel in some diesel engines

**DELIVERY SCOPE**

Double camshaft locking tool with short and long connecting arm  
Single camshaft locking tool with short and long locking screw



FITS FOR: **Universal**

ART.NR	ITEM NAME	PRICE
BT596002	Universal camshaft wheel puller	63,00 €

**DESCRIPTION**

For pulling the pulley and camshaft gear  
Gripping arms are connected with each other via adjusting disk, thus the gripping arms can be set easily and exactly  
Continuous adjustment range of the gripping arms from 42 – 82 mm  
Gripping arm depth is 27 mm

**DELIVERY SCOPE**

3 x gripping arms, Ø 12 mm, M10 x 1.5, suitable for material thickness up to max. 10 mm  
6-groove puller body with adjusting disc  
Spindle, M14 x 1.5, 19 mm hex, with centring cone

**BT546001  
EAN4042146779217  
Torque angle gauge**

**10,- €**

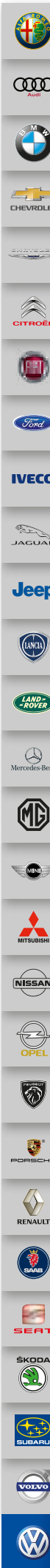
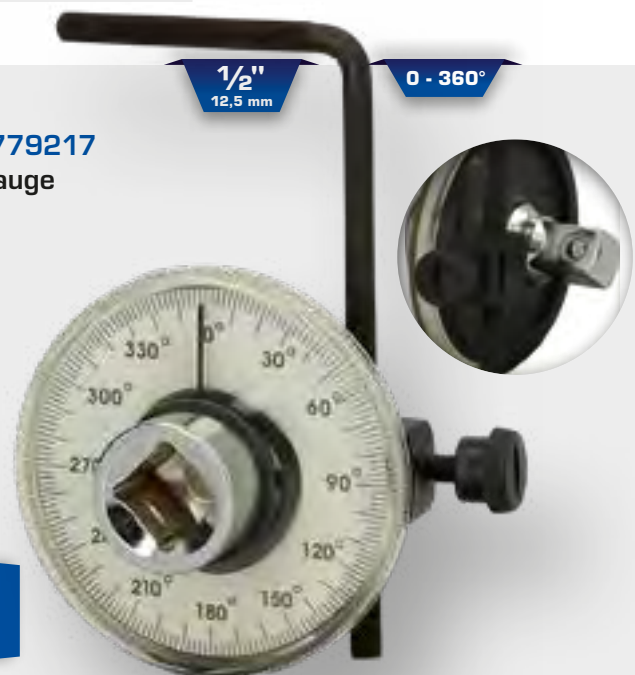



ART.NR	ITEM NAME	PRICE
<b>BT595910</b>	Timing chain test tool set for VAG 1.2, 1.4 TFSi	<b>149,00 €</b>

**FOR THE FOLLOWING MODELS**

Audi: A1 (2012-2015), A1 Sportback (2012-2015), A3 (2013-2015), A3 (2013-2015), A3 Sportback (2012-2015)

Seat: Ibiza (2012-2017), Leon (2012-2015), Toledo (2012-2017)

Skoda: Fabia II (2010-2015), Fabia III (2014-2017), Octavia II (2010-2013), Octavia III (2010-2015), Praktik (2010-2015), Roomster (2010-2015), Rapid (2015-2017)

Volkswagen: Golf VI & VII (2008-2015), Golf VII Kombi (2008-2017), Jetta (2012-2017), Polo (2012-2017), Sportsvan (2014-2017)

**DESCRIPTION**

For checking the timing chain elongation on VAG 1.2 and 1.4L TFSi engines

Prevents costly repairs at a later stage due to the timing chain slipping

**DELIVERY SCOPE**

Timing chain test tool set, use as OEM T10550

Comprises the following tools: Camshaft fixing tool, use as OEM T10550/1; indicator, use as OEM T10550/2; scale sleeve with crankshaft pulley plate, use as OEM T10550/3



**WORK  
BRILLIANT**

[WWW.BRILLIANT-TOOLS.COM](http://WWW.BRILLIANT-TOOLS.COM)



ART.NR	ITEM NAME	PRICE
<b>BT595920</b>	Camshaft assembly tool set for VAG and Porsche	<b>549,00 €</b>

**FOR THE FOLLOWING MODELS**

Suitable for the following diesel vehicles (TDI CR) from 2003 onwards: Audi, Porsche, Seat, Skoda, Volkswagen with 1.2, 1.6, 2.0, 2.7, 3.0, 4.0, 4.2 common rail engines

**ENGINE CODES**

Engine codes ASB, ASE, BKN, BKS, BMK, BNG, BPP, BSG, BTR, BUG, BUN, BVN, CAAA, CAAB, CAAC, CAAD, CAAE, CAGA, CAGB, CAGC, CAHA, CAHB, CAMA, CAMB, CANA, CANB, CANC, CAND, CAPA, CARA, CASA, CASB, CASC, CASD, CATA, CAYA, CAYB, CAYC, CAYD, CAYE, CBAA, CBAB, CBAC, CBBA, CBBB, CBDA, CBDB, CBDC, CCFA, CCFC, CCHA, CCHB, CCLA, CCMA, CCWA, CCWB, CDBA, CDCA, CDSB, CDTA, CDTB, CDUC, CDUD, CDYA, CDYB, CDYC, CEGA, CEXA, CFCA, CFFA, CFFB, CFFD, CFFE, CFGB, CFGC, CFGD, CFHA, CFHB, CFHC, CFHD, CFHE, CFHF, CFJA, CFWA, CGKA, CGKB, CGLA, CGLB, CGLC, CGLD, CGLE, CGGB, CJAA, CJCA, CJCB, CJCC, CJCD, CJGA, CJGC, CJGD, CJMA, CKDA, CKTB, CKTC, CKUB, CKUC, CKVB, CKVC, CLAA, CLAB, CLCA, CLCB, CLJA, CLLA, CLNA, CLZB, CMEA, CMFA, CMFB, CMGB, CMHA, CNEA, CNFA, CNRB, CRCA, CSHA, M05/9D (CAS), M05/9E, M05/9E (CRCA), M05/9E (CRCB)

**DESCRIPTION**

For installing the camshafts in the correct position  
Needed when installing new or existing camshafts; attempting installation without this tool may lead to damage on the camshaft bearing bridge and the cylinder head

**DELIVERY SCOPE**

Mounting device including pre-assembled parts, use as OEM T40094

Camshaft clamp, use as OEM T40095

2 alignment clamps, use as OEM T40096, T40096/1

4 camshaft brackets for mounting device, use as OEM T40094/1, T40094/2, T40094/9, T40094/10

Interlock for camshaft bracket, use as OEM T40094/11

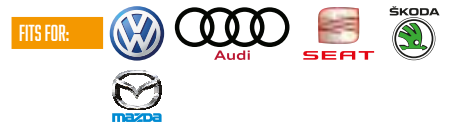
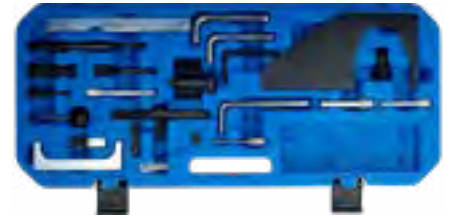

ART.NR	ITEM NAME	PRICE
<b>BT593100</b>	Engine adjustment tool set for Ford	<b>109,00 €</b>

**FOR THE FOLLOWING MODELS**

Suitable for the following Ford engines: 1.4, 1.6 16V, 1.7, 1.8 16V, 2.0 16V (including Zetec), 1.4, 1.6, 1.8, 1.9 D/TD/TDCi

**DESCRIPTION**

Contains tools for: Locking the flywheel

Locking the crankshaft, pump shaft

Locking the injection pump shaft

Removing the crankshaft pulley

Tensioning the toothed belt

Adjustment gauge for positioning the camshaft and pump shaft in relation to the crankshaft

Use as OEM 21-162, 21-162B, 303-367, 303-376, 23-059, 310-085, 21-168, 303-393, 23-020, 23-047, 23-020, 21-163, 303-620, 23-019, 21-210, 303-507, 21-251, 303-698, 21-262, 303-734, 23-029, 303-1061, 23-058, 310-084, 21-105, 21-262, 303-734, 21-168, 303-393, 21-263, 303-735, Mazda 49JE01061, Audi 3359, T10008, T10050, 2065A, Seat 3359, T10008, T10050, 2065A, Skoda 3359, T10008, T10050, 2065A, Volkswagen 3359, T10008, T10050, 2065A



ART.NR	ITEM NAME	PRICE
<b>BT597218</b>	Counter-support spanner for crankshaft pulleys for Volkswagen, Seat 1.6 l	<b>42,00 €</b>

**ENGINE CODES**

Engine code: ARC, AVY

**DESCRIPTION**

Counter-support spanner for crankshaft pulleys for Volkswagen, Seat 1.6 l





**FITS FOR:**

ART.NR	ITEM NAME	PRICE
<b>BT591030</b>	Engine adjustment tool set for VAG	<b>59,00 €</b>

**FOR THE FOLLOWING MODELS**

Audi A3 1.8 Turbo (AGN AGU AJQ APG APP AQA ARX ARY ARZ AUM AUG) 1996-2003, A3 1.6 FSI (BAG) 2003-2006, S3 1.8 Turbo (AMK APY BAM) 1996, A4 1.8 Turbo (ADR AEB AJL AJP ANB APU AVJ AWT) 1994-2006, A6 1.8 Turbo (ADR AEB AJL AJP ANB APU AVJ AWT) 1994-2006, Cabriolet 1.8 (ADR) 1997-2000, TT 1.8 Turbo (AJQ APP APX AUM AUG BAM) 1998-2006

Volkswagen Beetle 1.8 Turbo (AVC) 1999-2006, Touran 1.6 FSI (BAG BLP) 2003-2007, Golf 1.8 Turbo (AGN AGU AQA ARZ AUM AUG) 1997-2005, Bora 1.8 Turbo (AGN AGU AQA ARZ AUM AUG) 1997-2005, Passat 1.8 Turbo (ADR AEB ANB APT APU ARG AWT) 1996-2005, Sharan 1.8 Turbo (AJH AVWC) 1997-2007

Seat Ibiza 1.8 Turbo (AQX AYP) 1999-2002, Cordoba 1.8 Turbo (AQX AYP) 1999-2002, Leon 1.8 Turbo (AJQ AGN APG APP APT ARYAUQ) 1999-2005, Toledo Turbo (AGN APG APT ARY AUG) 1999-2005, Alhambra 1.8 Turbo (AJW AWC) 1997-2007

Skoda Octavia 1.8 FSI Turbo (AGN AGU ARX ARZ AUM) 1996-2005, Octavia 1.8 Turbo 20V RS (AUG) 2000-2006, Octavia 1.6 FSI (BLF) 2004-2007

**ENGINE CODES**

Suitable for 1.8 L turbo and 1.6 L FSI engines

**DELIVERY SCOPE**

Counter support for crankshaft, use as OEM 3036  
Camshaft fixing tool, use as OEM T10171  
Counter support for drive sprockets of oil pump gear, camshaft, vibration damper, use as OEM T10172  
Adapter pieces for counter support, use as OEM T10172  
Chain tensioner bracket for installation and removal of the chain tensioner, use as OEM T20018, 3366  
Tension roller element fixing pin, use as OEM T40011



ART.NR	ITEM NAME	PRICE
<b>BT591089</b>	Drive gear fixing tool for VAG 3.6 FSI	<b>6,00 €</b>

**DESCRIPTION**

For fixing the high-pressure pump driving toothed wheel  
Needed for adjusting the valve timing  
Suitable for VAG 3.6L 6-cylinder 4-valve engines, installed in the Volkswagen Passat (357), (3C2), (3C5) from 2006 onwards, Touareg (7L6), (7LA) from 2006 onwards, Audi Q7 (4LB) from 2007 onwards  
Engine codes: BLV, BHL, BHK  
Use as OEM T10363



**FITS FOR:**

ART.NR	ITEM NAME	PRICE
<b>BT591088</b>	Drive gear fixing tool for VAG 3.6 FSI	<b>10,00 €</b>

**DESCRIPTION**

For fixing the high-pressure pump driving toothed wheel  
Needed for adjusting the valve timing  
Suitable for VAG 3.6L 6-cylinder 4-valve engines, installed in the Volkswagen Passat (357), (3C2), (3C5) from 2006 onwards, Touareg (7L6), (7LA) from 2006 onwards, Audi Q7 (4LB) from 2007 onwards  
Engine codes: BLV, BHL, BHK  
Use as OEM T10332



**FITS FOR:**

ART.NR	ITEM NAME	PRICE
<b>BT542078</b>	Crankshaft seal assembly device for VAG gasoline & diesel engines	<b>149,00 €</b>

**DESCRIPTION**

For fitting the radial sealing ring on the transmission  
Attempting to fit the sealing ring without this tool may lead to leaks, destruction of the new sealing ring, and poor engine running  
Suitable for VAG vehicles Volkswagen Golf, Touran and Audi A3, A4 1.4i Turbo, 1.4 & 1.6 petrol direct injection, 1.9, 2.0 SDI, 2.0 common rail diesel engines  
Use as OEM T10134



**FITS FOR:**

ART.NR	ITEM NAME	PRICE
<b>BT591018</b>	Front mask propping aid for Audi A4	<b>17,00 €</b>

**DESCRIPTION**

For pushing the front mask into the service position, e.g. for Audi A4, Passat from 1997 onwards  
Allows for timing belt changes or the renewal of the water pump  
Use as T10093



**FITS FOR:**

ART.NR	ITEM NAME	PRICE
<b>BT542070</b>	Handle/Camshaft radial seal extraction set for VAG	<b>189,00 €</b>

**DESCRIPTION**

For removing radial sealing rings  
Grips the seal from the inside with its conical profile  
Suitable for most commercially available sealing rings  
Suitable for most VAG petrol engines e.g. VW Lupo and Polo 1.4i, VR6, Audi V6, etc.  
Contains the following extractors: 5 short extractors, Ø 25, 32, 35, 27, 55 mm  
1 long extractor, Ø 32 mm



**FITS FOR:**

ART.NR	ITEM NAME	PRICE
<b>BT597450</b>	Engine adjustment tool set for VAG	<b>40,00 €</b>

**FOR THE FOLLOWING MODELS**

VW Passat, Sharan  
AUDI A4, A6, A8, Allroad (1997-2006), A8  
SKODA Superb 2.5 (2002-2006)

**ENGINE CODES**

AFB, AKN, AKE, AYM, BAU, BCZ, BDG, BDH, BFC

**DESCRIPTION**

For inspecting and adjusting the camshaft control times

**DELIVERY SCOPE**

Interlock plate with chain, use as OEM 3458  
Special spanner, spanner width 22 mm, 1/2" drive, use as OEM 3078  
Propping aid for front masks, use as OEM 3369  
Crankshaft locking pin, use as OEM 3242  
Marking pin of injection pump wheel, use as OEM 3359

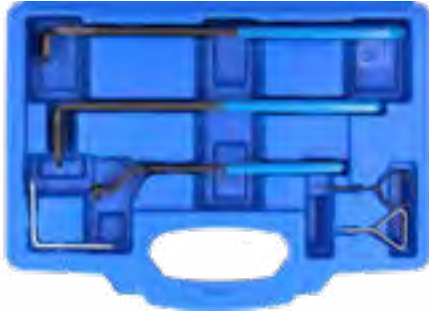

ART.NR	ITEM NAME	PRICE
<b>BT597600</b>	Toothed belt tensioner set for VAG	<b>39,00 €</b>

DELIVERY SCOPE
Range for actuating and locking toothed belt tension rollers
Needed when replacing the toothed belt and carrying out repairs on the engine
For the most common VW, Audi, Seat, Skoda petrol and diesel engines
Spanner can be used as counter support
Tightening the nut does not affect the adjustment of the toothed belt tension
3 tension roller spanners with different lengths and crank portions, use as OEM T10020, V159, 3387
3 locking pins for toothed belt tensioner: 1.6 mm, use as OEM T40011, 2.5 mm, use as OEM T03006, 4 mm, use as OEM T10060A



ART.NR	ITEM NAME	PRICE
<b>BT671050</b>	Drive shaft retractor set	<b>89,00 €</b>

FOR THE FOLLOWING MODELS
M16 x 1.5 mm: for Subaru
M20 x 1.5 mm: for VW Beetle, Touareg, Porsche Cayenne
M22 x 1.5 mm: for BMW E30, E46
M24 x 1.5 mm: for BMW E36, Mercedes W203
M27 x 1.5 mm: for BMW E32, E34, E38, E39, X5
M30 x 1.5 mm: for BMW E32, E34, E36

DESCRIPTION
For pulling the drive shaft into the wheel hub
In a standardised industrial bearing
Contains 6 pulling sleeves with various threads

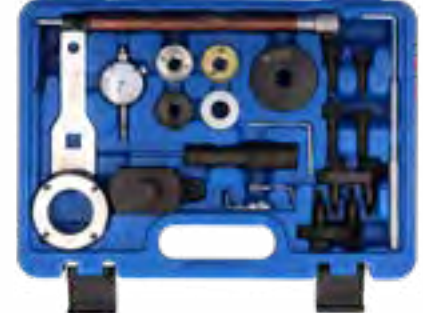

ART.NR	ITEM NAME	PRICE
<b>BT597760</b>	Engine adjustment tool set for VAG 1.8, 2.0 FSI, TFSI	<b>190,00 €</b>

DESCRIPTION
For checking and adjusting the engine timing
Suitable for 1.8, 2.0L VAG engines with engine code BYT, BZB, CABA, CABB, CABD, CADA, CAEA, CAEB, CAWA, CAWB, CBFA, CCTA, CCZA, CCZB, CCZC, CCZD, CDAA, CDAB, CDHA, CDHB, CDNB, CDNC, CDND, CESA, CETA, CFKA, CFPA, CGYA, CHHA, CHHB, CJBA, CJEB, CJK, CJKB, CJS, CJSB, CNCD, CPLA, CPSA
Installed e.g. in Audi A4, A5 (from 2008 onwards), A6 (from 2012 onwards)

DELIVERY SCOPE
Crankshaft counter support tool, use as OEM T10355
Crankshaft thrust piece, use as OEM T10368
Crankshaft thrust piece, use as OEM T10354
Camshaft interlock bolt (4x), use as OEM T40196
Chain adjuster interlocking clamp (2x), use as OEM T40267
Drive sprocket blocking tool (2x), use as OEM T40271, T20208
Camshaft valve tool, use as OEM T10352
Camshaft valve tool, use as OEM T10352/1
Camshaft valve tool, use as OEM T10352/2
Tensioning marking pin, use as OEM T10060A
Tensioning marking pin (2x), use as OEM T40011
Marking pin for oil pump, use as OEM T40265



ART.NR	ITEM NAME	PRICE
<b>BT521300</b>	Water pump removal tool for Volkswagen	<b>59,00 €</b>

DESCRIPTION
Suitable for Volkswagen T5, Touareg 2.5D

DELIVERY SCOPE
Water pump extractor, for removing the water pump gear, use as OEM T10222A
Drive wheel extractor, for removing the water pump, use as OEM T10221A
Special spanner, for bracing or turning the crankshaft when loosening the gear fastening screw on the water pump, use as OEM T10225



ART.NR	ITEM NAME	PRICE
<b>BT591094</b>	Crankshaft locking tool for VAG 1.4, 1.6, 2.0 TDI (EA288)	<b>31,00 €</b>

FOR THE FOLLOWING MODELS
For the following vehicles: 1.4 TDI Audi A1, 1.4 TDI Seat Ibiza, Toledo IV, 1.4 TDI Skoda Fabia III, Rapid (2012), 1.4 TDI VW Polo V, 1.6 TDI Audi A1, A3 8V, A4 B9, Q2, 1.6 TDI Seat Leon III, Toledo IV, Ateca, 1.6 TDI Skoda, Octavia III, Rapid (2012), Superb III, Karoq, 1.6 TDI VW Beetle, Golf VII, Jetta VI, Tiguan, Touran II, T-Roc, Passat B8, CC, Scirocco III, 2.0 TDI Audi A3 8V, A4 B9, Q2, 2.0 TDI Seat Leon III, Ateca, Alhambra II, 2.0 TDI Skoda Octavia III, Superb III, Kodiak, Karoq, 2.0 TDI VW Beetle, Golf VII, Jetta VI, Tiguan, Tiguan II, Touran II, T-Roc, Sharan II, Passat B8, CC, Scirocco III, Arteon, T6, Caddy, Crafter, Amarok

DESCRIPTION
For adjusting and locking the crankshaft e.g. when working on the camshaft drive or replacing the cylinder head seal
Suitable for: TDI common rail engines in the EA288 series
Use as OEM T10490

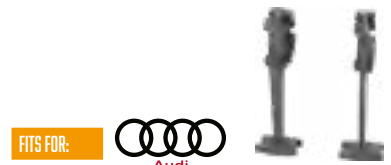

ART.NR	ITEM NAME	PRICE
<b>BT591110</b>	Camshaft adjustment tool for Audi V8 4.2	<b>47,00 €</b>

DESCRIPTION
For adjusting the camshafts
Use as OEM T40047
Enables correct adjustment of the Hall sensor covers; incorrect adjustment can lead to rough idling and slow responses
Suitable for vehicles with 4.2L V8 engines AUDI A6 (2005, 2006), A8 (2004, 2006), Quattro (2003, 2005), S4 (2004, 2009), VW Phaeton (2004, 2006) with engine code BNK, BFM, BGK, BAS, BHF, BGH

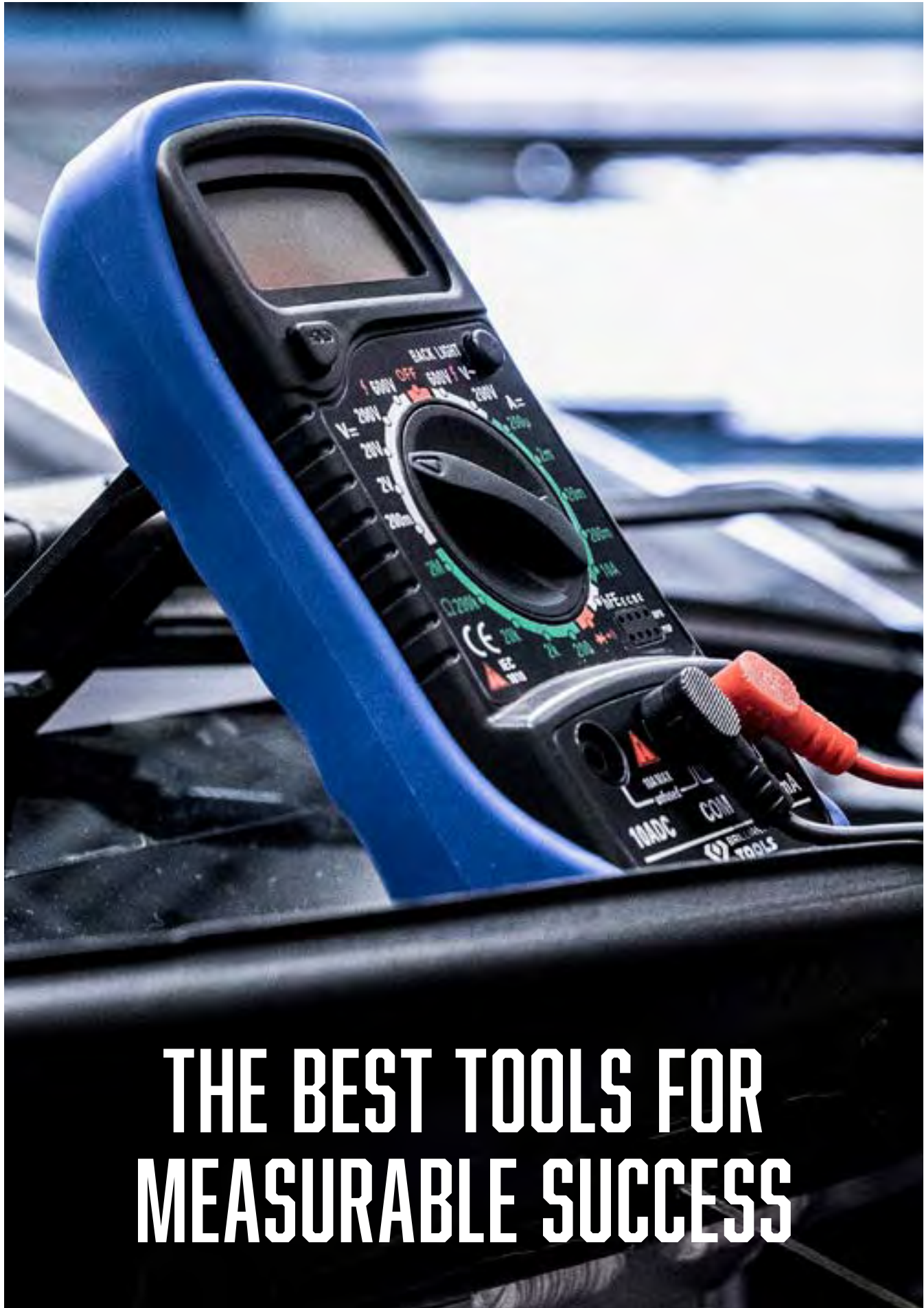

# THE BEST TOOLS FOR MEASURABLE SUCCESS



# CONTENT BY PRODUCT NAME FOR HAND TOOLS AND AUTOMOTIVE SPECIAL TOOLS

Art. Nr.	Page	Art. Nr.	Page	Art. Nr.	Page	Art. Nr.	Page	Art. Nr.	Page	Art. Nr.	Page
BT010012	12	BT012911	15	BT014804	13	BT020902	26	BT020983	28	BT021839	36
BT010900	12	BT013105	18	BT014806	13	BT020903	31	BT020984	28	BT021840	36
BT010901	12	BT013112	18	BT014808	13	BT020904	31	BT020985	28	BT021841	36
BT010902	12	BT013121	19	BT014810	13	BT020905	31	BT020986	28	BT021850	35
BT010903	12	BT013205	20	BT014812	13	BT020906	30	BT020990	29	BT021851	35
BT010904	12	BT013212	20	BT014815	13	BT020907	30	BT020991	29	BT021852	35
BT010905	12	BT013221	21	BT015006	22	BT020908	30	BT020992	29	BT021860	36
BT010907	12	BT013706	19	BT015007	22	BT020909	30	BT020993	29	BT021861	36
BT010908	12	BT013707	19	BT015008	22	BT020910	26	BT020995	32	BT021862	36
BT010909	12	BT013708	19	BT015009	22	BT020911	30	BT020996	33	BT021870	37
BT010910	12	BT013709	19	BT015010	22	BT020912	30	BT020997	33	BT021871	37
BT010912	12	BT013710	19	BT015011	22	BT020930	27	BT020999	32	BT021872	37
BT010913	12	BT013711	19	BT015012	22	BT020931	27	BT021061	34	BT021873	37
BT010914	12	BT013712	19	BT015013	22	BT020932	27	BT021800	35	BT021874	37
BT011015	13	BT013713	19	BT015014	22	BT020933	27	BT021801	35	BT021875	37
BT011021	14	BT013714	19	BT015015	22	BT020934	27	BT021802	35	BT021876	37
BT011021	428	BT013715	19	BT015016	22	BT020935	27	BT021803	35	BT021880	36
BT011906	14	BT013716	19	BT015017	22	BT020936	27	BT021804	35	BT021881	36
BT011907	14	BT013717	19	BT015018	22	BT020937	27	BT021805	35	BT021882	36
BT011908	14	BT013718	19	BT015019	22	BT020938	27	BT021806	35	BT021890	36
BT011909	14	BT013719	19	BT015020	22	BT020939	27	BT021807	35	BT021891	36
BT011910	14	BT013720	19	BT015021	22	BT020940	27	BT021808	35	BT021892	36
BT011911	14	BT013721	19	BT015022	22	BT020941	27	BT021809	35	BT021899	70
BT011912	14	BT013722	19	BT015023	22	BT020942	27	BT021810	35	BT021900	38
BT011913	14	BT013724	19	BT015024	22	BT020950	27	BT021811	35	BT021901	39
BT011914	14	BT013727	19	BT015100	22	BT020951	27	BT021812	35	BT021902	39
BT011915	14	BT013730	19	BT016001	17	BT020952	27	BT021813	35	BT021903	39
BT011916	14	BT013732	19	BT020009	31	BT020953	27	BT021814	35	BT021904	39
BT011917	14	BT013806	21	BT020009	40	BT020954	27	BT021815	35	BT021905	39
BT011918	14	BT013807	21	BT020009	60	BT020955	27	BT021816	35	BT021907	40
BT011919	14	BT013808	21	BT020023	24	BT020956	27	BT021817	35	BT021908	40
BT011920	14	BT013809	21	BT020023	335	BT020957	27	BT021820	35	BT021909	40
BT011921	14	BT013810	21	BT020046	25	BT020958	27	BT021821	35	BT021910	40
BT011922	14	BT013811	21	BT020800	29	BT020959	27	BT021822	35	BT021911	40
BT011924	14	BT013812	21	BT020801	29	BT020960	27	BT021823	35	BT021912	40
BT011927	14	BT013813	21	BT020802	29	BT020961	27	BT021824	35	BT021930	37
BT011930	14	BT013814	21	BT020803	29	BT020962	27	BT021825	35	BT021931	37
BT011932	14	BT013815	21	BT020810	29	BT020963	27	BT021826	35	BT021932	37
BT012012	15	BT013816	21	BT020811	29	BT020964	27	BT021827	35	BT021940	37
BT012900	15	BT013817	21	BT020812	29	BT020965	27	BT021828	35	BT021941	37
BT012901	15	BT013818	21	BT020813	29	BT020970	28	BT021829	35	BT021942	37
BT012902	15	BT013819	21	BT020820	28	BT020971	28	BT021830	36	BT021943	37
BT012903	15	BT013820	21	BT020821	28	BT020972	28	BT021831	36	BT021944	37
BT012904	15	BT013821	21	BT020822	28	BT020973	28	BT021832	36	BT021945	37
BT012905	15	BT013822	21	BT020823	28	BT020974	28	BT021833	36	BT021946	37
BT012906	15	BT013824	21	BT020824	28	BT020975	28	BT021834	36	BT021947	37
BT012907	15	BT013827	21	BT020825	28	BT020976	28	BT021835	36	BT021948	37
BT012908	15	BT013830	21	BT020899	70	BT020980	28	BT021836	36	BT021949	37
BT012909	15	BT013832	21	BT020900	32	BT020981	28	BT021837	36	BT021995	38
BT012910	15	BT013901	17	BT020901	26	BT020982	28	BT021838	36	BT021996	38

Art. Nr.	Page	Art. Nr.	Page	Art. Nr.	Page	Art. Nr.	Page	Art. Nr.	Page	Art. Nr.	Page
BT021997	39	BT022618	75	BT022703	52	BT022809	48	BT022876	50	BT022955	51
BT022003	70	BT022619	75	BT022704	52	BT022810	48	BT022877	50	BT022956	51
BT022012	49	BT022620	77	BT022705	52	BT022811	48	BT022880	50	BT022960	51
BT022025	42	BT022621	76	BT022710	52	BT022812	48	BT022881	50	BT022961	51
BT022026	55	BT022622	76	BT022711	52	BT022813	48	BT022882	50	BT022962	51
BT022030	54	BT022623	76	BT022712	52	BT022814	48	BT022883	50	BT022963	51
BT022032	54	BT022624	76	BT022713	52	BT022815	48	BT022884	50	BT022970	52
BT022032	440	BT022625	78	BT022714	52	BT022816	48	BT022885	50	BT022971	52
BT022401	57	BT022626	76	BT022715	52	BT022817	48	BT022886	50	BT022972	52
BT022401-1	57	BT022627	76	BT022720	53	BT022818	48	BT022890	50	BT022973	52
BT022405	41	BT022628	76	BT022721	53	BT022820	48	BT022891	50	BT022974	52
BT022408	41	BT022629	76	BT022722	53	BT022821	48	BT022892	50	BT022975	52
BT022409	41	BT022631	77	BT022723	53	BT022822	48	BT022893	50	BT022976	52
BT022410	41	BT022632	77	BT022724	53	BT022823	48	BT022894	50	BT022977	52
BT022411	41	BT022633	77	BT022725	53	BT022824	48	BT022895	50	BT022978	52
BT022412	41	BT022634	77	BT022726	53	BT022825	48	BT022899	70	BT022979	52
BT022413	41	BT022636	77	BT022727	53	BT022826	48	BT022900	56	BT022980	52
BT022414	41	BT022637	77	BT022728	53	BT022827	48	BT022901	58	BT022981	52
BT022415	41	BT022638	77	BT022730	53	BT022828	48	BT022902	59	BT022982	52
BT022416	41	BT022639	77	BT022731	53	BT022829	48	BT022903	59	BT022983	52
BT022417	41	BT022641	77	BT022732	53	BT022830	48	BT022904	59	BT022984	52
BT022418	41	BT022642	77	BT022733	53	BT022840	48	BT022905	59	BT022985	52
BT022419	41	BT022643	77	BT022734	53	BT022841	48	BT022906	59	BT022986	52
BT022420	41	BT022644	77	BT022735	53	BT022842	48	BT022907	59	BT022987	52
BT022421	41	BT022645	81	BT022736	53	BT022843	48	BT022908	60	BT022988	52
BT022422	41	BT022646	77	BT022737	53	BT022844	48	BT022909	60	BT022989	52
BT022424	41	BT022647	77	BT022738	53	BT022845	48	BT022910	60	BT022992	57
BT022427	41	BT022648	77	BT022740	53	BT022846	48	BT022911	60	BT022992	362
BT022430	41	BT022649	78	BT022741	53	BT022847	48	BT022912	60	BT022993	57
BT022432	41	BT022651	78	BT022742	53	BT022848	48	BT022913	60	BT022995	56
BT022434	41	BT022652	78	BT022743	53	BT022850	48	BT022930	51	BT023002	56
BT022436	41	BT022653	78	BT022744	53	BT022851	48	BT022931	51	BT023002	342
BT022532	55	BT022654	78	BT022745	53	BT022858	49	BT022932	51	BT023094	43
BT022600	74	BT022656	78	BT022746	53	BT022859	49	BT022933	51	BT023172	44
BT022601	74	BT022657	78	BT022750	53	BT022860	49	BT022934	51	BT023172	424
BT022602	74	BT022658	78	BT022751	53	BT022861	49	BT022935	51	BT023216	46
BT022603	74	BT022659	78	BT022752	53	BT022862	49	BT022936	51	BT024006	61
BT022604	74	BT022661	78	BT022753	53	BT022863	49	BT022937	51	BT024064	62
BT022605	75	BT022662	78	BT022754	53	BT022864	49	BT022940	51	BT024095	64
BT022606	74	BT022663	78	BT022755	53	BT022865	49	BT022941	51	BT024143	66
BT022607	74	BT022664	78	BT022756	53	BT022866	49	BT022942	51	BT024601	83
BT022608	74	BT022666	78	BT022800	48	BT022867	49	BT022943	51	BT024602	83
BT022609	74	BT022667	78	BT022801	48	BT022868	49	BT022944	51	BT024603	83
BT022611	75	BT022668	77	BT022802	48	BT022869	49	BT022945	51	BT024604	83
BT022612	75	BT022669	81	BT022803	48	BT022870	50	BT022946	51	BT024605	82
BT022613	75	BT022682	82	BT022804	48	BT022871	50	BT022950	51	BT025020	71
BT022614	75	BT022683	82	BT022805	48	BT022872	50	BT022951	51	BT025600	84
BT022615	76	BT022700	52	BT022806	48	BT022873	50	BT022952	51	BT025601	85
BT022616	75	BT022701	52	BT022807	48	BT022874	50	BT022953	51	BT025602	85
BT022617	75	BT022702	52	BT022808	48	BT022875	50	BT022954	51	BT025603	85

# CONTENT BY PRODUCT NAME FOR HAND TOOLS AND AUTOMOTIVE SPECIAL TOOLS

Art. Nr.	Page	Art. Nr.	Page	Art. Nr.	Page	Art. Nr.	Page	Art. Nr.	Page	Art. Nr.	Page
BT025604	85	BT031004	88	BT034012	376	BT065003	110	BT068014	121	BT101935	202
BT025606	84	BT031005	88	BT041001	96	BT065004	111	BT068015	121	BT101940	180
BT025607	84	BT031006	88	BT041002	96	BT065016	112	BT068018	117	BT101940	202
BT025608	84	BT031007	88	BT041003	96	BT065901	110	BT068024	117	BT101941	152
BT025609	84	BT031010	86	BT041004	96	BT065902	110	BT071925	137	BT101942	152
BT025611	84	BT031011	89	BT041005	96	BT065903	110	BT071926	137	BT101950	148
BT025612	84	BT031012	89	BT041006	96	BT066900	116	BT071930	137	BT101985	149
BT025613	84	BT031013	89	BT041007	96	BT066901	116	BT071931	137	BT102900	144
BT025614	84	BT031014	89	BT041008	96	BT066902	117	BT073030	136	BT102901	144
BT025900	72	BT031015	89	BT041009	96	BT066950	116	BT073050	136	BT102905	144
BT025905	72	BT031016	89	BT041011	97	BT067000	113	BT073080	136	BT103000	156
BT025906	73	BT031020	87	BT041012	97	BT067001	115	BT073100	136	BT103030	155
BT025907	73	BT031021	89	BT041013	97	BT067002	115	BT073150	136	BT103101	158
BT025919	72	BT031022	89	BT041014	97	BT067003	115	BT075100	136	BT103102	158
BT025922	72	BT031023	89	BT041015	97	BT067004	115	BT075125	136	BT103103	158
BT025924	72	BT031024	89	BT041016	97	BT067005	114	BT075150	136	BT103104	159
BT025926	72	BT031031	88	BT041017	97	BT067006	114	BT075200	136	BT103105	159
BT025927	72	BT031032	88	BT041018	97	BT067007	114	BT077025	136	BT103106	159
BT025928	72	BT031035	88	BT041019	97	BT067008	114	BT077040	136	BT103107	159
BT025930	72	BT031036	88	BT041100	96	BT067110	108	BT077080	136	BT103108	159
BT025932	72	BT031037	89	BT041200	97	BT067112	108	BT077100	136	BT103109	158
BT025934	72	BT031038	89	BT044009	94	BT067115	108	BT077150	136	BT103110	160
BT025936	72	BT031039	89	BT044019	95	BT067120	108	BT077250	136	BT110900	162
BT025938	72	BT031041	89	BT045009	94	BT067200	153	BT080918	142	BT111903	162
BT025941	72	BT031042	89	BT045019	95	BT067201	153	BT081906	142	BT114900	163
BT025942	72	BT031043	89	BT053001	98	BT067202	153	BT084910	142	BT114901	162
BT025945	72	BT031044	89	BT053003	98	BT067203	153	BT084911	142	BT114902	163
BT025948	72	BT031045	89	BT053032	100	BT067601	126	BT085010	139	BT114903	163
BT025950	72	BT031046	88	BT053100	101	BT067602	126	BT085030	140	BT115900	130
BT026000	68	BT031047	89	BT053208	102	BT067603	126	BT085060	138	BT115902	168
BT026001	69	BT031048	88	BT053208	192	BT067604	126	BT085070	141	BT115903	130
BT026002	69	BT031049	89	BT053532	99	BT067606	127	BT085080	141	BT115905	129
BT026003	69	BT031051	89	BT053901	98	BT067607	127	BT090900	143	BT115906	130
BT026004	69	BT031052	88	BT060005	104	BT067608	127	BT091004	143	BT115907	131
BT026005	69	BT031053	88	BT060901	105	BT067609	127	BT094901	178	BT115908	131
BT026006	69	BT031054	88	BT060902	105	BT067900	113	BT094902	178	BT120900	122
BT026007	69	BT031055	90	BT061901	105	BT067905	129	BT100900	145	BT121900	122
BT026008	69	BT031056	90	BT062901	105	BT068001	122	BT100901	145	BT122900	123
BT026009	69	BT031066	93	BT064902	106	BT068002	118	BT100902	145	BT122910	123
BT026011	69	BT031067	93	BT064906	106	BT068003	118	BT100903	146	BT124009	125
BT026012	69	BT031068	93	BT064907	106	BT068004	119	BT100950	154	BT124030	124
BT026013	69	BT031070	92	BT064908	106	BT068005	119	BT101922	147	BT124060	124
BT026014	69	BT031071	92	BT064910	107	BT068006	119	BT101923	147	BT130910	187
BT026016	69	BT031072	92	BT064911	107	BT068007	119	BT101924	147	BT141901	165
BT026017	69	BT031073	92	BT064912	107	BT068008	120	BT101925	150	BT141901	384
BT026018	69	BT031074	92	BT064913	107	BT068009	120	BT101926	150	BT141902	165
BT031000	86	BT031076	92	BT064914	108	BT068010	118	BT101927	150	BT141902	384
BT031001	88	BT031077	92	BT064915	108	BT068011	120	BT101928	150	BT141903	165
BT031002	88	BT031078	92	BT064916	109	BT068012	120	BT101930	147	BT141903	384
BT031003	88	BT034012	91	BT064917	109	BT068013	121	BT101935	180	BT141904	165

Art. Nr.	Page	Art. Nr.	Page	Art. Nr.	Page	Art. Nr.	Page	Art. Nr.	Page	Art. Nr.	Page
BT141904	384	BT160100	169	BT521000	222	BT541120	348	BT551360	239	BT586000	256
BT141905	165	BT160100	311	BT521000	447	BT541150	230	BT551360	337	BT591010	339
BT141905	384	BT160100	404	BT521010	223	BT541900	229	BT551360	456	BT591010	461
BT141906	165	BT160300	175	BT521015	223	BT542000	229	BT551376	245	BT591011	339
BT141907	165	BT160400	168	BT521030	214	BT542010	235	BT551376	351	BT591011	461
BT141908	165	BT160500	174	BT521050	216	BT542020	234	BT551380	243	BT591012	462
BT141909	165	BT160600	170	BT521100	216	BT542025	234	BT551400	245	BT591013	462
BT141910	165	BT160601	170	BT521150	218	BT542030	237	BT551400	417	BT591014	340
BT142005	166	BT160602	170	BT521150	394	BT542060	235	BT551400	431	BT591015	339
BT150800	186	BT160700	172	BT521200	217	BT542070	236	BT561000	246	BT591018	339
BT150900	188	BT160701	171	BT521250	215	BT542070	346	BT561005	246	BT591018	465
BT152900	189	BT160702	171	BT521300	215	BT542070	465	BT561005	337	BT591019	340
BT153207	190	BT160703	173	BT521300	386	BT542078	237	BT561005	437	BT591019	462
BT153207	399	BT160704	173	BT521300	466	BT542078	345	BT561005	443	BT591020	339
BT153473	192	BT160705	171	BT526000	220	BT542078	465	BT561005	459	BT591030	340
BT156905	183	BT160710	173	BT526001	220	BT542080	128	BT561006	246	BT591030	435
BT156910	179	BT160711	172	BT526002	220	BT546000	232	BT561006	336	BT591030	443
BT156912	137	BT161100	177	BT526003	220	BT546000	427	BT561006	437	BT591030	457
BT156916	186	BT161101	177	BT526004	221	BT546001	228	BT561006	446	BT591030	465
BT156917	179	BT161103	174	BT526005	221	BT546001	463	BT561006	459	BT591040	456
BT156919	183	BT161104	174	BT526006	220	BT546002	234	BT561010	248	BT591050	345
BT156920	183	BT162000	178	BT526007	214	BT546003	233	BT561020	248	BT591070	344
BT156921	180	BT180000	184	BT526008	216	BT546003	347	BT561030	249	BT591070	436
BT156923	180	BT180005	182	BT526009	216	BT546004	237	BT566000	246	BT591070	442
BT156930	179	BT180010	182	BT526009	412	BT546004	439	BT566001	247	BT591080	337
BT156931	179	BT511000	203	BT531000	224	BT546004	445	BT566002	247	BT591080	456
BT156932	179	BT511005	90	BT531050	225	BT546004	463	BT566003	247	BT591084	345
BT156933	179	BT511005	202	BT531150	227	BT551000	240	BT571013	253	BT591085	462
BT156940	181	BT511005	450	BT536000	225	BT551008	238	BT571013	374	BT591086	344
BT156941	181	BT511015	209	BT536001	224	BT551008	348	BT571014	253	BT591087	346
BT156942	181	BT511025	209	BT536004	224	BT551010	242	BT571014	377	BT591088	345
BT158013	191	BT511035	209	BT536006	226	BT551100	241	BT571014	452	BT591088	465
BT158013	195	BT511045	208	BT536007	226	BT551105	244	BT571015	252	BT591089	346
BT158016	193	BT511045	368	BT536008	226	BT551105	375	BT571016	253	BT591089	465
BT158016	197	BT511055	211	BT536009	226	BT551110	240	BT571016	400	BT591090	338
BT158018	196	BT511065	210	BT536010	214	BT551110	374	BT571020	250	BT591090	440
BT158021	196	BT511075	210	BT541050	231	BT551120	240	BT571050	252	BT591090	446
BT158024	191	BT511080	212	BT541060	232	BT551121	239	BT571060	251	BT591094	346
BT158024	192	BT511100	205	BT541060	355	BT551121	400	BT571080	250	BT591094	440
BT158024	195	BT511130	213	BT541061	228	BT551122	238	BT571090	252	BT591094	466
BT158170	190	BT511150	204	BT541061	336	BT551122	400	BT571091	253	BT591100	345
BT158170	192	BT511150	367	BT541061	437	BT551180	241	BT581000	258	BT591110	339
BT158170	194	BT511200	204	BT541061	442	BT551250	243	BT581050	257	BT591110	466
BT159016	197	BT511200	436	BT541061	460	BT551300	244	BT581200	227	BT591150	340
BT160005	176	BT511230	206	BT541062	233	BT551330	238	BT581250	259	BT591200	342
BT160010	176	BT516000	203	BT541062	382	BT551340	239	BT581350	259	BT591210	335
BT160015	176	BT516001	203	BT541070	232	BT551340	456	BT581400	260	BT591215	332
BT160030	176	BT516002	203	BT541080	233	BT551350	245	BT581450	261	BT591220	334
BT160035	176	BT516003	208	BT541100	231	BT551350	336	BT581500	261	BT591225	334
BT160100	93	BT516010	208	BT541120	233	BT551350	456	BT581530	258	BT591225	372

# CONTENT BY PRODUCT NAME FOR HAND TOOLS AND AUTOMOTIVE SPECIAL TOOLS

Art. Nr.	Page	Art. Nr.	Page	Art. Nr.	Page	Art. Nr.	Page	Art. Nr.	Page	Art. Nr.	Page
BT591225	391	BT591650	392	BT592540	413	BT593040	380	BT593670	359	BT594460	380
BT591230	334	BT591650	405	BT592550	372	BT593040	454	BT593670	386	BT594460	382
BT591235	334	BT591650	413	BT592560	369	BT593050	374	BT593750	352	BT594460	398
BT591240	334	BT591651	348	BT592570	372	BT593100	347	BT593750	355	BT594460	416
BT591245	334	BT591651	404	BT592570	389	BT593100	378	BT593750	362	BT594460	424
BT591245	390	BT591750	352	BT592575	372	BT593100	399	BT593750	364	BT594460	430
BT591250	332	BT591810	351	BT592575	390	BT593100	441	BT593750	406	BT594460	455
BT591260	335	BT591822	353	BT592578	373	BT593100	447	BT593750	406	BT594500	405
BT591260	346	BT591823	353	BT592578	380	BT593100	464	BT593750	425	BT594550	410
BT591260	359	BT591824	353	BT592580	372	BT593130	380	BT593770	406	BT594550	410
BT591260	364	BT591825	354	BT592585	372	BT593130	406	BT593800	354	BT594550	430
BT591260	378	BT591830	350	BT592585	391	BT593150	384	BT593800	364	BT594570	358
BT591260	394	BT591830	352	BT592590	372	BT593150	394	BT593800	406	BT594570	408
BT591260	399	BT591840	353	BT592590	391	BT593160	365	BT593800	423	BT594570	418
BT591260	405	BT591850	353	BT592600	370	BT593160	381	BT593815	356	BT594570	432
BT591260	407	BT591860	355	BT592600	388	BT593160	385	BT593815	419	BT594570	454
BT591260	418	BT591870	354	BT592650	369	BT593160	395	BT593815	434	BT594580	431
BT591260	426	BT591870	407	BT592660	370	BT593160	427	BT593820	410	BT594592	432
BT591260	439	BT591870	425	BT592660	390	BT593180	365	BT593820	414	BT594610	432
BT591260	446	BT591880	354	BT592700	333	BT593180	385	BT593820	432	BT594650	415
BT591260	448	BT591880	395	BT592700	366	BT593180	397	BT593830	410	BT594650	431
BT591260	450	BT591900	348	BT592700	371	BT593180	427	BT593830	412	BT594650	453
BT591260	463	BT591950	350	BT592700	376	BT593190	384	BT593830	431	BT594651	431
BT591270	391	BT591960	337	BT592700	388	BT593190	396	BT593850	415	BT594652	430
BT591275	391	BT591960	438	BT592750	368	BT593200	396	BT593870	356	BT594653	430
BT591280	391	BT591960	443	BT592800	371	BT593250	385	BT593870	412	BT594654	415
BT591300	335	BT591960	460	BT592800	390	BT593250	395	BT593890	358	BT594655	431
BT591300	356	BT592000	351	BT592801	371	BT593300	384	BT593890	386	BT594670	379
BT591300	369	BT592100	349	BT592801	390	BT593300	399	BT593910	412	BT594670	430
BT591300	414	BT592200	351	BT592810	454	BT593310	386	BT593920	417	BT594670	452
BT591310	367	BT592250	360	BT592850	377	BT593320	396	BT593930	417	BT594680	432
BT591310	388	BT592250	366	BT592860	361	BT593320	434	BT593940	417	BT595700	360
BT591320	333	BT592250	370	BT592860	375	BT593350	397	BT593970	419	BT595700	371
BT591320	368	BT592250	421	BT592860	397	BT593360	393	BT593970	434	BT595700	374
BT591320	389	BT592250	426	BT592860	424	BT593360	404	BT594200	416	BT595700	411
BT591350	332	BT592260	350	BT592860	455	BT593370	403	BT594240	414	BT595700	424
BT591350	371	BT592300	361	BT592870	377	BT593380	400	BT594240	435	BT595700	435
BT591350	389	BT592300	423	BT592880	392	BT593500	403	BT594250	412	BT595700	439
BT591500	355	BT592320	363	BT592880	420	BT593530	400	BT594250	434	BT595700	445
BT591515	348	BT592320	374	BT592880	453	BT593545	400	BT594260	415	BT595701	417
BT591520	351	BT592320	392	BT592900	374	BT593550	403	BT594300	356	BT595702	416
BT591550	353	BT592320	408	BT592950	379	BT593560	358	BT594300	416	BT595703	332
BT591556	352	BT592320	420	BT592951	375	BT593560	401	BT594350	414	BT595703	373
BT591560	349	BT592520	361	BT592970	376	BT593570	401	BT594350	434	BT595703	417
BT591570	350	BT592520	367	BT592976	378	BT593585	402	BT594410	429	BT595750	251
BT591580	348	BT592520	382	BT592980	377	BT593600	401	BT594420	429	BT595800	339
BT591580	350	BT592520	423	BT593000	393	BT593620	402	BT594450	333	BT595800	437
BT591580	362	BT592530	369	BT593010	379	BT593625	402	BT594450	368	BT595800	446
BT591580	407	BT592530	425	BT593029	380	BT593635	402	BT594450	413	BT595800	458
BT591580	425	BT592540	369	BT593029	398	BT593660	359	BT594460	362	BT595800	459
BT591650	349	BT592540	375	BT593030	376	BT593660	401	BT594460	367	BT595850	337



Art. Nr.	Page	Art. Nr.	Page	Art. Nr.	Page	Art. Nr.	Page	Art. Nr.	Page	Art. Nr.	Page
BT595850	340	BT596015	446	BT597920	453	BT641240	268	BT681100	296	BT701250	318
BT595850	437	BT596015	463	BT597940	363	BT651000	272	BT681150	296	BT701260	313
BT595850	442	BT596020	460	BT597940	373	BT651010	275	BT686000	294	BT706000	315
BT595850	459	BT597000	444	BT597940	381	BT651017	276	BT686001	294	BT706001	312
BT595850	462	BT597000	461	BT597940	393	BT651050	273	BT686002	294	BT706002	157
BT595900	445	BT597010	341	BT597940	411	BT651100	275	BT686003	296	BT706003	157
BT595900	461	BT597010	436	BT597940	422	BT651150	273	BT691004	79	BT706004	312
BT595910	347	BT597010	443	BT597940	433	BT651200	274	BT691004	299	BT706006	315
BT595910	440	BT597010	457	BT597990	364	BT651250	272	BT691005	80	BT706007	315
BT595910	447	BT597050	344	BT597990	425	BT661000	276	BT691005	167	BT706008	312
BT595910	464	BT597050	447	BT598100	428	BT661050	278	BT691005	300	BT706009	157
BT595920	347	BT597050	461	BT598110	429	BT661100	278	BT691006	79	BT706010	318
BT595920	441	BT597100	338	BT598120	428	BT661250	277	BT691006	299	BT706015	16
BT595920	448	BT597100	456	BT598130	428	BT661300	277	BT691007	79	BT706016	16
BT595920	464	BT597150	345	BT601000	264	BT661350	279	BT691007	299	BT706017	16
BT595950	342	BT597150	441	BT601006	262	BT666000	279	BT691008	79	BT706018	16
BT596000	351	BT597150	448	BT601007	262	BT666010	279	BT691008	299	BT706019	16
BT596001	402	BT597151	338	BT601020	264	BT671000	280	BT691009	79	BT706020	16
BT596002	336	BT597151	457	BT601040	265	BT671050	282	BT691009	299	BT706021	16
BT596002	346	BT597152	338	BT601050	265	BT671050	355	BT691010	80	BT711003	320
BT596002	359	BT597152	457	BT601060	265	BT671050	450	BT691010	300	BT711004	320
BT596002	364	BT597200	459	BT606000	263	BT671050	466	BT691011	79	BT711010	321
BT596002	377	BT597210	459	BT606001	263	BT671100	285	BT691011	298	BT711050	322
BT596002	382	BT597215	462	BT606002	263	BT671200	281	BT691012	309	BT711105	320
BT596002	394	BT597218	464	BT606003	263	BT671250	280	BT691013	309	BT711106	320
BT596002	398	BT597250	458	BT606004	262	BT671300	283	BT691015	310	BT711107	320
BT596002	404	BT597300	442	BT606004	337	BT671350	284	BT691019	310	BT711108	320
BT596002	406	BT597400	343	BT606004	437	BT671450	286	BT691050	305	BT711109	320
BT596002	419	BT597450	338	BT606004	442	BT671600	286	BT691100	308	BT711110	327
BT596002	420	BT597450	465	BT606004	459	BT671650	287	BT691150	309	BT711130	327
BT596002	439	BT597500	341	BT611000	254	BT671750	287	BT691155	302	BT711150	323
BT596002	447	BT597500	436	BT611020	256	BT671800	288	BT691159	301	BT711200	325
BT596002	450	BT597500	444	BT616000	254	BT671850	288	BT691160	301	BT711250	325
BT596002	463	BT597500	458	BT621000	266	BT671900	288	BT691165	301	BT711300	326
BT596003	342	BT597600	466	BT626000	266	BT671900	445	BT691166	302	BT716000	323
BT596003	438	BT597650	343	BT626050	267	BT672050	289	BT691170	303	BT716002	324
BT596003	444	BT597700	343	BT631000	134	BT672100	291	BT691190	307	BT716003	180
BT596004	341	BT597700	460	BT631021	132	BT672150	290	BT691210	305	BT716003	324
BT596004	438	BT597760	344	BT631022	132	BT672200	292	BT691230	304	BT716004	180
BT596004	444	BT597760	466	BT631023	132	BT672250	292	BT691260	306	BT716004	324
BT596005	343	BT597800	338	BT631050	133	BT672350	290	BT691290	304	BT716005	180
BT596005	438	BT597800	341	BT631100	134	BT672400	291	BT691310	307	BT716005	324
BT596005	445	BT597800	438	BT631150	133	BT672450	293	BT691330	306		
BT596006	439	BT597800	444	BT631200	135	BT676000	282	BT691360	303		
BT596006	445	BT597800	457	BT641000	269	BT676001	282	BT691390	308		
BT596006	462	BT597800	458	BT641050	269	BT676002	282	BT701000	316		
BT596007	339	BT597802	458	BT641060	269	BT676003	281	BT701050	317		
BT596007	461	BT597806	448	BT641060	355	BT676005	319	BT701100	319		
BT596008	460	BT597806	460	BT641100	269	BT676007	293	BT701150	316		
BT596010	459	BT597850	452	BT641150	270	BT681000	295	BT701200	314		
BT596015	440	BT597900	452	BT641220	268	BT681050	297	BT701220	314		

Page 57



**BT022993**  
**EAN 4042146844977**  
**1/2" telescopic reversible ratchet with flexible head**

**1/2"**

1/2" adapter to 3/4" .....	<b>59</b>	1/2" impact hexagon socket set, short.....	<b>77</b>
1/2" adapter to 3/8" .....	<b>59</b>	1/2" impact hexagon socket set, short.....	<b>81</b>
1/2" bit adapter.....	<b>59</b>	1/2" impact hexagon socket set,	
1/2" pneumatic ratchet, 67 Nm.....	<b>170</b>	long, 10 - 24 mm.....	<b>78</b>
1/2" pneumatic impact wrench.....	<b>93</b>	1/2" impact hexagon socket set, long.....	<b>78</b>
1/2" pneumatic impact wrench.....	<b>169</b>	1/2" impact extension, 125 mm.....	<b>81</b>
1/2" pneumatic impact wrench.....	<b>311</b>	1/2" Mini pneumatic impact wrench.....	<b>168</b>
1/2" pneumatic impact wrench.....	<b>404</b>	1/2" RIBE bit socket, 100 mm long.....	<b>53</b>
1/2" slide grip.....	<b>58</b>	1/2" RIBE bit socket, 140 mm long.....	<b>53</b>
1/2" Sliding piece.....	<b>59</b>	1/2" RIBE bit socket, 200 mm long.....	<b>53</b>
1/2" hexagonal bit socket.....	<b>49</b>	1/2" RIBE bit socket, 55 mm long.....	<b>53</b>
1/2" hexagonal bit socket set,		1/2" wobble extension.....	<b>60</b>
5 - 22 mm .....	<b>49</b>	1/2" hexagonal socket.....	<b>48</b>
1/2" hexagonal bit socket,		1/2" hexagonal socket, long version.....	<b>48</b>
100 mm long.....	<b>50</b>	1/2" Spiral-Profil socket set, 10 - 19 mm .....	<b>68</b>
1/2" hexagonal bit socket,		1/2" Spiral-Profil socket set, 21 - 32 mm.....	<b>69</b>
140 mm long.....	<b>50</b>	1/2" Spiral-Profil socket, 10 - 32 mm.....	<b>69</b>
1/2" hexagonal bit socket,		1/2" socket set.....	<b>42</b>
200 mm long .....	<b>50</b>	1/2" socket set, 32-pcs., RIBE profile.....	<b>440</b>
1/2" impact bit socket hexagon socket.....	<b>76</b>	1/2" socket set, hexagon socket profile.....	<b>54</b>
1/2" impact bit socket set, TORX®, T30 - T80.....	<b>74</b>	1/2" socket set, RIBE profile.....	<b>54</b>
1/2" impact bit socket TORX®.....	<b>74</b>	1/2" socket set, TORX® profi e.....	<b>55</b>
1/2" impact bit socket XZN.....	<b>75</b>	1/2" socket set, spline profile, XZN.....	<b>55</b>
1/2" impact bit socket set,		1/2" socket set,	
hexagon socket, 5 - 19 mm.....	<b>76</b>	12-point, short, 8 - 36 mm.....	<b>41</b>
1/2" impact bit socket set, XZN, M5 - M18 .....	<b>75</b>	1/2" telescopic telescopic handle.....	<b>57</b>
1/2" impact ball joint.....	<b>83</b>	1/2" telescopic reversible ratchet.....	<b>57</b>
1/2" impact hexagon socket, short.....	<b>77</b>	1/2" telescopic reversible ratchet.....	<b>362</b>
1/2" impact 12-point socket, 32 mm, short.....	<b>82</b>	1/2" telescopic reversible ratchet	
1/2" impact 12-point socket, 36 mm, short.....	<b>82</b>	with flexible head.....	<b>57</b>

**1/2"**

1/2" TORX <sup>®</sup> bit socket, 55 mm long.....	<b>52</b>	1/2" universal socket.....	<b>70</b>
1/2" TORX <sup>®</sup> bit socket.....	<b>48</b>	1/2" universal joint.....	<b>59</b>
1/2" TORX <sup>®</sup> bit socket, 100 mm long.....	<b>52</b>	1/2" extension.....	<b>60</b>
1/2" TORX <sup>®</sup> bit socket, 140 mm long.....	<b>52</b>	1/2" spline bit socket, 100 mm long.....	<b>51</b>
1/2" TORX <sup>®</sup> bit socket, 200 mm long.....	<b>52</b>	1/2" spline bit socket, 140 mm long.....	<b>51</b>
1/2" TORX <sup>®</sup> bit socket, tamper-proof, TB55.....	<b>59</b>	1/2" spline bit socket, 200 mm long.....	<b>51</b>
1/2" reversible ratchet.....	<b>56</b>	1/2" spline bit socket, 55 mm long.....	<b>51</b>
1/2" reversible ratchet with metal handle.....	<b>56</b>	1/2" spark plug socket.....	<b>48</b>
		1/2" 12-point socket.....	<b>41</b>

# Page 98

**BT053003**  
**EAN 4042146868461**

**1/4" square drive-adaptor-set, 1/4"-3/8"-1/2"**

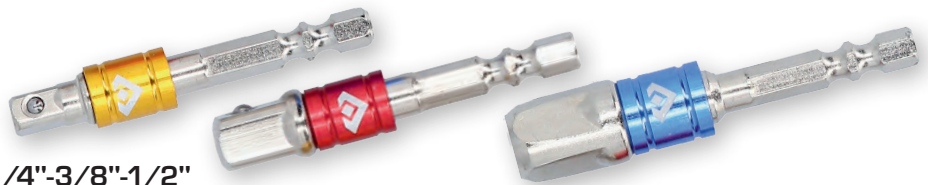

**1/4"**

1/4" adapter.....	<b>30</b>	1/4" hexagonal socket, long version.....	<b>27</b>
1/4" adapter to 3/8".....	<b>30</b>	1/4" spin type speeder.....	<b>26</b>
1/4" bit adapter.....	<b>30</b>	1/4" telescopic reversible ratchet.....	<b>33</b>
1/4" bit-screwdriver.....	<b>90</b>	1/4" telescopic reversible ratchet with flexible head.....	<b>33</b>
1/4" pneumatic ratchet, 35 Nm.....	<b>170</b>	1/4" TORX <sup>®</sup> bit socket.....	<b>28</b>
1/4" flexible extension.....	<b>26</b>	1/4" TORX <sup>®</sup> bit socket, tamper-proof.....	<b>28</b>
1/4" slide grip.....	<b>26</b>	1/4" TORX <sup>®</sup> E-socket.....	<b>27</b>
1/4" hexagonal bit socket.....	<b>28</b>	1/4" reversible ratchet.....	<b>32</b>
1/4" impact ball joint.....	<b>83</b>	1/4" reversible ratchet with metal handle, 100 tooth.....	<b>32</b>
1/4" mini reversible ratchet with metal handle, 100-tooth.....	<b>32</b>	1/4" universal socket.....	<b>70</b>
1/4" PH Phillips bit socket.....	<b>29</b>	1/4" universal joint.....	<b>30</b>
1/4" PZ Pozdriv bit socket.....	<b>29</b>	1/4" extension.....	<b>30</b>
1/4" slot bit socket.....	<b>29</b>	1/4" square drive-adaptor-set, 1/4"-3/8"-1/2".....	<b>98</b>
1/4" wobble extension.....	<b>31</b>	1/4" square drive screwdriver, 60 mm.....	<b>90</b>
1/4" hexagonal socket.....	<b>27</b>		

# Page 73

**BT025906...907**  
**3/4" extension**

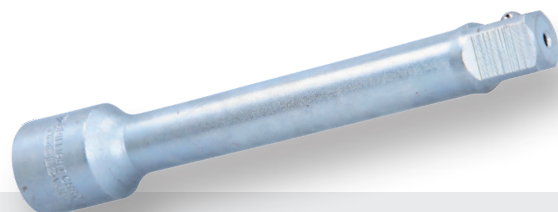

**3/4"**

3/4" pneumatic impact wrench.....	<b>169</b>	3/4" impact 12-point socket, short.....	<b>85</b>
3/4" sliding T-handle.....	<b>72</b>	3/4" hexagonal socket.....	<b>72</b>
3/4" impact hexagon socket, long.....	<b>84</b>	3/4" socket set.....	<b>71</b>
3/4" impact socket set, hexagon socket, long, 24 - 36 mm.....	<b>84</b>	3/4" reversible ratchet.....	<b>72</b>
		3/4" extension.....	<b>73</b>

# CONTENT BY PRODUCT NAME FOR HAND TOOLS AND AUTOMOTIVE SPECIAL TOOLS

Page 39

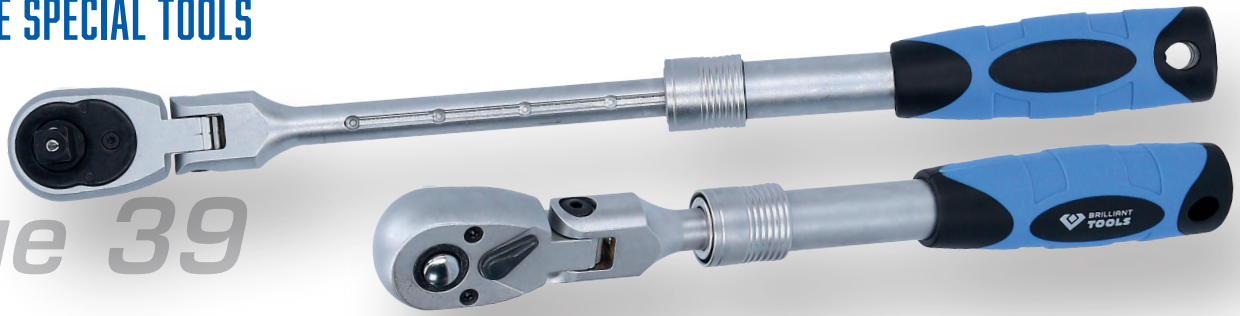

BT021997

EAN 4042146868454

3/8" telescopic reversible ratchet with flexible head

3/8"

3/8" adapter for 1/2".....	39	3/8" socket set.....	34
3/8" adapter for 1/4".....	39	3/8" telescopic reversible ratchet.....	38
3/8" bit adapter for 5/16".....	39	3/8" telescopic reversible ratchet with flexible head.....	39
3/8" pneumatic ratchet, 35 Nm.....	170	3/8" TORX® bit socket.....	37
3/8" Sliding head/adapter.....	39	3/8" TORX® bit socket, tamper-proof.....	37
3/8" impact ball joint.....	83	3/8" TORX® E-socket.....	36
3/8" PH bit socket.....	36	3/8" reversible ratchet.....	38
3/8" PZ bit socket.....	36	3/8" reversible ratchet with metal handle.....	38
3/8" slot bit socket.....	36	3/8" universal socket.....	70
3/8" wobble extension.....	40	3/8" universal joint.....	39
3/8" hexagonal bit socket.....	37	3/8" extension.....	40
3/8" hexagonal socket.....	35	3/8" spark plug socket.....	35
3/8" hexagonal socket, long version.....	35		

Page 204



BT511150

EAN 4042146778753

Air bag removal tool set

A

2 in 1 Telescopic-Magnetic holder, Ø 6 mm.....	130	for Renault, Mitsubishi, Opel.....	245
4in1 universal workbench.....	184	Air bag removal tool set.....	204
Adapter set.....	61	Air bag removal tool set.....	367
A/C Compressor clutch remover.....	254	Bearing separator.....	134
A/C Compressor clutch remover kit.....	254	Aluminium rim force socket.....	299
Adjustable spanner.....	13	Aluminium rim force socket set, 17 / 19 / 21 / 22 mm.....	80
Adjustment and locking tool for diesel pumps			

**A - B**

Aluminium rim force socket set, 17 / 19 / 21 mm .....	<b>80</b>	Ball joint tool, for BMW 3 Series .....	<b>277</b>
Aluminium rim force socket set, SW 15 / 17 / 19 / 21 / 22 mm .....	<b>300</b>	K4in1 Ball joint service tool set.....	<b>278</b>
Aluminium rim force socket set, SW 17 / 19 / 21 mm .....	<b>167</b>	Band wrench for oil filter casing.....	<b>320</b>
Aluminium rim force socket set, SW 17 / 19 / 21 mm .....	<b>300</b>	Battery terminal & wiper arm puller.....	<b>294</b>
Alignment and O-ring assembly set for VAG pump/nozzle unit.....	<b>239</b>	Belt tensioner wrench for Ford Duratorq engines.....	<b>253</b>
Alternator pulley kit.....	<b>250</b>	Bench vice, 6", 150 mm.....	<b>181</b>
Angled bit holder, 105° .....	<b>98</b>	Bench vice-protective jaws.....	<b>181</b>
Axle nut socket set.....	<b>280</b>	Bench vice-protective jaws with notches, plastic.....	<b>181</b>
Automatic centre punch .....	<b>142</b>	Bearing extractor set.....	<b>133</b>
Audi/VW Belt pulley reaction wrench .....	<b>214</b>	Bit set.....	<b>101</b>
Axle stands with quick unlocking.....	<b>182</b>	Bit set.....	<b>102</b>
Ball joint remover 23 - 28 - 34 mm.....	<b>276</b>	Bit set.....	<b>192</b>
Ball joint service tool set.....	<b>279</b>	Bit set, mixed .....	<b>100</b>
Ball joint spreader set.....	<b>277</b>	Bit set with bit reversing ratchet.....	<b>99</b>
		Bit socket for VAG Polydrive®.....	<b>228</b>
		Bit reversing ratchet.....	<b>98</b>
		Bleed nozzle adaptor set for brake bleeding .....	<b>314</b>

# Page 139

**BT085010**  
**EAN 4042146866733**  
**Chisel and punch set**

**B - C**

BLUE/SILVER Tool cabinet with 7 drawers and 207 premium tools.....	<b>399</b>	Cable reel, 15 m.....	<b>178</b>
Bolt cutter .....	<b>117</b>	Camshaft assembly tool for BMW N53, N54.....	<b>238</b>
Body grip pliers set.....	<b>112</b>	Camshaft assembly tool for BMW N51, N52.....	<b>233</b>
Brake bleeding device.....	<b>313</b>	Camshaft assembly tool for BMW N53, N54.....	<b>232</b>
Brake line rim engine, 4,75mm.....	<b>312</b>	Camshaft sprocket puller set.....	<b>233</b>
Brake thread repair kit M9x1.25, 16 pcs .....	<b>319</b>	Car window extension device for glued windows.....	<b>296</b>
Bushing/bearing/seal drivers.....	<b>287</b>	Cartridge gun.....	<b>178</b>
BT158018.....	<b>193</b>	Cartridge gun, 310 ml, M14 x 2,0 mm holder.....	<b>158</b>
BT158021 .....	<b>193</b>	Centre punch.....	<b>142</b>
BT159016.....	<b>193</b>	Centre punch set.....	<b>141</b>
Brass hand wire brush, 4 rows, 290 mm.....	<b>157</b>	Chain pipe wrench.....	<b>109</b>
Brush set for drilling machines .....	<b>160</b>		

# CONTENT BY PRODUCT NAME FOR HAND TOOLS AND AUTOMOTIVE SPECIAL TOOLS

## C - D

Chisel and punch set.....	138	Crankshaft holding key for Ford.....	253
Chisel and punch set.....	139	Crowbar.....	143
Chisel and punch set of chromium vanadium.....	140	Club hammer with hickory handle.....	136
Clipheber phrase.....	212	Combination pliers, 180 mm.....	105
Clip removal plier.....	208	Conditioning disconnection tool set fuel & air.....	225
COB flashlight 2in1 with 140 lumens.....	187	Claw grip with magnet and LED, adaptable.....	131
Common rail tester with 40 Adaptern.....	258	Claw grip with magnet and LED, rigid.....	131
CV joint assembly removal tool.....	281	Cape chisel.....	142
Circlip pliers for internal retention rings, straight, 125 mm.....	114	Cooling system vacuum purge & refill kit.....	216
Circlip pliers for internal retention rings, straight, 175 mm.....	115	Cooling system vacuum purge & refill kit.....	216
Circlip pliers set, 125 mm.....	113	Cooling radiator pressure tester.....	217
Circlip pliers set, 175 mm.....	113	Counter-support spanner for crankshaft pulleys for VAG.....	252
Circlip pliers set, pliers, hammer und chisel.....	193	Copper washer remover install tool diesel injector.....	243
Circlip pliers set, pliers, hammer und chisel.....	197	CV Boot band plier.....	282
Circlip pliers for external retention rings, curved, 125 mm.....	114	CV joint clamp banding tool.....	282
Circlip pliers for external retention rings, curved, 175 mm.....	115	Differetial & axle bush tool kit - BMW, E36/E46/ E38/E39/E60/E61/E31/E90/E91.....	289
Seegeringzange for Außensicherungsringe, gerade, 125 mm.....	114	Drive shaft retractor set.....	282
Circlip pliers for external retention rings, straight, 175 mm.....	115	Drivable stretcher.....	183
Circlip pliers for internal retention rings, curved, 125 mm.....	114	DCT clutch tool set for Ford / Volvo.....	268
Circlip pliers for internal retention rings, curved, 175 mm.....	115	Diagonal page cutter, 180 mm.....	105
Cleaning brush set.....	156	Diagonal page cutter, 180 mm.....	105
Crank/camshaft radial seal extraction set for VAG.....	236	Diesel fuel pump timing set.....	227
Crankshaft sealing ring assembly tool for VAG 1.4 and 1.6 16V.....	237	Diesel pump locking pin for Mercedes-Benz.....	239
Crank seal remover and installer kit.....	237	Diesel engine compression test set.....	257
Crankshaft lathe tool for Iveco.....	233	Diesel engine compression test set.....	258
Crankshaft radial seal assembly tool for VAG 2.0 TFSI.....	233	Diesel/petrol engine flywheel holding tool for BMW Mini.....	269
Crankshaft vibration damper alignment tool for Ford, Volvo.....	253	Digital multimeter.....	123
Crankshaft seal assembly device for VAG petrol & diesel engines.....	237	Digital depth gauge.....	163
		Digital measuring stick.....	163
		Disc brush, Ø 75 mm with 6 mm holder.....	159
		Disc brush, braided, Ø 75 mm with 6 mm holder.....	158
		Disc brush, Ø 115 mm.....	158
		DL hose reel Ø 10 mm.....	177
		DL hose reel Ø 8 mm.....	177
		Double open-ended spanner.....	12
		Double open-ended spanner.....	12
		Double ring spanner, offset.....	15

**D - G**

Double ring spanner, offset 18 x 19 mm.....	<b>15</b>	File set with file brush.....	<b>155</b>
Double ratchet ring key 4in1.....	<b>17</b>	Fitters hammer with hickory handle,.....	<b>136</b>
Double ring spanner set, 8 - 19 mm.....	<b>22</b>	Fitters hammer with hickory handle, french form.....	<b>136</b>
Double plug-in wrench, with bore.....	<b>22</b>	Flat chisel.....	<b>142</b>
DSG mechatronic unit remover for VAG.....	<b>266</b>	Flexible solenoid lifter.....	<b>130</b>
DSG coupling tool set,.....	<b>268</b>	Flexible hose clamps set, straight.....	<b>223</b>
Electronic brake fluid tester.....	<b>312</b>	Fly wheel locking tool for, Citroen, Fiat, Peugeot... <b>269</b>	
Engine oil pressure tester.....	<b>261</b>	FSI nozzle assembly and disassembly set.....	<b>239</b>
Engine bridge, 500 kg.....	<b>182</b>	Feeler gauge, 0,05 - 1 mm.....	<b>162</b>
Exhaust gas recirculation valve dismantling tool for Hyundai and Kia.....	<b>262</b>	Folding knife with lock and pocket.....	<b>144</b>
Exhaust puller set.....	<b>265</b>	Front upper ball joint remover/ installer tool - VWT4.....	<b>278</b>
Fuel synchronisation kit, 26 pcs.....	<b>227</b>	Front suspension bush tool for VAG.....	<b>288</b>
Fuel injection pump pressure tester kit.....	<b>259</b>	Front suspension bush tool for VW Polo 9N.....	<b>288</b>
Fuel injection test set.....	<b>259</b>	Front suspension bush tool for Mini.....	<b>288</b>
Fuel filter tool set for JTD engines.....	<b>225</b>	Front wheel bearing tool - 72mm.....	<b>286</b>
Fuel line unlocking tool.....	<b>224</b>	Front wheel hub bearing tool - 85mm.....	<b>286</b>
Fuel line unlocking tool set.....	<b>224</b>	Ford Transit rear hub puller.....	<b>319</b>
Fuel line unlocking pliers set.....	<b>224</b>	Gas soldering equipment set.....	<b>125</b>
Fuel pressure meter, 0-8 bar.....	<b>260</b>	Gearbox rising device for automatic gearbox including 35-piece adapter set.....	<b>267</b>
Fuel tank sender spanner for BMW.....	<b>226</b>	Grinding pin set for pencil grinder.....	<b>172</b>
Fuel tank sender spanner, 2 leg.....	<b>226</b>	Glow plug removal kit.....	<b>249</b>
Fuel tank sender spanner, 3 leg.....	<b>226</b>	Glow plug extractor set.....	<b>248</b>
Folding mechanic protection matt.....	<b>183</b>		
File set.....	<b>154</b>		

# Page 144

**BT102905**

**EAN 4042146778289**

**Folding knife with locking function  
and bag**



## Page 183

**BT156919**  
**EAN 4042146868362**

**Knee mat /  
 knee board,  
 480 mm x 320 mm**



### G - L

Glow plug tool set.....	248	Impact socket for aluminium rims, 17 mm.....	299
Glow plug connector pliers - angled jaw.....	247	Impact socket for aluminium rims, 19 mm.....	299
Glow plug connector pliers- straight jaw.....	247	Impact socket for aluminium rims, 21 mm.....	299
Handles with pull wire for cutting slices.....	296	Injector seat and manhole cleaning set.....	243
Haldex Filter service tool 46mm.....	323	Injector seat and manhole cleaning set.....	244
Hammer tacker.....	137	Internal & external puller set.....	135
Hand riveting tool set for $\emptyset$ 2.4 – 3.2 – 4.0 – 4.8 mm rivets.....	116	Inset with ratchet wrench.....	197
Heavy pincers 7", 175 mm.....	108	Inset with keys.....	195
Heavy duty wheel hub puller set.....	285	Inset with Screwdrivers.....	196
Hook and screwdriver set.....	128	Inset with Screwdrivers, Pliers.....	195
Hook set.....	318	Inset with Plug-in wets.....	194
Hose clamp pliers set, 90° angle,.....	223	Installer/remover (E90).....	292
Hose clamp plier.....	220	Injection nozzle assembly and disassembly tool for BMW, 6 pcs.....	238
Hose clamp plier with bowdengrip.....	221	Interchangeable belt tensioner wrench set.....	252
Hose clamp plier set.....	222	Interchangeable belt tensioner wrench set.....	251
Hose clamp plier set.....	447	Impact adapter set.....	82
HSS-Co Welding point drill.....	203	Impact ball joint set 1/4" + 3/8" + 1/2".....	83
Hydraulic wheel hub puller, 98 - 125 mm.....	280	Impact screwdriver slot, PH.....	87
Hydraulic wheel hub puller, for drive shafts.....	281	4in1 impact socket set.....	79
Impact socket for aluminium rims, 22 mm.....	299	Jar brush, 6 mm with holder.....	159
Infrared thermometer, -50°-500°.....	214	Jar brush, $\emptyset$ 65 mm with M14 x 2.0 mm holder ..	158
Injector alignment tool for Ford Duratorq.....	240	Japan spatula set, plastic.....	180
Injector extractor.....	240	Japan spatula set, plastic.....	202
Injector extractor set.....	241	Japan spatula set, metal.....	180
Injector extractor set.....	242	Japan spatula set, metal.....	202
Injector extractor set for HDI injectors from Bosch and Siemens.....	241	Knife and multifunctional pliers.....	146
Ignition coil extractor for VAG.....	246	Knee mat / knee board.....	183
Ignition coil extractor for VAG.....	246	Knife.....	144
Ignition coil extractor for VAG.....	246	Locking pliers, 140 mm.....	110
Impact socket for aluminium rims, 15 mm.....	79	Locking pliers, 220 mm.....	110
		Lever shears, straight cutting , 10".....	153
		Lever shears, left-sided , 10".....	153
		Lever shears, right cutting , 10".....	153



**L - O**

Lever-plate scissors set.....	<b>153</b>	Mini pick and hook set.....	<b>234</b>
Locking pliers / locking pliers set.....	<b>111</b>	Measuring stick.....	<b>163</b>
Locking pliers / locking pliers set, 140 - 220 mm.....	<b>110</b>	Mini pneumatic die grinder, straight.....	<b>171</b>
Long nosed pliers, curved, 200 mm .....	<b>105</b>	Mini pipe cutter.....	<b>312</b>
Long nose locking pliers 140 mm.....	<b>110</b>	Mechanic & nippers 10", 250 mm .....	<b>108</b>
LBMW Rearflower control arm bush,		Metal tool box, folding.....	<b>186</b>
Line wrench.....	<b>16</b>	Macpherson strut expander tool set.....	<b>275</b>
Line wrench set, 8 - 19 mm.....	<b>16</b>	Mounting tool for rear axle silent blocks for Fiat Stilo/Bravo.....	<b>292</b>
Nylon tool case.....	<b>62</b>	Oxygen sensor socket & thread chaser set .....	<b>264</b>
Master terminal release tool kit, universal.....	<b>205</b>	Oxygen sensor wrench, extra flat.....	<b>263</b>
Master release tool kit.....	<b>206</b>	Oxygen sensor wrench, flat.....	<b>263</b>
Mercedes & BMW Fan clutch tool set.....	<b>215</b>	Offset pipe pliers 45° angled.....	<b>108</b>
Magnetic armband.....	<b>179</b>	Oil filler funnel adapter.....	<b>327</b>
Magnetic shell with collecting frame .....	<b>302</b>	Oil pan plug screws and O-ring set.....	<b>325</b>
Measure tape.....	<b>162</b>	Oil drip tray / multifunctional tray.....	<b>180</b>
Magnetic parts tray set.....	<b>302</b>	Oil drip tray / multifunctional tray.....	<b>324</b>
Magnetic parts tray set, 140 x 240 mm.....	<b>301</b>	Oil drain sump plug key socket set.....	<b>323</b>
Magnetic parts tray set, Ø 150 mm.....	<b>301</b>	Oil filter spanner set.....	<b>321</b>
Master cooling radiator pressure tester with vacuum purge and refill kits.....	<b>218</b>	Oil filter spanner set.....	<b>322</b>
Master cooling radiator pressure tester with vacuum purge and refill kits.....	<b>394</b>	Oil filter spanner, 3leg.....	<b>320</b>
Mechanic's stethoscope.....	<b>256</b>	Oil spray can, 300 ml.....	<b>179</b>
Multimeter.....	<b>123</b>	Oil funnel with adaptor for VAG.....	<b>327</b>

*Page 218*

**BT521150**  
**EAN 4042146778869**  
**Master cooling radiator  
pressure tester with vacuum  
purge and refill kit, 28 pcs**



# CONTENT BY PRODUCT NAME FOR HAND TOOLS AND AUTOMOTIVE SPECIAL TOOLS

*Page 266*

**BT621000**  
**EAN 4042146780800**  
**Pneumatic fluid extractor/dispenser**



**P**

Panel/trim removal tool set.....	<b>208</b>	Plastic soft-head hammer Ø 40 mm.....	<b>137</b>
Panel/trim removal tool set.....	<b>368</b>	Pliers and Screwdriver.....	<b>191</b>
Pair of replacement heads Ø 32 mm.....	<b>137</b>	Pliers set.....	<b>104</b>
Pair of replacement heads, Ø 40 mm.....	<b>137</b>	Pre-chamber insert for Mercedes-Benz CDI.....	<b>238</b>
Petrol injection nozzle tool for BMW.....	<b>245</b>	Precision long nosed pliers.....	<b>126</b>
Petrol engine compression tester set.....	<b>256</b>	Precision long nosed pliers, curved.....	<b>127</b>
Petrol engine compression tester set.....	<b>257</b>	Precision flat pliers.....	<b>126</b>
Petrol engine coolant pump sprocket, Retainer - Vauxhall/Opel 2.2-chain drive.....	<b>216</b>	Precision combination pliers.....	<b>126</b>
Plastic magnet half shell Ø 110 mm.....	<b>301</b>	Precision needle nosed pliers.....	<b>127</b>
Plastic scraper set, 19/22/25/38 mm.....	<b>309</b>	Precision-mechanics-page cutter.....	<b>126</b>
Plastic soft-head hammer Ø 32 mm.....	<b>137</b>	Precision cutting pliers.....	<b>127</b>
		Precision telephone pliers.....	<b>127</b>

*Page 179*

**BT156930... 933**  
**Micro fine-knit gloves, black**



# Page 19

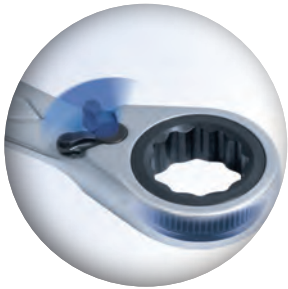

**BT013221**  
**EAN 4042146864241**  
Ratchet ring spanner set,  
reversing, 12 pcs, 6 - 32 mm



## P - R

Pliers for balancing weights.....	<b>309</b>	Polyester gloves, black.....	<b>179</b>
Press and pull sleeve kit, 26 pcs.....	<b>293</b>	Quick release hacksaw frame.....	<b>152</b>
Punch set, .....	<b>141</b>	Range of blind rivets .....	<b>116</b>
Pneumatic blow out pistol set including 3 interchangeable nozzles.....	<b>174</b>	Ratchet brake piston resetter, reversible.....	<b>315</b>
Pneumatic blow out pistol set, 110 - 500 mm .....	<b>174</b>	Ratchet ring spanner.....	<b>19</b>
Pneumatic fluid extractor/dispenser.....	<b>266</b>	Ratchet ring spanner set, 6 - 32 mm.....	<b>19</b>
Pneumatic-pistol grip drill.....	<b>173</b>	Ratchet ring spanner set, 8 - 19 mm.....	<b>18</b>
Pneumatic brake fluid bleeder kit.....	<b>314</b>	Ratchet ring spanner set, 8 - 19 mm.....	<b>18</b>
Pneumatic brake fluid bleeder kit.....	<b>175</b>	Ratchet ring spanner set, reversing, 6 - 32 mm .....	<b>21</b>
Pneumatic vacuum cleaner.....	<b>213</b>	Ratchet ring spanner set, reversing, 8 - 19 mm.....	<b>20</b>
Pneumatic spiral coiled tube, Ø 10 mm, 10 m .....	<b>176</b>	Ratchet ring spanner set, reversing, 8 - 19 mm.....	<b>20</b>
Pneumatic spiral coiled tube, Ø 6 mm, 10 m.....	<b>176</b>	Ratchet ring spanner set, reversing.....	<b>21</b>
Pneumatic die grinder set.....	<b>172</b>	Ratchet ring spanner.....	<b>193</b>
Pneumatic die grinder, angled.....	<b>171</b>	Reversible ratchet set.....	<b>56</b>
Pneumatic die grinder, straight.....	<b>171</b>	Reversible ratchet set, 2-pcs. ....	<b>342</b>
Pneumatic-pencil grinder set.....	<b>173</b>	Revolving punch pliers, Ø 2,5 - 3 - 3,5 - 4 - 4,5 mm.....	<b>117</b>
Pneumatic underbody protection gun.....	<b>174</b>	Refractometer.....	<b>214</b>
Pneumatic valve spring assembly tool set.....	<b>232</b>	Replacement head for BT022401.....	<b>57</b>
Pneumatic angled disc cutter.....	<b>173</b>	Radio removal tool set.....	<b>204</b>
Pneumatic hose.....	<b>176</b>	Radio removal tool set.....	<b>436</b>
Pry bar set.....	<b>143</b>	Rear axle bush tool for Ford Fiesta/Ka .....	<b>291</b>
Portable oil drain pan 16 l.....	<b>324</b>	Rear axle bush tool for Ford/Mazda/Volvo .....	<b>290</b>

# CONTENT BY PRODUCT NAME FOR HAND TOOLS AND AUTOMOTIVE SPECIAL TOOLS

Page 24

**BT020023**  
**EAN 4042146774281**  
**Socket set**

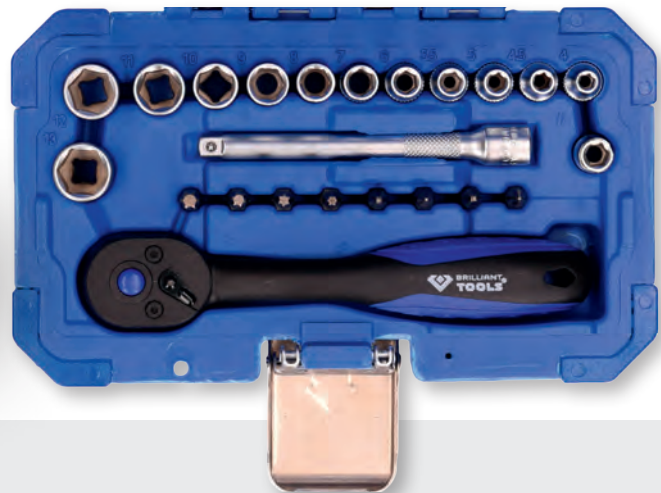

**R - S**

Rear sub frame bush kit for Ford Mondeo.....	<b>290</b>	Solenoid holder for impact screwdriver.....	<b>168</b>
Rear sub frame bushing kit for Renault Laguna II.....	<b>291</b>	Single-handed grease gun, 500 ccm.....	<b>178</b>
Repair set for oil drain screw thread .....	<b>325</b>	Set of compressed cushions.....	<b>208</b>
Repair set for oil drain screw thread .....	<b>326</b>	Seal puller .....	<b>234</b>
Repair tool for Lambda probe thread.....	<b>265</b>	Setting gauges for VAG pump-nozzle-units on	
Ring open-ended spanner .....	<b>14</b>	Spark plug thread chasers.....	<b>247</b>
Ring open ended spanner, 6 - 22 mm.....	<b>13</b>	Spark plug socket.....	<b>246</b>
Ring open ended spanner, 6 - 32 mm.....	<b>14</b>	Special injector socket set.....	<b>240</b>
Ring open ended spanner, 6 - 32 mm.....	<b>428</b>	Special spanner for exhaust gas temperature	
Ring open and double open ended spanner.....	<b>191</b>	sensor for VAG, SW 19 mm.....	<b>262</b>
Ring open and double open ended spanner .....	<b>192</b>	Special wrench for turbo charger	
Ruler.....	<b>162</b>	for VAG, SW 12 mm .....	<b>262</b>
Rivet plier for Ø 2.4 - 3.2 - 4.0 - 4.8 mm rivets..	<b>116</b>	Snipe nose pliers, 200 mm .....	<b>105</b>
Scraper .....	<b>147</b>	Snap off blades, 10 pcs.....	<b>144</b>
SAC Clutch alignment tool.....	<b>270</b>	Small insert bearing puller.....	<b>133</b>
Scraper .....	<b>147</b>	Stainless steel hand wire brush,	
Scraper, hook & pick set.....	<b>235</b>	3 rows, 290mm .....	<b>157</b>
Scapers set.....	<b>147</b>	Steel hand wire brush, 4 rows, 290 mm.....	<b>157</b>
Scapers set.....	<b>234</b>	Strut nut kit .....	<b>272</b>
Scaffolding wrench .....	<b>17</b>	Strut coil clamp spring compressor set.....	<b>273</b>
Small hand saw frame.....	<b>152</b>		
Sensor socket set.....	<b>264</b>		
Seat protection cover for single seats .....	<b>180</b>		
Slide hammer/puller set.....	<b>283</b>		
Slide hammer/puller set.....	<b>284</b>		
Soldering iron, 30 W.....	<b>124</b>		
Soldering iron, 60 W.....	<b>124</b>		



Page 17 **BT016001**  
**EAN 4042146867747**  
**Scaffolding wrench**

# Page 165

**BT141901...905**

**Torque wrench with rotary mushroom ratchet head, 1 - 320 Nm**

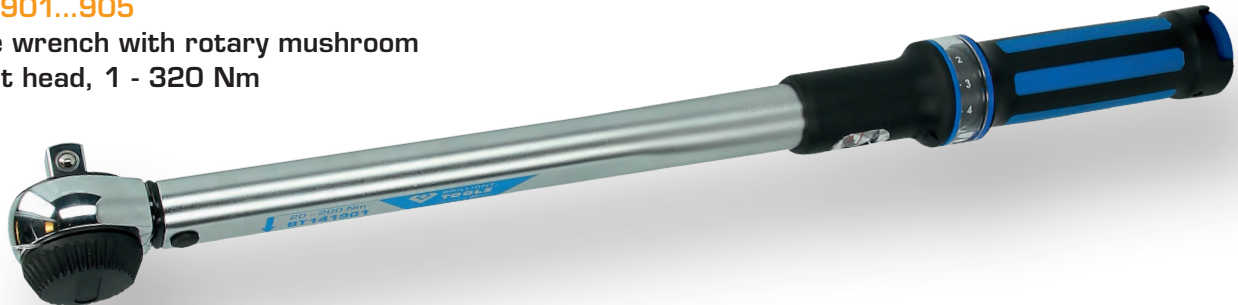

## T

Tail pipe expander.....	<b>265</b>	Torque wrench with switching ratchet head, 1 – 320 Nm.....	<b>165</b>
Test lamp.....	<b>122</b>	Torque wrench set.....	<b>166</b>
Track rod end remover/installer.....	<b>279</b>	Torque angle gauge.....	<b>228</b>
Telescopic internal spring compressor set.....	<b>274</b>	Torque angle gauge.....	<b>463</b>
Telescopic internal spring compressor.....	<b>275</b>	Tool cabinet with 7 drawers and 207 tools.....	<b>190</b>
Telescope magnet holder.....	<b>130</b>	Tool cabinet with 7 drawers and 473 tools.....	<b>192</b>
Telescope mirror and magnetic jack set.....	<b>129</b>	Tool cabinet with 7 drawers, empty.....	<b>189</b>
TiN tap and die set.....	<b>148</b>	Trim and removal set.....	<b>209</b>
TiN tap and die set.....	<b>149</b>	Trim removal set.....	<b>209</b>
Torx®- Screwdriver set.....	<b>90</b>	Trim removal set.....	<b>210</b>
Torx®- Screwdriver set.....	<b>202</b>	Trim removal set.....	<b>210</b>
Torx®- Screwdriver set.....	<b>450</b>	Trim removal set.....	<b>211</b>
Timing case cover alignment and pump wheel removal tool set for Ford 1.8 TDDi / TDCi.....	<b>244</b>	Trim removal set, 5 pcs.....	<b>209</b>
Thread repair set.....	<b>230</b>	Tweezers set.....	<b>129</b>
T-grip socket wrench.....	<b>193</b>	Tyre lever set.....	<b>308</b>
T-grip hexagon socket wrench.....	<b>196</b>	Tyre inflation gauge, 0 - 16 bar.....	<b>310</b>
T-grip hexagon socket wrench set, short.....	<b>94</b>		
T-grip hexagon socket wrench set.....	<b>95</b>		
T-grip hexagon socket wrench.....	<b>96</b>		
T-grip hexagon socket wrench set.....	<b>96</b>		
T-grip Torx® key wrench.....	<b>97</b>		
T-grip Torx® key wrench set.....	<b>97</b>		
Torque wrench with rotary-button-switch ratchet head, 1 – 200 Nm.....	<b>384</b>		
Torque wrench with rotary-button-switch atchet head, 1 – 320 Nm.....	<b>165</b>		

## Page 256

**BT611020**

**EAN 4042146813409**

**UV leak search torch set**

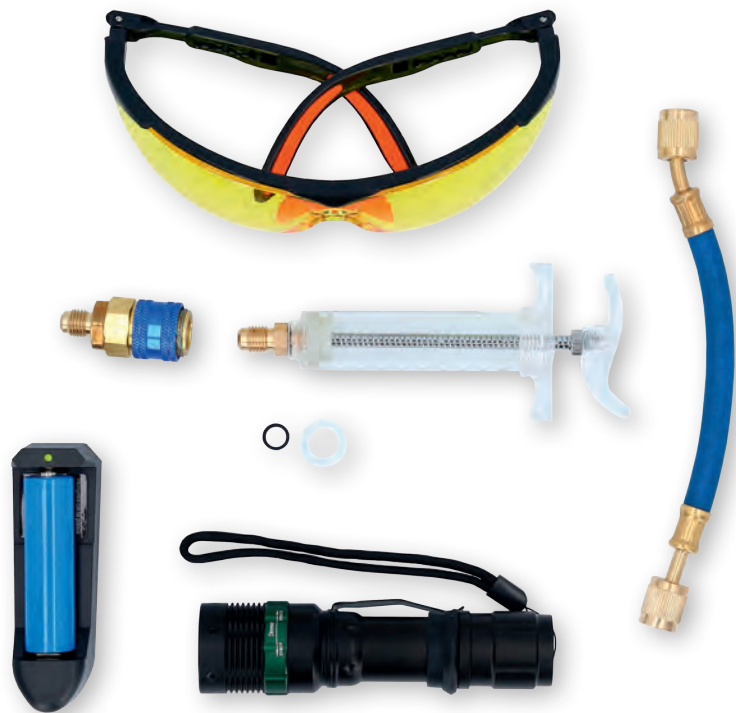
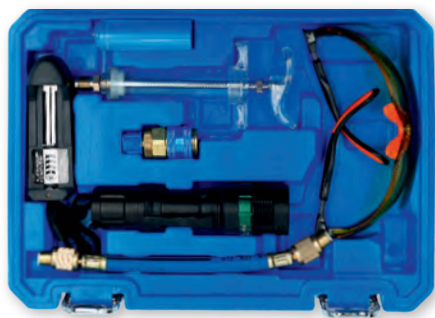

### U - V

Universal tie rod wrench, 36 - 41 mm .....	<b>279</b>	Vakuum-Druckpumpen-Satz.....	<b>261</b>
Universal caliper wind back kit .....	<b>315</b>	VDE Abisolierzange .....	<b>121</b>
Universal caliper wind back kit 15 - 90 mm.....	<b>315</b>	VDE Diagonal-Pagenschneider .....	<b>121</b>
Universal caliper wind back kit .....	<b>316</b>	VDE Flachrundzange.....	<b>120</b>
Universal caliper wind back kit .....	<b>317</b>	VDE Kombizange.....	<b>120</b>
Universal press support.....	<b>293</b>	VDE Rundzange .....	<b>121</b>
Universal brake drum and disc tool set.....	<b>318</b>	VDE Screwdriver Kreuz, PH0 x 75 mm .....	<b>119</b>
Universal pulley holder & fan clutch set.....	<b>251</b>	VDE Screwdriver Kreuz, PH1 x 80 mm.....	<b>119</b>
Universal ball joint pusher.....	<b>276</b>	VDE Screwdriver Kreuz, PH2 x 100 mm.....	<b>120</b>
Universal clutch alignment tool set.....	<b>269</b>	VDE Screwdriver Kreuz, PH3 x 150 mm.....	<b>120</b>
Universal clutch alignment tool set.....	<b>269</b>	VDE Screwdriver slot, 3,0 x 75 mm.....	<b>118</b>
Universal oil filter spanner.....	<b>320</b>	VDE Screwdriver slot, 4,0 x 100 mm.....	<b>118</b>
Universal scapers set.....	<b>147</b>	VDE Screwdriver slot, 5,5 x 100 mm.....	<b>119</b>
Universal scissors.....	<b>145</b>	VDE Screwdriver slot, 6,5 x 100 mm.....	<b>119</b>
Universal scissors.....	<b>145</b>	VDE Screwdriver set, Schlitz und Ph.....	<b>118</b>
Universal socket set, 5 - 32 mm.....	<b>70</b>	Valve seal removal and installation kit.....	<b>231</b>
Universal funnel set.....	<b>186</b>	Valve puller .....	<b>309</b>
Universal workshop scissors.....	<b>145</b>	Valve spring mounting tool set.....	<b>231</b>
Universal tool case .....	<b>64</b>	Double cup valve grinder set.....	<b>232</b>
Universal tool case .....	<b>66</b>	Double cup valve grinder set.....	<b>427</b>
Universal wing cover.....	<b>180</b>	V-belt assembly and disassembly tool set.....	<b>250</b>
Universal fuel tank sender spanner.....	<b>226</b>	V-ribbed belt tensioning element	
Universal 2 arm puller.....	<b>132</b>	for Mercedes-Benz W169 and W245.....	<b>253</b>
Universal 3 arm puller.....	<b>132</b>	Vibration damper holding key for Ford and Volvo..	<b>252</b>
Universal puller set.....	<b>134</b>	Voltage tester .....	<b>122</b>
Universal lock out tool kit.....	<b>203</b>	Voltage tester, 140 mm.....	<b>122</b>
UV leak search torch set.....	<b>256</b>		

# Page 190

**BT153207**  
**EAN 4042146831878**  
**Tool cabinet with 7 drawers**  
**and 207 tools**



## W

Water pump wheel holding tool for Opel Ecotec engines.....	216
Water pump pliers.....	106
Water pump pliers.....	106
Water pump pliers.....	107
Water pump pliers set 7", 10", 12".....	107
Weld point drill cutters.....	203
Wheel bearing tool set.....	287
Wheel locking key set for Audi.....	303
Wheel locking key set for BMW.....	303
Wheel locking key set for BMW.....	304
Wheel locking key set for BMW.....	304
Wheel locking key set for BMW.....	305
Wheel locking key set for Mercedes.....	305
Wheel locking key set for Porsche.....	306
Wheel locking key set for VW.....	306
Wheel locking key set for VW.....	307
Wheel locking key set for VW.....	307
Wheel locking key set for VW.....	308
Wheel brace, 1/2" x 17 x 19 x 22 mm.....	310
Wiper arm removal.....	294
Wiper arm removal.....	294
Wiper arm removal set.....	295
Wiper arm removal set.....	297
Wire end brush, Ø 25 mm with 6 mm holder.....	159
Windshield removal tool set.....	296
Wobble extension set.....	31
Wobble extension set.....	40
Wobble extension set.....	60

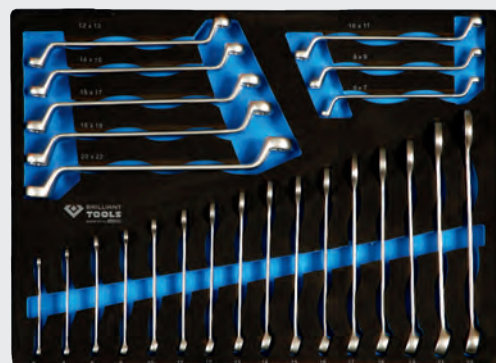
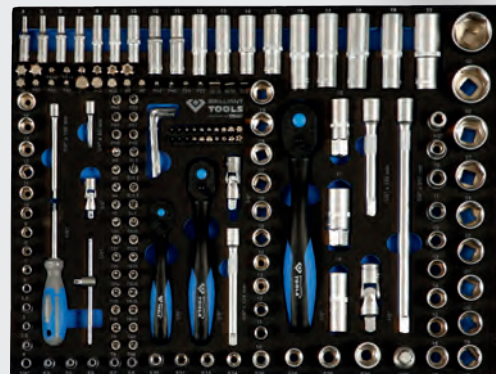



## 10-YEAR WARRANTY IMPORTANT INFORMATION

Please keep all documents in a safe place, as they constitute part of your purchase agreement.

As the original purchaser of our branded products, you receive a 10-year warranty on the material and surface condition, functional reliability and high standard of workmanship of all products under our BRILLIANT TOOLS brand in accordance with the quality and test specifications valid at the time of delivery.

The warranty includes the statutory 2-year warranty, only applies to new goods and is non-transferable.

The warranty does not affect statutory warranty claims, such as those concerning supplementary performance, rescission or compensation for damages.

### Warranty terms and conditions.

The warranty shall be fulfilled through, at the warrantor's choice, repair or subsequent delivery and shall not be suspended nor interrupted through the performance of services, i.e. the warranty shall end ten years after the delivery date.

Proper transportation, assembly, connection and use by authorised specialist staff are a mandatory requirement for the warranty to be valid.

The relevant installation, safety and operating instructions as well as the enclosed assembly instructions apply to all electronic components.

The warranty does not cover ten years of a new condition.

No liability is accepted for damage of any kind resulting from collection by the customer, overloading, operating errors or changes to the delivery state or consumables.

Products used for demonstration purposes are also excluded from the warranty, as they no longer conform to new condition due to use and demonstration effects. The statutory two-year warranty applies and we recommend documenting signs of wear before the transfer of risk.

Material defects are generally repaired by the trade partner and only on presentation of the purchase agreement.

*BrilliantTools<sup>®</sup>*

### The following are not covered by the warranty:

- ❖ Normal and natural signs of wear
- ❖ Wear caused by excessive or improper use
- ❖ Damage that occurs through normal and natural wear during use by the purchaser
- ❖ Improper modifications by unauthorised persons
- ❖ Improper exposure to heat, moisture, liquids or care products
- ❖ Damage caused by pointed, sharp, hot or wet objects
- ❖ Environmental factors such as extreme dryness, humidity, light or temperature
- ❖ Intentional destruction, misuse, overloading or accidental damage
- ❖ Damage and soiling caused by heat sources or weather
- ❖ Discolouration caused by medication ingredients (toxic reaction)
- ❖ Any changes caused by substances containing acid, solvents or alcohol
- ❖ Unsuitable cleaning, repair or improvement attempts
- ❖ Moisture damage caused by standing water or condensation not being removed
- ❖ Characteristics typical of the product that do not constitute material defects





**WORK  
BRILLIANT**



**BRILLIANT<sup>®</sup>  
TOOLS**

powered by **KS TOOLS**

**KS Tools Werkzeuge - Maschinen GmbH**  
Seligenstädter Grund 10-12  
D-63150 Heusenstamm

[www.brilliant-tools.com](http://www.brilliant-tools.com)

Где купить:  
ООО "КОМПАНИЯ ОПТУЛС"  
г.Москва, ул.Иловайская, д.3, стр.2  
Tel.: +7 (495) 646-00-96  
E-Mail: [sale@opttools.ru](mailto:sale@opttools.ru)  
Internet: [www.opttools.ru](http://www.opttools.ru)

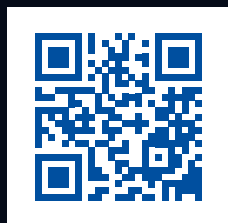

All prices mentioned in this catalog are recommended retail prices plus VAT. Prices valid until 31.03.2023. Sale only to specialist dealers. Misprints, errors and technical changes reserved.