



CEMBRE

GENERAL CATALOGUE



CEMBRE AT A GLANCE

INNOVATION IS IN OUR DNA



276
Patents and
filled applications

121
Registered
trademarks
in 27 countries



MAIN MANUFACTURING SITE, ITALY



60,000
m² of space
dedicated to offices,
factories, laboratories

121,000
m² of site

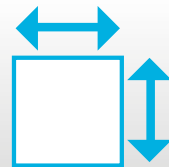

OUR PRODUCT CODES



17,995
different product codes
sold each year

19,515
product codes are
available for
immediate dispatch



AUTOMATED WAREHOUSE



60,000
bins capacity

10,000
order lines
per working day



are registered trademarks of CEMBRE S.p.A.

 **CEMBRE**

 **Cembre**

Crimpstar

ZETApiù

ZETAblock

ZETAmini

SICURclips

MAXIblock

spiralblock

MAXIbrass

 **EWO**
EASY WIRE ORGANIZER

Quality and Innovation: our priorities



Certified Quality Management System



Certified Environmental Management System



Certified Occupational Health & Safety Management System



“It is the aim of CEMBRE S.p.A. and all its employees to pursue the satisfaction of their customers through the fulfilling of their needs by meeting their legitimate expectations.”

To achieve this goal, CEMBRE places the following principles at the very heart of its work:

- highest quality product and services
- continuously research and innovative solutions.
- safeguarding the environment and protecting the health and safety of workers and users of its products
- respect and promote the values set out in the Company's Code of Ethics
- ensure strict fulfillment of statutory, national and international laws and regulations

The Company's Management System, certified in accordance with ISO 9001 : 2015 quality standards, ISO 14001 : 2015 for environmental protection and ISO 45001 : 2018 standard for the protection of the health and safety of workers, **are the tools used to translate the principles of company policy into corporate objectives and to monitor their fulfilment.**



All CEMBRE products comply with Directive 2011/65/EU of the European Parliament and Council dated 8 June 2011 (and subsequent amendments)

Index

ELECTRICAL CONNECTORS

symbol description.....	4
PVC INSULATED CRIMP TERMINALS.....	6
FEMALE DISCONNECT TERMINALS.....	8
MALE DISCONNECT TERMINALS.....	8
MALE/FEMALE.....	8
BULLET AND SOCKET.....	8
BUTT AND PARALLEL CONNECTORS.....	9
BUTT CONNECTORS.....	9
CLOSE END CONNECTORS.....	9
HALOGEN FREE INSULATED TERMINALS.....	10
INSULATED CHAIN TERMINALS.....	12
REINFORCED PA 6.6 INSULATED TERMINALS.....	14
REINFORCED DISCONNECT TERMINALS.....	16
FEMALE CONNECTORS.....	16
MALE CONNECTORS.....	17
MALE TABS.....	17
CONNECTOR SLEEVES.....	17
PA6 INSULATED END SLEEVES.....	18
"TWIN" PA6 INSULATED END SLEEVES.....	20
"TWIN" POLYPROPYLENE INSULATED END SLEEVES.....	21
POLYPROPYLENE INSULATED CHAIN END SLEEVES.....	22
UNINSULATED END SLEEVES.....	22
COPPER TUBE CRIMPING LUGS PC INSULATED.....	23
POLYAMIDE PA6.6 INSULATED COPPER TUBE LUGS.....	24
POLYAMIDE PA6.6 INSULATED FORK TERMINALS.....	27
POLYAMIDE PA6.6 INSULATED PIN TERMINALS.....	27
UNINSULATED TERMINALS.....	28
CRIMPING CONNECTORS ACCORDING TO DIN 46234.....	32
COPPER TUBE CRIMPING LUGS.....	34
RING TONGUE TERMINALS WITH CONTAINED PALM.....	36
COPPER TUBE CRIMPING LUGS.....	37
COPPER TUBE CRIMPING LUGS ANGLED 90°.....	38
COPPER TUBE CRIMPING LUGS.....	39
COPPER TUBE CRIMPING LUGS ANGLED 31.5° and 34.5°.....	41
HEAVY DUTY COPPER TUBE TERMINALS.....	42
THROUGH CONNECTORS.....	44
PARALLEL CONNECTORS.....	44
COPPER TUBE LUGS 4-ESI FIXING.....	45
UNINSULATED PIN CONNECTORS.....	46
UNINSULATED ROUND PIN CONNECTORS.....	46
UNINSULATED ROUND PIN CONNECTORS ANGLED 45°.....	47
UNINSULATED FORK TERMINALS.....	47
COPPER TUBE CRIMPING LUGS ACCORDING TO DIN 46235.....	48
COPPER TUBE CRIMPING LUGS ACCORDING TO DIN 46235.....	49
CRIMPING THROUGH CONNECTORS ACCORDING TO DIN 46267 T.1.....	49
COPPER TUBE CRIMPING LUGS.....	50
CRIMPING THROUGH CONNECTORS.....	51
COPPER TUBE CRIMPING LUGS.....	52
COPPER TUBE CRIMPING LUGS ANGLED 90°.....	54
COPPER TUBE CRIMPING LUGS ANGLED 45°.....	55
COPPER TUBE CRIMPING LUGS ACCORDING TO NF C 20-130.....	56
COPPER TUBE CRIMPING LUGS ANGLED 90°.....	57
CRIMPING THROUGH CONNECTORS.....	57
COLOUR CODED COPPER CRIMPING LUGS AND SPLICES.....	58
SLEEVE CONNECTORS.....	63
H CLAMPS.....	64
TWIN CABLE TERMINAL LUGS FOR ROUND CONDUCTORS.....	65
COPPER TUBE CRIMPING LUGS WITH 2 HOLE FIXING.....	66
MECHANICAL FIXING LUGS.....	67
CABLE CLAMPS.....	67
MEDIUM VOLTAGE COPPER TERMINALS.....	68
MEDIUM VOLTAGE STALK CONNECTORS.....	70
MEDIUM VOLTAGE COPPER THROUGH CONNECTORS.....	71
ALUMINIUM TERMINALS.....	72
THROUGH CONNECTORS.....	73
REDUCER THROUGH CONNECTORS.....	73
ALUMINIUM TERMINALS.....	74
ALUMINIUM THROUGH CONNECTORS.....	75
BIMETALLIC CONNECTORS.....	76
MECHANICAL LUGS AND SPLICES.....	79

TERMINAL BLOCKS, FLEXIBLE BUSBAR, BRAIDS AND DISTRIBUTION BLOCKS

symbol description.....	82
example applications.....	83
SINGLE POLE TERMINAL BLOCKS.....	84
CONNECTING CAPACITY OF TERMINAL BLOCKS.....	86
POWER DISTRIBUTION BLOCK.....	88
CONNECTING CAPACITY OF POWER DISTRIBUTION BLOCK.....	89
ONE WAY TERMINAL BLOCKS.....	90
TERMINAL BLOCK TYPE EKL.....	91
TERMINAL BLOCK TYPE ZS.....	91
UNIPOLAR DISTRIBUTION BLOCKS.....	92
BIPOLAR DISTRIBUTION BLOCKS.....	92
TETRAPOLAR DISTRIBUTION BLOCKS.....	93
ACCESSORIES.....	93
INSULATED FLEXIBLE BUSBAR.....	94
FLEXIBLE BRAIDS.....	97
CABLE TIES.....	98
ACCESSORIES.....	102
INSULATED COVERS.....	103
TERMOCOIL HEAT-SHRINKABLE TUBING.....	104
CAST RESIN JOINTS.....	109

CABLE GLANDS AND ACCESSORIES

symbol description.....	112
range overview.....	113
MAXIBLOCK CABLE GLANDS.....	114
SPIRALBLOCK CABLE GLANDS.....	120
MAXIBLOCK ATEX and UKEX CABLE GLANDS.....	121
COMPRESSION CABLE GLANDS.....	122
MAXIBRASS CABLE GLANDS.....	124
MAXIBRASS ATEX and UKEX CABLE GLANDS.....	128
EMC CABLE GLANDS.....	128
COMPRESSION CABLE GLANDS.....	129
MAXINOX CABLE GLANDS.....	130
LOCKNUTS WITH COLLAR.....	132
LOCKNUTS WITHOUT COLLAR.....	133
LOCKNUTS.....	134
EMC LOCKNUTS.....	135
MAXINOX LOCKNUTS.....	135
INTERNAL PLUGS FOR CABLE GLANDS.....	136
MULTI-ENTRY SEALS FOR CABLE GLANDS.....	137
MULTI-ENTRY SEAL PLUGS FOR CABLE GLANDS.....	137
ENTRY THREAD ADAPTERS.....	138
ACCESSORIES.....	141
SEALING RINGS.....	142
ENTRY PLUGS.....	145
ENTRY BUSHES.....	146
ENTRY PLUGS.....	147
ENTRY BUSHES.....	147
GROMMETS.....	148
MODULAR RETAINING CLIPS.....	148

SPLIT CABLE ENTRY SYSTEMS FOR PREDETERMINED CABLES AND ACCESSORIES

SPLIT CABLE ENTRY SYSTEMS FOR PREDETERMINED CABLES.....	150
CIRCULAR SPLIT CABLE ENTRY SYSTEMS FOR PREDETERMINED CABLES.....	158
GROMMETS FOR SPLIT CABLE ENTRY SYSTEMS.....	162
BLINDPLUGS.....	165
RECTANGULAR FLAT SEALS.....	166
INTUMESCENT GASKETS FOR FIRE BARRIERS.....	167
PUSH-FIT MOUNTS.....	168
CLOSING PLATES WITH SCREWS.....	169
SNAP-ON CLOSING PLATES.....	170
SPLIT BUSHING FOR CIRCULAR SPLIT CABLE ENTRY SYSTEMS.....	170

CABLE ENTRY WITH MEMBRANE TWO-COMPONENT FOR UNMARKED CABLES SERIES 9200

MEMBRANE CABLE ENTRY FOR UNMARKED CABLES.....	172
---	-----

CABLE ENTRY WITH MEMBRANE IN RUBBER FOR UNMARKED CABLES SERIES 9220 TYPE A

MEMBRANE CABLE ENTRY FOR UNMARKED CABLES.....	178
---	-----

CABLE ENTRY WITH MEMBRANE IN RUBBER FOR UNMARKED CABLES SERIES 9220 TYPE B

MEMBRANE CABLE ENTRY FOR UNMARKED CABLES.....	182
---	-----

MECHANICAL AND PNEUMATIC TOOLS

symbol description.....	186
MECHANICAL TOOLS CRIMPSTAR® RANGE.....	188
MECHANICAL TOOLS.....	196
MECHANICAL TOOLS ND® RANGE.....	198
MECHANICAL TOOLS ZKE RANGE.....	199
MECHANICAL TOOL HWEIN.....	200
MECHANICAL TOOL IDT.....	201
MECHANICAL TOOLS TN RANGE.....	202
MECHANICAL TOOLS TNE RANGE.....	204
WIRE STRIPPERS HB RANGE.....	208
CABLE STRIPPING TOOLS HB RANGE.....	213
CABLE CUTTERS KT RANGE FOR SMALL SECTIONS.....	214
RATCHET CABLE CUTTERS KT RANGE.....	215
CABLE CUTTERS KT RANGE FOR LARGE SECTIONS.....	216
HAND TOOLS.....	218
HAND TOOLS FOR CABLE TIES.....	219
ASSORTMENT CASE.....	220

BENCH PRESS TOOLS

BENCH PRESS TOOL.....	224
ELECTRO-PNEUMATIC BENCH PRESS.....	226
PNEUMATIC CRIMPING TOOLS.....	227
BENCH PRESS.....	228

PROFESSIONAL EQUIPMENT

symbol description.....	230
PROFESSIONAL SCISSORS SC5X.....	232
PROFESSIONAL SCISSORS SC6X.....	233
PROFESSIONAL SCISSORS SC RANGE.....	234
CBLIGHT.....	236
CBLIGHT HD.....	240
PROFESSIONAL SCREWDRIVERS SDC RANGE.....	244
PROFESSIONAL HEX SOCKET SCREWDRIVERS.....	247
UNIVERSAL KEY UKC4.....	247
PROFESSIONAL PLIERS.....	248
PROFESSIONAL TOOL HOLDERS.....	250
PROFESSIONAL SPANNERS.....	262
PROFESSIONAL TORQUE WRENCHES.....	265
PROFESSIONAL SOCKETS & DRIVES.....	266
PROFESSIONAL SPANNERS & SOCKETS.....	267
PROFESSIONAL HAMMERS & REMOVAL TOOLS.....	268
PROFESSIONAL CUTTERS, SAWS & FILES.....	269
PROFESSIONAL DIGITAL INSTRUMENTS.....	270
PROFESSIONAL TAPES, LEVELS & LINES.....	271
PROFESSIONAL HOLE MAKING ACCESSORIES.....	272

HYDRAULIC TOOLS AND HEADS

symbol description.....	276
HYDRAULIC CRIMPING TOOLS.....	278
HYDRAULIC PRESSHEADS.....	280
HYDRAULIC CUTTING TOOLS.....	294
HYDRAULIC CUTTING HEADS.....	294
PIERCING HEADS.....	303
PULLER-TYPE HOLE PUNCHING TOOLS.....	304
HOLE PUNCHING KIT.....	304
PULLER-TYPE HOLE PUNCHING HEAD.....	305
NUT SPLITTING HEADS.....	306

CORDLESS HYDRAULIC TOOLS

symbol description.....	308
18.0 V - CORDLESS TOOL FEATURES.....	310
18.0 V CORDLESS HYDRAULIC CRIMPING TOOLS.....	312
18.0 V CORDLESS HYDRAULIC CUTTING TOOLS.....	326
18.0 V CORDLESS HYDRAULIC FRAME-TYPE HOLE PUNCHING TOOL.....	339
18.0 V CORDLESS HYDRAULIC PULLER-TYPE HOLE PUNCHING TOOL.....	340
KIT FOR HOLE PUNCHING.....	342
PUNCHING ACCESSORIES AVAILABLE.....	343
18.0 V CORDLESS HYDRAULIC NUT SPLITTING TOOL.....	344

HYDRAULIC PUMPS AND UNITS

HYDRAULIC PUMP.....	346
PORTABLE ELECTRO-HYDRAULIC PUMP.....	348
PORTABLE ELECTRO-HYDRAULIC PUMPS B70M-P36 RANGE.....	350
PORTABLE ELECTRO-HYDRAULIC PUMP.....	351
ACCESSORIES FOR B70M-P36.....	352
COMBINATIONS OF PUMPS AND HYDRAULIC HEADS.....	352
HYDRAULIC UNIT.....	353
HYDRAULIC CUTTING UNIT.....	354
PORTABLE BATTERY HYDRAULIC CUTTING UNITS.....	356
PORTABLE BATTERY INSULATED HYDRAULIC PUMP.....	358
PORTABLE ELECTRO-HYDRAULIC INSULATED PUMP.....	359
ACCESSORIES FOR CORDLESS TOOLS.....	360
BATTERY AND BATTERY CHARGER KIT.....	361
POWER SUPPLIES.....	361
ACCESSORIES FOR STORAGE OF DIES.....	362
TRANSPORT ACCESSORIES.....	362
COMPRESSION KIT FOR 50KN AND 60KN TOOLS.....	363
MODULAR SYSTEM FOR TRANSPORT.....	364
ACCESSORIES FOR HYDRAULIC PUMPS.....	366
ACCESSORY FOR HYDRAULIC HEADS.....	366

DIE SELECTOR CHART

DIE SELECTOR CHART.....	368
DIE SELECTOR CHART FOR DEEP STEPPED INDENTING WITH CONTAINING DIES.....	373
DIE SELECTOR CHART.....	375
MUT DIES CROSS REFERENCE CHART.....	382
RHU600 DIES CROSS REFERENCE CHART.....	383
RHU1000 DIES CROSS REFERENCE CHART.....	384

APPENDIX

















Comparison of AWG, MCM and Metric conductor cross sections.....	386
IEC 60228 : 2004 - 11 conductor tables.....	387
System of denomination of harmonised cables according to CENELEC HD 361.....	390
UL and VDE marking of cable glands.....	391
Ingress protection (IP) rating according to EN 60529 - CEI 70-1.....	392
Overview of NEMA ratings.....	394
Comparative table of clamping range of cable glands.....	396
Flammability test for products and materials.....	398
Recommended torque settings for cable glands.....	399
Recommended torque settings for entry plugs.....	400
Recommended torque settings for entry thread enlargers and reducers.....	400
Identification & Labelling.....	401
General terms and conditions of sale.....	402

ELECTRICAL CONNECTORS



symbol description

electrical connectors

	Insulation sleeve in Polyvinylchloride		Aluminium connectors of of a purity equal to or greater than 99,5%.
	Insulation sleeve in Polycarbonate		Aldrey connectors
	Insulation sleeve in Nylon PA6.6		Zinc Plated Steel connectors
	Insulation sleeve in Polyethylene High Density		Internal surface is filled with special grease so as to avoid oxidation of the connector
	Heat shrinkable		Low and medium voltage connectors
	Insulation sleeve form to allow easy "introduction" of the conductor		Connector provided with central stop
	Manufactured from electrolytic Copper strip with a purity greater than 99.9%		Colour coded connectors
	Manufactured from Brass strip with a purity greater than 99.9%		Facilitated introduction of the conductor
	Manufactured from electrolytic Copper tube with a purity greater than 99.9%		Inspection hole for checking the correct introduction of the conductor
	Manufactured from electrolytic Copper wire with a purity greater than 99.9%		Contained palm connectors
	Brazed seam		Annealed material
	Brass connectors		Electrolytically tin plated to avoid oxidation; min 3µm
	Bimetallic connectors, Aluminium and Copper.		Lugs angled

symbol description

electrical connectors



Zinc Plated Steel screws



Operating temperature range



Zinc Plated Steel nuts



Degree of protection



Hexagonal crimp



UL LISTING Marking valid in USA & CANADA



Radial crimp



UL LISTING Marking valid in USA & CANADA



Indent crimp



In accordance with DIN 46235



Deep indent crimp



Meets the requirements for fire testing of materials and components for trains EN 45545-2:2015



Oval crimp



Halogen free



Trapezium crimp



Circular crimp



Semicircular crimp



Indent crimp



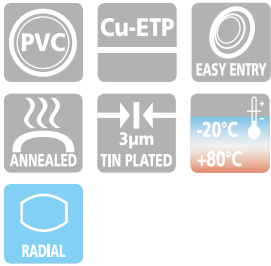

The unique funnel shaped PVC sleeve guarantees total insertion of the conductor strands into the terminal barrel, creating a secure and reliable, electrical and mechanical connection. The internal surface of the barrel is rifled to improve contact with conductor strands when crimped and to increase tensile strength. The "F" range of terminals offers a wide selection of rings, forks, pins and blades, designed to meet the ever changing end user requirements.

The PVC insulation, is a self-extinguishing thermoplastic material class V0 (UL 94). The operating temperature range is -20 to +80°C (Surge +90°C). Recommended crimping tools are shown on pages 188 to 225, 312.



pin terminals

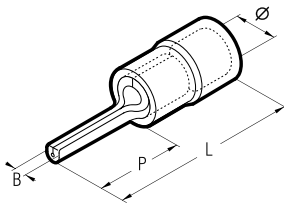

Conductor Size sqmm (AWG)	Type	Dimensions mm				Quantity Box/Bag
		Ø	B	P	L	
0,25÷1,5 (22÷16)	RF-P8	4,0	1,6	8,0	17,8	3.000/100
	RF-P10	4,0	1,6	10,0	19,8	3.000/100
	RF-P12	4,0	1,6	12,0	22,0	3.000/100
1,5÷2,5 (16÷14)	BF-P8	4,9	1,6	8,0	17,8	2.500/100
	BF-P10	4,9	1,6	10,0	19,8	2.500/100
	BF-P12	4,9	1,6	12,0	21,8	2.500/100
4÷6 (12÷10)	GF-P10	6,6	2,2	10,0	24,5	1.000/100
	GF-P12	6,6	2,2	12,0	26,7	1.000/100
	GF-P14	6,6	2,2	14,0	28,7	1.000/100

hooked blade terminals

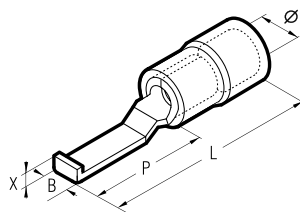

blade terminals

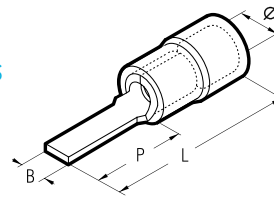

Conductor Size sqmm (AWG)	Type	Dimensions mm				Quantity Box/Bag
		Ø	B	P	L	
0,25÷1,5 (22÷16)	RF-PP12	4,0	3,0	12,8	22,8	3.000/100
	RF-PP12/1	4,0	3,0	11,3	21,3	3.000/100
	RF-PP12/19	4,0	1,9	13,2	23,2	3.000/100
	RF-PP12/23	4,0	2,3	13,2	23,2	2.500/100
	RF-PP14	4,0	3,0	14,8	24,8	2.500/100
	RF-PP16/23	4,0	2,3	17,2	27,2	2.500/100
1,5÷2,5 (16÷14)	BF-PP10	4,9	3,5	10,0	20,0	2.500/100
	BF-PP12	4,9	3,5	12,8	22,8	2.500/100
	BF-PP12/25	4,9	2,5	13,3	23,3	2.000/100
	BF-PP12/29*	4,9	2,9	13,3	23,3	2.500/100
	BF-PP16/25	4,9	2,5	17,2	27,2	2.500/100
	GF-PP12	6,6	4,0	13,3	27,4	1.000/100
4÷6 (12÷10)	GF-PP17	6,6	2,9	19,2	33,3	1.000/100

Conductor Size sqmm (AWG)	Type	Dimensions mm					Quantity Box/Bag
		Ø	B	P	L	X	
0,25÷1,5 (22÷16)	RF-PPL30*	4,0	3,0	17,5	28,3	1,7	2.500/100
	RF-PPL46*	4,0	4,6	17,5	28,3	1,7	2.500/100
1,5÷2,5 (16÷14)	BF-PPL30*	4,9	3,0	17,5	28,3	1,7	2.000/100
	BF-PPL46*	4,9	4,6	17,5	28,3	1,7	2.000/100
4÷6 (12÷10)	GF-PPL46*	6,6	4,6	17,5	32,6	1,9	1.000/100

*Not UL approved

PVC INSULATED CRIMP TERMINALS

RF BF GF

F range funnel entry - for Copper conductors



VALSTAR-N4

Robust plastic case with compartments, containing:

- An assortment of PVC insulated crimp terminals for conductor sizes 0,25 to 6 mm² (22÷10 AWG).
- Cable ties
- Tool Crimpstar® HP3.

Connectors included:

- Qty 100 terminals RF-M4
- Qty 100 terminals BF-M5
- Qty 100 terminals GF-M6
- Qty 100 terminals RF-F608P
- Qty 100 terminals BF-F608P
- Qty 100 connectors PL03-M
- Qty 100 cable ties G100X2.5

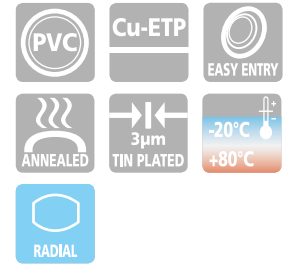

ring terminals

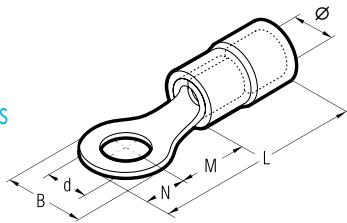

fork/spade terminals

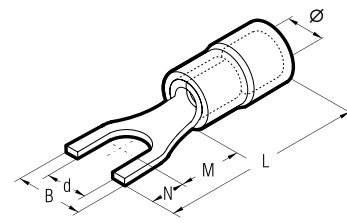

Conductor Size sqmm (AWG)	Ø Stud mm	Type	Dimensions mm						Quantity Box/Bag
			Ø	B	M	N	L	d	
0,25÷1,5 (22÷16)	2	RF-M2**	4,0	5,6	4,5	2,8	17,3	2,2	3.000/100
	3	RF-M3	4,0	5,6	4,5	2,8	17,3	3,2	3.000/100
	3,5	RF-M3.5	4,0	5,6	4,5	2,8	17,3	3,7	3.000/100
	3,5	RF-M3.5/1	4,0	6,2	7,1	3,1	20,2	3,7	3.000/100
	4	RF-M4	4,0	7,0	6,5	3,5	20,0	4,3	3.000/100
	4	RF-M4/3*	4,0	7,8	7,1	3,9	21,0	4,3	3.000/100
	5	RF-M5	4,0	7,8	7,1	3,9	21,0	5,3	2.500/100
	6	RF-M6	4,0	9,4	8,1	4,7	22,8	6,4	2.500/100
	6	RF-M6/1	4,0	12,0	10,3	6,0	26,3	6,4	2.000/100
	7	RF-M7	4,0	9,4	8,1	4,7	22,8	7,2	2.500/100
	8	RF-M8	4,0	12,0	10,3	6,0	26,3	8,4	2.000/100
	10	RF-M10	4,0	15,5	13,0	7,7	30,8	10,5	1.500/100
12	RF-M12	4,0	18,0	15,5	9,0	34,5	13,0	1.500/100	
1,5÷2,5 (16÷14)	2	BF-M2**	4,9	5,6	5,0	2,8	17,8	2,2	3.000/100
	3	BF-M3	4,9	5,6	5,0	2,8	17,8	3,2	2.500/100
	3,5	BF-M3.5	4,9	5,6	5,0	2,8	17,8	3,7	2.500/100
	3,5	BF-M3.5/1	4,9	6,2	6,5	3,1	19,6	3,7	2.500/100
	4	BF-M4	4,9	8,0	6,5	4,0	20,5	4,3	2.500/100
	5	BF-M5	4,9	8,0	7,5	4,0	21,5	5,3	2.000/100
	6	BF-M6	4,9	9,4	8,6	4,7	23,3	6,4	2.000/100
	6	BF-M6/1	4,9	12,0	10,3	6,0	26,3	6,4	2.000/100
	6	BF-M6/2**	4,9	8,4	5,4	4,2	19,6	6,4	2.500/100
	7	BF-M7	4,9	10,0	7,8	5,0	22,8	7,2	2.000/100
	8	BF-M8	4,9	12,0	10,3	6,0	26,3	8,4	1.500/100
	10	BF-M10	4,9	15,5	13,0	7,7	30,8	10,5	1.500/100
12	BF-M12	4,9	18	15,5	9,0	34,5	13,0	1.000/100	
4÷6 (12÷10)	3	GF-M3	6,6	8,0	8,1	4,0	26,2	3,2	1.000/100
	3,5	GF-M3.5	6,6	8,0	8,1	4,0	26,2	3,7	1.000/100
	4	GF-M4	6,6	9,0	8,1	4,5	26,7	4,3	1.000/100
	5	GF-M5	6,6	9,0	8,1	4,5	26,7	5,3	1.000/100
	6	GF-M6	6,6	11,0	11,1	5,5	30,7	6,4	1.000/100
	6	GF-M6/1	6,6	11,0	8,1	5,5	27,7	6,4	1.000/100
	7	GF-M7	6,6	11,0	11,1	5,5	30,7	7,2	1.000/100
	8	GF-M8	6,6	13,6	12,1	6,8	33,0	8,4	800/100
	8	GF-M8/1**	6,6	11,0	8,1	5,5	27,7	8,4	1.000/100
	10	GF-M10	6,6	13,6	12,1	6,8	33,0	10,5	800/100
	10	GF-M10/1	6,6	15,5	13,8	7,7	35,7	10,5	800/100
	12	GF-M12	6,6	19,0	15,1	9,5	38,7	13,0	500/100
14	GF-M14	6,6	21,0	16,1	10,5	40,7	15,0	500/100	
16	GF-M16	6,6	24,0	17,1	12,0	43,2	17,0	500/100	

Conductor Size sqmm (AWG)	Ø Stud mm	Type	Dimensions mm						Quantity Box/Bag
			Ø	B	M	N	L	d	
0,25÷1,5 (22÷16)	3	RF-U3	4,0	5,5	5,5	4,0	19,5	3,2	3.000/100
	3,5	RF-U3.5	4,0	6,0	6,5	3,8	20,3	3,7	3.000/100
	3,5	RF-U3.5/1	4,0	7,2	6,5	3,8	20,3	3,7	3.000/100
	3,5	RF-U3.5/2*	4,0	6,4	6,5	3,8	20,3	3,7	3.000/100
	4	RF-U4	4,0	6,5	7,5	3,7	21,2	4,3	3.000/100
	4	RF-U4/1	4,0	8,5	7,5	3,7	21,2	4,3	3.000/100
	4	RF-U4/2	4,0	7,5	7,5	3,7	21,2	4,3	3.000/100
	5	RF-U5	4,0	8,5	7,5	3,7	21,2	5,3	2.500/100
	5	RF-U5/1**	4,0	9,4	7,5	3,7	21,2	5,3	3.000/100
	6	RF-U6	4,0	9,4	8,1	4,7	22,8	6,4	2.000/100
	6	RF-U6/1	4,0	12,0	9,2	7,1	26,3	6,4	2.000/100
	8	RF-U8	4,0	14,0	10,0	6,3	26,3	8,4	2.000/100
10	RF-U10	4,0	17,5	13,0	7,7	30,8	10,5	1.500/100	
12	RF-U12	4,0	20,0	15,5	9,0	34,5	13,0	1.500/100	
1,5÷2,5 (16÷14)	3	BF-U3	4,9	5,5	5,5	4,0	19,5	3,2	2.500/100
	3,5	BF-U3.5	4,9	6,4	6,5	3,8	20,3	3,7	2.500/100
	3,5	BF-U3.5/1*	4,9	7,2	6,5	3,8	20,3	3,7	3.000/100
	4	BF-U4	4,9	6,5	7,5	3,7	21,2	4,3	3.000/100
	4	BF-U4/1	4,9	8,5	7,5	3,7	21,2	4,3	2.000/100
	4	BF-U4/2	4,9	7,5	7,5	3,7	21,2	4,3	2.000/100
	5	BF-U5	4,9	8,5	7,5	3,7	21,2	5,3	2.000/100
	5	BF-U5/2*	4,9	12,0	11,3	5,0	26,3	5,3	1.500/100
	6	BF-U6	4,9	9,4	8,1	4,7	22,8	6,4	2.000/100
	6	BF-U6/1	4,9	12,0	9,2	7,1	26,3	6,4	2.000/100
	8	BF-U8	4,9	14,0	10,0	6,3	26,3	8,4	1.500/100
	10	BF-U10	4,9	17,5	13,0	7,7	30,8	10,5	1.000/100
12	BF-U12	4,9	20,0	15,5	9,0	34,5	13,0	1.000/100	
4÷6 (12÷10)	3,5	GF-U3.5	6,6	7,5	8,5	3,9	26,5	3,7	1.000/100
	4	GF-U4	6,6	7,5	8,0	4,4	26,5	4,3	1.000/100
	5	GF-U5	6,6	9,5	8,0	4,4	26,5	5,3	1.000/100
	6	GF-U6	6,6	10,0	11,0	5,5	30,6	6,4	1.000/100
	8	GF-U8	6,6	13,5	12,0	8,0	34,1	8,4	800/100
	10	GF-U10	6,6	15,5	13,0	8,0	35,1	10,5	1.000/100
	10	GF-U10/1	6,6	17,5	13,8	7,7	35,7	10,5	1.000/100
	12	GF-U12	6,6	21,0	15,1	9,5	38,7	13,0	500/100
	14	GF-U14	6,6	23,0	16,1	10,5	40,7	15,0	500/100
	16	GF-U16	6,6	26,0	17,1	11,5	42,7	17,0	500/100

*Not UL approved *Made to order

RF-F BF-F GF-F



Brass

* Material: Polycarbonate type PC10500AC certified EN45545-2

FEMALE DISCONNECT TERMINALS

for Copper conductors

Recommended crimping tools are shown on pages 188 to 225, 312.



Polycarbonate* insulated terminals partially reinforced with Copper sleeve

Conductor Size sqmm (AWG)	Type	Tab Size mm	Quantity Box/Bag
0,25÷1,5 (22÷16)	RF-F305	2,8 x 0,5	3.000/100
	RF-F308*	2,8 x 0,8	3.000/100
	RF-F405	4,8 x 0,5	2.500/100
	RF-F408	4,8 x 0,8	2.500/100
1,5÷2,5 (16÷14)	RF-F608	6,35 x 0,8	2.500/100
	BF-F405	4,8 x 0,5	2.500/100
	BF-F408	4,8 x 0,8	2.500/100
4÷6 (12÷10)	GF-F608	6,35 x 0,8	1.000/100

Polycarbonate* fully insulated terminals partially reinforced with Copper sleeve

Conductor Size sqmm (AWG)	Type	Tab Size mm	Quantity Box/Bag
0,25÷1,5 (22÷16)	RF-F305P	2,8 x 0,5	2.000/100
	RF-F308P*	2,8 x 0,8	2.000/100
	RF-F405P	4,8 x 0,5	1.500/100
	RF-F408P	4,8 x 0,8	1.500/100
1,5÷2,5 (16÷14)	RF-F608P	6,35 x 0,8	1.000/100
	BF-F405P	4,8 x 0,5	1.500/100
	BF-F408P	4,8 x 0,8	1.500/100
4÷6 (12÷10)	GF-F608P	6,35 x 0,8	800/100

RF-M BF-M GF-M



Brass

* Material: Polycarbonate type PC10500AC certified EN45545-2

MALE DISCONNECT TERMINALS

for Copper conductors

Recommended crimping tools are shown on pages 188 to 225, 312.



Polycarbonate* insulated terminals partially reinforced with Copper sleeve

Conductor Size sqmm (AWG)	Type	Tab Size mm	Quantity Box/Bag
0,25÷1,5 (22÷16)	RF-M608	6,35 x 0,8	3.000/100
1,5÷2,5 (16÷14)	BF-M608	6,35 x 0,8	2.000/100
4÷6 (12÷10)	GF-M608	6,35 x 0,8	1.000/100

Polycarbonate* fully insulated terminals partially reinforced with Copper sleeve

Conductor Size sqmm (AWG)	Type	Tab Size mm	Quantity Box/Bag
0,25÷1,5 (22÷16)	RF-M608P	6,35 x 0,8	1.000/100
1,5÷2,5 (16÷14)	BF-M608P	6,35 x 0,8	800/100

RF-FM BF-FM RF-B BF-B



Brass

* Material: Polycarbonate type PC10500AC certified EN45545-2

MALE/FEMALE BULLET AND SOCKET

for Copper conductors

Recommended crimping tools are shown on pages 188 to 225, 312.



Polycarbonate* insulated terminals partially reinforced with Copper sleeve

Conductor Size sqmm (AWG)	Type	Tab Size mm	Quantity Box/Bag
0,25÷1,5 (22÷16)	RF-FM608	6,35 x 0,8	1.000/100
1,5÷2,5 (16÷14)	BF-FM608	6,35 x 0,8	1.000/100

Polycarbonate* insulated terminals partially reinforced with Copper sleeve

Conductor Size sqmm (AWG)	Type	Ø mm	Quantity Box/Bag
0,25÷1,5 (22÷16)	RF-BM4*	4,0	2.500/100
	RF-BF4*	3,95	800/100
1,5÷2,5 (16÷14)	BF-BM5*	5,0	2.000/100
	BF-BF5*	4,95	800/100

*Not UL approved

BUTT AND PARALLEL CONNECTORS

for Copper conductors



butt connectors

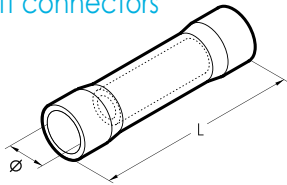

parallel connectors

Recommended crimping tools are shown on pages 188 to 225, 312.

PVC insulated

Conductor Size sqmm (AWG)	Type	Ø mm	L mm	Quantity Box/Bag
0,2÷0,5 (24÷20)	PL01-M*	3,0	25,0	3.000/100
0,25÷1,5 (22÷16)	PL03-M	4,0	25,0	1.000/100
1,5÷2,5 (16÷14)	PL06-M	5,0	25,0	1.500/100
4÷6 (12÷10)	PL1-M	6,5	32,0	500/100
0,25÷1,5 (22÷16)	PL03-P*	4,0	20,0	3.000/100
1,5÷2,5 (16÷14)	PL06-P*	5,0	16,0	2.000/100

PL

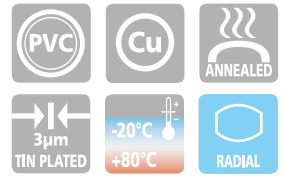

BUTT CONNECTORS

for Copper conductors

Recommended crimping tools are shown on pages 188 to 225, 312.

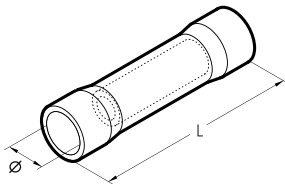

Polyamide PA6.6 insulated

Conductor Size sqmm (AWG)	Type	Ø mm	L mm	Quantity Box/Bag
0,25÷1,5 (22÷16)	NL03-M	4,0	25,0	1.000/100
1,5÷2,5 (16÷14)	NL06-M	5,4	25,5	1.500/100
4÷6 (12÷10)	NL1-M	7,6	32,0	500/100
10 (8÷7)	NL2-M	8,0	43,0	500/100
16 (6÷5)	NL3-M	9,2	44,0	400/100

NL-M



HF
HALOGEN
FREE

Recommended crimping tools are shown on pages 172, 184-185.

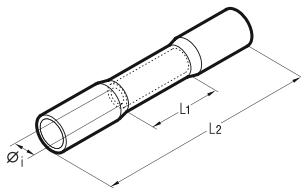

PE HD insulated, heat shrinkable

Conductor Size sqmm (AWG)	Type	Ø mm	L1 mm	L2 mm	Quantity Box/Bag
0,5÷1,5 (20÷16)	WL03-M	1,7	15,0	36,0	1.500/100
1,5÷2,5 (16÷14)	WL06-M	2,3	15,0	36,0	1.000/100
4÷6 (12÷10)	WL1-M	3,5	15,0	41,0	500/100

- Max operating voltage: 600 V
- Shrink temperature: 150 °C
- Protection: IP68

WL-M



CLOSE END CONNECTORS

for Copper conductors

Recommended crimping tools are shown on pages 188 to 225, 312.

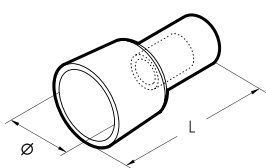

Polyamide PA6.6 insulated

Conductor Size sqmm (AWG)	Type	Ø mm	L mm	Quantity Box/Bag
0,25÷1,5 (22÷16)	NL03-P	7,9	21,0	1.000/100
1,5÷2,5 (16÷14)	NL06-P	7,9	19,9	1.000/100
4÷6 (12÷10)	NL06-PB	6,5	13,6	1.500/100
	NL1-P	10,5	21,5	500/100
	NL1-PG	9,0	17,8	1.000/100

NL-P



*Not UL approved

VP RP BP GP

HALOGEN FREE INSULATED TERMINALS

P range funnel entry - for Copper conductors

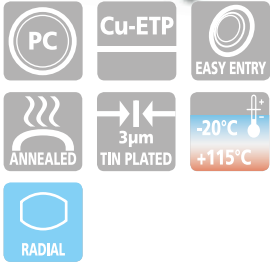

The "P" range of terminals has been designed, to meet the increasing demands for improved safety and reliability of electrical connectors.

The Polycarbonate insulation type PC10500AC certified EN45545-2, is a Halogen free, self extinguishing thermoplastic material class V0 (UL 94). The unique funnel shaped entry of the insulation sleeve, guarantees total insertion of the con-

ductor strands into the terminal barrel, creating a secure and reliable, electrical and mechanical connection.

The operating temperature range is -20 to +115°C (Surge +130°C).

Recommended crimping tools are shown on pages 188 to 225, 312.



pin terminals

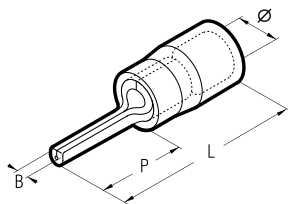

Conductor Size sqmm (AWG)	Type	Dimensions mm				Quantity Box/Bag
		Ø	B	P	L	
0,2÷0,5 (24÷20)	VP-P10	3,0	1,0	9,8	20,2	4.000/100
0,25÷1,5 (22÷16)	RP-P8	4,0	1,6	7,8	17,9	3.000/100
	RP-P10	4,0	1,6	9,8	19,9	3.000/100
1,5÷2,5 (16÷14)	RP-P12	4,0	1,6	12,0	22,1	3.000/100
	BP-P8	4,9	1,6	7,8	17,9	3.000/100
4÷6 (12÷10)	BP-P10	4,9	1,6	9,8	19,9	3.000/100
	BP-P12	4,9	1,6	11,8	21,9	2.500/100
4÷6 (12÷10)	GP-P10	6,6	2,2	10,4	24,5	1.000/100
	GP-P12	6,6	2,2	12,6	26,7	1.000/100
	GP-P14	6,6	2,2	14,6	28,7	1.000/100

blade terminals

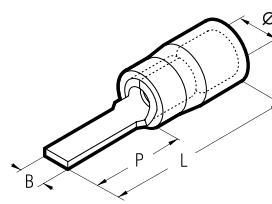

Conductor Size sqmm (AWG)	Type	Dimensions mm				Quantity Box/Bag
		Ø	B	P	L	
0,2÷0,5 (24÷20)	VP-PP12/19	3,0	1,9	12,4	22,4	4.000/100
0,25÷1,5 (22÷16)	RP-PP12	4,0	3,0	12,8	22,9	3.000/100
	RP-PP12/1	4,0	3,0	11,3	21,4	3.000/100
	RP-PP12/19	4,0	1,9	13,2	23,3	3.000/100
	RP-PP12/23	4,0	2,3	13,2	23,3	2.500/100
	RP-PP14	4,0	3,0	14,8	24,9	2.500/100
	RP-PP16/23	4,0	2,3	17,2	27,3	2.500/100
1,5÷2,5 (16÷14)	BP-PP12	4,9	3,5	12,8	22,9	2.500/100
	BP-PP12/25	4,9	2,5	13,3	23,4	2.000/100
	BP-PP12/29	4,9	2,9	13,3	23,4	2.500/100
	BP-PP16/25	4,9	2,5	17,2	27,3	2.500/100
4÷6 (12÷10)	GP-PP12	6,6	4,0	13,3	27,4	1.000/100
	GP-PP17	6,6	2,9	19,1	33,2	1.000/100

hooked blade terminals

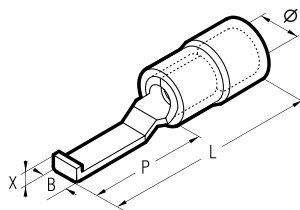

Conductor Size sqmm (AWG)	Type	Dimensions mm					Quantity Box/Bag
		Ø	B	P	L	X	
0,25÷1,5 (22÷16)	RP-PPL30	4,0	3,0	17,5	28,3	1,7	3.000/100
	RP-PPL46	4,0	4,6	17,5	28,3	1,7	3.000/100
1,5÷2,5 (16÷14)	BP-PPL30	4,9	3,0	17,5	28,3	1,7	2.500/100
	BP-PPL46	4,9	4,6	17,5	28,8	1,7	2.500/100
4÷6 (12÷10)	GP-PPL46	6,6	4,6	17,5	32,6	1,9	1.000/100

*Not UL approved

HALOGEN FREE INSULATED TERMINALS

P range funnel entry - for Copper conductors

VP RP
BP GP

ring terminals

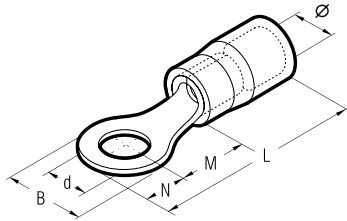

fork/spade terminals

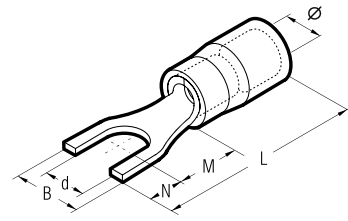

Cond. Size sqmm (AWG)	Ø Stud mm	Type	Dimensions mm						Quantity Box/Bag
			Ø	B	M	N	L	d	
0,25÷0,5 (24÷20)	3,0	2 VP-M2*	3,0	5,6	4,5	2,8	17,5	2,2	4.000/100
		3 VP-M3	3,0	5,6	4,5	2,8	17,5	3,2	4.000/100
		3,5 VP-M3.5	3,0	5,6	4,5	2,8	17,5	3,7	4.000/100
		4 VP-M4	3,0	7,0	6,5	3,5	20,2	4,3	4.000/100
		5 VP-M5	3,0	7,8	7,1	3,9	21,2	5,3	4.000/100
		6 VP-M6*	3,0	9,4	8,1	4,7	23,0	6,4	4.000/100
0,25÷1,5 (22÷16)	4,0	2 RP-M2*	4,0	5,6	4,5	2,8	17,4	2,2	3.000/100
		3 RP-M3	4,0	5,6	4,5	2,8	17,4	3,2	3.000/100
		3,5 RP-M3.5	4,0	5,6	4,5	2,8	17,4	3,7	3.000/100
		3,5 RP-M3.5/1	4,0	6,2	7,1	3,1	20,2	3,7	3.000/100
		4 RP-M4	4,0	7,0	6,5	3,5	20,1	4,3	3.000/100
		4 RP-M4/3	4,0	7,8	7,1	3,9	21,1	4,3	3.000/100
		5 RP-M5	4,0	7,8	7,1	3,9	21,1	5,3	2.500/100
		6 RP-M6	4,0	9,4	8,1	4,7	22,9	6,4	2.500/100
		6 RP-M6/1	4,0	12,0	10,3	6,0	26,4	6,4	2.000/100
		7 RP-M7	4,0	9,4	8,1	4,7	22,9	7,2	2.500/100
		8 RP-M8	4,0	12,0	10,3	6,0	26,4	8,4	2.500/100
		10 RP-M10	4,0	15,5	13,0	7,7	30,9	10,5	1.500/100
12 RP-M12	4,0	18,0	15,5	9,0	34,6	13,0	1.500/100		
1,5÷2,5 (16÷14)	4,9	2 BP-M2*	4,9	5,6	5,0	2,8	17,9	2,2	2.500/100
		3 BP-M3	4,9	5,6	5,0	2,8	17,9	3,2	2.500/100
		3,5 BP-M3.5	4,9	5,6	5,0	2,8	17,9	3,7	3.000/100
		3,5 BP-M3.5/1	4,9	6,2	6,5	3,1	19,7	3,7	2.500/100
		4 BP-M4	4,9	8,0	6,5	4,0	20,6	4,3	2.500/100
		5 BP-M5	4,9	8,0	7,5	4,0	21,6	5,3	2.000/100
		6 BP-M6	4,9	9,4	8,6	4,7	23,4	6,4	2.000/100
		6 BP-M6/1	4,9	12,0	10,3	6,0	26,4	6,4	2.000/100
		6 BP-M6/2*	4,9	8,4	5,4	4,2	19,7	6,4	2.500/100
		7 BP-M7	4,9	10,0	7,8	5,0	22,9	7,2	2.500/100
		8 BP-M8	4,9	12,0	10,3	6,0	26,4	8,4	1.500/100
		10 BP-M10	4,9	15,5	13,0	7,7	30,9	10,5	1.500/100
12 BP-M12	4,9	18,0	15,5	9,0	34,6	13,0	1.000/100		
4÷6 (12÷10)	6,6	3 GP-M3	6,6	8,0	8,1	4,0	26,2	3,2	1.000/100
		3,5 GP-M3.5	6,6	8,0	8,1	4,0	26,2	3,7	1.500/100
		4 GP-M4	6,6	9,0	8,1	4,5	26,7	4,3	1.000/100
		5 GP-M5	6,6	9,0	8,1	4,5	26,7	5,3	1.000/100
		6 GP-M6	6,6	11,0	11,1	5,5	30,7	6,4	1.000/100
		6 GP-M6/1	6,6	11,0	11,1	5,5	27,7	6,4	1.000/100
		7 GP-M7	6,6	11,0	11,1	5,5	30,7	7,2	1.000/100
		8 GP-M8	6,6	13,6	12,1	6,8	33,0	8,4	800/100
		8 GP-M8/1*	6,6	11,0	8,1	5,5	27,7	8,4	1.000/100
		10 GP-M10	6,6	13,6	12,1	6,8	33,0	10,5	1.000/100
		10 GP-M10/1	6,6	15,5	13,8	7,7	35,7	10,5	1.000/100
		12 GP-M12	6,6	19,0	15,1	9,5	38,7	13,0	500/100
		14 GP-M14	6,6	21,0	16,1	10,5	40,7	15,0	500/100
		16 GP-M16	6,6	24,0	17,1	12,0	43,2	17,0	500/100

Cond. Size sqmm (AWG)	Ø Stud mm	Type	Dimensions mm						Quantity Box/Bag		
			Ø	B	M	N	L	d			
0,2÷0,5 (24÷20)	3,0	3 VP-U3	3,0	5,5	5,5	4,0	18,7	3,2	4.000/100		
		3,5 VP-U3.5	3,0	6,0	6,5	3,8	19,5	3,7	4.000/100		
		4 VP-U4	3,0	6,5	7,5	3,7	20,4	4,3	4.000/100		
		3 RP-U3	4,0	5,5	5,5	4,0	19,6	3,2	3.000/100		
0,25÷1,5 (22÷16)	4,0	3,5 RP-U3.5	4,0	6,0	6,5	3,8	20,4	3,7	3.000/100		
		3,5 RP-U3.5/2	4,0	6,4	6,5	3,8	20,4	3,7	3.000/100		
		4 RP-U4	4,0	6,5	7,5	3,7	21,3	4,3	3.000/100		
		4 RP-U4/1	4,0	8,5	7,5	3,7	21,3	4,3	3.000/100		
		4 RP-U4/2	4,0	7,5	7,5	3,7	21,3	4,3	3.500/100		
		5 RP-U5	4,0	8,5	7,5	3,7	21,3	5,3	3.000/100		
		5 RP-U5/1*	4,0	9,4	7,5	3,7	21,3	5,3	3.000/100		
		6 RP-U6	4,0	9,4	8,1	4,7	22,9	6,4	2.000/100		
		6 RP-U6/1	4,0	12,0	9,2	7,1	26,4	6,4	2.000/100		
		8 RP-U8	4,0	14,0	10,0	6,3	26,4	8,4	2.000/100		
		10 RP-U10	4,0	17,5	13,0	7,7	30,9	10,5	1.500/100		
		12 RP-U12	4,0	20,0	15,5	9,0	34,6	13,0	1.500/100		
		1,5÷2,5 (16÷14)	4,9	3 BP-U3	4,9	5,5	5,5	4,0	19,6	3,2	2.500/100
				3,5 BP-U3.5	4,9	6,4	6,5	3,8	20,4	3,7	2.500/100
				3,5 BP-U3.5/1*	4,9	7,2	6,5	3,8	20,4	3,7	2.500/100
				4 BP-U4	4,9	6,5	7,5	3,7	21,3	4,3	2.500/100
4 BP-U4/1	4,9			8,5	7,5	3,7	21,3	4,3	3.000/100		
4 BP-U4/2	4,9			7,5	7,5	3,7	21,3	4,3	2.000/100		
5 BP-U5	4,9			8,5	7,5	3,7	21,3	5,3	2.000/100		
6 BP-U6	4,9			9,4	8,1	4,7	22,9	6,4	2.000/100		
6 BP-U6/1	4,9			12,0	9,2	7,1	26,4	6,4	2.000/100		
8 BP-U8	4,9			14,0	10,0	6,3	26,4	8,4	1.500/100		
10 BP-U10	4,9			17,5	13,0	7,7	30,9	10,5	1.000/100		
12 BP-U12	4,9			20	15,5	9,0	34,6	13,0	1.500/100		
4÷6 (12÷10)	6,6			3,5 GP-U3.5	6,6	7,5	8,5	3,9	26,5	3,7	1.000/100
				4 GP-U4	6,6	7,5	8,0	4,4	26,5	4,3	1.000/100
				5 GP-U5	6,6	9,5	8,0	4,4	26,5	5,3	1.000/100
				6 GP-U6	6,6	10,0	11,0	5,5	30,6	6,4	1.000/100
		8 GP-U8	6,6	13,5	12,0	8,0	34,1	8,4	1.000/100		
		10 GP-U10	6,6	15,5	13,0	8,0	35,1	10,5	1.000/100		
		10 GP-U10/1	6,6	17,5	13,8	7,7	35,7	10,5	1.000/100		
		12 GP-U12	6,6	21,0	15,1	9,5	38,7	13,0	500/100		
		14 GP-U14	6,6	23,0	16,1	10,5	40,7	15,0	500/100		
		16 GP-U16	6,6	26,0	17,1	11,5	42,7	17,0	500/100		

*Made to order

CRP CBP CGP

INSULATED CHAIN TERMINALS

CP range with easy entry - for Copper conductors



The "CP" range of terminals has been designed to meet the increasing demands for improved safety and reliability of electrical connectors. Developed for use with production equipment, to give a quick and reliable crimped joint, the Polycarbonate insulation type PC10500AC certified EN45545-2, is a Halogen free, self extinguishing thermoplastic material class V0 (UL 94). The unique funnel shaped entry of the insulation sleeve guarantees

strands into the terminal barrel, creating a secure and reliable, electrical and mechanical connection. The operating temperature range is -20 to +115°C (Surge +130°C).

stands into the terminal barrel, creating a secure and reliable, electrical and mechanical connection. The operating temperature range is -20 to +115°C (Surge +130°C).



- PC**
- Cu-ETP**
- EASY ENTRY**
- EN 45545-2**
- HF HALOGEN FREE**
- ANNEALED**
- 3µm TIN PLATED**
- 20°C to +115°C**
- RADIAL**

pin terminals

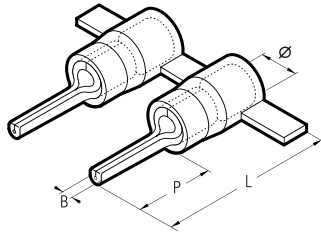

Conductor Size sqmm (AWG)	Type	Dimensions mm				Quantity
		Ø	B	P	L	
0,25÷1,5 (22÷16)	CRP-P8	4,0	1,6	8,0	17,9	2.000
	CRP-P10	4,0	1,6	10,0	19,9	2.000
	CRP-P12	4,0	1,6	12,0	22,1	2.000
1,5÷2,5 (16÷14)	CBP-P8	4,9	1,6	8,0	17,9	1.750
	CBP-P10	4,9	1,6	10,0	19,9	1.750
	CBP-P12	4,9	1,6	12,0	21,9	1.750
4÷6 (12÷10)	CGP-P10	6,6	2,2	10,0	24,5	1.250
	CGP-P12	6,6	2,2	12,0	26,7	1.250
	CGP-P14	6,6	2,2	14,0	28,7	1.250

blade terminals

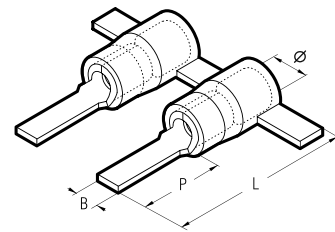

Conductor Size sqmm (AWG)	Type	Dimensions mm				Quantity
		Ø	B	P	L	
0,25÷1,5 (22÷16)	CRP-PP12	4,0	3,0	12,8	22,9	2.000
	CRP-PP12/1*	4,0	3,0	11,3	21,4	2.000
	CRP-PP12/23*	4,0	2,3	13,2	23,3	2.000
	CRP-PP14	4,0	3,0	14,8	24,9	2.000
1,5÷2,5 (16÷14)	CBP-PP12	4,9	3,5	12,8	22,9	1.750
	CBP-PP12/25*	4,9	2,5	13,3	23,4	1.750
4÷6 (12÷10)	CGP-PP12	6,6	4,0	13,3	27,4	1.250
CGP-PP17*	6,6	2,9	19,1	33,2	1.250	

male disconnect terminals

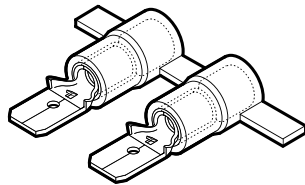

Conductor Size sqmm (AWG)	Type	Tab Size mm	Quantity
0,25÷1,5 (22÷16)	CRP-M608	6,35 x 0,8	2.000
1,5÷2,5 (16÷14)	CBP-M608	6,35 x 0,8	1.750
4÷6 (12÷10)	CGP-M608	6,35 x 0,8	1.250

female disconnect terminals

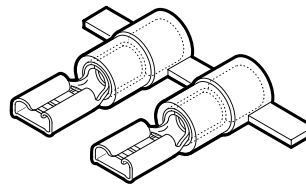

Conductor Size sqmm (AWG)	Type	Tab Size mm	Quantity
0,25÷1,5 (22÷16)	CRP-F305	2,8 x 0,5	2.000
	CRP-F308	2,8 x 0,8	2.000
	CRP-F405	4,8 x 0,5	2.000
	CRP-F408	4,8 x 0,8	2.000
	CRP-F608	6,35 x 0,8	2.000
1,5÷2,5 (16÷14)	CBP-F405	4,8 x 0,5	1.750
	CBP-F408	4,8 x 0,8	1.750
	CBP-F608	6,35 x 0,8	1.750
4÷6 (12÷10)	CGP-F608	6,35 x 0,8	1.250

female disconnect terminals fully insulated

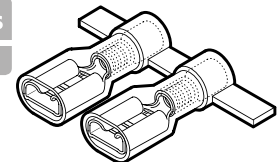

Conductor Size sqmm (AWG)	Type	Tab Size mm	Quantity
0,25÷1,5 (22÷16)	CRP-F405P*	4,8 x 0,5	2.000
	CRP-F408P*	4,8 x 0,8	2.000
	CRP-F608P*	6,35 x 0,8	1.500
1,5÷2,5 (16÷14)	CBP-F408P*	4,8 x 0,8	1.500
	CBP-F608P*	6,35 x 0,8	1.500
4÷6 (12÷10)	CGP-F608P*	6,35 x 0,8	1.250

*Not UL approved *Made to order

INSULATED CHAIN TERMINALS

CP range with easy entry - for Copper conductors

CRP CBP CGP

fork/spade terminals

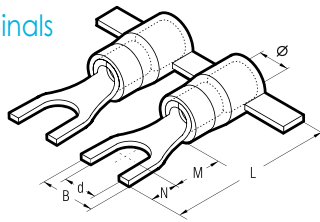

Cond. Size sqmm (AWG)	Ø Stud mm	Type	Dimensions mm					Quantity	
			Ø	B	M	N	L		d
0,25÷1,5 (22÷16)	3	CRP-U3	4,0	5,5	5,5	4,0	19,6	3,2	2.000
	3,5	CRP-U3.5	4,0	6,0	6,5	3,8	20,4	3,7	2.000
	3,5	CRP-U3.5/2*	4,0	6,4	6,5	3,8	20,4	3,7	2.000
	4	CRP-U4	4,0	6,5	7,5	3,7	21,3	4,3	2.000
	4	CRP-U4/1*	4,0	8,5	7,5	3,7	21,3	4,3	2.000
	4	CRP-U4/2*	4,0	7,5	7,5	3,7	21,3	4,3	2.000
	5	CRP-U5	4,0	8,5	7,5	3,7	21,3	5,3	2.000
	6	CRP-U6	4,0	9,4	8,1	4,7	22,9	6,4	2.000
1,5÷2,5 (16÷14)	6	CRP-U6/1*	4,0	12,0	9,2	7,1	26,4	6,4	2.000
	8	CRP-U8*	4,0	14,0	10,0	6,3	26,4	8,4	2.000
	3	CBP-U3	4,9	5,5	5,5	4,0	19,6	3,2	1.750
	3,5	CBP-U3.5	4,9	6,4	6,5	3,8	20,4	3,7	1.750
	4	CBP-U4	4,9	6,5	7,5	3,7	21,3	4,3	1.750
	4	CBP-U4/1*	4,9	8,5	7,5	3,7	21,3	4,3	1.750
4÷6 (12÷10)	4	CBP-U4/2*	4,9	7,5	7,5	3,7	21,3	4,3	1.750
	5	CBP-U5	4,9	8,5	7,5	3,7	21,3	5,3	1.750
	6	CBP-U6	4,9	9,4	8,1	4,7	22,9	6,4	1.750
	3,5	CGP-U3.5*	6,6	7,5	8,5	3,9	26,5	3,7	1.250
4	CGP-U4*	6,6	7,5	8,0	4,4	26,5	4,3	1.250	
5	CGP-U5	6,6	9,5	8,0	4,4	26,5	5,3	1.250	
6	CGP-U6	6,6	10,0	11,0	5,5	30,6	6,4	1.250	

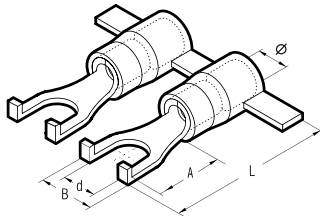

Cond. Size sqmm (AWG)	Ø Stud mm	Type	Dimensions mm					Quantity
			Ø	B	A	L	d	
1,5÷2,5 (16÷14)	4	CBP-U 4/3L*	4,9	6,5	9,5	14,5	4,3	1.750

hooked blade terminals

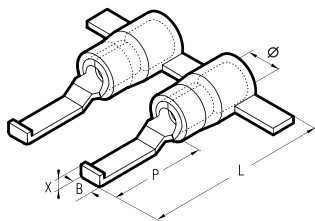

Cond. Size sqmm (AWG)	Type	Dimensions mm					Quantity
		Ø	B	P	L	X	
0,25÷1,5 (22÷16)	CRP-PPL30*	4,0	3,0	17,5	28,8	1,7	2.000
1,5÷2,5 (16÷14)	CBP-PPL30*	4,9	3,0	17,5	28,8	1,7	1.750

ring terminals

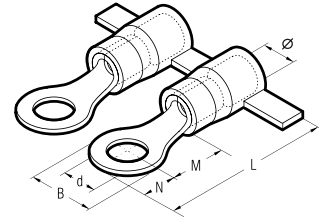

Cond. Size sqmm (AWG)	Ø Stud mm	Type	Dimensions mm					Quantity	
			Ø	B	M	N	L		d
0,25÷1,5 (22÷16)	3	CRP-M3	4,0	5,6	4,5	2,8	17,4	3,2	2.000
	3,5	CRP-M3.5*	4,0	5,6	4,5	2,8	17,4	3,7	2.000
	3,5	CRP-M3.5/1	4,0	6,2	7,1	3,1	20,2	3,7	2.000
	4	CRP-M4	4,0	7,0	6,5	3,5	20,1	4,3	2.000
	4	CRP-M4/3*	4,0	7,8	7,1	3,9	21,1	4,3	2.000
	5	CRP-M5	4,0	7,8	7,1	3,9	21,1	5,3	2.000
	6	CRP-M6	4,0	9,4	8,1	4,7	22,9	6,4	2.000
	6	CRP-M6/1*	4,0	12,0	10,3	6,0	26,4	6,4	2.000
1,5÷2,5 (16÷14)	7	CRP-M7	4,0	9,4	8,1	4,7	22,9	7,2	2.000
	8	CRP-M8	4,0	12,0	10,3	6,0	26,4	8,4	2.000
	3	CBP-M3	4,9	5,6	5,0	2,8	17,9	3,2	1.750
	3,5	CBP-M3.5	4,9	5,6	5,0	2,8	17,9	3,7	1.750
	3,5	CBP-M3.5/1*	4,9	6,2	6,5	3,1	19,6	3,7	1.750
	4	CBP-M4	4,9	8,0	6,5	4,0	20,6	4,3	1.750
	5	CBP-M5	4,9	8,0	7,5	4,0	21,6	5,3	1.750
	6	CBP-M6	4,9	9,4	8,6	4,7	23,4	6,4	1.750
4÷6 (12÷10)	6	CBP-M6/1*	4,9	12,0	10,3	6,0	26,4	6,4	1.750
	7	CBP-M7	4,9	10,0	7,8	5,0	22,9	7,2	1.750
	8	CBP-M8	4,9	12,0	10,3	6,0	26,4	8,4	1.750
	3	CGP-M3	6,6	8,0	8,1	4,0	26,2	3,2	1.250
	3,5	CGP-M3.5	6,6	8,0	8,1	4,0	26,2	3,7	1.250
	4	CGP-M4	6,6	9,0	8,1	4,5	26,7	4,3	1.250
	5	CGP-M5	6,6	9,0	8,1	4,5	26,7	5,3	1.250
	6	CGP-M6	6,6	11,0	11,1	5,5	30,7	6,4	1.250
	6	CGP-M6/1*	6,6	11,0	8,1	5,5	27,7	6,4	1.250
	7	CGP-M7	6,6	11,0	11,1	5,5	30,7	7,2	1.000
8	CGP-M8	6,6	13,6	12,1	6,8	33,0	8,4	1.250	
8	CGP-M8/1*	6,6	11,0	8,1	5,5	27,7	8,4	1.250	
10	CGP-M10	6,6	13,6	12,1	6,8	33,0	10,5	1.250	

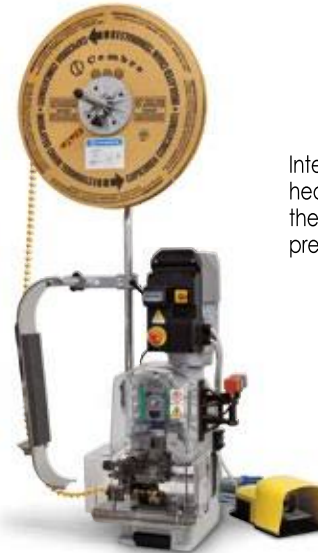

Interchangeable application heads are available for crimping these terminals with the bench press ELB-3 (see page 228).

*Not UL approved *Made to order

RKY BKY GKY

REINFORCED PA 6.6 INSULATED TERMINALS

KY range - for Copper conductors

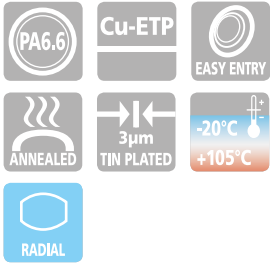

'KY' type terminals are designed to offer improved mechanical and electrical integrity under heavy-duty application. This is achieved via a Copper sleeve located between the Copper barrel and Polyamide insulation (type PA10180 certified EN45545-2) of the terminal. Then, during crimping, the insulation of the conductor is integrated into the crimp due to the Copper sleeve being deformed around it to maintain the level of 'grip' required in applications subject to continuous mechanical vibrations (e.g: mobile plant, vehicles, moving components).

The operating temperature range is -20 to +105°C (Surge +110°C). Recommended crimping tools are shown on pages 188 to 225, 312.



pin terminals

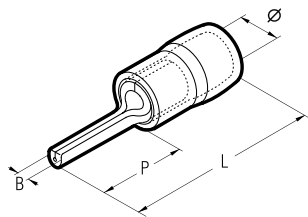

Conductor Size sqmm (AWG)	Type	Dimensions mm				Quantity Box/Bag
		Ø	B	P	L	
0,25÷1,5 (22÷16)	RKY-P8	4,5	1,9	9,0	19,8	3.000/100
	RKY-P10	4,5	1,9	10,0	20,8	3.500/100
	RKY-P12	4,5	1,9	12,0	22,8	3.000/100
1,5÷2,5 (16÷14)	BKY-P8	5,2	1,9	9,0	19,8	3.000/100
	BKY-P10	5,2	1,9	10,0	20,8	3.000/100
	BKY-P12	5,2	1,9	12,0	22,8	3.000/100
4÷6 (12÷10)	GKY-P14	7,0	2,8	14,0	27,0	1.000/100

blade terminals

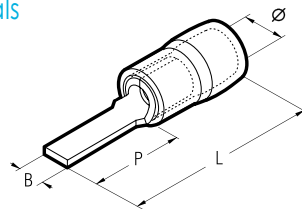

Conductor Size sqmm (AWG)	Type	Dimensions mm				Quantity Box/Bag
		Ø	B	P	L	
0,25÷1,5 (22÷16)	RKY-PP12	4,5	3,0	13,0	23,8	3.000/100
	RKY-PP12/19	4,5	2,0	18,0	28,8	3.000/100
	RKY-PP16/23	4,5	2,2	18,0	28,8	2.500/100
1,5÷2,5 (16÷14)	BKY-PP12	5,2	3,0	13,0	23,8	2.500/100
	BKY-PP12/25	5,2	2,4	13,0	23,8	2.000/100
	BKY-PP16/23	5,2	2,2	18,0	28,8	2.500/100
4÷6 (12÷10)	GKY-PP12	7,0	4,0	14,0	27,0	1.000/100
	GKY-PP17	7,0	2,0	18,0	31,0	1.000/100

hooked blade terminals

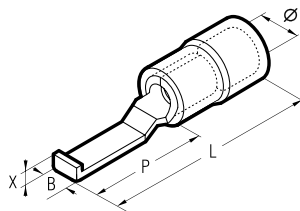

Conductor Size sqmm (AWG)	Type	Dimensions mm					Quantity Box/Bag
		Ø	B	P	L	X	
0,25÷1,5 (22÷16)	RKY-PPL30	4,5	3,0	16,8	28,2	2,1	3.000/100
	RKY-PPL46	4,5	4,6	16,8	28,2	2,1	3.000/100
1,5÷2,5 (16÷14)	BKY-PPL30	5,2	3,0	16,8	28,2	2,1	2.500/100
	BKY-PPL46	5,2	4,6	16,8	28,2	2,1	2.500/100
4÷6 (12÷10)	GKY-PPL46	7,0	4,6	17,2	30,2	2,4	1.000/100

Consult CEMBRE for a wider range of pin and blade dimensions.

REINFORCED PA 6.6 INSULATED TERMINALS

KY range - for Copper conductors

RKY BKY GKY

ring terminals

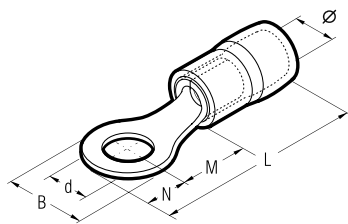

Cond. Size sqmm (AWG)	Ø Stud mm	Type	Dimensions mm						Quantity Box/Bag
			Ø	B	M	N	L	d	
0,25÷1,5 (22÷16)	3	RKY-M3	4,5	5,5	5,0	2,5	18,5	3,2	3.000/100
	3,5	RKY-M3.5	4,5	5,5	5,0	2,5	18,5	3,7	3.000/100
	3,5	RKY-M3.5/1	4,5	6,6	6,3	3,1	20,4	3,7	3.000/100
	4	RKY-M4	4,5	6,6	6,3	3,1	20,4	4,3	3.000/100
	5	RKY-M5	4,5	8,0	7,0	3,8	21,8	5,3	2.500/100
	6	RKY-M6/1	4,5	11,6	11,0	5,8	27,8	6,4	2.000/100
	8	RKY-M8	4,5	11,6	11,0	5,8	27,8	8,4	2.500/100
	10	RKY-M10	4,5	13,6	13,9	6,6	31,5	10,5	1.500/100
	12	RKY-M12	4,5	19,6	16,0	9,4	36,4	13,0	1.500/100
	3	BKY-M3	5,2	6,6	4,8	3,0	18,8	3,2	2.500/100
	3,5	BKY-M3.5	5,2	6,6	4,8	3,0	18,8	3,7	2.500/100
	3,5	BKY-M3.5/1	5,2	6,6	6,3	3,1	20,4	3,7	2.500/100
1,5÷2,5 (16÷14)	4	BKY-M4	5,2	8,5	7,8	4,0	22,8	4,3	2.500/100
	5	BKY-M5	5,2	8,5	7,8	4,0	22,8	5,3	2.500/100
	6	BKY-M6/1	5,2	12,0	11,0	5,8	27,8	6,4	2.000/100
	8	BKY-M8	5,2	12,0	11,0	5,8	27,8	8,4	1.500/100
	10	BKY-M10	5,2	13,6	13,9	6,6	31,5	10,5	1.500/100
	12	BKY-M12	5,2	19,2	16,0	9,4	36,4	13,0	1.000/100
4÷6 (12÷10)	3,5	GKY-M3.5	7,0	7,2	6,1	3,6	22,7	3,7	1.000/100
	4	GKY-M4	7,0	9,5	9,1	4,5	26,6	4,3	1.000/100
	5	GKY-M5	7,0	9,5	9,1	4,5	26,6	5,3	1.000/100
	6	GKY-M6	7,0	12,0	10,5	6,0	29,5	6,4	1.000/100
	8	GKY-M8	7,0	15,0	13,5	7,5	34,0	8,4	1.000/100
	10	GKY-M10	7,0	15,0	13,5	7,5	34,0	10,5	1.000/100
	12	GKY-M12	7,0	19,2	16,0	9,6	38,6	13,0	1.000/100
	14	GKY-M14	7,0	32,0	25,2	16,0	54,2	15,0	500/100
16	GKY-M16	7,0	32,0	25,2	16,0	54,2	17,0	500/100	

fork/spade terminals

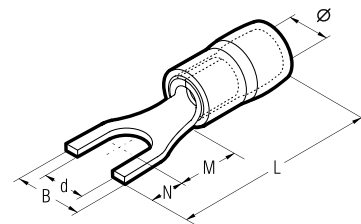

Cond. Size sqmm (AWG)	Ø Stud mm	Type	Dimensions mm						Quantity Box/Bag
			Ø	B	M	N	L	d	
0,25÷1,5 (22÷16)	3	RKY-U3	4,5	5,7	6,5	4,5	22,0	3,2	2.500/100
	3,5	RKY-U3.5	4,5	5,7	6,5	4,5	22,0	3,7	2.500/100
	4	RKY-U4	4,5	6,4	6,5	4,5	22,0	4,3	3.000/100
	5	RKY-U5	4,5	8,1	6,5	4,5	22,0	5,3	3.000/100
	6	RKY-U6	4,5	9,5	6,5	4,5	22,0	6,4	2.000/100
	6	RKY-U6/1	4,5	12,0	11,0	6,0	28,0	6,4	2.000/100
1,5÷2,5 (16÷14)	3	BKY-U3	5,2	5,7	6,5	4,5	22,0	3,2	2.500/100
	3,5	BKY-U3.5	5,2	6,0	6,5	4,5	22,0	3,7	2.500/100
	4	BKY-U4	5,2	6,4	6,5	4,5	22,0	4,3	2.500/100
	5	BKY-U5	5,2	7,9	6,5	4,5	22,0	5,3	2.000/100
	6	BKY-U6	5,2	9,3	6,5	4,5	22,0	6,4	2.000/100
	6	BKY-U6/1	5,2	12,0	11,0	6,0	28,0	6,4	2.000/100
4÷6 (12÷10)	3,5	GKY-U3.5	7,0	7,2	7,5	3,9	24,4	3,7	1.000/100
	4	GKY-U4	7,0	7,2	7,5	3,9	24,4	4,3	1.000/100
	5	GKY-U5	7,0	9,0	7,0	5,5	25,5	5,3	1.000/100
	6	GKY-U6	7,0	12,0	12,0	6,5	31,5	6,4	1.000/100
8	GKY-U8	7,0	14,0	10,5	7,0	30,5	8,4	1.000/100	

Consult CEMBRE for a wider range of pin and blade dimensions.

RKF-F BKF-F GK-F

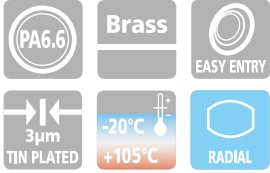

Recommended crimping tools are shown on pages 188 to 225, 312.

female connectors, fully reinforced with Copper sleeve

PA6.6 insulated terminals

Conductor Size sqmm (AWG)	Type	Tab Size mm	Quantity Box/Bag
0,25÷1,5 (22÷16)	RKF-F305	2,8 x 0,5	3.000/100
	RKF-F308	2,8 x 0,8	3.000/100
	RKF-F405	4,8 x 0,5	2.500/100
	RKF-F408	4,8 x 0,8	2.500/100
1,5÷2,5 (16÷14)	RKF-F608	6,35 x 0,8	2.500/100
	BKF-F405	4,8 x 0,5	2.500/100
	BKF-F408	4,8 x 0,8	2.500/100
4÷6 (12÷10)	GK-F608	6,35 x 0,8	1.500/100

PA6.6 fully insulated terminals

Conductor Size sqmm (AWG)	Type	Tab Size mm	Quantity Box/Bag
0,25÷1,5 (22÷16)	RKF-F405P	4,8 x 0,5	1.500/100
	RKF-F408P	4,8 x 0,8	2.000/100
1,5÷2,5 (16÷14)	RKF-F608P	6,35 x 0,8	1.000/100
	BKF-F405P	4,8 x 0,5	1.500/100
4÷6 (12÷10)	BKF-F408P	4,8 x 0,8	2.000/100
	BKF-F608P	6,35 x 0,8	1.000/100
	GK-F608P	6,35 x 0,8	1.000/100

HF
HALOGEN
FREE

RKF BKF GKF



male connectors, fully reinforced with Copper sleeve - PA6.6 insulated terminals

Conductor Size sqmm (AWG)	Type	Tab Size mm	Quantity Box/Bag
0,25÷1,5 (22÷16)	RKF-M608	6,35 x 0,8	3.000/100
1,5÷2,5 (16÷14)	BKF-M608	6,35 x 0,8	2.500/100
4÷6 (12÷10)	GKF-M608	6,35 x 0,8	1.000/100

male/female connectors, fully reinforced with Copper sleeve PA6.6 insulated terminals

Conductor Size sqmm (AWG)	Type	Tab Size mm	Quantity Box/Bag
0,25÷1,5 (22÷16)	RKF-FM608	6,35 x 0,8	1.500/100
1,5÷2,5 (16÷14)	BKF-FM608	6,35 x 0,8	1.500/100

Recommended crimping tools are shown on pages 188 to 225, 312.

HF
HALOGEN
FREE

bullet and socket connectors fully reinforced with Copper sleeve PA6.6 insulated terminals

Conductor Size sqmm (AWG)	Type	Ø mm	Quantity Box/Bag
0,25÷1,5 (22÷16)	RKF-BM4	4,0	2.500/100
	RKF-BF4	3,95	1.000/100
1,5÷2,5 (16÷14)	BKF-BM4	4,0	2.000/100
	BKF-BF4	3,95	800/100

RN-FA BN-FA



Recommended crimping tools are shown on pages 188 to 225, 312.

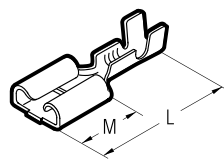

FEMALE CONNECTORS

for Copper conductors

Conductor Size sqmm (AWG)	Type	Tab Size mm	M mm	L mm	Quantity Box/Bag
0,5÷1 (20÷17)	RN-FA305	2,8 x 0,5	6,3	15,0	6.000/100
	RN-FA405	4,8 x 0,5	6,3	15,0	5.000/100
	RN-FA608	6,3 x 0,8	7,7	19,0	3.000/100
1÷2,5 (17÷14)	BN-FA608	6,3 x 0,8	7,7	19,0	2.000/100
	BN-FAB608*	6,3 x 0,8	7,7	15,5	2.000/100
	BN-FAR608**	6,3 x 0,8	7,7	19,0	3.000/100

*flag type **with retainer

MALE CONNECTORS

open barrel - for Copper conductors

Conductor Size sqmm (AWG)	Type	Tab Size mm	M mm	L mm	Quantity Box/Bag
0,5÷1 (20÷17)	RN-MA305	2,8 x 0,5	5,8	13,0	6.000/100
	RN-MA405	4,8 x 0,5	6,3	17,3	5.000/100
	RN-MA608	6,3 x 0,8	7,9	19,7	4.000/100
1÷2,5 (17÷14)	BN-MA608	6,3 x 0,8	7,9	20,0	4.000/100

Recommended crimping tools are shown on pages 188 to 225, 312.

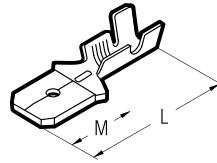

RN-MA BN-MA



MALE TABS

for board mounting - for Copper conductors

Type	Tab Size mm	Ø Stud mm	B mm	C mm	α	Quantity Box/Bag
MP608	6,3 x 0,8	4,0	8,0	11,0	0°	5.000/100
MP608/45	6,3 x 0,8	4,0	8,0	8,5	45°	6.000/100
MP608/90	6,3 x 0,8	4,0	8,0	8,5	90°	5.000/100
MP608D*	6,3 x 0,8	5,0	8,0	14,0	0°	5.000/100

*double tab

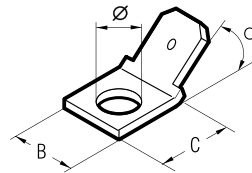

MP MPD



CONNECTOR SLEEVES

Type	Connector	B mm	M mm	L mm	Material	Quantity Box/Bag
CFA300	Female 2,8	5,5	7	18	Polyethylene	3.000/100
CFA400*	Female 4,8	7,5	9	20	Polyethylene	2.000/100
CFA600*	Female 6,3	9,0	11	24	Polyethylene	1.000/100
CFA2-600**	Female 6,3	9,0	9	22	Polyethylene	1.000/100
CFAR600	Female 6,3 with retainer	9,0	12	25	Polyamide 6.6	500/100
CFAB600	Female 6,3 flag	10,0	-	18	Polyamide 6.6	500/50
CMA600*	Male 6,3	12,0	11	22	Polyethylene	500/100

CFA CMA

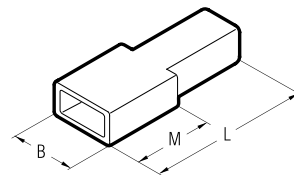

*For a single cable.
Colours available:
Transparent: no suffix
Red: add suffix R
Black: add suffix N

**For twin cables.
Colours available:
Transparent: no suffix
Red: add suffix R
Black: add suffix N
Green: add suffix V
Blue: add suffix B
Yellow: add suffix G

Max operating temperature:

- CFA300; CFA400; CFA600; CFA2-600; CMA600 (PE) 65°C
- CFAR600; CFAB600 (PA6.6) 105°C

PKD

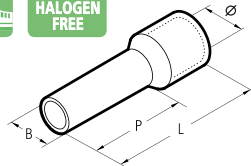

VALSTAR-N3

- Comprising:
- a selection of end sleeves PKD conductor size 1÷6 sqmm
 - Cable ties type G100X2
 - tool ZKE610N.

VALSTAR-N2

- Comprising:
- a selection of end sleeves PKE conductor size 1÷6 sqmm
 - Cable ties type G100X2
 - tool ZKE610N

VALSTAR-N1

- Comprising:
- a selection of end sleeves PKC conductor size 1÷6 sqmm
 - Cable ties type G100X2
 - tool ZKE610N

PA6 INSULATED END SLEEVES

for flexible Copper conductors

Conductor Size sqmm	Type	Dimensions mm				Insulation Colour	Quantity Box/Bag
		Ø	B	P	L		
0,3÷0,5	PKD506	2,6	1,4	6,0	12,0	○ white	10.000/500
	PKD508	2,6	1,4	8,0	14,0		10.000/500
	PKD510	2,6	1,4	10,0	16,0		10.000/500
0,75	PKD7506	2,8	1,6	6,0	12,0	● grey	10.000/500
	PKD7508	2,8	1,6	8,0	14,0		10.000/500
	PKD7510	2,8	1,6	10,0	16,0		10.000/500
	PKD7512	2,8	1,6	12,0	18,0		10.000/500
	PKD106	3,0	1,8	6,0	12,0		10.000/500
1	PKD108	3,0	1,8	8,0	14,0	● red	10.000/500
	PKD110	3,0	1,8	10,0	16,0		10.000/500
	PKD112	3,0	1,8	12,0	18,0		8.000/500
1,5	PKD1508	3,5	2,1	8,0	14,0	● black	5.000/500
	PKD1510	3,5	2,1	10,0	16,0		5.000/500
	PKD1512	3,5	2,1	12,0	18,0		5.000/500
	PKD1518	3,5	2,1	18,0	24,0		5.000/500
2,5	PKD2508	4,2	2,6	8,0	14,0	● blue	5.000/500
	PKD2512	4,2	2,6	12,0	18,0		4.000/500
	PKD2518	4,2	2,6	18,0	24,0		5.000/500
4	PKD410	4,8	3,3	10,0	18,0	● grey	3.000/200
	PKD412	4,8	3,3	12,0	20,0		3.000/200
	PKD418	4,8	3,3	18,0	26,0		3.000/200
6	PKD612	6,3	4,0	12,0	20,0	● yellow	1.500/100
	PKD618	6,3	4,0	18,0	26,0		1.500/100
10	PKD1012	7,6	5,0	12,0	22,0	● red	1.000/100
	PKD1018	7,6	5,0	18,0	28,0		1.000/100
16	PKD1612	8,8	6,4	12,0	24,0	● blue	800/100
	PKD1618	8,8	6,4	18,0	28,0		800/100
25	PKD25016	11,2	7,9	16,0	30,0	● yellow	400/50
	PKD25022	11,2	7,9	22,0	36,0		400/50
35	PKD35016	12,7	8,9	16,0	30,0	● red	300/50
	PKD35025	12,7	8,9	25,0	39,0		300/50
50	PKD50020	15,0	11,0	20,0	36,0	● blue	200/50
	PKD50025	15,0	11,0	25,0	41,0		150/50

PKE

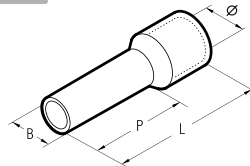

PA6 INSULATED END SLEEVES

for flexible Copper conductors

Conductor Size sqmm	Type	Dimensions mm				Insulation Colour	Quantity Box/Bag
		Ø	B	P	L		
0,1÷0,3	PKE308*	1,9	1,1	8,0	12,0	● yellow	20.000/500
0,3÷0,5	PKE508*	2,6	1,4	8,0	14,0	○ white	10.000/500
0,75	PKE7508	2,8	1,6	8,0	14,0	● blue	10.000/500
1	PKE108*	3,0	1,8	8,0	14,0	● red	10.000/500
	PKE1508*	3,5	2,1	8,0	14,0		5.000/500
1,5	PKE1510*	3,5	2,1	10,0	16,0	● black	5.000/500
	PKE1518*	3,5	2,1	18,0	24,0		5.000/500
2,5	PKE2508	4,2	2,6	8,0	14,0	● grey	5.000/500
	PKE2512	4,2	2,6	12,0	18,0		4.000/500
	PKE2518	4,2	2,6	18,0	24,0		3.000/500
4	PKE410	4,8	3,3	10,0	18,0	● orange	3.000/200
	PKE412	4,8	3,3	12,0	20,0		3.000/200
	PKE418	4,8	3,3	18,0	26,0		3.000/200
6	PKE612	6,3	4,0	12,0	20,0	● green	1.500/100
	PKE618	6,3	4,0	18,0	26,0		1.500/100
10	PKE1012	7,6	5,0	12,0	22,0	● brown	1.000/100
	PKE1018	7,6	5,0	18,0	28,0		1.000/100
16	PKE1612	8,8	6,2	12,0	23,0	○ ivory	800/100
	PKE1618	8,8	6,2	18,0	29,0		800/100
25	PKE25016	11,2	7,9	16,0	30,0	● black	400/50
	PKE25022	11,2	7,9	22,0	36,0		400/50

*to DIN standard 46 228/4 *Not UL approved

PA6 INSULATED END SLEEVES

for flexible Copper conductors

Conductor Size sqmm	Type	Dimensions mm				Insulation Colour	Quantity Box/Bag
		Ø	B	P	L		
0,1÷0,3	PKC306*	1,9	1,1	6,0	10,0	turquoise	20.000/500
	PKC308*	1,9	1,1	8,0	12,0		20.000/500
0,3÷0,5	PKC508	2,6	1,4	8,0	14,0	orange	10.000/500
	PKC510	2,6	1,4	10,0	16,0		10.000/500
0,75	PKC7508	2,8	1,6	8,0	14,0	white	10.000/500
	PKC7512	2,8	1,6	12,0	18,0		10.000/500
1	PKC108	3,0	1,8	8,0	14,0	yellow	10.000/500
	PKC112	3,0	1,8	12,0	18,0		7.500/500
1,5	PKC1508	3,5	2,1	8,0	14,0	red	5.000/500
	PKC1510	3,5	2,1	10,0	16,0		5.000/500
	PKC1518	3,5	2,1	18,0	24,0		5.000/500
2,5	PKC2508*	4,2	2,6	8,0	14,0	blue	5.000/500
	PKC2512*	4,2	2,6	12,0	18,0		5.000/500
	PKC2518*	4,2	2,6	18,0	24,0		5.000/500
4	PKC410*	4,8	3,3	10,0	18,0	grey	3.000/200
	PKC412*	4,8	3,3	12,0	20,0		3.000/200
	PKC418*	4,8	3,3	18,0	26,0		3.000/200
6	PKC612	6,3	4,0	12,0	20,0	black	1.500/100
	PKC618	6,3	4,0	18,0	26,0		1.500/100
10	PKC1012	7,6	5,0	12,0	22,0	ivory	1.000/100
	PKC1018	7,6	5,0	18,0	28,0		1.000/100
16	PKC1612	8,8	6,2	12,0	23,0	green	800/100
	PKC1618	8,8	6,2	18,0	29,0		800/100
25	PKC25016	11,2	7,9	16,0	30,0	brown	400/50
	PKC25022	11,2	7,9	22,0	36,0		500/50
35	PKC35016	12,7	8,9	16,0	30,0	beige	300/50
	PKC35025	12,7	8,9	25,0	39,0		200/50
50	PKC50020	15,0	11,0	20,0	36,0	olive	200/50
	PKC50025	15,0	11,0	25,0	41,0		150/50
70	PKC70022*	16,0	14,3	22,0	38,0	yellow	100/25
95	PKC95025*	18,0	15,7	25,0	44,0	red	100/25
120	PKC120027*	21,0	17,5	27,0	48,0	blue	75/25

*to DIN standard 46 228/4 *Not UL approved

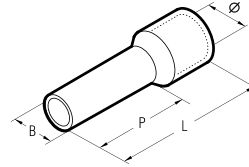

PA6 INSULATED END SLEEVES

for flexible Copper conductors with increased insulation diameter

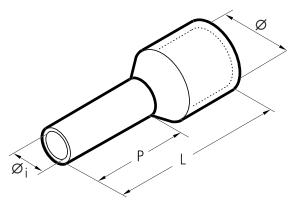

Conductor Size sqmm	Type	Dimensions mm				Insulation Colour	Quantity Box/Bag
		Ø	B	P	L		
1,5	PKK1508	6,4	1,8	8,0	17,5	black	100
	PKK1510	6,4	1,8	10,0	19,5		100
2,5	PKK2508	7,3	2,3	8,0	17,5	blue	100
	PKK2512	7,3	2,3	12,0	21,5		100
4	PKK410	7,3	2,9	10,0	19,5	grey	100
6	PKK612	10,0	3,5	12,0	23,0	yellow	100
10	PKK1012	9,6	4,6	12,0	24,0	red	100
16	PKK1612	11,9	6,0	12,0	25,5	blue	100

The PKK.. range of end sleeves is manufactured from Tin plated electrolytic Copper with a purity greater than 99.9%.



They were specially developed in dimensions for flexible copper conductors with increased insulation diameter. Insulating material made of PA6. The operating temperature range is - 20 to + 120°C (Surge + 130°C). Recommended crimping tools are shown on pages 188 to 228, 279-281, 312, 314, 316-319.

for fine stranded conductors

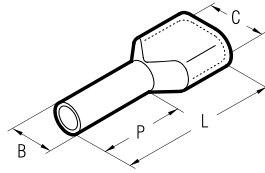

for International Market (excluding UK)



Type PKT range of end sleeves is manufactured from Tin plated electrolytic Copper.

The PA6 insulation type PA10080 is certified EN45545-2.

Designed to accommodate two cables terminating in the same sleeve.

The operating temperature range is -20 to +120°C (Surge +130°C).

Recommended crimping tools are shown on pages 188 to 228, 279-281, 312, 314, 316-319.

Conductor Size sqmm	Type	Dimensions mm				Insulation Colour	ND1,ND2,ND3, ND4 and HNKE 50 Compression Aperture	Quantity Box/Bag
		C	B	P	L			
2 x 0,5	PKT508	4,7x2,5	1,80	8,0	15,0	○ white	1	5.000/500
	PKT510*	4,7x2,5	1,80	10,0	18,0			5.000/500
2 x 0,75	PKT7508	5,0x2,8	2,10	8,0	15,0	● grey	1,5	2.500/100
	PKT7510	5,0x2,8	2,10	10,0	17,0			2.500/100
2 x 1	PKT108	5,4x3,4	2,35	8,0	15,0	● red	2,5	2.500/100
	PKT110	5,4x3,4	2,35	10,0	17,0			2.500/100
2 x 1,5	PKT1508	6,6x3,6	2,50	8,0	16,0	● black	2,5	2.500/100
	PKT1512	6,6x3,6	2,50	12,0	20,0			2.500/100
2 x 2,5	PKT2510	7,8x4,2	3,20	10,0	18,5	● blue	4	2.000/100
	PKT2512	7,8x4,2	3,20	13,0	21,5			1.500/100
2 x 4	PKT412	8,8x4,9	4,10	12,0	23,0	● grey	6	1.000/100
2 x 6	PKT614	10,0x6,9	5,20	14,0	26,0	● yellow	10	800/100
2 x 10	PKT1014*	13,0x7,2	6,70	14,0	26,0	● red	16	500/50
2 x 16	PKT1614	18,4x9,6	8,90	14,0	30,0	● blue	35	200/50

*Not UL approved

"TWIN" POLYPROPYLENE INSULATED END SLEEVES

for fine stranded conductors - for UK Market

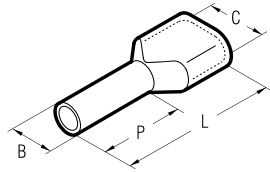

PKET PKCT



for UK Market 

Conductor Size sqmm	Type	Dimensions mm				Insulation Colour	ND1,ND2,ND3, ND4 and HNKE 50 Compression Aperture	Quantity Box/Bag
		C	B	P	L			
2 x 0,5	PKET508	4,6x2,4	1,8	8,0	15,0	○ white	1	500
2 x 0,75	PKET7508	5,4x2,7	2,1	8,0	15,0	● blue	1,5	500
	PKET7512	5,4x2,7	2,1	12,0	19,0			500
2 x 1	PKET108	5,3x2,3	2,35	8,0	15,0	● red	2,5	500
	PKET112	5,3x3,3	2,35	12,0	19,0			500
2 x 1,5	PKET1508	6,5x3,5	2,6	8,0	16,0	● black	2,5	500
	PKET1512	6,5x3,5	2,6	12,0	20,0		2,4	500
2 x 2,5	PKET2510	7,7x4,1	3,3	10,0	19,0	○ grey	4	250
	PKET2512	7,7x4,1	3,3	12,0	22,0			250
2 x 4	PKET412	8,7x4,9	4,2	12,0	23,0	● orange	6	100
2 x 6	PKET614	9,9x6,1	5,3	14,0	25,0	● green	10	100
2 x 10	PKET1014	12,9x7,1	6,9	14,0	26,0	● brown	16	100
2 x 16	PKET1616	16,8x9,8	8,9	16,0	31,0	○ white	35	100

Conductor Size sqmm	Type	Dimensions mm				Insulation Colour	ND1,ND2,ND3, ND4 and HNKE 50 Compression Aperture	Quantity Box/Bag
		C	B	P	L			
2 x 0,5	PKCT508	4,6x2,4	1,8	8,0	15,0	● orange	1	500
2 x 0,75	PKCT7508	5,4x2,7	2,1	8,0	15,0	○ white	1,5	500
	PKCT7512	5,4x2,7	2,1	12,0	19,0			500
2 x 1	PKCT108	5,3x2,3	2,35	8,0	15,0	● yellow	2,5	500
	PKCT112	5,3x3,3	2,35	12,0	19,0			500
2 x 1,5	PKCT1508	6,5x3,5	2,6	8,0	16,0	● red	2,5	500
	PKCT1512	6,5x3,5	2,6	12,0	20,0		2,4	500
2 x 2,5	PKCT2510	7,7x4,1	3,3	10,0	19,0	● blue	4	250
	PKCT2512	7,7x4,1	3,3	12,0	22,0			250
2 x 4	PKCT412	8,7x4,9	4,2	12,0	23,0	○ grey	6	100
2 x 6	PKCT614	9,9x6,1	5,3	14,0	25,0	● black	10	100
2 x 10	PKCT1014	12,9x7,1	6,9	14,0	26,0	○ ivory	16	100
2 x 16	PKCT1616	16,8x9,8	8,9	16,0	31,0	● green	35	100



Type PKET, PKCT ranges of twin end sleeves are manufactured from Tin plated electrolytic Copper with a purity greater than 99.9%. Designed to accommodate two cables terminating in the same sleeve they are ideal for looping conductors.

The operating temperature range is -20 to +105°C (Surge +110°C).

Recommended crimping tools are shown on pages 188 to 228, 279-281, 312, 314, 316-319.

CPKD CPKC



Conforms to DIN standard 46228/4.

Interchangeable application heads are available for crimping these terminals with the bench press ELB-3 (see page 228).



POLYPROPYLENE INSULATED CHAIN END SLEEVES

for flexible Copper conductors

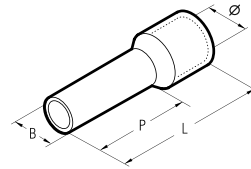

HF
HALOGEN
FREE

Conductor Size sqmm	Type	Dimensions mm				Insulation Colour	Quantity Box/Bag
		Ø	B	P	L		
0,3±0,5	CPKD508	2,6	1,3	8,0	14,0	○ white	5.000
0,75	CPKD7508	2,8	1,5	8,0	14,0	● grey	5.000
0,75	CPKC7508	2,8	1,5	8,0	14,0	○ white	5.000
1	CPKD108	3,0	1,7	8,0	14,0	● red	5.000
1,5	CPKD1508	3,5	2,0	8,0	14,0	● black	5.000
2,5	CPKD2508	4,2	2,5	8,0	14,0	● blue	3.000



KE

UNINSULATED END SLEEVES

for flexible Copper conductors

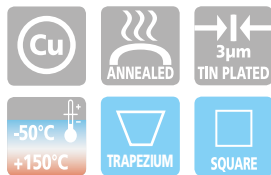

KE series end sleeves are manufactured from Tin plated electrolytic Copper of grade CW024A according to EN 12449, with purity greater than 99%. The compact geometry of the range allows for the termination of flexible conductors in confined spaces.

Recommended crimping tools are shown on pages 188 to 228, 279-281, 312, 314, 316-319.

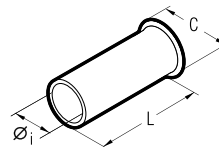

Conductor Size sqmm	Type	Dimensions mm			Quantity Box/Bag
		Ø	L	C	
0,5	KE506ST*	1,0	6,0	1,9	50.000/500
	KE508ST	1,0	8,0	1,9	50.000/500
0,75	KE7506ST*	1,2	6,0	2,2	40.000/500
	KE7508ST	1,2	8,0	2,2	40.000/500
1	KE106ST*	1,4	6,0	2,4	25.000/500
	KE110ST*	1,4	10,0	2,4	25.000/500
1,5	KE1508ST	1,7	8,0	2,8	25.000/500
	KE1510ST*	1,7	10,0	2,8	25.000/500
2,5	KE2508ST	2,2	8,0	3,4	20.000/500
	KE2510ST*	2,2	10,0	3,4	15.000/500
4	KE410ST	2,8	10,0	4,0	12.500/500
	KE412ST*	2,8	12,0	4,0	10.000/500
6	KE610ST*	3,5	10,0	4,7	10.000/500
	KE612ST*	3,5	12,0	4,7	7.500/500
	KE616ST*	3,5	15,0	4,7	5.000/500
10	KE1016ST*	4,5	15,0	5,8	4.000/250
16	KE1616ST*	5,8	15,0	7,5	2.000/250
25	KE25015ST	7,3	15,0	9,5	1.500/100
	KE25018ST*	7,3	18,0	9,5	1.500/100
35	KE35012ST	8,3	12,0	10,5	1.500/100
	KE35015ST	8,3	16,0	10,5	1.500/100
	KE35018ST*	8,3	18,0	10,5	1.000/100

*to DIN standard 46 228/1

COPPER TUBE CRIMPING LUGS PC INSULATED

P-M

for flexible Copper conductors - tested according to EN 45545-2:2013

HF
HALOGEN
FREE

EN
45545

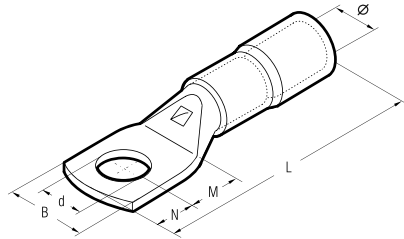

Conductor Size Flexible sqmm (AWG)	Ø Stud mm	Type	Dimensions mm						Insulation Colour	Quantity Box/Bag
			Ø	B	M	N	L	d		
0,25÷1,5 (22÷16)	3	P03-M3	4,0	6,0	4,5	3,5	22,0	3,2	Red	100
	3,5	P03-M3,5	4,0	6,5	4,5	3,5	22,0	3,7		100
	4	P03-M4	4,0	6,5	5,0	4,0	23,0	4,3		100
	5	P03-M5	4,0	7,5	5,5	4,5	24,0	5,3		100
1,5÷2,5 (16÷14)	6	P03-M6	4,0	9,0	6,0	5,0	25,0	6,4	Blue	100
	3	P06-M3	4,9	6,0	4,5	3,5	22,6	3,2		100
	3,5	P06-M3,5	4,9	6,5	4,5	3,5	22,6	3,7		100
	4	P06-M4	4,9	7,5	5,0	4,0	23,6	4,3		100
	5	P06-M5	4,9	8,5	5,5	4,5	24,6	5,3		100
	6	P06-M6	4,9	9,0	6,0	5,0	25,6	6,4		100
4÷6 (12÷10)	8	P06-M8	4,9	12,0	9,0	8,0	31,3	8,4	yellow	100
	3	P1-M3	6,7	7,5	4,5	3,5	28,0	3,2		100
	3,5	P1-M3,5	6,7	7,5	4,5	3,5	28,0	3,7		100
	4	P1-M4	6,7	8,0	5,0	4,0	30,0	4,3		100
	5	P1-M5	6,7	9,0	6,5	6,0	32,3	5,3		100
	6	P1-M6	6,7	11,0	7,0	6,0	32,8	6,4		100
	8	P1-M8	6,7	14,0	9,0	8,0	36,8	8,4		100
	10	P1-M10	6,7	16,5	11,0	10,0	41,4	10,5		100
12	P1-M12	6,7	20,0	16,0	12,0	53,5	13,2	100		

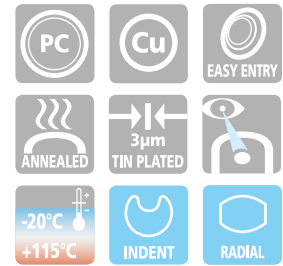

P-M series lugs are manufactured from electrolytic Copper tube with a purity greater than 99.9%, annealed and Tin plated.

The interior of the Polycarbonate insulated sleeve is funnel shaped so as to ensure complete and easy introduction of the conductor strands.

The P-M series lugs have the insulating sleeve in EN45545-2 certified PC10500AC type Polycarbonate, a halogen-free thermoplastic characterized, among other things, by a particular molecular structure which gives greater toughness compared to PVC and PA6.6.

- The operating temperature range is - 20 to + 115°C (Surge + 130°C).
- To install the P-M series lugs, use the HP3 or HP5 tools (see pages 188-189).

ANE-M

POLYAMIDE PA6.6 INSULATED COPPER TUBE LUGS

for Copper conductors

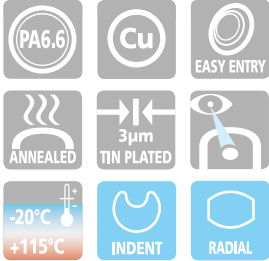
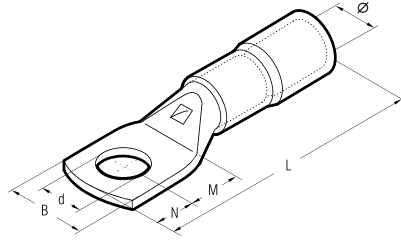

ANE-M series lugs are manufactured from electrolytic Copper tube with a purity greater than 99.9%, annealed and Tin plated. The interior of the PA6.6 insulated sleeve is funnel shaped so as to ensure complete and easy introduction of the conductor strands. It also eliminates the need to insulate the terminal using either tape or heat shrinkable tubing. Furthermore the PA6.6 sleeve avoids the possibility of conductor breakage at the barrel entrance. The operating temperature range is -20 to +115°C (Surge +130°C). In order to achieve the best electrical and mechanical performance it is suggested that they are crimped using dies and tools specifically developed for this purpose by CEMBRE.

Details of the appropriate crimping tools and dies are shown on pages 370 to 371.

Cond. Size Flexible sqmm	Ø Stud mm	Type	Dimensions mm						Quantity Box/Bag	Mechanical Tools		Hydraulic Tools			
			Ø	B	M	N	L	d							
10	4	ANE2-M4	8,0	10,0	5,0	4,0	34,1	4,3	500/100	HNN3	HNN4	B15MD			
	5	ANE2-M5	8,0	10,0	6,5	6,0	37,6	5,3	500/100						
	6	ANE2-M6	8,0	11,0	7,0	6,0	38,1	6,4	500/100						
	8	ANE2-M8	8,0	15,0	9,0	8,0	42,1	8,4	500/100						
	10	ANE2-M10	8,0	18,0	11,0	10,0	46,1	10,5	500/100						
16	12	ANE2-M12	8,0	19,0	14,0	12,0	51,1	13,2	500/100	HNN4	B15MD				
	4	ANE3-M4	9,2	11,5	5,0	4,0	38,6	4,3	400/100						
	5	ANE3-M5	9,2	11,5	6,5	6,0	42,1	5,3	400/100						
	6	ANE3-M6	9,2	11,5	7,0	6,0	42,6	6,4	400/100						
	8	ANE3-M8	9,2	15,0	9,0	8,0	46,6	8,4	400/100						
25	10	ANE3-M10	9,2	18,0	11,0	10,0	50,6	10,5	300/100	HNN4	B15MD				
	12	ANE3-M12	9,2	20,0	14,0	12,0	55,6	13,2	300/100						
	4	ANE5-M4	11,1	14,0	5,0	4,0	41,0	4,3	300/100				TNN70	B15MD	
	5	ANE5-M5	11,1	14,0	6,5	6,0	44,5	5,3	300/100						
	6	ANE5-M6	11,1	14,0	7,0	6,0	45,0	6,4	300/100						
8	ANE5-M8	11,1	15,0	9,0	8,0	49,0	8,4	300/100							
10	ANE5-M10	11,1	18,0	11,0	10,0	53,0	10,5	200/100							
35	12	ANE5-M12	11,1	21,0	14,0	12,0	58,0	13,2	200/50	TNN70	B15MD				
	6	ANE7-M6	13,6	17,0	7,0	6,0	50,0	6,4	100/50				TNN120	B15MD	
	8	ANE7-M8	13,6	17,0	9,0	8,0	54,0	8,4	100/50						
	10	ANE7-M10	13,6	19,0	11,0	10,0	58,0	10,5	100/50						
	12	ANE7-M12	13,6	21,0	14,0	12,0	63,0	13,2	100/50						
50	6	ANE10-M6	13,8	19,0	8,0	7,0	53,0	6,4	150/50	TNN120	B15MD				
	8	ANE10-M8	13,8	19,0	9,0	8,0	55,0	8,4	150/50						
	10	ANE10-M10	13,8	20,0	11,5	9,5	59,0	10,5	150/50						
	12	ANE10-M12	13,8	21,0	12,0	12,0	62,0	13,2	150/50						
	6	ANE14-M6	15,8	21,0	8,0	7,0	61,0	6,4	75/25				TNN120	B15MD	
8	ANE14-M8	15,8	21,0	9,0	8,0	63,0	8,0	75/25							
10	ANE14-M10	15,8	21,0	11,0	10,0	67,0	10,5	75/25							
12	ANE14-M12	15,8	22,0	14,0	12,0	72,0	13,2	75/25							
14	ANE14-M14	15,8	25,0	16,0	14,0	76,0	15,0	100/25							
70	8	ANE19-M8	18,0	25,0	9,0	8,0	73,0	8,4	50/25	TNN120	B15MD				
	10	ANE19-M10	18,0	25,0	11,0	10,0	77,0	10,5	50/25						
	12	ANE19-M12	18,0	25,0	14,0	12,0	82,0	13,2	50/25						
	14	ANE19-M14	18,0	25,0	16,0	14,0	86,0	15,0	50/25						
	16	ANE19-M16	18,0	27,0	18,0	16,0	80,0	17,0	50/25						
120	10	ANE24-M10	20,0	28,5	11,0	10,0	77,7	10,5	50/25	TNN120	B15MD				
	12	ANE24-M12	20,0	28,5	14,0	12,0	86,5	13,2	50/25						
	14	ANE24-M14	20,0	28,5	16,0	14,0	88,5	15,0	50/25						
	16	ANE24-M16	20,0	28,5	18,0	16,0	90,5	17,0	50/25						
	12	ANE30-M12	23,0	31,5	16,0	14,0	101,0	13,2	20/10				TNN120	B15MD	
14	ANE30-M14	23,0	31,5	18,0	16,0	105,0	15,0	30/15							
16	ANE30-M16	23,0	31,5	19,0	17,0	107,0	17,0	30/15							
150	20	ANE30-M20	23,0	31,5	22,0	20,0	113,0	21,0	30/15	TNN120	B15MD				

HT120 and tools and heads with 130 kN crimping force ECW-H3D

POLYAMIDE PA6.6 INSULATED COPPER TUBE LUGS

ANE-M

for extra flexible Copper conductors

• for fine stranded •
SPECIAL
flexible conductors

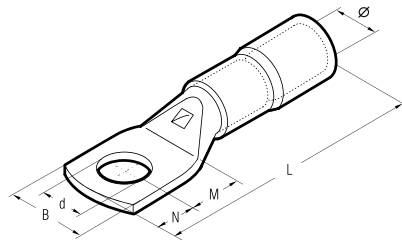

Conductor Size Extra Flexible sqmm	Ø Stud mm	Type	Dimensions mm						Quantity Box/Bag	Mechanical Tools	Hydraulic Tools				
			Ø	B	M	N	L	d							
35	6	ANE9-M6/15*	13,6	15,0	8,0	7,0	54,0	6,4	150/50	TNN70	HT51 RH50 B500ND				
	8	ANE9-M8	13,6	17,0	9,0	8,0	56,0	8,4	150/50						
	10	ANE9-M10	13,6	18,5	11,0	10,0	60,0	10,5	150/50						
	12	ANE9-M12	13,6	21,0	14,0	12,0	65,0	13,2	150/50						
50	6	ANE12-M6/15*	15,7	15,0	8,0	7,0	59,5	6,4	50/25			TNN120	HT51 RH50 B500ND		
	8	ANE12-M8	15,7	19,8	9,0	8,0	61,5	8,4	50/25						
	10	ANE12-M10	15,7	19,8	11,0	10,0	65,5	10,5	50/25						
	10	ANE12-M10/19*	15,7	19,0	11,0	10,0	65,5	10,5	50/25						
70	12	ANE12-M12	15,7	22,0	14,0	12,0	70,5	13,2	50/25					TNN120	HT51 RH50 B500ND
	6	ANE17-M6	17,9	23,0	8,0	7,0	63,8	6,4	50/25						
	8	ANE17-M8	17,9	23,0	9,0	8,0	65,8	8,4	50/25						
	10	ANE17-M10	17,9	23,0	11,0	10,0	69,8	10,5	50/25						
95	10	ANE17-M10/19*	17,9	19,0	11,0	10,0	69,8	10,5	100/25	TNN120	HT51 RH50 B500ND				
	12	ANE17-M12	17,9	23,0	14,0	12,0	74,8	13,2	50/25						
	14	ANE17-M14	17,9	25,0	15,5	12,0	76,3	15,0	50/25						
	16	ANE17-M16	17,9	27,0	16,5	13,5	78,8	17,0	50/25						
120	8	ANE20-M8	20,0	27,0	9,0	8,0	70,6	8,4	50/25			TNN120	HT51 RH50 B500ND		
	10	ANE20-M10	20,0	27,0	11,0	10,0	74,6	10,5	50/25						
	12	ANE20-M12	20,0	27,0	14,0	12,0	79,6	13,2	50/25						
	14	ANE20-M14	20,0	27,0	15,5	12,0	81,1	15,0	50/25						
150	16	ANE20-M16	20,0	27,0	16,5	13,5	83,6	17,0	50/25					TNN120	HT51 RH50 B500ND
	10	ANE29-M10	22,4	30,0	11,0	10,0	81,5	10,5	30/15						
	12	ANE29-M12	22,4	30,0	14,0	12,0	86,5	13,2	30/15						
	14	ANE29-M14	22,4	30,0	15,5	12,0	88,5	15,0	50/25						
150	16	ANE29-M16	22,4	30,0	16,5	13,5	90,5	17,0	50/25	TNN120	HT51 RH50 B500ND				
	20	ANE29-M20	22,4	30,0	22,0	20,0	102,5	21,0	40/20						
	12	ANE35-M12	25,0	34,2	16,0	14,0	95,0	13,2	30/15						
	14	ANE35-M14	25,0	34,2	18,0	16,0	99,0	15,0	30/15						
150	16	ANE35-M16	25,0	34,2	19,0	17,0	101,0	17,0	30/15			TNN120	HT51 RH50 B500ND		
	20	ANE35-M20	25,0	34,2	22,0	20,0	107,0	21,0	30/15						



These lugs are particularly recommended for use with extra flexible conductors on for instance, welding machines.

ANE-M series lugs are manufactured from electrolytic Copper tube with a purity greater than 99.9%, annealed and Tin plated.

The interior of the PA6.6 insulated sleeve is funnel shaped so as to ensure complete and easy introduction of the conductor strands.

It also eliminates the need to insulate the terminal using either tape or heat shrinkable tubing.

Furthermore the PA6.6 sleeve avoids the possibility of conductor breakage at the barrel entrance.

The operating temperature range is -20 to +115°C (Surge +130°C).

In order to achieve the best electrical and mechanical performance it is suggested that they are crimped using dies and tools specifically developed for this purpose by CEMBRE.

Details of the appropriate crimping tools and dies are shown on pages 370 to 371.

AN-M
IN-M
EN-M

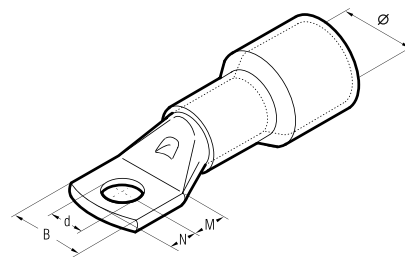

POLYAMIDE PA6.6 INSULATED COPPER TUBE LUGS

for Copper conductors



These terminals are particularly recommended for use with flexible conductors.

They are manufactured from electrolytic copper tube with a purity greater than 99.9% and with dimension so as to ensure both a good electrical connection and an adequate resistance to vibrations and traction; they are annealed and tin plated.

For the same cable section are available different types of connectors with PA6.6 sleeve entry of different diameters so as to accept conductors with various insulation thickness.

The insulated sleeve additionally will accept the conductor so avoiding a sudden bending of the conductor itself at the connector entry, highly increasing its resistance to the mechanical solicitations that could break the conductor strands.

The operating temperature range is -20 to +115°C (Surge +130°C).

- To complete the type of connectors add the screw diameter expressed in mm to the M reference.
- The M, N, and B dimensions concerning the palm are the same as the A-M connector ones.

These connectors can be used also on low stranded conductors if crimped with radial containment dies of the MN..RF-C series.

In order to achieve the best electrical and mechanical performance it is suggested that they are crimped using dies and tools specifically developed for this purpose by CEMBRE (see page 370 to 371).

Conductor Size mm ²	Type	Insulation		Mechanical Tools	Hydraulic Tools						
		Ø mm	colour								
1,5÷2,5 F	AN06-M.....	4,1	● blue	HNN3							
	IN06-M.....	5,3	● green								
	ENR06-M.....	6,0	● blue								
4÷6 F	AN06-M.....	6,9	● blue								
	AN1-M.....	5,3	● yellow								
	IN1-M.....	6,6	○ neutral								
	ON1-M.....	7,6	● blue								
	UN1-M.....	8,7	● blue								
	EN1-M.....	14,1	● red								
10 F	AN2-M.....	8,0	● red			HNN4	B15MD				
	IN2-M.....	10,8	● blue								
10 R	ENR2-M.....	12,5	● blue			TNN70 TNN71	HT51 RH50 B500ND				
	EN2-M.....	15,1	● red								
16 F	AN3-M.....	9,2	● blue	TNN120	HT120 and tools and heads with 130 kN crimping force						
	EN3-M.....	11,7	● blue								
16 R	IN3-M.....	16,9	● red					ECW-H3D			
	EN3-M.....	16,9	● red								
25 F 25 R	AN5-M.....	11,1	● yellow						HT120 and tools and heads with 130 kN crimping force		
	AN7-M.....	11,9	● red								
25÷35 F	EN7-M.....	13,0	● blue							ECW-H3D	
	IN7-M.....	18,7	● red								
35 R	AN10-M.....	13,8	○ neutral								HT120 and tools and heads with 130 kN crimping force
	IN10-M.....	15,0	● blue								
35 F	ENR10-M.....	17,3	● blue			ECW-H3D					
	EN10-M.....	20,2	● red								
50 R	AN14-M.....	15,8	● blue	HT120 and tools and heads with 130 kN crimping force							
	IN14-M.....	16,9	● blue								
50 F	EN14-M.....	21,9	● red		ECW-H3D						
	AN19-M.....	18,0	● blue								
70 R	IN19-M.....	19,6	● blue				HT120 and tools and heads with 130 kN crimping force				
	EN19-M.....	19,6	● blue								
70 F	IN19-M.....	24,3	● red					ECW-H3D			
	AN24-M.....	20,0	● red								
95 R	IN24-M.....	22,2	● blue						HT120 and tools and heads with 130 kN crimping force		
	EN24-M.....	27,1	● red								
95 F	AN30-M.....	23,0	● red			ECW-H3D					
	IN30-M.....	29,0	● red								
120 R	EN30-M.....	24,5	● blue	HT120 and tools and heads with 130 kN crimping force							
	IN30-M.....	29,0	● red								
120 F	INR37-M.....	29,0	● blue		ECW-H3D						
	IN37-M.....	31,6	● red								
185 R	EN48-M.....	29,4	● red				HT120 and tools and heads with 130 kN crimping force				
	IN48-M.....	34,5	● red								
185 F	EN60-M.....	33,5	● red					ECW-H3D			
	IN60-M.....	38,0	● red								
240 F	EN80-M.....	37,7	● blue						HT120 and tools and heads with 130 kN crimping force		
	IN80-M.....	41,1	● red								

R = Rigid conductor F = Flexible conductor

POLYAMIDE PA6.6 INSULATED FORK TERMINALS

for Copper conductors

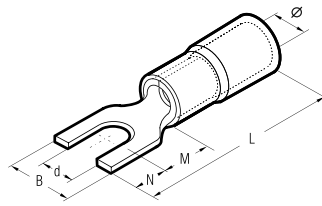

Conductor Size Flexible sqmm	Ø Stud mm	Type	Dimensions mm						Quantity Box/Bag	Mechanical Tools		Hydraulic Tools					
			Ø	B	M	N	L	d		HNN3	HNN4	TNN70	TNN120	B15MD	HT51 RH50 B500 B500ND	HT120 and tools and heads with 130 kN crimping force	ECW-H3D
10	4	ANE2-U4	8,0	9,8	7,5	7,0	35,1	4,3	500/100	HNN3	HNN4	TNN70	TNN120	B15MD	HT51 RH50 B500 B500ND	HT120 and tools and heads with 130 kN crimping force	ECW-H3D
	5	ANE2-U5	8,0	11,5	7,5	7,0	35,1	5,3	500/100								
16	4	ANE3-U4	9,2	10,0	10,0	8,0	41,1	4,3	400/100	HNN3	HNN4	TNN70	TNN120	B15MD	HT51 RH50 B500 B500ND	HT120 and tools and heads with 130 kN crimping force	ECW-H3D
	5	ANE3-U5	9,2	11,5	10,0	8,0	41,1	5,3	400/100								



ANE-U series terminals are made from electrolytic Copper with a purity greater than 99.9%, rolled, Tin plated and brazed. The interior of the PA6.6 insulated sleeve is funnel shaped so as to ensure complete and easy introduction of the conductor strands. The operating temperature range is -20 to +115°C (Surge +130°C).

In order to achieve the best electrical and mechanical performance it is suggested that they are crimped using dies and tools specifically developed for this purpose by CEMBRE. Details of the appropriate crimping tools and dies are shown on pages 370 to 371.

POLYAMIDE PA6.6 INSULATED PIN TERMINALS

for Copper conductors

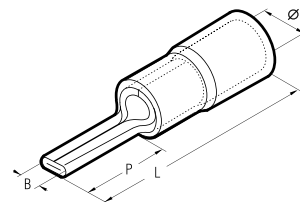

Conductor Size Flexible sqmm	Type	Dimensions mm				Quantity Box/Bag	Mechanical Tools				Hydraulic Tools			
		Ø	B	P	L		HNN3	HNN4	TNN70	TNN120	B15MD	HT51 RH50 B500 B500ND	HT120 and tools and heads with 130 kN crimping force	ECW-H3D
10	ANE2-P12	8,0	4,3	14,5	35,1	500/100	HNN3	HNN4	TNN70	TNN120	B15MD	HT51 RH50 B500 B500ND	HT120 and tools and heads with 130 kN crimping force	ECW-H3D
16	ANE3-P14	9,2	5,5	18,0	41,1	400/100								
25	ANE5-P16	11,1	7,0	20,3	45,0	300/100	HNN3	HNN4	TNN70	TNN120	B15MD	HT51 RH50 B500 B500ND	HT120 and tools and heads with 130 kN crimping force	ECW-H3D
35	ANE7-P20	13,6	8,0	24,5	55,0	150/50								



ANE-P series terminals are made from electrolytic Copper with a purity greater than 99.9%, rolled, Tin plated and brazed. The interior of the PA6.6 insulated sleeve is funnel shaped so as to ensure complete and easy introduction of the conductor strands. The operating temperature range is -20 to +115°C (Surge +130°C).

In order to achieve the best electrical and mechanical performance it is suggested that they are crimped using dies and tools specifically developed for this purpose by CEMBRE. Details of the appropriate crimping tools and dies are shown on pages 370 to 371.

S

UNINSULATED TERMINALS

S range - brazed seam - for Copper conductors



S range terminals are manufactured from electrolytic Copper strip with a purity greater than 99.9% and Tin plated.

The seam is brazed to provide uniform mechanical strength. The terminal barrel is rifled to enhance electrical contact and to improve mechanical strength.

Recommended crimping tools are shown on pages 188 to 225, 312.

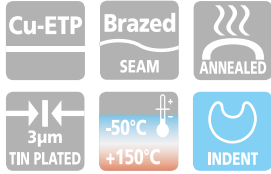

pin terminals

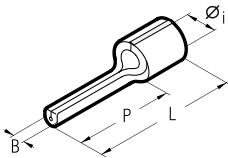

Conductor Size sqmm (AWG)	Type	Dimensions mm				Quantity Box/Bag
		Øi	B	P	L	
0,25÷1,5 [22÷16]	S1.5-P8	1,8	1,6	8,0	12,0	8.000/100
	S1.5-P10	1,8	1,6	10,0	14,0	8.000/100
	S1.5-P12	1,8	1,6	12,0	16,2	8.000/100
1,5÷2,5 [16÷14]	S2.5-P8	2,4	1,6	8,0	12,0	7.000/100
	S2.5-P10	2,4	1,6	10,0	14,0	7.000/100
	S2.5-P12	2,4	1,6	12,0	16,0	7.000/100
4÷6 [12÷10]	S6-P10	3,6	2,2	10,0	16,8	4.000/100
	S6-P12	3,6	2,2	12,0	19,0	4.000/100
	S6-P14	3,6	2,2	14,0	21,0	3.000/100

blade terminals

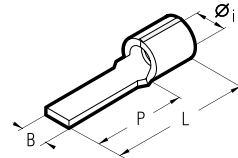

Conductor Size sqmm (AWG)	Type	Dimensions mm				Quantity Box/Bag
		Øi	B	P	L	
0,25÷1,5 [22÷16]	S1.5-PP12	1,8	3,0	12,8	17,0	8.000/100
	S1.5-PP12/1*	1,8	3,0	11,3	15,5	8.000/100
	S1.5-PP12/19	1,8	1,9	13,2	17,4	8.000/100
	S1.5-PP14	1,8	3,0	14,8	19,0	8.000/100
1,5÷2,5 [16÷14]	S2.5-PP12	2,4	3,5	12,8	17,0	7.000/100
	S2.5-PP12/25	2,4	2,5	13,3	17,5	7.000/100
	S2.5-PP16/25	2,4	2,5	17,2	21,4	7.000/100
4÷6 [12÷10]	S6-PP12	3,6	4,0	13,3	19,7	4.000/100
	S6-PP17	3,6	2,9	19,1	25,5	4.000/100

*Made to order

UNINSULATED TERMINALS

S

S range - brazed seam - for Copper conductors

ring terminals

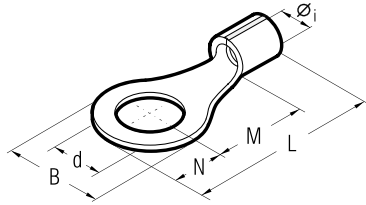

fork/spade terminals

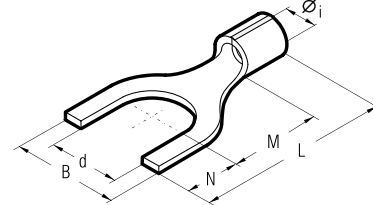

Conductor Size sqmm (AWG)	Ø Stud mm	Type	Dimensions mm						Quantity Box/Bag
			Øi	B	M	N	L	d	
0,25÷1,5 [22÷16]	2	S1.5-M2*	1,8	5,6	4,5	2,8	11,5	2,2	7.000/100
	3	S1.5-M3	1,8	5,6	4,5	2,8	11,5	3,2	7.000/100
	3,5	S1.5-M3.5	1,8	5,6	4,5	2,8	11,5	3,7	7.000/100
	3,5	S1.5-M3.5/1*	1,8	6,2	7,1	3,1	14,4	3,7	7.000/100
	4	S1.5-M4	1,8	7,0	6,5	3,5	14,2	4,3	7.000/100
	4	S1.5-M4/3*	1,8	7,8	7,1	3,9	15,2	4,3	7.000/100
	5	S1.5-M5	1,8	7,8	7,1	3,9	15,2	5,3	7.000/100
	6	S1.5-M6	1,8	9,4	8,1	4,7	17,0	6,4	6.000/100
	6	S1.5-M6/1	1,8	12,0	10,3	6,0	20,5	6,4	5.000/100
	7	S1.5-M7	1,8	9,4	8,1	4,7	17,0	7,2	6.000/100
	8	S1.5-M8	1,8	12,0	10,3	6,0	20,5	8,4	4.000/100
	10	S1.5-M10	1,8	15,5	13,0	7,7	25,0	10,5	3.000/100
12	S1.5-M12	1,8	18,0	15,5	9,0	28,7	13,0	2.000/100	
1,5÷2,5 [16÷14]	3	S2.5-M3	2,4	5,6	5,0	2,8	12,0	3,2	6.000/100
	3,5	S2.5-M3.5	2,4	5,6	5,0	2,8	12,0	3,7	6.000/100
	3,5	S2.5-M3.5/1*	2,4	6,2	6,5	3,1	13,8	3,7	5.000/100
	4	S2.5-M4	2,4	8,0	6,5	4,0	14,7	4,3	5.000/100
	5	S2.5-M5	2,4	8,0	7,5	4,0	15,7	5,3	5.000/100
	6	S2.5-M6	2,4	9,4	8,6	4,7	17,5	6,4	5.000/100
	6	S2.5-M6/1	2,4	12,0	10,3	6,0	20,5	6,4	5.000/100
	7	S2.5-M7	2,4	10,0	7,8	5,0	17,0	7,2	5.000/100
	8	S2.5-M8	2,4	12,0	10,3	6,0	20,5	8,4	4.000/100
	10	S2.5-M10	2,4	15,5	13,0	7,7	25,0	10,5	2.500/100
	12	S2.5-M12	2,4	18,0	15,5	9,0	28,7	13,0	2.000/100
	4÷6 [12÷10]	3	S6-M3	3,6	8,0	8,1	4,0	18,5	3,2
3,5		S6-M3.5	3,6	8,0	8,1	4,0	18,5	3,7	3.000/100
4		S6-M4	3,6	9,0	8,1	4,5	19,0	4,3	3.000/100
5		S6-M5	3,6	9,0	8,1	4,5	19,0	5,3	2.500/100
6		S6-M6	3,6	11,0	11,1	5,5	23,0	6,4	2.500/100
6		S6-M6/1*	3,6	11,0	8,1	5,5	20,0	6,4	2.500/100
7		S6-M7	3,6	11,0	11,1	5,5	23,0	7,2	2.500/100
8		S6-M8	3,6	13,6	12,1	6,8	25,3	8,4	2.000/100
8		S6-M8/1*	3,6	11,0	8,1	5,5	20,0	8,4	2.500/100
10		S6-M10	3,6	13,6	12,1	6,8	25,3	10,5	2.000/100
10		S6-M10/1	3,6	15,5	13,8	7,7	28,0	10,5	2.000/100
12		S6-M12	3,6	19,0	15,1	9,5	31,0	13,0	1.000/100
14	S6-M14	3,6	21,0	16,1	10,5	33,0	15,0	1.000/100	
16	S6-M16	3,6	24,0	17,1	12,0	35,5	17,0	1.000/100	
10 (8)	4	S10-M4	4,8	11,5	9,0	5,8	23,8	4,3	2.000/100
	5	S10-M5	4,8	11,5	9,0	5,8	23,8	5,3	2.000/100
	6	S10-M6	4,8	11,5	9,0	5,8	23,8	6,4	1.500/100
	7	S10-M7	4,8	11,5	9,0	5,8	23,8	7,2	1.500/100

Conductor Size sqmm (AWG)	Ø Stud mm	Type	Dimensions mm						Quantity Box/Bag
			Øi	B	M	N	L	d	
0,25÷1,5 [22÷16]	3	S1.5-U3	1,8	5,5	5,5	4,0	13,7	3,2	7.000/100
	3,5	S1.5-U3.5	1,8	6,0	6,5	3,8	14,5	3,7	7.000/100
	3,5	S1.5-U3.5/2*	1,8	6,4	6,5	3,8	14,5	3,7	7.000/100
	4	S1.5-U4	1,8	6,5	7,5	3,7	15,4	4,3	7.000/100
	4	S1.5-U4/1*	1,8	8,5	7,5	3,7	15,4	4,3	7.000/100
	4	S1.5-U4/2	1,8	7,5	7,5	3,7	15,4	4,3	7.000/100
	5	S1.5-U5	1,8	8,5	7,5	3,7	15,4	5,3	7.000/100
	5	S1.5-U5/1	1,8	9,4	7,5	3,7	15,4	5,3	7.000/100
	6	S1.5-U6	1,8	9,4	8,1	4,7	17,0	6,4	6.000/100
	6	S1.5-U6/1*	1,8	12,0	9,2	7,1	20,5	6,4	6.000/100
	8	S1.5-U8	1,8	14,0	10,0	6,3	20,5	8,4	3.000/100
	10	S1.5-U10	1,8	17,5	13,0	7,7	25,0	10,5	2.500/100
12	S1.5-U12	1,8	20,0	15,5	9,0	28,7	13,0	2.000/100	
1,5÷2,5 [16÷14]	3	S2.5-U3	2,4	5,5	5,5	4,0	13,7	3,2	6.000/100
	3,5	S2.5-U3.5	2,4	6,4	6,5	3,8	14,5	3,7	6.000/100
	3,5	S2.5-U3.5/1*	2,4	7,2	6,5	3,8	14,5	3,7	6.000/100
	4	S2.5-U4	2,4	6,5	7,5	3,7	15,4	4,3	5.000/100
	4	S2.5-U4/1*	2,4	8,5	7,5	3,7	15,4	4,3	6.000/100
	4	S2.5-U4/2*	2,4	7,5	7,5	3,7	15,4	4,3	6.000/100
	5	S2.5-U5	2,4	8,5	7,5	3,7	15,4	5,3	6.000/100
	6	S2.5-U6	2,4	9,4	8,1	4,7	17,0	6,4	5.000/100
	6	S2.5-U6/1*	2,4	12,0	9,2	7,1	20,5	6,4	4.000/100
	8	S2.5-U8	2,4	14,0	10,0	6,3	20,5	8,4	2.500/100
	10	S2.5-U10	2,4	17,5	13,0	7,7	25,0	10,5	2.000/100
	12	S2.5-U12	2,4	20,0	15,5	9,0	28,7	13,0	2.000/100
4÷6 [12÷10]	3,5	S6-U3.5	3,6	7,5	8,5	3,9	18,8	3,7	3.000/100
	4	S6-U4	3,6	7,5	8,0	4,4	18,8	4,3	3.000/100
	5	S6-U5	3,6	9,5	8,0	4,4	18,8	5,3	2.500/100
	6	S6-U6	3,6	10,0	11,0	5,5	22,9	6,4	2.500/100
	8	S6-U8	3,6	13,5	12,0	8,0	26,4	8,4	2.000/100
	10	S6-U10	3,6	15,5	13,0	8,0	27,4	10,5	2.000/100
	10	S6-U10/1*	3,6	17,5	13,8	7,7	28,0	10,5	2.000/100
	12	S6-U12	3,6	21,0	15,1	9,5	31,0	13,0	1.000/100
	14	S6-U14	3,6	23,0	16,1	10,5	33,0	15,0	1.000/100
	16	S6-U16*	3,6	26,0	17,1	11,5	35,0	17,0	1.000/100

*Made to order



RN, BN, GN range terminals are manufactured from electrolytic Copper strip with a purity greater than 99.9% and Tin plated. The seam is unbraced.

The terminal barrel is rifled to enhance electrical contact and to improve mechanical strength.

Recommended crimping tools are shown on pages 188 to 225, 312.



pin terminals

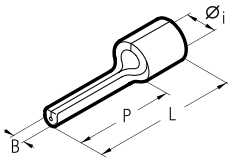

Conductor Size sqmm (AWG)	Type	Dimensions mm				Quantity Box/Bag
		Øi	B	P	L	
0,25÷1,5 [22÷16]	RN-P8	1,8	1,6	8,0	12,0	8.000/100
	RN-P10	1,8	1,6	10,0	14,0	8.000/100
	RN-P12	1,8	1,6	12,0	16,2	8.000/100
1,5÷2,5 [16÷14]	BN-P8	2,4	1,6	8,0	12,0	7.000/100
	BN-P10	2,4	1,6	10,0	14,0	7.000/100
	BN-P12	2,4	1,6	12,0	16,0	7.000/100
4÷6 [12÷10]	GN-P10	3,6	2,2	10,0	16,8	4.000/100
	GN-P12	3,6	2,2	12,0	19,0	4.000/100
	GN-P14	3,6	2,2	14,0	21,0	3.500/100

blade terminals

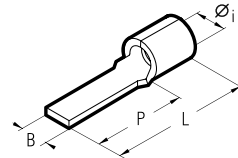

Conductor Size sqmm (AWG)	Type	Dimensions mm				Quantity Box/Bag
		Øi	B	P	L	
0,25÷1,5 [22÷16]	RN-PP12	1,8	3,0	12,8	17,0	8.000/100
	RN-PP12/1	1,8	3,0	11,3	15,5	8.000/100
	RN-PP12/19	1,8	1,9	13,2	17,4	8.000/100
	RN-PP14	1,8	3,0	14,8	19,0	8.000/100
	RN-PP16/23	1,8	2,3	17,2	21,4	8.000/100
1,5÷2,5 [16÷14]	BN-PP12	2,4	3,5	12,8	17,0	7.000/100
	BN-PP12/25	2,4	2,5	13,3	17,5	7.000/100
	BN-PP16/25	2,4	2,5	17,2	21,4	7.000/100
4÷6 [12÷10]	GN-PP12	3,6	4,0	13,3	19,7	4.000/100
	GN-PP17	3,6	2,9	19,1	25,5	3.000/100

RN, BN, GN range - unbraced - for Copper conductors

ring terminals

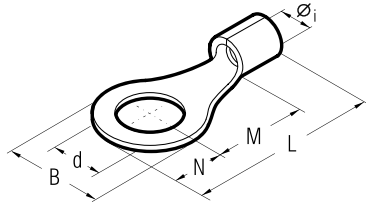

Conductor Size sqmm (AWG)	Ø Stud mm	Type	Dimensions mm						Quantity Box/Bag
			Øi	B	M	N	L	d	
0,25÷1,5 (22÷16)	2	RN-M2*	1,8	5,6	4,5	2,8	11,5	2,2	7.000/100
	3	RN-M3	1,8	5,6	4,5	2,8	11,5	3,2	7.000/100
	3,5	RN-M3.5	1,8	5,6	4,5	2,8	11,5	3,7	7.000/100
	3,5	RN-M3.5/1	1,8	6,2	7,1	3,1	14,4	3,7	7.000/100
	4	RN-M4	1,8	7,0	6,5	3,5	14,2	4,3	7.000/100
	4	RN-M4/3	1,8	7,8	7,1	3,9	15,2	4,3	7.000/100
	5	RN-M5	1,8	7,8	7,1	3,9	15,2	5,3	7.000/100
	6	RN-M6	1,8	9,4	8,1	4,7	17,0	6,4	6.000/100
	6	RN-M6/1	1,8	12,0	10,3	6,0	20,5	6,4	4.000/100
	7	RN-M7	1,8	9,4	8,1	4,7	17,0	7,2	6.000/100
	8	RN-M8	1,8	12,0	10,3	6,0	20,5	8,4	4.000/100
	10	RN-M10	1,8	15,5	13,0	7,7	25,0	10,5	2.000/100
12	RN-M12	1,8	18,0	15,5	9,0	28,7	13,0	2.000/100	
1,5÷2,5 (16÷14)	2	BN-M2*	2,4	5,6	5,0	2,8	12,0	2,2	6.000/100
	3	BN-M3	2,4	5,6	5,0	2,8	12,0	3,2	6.000/100
	3,5	BN-M3.5	2,4	5,6	5,0	2,8	12,0	3,7	6.000/100
	3,5	BN-M3.5/1	2,4	6,2	6,5	3,1	13,8	3,7	6.000/100
	4	BN-M4	2,4	8,0	6,5	4,0	14,7	4,3	5.000/100
	5	BN-M5	2,4	8,0	7,5	4,0	15,7	5,3	5.000/100
	6	BN-M6	2,4	9,4	8,6	4,7	17,5	6,4	5.000/100
	6	BN-M6/1	2,4	12,0	10,3	6,0	20,5	6,4	5.000/100
	7	BN-M7	2,4	10,0	7,8	5,0	17,0	7,2	5.000/100
	8	BN-M8	2,4	12,0	10,3	6,0	20,5	8,4	4.000/100
	10	BN-M10	2,4	15,5	13,0	7,7	25,0	10,5	2.500/100
	12	BN-M12	2,4	18,0	15,5	9,0	28,7	13,0	2.000/100
4÷6 (12÷10)	3	GN-M3	3,6	8,0	8,1	4,0	18,5	3,2	3.000/100
	3,5	GN-M3.5	3,6	8,0	8,1	4,0	18,5	3,7	3.000/100
	4	GN-M4	3,6	9,0	8,1	4,5	19,0	4,3	3.000/100
	5	GN-M5	3,6	9,0	8,1	4,5	19,0	5,3	2.500/100
	6	GN-M6	3,6	11,0	11,1	5,5	23,0	6,4	2.500/100
	6	GN-M6/1	3,6	11,0	8,1	5,5	20,0	6,4	2.500/100
	7	GN-M7	3,6	11,0	11,1	5,5	23,0	7,2	2.500/100
	8	GN-M8	3,6	13,6	12,1	6,8	25,3	8,4	2.000/100
	8	GN-M8/1*	3,6	11,0	8,1	5,5	20,0	8,4	2.500/100
	10	GN-M10	3,6	13,6	12,1	6,8	25,3	10,5	2.000/100
	10	GN-M10/1	3,6	15,5	13,8	7,7	28,0	10,5	2.000/100
	12	GN-M12	3,6	19,0	15,1	9,5	31,0	13,0	1.000/100
14	GN-M14	3,6	21,0	16,1	10,5	33,0	15,0	1.000/100	
16	GN-M16	3,6	24,0	17,1	12,0	35,5	17,0	1.000/100	

fork/spade terminals

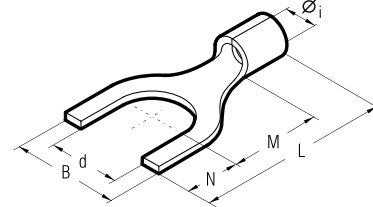

Conductor Size sqmm (AWG)	Ø Stud mm	Type	Dimensions mm						Quantity Box/Bag
			Øi	B	M	N	L	d	
0,25÷1,5 (22÷16)	3	RN-U3	1,8	5,5	5,5	4,0	13,7	3,2	7.000/100
	3,5	RN-U3.5	1,8	6,0	6,5	3,8	14,5	3,7	7.000/100
	3,5	RN-U3.5/2	1,8	6,4	6,5	3,8	14,5	3,7	7.000/100
	4	RN-U4	1,8	6,5	7,5	3,7	15,4	4,3	7.000/100
	4	RN-U4/1	1,8	8,5	7,5	3,7	15,4	4,3	7.000/100
	4	RN-U4/2	1,8	7,5	7,5	3,7	15,4	4,3	7.000/100
	5	RN-U5	1,8	8,5	7,5	3,7	15,4	5,3	5.000/100
	5	RN-U5/1*	1,8	9,4	7,5	3,7	15,4	5,3	5.000/100
	6	RN-U6	1,8	9,4	8,1	4,7	17,0	6,4	6.000/100
	6	RN-U6/1	1,8	12,0	9,2	7,1	20,5	6,4	3.000/100
	8	RN-U8	1,8	14,0	10,0	6,3	20,5	8,4	2.500/100
	10	RN-U10	1,8	17,5	13,0	7,7	25,0	10,5	2.000/100
12	RN-U12	1,8	20,0	15,5	9,0	28,7	13,0	2.000/100	
1,5÷2,5 (16÷14)	3	BN-U3	2,4	5,5	5,5	4,0	13,7	3,2	6.000/100
	3,5	BN-U3.5	2,4	6,4	6,5	3,8	14,5	3,7	6.000/100
	3,5	BN-U3.5/1*	2,4	7,2	6,5	3,8	14,5	3,7	6.000/100
	4	BN-U4	2,4	6,5	7,5	3,7	15,4	4,3	6.000/100
	4	BN-U4/1	2,4	8,5	7,5	3,7	15,4	4,3	6.000/100
	4	BN-U4/2	2,4	7,5	7,5	3,7	15,4	4,3	6.000/100
	5	BN-U5	2,4	8,5	7,5	3,7	15,4	5,3	5.000/100
	6	BN-U6	2,4	9,4	8,1	4,7	17,0	6,4	5.000/100
	6	BN-U6/1	2,4	12,0	9,2	7,1	20,5	6,4	4.000/100
	8	BN-U8	2,4	14,0	10,0	6,3	20,5	8,4	4.000/100
	10	BN-U10	2,4	17,5	13,0	7,7	25,0	10,5	2.000/100
	12	BN-U12	2,4	20,0	15,5	9,0	28,7	13,0	2.000/100
4÷6 (12÷10)	3,5	GN-U3.5	3,6	7,5	8,5	3,9	18,8	3,7	3.000/100
	4	GN-U4	3,6	7,5	8,0	4,4	18,8	4,3	3.000/100
	5	GN-U5	3,6	9,5	8,0	4,4	18,8	5,3	2.500/100
	6	GN-U6	3,6	10,0	11,0	5,5	22,9	6,4	2.500/100
	8	GN-U8	3,6	13,5	12,0	8,0	26,4	8,4	2.000/100
	10	GN-U10	3,6	15,5	13,0	8,0	27,4	10,5	2.000/100
	10	GN-U10/1	3,6	17,5	13,8	7,7	28,0	10,5	2.000/100
	12	GN-U12	3,6	21,0	15,1	9,5	31,0	13,0	1.000/100
	14	GN-U14	3,6	23,0	16,1	10,5	33,0	15,0	1.000/100
	16	GN-U16	3,6	26,0	17,1	11,5	35,0	17,0	1.000/100

*Made to order



CRIMPING CONNECTORS ACCORDING TO DIN 46234

for Copper conductors

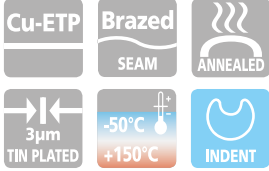
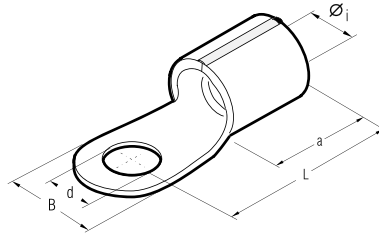

Q type connectors are manufactured from electrolytic Copper strip with a purity greater than 99.9%, annealed and surface protected by tin plating; dimensions are compliant with DIN 46234; the sleeve is brazed with a silver-Copper alloy.

Details of the conductor csa and stud diameter are engraved on the palm.

Details of the appropriate crimping tools and dies are shown on page 378.

Consult us for special requirements.

Conductor Size sqmm	Ø Stud mm	Type	Dimensions mm					Quantity Box/Bag	Mechanical Tools	Hydraulic Tools			
			Øi	d	L	B	a						
6÷10	4	Q10-4	4,5	4,3	16,0	10,0	8,0	1.500/100	HNS*	HT51D RH50 RHM50 B500ND HT81-JD RHU81D	RH60C B600C B600CND	HT120 and tools and heads with 130 kN crimping force	ECW-H3D
	5	Q10-5	4,5	5,3	16,0	10,0	8,0	1.500/100					
	6	Q10-6	4,5	6,5	17,0	11,0	8,0	1.000/100					
	8	Q10-8	4,5	8,4	20,0	14,0	8,0	1.000/100					
	10	Q10-10	4,5	10,5	21,0	18,0	8,0	1.000/100					
10÷16	12	Q10-12	4,5	13,0	22,0	22,0	8,0	500/100					
	5	Q16-5	5,8	5,3	20,0	11,0	10,0	1.000/100					
	6	Q16-6	5,8	6,5	20,0	11,0	10,0	1.000/100					
	8	Q16-8	5,8	8,4	22,0	14,0	10,0	500/100					
16÷25	10	Q16-10	5,8	10,5	24,0	18,0	10,0	500/100					
	12	Q16-12	5,8	13,0	26,0	22,0	10,0	500/100					
	5	Q25-5	7,5	5,3	25,0	12,0	11,0	500/100					
	6	Q25-6	7,5	6,5	25,0	12,0	11,0	500/100					
	8	Q25-8	7,5	8,4	25,0	16,0	11,0	500/100					
25÷35	10	Q25-10	7,5	10,5	26,0	18,0	11,0	500/100					
	12	Q25-12	7,5	13,0	31,0	22,0	11,0	500/100					
	16	Q25-16	7,5	17,0	35,0	28,0	11,0	200/100					
	6	Q35-6	9,0	6,5	26,0	15,0	12,0	400/100					
	8	Q35-8	9,0	8,4	26,0	16,0	12,0	400/100					
35÷50	10	Q35-10	9,0	10,5	27,0	18,0	12,0	300/100					
	12	Q35-12	9,0	13,0	31,0	22,0	12,0	250/50					
	16	Q35-16	9,0	17,0	36,0	28,0	12,0	200/50					
	6	Q50-6	11,0	6,5	34,0	18,0	16,0	200/50					
50÷70	8	Q50-8	11,0	8,4	34,0	18,0	16,0	200/50					
	10	Q50-10	11,0	10,5	34,0	18,0	16,0	200/50					
	12	Q50-12	11,0	13,0	36,0	22,0	16,0	200/50					
	16	Q50-16	11,0	17,0	40,0	28,0	16,0	200/50					
70÷95	6	Q70-6	13,0	6,5	38,0	22,0	18,0	100/50					
	8	Q70-8	13,0	8,4	38,0	22,0	18,0	100/50					
	10	Q70-10	13,0	10,5	38,0	22,0	18,0	100/50					
	12	Q70-12	13,0	13,0	38,0	22,0	18,0	100/50					
	16	Q70-16	13,0	17,0	42,0	28,0	18,0	100/50					
70÷95	8	Q95-8	15,0	8,4	42,0	24,0	20,0	100/25					
	10	Q95-10	15,0	10,5	42,0	24,0	20,0	100/25					
	12	Q95-12	15,0	13,0	44,0	24,0	20,0	100/25					
	16	Q95-16	15,0	17,0	70,0	28,0	20,0	100/25					

CRIMPING CONNECTORS ACCORDING TO DIN 46234

for Copper conductors

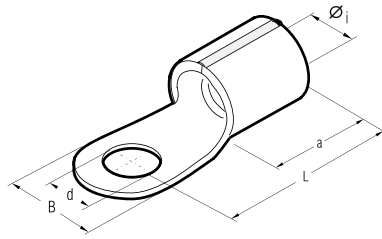

Conductor Size sqmm	Ø Stud mm	Type	Dimensions mm					Quantity Box/Bag	Hydraulic Tools	
			Øi	d	L	B	a		HT120 and tools and heads with 130 kN crimping force	ECW-H3D
95÷120	8	Q120-8	16,5	8,4	44,0	24,0	22,0	100/25		
	10	Q120-10	16,5	10,5	44,0	24,0	22,0	100/25		
	12	Q120-12	16,5	13,0	44,0	24,0	22,0	100/25		
	16	Q120-16	16,5	17,0	48,0	28,0	22,0	50/25		
120:150	10	Q150-10	19,0	10,5	50,0	30,0	24,0	50/25		
	12	Q150-12	19,0	13,0	50,0	30,0	24,0	50/25		
	16	Q150-16	19,0	17,0	50,0	30,0	24,0	50/25		
150÷185	10	Q185-10	21,0	10,5	50,0	36,0	28,0	40/20		
	12	Q185-12	21,0	13,0	50,0	36,0	28,0	40/20		
	16	Q185-16	21,0	17,0	50,0	36,0	28,0	30/15		
185÷240	10	Q240-10	23,5	10,5	56,0	38,0	32,0	10/10		
	12	Q240-12	23,5	13,0	56,0	38,0	32,0	10/10		
	16	Q240-16	23,5	17,0	56,0	38,0	32,0	10/10		

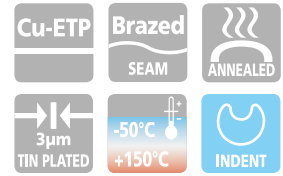

Consult us for special requirements.

Consult us for further information.

A-M

COPPER TUBE CRIMPING LUGS

for Copper conductors

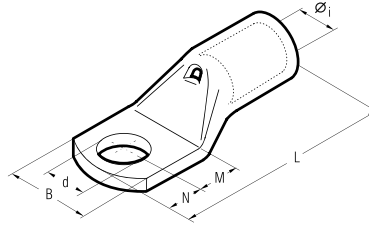

A-M series lugs are manufactured from electrolytic Copper tube with a purity greater than 99.9%. The dimensions of the tube are designed to obtain the most efficient electrical conductivity and mechanical strength to resist vibration and pull out.

CEMBRE lugs are annealed to guarantee optimum ductility which is an absolute necessity for connectors which will have to withstand the severe deformation arising when compressed and any bending of the palm during installation.

In applications subject to vibration, lugs still have to provide a reliable connection and annealing plays a vital role in avoiding cracking or breaks between the barrel and palm.

The presence of an inspection hole facilitates full insertion of the conductor, whilst the barrel length has been designed to allow easy and accurate positioning of the dies during the crimping operation.

Lugs are electrolytically Tin plated to avoid oxidation. A-M series lugs form an important part of CEMBRE crimping systems for power carrying conductors, details of the appropriate crimping tools and dies are shown opposite and in detail on pages 368 to 369.

Our technicians are always available to provide any technical advice which may be required.

The enclosed table is only indicative of the range and many variations in stud fixing and palm lengths are also available.

Conductor Size sqmm	Ø Stud mm	Type	Dimensions mm							Quantity Box/Bag	Mechanical Tools	Hydraulic Tools
			Øi	B	M	N	L	d				
0,25÷1,5	3	A03-M3*	1,8	6,0	4,5	3,5	16,0	3,2	5.000/100	HN1	B15MD	
	3,5	A03-M3.5*	1,8	6,5	4,5	3,5	16,0	3,7	5.000/100			
	4	A03-M4*	1,8	6,5	5,0	4,0	17,0	4,3	5.000/100			
	5	A03-M5*	1,8	7,5	5,5	4,5	18,0	5,3	5.000/100			
	6	A03-M6*	1,8	9,0	6,0	5,0	19,0	6,4	5.000/100			
	3	A06-M3*	2,4	6,0	4,5	3,5	17,0	3,2	4.000/100			
1,5÷2,5	3,5	A06-M3.5*	2,4	6,5	4,5	3,5	17,0	3,7	4.000/100			
	4	A06-M4*	2,4	7,5	5,0	4,0	18,0	4,3	4.000/100			
	5	A06-M5*	2,4	8,5	5,5	4,5	19,0	5,3	4.000/100			
	6	A06-M6*	2,4	9,0	6,0	5,0	20,0	6,4	4.000/100			
	8	A06-M8*	2,4	12,0	9,0	8,0	26,0	8,4	2.500/100			
	3	A1-M3	3,6	7,5	4,5	3,5	20,5	3,2	2.000/100			HN5
3,5	A1-M3.5	3,6	7,5	4,5	3,5	20,5	3,7	2.000/100				
4	A1-M4	3,6	8,0	5,0	4,0	21,5	4,3	2.000/100				
5	A1-M5	3,6	9,0	6,5	6,0	25,0	5,3	2.000/100				
6	A1-M6	3,6	11,0	7,0	6,0	25,5	6,4	1.500/100				
8	A1-M8	3,6	14,0	9,0	8,0	29,5	8,4	1.500/100				
10	A1-M10	3,6	16,5	11,0	10,0	34,0	10,5	1.000/100				
4	A2-M4	4,6	10,0	5,0	4,0	22,5	4,3	1.500/100	HN5	B15MD		
5	A2-M5	4,6	10,0	6,5	6,0	26,0	5,3	1.000/100				
6	A2-M6	4,6	11,0	7,0	6,0	26,5	6,4	1.000/100				
8	A2-M8	4,6	15,0	9,0	8,0	30,5	8,4	1.000/100				
10	A2-M10	4,6	18,0	11,0	10,0	34,5	10,5	500/100				
12	A2-M12	4,6	19,0	14,0	12,0	39,5	13,2	500/100				
4	A3-M4	5,8	11,5	5,0	4,0	25,5	4,3	1.000/100			HN5	B15MD
5	A3-M5	5,8	11,5	6,5	6,0	29,0	5,3	1.000/100				
6	A3-M6	5,8	11,5	7,0	6,0	29,5	6,4	1.000/100				
8	A3-M8	5,8	15,0	9,0	8,0	33,5	8,4	500/100				
10	A3-M10	5,8	18,0	11,0	10,0	37,5	10,5	500/100				
12	A3-M12	5,8	20,0	14,0	12,0	44,0	13,2	500/100				
4	A5-M4	7,0	14,0	5,0	4,0	28,0	4,3	500/100	TN70SE	B15MD		
5	A5-M5	7,0	14,0	6,5	6,0	31,5	5,3	500/100				
6	A5-M6	7,0	14,0	7,0	6,0	32,0	6,4	500/100				
8	A5-M8	7,0	15,0	9,0	8,0	36,0	8,4	500/100				
10	A5-M10	7,0	18,0	11,0	10,0	40,0	10,5	500/100				
12	A5-M12	7,0	21,0	14,0	12,0	45,0	13,2	400/100				
5	A7-M5	8,9	17,0	6,5	6,0	34,0	5,3	400/100			TN120SE	B15MD
6	A7-M6	8,9	17,0	7,0	6,0	34,5	6,4	400/100				
8	A7-M8	8,9	17,0	9,0	8,0	38,5	8,4	400/100				
10	A7-M10	8,9	19,0	11,0	10,0	42,5	10,5	300/100				
12	A7-M12	8,9	21,0	14,0	12,0	47,5	13,2	200/50				
6	A10-M6	10,0	19,0	8,0	7,0	38,5	6,4	200/50				
8	A10-M8	10,0	19,0	9,0	8,0	40,5	8,4	200/50				
10	A10-M10	10,0	20,0	11,5	9,5	44,5	10,5	200/50				
12	A10-M12	10,0	21,0	12,0	12,0	47,5	13,2	200/50				
14	A10-M14	10,0	25,0	16,0	14,0	55,5	15,0	200/50				
16	A10-M16	10,0	26,0	18,0	16,0	59,5	17,0	100/50				
6	A14-M6	11,3	21,0	8,0	7,0	44,0	6,4	200/50	TN120SE	B15MD		
8	A14-M8	11,3	21,0	9,0	8,0	46,0	8,4	200/50				
10	A14-M10	11,3	21,0	11,0	10,0	50,0	10,5	200/50				
12	A14-M12	11,3	22,0	14,0	12,0	55,0	13,2	150/50				
14	A14-M14	11,3	25,0	16,0	14,0	59,0	15,0	100/50				
16	A14-M16	11,3	26,0	18,0	16,0	63,0	17,0	100/50				

*Not UL approved

COPPER TUBE CRIMPING LUGS

for Copper conductors

A-M

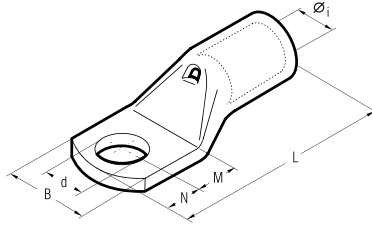

Conductor Size sqmm		Type	Dimensions mm							Quantity Box/Bag	Mechanical Tools	Hydraulic Tools
Low Str.	Flex*		Ø Stud mm	Øi	B	M	N	L	d			
95	70 95	6 A19-M6	13,5	25,0	8,0	7,0	50,5	6,4	100/25	TNI20SE** HT45-E B450ND-BV	HT51 RH50 B500ND RH60C HT60C B600C B600CND RH81-UD RHU81-D HT120 and tools and heads with 130 kN crimping force ECW-H3D RHU520	
		8 A19-M8	13,5	25,0	9,0	8,0	52,5	8,4	100/25			
		10 A19-M10	13,5	25,0	11,0	10,0	56,5	10,5	100/25			
		12 A19-M12	13,5	25,0	14,0	12,0	61,5	13,2	100/25			
		14 A19-M14	13,5	25,0	16,0	14,0	65,5	15,0	100/25			
		16 A19-M16	13,5	27,0	18,0	16,0	69,5	17,0	50/25			
20 A19-M20	13,5	29,5	22,0	20,0	77,5	21,0	50/25					
120	95 120	8 A24-M8	15,2	28,5	9,0	8,0	54,0	8,4	75/25			
		10 A24-M10	15,2	28,5	11,0	10,0	58,0	10,5	75/25			
		12 A24-M12	15,2	28,5	14,0	12,0	63,0	13,2	75/25			
		14 A24-M14	15,2	28,5	16,0	14,0	67,0	15,0	50/25			
		16 A24-M16	15,2	28,5	18,0	16,0	71,0	17,0	50/25			
		20 A24-M20	15,2	30,0	22,0	20,0	79,0	21,0	50/25			
150	120 150	8 A30-M8	16,7	31,5	13,0	11,0	69,0	8,4	50/25			
		10 A30-M10	16,7	31,5	13,0	11,0	69,0	10,5	50/25			
		12 A30-M12	16,7	31,5	16,0	14,0	75,0	13,2	50/25			
		14 A30-M14	16,7	31,5	18,0	16,0	79,0	15,0	50/25			
		16 A30-M16	16,7	31,5	19,0	17,0	81,0	17,0	50/25			
		20 A30-M20	16,7	31,5	22,0	20,0	87,0	21,0	50/25			
185	150 185	8 A37-M8	19,2	35,5	13,0	11,0	76,0	8,4	30/15			
		10 A37-M10	19,2	35,5	13,0	11,0	76,0	10,5	30/15			
		12 A37-M12	19,2	35,5	16,0	14,0	82,0	13,2	30/15			
		14 A37-M14	19,2	35,5	18,0	16,0	86,0	15,0	30/15			
		16 A37-M16	19,2	35,5	19,0	17,0	88,0	17,0	30/15			
		20 A37-M20	19,2	35,5	22,0	20,0	94,0	21,0	30/15			
240	185 240	8 A48-M8	21,1	39,0	13,0	11,0	77,5	8,4	20/10			
		10 A48-M10	21,1	39,0	13,0	11,0	77,5	10,5	20/10			
		12 A48-M12	21,1	39,0	14,0	12,0	79,5	13,2	20/10			
		14 A48-M14	21,1	39,0	18,0	16,0	92,0	15,0	20/10			
		16 A48-M16	21,1	39,0	19,0	17,0	94,0	17,0	20/10			
		20 A48-M20	21,1	39,0	22,0	20,0	100,0	21,0	20/10			
300	240 300	10 A60-M10	23,7	44,0	20,0	11,0	96,0	10,5	20/10			
		12 A60-M12	23,7	44,0	20,0	14,0	99,0	13,2	20/10			
		14 A60-M14	23,7	44,0	22,0	16,0	103,0	15,0	20/10			
		16 A60-M16	23,7	44,0	22,0	19,0	106,0	17,0	20/10			
		20 A60-M20	23,7	44,0	24,0	23,0	112,0	21,0	20/10			
		12 A80-M12	27,0	51,0	22,0	19,0	113,0	13,2	15/5			
400	300 400	14 A80-M14	27,0	51,0	22,0	19,0	113,0	15,0	15/5			
		16 A80-M16	27,0	51,0	22,0	19,0	113,0	17,0	15/5			
		20 A80-M20	27,0	51,0	24,0	23,0	119,0	21,0	15/5			
		16 A100-M16	30,3	56,5	22,0	19,0	117,0	17,0	10/1			
500	400 500	20 A100-M20	30,3	56,5	24,0	23,0	123,0	21,0	10/1			
		16 A120-M16*	33,4	61,6	22,0	19,0	128,0	17,0	9/1			
630	500 630	20 A120-M20*	33,4	61,6	24,0	23,0	134,0	21,0	9/1			
		16 A160-M16*	38,0	72,0	24,0	19,0	141,0	17,0	5/1			
800	630 800	20 A160-M20*	38,0	72,0	24,0	23,0	145,0	21,0	6/1			
		16 A200-M16*	44,0	80,0	24,0	19,0	158,0	17,0	5/1			
1000	800 1000	20 A200-M20*	44,0	80,0	24,0	23,0	162,0	21,0	5/1			

*Actual conductor section may require a larger lug eg for 120mm² size use A30-... lug.

**See page 203

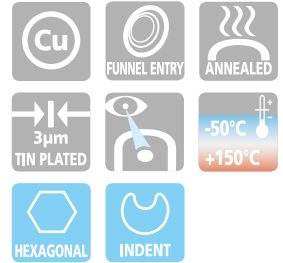

*Not UL approved

A-M

RING TONGUE TERMINALS WITH CONTAINED PALM

for L.V. circuit breakers - for Copper conductors

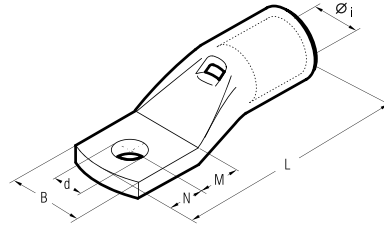

Cond. Size Flexible sqmm	Ø Stud mm	Type	Dimensions mm						Quantity Box/Bag	Mechanical Tools	Hydraulic Tools										
			Øi	B	M	N	L	d													
10	5	A2-M5/9	4,6	9,0	6,5	6,0	26,0	5,3	1.000/100	HN5	HN-A25	TN70SE	TN120SE	HT45-E B450ND-BV	HT151	RH50 B500 B500ND	RH60C HT60C B600C B600CND	HT81-UD RHU81-D	HTT20 and heads with 130 kN crimping force	ECW-H3D	RHU520
16	5	A3-M5/9	5,8	9,0	6,5	6,0	30,5	5,3	1.000/100												
25	5	A5-M5/9	7,0	9,0	6,5	6,0	31,5	5,3	500/100												
	6	A5-M6/11	7,0	11,0	7,0	6,0	32,0	6,4	500/100												
	8	A5-M8/13.5	7,0	13,5	9,0	8,0	36,0	8,4	500/100												
35	10	A5-M10/14	7,0	14,0	11,0	10,0	40,0	10,5	500/100												
	6	A7B-M6/11.5*	8,9	11,5	8,0	7,0	36,5	6,4	400/100												
50	8	A7B-M8/14*	8,9	14,0	9,0	8,0	38,5	8,4	400/100												
	6	A10B-M6/11.5*	10,0	11,5	8,0	7,0	40,5	6,4	200/50												
70	8	A10B-M8/14*	10,0	14,0	9,0	8,0	42,5	8,4	200/50												
	6	A14B-M6/11.5*	11,3	11,5	8,0	7,0	44,5	6,4	200/50												
95	8	A14B-M8/15.5*	11,3	15,5	9,0	8,0	46,0	8,4	200/50												
	8	A19B-M8/15.5*	13,5	15,5	9,0	8,0	52,5	8,4	100/25												
120	8	A19-M8/19	13,5	19,0	9,0	8,0	52,5	8,4	100/25												
	10	A19-M10/19	13,5	19,0	9,0	8,0	52,5	10,5	100/25												
	8	A24B-M8/19*	15,2	19,0	14,0	9,0	60,0	8,4	75/25												
150	10	A24B-M10/19*	15,2	19,0	14,0	9,0	60,0	10,5	75/25												
	8	A30B-M8/19*	16,7	19,0	18,0	9,0	70,0	8,4	50/25												
185	10	A30B-M10/19*	16,7	19,0	18,0	9,0	70,0	10,5	50/25												
	10	A37B-M10/24.5*	19,2	24,5	18,0	9,0	77,0	10,5	30/15												
240	12	A37-M12/31	19,2	31,0	16,0	12,0	80,0	13,2	30/15												
	10	A48B-M10/31	21,1	31,0	13,0	9,0	80,0	10,5	20/10												
	12	A48B-M12/31*	21,1	31,0	14,0	12,0	79,5	13,2	20/10												
	12	A48-M12/31	21,1	31,0	16,0	12,0	86,0	13,2	20/10												
	16	A48-M16/31	21,1	31,0	19,0	17,0	94,0	17,0	20/10												
300	10	A60B-M10/31*	23,7	31,0	16,0	12,0	95,0	10,5	20/10												
	12	A60B-M12/31*	23,7	31,0	16,0	12,0	95,0	13,2	20/10												
400	12	A80-M12/41	27,0	41,0	22,0	19,0	113,0	13,2	15/5												
800	20	A160B-M20S/61*	38,0	61,0	31,5	34,0	163,5	21,0	6/2												

*Without inspection hole

This range of terminals features contained palm width and has been specifically developed for application on L.V. circuit breakers with reduced space terminal blocks.

The contained palm width allows an immediate and easier installation.

CEMBRE terminals are manufactured from electrolytic Copper tube with a purity greater than 99.9%.

The specifically designed section of the barrel and the choice of principal dimensions are optimising the best combination of mechanical strength and electrical conductivity.

These terminals are annealed to guarantee optimum ductility and are electrolytically Tin plated to avoid oxidation.

The barrel is provided with an internal taper to ease the introduction of the conductor; furthermore, its length grants a comfortable and correct positioning between dies, during crimping operations.

Each palm is marked with the CEMBRE logo and part number.

Easy to install via cable gland, allows for pre-installation.

Details of the appropriate crimping tools and dies are shown on pages 368 to 369.



COPPER TUBE CRIMPING LUGS

for extra flexible Copper conductors

A-M

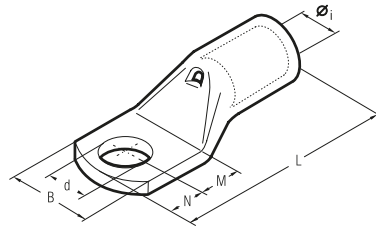

• for fine stranded •
SPECIAL
flexible conductors



Conductor Size Extra Flexible sqmm	Ø Stud mm	Type	Dimensions mm						Quantity Box/Bag	Mechanical Tools	Hydraulic Tools						
			Øi	B	M	N	L	d									
35	6	A9-M6/15	9,3	15,0	8,0	7,0	38,5	6,4	400/100	TN120SE	HT45-E B450ND-BV	HT51 RH50 B500	RH60C HT60C B600C B600CND	HT81-UD RHU81-D	HT120 and tools and heads with 130kN crimping force	ECW-H3D	RHU520
	8	A9-M8	9,3	17,0	9,0	8,0	40,5	8,4	400/100								
	10	A9-M10	9,3	18,5	11,0	10,0	44,5	10,5	300/100								
	12	A9-M12	9,3	21,0	14,0	12,0	49,5	13,2	200/50								
50	6	A12-M6/15	11,0	15,0	8,0	7,0	40,5	6,4	200/50								
	8	A12-M8	11,0	19,3	9,0	8,0	42,5	8,4	200/50								
	10	A12-M10	11,0	19,3	11,0	10,0	46,5	10,5	200/50								
	10	A12-M10/19	11,0	19,0	11,0	10,0	46,5	10,5	200/50								
	12	A12-M12	11,0	22,0	14,0	12,0	51,5	13,2	200/50								
70	6	A17-M6	13,0	23,0	8,0	7,0	45,0	6,4	200/50								
	8	A17-M8	13,0	23,0	9,0	8,0	47,0	8,4	150/50								
	10	A17-M10	13,0	23,0	11,0	10,0	51,0	10,5	150/50								
	10	A17-M10/19	13,0	19,0	11,0	10,0	51,0	10,5	200/50								
	12	A17-M12	13,0	23,0	14,0	12,0	56,0	13,2	150/50								
	14	A17-M14	13,0	25,0	15,5	12,0	57,5	15,0	150/25								
95	16	A17-M16	13,0	27,0	16,5	13,5	60,0	17,0	100/25								
	8	A20-M8	15,0	27,0	9,0	8,0	50,0	8,4	100/25								
	10	A20-M10	15,0	27,0	11,0	10,0	54,0	10,5	100/25								
	12	A20-M12	15,0	27,0	14,0	12,0	59,0	13,2	100/25								
	14	A20-M14	15,0	27,0	15,5	12,0	60,5	15,0	100/25								
120	16	A20-M16	15,0	27,0	16,5	13,5	63,0	17,0	100/25								
	8	A29-M8	16,5	30,0	9,0	8,0	53,5	8,4	50/25								
	10	A29-M10	16,5	30,0	11,0	10,0	57,5	10,5	50/25								
	12	A29-M12	16,5	30,0	14,0	12,0	62,5	13,2	50/25								
	14	A29-M14	16,5	30,0	15,5	12,0	64,0	15,0	100/25								
	16	A29-M16	16,5	30,0	16,5	13,5	66,5	17,0	50/25								
150	20	A29-M20	16,5	30,0	22,0	20,0	78,5	21,0	75/25								
	10	A35-M10	19,2	34,2	13,0	11,0	65,5	10,5	50/25								
	12	A35-M12	19,2	34,2	16,0	14,0	71,5	13,2	50/25								
	14	A35-M14	19,2	34,2	18,0	16,0	75,5	15,0	50/25								
	16	A35-M16	19,2	34,2	19,0	17,0	77,5	17,0	30/15								
185	20	A35-M20	19,2	34,2	22,0	20,0	83,5	21,0	30/15								
	10	A40-M10	21,0	37,5	13,0	11,0	73,0	10,5	30/15								
	12	A40-M12	21,0	37,5	16,0	14,0	79,0	13,2	30/15								
	14	A40-M14	21,0	37,5	18,0	16,0	83,0	15,0	30/15								
	16	A40-M16	21,0	37,5	19,0	17,0	85,0	17,0	30/15								
	20	A40-M20	21,0	37,5	22,0	20,0	91,0	21,0	30/15								

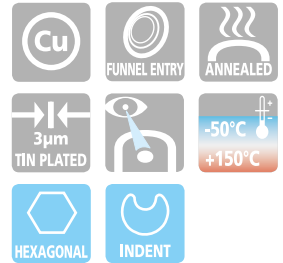

These lugs are particularly recommended for use with extra flexible conductors on for instance, welding machines.

A-M series lugs are designed to suit panel applications.

The dimensions of the tube are designed to obtain the most efficient electrical conductivity and mechanical strength to resist vibration and pull out.

CEMBRE lugs are annealed to guarantee optimum ductility and electrolytically Tin plated to avoid oxidation.

The presence of an inspection hole facilitates full insertion of the conductor.

Details of the appropriate crimping tools and dies are shown on pages 368 to 369.

A-L

COPPER TUBE CRIMPING LUGS ANGLED 90°

for Copper conductors

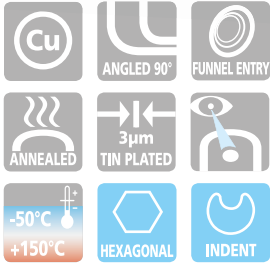
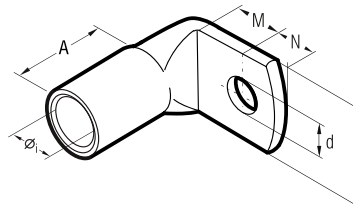

A-L series lugs angled 90° are manufactured from electrolytic Copper tube with a purity greater than 99.9%.

The dimensions of the tube are designed to obtain the most efficient electrical conductivity and mechanical strength to resist vibration and pull out.

CEMBRE lugs are annealed to guarantee optimum ductility which is an absolute necessity for connectors which will have to withstand the severe deformation arising when compressed and any bending of the palm during installation.

In applications subject to vibration, terminals still have to perform a reliable connection, annealing plays a vital role in avoiding cracking or breaks between the barrel and palm.

The presence of an inspection hole facilitates full insertion of the conductor, whilst the barrel length has been designed to allow easy and accurate positioning of the dies during the crimping operation. Lugs are electrolytically Tin plated to avoid oxidation.

Details of the appropriate crimping tools and dies are shown on pages 368 to 369.

Conductor Size sqmm	Ø Stud mm	Type	Dimensions mm						Quantity Box/Bag	Mechanical Tools		Hydraulic Tools	
			Øi	B	M	N	A	d					
6	6	A1-L6*	3,6	11,0	7,0	6,0	8,0	6,4	2.000/100				
10	4	A2-L4	4,6	10,0	5,0	4,0	8,0	4,3	1.500/100	HNT			
	5	A2-L5	4,6	10,0	6,5	6,0	8,0	5,3	1.000/100				
	6	A2-L6	4,6	11,0	7,0	6,0	8,0	6,4	1.000/100				
16	8	A2-L8	4,6	15,0	9,0	8,0	8,0	8,4	500/100				
	5	A3-L5	5,8	11,5	6,5	6,0	11,5	5,3	1.000/100	HNS			
	6	A3-L6	5,8	11,5	7,0	6,0	11,5	6,4	1.000/100	HN-A25			
25	8	A3-L8	5,8	15,0	9,0	8,0	11,5	8,4	500/100				
	10	A3-L10	5,8	18,0	11,0	10,0	11,5	10,5	500/100				
	5	A5-L5	7,0	14,0	6,5	6,0	10,5	5,3	500/100				
35	6	A5-L6	7,0	14,0	7,0	6,0	10,5	6,4	500/100				
	8	A5-L8	7,0	15,0	9,0	8,0	10,5	8,4	500/100				
	10	A5-L10	7,0	18,0	11,0	10,0	10,5	10,5	500/100				
50	6	A7-L6	8,9	17,0	7,0	6,0	13,2	6,4	300/100				
	8	A7-L8	8,9	17,0	9,0	8,0	13,2	8,4	300/100				
	10	A7-L10	8,9	19,0	11,0	10,0	13,2	10,5	300/100				
70	12	A7-L12	8,9	21,0	14,0	12,0	13,2	13,2	300/100				
	6	A10-L6	10,0	19,0	8,0	7,0	16,5	6,4	300/100				
	8	A10-L8	10,0	19,0	9,0	8,0	16,5	8,4	200/100				
95	10	A10-L10	10,0	20,0	11,5	9,5	16,5	10,5	200/50				
	12	A10-L12	10,0	21,0	12,0	12,0	16,5	13,2	200/50				
	8	A14-L8	11,3	21,0	9,0	8,0	18,0	8,4	200/50				
120	10	A14-L10	11,3	21,0	11,0	10,0	18,0	10,5	100/50				
	12	A14-L12	11,3	22,0	14,0	12,0	18,0	13,2	100/50				
	16	A14-L16	11,3	26,0	18,0	16,0	18,0	17,0	150/50				
150	8	A19-L8	13,5	25,0	9,0	8,0	22,5	8,4	100/25				
	10	A19-L10	13,5	25,0	11,0	10,0	22,5	10,5	100/25				
	12	A19-L12	13,5	25,0	14,0	12,0	22,5	13,2	100/25				
185	10	A24-L10	15,2	28,5	11,0	10,0	24,0	10,5	50/25				
	12	A24-L12	15,2	28,5	14,0	12,0	24,0	13,2	50/25				
	10	A30-L10	16,7	31,5	13,0	11,0	26,5	10,5	50/25				
240	12	A30-L12	16,7	31,5	16,0	14,0	26,5	13,2	50/25				
	10	A37-L10	19,2	35,5	13,0	11,0	29,0	10,5	30/15				
	12	A37-L12	19,2	35,5	16,0	14,0	29,0	13,2	30/25				
300	10	A48-L10	21,1	39,0	13,0	11,0	33,0	10,5	30/15				
	12	A48-L12	21,1	39,0	16,0	14,0	33,0	13,2	20/10				
	12	A60-L12	23,7	44,0	20,0	14,0	40,0	13,2	20/10				

*Actual conductor section may require a larger lug eg for 120mm² size use A30... lug.

**See page 203

*Not UL approved

COPPER TUBE CRIMPING LUGS

double hole fixing - for Copper conductors

A-2M

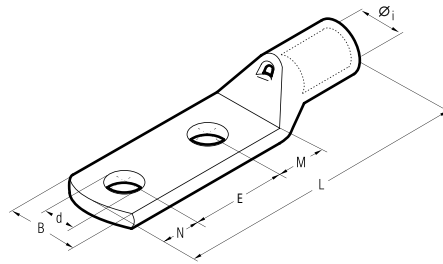

Conductor Size sqmm	Ø Stud mm	Type	Dimensions mm							Quantity Box/Bag	Mechanical Tools	Hydraulic Tools
			Øi	B	M	N	E	L	d			
10	4	A2-2M4-12	4,6	10,0	5,0	4,0	12,0	36,5	4,3	100	HN1 HN5 HN-A25	B15MD
	8	A2-2M8-20	4,6	15,0	11,0	11,0	20,0	57,5	8,4	100		
16	8	A3-2M8-20	5,8	15,0	11,0	11,0	20,0	62,0	8,4	50	HN-A25	B15MD
	12	A3-2M12-40	5,8	20,0	14,0	12,0	40,0	82,5	13,2	200/50		
25	8	A5-2M8-20	7,0	15,0	9,0	11,0	20,0	59,0	8,4	400/100	TN70SE	B15MD
	8	A5-2M8-24-24	7,0	15,0	24,0	11,0	24,0	78,0	8,4	300/100		
	10	A5-2M10-24-13	7,0	18,0	13,0	11,0	24,0	67,0	10,5	300/100		
35	10	A7-2M10	8,9	19,0	11,0	10,0	44,5	87,0	10,5	100/50	TN70SE	B15MD
	10	A7-2M10-25	8,9	19,0	12,0	11,0	25,0	69,5	10,5	100		
	12	A7-2M12	8,9	21,0	16,0	14,0	44,5	96,0	13,2	200/100		
	12	A7-2M12-25	8,9	21,0	16,0	14,0	25,0	76,5	13,2	50		
	12	A7-2M12-40	8,9	21,0	16,0	14,0	40,0	91,5	13,2	150/50		
50	6	A10-2M6	10,0	19,0	8,0	11,0	44,5	89,0	6,4	50	TN70SE	B15MD
	8	A10-2M8	10,0	19,0	11,0	11,0	44,5	92,0	8,4	100/50		
	8	A10-2M8-20	10,0	19,0	11,0	11,0	20,0	67,5	8,4	100/50		
	8	A10-2M8-22	10,0	19,0	11,0	11,0	22,0	69,5	8,4	150/50		
	8	A10-2M8-30	10,0	19,0	11,0	11,0	30,0	77,5	8,4	150/50		
	8	A10-2M8-24-24	10,0	19,0	24,0	11,0	24,0	84,5	8,4	150/50		
	10	A10-2M10	10,0	20,0	13,0	11,0	44,5	94,0	10,5	100/50		
	10	A10-2M10-24-13	10,0	19,0	13,0	11,0	24,0	73,5	10,5	150/50		
	12	A10-2M12	10,0	21,0	16,0	14,0	44,5	100	13,2	100/50		
	12	A10-2M12-25	10,0	21,0	16,0	14,0	25,0	80,5	13,2	50		
70	8	A14-2M8	11,3	21,0	11,0	11,0	44,5	95,5	8,4	50	TN70SE	B15MD
	8	A14-2M8-24-24	11,3	21,0	24,0	11,0	24,0	88,0	8,4	100/50		
	10	A14-2M10	11,3	21,0	13,0	11,0	44,5	97,5	10,5	100/50		
	10	A14-2M10-24	11,3	21,0	13,0	11,0	24,0	77,0	10,5	100/50		
	12	A14-2M12	11,3	22,0	16,0	14,0	44,5	103,5	13,2	100/50		
	12	A14-2M12-25	11,3	22,0	16,0	14,0	25,0	84,0	13,2	100/50		
	12	A14-2M12-30-29	11,3	22,0	29,0	14,0	30,0	102,0	13,2	100/50		
	12	A14-2M12-40	11,3	22,0	16,0	14,0	40,0	99,0	13,2	100/50		
14	A14-2M14	11,3	25,0	18,0	16,0	44,5	107,5	15,0	100/50			
95	6	A19-2M6	13,5	25,0	10,0	11,0	44,5	101,0	6,4	25	TN70SE	B15MD
	8	A19-2M8-50 S	13,5	25,0	15,0	15,0	50,0	115,5	8,4	75/25		
	10	A19-2M10	13,5	25,0	13,0	11,0	44,5	104,0	10,5	50/25		
	10	A19-2M10-24-13	13,5	25,0	13,0	11,0	24,0	83,5	10,5	75/25		
	10	A19-2M10-24-26	13,5	25,0	26,0	11,0	24,0	96,5	10,5	50/25		
	10	A19-2M10-40	13,5	25,0	13,0	11,0	40,0	99,5	10,5	75/25		
	12	A19-2M12	13,5	25,0	16,0	14,0	44,5	110,0	13,2	75/25		
	12	A19-2M12-25	13,5	25,0	16,0	14,0	25,0	90,5	13,2	25		
	12	A19-2M12-30-29	13,5	25,0	29,0	14,0	30,0	108,5	13,2	50/25		
	14	A19-2M14	13,5	25,0	18,0	16,0	44,5	114,0	15,0	100/25		
120	16	A19-2M16	13,5	25,0	19,0	17,0	44,5	116,0	17,0	50/25	TN70SE	B15MD
	8	A24-2M8-20	15,2	28,5	11,0	11,0	20,0	79,0	8,4	25		
	8	A24-2M8-24-29	15,2	28,5	29,0	11,0	24,0	101,0	8,4	50/25		
	10	A24-2M10	15,2	28,5	13,0	11,0	44,5	105,5	10,5	50/25		
	10	A24-2M10-22	15,2	28,5	13,0	11,0	22,0	83,0	10,5	50/25		
	10	A24-2M10-25/24	15,2	24,0	13,0	11,0	25,0	86,0	10,5	50/25		
	10	A24-2M10-33.5	15,2	28,5	13,0	11,0	33,5	94,5	10,5	50/25		
	10	A24L-2M10-30AS	15,2	28,5	13,0	11,0	30,0	91,0	10,5	25		
	12	A24-2M12	15,2	28,5	16,0	14,0	44,5	113,0	13,2	50/25		
	12	A24-2M12-30-29	15,2	28,5	29,0	14,0	30,0	110,0	13,2	50/25		
	12	A24-2M12-40	15,2	28,5	16,0	14,0	40,0	107,0	13,2	50/25		
	14	A24-2M14	15,2	28,5	18,0	16,0	44,5	115,5	15,0	50/25		
16	A24-2M16	15,2	28,5	19,0	17,0	44,5	117,5	17,0	50/25			



A-2M series lugs are manufactured from electrolytic copper tube with a purity greater than 99.9%.

The dimensions of the tube are designed to obtain the most efficient electrical conductivity and mechanical strength to resist vibration and pull out.

The double hole fixing ensures greater mechanical stability even in the presence of electrodynamic stresses.

CEMBRE lugs are annealed to guarantee optimum ductility, an absolute necessity for connectors which will have to withstand the severe deformation arising when compressed and any bending of the palm during installation.

In applications subject to vibration, terminals still have to perform a reliable connection, annealing plays a vital role in avoiding cracking or breaks between the barrel and palm.

The presence of an inspection hole facilitates full insertion of the conductor, whilst the barrel length has been designed to allow easy and accurate positioning of the dies during the crimping operation. Lugs are electrolytically tinplated to avoid oxidation.

A-2M series lugs form an important part of CEMBRE crimping systems for power carrying conductors, details of the appropriate crimping tools and dies are shown opposite and in detail on page 368 to 369, whilst our technicians are always available to provide any technical advice which may be required.

The enclosed table is only indicative of the range and many variations in stud fixing and palm lengths are also available.

double hole fixing - for Copper conductors

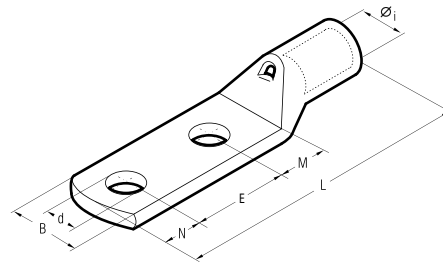

Conductor Size sqmm	Ø Stud mm	Type	Dimensions mm							Quantity Box/Bag	Mechanical Tools	Hydraulic Tools
			Øi	B	M	N	E	L	d			
150	8	A30-2M8-20	16,7	31,5	13,0	11,0	20,0	89,0	8,4	50/25	TN120SE*	
	10	A30-2M10	16,7	31,5	13,0	11,0	44,5	113,5	10,5	50/25		
	10	A30-2M10-24-28	16,7	31,5	28,0	11,0	24,0	108,0	10,5	50/25		
	12	A30-2M12	16,7	31,5	16,0	14,0	44,5	119,5	13,2	50/25		
	12	A30-2M12-30	16,7	31,5	16,0	14,0	30,0	105,0	13,2	50/25		
	12	A30-2M12-30-29	16,7	31,5	29,0	14,0	30,0	118,0	13,2	30/15		
	12	A30-2M12-40	16,7	31,5	16,0	14,0	40,0	115,0	13,2	30/15		
	14	A30-2M14	16,7	31,5	18,0	16,0	44,5	123,5	15,0	50/25		
185	14	A30-2M14-33.5	16,7	31,5	18,0	16,0	33,5	112,5	15,0	50/25	HT51	RH50 B500 B500ND RH60C HT60C B600CND HT81-UD RHU81-D HT120 and tools and heads with 130 kN crimping force ECW-H3D RHU520
	10	A37-2M10	19,2	35,5	13,0	11,0	44,5	120,5	10,5	30/15		
	10	A37-2M10-25	19,2	35,5	13,0	11,0	25,0	101,0	10,5	30/15		
	12	A37-2M12	19,2	35,5	16,0	14,0	44,5	126,5	13,2	30/15		
	12	A37-2M12-32	19,2	35,5	16,0	14,0	32,0	114,0	13,2	30/15		
	12	A37-2M12-30-31	19,2	35,5	31,0	14,0	30,0	127,0	13,2	30/15		
	14	A37-2M14	19,2	35,5	18,0	16,0	44,5	130,5	15,0	30/15		
	14	A37-2M14-35	19,2	35,5	18,0	16,0	35,0	121,0	15,0	30/15		
240	16	A37-2M16	19,2	35,5	19,0	17,0	44,5	132,5	17,0	30/15	HT51	RH50 B500 B500ND RH60C HT60C B600CND HT81-UD RHU81-D HT120 and tools and heads with 130 kN crimping force ECW-H3D RHU520
	16	A37-2M16-40	19,2	35,5	19,0	17,0	40,0	128,0	17,0	30/15		
	10	A48-2M10	21,1	39,0	13,0	11,0	44,5	126,5	10,5	30/15		
	10	A48-2M10-20	21,1	39,0	13,0	11,0	20,0	102,0	10,5	30/15		
	10	A48-2M10-35	21,1	39,0	13,0	11,0	35,0	117,0	10,5	30/15		
	12	A48-2M12	21,1	39,0	16,0	14,0	44,5	132,5	13,2	30/15		
	12	A48-2M12-35	21,1	39,0	16,0	14,0	35,0	123,0	13,2	30/15		
	12	A48-2M12-40	21,1	39,0	16,0	14,0	40,0	128,0	13,2	30/15		
300	12	A48-2M12-30-31	21,1	39,0	31,0	14,0	30,0	133,0	13,2	20/10	HT51	RH50 B500 B500ND RH60C HT60C B600CND HT81-UD RHU81-D HT120 and tools and heads with 130 kN crimping force ECW-H3D RHU520
	14	A48-2M14	21,1	39,0	18,0	16,0	44,5	136,5	15,0	30/15		
	14	A48-2M14-40	21,1	39,0	18,0	16,0	40,0	132,0	15,0	30/15		
	16	A48-2M16	21,1	39,0	19,0	17,0	44,5	138,5	17,0	30/15		
	10	A60-2M10	23,7	44,0	13,0	11,0	44,5	133,5	10,5	20/5		
	12	A60-2M12	23,7	44,0	20,0	14,0	44,5	143,5	13,2	20/5		
	12	A60-2M12-40	23,7	44,0	20,0	14,0	40,0	139,0	13,2	20/5		
	12	A60-2M12-30-38	23,7	44,0	38,0	14,0	30,0	147,0	13,2	20/5		
400	14	A60-2M14	23,7	44,0	22,0	16,0	44,5	147,5	15,0	20/5	HT51	RH50 B500 B500ND RH60C HT60C B600CND HT81-UD RHU81-D HT120 and tools and heads with 130 kN crimping force ECW-H3D RHU520
	16	A60-2M16-40	23,7	44,0	22,0	17,0	40,0	144,0	17,0	20/5		
	16	A60-2M16	23,7	44,0	22,0	17,0	44,5	148,5	17,0	20/5		
	16	A60-2M16-35	23,7	44,0	22,0	17,0	35,0	139,0	17,0	20/5		
	16	A60-2M16/36	23,7	36,0	22,0	17,0	44,5	148,5	17,0	20/5		
	12	A80-2M12	27,0	51,0	22,0	14,0	44,5	152,5	13,2	15/5		
500	14	A80-2M14	27,0	51,0	22,0	16,0	44,5	154,5	15,0	15/5	HT51	RH50 B500 B500ND RH60C HT60C B600CND HT81-UD RHU81-D HT120 and tools and heads with 130 kN crimping force ECW-H3D RHU520
	14	A80-2M14-40	27,0	51,0	22,0	16,0	40,0	150,0	15,0	15/5		
	16	A80-2M16	27,0	51,0	22,0	19,0	44,5	157,5	17,0	15/5		
	16	A80-2M16-40	27,0	51,0	22,0	19,0	40,0	153,0	17,0	15/5		
	16	A80-2M16/41	27,0	41,0	22,0	19,0	44,5	157,5	17,0	15/5		
	16	A80-2M16-50	27,0	51,0	22,0	19,0	50,0	163,0	17,0	5		
630	12	A100-2M12	30,3	56,5	20,0	14,0	44,5	152,0	13,2	10/1	HT51	RH50 B500 B500ND RH60C HT60C B600CND HT81-UD RHU81-D HT120 and tools and heads with 130 kN crimping force ECW-H3D RHU520
	14	A100-2M14-40	30,3	56,5	17,0	16,0	40,0	149,0	15,0	1		
	14	A100-2M14	30,3	56,5	17,0	16,0	44,5	153,5	15,0	10/1		
800	16	A100-2M16	30,3	56,5	19,0	19,0	44,5	158,5	17,0	10/5	HT51	RH50 B500 B500ND RH60C HT60C B600CND HT81-UD RHU81-D HT120 and tools and heads with 130 kN crimping force ECW-H3D RHU520
	12	A120-2M12*	33,4	61,6	22,0	14,0	44,5	167,5	13,2	20/5		
800	16	A120-2M16*	33,4	61,6	22,0	19,0	44,5	172,5	17,0	8/1	HT51	RH50 B500 B500ND RH60C HT60C B600CND HT81-UD RHU81-D HT120 and tools and heads with 130 kN crimping force ECW-H3D RHU520
	12	A160-2M12*	38,0	72,0	20,0	14,0	44,5	176,5	13,2	9/3		
800	16	A160-2M16*	38,0	72,0	22,0	19,0	44,5	183,5	17,0	9/3	HT51	RH50 B500 B500ND RH60C HT60C B600CND HT81-UD RHU81-D HT120 and tools and heads with 130 kN crimping force ECW-H3D RHU520

*See page 203

*Not UL approved

COPPER TUBE CRIMPING LUGS ANGLED 315° and 345°

A-2M

double hole fixing - for Copper conductors

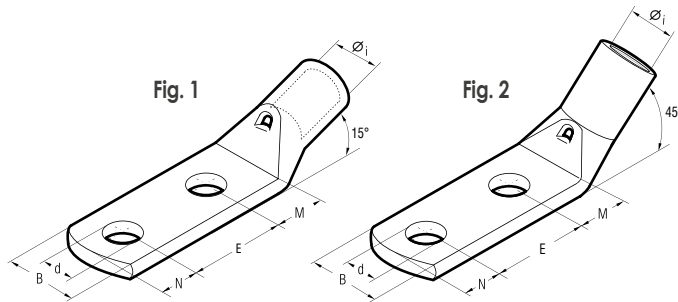

Conductor Size sqmm	Ø Stud mm	Type	Fig. N.	Dimensions mm						Quantity Box/Bag	Mechanical Tools	Hydraulic Tools
				Øi	B	M	N	E	d			
25	8	A5-2M8-24-24/345	1	7,0	15,0	24,0	11,0	24,0	8,4	300/100	HN-A25	HT45-E B450ND-BV
	12	A5-2M12-3029/345	1	7,0	21,0	29,0	14,0	30,0	13,2	200/100		
50	8	A10-2M8-2424/345	1	10,0	19,0	24,0	11,0	24,0	8,4	150/50	TN70SE	HT51 B500ND
	10	A14-2M102426/315	2	11,3	21,0	26,0	11,0	24,0	10,5	100/50		
70	10	A14-2M102426/345	1	11,3	21,0	26,0	11,0	24,0	10,5	100/50	TN120SE*	RH50 B600C B600CND
	12	A14-2M123029/345	1	11,3	22,0	29,0	14,0	30,0	13,2	100/50		
95	8	A19-2M8-2424/345	1	13,5	25,0	24,0	11,0	24,0	8,4	75/25	RH60C HT60C B600C	HT81-UD RHU81-D
	10	A19-2M102426/345	1	13,5	25,0	26,0	11,0	24,0	10,5	25		
120	12	A19-2M123029/345	1	13,5	25,0	29,0	14,0	30,0	13,2	75/25	RH81-UD RHU81-D	ECW-H3D
	8	A24-2M8-2429/345	1	15,2	28,5	29,0	11,0	24,0	8,4	50/25		
150	10	A24-2M102429/345	1	15,2	28,5	29,0	11,0	24,0	10,5	50/25	RHU520	RHU520
	12	A24-2M123029/345	1	15,2	28,5	29,0	14,0	30,0	13,2	50/25		
185	8	A30-2M8-2429/345	1	16,7	31,5	29,0	11,0	24,0	8,4	30/15	HT120 and tools and heads with 130 kN crimping force	RHU520
	10	A30-2M102428/345	1	16,7	31,5	28,0	11,0	24,0	10,5	50/25		
240	12	A30-2M123029/345	1	16,7	31,5	29,0	14,0	30,0	13,2	40/20	RHU520	RHU520
	10	A37-2M10-25/315	2	19,2	35,5	13,0	11,0	25,0	10,5	15		
300	12	A37-2M123031/345	1	19,2	35,5	31,0	14,0	30,0	13,2	30/15	RHU520	RHU520
	12	A48-2M12/345	1	21,1	39,0	16,0	14,0	44,5	13,2	20/10		
300	12	A48-2M12-30/45	1	21,1	39,0	16,0	14,0	30,0	13,2	20/10	RHU520	RHU520
	12	A48-2M123031/345	1	21,1	39,0	31,0	14,0	30,0	13,2	20/10		
300	12	A60-2M123038/345	1	23,7	44,0	38,0	14,0	30,0	13,2	20/10	RHU520	RHU520

*See page 203

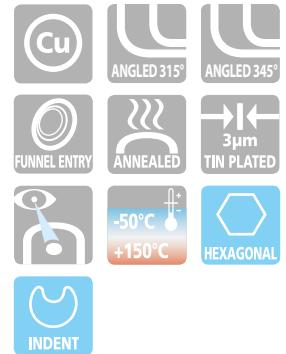

A-2M series lugs angled 315° and 345° are manufactured from electrolytic copper tube with a purity greater than 99.9%.

The dimensions of the tube are designed to obtain the most efficient electrical conductivity and mechanical strength to resist vibration and pull out.

The double hole fixing ensures greater mechanical stability even in the presence of electrodynamic stresses.

CEMBRE lugs are annealed to guarantee optimum ductility, an absolute necessity for connectors which will have to withstand the severe deformation arising when compressed and any bending of the palm during installation.

In applications subject to vibration, terminals still have to perform a reliable connection, annealing plays a vital role in avoiding cracking or breaks between the barrel and palm.

The presence of an inspection hole facilitates full insertion of the conductor, whilst the barrel length has been designed to allow easy and accurate positioning of the dies during the crimping operation. Lugs are electrolytically tinplated to avoid oxidation.

Details of the appropriate crimping tools and dies are shown on pages 368 to 369.

2A-M

HEAVY DUTY COPPER TUBE TERMINALS

for Copper conductors

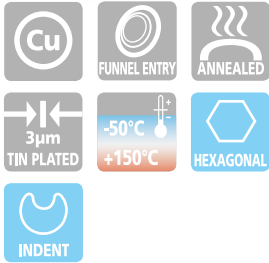
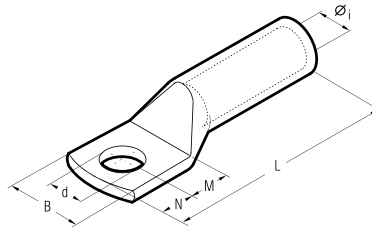

The 2A-M series cable lugs are designed for heavy duty, for grounding structures and equipment both indoors and outdoors and for medium voltage applications up to 35 kV.

2A-M series terminals are made from high purity Copper tube with a purity greater than 99.9%, and are annealed.

They feature a double length barrel for enhanced electrical and mechanical performance in heavy duty applications.

The absence of an inspection hole prevents the entry of water or moisture into the crimped joint making these terminals suitable for outdoor applications.

The terminals are electrolytically Tin plated to prevent atmospheric corrosion.

Details of the appropriate crimping tools and dies are shown on pages 368 to 369.

Conductor Size sqmm	Ø Stud mm	Type	Dimensions mm						Quantity Box/Bag	Mechanical Tools	Hydraulic Tools	
			Øi	B	M	N	L	d				
16	8	2A3-M8	5,8	15,0	9,0	8,0	43,5	8,4	600/100	HNS	B15MD	
	10	2A3-M10	5,8	18,0	11,0	10,0	47,5	10,5	500/100			
25	8	2A5-M8	7,0	15,0	9,0	8,0	51,0	8,4	400/100	HN-A25		
	10	2A5-M10	7,0	18,0	11,0	10,0	55,0	10,5	300/50			
35	12	2A5-M12	7,0	21,0	14,0	12,0	60,0	13,2	300/50	TN70SE		
	8	2A7-M8	8,9	17,0	9,0	8,0	53,0	8,4	200/50			
50	10	2A7-M10	8,9	19,0	11,0	10,0	57,0	10,5	200/50	TN70SE		
	12	2A7-M12	8,9	21,0	14,0	12,0	62,0	13,2	200/50			
63	10	2A10-M10	10,0	20,0	11,0	10,0	63,0	10,5	100/50	TN120 SE*		
	12	2A10-M12	10,0	21,0	14,0	12,0	68,0	13,2	100/50			
70	14	2A10-M14	10,0	25,0	16,0	14,0	72,0	15,0	150/50	TN120 SE*		
	16	2A10-M16	10,0	26,0	18,0	16,0	76,0	17,0	150/50			
95	10	2A14-M10	11,3	21,0	11,0	10,0	70,0	10,5	100/50	TN120 SE*		
	12	2A14-M12	11,3	22,0	14,0	12,0	75,0	13,2	100/50			
120	14	2A14-M14	11,3	25,0	16,0	14,0	79,0	15,0	100/50	TN120 SE*		
	16	2A14-M16	11,3	26,0	18,0	16,0	83,0	17,0	100/50			
125	10	2A19-M10	13,5	25,0	11,0	10,0	76,5	10,5	50/25	TN120 SE*		
	12	2A19-M12	13,5	25,0	14,0	12,0	81,5	13,2	50/25			
150	14	2A19-M14	13,5	25,0	16,0	14,0	85,5	15,0	75/25	TN120 SE*		
	16	2A19-M16	13,5	27,0	18,0	16,0	90,5	17,0	50/25			
185	20	2A19-M20	13,5	29,5	22,0	20,0	97,5	21,0	50/25	TN120 SE*		
	10	2A24-M10	15,2	28,5	11,0	10,0	82,0	10,5	30/15			
240	12	2A24-M12	15,2	28,5	14,0	12,0	87,0	13,2	30/15	TN120 SE*		
	14	2A24-M14	15,2	28,5	16,0	14,0	91,0	15,0	30/15			
300	16	2A24-M16	15,2	28,5	18,0	16,0	95,0	17,0	30/15	TN120 SE*		
	20	2A24-M20	15,2	30,0	22,0	20,0	103,0	21,0	50/25			
400	12	2A30-M10	16,7	31,5	13,0	11,0	92,0	10,5	30/15	TN120 SE*		
	10	2A30-M12	16,7	31,5	16,0	14,0	98,0	13,2	30/15			
480	14	2A30-M14	16,7	31,5	18,0	16,0	102,0	15,0	30/15	TN120 SE*		
	16	2A30-M16	16,7	31,5	19,0	17,0	104,0	17,0	30/15			
600	20	2A30-M20	16,7	31,5	22,0	20,0	110,0	21,0	30/15	TN120 SE*		
	12	2A37-M12	19,2	35,5	16,0	14,0	108,0	13,2	20/10			
720	14	2A37-M14	19,2	35,5	18,0	16,0	112,0	15,0	30/15	TN120 SE*		
	16	2A37-M16	19,2	35,5	19,0	17,0	114,0	17,0	30/15			
840	20	2A37-M20	19,2	35,5	22,0	20,0	120,0	21,0	30/15	TN120 SE*		
	12	2A48-M12	21,1	39,0	16,0	14,0	109,0	13,2	20/5			
1000	14	2A48-M14	21,1	39,0	18,0	16,0	113,0	15,0	20/5	TN120 SE*		
	16	2A48-M16	21,1	39,0	19,0	17,0	115,0	17,0	20/5			
1200	20	2A48-M20	21,1	39,0	22,0	20,0	121,0	21,0	25/5	TN120 SE*		
	12	2A60-M12	23,7	44,0	20,0	14,0	129,5	13,2	15/5			
1440	14	2A60-M14	23,7	44,0	22,0	16,0	133,5	15,0	15/5	TN120 SE*		
	16	2A60-M16	23,7	44,0	22,0	19,0	136,5	17,0	15/5			
1710	20	2A60-M20	23,7	44,0	24,0	23,0	142,5	21,0	15/5	TN120 SE*		
	12	2A80-M12	27,0	51,0	22,0	19,0	140,0	13,2	15/5			
2025	14	2A80-M14	27,0	51,0	22,0	19,0	140,0	15,0	10/5	TN120 SE*		
	16	2A80-M16	27,0	51,0	22,0	19,0	140,0	17,0	10/5			
2430	20	2A80-M20	27,0	51,0	24,0	23,0	146,0	21,0	15/5	TN120 SE*		
	16	2A100-M16	30,3	56,5	22,0	19,0	141,0	17,0	10/1			
2835	20	2A100-M20	30,3	56,5	24,0	23,0	147,0	21,0	10/1	TN120 SE*		
	16	2A120-M16*	33,4	61,5	22,0	19,0	159,0	17,0	20/1			
3240	20	2A120-M20*	33,4	61,5	24,0	23,0	165,0	21,0	20/1	TN120 SE*		
	800	2A160-M20*	38,0	72,0	24,0	23,0	187,0	21,0	12/1			
3645	1000	2A200-M20*	44,0	80,0	24,0	23,0	202,0	21,0	6/1	TN120 SE*		

*See page 203

*Not UL approved

HEAVY DUTY COPPER TUBE TERMINALS

2A-2M

double hole fixing - for Copper conductors

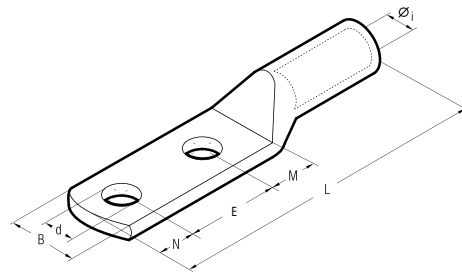

Conductor Size sqmm	Ø Stud mm	Type	Dimensions mm							Quantity Box/Bag	Mechanical Tools	Hydraulic Tools
			Øi	B	M	N	E	L	d			
50	12	2A10-2M12	10,0	21,0	14,0	12,0	44,5	112,5	13,2	75/25	TN70SE	B450ND-BV
70	12	2A14-2M12	11,3	22,0	16,0	14,0	44,5	123,5	13,2	50/25		
	14	2A14-2M14	11,3	25,0	18,0	16,0	44,5	127,5	15,0	75/25	TN120 SE*	B450ND-BV
95	12	2A19-2M12	13,5	25,0	16,0	14,0	44,5	128,0	13,2	50/25		
	14	2A19-2M14	13,5	25,0	18,0	16,0	44,5	132,0	15,0	50/25	HT45-E	HT51
120	12	2A24-2M12	15,2	28,5	16,0	14,0	44,5	135,5	13,2	50/25		
	14	2A24-2M14	15,2	28,5	18,0	16,0	44,5	139,5	15,0	50/25	RH50 B500	RH60C B600C
150	16	2A24-2M16	15,2	28,5	18,0	17,0	44,5	140,5	17,0	50/25		
	12	2A30-2M12	16,7	31,5	16,0	14,0	44,5	142,5	13,2	30/15	HT81-UD	RHU81-D
	14	2A30-2M14	16,7	31,5	18,0	16,0	44,5	146,5	15,0	30/15		
185	12	2A37-2M12	19,2	35,5	16,0	14,0	44,5	152,5	13,2	30/15	ECW-H3D	RHU520
	14	2A37-2M14	19,2	35,5	18,0	16,0	44,5	156,5	15,0	30/15		
	16	2A37-2M16	19,2	35,5	19,0	17,0	44,5	158,5	17,0	30/15		
240	12	2A48-2M12	21,1	39,0	16,0	14,0	44,5	153,5	13,2	20/5	HT70 and tools and heads with 130 kN crimping force	RHU520
	14	2A48-2M14	21,1	39,0	18,0	16,0	44,5	157,5	15,0	25/5		
	16	2A48-2M16	21,1	39,0	19,0	17,0	44,5	159,5	17,0	25/5		
	12	2A60-2M12	23,7	44,0	20,0	14,0	44,5	174,0	13,2	15/5	HT70 and tools and heads with 130 kN crimping force	RHU520
300	14	2A60-2M14	23,7	44,0	22,0	16,0	44,5	178,0	15,0	20/5		
	16	2A60-2M16	23,7	44,0	19,0	17,0	44,5	176,0	17,0	20/5		
	12	2A80-2M12	27,0	51,0	20,0	14,0	44,5	177,5	13,2	10/5	HT70 and tools and heads with 130 kN crimping force	RHU520
400	14	2A80-2M14	27,0	51,0	22,0	16,0	44,5	181,5	15,0	10/5		
	16	2A80-2M16	27,0	51,0	22,0	19,0	44,5	184,5	17,0	15/5		
	12	2A100-2M12	30,3	56,5	20,0	14,0	44,5	178,5	13,2	10/1	HT70 and tools and heads with 130 kN crimping force	RHU520
500	14	2A100-2M14	30,3	56,5	22,0	16,0	44,5	182,5	15,0	10/1		
	16	2A100-2M16	30,3	56,5	22,0	19,0	44,5	185,5	17,0	8/1		
	12	2A120-2M12*	33,4	61,5	20,0	14,0	44,5	196,5	13,2	15/1	HT70 and tools and heads with 130 kN crimping force	RHU520
630	14	2A120-2M14*	33,4	61,5	22,0	19,0	44,5	200,5	15,0	15/1		
	16	2A120-2M16*	33,4	61,5	22,0	19,0	44,5	203,5	17,0	10/1		
	14	2A160-2M14*	38,0	72,0	22,0	19,0	44,5	225,5	15,0	10/1	HT70 and tools and heads with 130 kN crimping force	RHU520
800	16	2A160-2M16*	38,0	72,0	24,0	19,0	44,5	227,5	17,0	10/1		
	12	2A200-2M12*	44,0	80,0	20,0	14,0	44,5	233,5	13,2	6/2		
1000	16	2A200-2M16*	44,0	80,0	22,0	19,0	44,5	240,5	17,0	5/1	HT70 and tools and heads with 130 kN crimping force	RHU520
	20	2A200-2M20*	44,0	80,0	24,0	23,0	44,5	246,5	21,0	6/2		

*See page 203

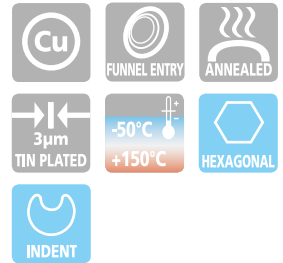

The 2A-2M series cable lugs are designed for heavy duty, for grounding structures and equipment both indoors and outdoors and for medium voltage applications up to 35 kV.

2A-2M series terminals are made from high purity Copper tube with a purity greater than 99.9%, and are annealed.

They feature a double length barrel for enhanced electrical and mechanical performance in heavy duty applications.

The double hole fixing ensures greater mechanical stability even in the presence of electrodynamic stresses.

The absence of an inspection hole prevents the entry of water or moisture into the crimped joint making these terminals suitable for outdoor applications.

The terminals are electrolytically Tin plated to prevent atmospheric corrosion.

Details of the appropriate crimping tools and dies are shown on pages 368 to 369.

*Not UL approved

L-M

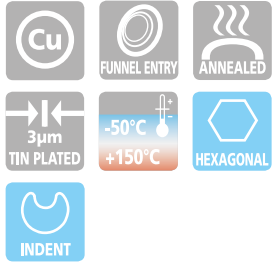

L-M range of connectors are designed for jointing low voltage conductors.

Made of electrolytic Copper tube with a purity greater than 99.9%, having the same dimension as A-M series lugs: L-M connectors are annealed and electrolytically Tin plated.

They feature an internal taper at both ends to ease the introduction of the conductor and a central stop to ensure correct positioning. Details of the appropriate crimping tools and dies are shown on pages 368 to 369.

THROUGH CONNECTORS

for Copper conductors

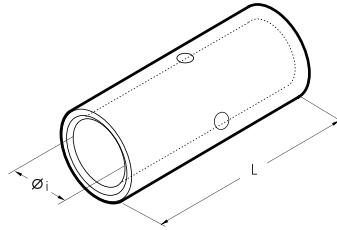

Conductor Size sqmm		Type	Dimensions mm		Quantity Box/Bag	Mechanical Tools	Hydraulic Tools
Low Stranded	Flexible		øi	L			
0,25÷1,5	0,25÷1,5	L03-M*	1,8	15	5.000/100	HN1 HN5 HN-A25 TN70SE TN120 SE* B15MD HT45-E B450ND-BV HT51 RH50 B500 B500ND RH60C HT60C B600C B600CND HT81-UD RHU81-D HT120 and tools and heads with 130 kN crimping force ECW-H3D RHU520	
1,5÷2,5	1,5÷2,5	L06-M*	2,4	15	4.000/100		
4÷6	4÷6	L1-M	3,6	22	2.000/100		
10	10	L2-M	4,6	25	1.000/100		
16	16	L3-M	5,8	27	500/100		
25	25	L5-M	7,0	29	500/100		
35	25÷35	L7-M	8,9	33	400/100		
50	35÷50	L10-M	10,0	37	200/50		
70	50÷70	L14-M	11,3	39	200/50		
95	70÷95	L19-M	13,5	43	100/25		
120	95÷120	L24-M	15,2	47	75/25		
150	120÷150	L30-M	16,7	58	50/25		
185	150÷185	L37-M	19,2	64	30/15		
240	185÷240	L48-M	21,1	75	20/10		
300	240÷300	L60-M	23,7	90	20/10		
400	300÷400	L80-M	27,0	94	15/5		
500	400÷500	L100-M	30,3	98	12/1		
630	500÷630	L120-M*	33,4	105	10/1		
800	600	L160-M*	38,0	112	6/1		
1000	800	L200-M*	44,0	120	6/1		

*See page 203

L-P

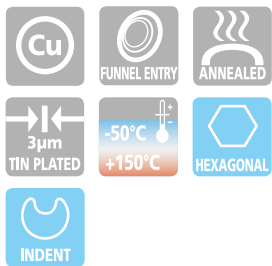

Made of electrolytic Copper tube with a purity greater than 99.9%, having the same dimensions as A-M series lugs, L-P connectors are annealed and electrolytically Tin plated.

They feature an internal taper to ease the introduction of the conductor.

Details of the appropriate crimping tools and dies are shown on pages 368 to 369.

PARALLEL CONNECTORS

for Copper conductors

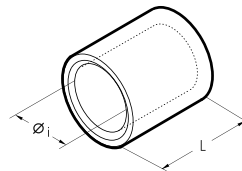

Total Conductor Size sqmm		Type	Dimensions mm		Quantity Box/Bag	Mechanical Tools	Hydraulic Tools
Low Stranded	Flexible		øi	L			
0,25÷1,5	0,25÷1,5	L03-P	1,8	6,0	8.000/100	HN1 HN5 HN-A25 TN70SE TN120 SE* B15MD HT45-E B450ND-BV HT51 RH50 B500 B500ND RH60C HT60C B600C B600CND HT81-UD RHU81-D HT120 and tools and heads with 130 kN crimping force ECW-H3D RHU520	
1,5÷2,5	1,5÷2,5	L06-P	2,4	6,0	5.000/100		
4÷6	4÷6	L1-P	3,6	9,0	3.000/100		
10	10	L2-P	4,6	10,5	2.000/100		
16	16	L3-P	5,8	11,5	1.500/100		
25	25	L5-P	7,0	13,0	1.000/100		
35	25÷35	L7-P	8,9	14,0	500/100		
50	35÷50	L10-P	10,0	16,0	500/100		
70	50÷70	L14-P	11,3	18,0	500/100		
95	70÷95	L19-P	13,5	19,0	200/50		
120	95÷120	L24-P	15,2	22,0	200/50		
150	120÷150	L30-P	16,7	26,5	100/50		
185	150÷185	L37-P	19,2	26,5	100/50		
240	185÷240	L48-P	21,1	34,0	60/15		
300	240÷300	L60-P	23,7	43,0	50/25		

*See page 203

*Not UL approved

COPPER TUBE LUGS 4-ESI FIXING

for Copper conductors

A-4ESI

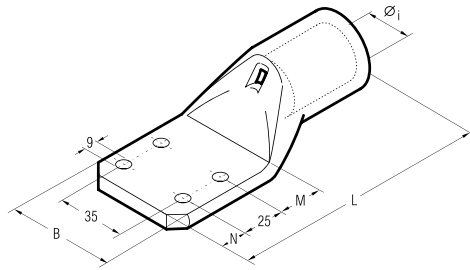

Conductor Size sqmm	Type	Dimensions mm					Quantity Box/Bag	Hydraulic Tools					
		Ø	B	M	N	L		HT51 B550	RH50 B500 B500ND	RH60C HT60C B600C B600CND	HT81-UD RHU81-D	HT 120 and tools and heads with 130 kN crimping force	ECW-H3D
185	A 37-4ESI	19,2	61,0	20	15	124	20/10						
240	A 48-4ESI	21,1	61,0	20	15	128	20/10						
300	A 60-4ESI	23,7	61,0	20	15	133	15/5						
400	A 80-4ESI	27,0	61,0	20	15	134	15/5						
500	A 100-4ESI	30,3	61,0	20	15	139	10/5						
630	A 120-4ESI	33,4	61,6	20	15	144	10/5						
800	A 160-4ESI	38,0	61,0	20	15	158	8/1						

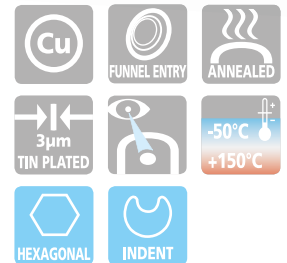

A-4ESI series lugs are made from electrolytic Copper tube with a purity greater than 99.9%, annealed and Tin plated.

The four hole stud fixing in accordance with E.A. specifications ensures compatibility with most transformer fixing arrangements.

Details of the appropriate crimping tools and dies are shown on pages 368 to 369.



A-P



Cu-ETP
Brazed
 SEAM
 ANNEALED
 3µm
 TIN PLATED
 -50°C
 +150°C
 INDENT
 HEXAGONAL

A-P series pin connectors are designed to terminate conductors into contact blocks. They are manufactured from Copper strip with a purity greater than 99.9%, rolled, brazed and Tin plated.

UNINSULATED PIN CONNECTORS

for Copper conductors

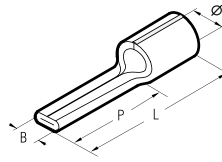

Conductor Size sqmm		Type	Dimensions mm				Quantity Box/Bag	Mechanical Tools				Hydraulic Tools												
Low Stranded	Flex		Øi	B	P	L		HN1	HN5	HN-A25	TN70SE	TN120SE	B15MD	HT45-E	B450ND-BV	HT51	RH50	B500	B500ND	RH60C	HT60C	B600C	B600CND	HT120 and tools and heads with 130 kN crimping force
10	10	A2-P12	4,8	4,3	14,5	23,5	1.500/100																	
16	16	A3-P14	5,9	5,5	18,0	28,0	1.000/100																	
25	25	A5-P16	7,0	7,0	20,3	32,0	500/100																	
35	25÷35	A7-P20	8,9	8,0	24,5	39,0	500/100																	
50	35÷50	A10-P25	10,0	9,5	26,0	45,0	250/50																	
70	50÷70	A14-P30	11,5	11,0	31,0	55,0	200/50																	

Details of the appropriate crimping tools and dies are shown on pages 368 to 369.

A-PR



Cu-ETP
Brazed
 SEAM
 ANNEALED
 3µm
 TIN PLATED
 -50°C
 +150°C
 INDENT
 HEXAGONAL

A-PR series pin connectors are designed to terminate conductors into contact blocks. They are manufactured from Copper strip with a purity greater than 99.9%, rolled, brazed and Tin plated.

UNINSULATED ROUND PIN CONNECTORS

for Copper conductors

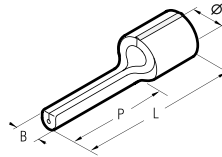

Conductor Size sqmm		Type	Dimensions mm				Quantity Box/Bag	Mechanical Tools				Hydraulic Tools												
Low Stranded	Flex		Øi	B	P	L		HN1	HN5	HN-A25	TN70SE	TN120SE	B15MD	HT45-E	B450ND-BV	HT51	RH50	B500	B500ND	RH60C	HT60C	B600C	B600CND	HT120 and tools and heads with 130 kN crimping force
16	16	A3-P22R	5,9	4,0	22,0	32,0	1.000/100																	
25	25	A5-P22R	7,0	4,0	22,0	33,7	500/100																	

Details of the appropriate crimping tools and dies are shown on pages 368 to 369.

UNINSULATED ROUND PIN CONNECTORS ANGLED 45°

for Copper conductors

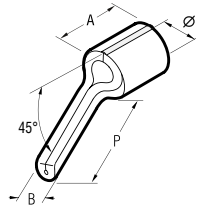

Conductor Size sqmm		Type	Dimensions mm				Quantity Box/Bag	Mechanical Tools				Hydraulic Tools										
Low Stranded	Flex		Øi	B	P	A		HN1	HNS	HN-A25	TN70SE	TN120SE	B15MD	HT45-E	B450ND-BV	HT51 RH50	B500 B500ND	RH60C	HT60C B600C	B600CND	HT120 and tools and heads with 130 kN crimping force	ECW-H3D
16	16	A3-P22R/45	5,9	4,0	22,0	10,0	1.000/100															
25	25	A5-P22R/45	7,0	4,0	22,0	11,7	500/100															

A-PR/45

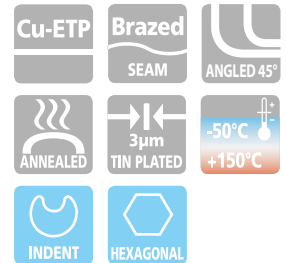

A-PR/45 series pin connectors are designed to terminate conductors into contact blocks.

They are manufactured from Copper strip with a purity greater than 99.9%, rolled, brazed and Tin plated.

Details of the appropriate crimping tools and dies are shown on pages 368 to 369.

UNINSULATED FORK TERMINALS

for Copper conductors

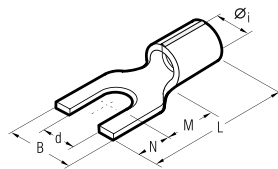

Conductor Size sqmm	Ø Stud mm	Type	Dimensions mm						Quantity Box/Bag	Mechanical Tools				Hydraulic Tools										
			Øi	B	M	N	L	d		HN1	HNS	HN-A25	TN70SE	TN120SE	B15MD	HT45-E	B450ND-BV	HT51 RH50	B500 B500ND	RH60C	HT60C B600C	B600CND	HT120 and tools and heads with 130 kN crimping force	ECW-H3D
10	4	A2-U4	4,8	9,8	7,5	7,0	23,5	4,3	1.500/100															
	5	A2-U5	4,8	11,5	7,5	7,0	23,5	5,3	1.500/100															
16	4	A3-U4	5,9	10,0	10,0	8,0	28,0	4,3	1.000/100															
	5	A3-U5	5,9	11,5	10,0	8,0	28,0	5,3	1.000/100															

A-U

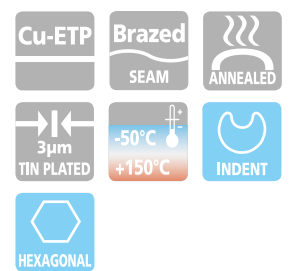

A-U series fork terminals are designed to terminate conductors into contact blocks.

Made from electrolytic Copper strip with a purity greater than 99.9%, rolled and Tin plated.

The seam is brazed to provide uniform mechanical strength.

The terminal barrel is rifled to enhance electrical contact and to improve mechanical strength. Recommended crimping tools are shown on pages 368 to 369.

for Copper conductors

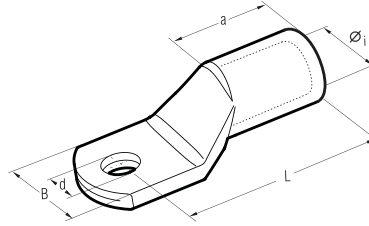

DR-N series lugs are manufactured from electrolytic Copper tube with a purity greater than 99.9%, and designed to obtain high electrical conductivity combined with the mechanical strength required to resist vibration and pull out.

CEMBRE lugs are annealed and Tin plated for improved surface protection.

The annealing process optimises the structural features of the material allowing easier crimping and greater resistance to mechanical stresses.

Dimensions are according to DIN 46235.

The barrel entrance of the lug is chamfered to allow easy conductor insertion, while its length facilitates precise positioning in the crimping die.

Each lug is marked with:

- CEMBRE logo and part code.
- conductor type and csa (mm²).
- stud Ø (mm).
- crimping die code

Details of the appropriate crimping tools and dies are shown on page 378.

Consult us for special requirements

Conductor Size sqmm	Ø Stud mm	Type	Code	Dimensions mm					Quantity Box/Bag	Mechanical Tools	Hydraulic Tools	
				Øi	d	L	B	a				
6	5	DR6-5N	5	3,8	5,3	25,0	8,5	10,0	800/100	HN-D25 TNE-D50	B15MD	
	6	DR6-6N	5	3,8	6,4	25,0	8,5	10,0	800/100			
	8	DR6-8N*	5	3,8	8,4	25,0	12,5	10,0	800/100			
10	5	DR10-5N	6	4,5	5,3	28,0	9,0	13,0	800/100			
	6	DR10-6N	6	4,5	6,4	28,0	9,0	13,0	800/100			
	8	DR10-8N*	6	4,5	8,4	28,0	13,0	13,0	800/100			
16	10	DR10-10N*	6	4,5	10,5	28,0	17,0	13,0	800/100			
	6	DR16-6N	8	5,5	6,4	37,0	13,0	20,0	400/100			
	8	DR16-8N	8	5,5	8,4	37,0	13,0	20,0	400/100			
25	10	DR16-10N	8	5,5	10,5	37,0	17,0	20,0	400/100			
	12	DR16-12N*	8	5,5	13,0	39,0	19,0	20,0	400/100			
	6	DR25-6N	10	7,0	6,4	39,0	14,0	20,0	400/100			
35	8	DR25-8N	10	7,0	8,4	39,0	16,0	20,0	300/100			
	10	DR25-10N	10	7,0	10,5	39,0	17,0	20,0	200/100			
	12	DR25-12N	10	7,0	13,0	40,0	19,0	20,0	200/100			
50	6	DR35-6N*	12	8,2	6,4	41,0	17,0	20,0	200/50			
	8	DR35-8N	12	8,2	8,4	43,0	17,0	20,0	200/50			
	10	DR35-10N	12	8,2	10,5	43,0	19,0	20,0	200/50			
70	12	DR35-12N	12	8,2	13,0	43,0	21,0	20,0	200/50			
	16	DR35-16N*	12	8,2	17,0	47,0	26,0	20,0	200/50			
	6	DR50-6N*	14	10,0	6,4	53,0	20,0	28,0	100/25			
95	8	DR50-8N	14	10,0	8,4	53,0	20,0	28,0	100/25			
	10	DR50-10N	14	10,0	10,5	53,0	22,0	28,0	100/25			
	12	DR50-12N	14	10,0	13,0	53,0	24,0	28,0	100/25			
120	16	DR50-16N	14	10,0	17,0	53,0	28,0	28,0	100/25			
	8	DR70-8N	16	11,5	8,4	56,0	24,0	28,0	50/25			
	10	DR70-10N	16	11,5	10,5	56,0	24,0	28,0	50/25			
150	12	DR70-12N	16	11,5	13,0	56,0	24,0	28,0	50/25			
	16	DR70-16N	16	11,5	17,0	56,0	30,0	28,0	50/25			
	20	DR70-20N*	16	11,5	21,0	64,0	30,0	28,0	50/25			
185	8	DR95-8N*	18	13,5	8,4	66,0	28,0	35,0	50/25			
	10	DR95-10N	18	13,5	10,5	66,0	28,0	35,0	50/25			
	12	DR95-12N	18	13,5	13,0	66,0	28,0	35,0	50/25			
240	16	DR95-16N	18	13,5	17,0	66,0	32,0	35,0	50/25			
	20	DR95-20N*	18	13,5	21,0	74,0	32,0	35,0	50/25			
	8	DR120-8N*	20	15,5	8,4	71,0	30,0	35,0	20/10			
185	10	DR120-10N	20	15,5	10,5	71,0	32,0	35,0	20/10			
	12	DR120-12N	20	15,5	13,0	71,0	32,0	35,0	20/10			
	16	DR120-16N	20	15,5	17,0	71,0	32,0	36,0	20/10			
240	20	DR120-20N	20	15,5	21,0	71,0	38,0	36,0	20/10			
	10	DR150-10N	22	17,0	10,5	79,0	34,0	39,0	30/15			
	12	DR150-12N	22	17,0	13,0	79,0	34,0	39,0	30/15			
185	16	DR150-16N	22	17,0	17,0	79,0	34,0	39,0	30/15			
	20	DR150-20N	22	17,0	21,0	79,0	40,0	39,0	30/15			
	10	DR185-10N	25	19,0	10,5	83,0	37,0	40,0	25/5			
240	12	DR185-12N	25	19,0	13,0	83,0	37,0	40,0	25/5			
	16	DR185-16N	25	19,0	17,0	83,0	37,0	40,0	25/5			
	20	DR185-20N	25	19,0	21,0	83,0	40,0	40,0	25/5			
185	10	DR240-10N*	28	21,5	10,5	92,0	42,0	46,0	20/10			
	12	DR240-12N	28	21,5	13,0	92,0	42,0	46,0	20/10			
	16	DR240-16N	28	21,5	17,0	93,0	42,0	46,0	20/10			
240	20	DR240-20N	28	21,5	21,0	93,0	45,0	46,0	20/10			

* Dimensions of the tube according to DIN 46235; Stud hole not included within the standard.

COPPER TUBE CRIMPING LUGS ACCORDING TO DIN 46235

for Copper conductors

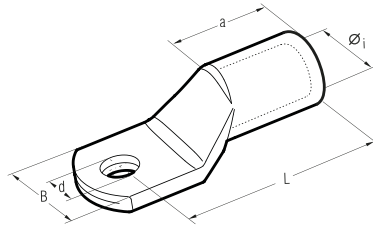

Conductor Size sqmm	Ø Stud mm	Type	Code	Dimensions mm					Quantity Box/Bag	Mechanical Tools	Hydraulic Tools		
				Øi	d	L	B	a			Hydraulic Tools		
300	12	DR300-12N*	32	24,5	13,0	101,0	48,0	51,0	10/5	TN60C	RH50 B500 B500ND	RH60C B600C B600CND	HT120 and tools and heads with 130 kN crimping force
	16	DR300-16N	32	24,5	17,0	101,0	48,0	51,0	10/5				
	20	DR300-20N	32	24,5	21,0	101,0	48,0	51,0	10/5				
400	12	DR400-12N**	38	27,5	13,0	116,0	55,0	70,0	5/1				
	16	DR400-16N*	38	27,5	17,0	116,0	55,0	70,0	5/1				
	20	DR400-20N*	38	27,5	21,0	116,0	55,0	70,0	5/1				
500	12	DR500-12N**	42	31,0	13,0	125,0	60,0	70,0	5/1				
	16	DR500-16N**	42	31,0	17,0	125,0	60,0	70,0	5/1				
	20	DR500-20N*	42	31,0	21,0	125,0	60,0	70,0	5/1				
625	12	DR625-12N*	44	34,5	13,0	136,0	60,0	80,0	5/1				
	16	DR625-16N*	44	34,5	17,0	136,0	60,0	80,0	5/1				
	20	DR625-20N*	44	34,5	21,0	136,0	60,0	80,0	5/1				
800	20	DR800-20N*	52	40,0	21,0	166,0	75,0	100,0	5/1				
1.000	20	DR1000-20N*	58	44,0	21,0	166,0	85,0	100,0	5/1				

* Dimensions of the tube according to DIN 46235; Stud hole not included within the standard.

**Not UL approved

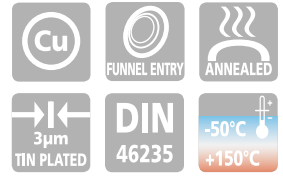

Consult us for special requirements

CRIMPING THROUGH CONNECTORS ACCORDING TO DIN 46267 T.1

for Copper conductors

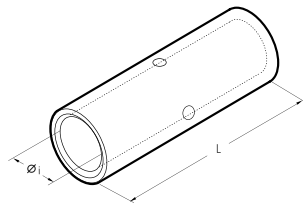

Conductor Size sqmm	Type	Code	Dimensions mm		Quantity Box/Bag	Mechanical Tools	Hydraulic Tools		
			Øi	L			Hydraulic Tools		
6	DSV6	5	3,7	30	1.200/100	TN60C	RH50 B500 B500ND	RH60C B600C B600CND	HT120 and tools and heads with 130 kN crimping force
10	DSV10	6	4,5	30	1.200/100				
16	DSV16	8	5,5	50	400/100				
25	DSV25	10	7,0	50	200/100				
35	DSV35	12	8,2	50	200/100				
50	DSV50	14	10,0	56	200/50				
70	DSV70	16	11,5	56	100/50				
95	DSV95	18	13,5	70	100/50				
120	DSV120	20	15,5	70	50/25				
150	DSV150	22	17,0	80	50/25				
185	DSV185	25	19,0	85	25/25				
240	DSV240	28	21,5	90	15/15				
300	DSV300	32	24,5	100	10/5				
400	DSV400	38	27,5	150	10/5				
500	DSV500	42	31,0	160	5/5				
625	DSV625	44	34,5	160	5/5				
800	DSV800	52	40,0	200	5/5				
1.000	DSV1000	58	44,0	200	5/5				

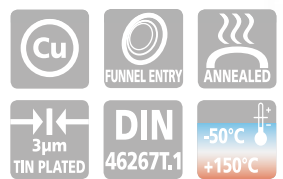

DSV series through connectors are manufactured from electrolytic Copper tube with a purity greater than 99.9%, annealed and surface protected by tin plating. Internal and external dimensions match those of DR series lugs. Chamfered ends and a central stop provide easy and correct insertion of the conductor. Details of the appropriate crimping tools and dies are shown on page 378.

Consult us for special requirements

HR-N

COPPER TUBE CRIMPING LUGS

for Copper conductors

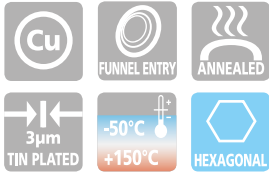
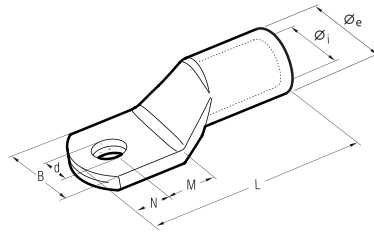

HR-N series lugs are manufactured from electrolytic Copper tube with a purity greater than 99.9%, and designed to obtain high electrical conductivity combined with the mechanical strength required to resist vibration and pull out.

CEMBRE lugs are annealed and Tin plated for improved surface protection.

The annealing process optimises the structural features of the material allowing easier crimping and greater resistance to mechanical stresses.

The barrel entrance of the lug is chamfered to allow easy conductor insertion, while its length facilitates precise positioning in the crimping die.

Each lug is marked with:

- CEMBRE logo and part code.
- conductor type and csa (mm²).
- stud Ø (mm).
- crimping die code

Details of the appropriate crimping tools and dies are shown on page 378.

Consult us for special requirements

Conductor Size sqmm	Ø Stud mm	Type	Dimensions mm							Quantity Box/Bag	Mechanical Tools		Hydraulic Tools		
			Øi	Øe	B	M	N	L	d						
6	4	HR6-4N	3,5	6,5	10,0	7,5	6,5	27,5	4,3	800/100	HIN1	HNS	HN-H25	B15MD	
	5	HR6-5N	3,5	6,5	10,0	7,5	6,5	27,5	5,3	800/100					
	6	HR6-6N	3,5	6,5	11,5	7,5	6,5	27,5	6,4	800/100					
	8	HR6-8N	3,5	6,5	15,0	10,0	10,0	33,5	8,4	800/100					
	10	HR6-10N	3,5	6,5	17,0	12,0	12,0	37,5	10,5	800/100					
	12	HR6-12N	3,5	6,5	19,0	15,0	13,5	42,0	13,2	800/100					
10	4	HR10-4N	4,5	7,0	12,0	7,5	6,5	28,5	4,3	600/100	TNE-H50	TN60C	HT45-E B450ND-BV		
	5	HR10-5N	4,5	7,0	12,0	7,5	6,5	28,5	5,3	600/100					
	6	HR10-6N	4,5	7,0	12,0	7,5	6,5	28,5	6,4	600/100					
	8	HR10-8N	4,5	7,0	15,0	10,0	10,0	34,5	8,4	600/100					
	10	HR10-10N	4,5	7,0	17,0	12,0	12,0	38,5	10,5	600/100					
	12	HR10-12N	4,5	7,0	19,0	13,0	13,0	40,5	13,2	600/100					
16	5	HR16-5N	5,5	8,5	12,0	7,0	6,0	31,5	5,3	400/100	TNE-H120	TN60C	HT51 RH50 RHMS0 B500 ND RH60C HT60C B600C B600CND HT81-UD RHU81-D		
	6	HR16-6N	5,5	8,5	12,0	7,5	6,5	32,5	6,4	400/100					
	8	HR16-8N	5,5	8,5	15,0	9,5	8,5	36,5	8,4	400/100					
	10	HR16-10N	5,5	8,5	17,0	11,5	10,5	40,5	10,5	400/100					
	12	HR16-12N	5,5	8,5	19,0	13,0	12,0	43,5	13,2	400/100					
	14	HR25-14N	7,0	10,0	21,0	14,0	14,5	50,5	15,0	200/100					
25	5	HR25-5N	7,0	10,0	14,0	7,5	7,5	37,0	5,3	400/100	TNE-H120	TN60C	HT51 RH50 RHMS0 B500 ND RH60C HT60C B600C B600CND HT81-UD RHU81-D		
	6	HR25-6N	7,0	10,0	14,0	7,5	7,5	37,0	6,4	200/100					
	8	HR25-8N	7,0	10,0	16,0	10,0	10,0	42,0	8,4	200/100					
	10	HR25-10N	7,0	10,0	18,0	12,0	12,0	46,0	10,5	200/100					
	12	HR25-12N	7,0	10,0	19,0	13,0	13,0	48,0	13,2	200/100					
	14	HR25-14N	7,0	10,0	21,0	14,0	14,5	50,5	15,0	200/100					
35	6	HR35-6N	8,5	12,0	17,0	7,5	7,5	39	6,4	200/50	TNE-H120	TN60C	HT51 RH50 RHMS0 B500 ND RH60C HT60C B600C B600CND HT81-UD RHU81-D		
	8	HR35-8N	8,5	12,0	17,0	10,0	10,0	44	8,4	200/50					
	10	HR35-10N	8,5	12,0	19,0	12,0	12,0	48	10,5	200/50					
	12	HR35-12N	8,5	12,0	21,0	13,0	13,0	50	13,2	200/50					
	14	HR35-14N	8,5	12,0	21,0	14,5	14,5	53	15,0	200/50					
	16	HR35-16N	8,5	12,0	26,0	18,0	16,0	58	17,0	200/50					
50	6	HR50-6N	10,0	14,0	20,0	10,0	10,0	47,0	6,4	100/25	TNE-H120	TN60C	HT51 RH50 RHMS0 B500 ND RH60C HT60C B600C B600CND HT81-UD RHU81-D		
	8	HR50-8N	10,0	14,0	20,0	10,0	10,0	47,0	8,4	100/25					
	10	HR50-10N	10,0	14,0	20,0	12,0	12,0	51,0	10,5	100/25					
	12	HR50-12N	10,0	14,0	23,0	13,0	13,0	53,0	13,2	100/25					
	14	HR50-14N	10,0	14,0	23,0	14,5	14,5	56,0	15,0	100/25					
	16	HR50-16N	10,0	14,0	28,0	16,0	16,0	59,0	17,0	100/25					
70	20	HR50-20N	10,0	14,0	30,0	19,0	19,0	65,0	21,0	100/25	TNE-H120	TN60C	HT51 RH50 RHMS0 B500 ND RH60C HT60C B600C B600CND HT81-UD RHU81-D		
	6	HR70-6N	12,0	16,5	23,5	10,0	10,0	52,0	6,4	100/25					
	8	HR70-8N	12,0	16,5	23,5	10,0	10,0	52,0	8,4	100/25					
	10	HR70-10N	12,0	16,5	23,5	12,0	12,0	56,0	10,5	100/25					
	12	HR70-12N	12,0	16,5	23,5	13,0	13,0	58,0	13,2	100/25					
	14	HR70-14N	12,0	16,5	23,5	14,5	14,5	61,0	15,0	100/25					
95	16	HR70-16N	12,0	16,5	28,0	16,0	16,0	64,0	17,0	100/25	TNE-H120	TN60C	HT51 RH50 RHMS0 B500 ND RH60C HT60C B600C B600CND HT81-UD RHU81-D		
	20	HR70-20N	12,0	16,5	30,5	19,0	19,0	70,0	21,0	100/25					
	8	HR95-8N	13,5	18,0	26,0	12,0	12,0	60,0	8,4	100/25					
	10	HR95-10N	13,5	18,0	26,0	12,0	12,0	60,0	10,5	100/25					
	12	HR95-12N	13,5	18,0	26,0	13,0	13,0	62,0	13,2	100/25					
	14	HR95-14N	13,5	18,0	26,0	14,5	14,5	65,0	15,0	75/25					
120	16	HR95-16N	13,5	18,0	28,0	16,0	16,0	68,0	17,0	75/25	TNE-H120	TN60C	HT51 RH50 RHMS0 B500 ND RH60C HT60C B600C B600CND HT81-UD RHU81-D		
	20	HR95-20N	13,5	18,0	36,0	22,0	22,0	80,0	21,0	75/25					
	8	HR120-8N	15,0	19,5	28,0	14,0	14,0	65,0	8,4	30/10					
	10	HR120-10N	15,0	19,5	28,0	14,0	14,0	65,0	10,5	30/10					
	12	HR120-12N	15,0	19,5	28,0	14,0	14,0	65,0	13,2	30/10					
	14	HR120-14N	15,0	19,5	28,0	15,0	15,0	67,0	15,0	30/10					
150	16	HR120-16N	15,0	19,5	30,0	16,0	16,0	69,0	17,0	30/10	TNE-H120	TN60C	HT51 RH50 RHMS0 B500 ND RH60C HT60C B600C B600CND HT81-UD RHU81-D		
	20	HR120-20N	15,0	19,5	36,0	22,0	22,0	81,0	21,0	30/10					
	8	HR150-8N	16,5	21,0	31,0	14,0	14,0	70,0	8,4	30/10					
	10	HR150-10N	16,5	21,0	31,0	14,0	14,0	70,0	10,5	30/10					
	12	HR150-12N	16,5	21,0	31,0	15,0	15,0	72,0	13,2	30/10					
	14	HR150-14N	16,5	21,0	31,0	15,0	15,0	72,0	15,0	30/10					
150	16	HR150-16N	16,5	21,0	31,0	16,0	16,0	74,0	17,0	30/10	TNE-H120	TN60C	HT51 RH50 RHMS0 B500 ND RH60C HT60C B600C B600CND HT81-UD RHU81-D		
	20	HR150-20N	16,5	21,0	36,0	22,0	22,0	88,0	21,0	30/10					

COPPER TUBE CRIMPING LUGS

for Copper conductors

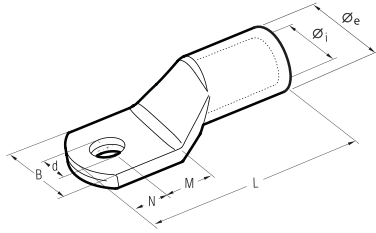

Conductor Size sqmm	Ø Stud mm	Type	Dimensions mm							Quantity Box/Bag	Mechanical Tools	Hydraulic Tools		
			Øi	Øe	B	M	N	L	d					
185	10	HR185-10N	19,0	24,0	35,0	18,0	18,0	83,0	10,5	30/10	TN60C	HT51	RH50 RHM50 B500 B500ND RH60C HT60C B600C B600CND HT81-UD RHU81D	HT120 and tools and heads with 130 kN crimping force ECW-H3D
	12	HR185-12N	19,0	24,0	35,0	18,0	18,0	83,0	13,2	30/10				
	14	HR185-14N	19,0	24,0	35,0	18,0	18,0	83,0	15,0	30/10				
	16	HR185-16N	19,0	24,0	35,0	18,0	18,0	83,0	17,0	30/10				
	20	HR185-20N	19,0	24,0	39,0	22,0	22,0	91,0	21,0	30/10				
240	10	HR240-10N	21,0	26,0	39,0	19,0	21,5	93,5	10,5	30/10				
	12	HR240-12N	21,0	26,0	39,0	19,0	21,5	93,5	13,2	30/10				
	14	HR240-14N	21,0	26,0	39,0	19,0	21,5	93,5	15,0	30/10				
	16	HR240-16N	21,0	26,0	39,0	19,0	21,5	93,5	17,0	30/10				
300	20	HR240-20N	21,0	26,0	39,0	19,0	21,5	93,5	21,0	30/10				
	12	HR300-12N	23,5	29,5	44,0	21,0	24,0	111,0	13,2	10/5				
	14	HR300-14N	23,5	29,5	44,0	21,0	24,0	111,0	15,0	10/5				
	16	HR300-16N	23,5	29,5	44,0	21,0	24,0	111,0	17,0	10/5				
20	HR300-20N	23,5	29,5	44,0	21,0	24,0	111,0	21,0	10/5					

HR-N

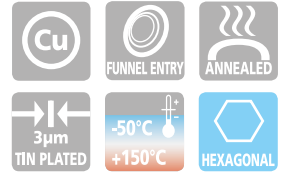

CRIMPING THROUGH CONNECTORS

for Copper conductors

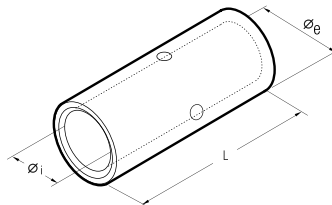

Conductor Size sqmm	Type	Dimensions mm			Quantity Box/Bag	Mechanical Tools	Hydraulic Tools		
		Øi	Øe	L					
10	HSV10	4,5	7,0	30	1200/100	HN1	TN60C	HT45-E B450ND-BV HT51 RH50 B500 B500ND RH60C HT60C B600C B600CND HT81-UD RHU81-D	HT120 and tools and heads with 130 kN crimping force ECW-H3D
16	HSV16	5,5	8,5	35	800/100	HN-5			
25	HSV25	7,0	10,0	40	400/100	HN-H25			
35	HSV35	8,5	12,0	45	200/50	TNE-H50			
50	HSV50	10,0	14,0	50	200/50	TNE-H120			
70	HSV70	12,0	16,5	55	160/40				
95	HSV95	13,5	18,0	60	80/10				
120	HSV120	15,0	19,5	65	80/10				
150	HSV150	16,5	21,0	70	80/10				
185	HSV185	19,0	24,0	75	40/20				
240	HSV240	21,0	26,0	85	40/20				
300	HSV300	23,5	29,5	100	20/10				

HSV

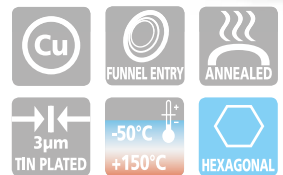

HSV series through connectors are manufactured from electrolytic Copper tube with a purity greater than 99.9%, annealed and surface protected by tin plating. Internal and external dimensions match those of HR series lugs. Chamfered ends and a central stop provide easy and correct insertion of the conductor. Details of the appropriate crimping tools and dies are shown on page 378.

Consult us for special requirements

HRS-N

COPPER TUBE CRIMPING LUGS

for Copper conductors - with inspection hole

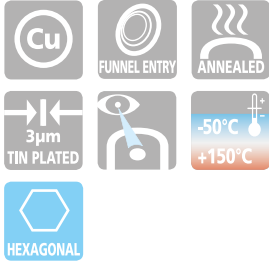
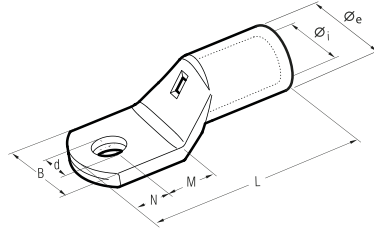

HRS-N series lugs are manufactured from electrolytic Copper tube with a purity greater than 99.9%, and designed to obtain high electrical conductivity combined with the mechanical strength required to resist vibration and pull out.

CEMBRE lugs are annealed and Tin plated for improved surface protection.

The annealing process optimises the structural features of the material allowing easier crimping and greater resistance to mechanical stresses.

The barrel entrance of the lug is chamfered to allow easy conductor insertion, while its length facilitates precise positioning in the crimping die.

Each lug is marked with:

- CEMBRE logo and part code.
- conductor type and csa (mm²).
- stud Ø (mm).
- crimping die code

Details of the appropriate crimping tools and dies are shown on page 378.

Consult us for special requirements

Conductor Size sqmm	Ø Stud mm	Type	Dimensions mm							Quantity Box/Bag	Mechanical Tools			Hydraulic Tools			
			Øi	Øe	B	M	N	L	d								
6	4	HRS6-4N	3,5	6,5	10,0	7,5	6,5	27,5	4,3	800/100	HNI	HNS	HN-H25	B15MD			
	5	HRS6-5N	3,5	6,5	10,0	7,5	6,5	27,5	5,3	800/100							
	6	HRS6-6N	3,5	6,5	11,5	7,5	6,5	27,5	6,4	800/100							
	8	HRS6-8N	3,5	6,5	15,0	10,0	10,0	33,5	8,4	800/100							
	10	HRS6-10N	3,5	6,5	17,0	12,0	12,0	37,5	10,5	800/100							
	12	HRS6-12N	3,5	6,5	19,0	15,0	13,5	42,0	13,2	800/100							
10	4	HRS10-4N	4,5	7,0	12,0	7,5	6,5	28,5	4,3	600/100	TNE-H50	TN60C	HT45-E B450ND-BV	HT120 and tools and heads with 130 kN crimping force			
	5	HRS10-5N	4,5	7,0	12,0	7,5	6,5	28,5	5,3	600/100							
	6	HRS10-6N	4,5	7,0	12,0	7,5	6,5	28,5	6,4	600/100							
	8	HRS10-8N	4,5	7,0	15,0	10,0	10,0	34,5	8,4	600/100							
	10	HRS10-10N	4,5	7,0	17,0	12,0	12,0	38,5	10,5	600/100							
	12	HRS10-12N	4,5	7,0	19,0	13,0	13,0	40,5	13,2	600/100							
16	5	HRS16-5N	5,5	8,5	12,0	7,0	6,0	31,5	5,3	400/100	TNE-H120	TN60C	HT51 RH50 RHM50 B500 ND RH60C HT60C B600C B600CND HT81-UD RHU81-D	ECW-H3D			
	6	HRS16-6N	5,5	8,5	12,0	7,5	6,5	32,5	6,4	400/100							
	8	HRS16-8N	5,5	8,5	15,0	9,5	8,5	36,5	8,4	400/100							
	10	HRS16-10N	5,5	8,5	17,0	11,5	10,5	40,5	10,5	400/100							
	12	HRS16-12N	5,5	8,5	19,0	13,0	12,0	43,5	13,2	400/100							
	14	HRS16-14N	5,5	8,5	21,0	14,5	14,5	50,5	15,0	200/100							
25	5	HRS25-5N	7,0	10,0	14,0	7,5	7,5	37,0	5,3	400/100	TNE-H120	TN60C	HT45-E B450ND-BV	HT120 and tools and heads with 130 kN crimping force			
	6	HRS25-6N	7,0	10,0	14,0	7,5	7,5	37,0	6,4	200/100							
	8	HRS25-8N	7,0	10,0	16,0	10,0	10,0	42,0	8,4	200/100							
	10	HRS25-10N	7,0	10,0	18,0	12,0	12,0	46,0	10,5	200/100							
	12	HRS25-12N	7,0	10,0	19,0	13,0	13,0	48,0	13,2	200/100							
	14	HRS25-14N	7,0	10,0	21,0	14,0	14,5	50,5	15,0	200/100							
35	6	HRS35-6N	8,5	12,0	17,0	7,5	7,5	39	6,4	200/50	TNE-H120	TN60C	HT45-E B450ND-BV	HT120 and tools and heads with 130 kN crimping force			
	8	HRS35-8N	8,5	12,0	17,0	10,0	10,0	44	8,4	200/50							
	10	HRS35-10N	8,5	12,0	19,0	12,0	12,0	48	10,5	200/50							
	12	HRS35-12N	8,5	12,0	21,0	13,0	13,0	50	13,2	200/50							
	14	HRS35-14N	8,5	12,0	21,0	14,5	14,5	53	15,0	200/50							
	16	HRS35-16N	8,5	12,0	26,0	18,0	16,0	58	17,0	200/50							
50	6	HRS50-6N	10,0	14,0	20,0	10,0	10,0	47,0	6,4	100/25	TNE-H120	TN60C	HT45-E B450ND-BV	HT120 and tools and heads with 130 kN crimping force			
	8	HRS50-8N	10,0	14,0	20,0	10,0	10,0	47,0	8,4	100/25							
	10	HRS50-10N	10,0	14,0	20,0	12,0	12,0	51,0	10,5	100/25							
	12	HRS50-12N	10,0	14,0	23,0	13,0	13,0	53,0	13,2	100/25							
	14	HRS50-14N	10,0	14,0	23,0	14,5	14,5	56,0	15,0	100/25							
	16	HRS50-16N	10,0	14,0	28,0	16,0	16,0	59,0	17,0	100/25							
70	20	HRS50-20N	10,0	14,0	30,0	19,0	19,0	65,0	21,0	100/25	TNE-H120	TN60C	HT45-E B450ND-BV	HT120 and tools and heads with 130 kN crimping force			
	6	HRS70-6N	12,0	16,5	23,5	10,0	10,0	52,0	6,4	100/25							
	8	HRS70-8N	12,0	16,5	23,5	10,0	10,0	52,0	8,4	100/25							
	10	HRS70-10N	12,0	16,5	23,5	12,0	12,0	56,0	10,5	100/25							
	12	HRS70-12N	12,0	16,5	23,5	13,0	13,0	58,0	13,2	100/25							
	14	HRS70-14N	12,0	16,5	23,5	14,5	14,5	61,0	15,0	100/25							
95	16	HRS70-16N	12,0	16,5	28,0	16,0	16,0	64,0	17,0	100/25	TNE-H120	TN60C	HT45-E B450ND-BV	HT120 and tools and heads with 130 kN crimping force			
	20	HRS70-20N	12,0	16,5	30,5	19,0	19,0	70,0	21,0	100/25							
	8	HRS95-8N	13,5	18,0	26,0	12,0	12,0	60,0	8,4	100/25							
	10	HRS95-10N	13,5	18,0	26,0	12,0	12,0	60,0	10,5	100/25							
	12	HRS95-12N	13,5	18,0	26,0	13,0	13,0	62,0	13,2	100/25							
	14	HRS95-14N	13,5	18,0	26,0	14,5	14,5	65,0	15,0	75/25							
120	16	HRS95-16N	13,5	18,0	28,0	16,0	16,0	68,0	17,0	75/25	TNE-H120	TN60C	HT45-E B450ND-BV	HT120 and tools and heads with 130 kN crimping force			
	20	HRS95-20N	13,5	18,0	36,0	22,0	22,0	80,0	21,0	75/25							
	8	HRS120-8N	15,0	19,5	28,0	14,0	14,0	65,0	8,4	30/10							
	10	HRS120-10N	15,0	19,5	28,0	14,0	14,0	65,0	10,5	30/10							
	12	HRS120-12N	15,0	19,5	28,0	14,0	14,0	65,0	13,2	30/10							
	14	HRS120-14N	15,0	19,5	28,0	15,0	15,0	67,0	15,0	30/10							
150	16	HRS120-16N	15,0	19,5	30,0	16,0	16,0	69,0	17,0	30/10	TNE-H120	TN60C	HT45-E B450ND-BV	HT120 and tools and heads with 130 kN crimping force			
	20	HRS120-20N	15,0	19,5	36,0	22,0	22,0	81,0	21,0	30/10							
	8	HRS150-8N	16,5	21,0	31,0	14,0	14,0	70,0	8,4	30/10							
	10	HRS150-10N	16,5	21,0	31,0	14,0	14,0	70,0	10,5	30/10							
	12	HRS150-12N	16,5	21,0	31,0	15,0	15,0	72,0	13,2	30/10							
	14	HRS150-14N	16,5	21,0	31,0	15,0	15,0	72,0	15,0	30/10							
150	16	HRS150-16N	16,5	21,0	31,0	16,0	16,0	74,0	17,0	30/10	TNE-H120	TN60C	HT45-E B450ND-BV	HT120 and tools and heads with 130 kN crimping force			
	20	HRS150-20N	16,5	21,0	36,0	22,0	22,0	88,0	21,0	30/10							

COPPER TUBE CRIMPING LUGS

for Copper conductors - with inspection hole

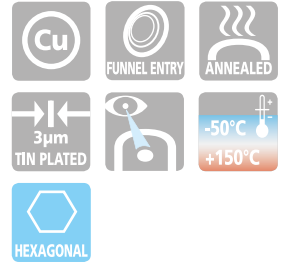
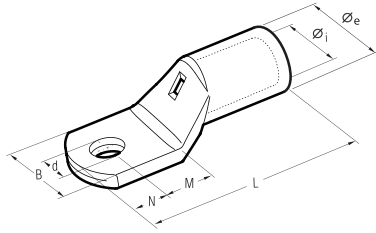

Conductor Size sqmm	Ø Stud mm	Type	Dimensions mm							Quantity Box/Bag	Mechanical Tools	Hydraulic Tools				
			Øi	Øe	B	M	N	L	d							
185	10	HRS185-10N	19,0	24,0	35,0	18,0	18,0	83,0	10,5	30/10	TN60C	HT51	RH50 RHM50 B500 B500ND RH60C HT60C B600C B600CND	HT81-UD RHU81D	HT120 and tools and heads with 130 kN crimping force	ECW-H3D
	12	HRS185-12N	19,0	24,0	35,0	18,0	18,0	83,0	13,2	30/10						
	14	HRS185-14N	19,0	24,0	35,0	18,0	18,0	83,0	15,0	30/10						
	16	HRS185-16N	19,0	24,0	35,0	18,0	18,0	83,0	17,0	30/10						
	20	HRS185-20N	19,0	24,0	39,0	22,0	22,0	91,0	21,0	30/10						
240	10	HRS240-10N	21,0	26,0	39,0	19,0	21,5	93,5	10,5	30/10						
	12	HRS240-12N	21,0	26,0	39,0	19,0	21,5	93,5	13,2	30/10						
	14	HRS240-14N	21,0	26,0	39,0	19,0	21,5	93,5	15,0	30/10						
	16	HRS240-16N	21,0	26,0	39,0	19,0	21,5	93,5	17,0	30/10						
	20	HRS240-20N	21,0	26,0	39,0	19,0	21,5	93,5	21,0	30/10						
300	12	HRS300-12N	23,5	29,5	44,0	21,0	24,0	111,0	13,2	10/5						
	14	HRS300-14N	23,5	29,5	44,0	21,0	24,0	111,0	15,0	10/5						
	16	HRS300-16N	23,5	29,5	44,0	21,0	24,0	111,0	17,0	10/5						
	20	HRS300-20N	23,5	29,5	44,0	21,0	24,0	111,0	21,0	10/5						

for Copper conductors

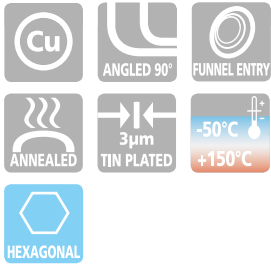
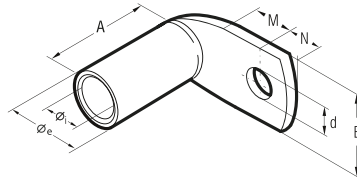

HR-LN series lugs are manufactured from electrolytic Copper tube with a purity greater than 99.9%, and designed to obtain high electrical conductivity combined with the mechanical strength required to resist vibration and pull out.

CEMBRE lugs are annealed and Tin plated for improved surface protection.

The annealing process optimises the structural features of the material allowing easier crimping and greater resistance to mechanical stresses.

The barrel entrance of the lug is chamfered to allow easy conductor insertion, while its length facilitates precise positioning in the crimping die.

Each lug is marked with:

- CEMBRE logo and part code.
- conductor type and csa (mm²).
- stud Ø (mm).
- crimping die code

Details of the appropriate crimping tools and dies are shown on page 378.

Consult us for special requirements

Conductor Size sqmm	Ø Stud mm	Type	Dimensions mm							Quantity Box/Bag	Mechanical Tools		Hydraulic Tools								
			Øi	Øe	B	M	N	A	d												
6	4	HR6-L4N	3,5	6,5	10,0	8,5	7,5	10,5	4,3	400/100	HN1	HN5	HN-H25	TNE-H50	B15MD						
	5	HR6-L5N	3,5	6,5	10,0	8,5	7,5	10,5	5,3	400/100											
	6	HR6-L6N	3,5	6,5	11,5	8,5	7,5	10,5	6,4	400/100											
	8	HR6-L8N	3,5	6,5	15,0	11,0	10,0	10,5	8,4	400/100											
	10	HR6-L10N	3,5	6,5	17,0	13,0	12,0	10,5	10,5	400/100											
	12	HR6-L12N	3,5	6,5	19,0	13,5	13,5	10,5	13,2	400/100											
10	4	HR10-L4N	4,5	7,0	12,0	8,5	7,5	10,5	4,3	400/100	HN1	HN5	HN-H25	TNE-H50	B15MD						
	5	HR10-L5N	4,5	7,0	12,0	8,5	7,5	10,5	5,3	400/100											
	6	HR10-L6N	4,5	7,0	12,0	8,5	7,5	10,5	6,4	400/100											
	8	HR10-L8N	4,5	7,0	15,0	11,0	10,0	10,5	8,4	400/100											
	10	HR10-L10N	4,5	7,0	17,0	13,0	12,0	10,5	10,5	400/100											
	12	HR10-L12N	4,5	7,0	19,0	16,0	13,5	10,5	13,2	400/100											
16	5	HR16-L5N	5,5	8,5	12,0	8,5	7,5	12,0	5,3	400/100	HN1	HN5	HN-H25	TNE-H50	B15MD						
	6	HR16-L6N	5,5	8,5	12,0	8,5	7,5	12,0	6,4	400/100											
	8	HR16-L8N	5,5	8,5	15,0	11,0	10,0	12,0	8,4	400/100											
	10	HR16-L10N	5,5	8,5	17,0	13,0	12,0	12,0	10,5	400/100											
	12	HR16-L12N	5,5	8,5	19,0	16,0	13,5	12,0	13,2	400/100											
	25	5	HR25-L5N	7,0	10,0	14,0	9,0	7,5	13,0	5,3						400/100	HN1	HN5	HN-H25	TNE-H50	B15MD
6	HR25-L6N	7,0	10,0	14,0	9,0	7,5	13,0	6,4	400/100												
8	HR25-L8N	7,0	10,0	15,0	11,0	10,0	13,0	8,4	400/100												
10	HR25-L10N	7,0	10,0	18,0	13,0	12,0	13,0	10,5	400/100												
12	HR25-L12N	7,0	10,0	19,0	14,0	13,0	13,0	13,2	400/100												
35	6	HR35-L6N	8,5	12,0	17,0	9,0	7,5	15,5	6,4	200/50	HN1	HN5	HN-H25	TNE-H120	B15MD						
8	HR35-L8N	8,5	12,0	17,0	11,0	10,0	15,5	8,4	200/50												
10	HR35-L10N	8,5	12,0	19,0	13,0	12,0	15,5	10,5	200/50												
12	HR35-L12N	8,5	12,0	21,0	14,0	13,0	15,5	13,2	200/50												
16	HR35-L16N	8,5	12,0	26,0	18,5	16,0	15,5	17,0	200/50												
50	6	HR50-L6N	10,0	14,0	20,0	11,0	10,0	18,5	6,4	100/50						HN1	HN5	HN-H25	TNE-H120	B15MD	
8	HR50-L8N	10,0	14,0	20,0	11,0	10,0	18,5	8,4	100/50												
10	HR50-L10N	10,0	14,0	20,0	13,0	12,0	18,5	10,5	100/50												
12	HR50-L12N	10,0	14,0	21,0	14,0	13,0	18,5	13,2	100/50												
16	HR50-L16N	10,0	14,0	26,0	18,5	16,0	18,5	17,0	100/50												
20	HR50-L20N	10,0	14,0	30,0	20,0	19,0	18,5	21,0	100/50												
70	6	HR70-L6N	12,0	16,5	21,0	12,0	10,0	20,0	6,4	80/20	HN1	HN5	HN-H25	TNE-H120	B15MD						
	8	HR70-L8N	12,0	16,5	21,0	12,0	10,0	20,0	8,4	80/20											
	10	HR70-L10N	12,0	16,5	21,0	13,0	12,0	20,0	10,5	80/20											
	12	HR70-L12N	12,0	16,5	21,0	14,0	13,0	20,0	13,2	80/20											
	16	HR70-L16N	12,0	16,5	28,0	18,2	16,0	20,0	17,0	80/20											
	20	HR70-L20N	12,0	16,5	30,5	21,5	19,0	20,0	21,0	80/20											
95	8	HR95-L8N	13,5	18,0	26,0	12,0	10,0	24,5	8,4	80/20	HN1	HN5	HN-H25	TNE-H120	B15MD						
	10	HR95-L10N	13,5	18,0	26,0	13,0	12,0	24,5	10,5	80/20											
	12	HR95-L12N	13,5	18,0	26,0	14,0	13,0	24,5	13,2	80/20											
	16	HR95-L16N	13,5	18,0	28,0	19,0	16,0	24,5	17,0	80/20											
	20	HR95-L20N	13,5	18,0	31,0	23,0	21,0	24,5	21,0	80/20											
	120	8	HR120-L8N	15,0	19,5	29,0	14,0	14,0	25,5	8,4						80/20	HN1	HN5	HN-H25	TNE-H120	B15MD
10	HR120-L10N	15,0	19,5	29,0	14,0	14,0	25,5	10,5	80/20												
12	HR120-L12N	15,0	19,5	29,0	14,0	14,0	25,5	13,2	80/20												
16	HR120-L16N	15,0	19,5	31,0	15,0	16,0	25,5	17,0	80/20												
20	HR120-L20N	15,0	19,5	36,0	23,0	21,0	25,5	21,0	80/20												
150	8	HR150-L8N	16,5	21,0	31,0	14,0	14,0	28,5	8,4	40/10	HN1	HN5	HN-H25	TNE-H120	B15MD						
10	HR150-L10N	16,5	21,0	31,0	14,0	14,0	28,5	10,5	40/10												
12	HR150-L12N	16,5	21,0	31,0	15,0	15,0	28,5	13,2	40/10												
16	HR150-L16N	16,5	21,0	31,0	19,0	16,0	28,5	17,0	40/10												
20	HR150-L20N	16,5	21,0	36,0	23,0	21,0	28,5	21,0	40/10												
185	10	HR185-L10N	19,0	24,0	35,0	19,0	16,0	31,5	10,5	40/10						HN1	HN5	HN-H25	TNE-H120	B15MD	
12	HR185-L12N	19,0	24,0	35,0	19,0	16,0	31,5	13,2	40/10												
16	HR185-L16N	19,0	24,0	35,0	19,0	16,0	31,5	17,0	40/10												
20	HR185-L20N	19,0	24,0	37,0	23,0	21,0	31,5	21,0	40/10												
240	10	HR240-L10N	21,0	26,0	39,0	19,0	16,0	36,5	10,5	20/10	HN1	HN5	HN-H25	TNE-H120	B15MD						
12	HR240-L12N	21,0	26,0	39,0	19,0	16,0	36,5	13,2	20/10												
16	HR240-L16N	21,0	26,0	39,0	19,0	16,0	36,5	17,0	20/10												
20	HR240-L20N	21,0	26,0	39,0	23,0	21,0	36,5	21,0	20/10												
300	12	HR300-L12N	23,5	29,5	44,0	24,0	24,0	45,0	13,2	10/5						HN1	HN5	HN-H25	TNE-H120	B15MD	
16	HR300-L16N	23,5	29,5	44,0	24,0	24,0	45,0	17,0	10/5												
	20	HR300-L20N	23,5	29,5	44,0	24,0	24,0	45,0	21,0	10/5											

COPPER TUBE CRIMPING LUGS ANGLED 45°

for Copper conductors

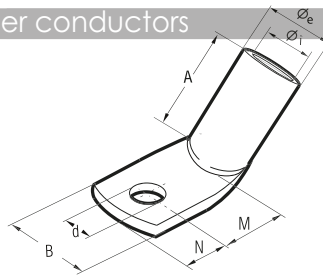

HR-/45N



Conductor Size sqmm	Ø Stud mm	Type	Dimensions mm							Quantity Box/Bag	Mechanical Tools		Hydraulic Tools				
			Øi	Øe	B	M	N	A	d								
6	4	HR6-4/45N	3,5	6,5	8,5	8,5	7,5	8,5	4,3	400/100	HN1	HN5	B15MD				
	5	HR6-5/45N	3,5	6,5	10,0	8,5	7,5	10,5	5,3	400/100							
	6	HR6-6/45N	3,5	6,5	11,5	8,5	7,5	10,5	6,4	400/100							
	8	HR6-8/45N	3,5	6,5	15,0	11,0	10,0	10,5	8,4	400/100							
	10	HR6-10/45N	3,5	6,5	17,0	13,0	12,0	10,5	10,5	400/100							
10	12	HR6-12/45N	3,5	6,5	19,0	16,0	13,5	10,5	13,2	400/100	HN1	HN5	B15MD				
	4	HR10-4/45N	4,5	7,0	12,0	8,5	7,5	8,5	4,3	400/100							
	5	HR10-5/45N	4,5	7,0	12,0	8,5	7,5	10,5	5,3	400/100							
	6	HR10-6/45N	4,5	7,0	12,0	8,5	7,5	10,5	6,4	400/100							
	8	HR10-8/45N	4,5	7,0	15,0	11,0	10,0	10,5	8,4	400/100							
16	10	HR10-10/45N	4,5	7,0	17,0	13,0	12,0	10,5	10,5	400/100	HN1	HN5	B15MD				
	12	HR10-12/45N	4,5	7,0	19,0	16,0	13,5	10,5	13,2	400/100							
	5	HR16-5/45N	5,5	8,5	12,0	8,5	7,5	12,0	5,3	400/100				TNE-H50	B15MD		
	6	HR16-6/45N	5,5	8,5	12,0	8,5	7,5	12,0	6,4	400/100							
	8	HR16-8/45N	5,5	8,5	15,0	11,0	10,0	12,0	8,4	400/100							
10	HR16-10/45N	5,5	8,5	17,0	13,0	12,0	12,0	10,5	400/100								
12	HR16-12/45N	5,5	8,5	19,0	16,0	13,5	12,0	13,2	400/100								
25	5	HR25-5/45N	7,0	10,0	14,0	9,0	7,5	13,0	5,3	400/100	TNE-H50	B15MD					
	6	HR25-6/45N	7,0	10,0	14,0	9,0	7,5	13,0	6,4	400/100							
	8	HR25-8/45N	7,0	10,0	15,0	11,0	10,0	13,0	8,4	400/100							
	10	HR25-10/45N	7,0	10,0	18,0	13,0	12,0	13,0	10,5	400/100							
	12	HR25-12/45N	7,0	10,0	19,0	14,0	13,0	13,0	13,2	400/100							
35	6	HR35-6/45N	8,5	12,0	17,0	9,0	7,5	15,5	6,4	200/50	TNE-H120	B15MD					
	8	HR35-8/45N	8,5	12,0	17,0	11,0	10,0	15,5	8,4	200/50							
	10	HR35-10/45N	8,5	12,0	19,0	13,0	12,0	15,5	10,5	200/50							
	12	HR35-12/45N	8,5	12,0	21,0	14,0	13,0	15,5	13,2	200/50							
	16	HR35-16/45N	8,5	12,0	26,0	18,5	16,0	15,5	17,0	200/50							
50	6	HR50-6/45N	10,0	14,0	20,0	11,0	10,0	18,5	6,4	200/50	TNE-H120	B15MD					
	8	HR50-8/45N	10,0	14,0	20,0	11,0	10,0	18,5	8,4	200/50							
	10	HR50-10/45N	10,0	14,0	20,0	13,0	12,0	18,5	10,5	200/50							
	12	HR50-12/45N	10,0	14,0	21,0	14,0	13,0	18,5	13,2	200/50							
	16	HR50-16/45N	10,0	14,0	26,0	18,5	16,0	18,5	17,0	150/50							
70	20	HR50-20/45N	10,0	14,0	30,0	20,0	19,0	18,5	21,0	200/50	TN60C	B15MD					
	6	HR70-6/45N	12,0	16,5	24,0	12,0	10,0	20,0	6,4	80/20							
	8	HR70-8/45N	12,0	16,5	24,0	12,0	10,0	20,0	8,4	80/20							
	10	HR70-10/45N	12,0	16,5	24,0	13,0	12,0	20,0	10,5	80/20							
	12	HR70-12/45N	12,0	16,5	24,0	14,0	13,0	20,0	13,2	80/20							
95	16	HR70-16/45N	12,0	16,5	28,0	18,5	16,0	20,0	17,0	80/20							
	20	HR70-20/45N	12,0	16,5	30,5	21,5	19,0	20,0	21,0	80/20							
	8	HR95-8/45N	13,5	18,0	26,0	12,0	10,0	24,5	8,4	80/20							
	10	HR95-10/45N	13,5	18,0	26,0	13,0	12,0	24,5	10,5	80/20							
	12	HR95-12/45N	13,5	18,0	26,0	14,0	13,0	24,5	13,2	80/20							
120	16	HR95-16/45N	13,5	18,0	28,0	19,0	16,0	24,5	17,0	80/20							
	20	HR95-20/45N	13,5	18,0	32,0	23,0	21,0	24,5	21,0	80/20							
	8	HR120-8/45N	15,0	19,5	29,0	14,0	14,0	25,5	8,4	80/20							
	10	HR120-10/45N	15,0	19,5	29,0	14,0	14,0	25,5	10,5	80/20							
	12	HR120-12/45N	15,0	19,5	29,0	14,0	14,0	25,5	13,2	80/20							
150	16	HR120-16/45N	15,0	19,5	31,0	19,0	16,0	25,5	17,0	80/20							
	20	HR120-20/45N	15,0	19,5	36,0	23,0	21,0	25,5	21,0	80/20							
	8	HR150-8/45N	16,5	21,0	31,0	14,0	14,0	28,5	8,4	40/10							
	10	HR150-10/45N	16,5	21,0	31,0	14,0	14,0	28,5	10,5	40/10							
	12	HR150-12/45N	16,5	21,0	31,0	15,0	15,0	28,5	13,2	40/10							
185	16	HR150-16/45N	16,5	21,0	31,0	19,0	16,0	28,5	17,0	40/10							
	20	HR150-20/45N	16,5	21,0	36,0	23,0	21,0	28,5	21,0	40/10							
	10	HR185-10/45N	19,0	21,0	35,0	19,0	16,0	31,5	10,5	40/10							
	12	HR185-12/45N	19,0	21,0	35,0	19,0	16,0	31,5	13,2	40/10							
	16	HR185-16/45N	19,0	21,0	35,0	19,0	16,0	31,5	17,0	40/10							
240	20	HR185-20/45N	19,0	21,0	37,0	23,0	21,0	31,5	21,0	40/10							
	10	HR240-10/45N	21,0	26,0	39,0	19,0	16,0	36,5	10,5	20/10							
	12	HR240-12/45N	21,0	26,0	39,0	19,0	16,0	36,5	13,2	20/10							
	16	HR240-16/45N	21,0	26,0	39,0	19,0	16,0	36,5	17,0	20/10							
	20	HR240-20/45N	21,0	26,0	39,0	23,0	21,0	36,5	21,0	20/10							
300	12	HR300-12/45N	23,5	29,5	44,0	19,0	16,0	45,0	13,2	10/5							
	16	HR300-16/45N	23,5	29,5	44,0	23,0	21,0	45,0	17,0	10/5							
	20	HR300-20/45N	23,5	29,5	44,0	23,0	21,0	45,0	21,0	10/5							

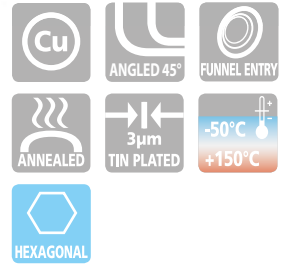

HR-/45N series lugs are manufactured from electrolytic Copper tube with a purity greater than 99.9%, and designed to obtain high electrical conductivity combined with the mechanical strength required to resist vibration and pull out.

CEMBRE lugs are annealed and Tin plated for improved surface protection.

The annealing process optimises the structural features of the material allowing easier crimping and greater resistance to mechanical stresses.

The barrel entrance of the lug is chamfered to allow easy conductor insertion, while its length facilitates precise positioning in the crimping die.

Each lug is marked with:

- CEMBRE logo and part code.
- conductor type and csa (mm²).
- stud Ø (mm).
- crimping die code

Details of the appropriate crimping tools and dies are shown on page 378.

Consult us for special requirements

T-M

COPPER TUBE CRIMPING LUGS ACCORDING TO NF C 20-130

for Copper conductors

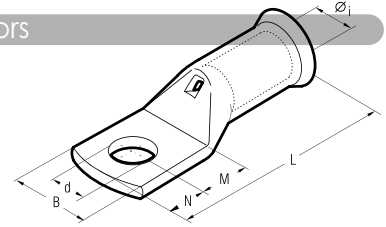

T-M series lugs are manufactured from electrolytic Copper tube with a purity greater than 99.9%.

The dimensions of the tube are designed to obtain the most efficient electrical conductivity and mechanical strength to resist vibration and pull out.

CEMBRE lugs are annealed to guarantee optimum ductility which is an absolute necessity for connectors which will have to withstand the severe deformation arising when compressed and any bending of the palm during installation.

In applications subject to vibration, lugs still have to provide a reliable connection and annealing plays a vital role in avoiding cracking or breaks between the barrel and palm.

The insertion of the cable is facilitated by a tulip out.

The presence of an inspection hole facilitates full insertion of the conductor, whilst the barrel length has been designed to allow easy and accurate positioning of the dies during the crimping operation.

Lugs are electrolytically Tin plated to avoid oxidation.

Our technicians are always available to provide any technical advice which may be required.

The enclosed table is only indicative of the range and many variations in stud fixing and palm lengths are also available.

Details of the appropriate crimping tools and dies are shown on page 380.

Conductor Size sqmm	Low Str.	Flex	Ø Stud mm	Type	Dimensions mm							Quantity Box/Bag	Mechanical Tools	Hydraulic Tools
					Øi	B	M	N	L	d				
4			4	T4-M4	2,7	9,0	7,0	6,0	27,5	4,2	1.200/100	HN1	B15MD	
			5	T4-M5	2,7	9,0	7,0	6,0	27,5	5,2	2.000/100			
			6	T4-M6	2,7	12,0	9,0	8,0	32,0	6,4	1.200/100			
4÷6			4	T6-M4	3,3	10,0	6,5	6,0	30,0	4,2	1.200/100	HN1	B15MD	
			5	T6-M5	3,3	13,0	6,5	6,0	30,0	5,2	1.200/100			
			6	T6-M6	3,3	13,0	9,0	8,0	34,5	6,4	800/100			
10			8	T6-M8	3,3	13,0	11,0	10,0	38,5	8,3	800/100	HN1	B15MD	
			5	T10-M5	4,2	11,0	6,5	6,0	30,0	5,2	800/100			
			6	T10-M6	4,2	11,0	9,0	8,0	34,5	6,4	800/100			
16			8	T10-M8	4,2	14,0	11,0	10,0	38,5	8,3	800/100	HN5	B15MD	
			10	T10-M10	4,2	14,0	14,0	12,0	43,5	10,3	800/100			
			5	T16-M5	5,3	12,0	6,5	6,0	34,0	5,2	800/100			
25			6	T16-M6	5,3	12,0	9,0	8,0	38,5	6,4	400/100	HN-T25	B15MD	
			8	T16-M8	5,3	16,0	11,0	10,0	42,5	8,3	400/100			
			10	T16-M10	5,3	16,0	14,0	12,0	47,5	10,3	400/100			
35			5	T25-M5	6,6	13,0	6,5	6,0	35,5	5,2	400/100	TNE-T50	B15MD	
			6	T25-M6	6,6	13,0	9,0	8,0	40,0	6,4	400/100			
			8	T25-M8	6,6	16,0	11,0	10,0	44,0	8,3	400/100			
50			10	T25-M10	6,6	16,0	14,0	12,0	49,0	10,3	400/100	TNE-T50	B15MD	
			12	T25-M12	6,6	19,0	18,0	16,0	57,0	12,8	200/50			
			6	T35-M6	7,9	15,0	9,0	8,0	41,0	6,4	200/50			
70			8	T35-M8	7,9	17,0	11,0	10,0	45,0	8,3	200/50	TNE-T120	B15MD	
			10	T35-M10	7,9	17,0	14,0	12,0	50,0	10,3	200/50			
			12	T35-M12	7,9	17,0	18,0	16,0	58,0	12,8	200/50			
95			6	T50-M6	9,2	18,0	9,0	8,0	46,5	6,4	200/25	TNE-T120	B15MD	
			8	T50-M8	9,2	18,0	11,0	10,0	50,5	8,3	200/25			
			10	T50-M10	9,2	18,0	14,0	12,0	55,5	10,3	200/25			
120			12	T50-M12	9,2	19,0	18,0	16,0	63,5	12,8	100/25	TNE-T120	B15MD	
			8	T70-M8	11,0	21,0	11,0	10,0	54,0	8,3	100/25			
			10	T70-M10	11,0	21,0	14,0	12,0	59,0	10,3	100/25			
150			12	T70-M12	11,0	21,0	18,0	16,0	67,0	12,8	100/25	TNE-T120	B15MD	
			8	T95-M8	13,1	23,0	11,0	10,0	60,0	8,3	80/20			
			10	T95-M10	13,1	23,0	14,0	12,0	65,0	10,3	80/20			
185			12	T95-M12	13,1	23,0	18,0	16,0	73,0	12,8	80/20	TNE-T120	B15MD	
			14	T95-M14	13,1	23,0	18,0	16,0	73,0	14,5	80/20			
			16	T95-M16	13,1	23,0	19,0	17,0	75,0	16,5	80/20			
240			8	T120-M8	14,5	28,0	11,0	10,0	63,0	8,3	50/25	TNE-T120	B15MD	
			10	T120-M10	14,5	28,0	14,0	12,0	68,0	10,3	50/25			
			12	T120-M12	14,5	28,0	18,0	16,0	76,0	12,8	50/25			
300			14	T120-M14	14,5	28,0	18,0	16,0	76,0	14,5	50/25	TNE-T120	B15MD	
			16	T120-M16	14,5	28,0	19,0	17,0	78,0	16,5	50/25			
			8	T150-M8	16,2	30,0	11,0	10,0	72,5	8,3	40/10			
400			10	T150-M10	16,2	30,0	14,0	12,0	77,5	10,3	40/10	TNE-T120	B15MD	
			12	T150-M12	16,2	30,0	18,0	16,0	85,5	12,8	40/10			
			14	T150-M14	16,2	30,0	18,0	16,0	85,5	14,5	40/10			
480			16	T150-M16	16,2	30,0	19,0	17,0	87,5	16,5	40/10	TNE-T120	B15MD	
			10	T185-M10	18,0	33,0	14,0	12,0	83,5	10,3	40/10			
			12	T185-M12	18,0	33,0	18,0	16,0	91,5	12,8	40/10			
560			14	T185-M14	18,0	33,0	18,0	16,0	91,5	14,5	40/10	TNE-T120	B15MD	
			16	T185-M16	18,0	33,0	19,0	17,0	93,5	16,5	40/10			
			10	T240-M10	20,6	37,0	13,0	11,0	87,5	10,3	20/10			
630			12	T240-M12	20,6	37,0	16,0	14,0	93,5	12,8	20/10	TNE-T120	B15MD	
			14	T240-M14	20,6	37,0	18,0	16,0	97,5	14,5	20/10			
			16	T240-M16	20,6	37,0	19,0	17,0	99,5	16,5	20/10			
720			20	T240-M20	20,6	37,0	22,0	20,0	105,5	21,0	20/10	TNE-T120	B15MD	
			10	T300-M10	23,1	41,0	14,0	11,0	95,0	10,3	20/5			
			12	T300-M12	23,1	41,0	20,0	14,0	104,0	12,8	20/5			
840			14	T300-M14	23,1	41,0	22,0	16,0	108,0	14,5	20/5	TNE-T120	B15MD	
			16	T300-M16	23,1	41,0	22,0	19,0	111,0	16,5	20/5			
			20	T300-M20	23,1	41,0	24,0	23,0	117,0	21,0	10/5			
960			14	T400-M14	26,1	47,0	22,0	19,0	119,0	14,5	10/5	TNE-T120	B15MD	
			16	T400-M16	26,1	47,0	22,0	19,0	119,0	16,5	10/5			
			20	T400-M20	26,1	47,0	24,0	23,0	125,0	21,0	10/5			

COPPER TUBE CRIMPING LUGS ANGLED 90°

for Copper conductors

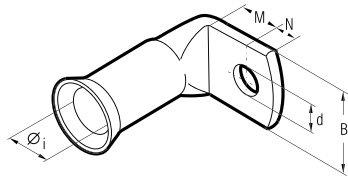

T-L



Conductor Size sqmm		Type	Dimensions mm					Quantity Box/Bag	Mechanical Tools	Hydraulic Tools							
Low Str.	Flex		Øi	B	M	N	d			Hydraulic Tools							
4÷6	6	T6-L6	3,3	13,0	9,0	8,0	6,4	800/100	HN1	B15MD	HT45-E B450ND-BV	HT51 RH50 B500 B500ND	RH60C HT60C B600C B600CND	HT81-UD RHU81-D	HT120 and tools and heads with 130 kN crimping force	ECW-H3D	RHU520
	5	T10-L5	4,2	11,0	6,0	6,0	5,2										
10	6	T10-L6	4,2	11,0	8,0	8,0	6,4	800/100	HN5	B15MD	HT45-E B450ND-BV	HT51 RH50 B500 B500ND	RH60C HT60C B600C B600CND	HT81-UD RHU81-D	HT120 and tools and heads with 130 kN crimping force	ECW-H3D	RHU520
	8	T10-L8	4,2	14,0	11,0	10,0	8,3										
16	6	T16-L6	5,3	12,0	9,0	8,0	6,4	400/100	HN-T25	B15MD	HT45-E B450ND-BV	HT51 RH50 B500 B500ND	RH60C HT60C B600C B600CND	HT81-UD RHU81-D	HT120 and tools and heads with 130 kN crimping force	ECW-H3D	RHU520
	8	T16-L8	5,3	16,0	11,0	10,0	8,3										
25	6	T25-L6	6,6	13,0	9,0	8,0	6,4	400/100	TNE-T50	B15MD	HT45-E B450ND-BV	HT51 RH50 B500 B500ND	RH60C HT60C B600C B600CND	HT81-UD RHU81-D	HT120 and tools and heads with 130 kN crimping force	ECW-H3D	RHU520
	8	T25-L8	6,6	16,0	11,0	10,0	8,3										
35	6	T35-L6	7,9	15,0	9,0	8,0	6,4	400/50	TNE-T120	B15MD	HT45-E B450ND-BV	HT51 RH50 B500 B500ND	RH60C HT60C B600C B600CND	HT81-UD RHU81-D	HT120 and tools and heads with 130 kN crimping force	ECW-H3D	RHU520
	8	T35-L8	7,9	17,0	11,0	10,0	8,3										
50	6	T50-L6	9,2	18,0	9,0	8,0	6,4	100/25	TNE-T120	B15MD	HT45-E B450ND-BV	HT51 RH50 B500 B500ND	RH60C HT60C B600C B600CND	HT81-UD RHU81-D	HT120 and tools and heads with 130 kN crimping force	ECW-H3D	RHU520
	8	T50-L8	9,2	18,0	10,0	10,0	8,3										
70	6	T70-L6	9,2	18,0	14,0	12,0	10,3	100/25	TNE-T120	B15MD	HT45-E B450ND-BV	HT51 RH50 B500 B500ND	RH60C HT60C B600C B600CND	HT81-UD RHU81-D	HT120 and tools and heads with 130 kN crimping force	ECW-H3D	RHU520
	10	T70-L8	11,0	21,0	11,0	10,0	8,3										
95	8	T95-L8	13,1	23,0	11,0	10,0	8,3	100/25	TNE-T120	B15MD	HT45-E B450ND-BV	HT51 RH50 B500 B500ND	RH60C HT60C B600C B600CND	HT81-UD RHU81-D	HT120 and tools and heads with 130 kN crimping force	ECW-H3D	RHU520
	10	T95-L10	13,1	23,0	14,0	12,0	10,3										
120	10	T120-L10	14,5	28,0	14,0	12,0	10,3	50/25	TNE-T120	B15MD	HT45-E B450ND-BV	HT51 RH50 B500 B500ND	RH60C HT60C B600C B600CND	HT81-UD RHU81-D	HT120 and tools and heads with 130 kN crimping force	ECW-H3D	RHU520
	12	T120-L12	14,5	28,0	18,0	16,0	12,8										
150	10	T150-L10	16,2	30,0	14,0	12,0	10,3	40/10	TNE-T120	B15MD	HT45-E B450ND-BV	HT51 RH50 B500 B500ND	RH60C HT60C B600C B600CND	HT81-UD RHU81-D	HT120 and tools and heads with 130 kN crimping force	ECW-H3D	RHU520
	12	T150-L12	16,2	30,0	18,0	16,0	12,8										
185	10	T185-L10	18,0	33,0	14,0	12,0	10,3	40/10	TNE-T120	B15MD	HT45-E B450ND-BV	HT51 RH50 B500 B500ND	RH60C HT60C B600C B600CND	HT81-UD RHU81-D	HT120 and tools and heads with 130 kN crimping force	ECW-H3D	RHU520

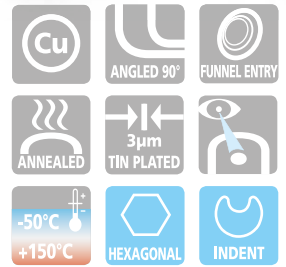

T-L series lugs angled 90° are manufactured from electrolytic Copper tube with a purity greater than 99.9%.

T-L series lugs having the same dimensions and characteristics as T-M series lugs.

Details of the appropriate crimping tools and dies are shown on page 380.

CRIMPING THROUGH CONNECTORS

for Copper conductors

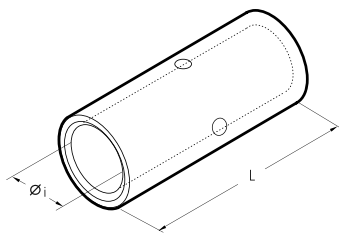

L-T



Total Conductor Size sqmm		Type	Dimensions mm		Quantity Box/Bag	Mechanical Tools	Hydraulic Tools							
Low Stranded	Flexible		Øi	L			Hydraulic Tools							
4	4	L4-T	2,7	22	2.000/100	HN1	B15MD	HT45-E B450ND-BV	HT51 RH50 B500 B500ND	RH60C HT60C B600C B600CND	HT81-UD RHU81-D	HT120 and tools and heads with 130 kN crimping force	ECW-H3D	RHU520
4÷6	4÷6	L6-T	3,3	25	1.500/100									
10	10	L10-T	4,2	27	1.000/100	HN5	B15MD	HT45-E B450ND-BV	HT51 RH50 B500 B500ND	RH60C HT60C B600C B600CND	HT81-UD RHU81-D	HT120 and tools and heads with 130 kN crimping force	ECW-H3D	RHU520
16	16	L16-T	5,3	31	500/100									
25	25	L25-T	6,6	35	500/100	HN-A25	B15MD	HT45-E B450ND-BV	HT51 RH50 B500 B500ND	RH60C HT60C B600C B600CND	HT81-UD RHU81-D	HT120 and tools and heads with 130 kN crimping force	ECW-H3D	RHU520
35	25	L35-T	7,9	37	250/50									
50	35	L50-T	9,2	45	250/50	TNE-T50	B15MD	HT45-E B450ND-BV	HT51 RH50 B500 B500ND	RH60C HT60C B600C B600CND	HT81-UD RHU81-D	HT120 and tools and heads with 130 kN crimping force	ECW-H3D	RHU520
70	50	L70-T	11,0	50	200/50									
95	70	L95-T	13,1	56	100/25	TNE-T120	B15MD	HT45-E B450ND-BV	HT51 RH50 B500 B500ND	RH60C HT60C B600C B600CND	HT81-UD RHU81-D	HT120 and tools and heads with 130 kN crimping force	ECW-H3D	RHU520
120	95	L120-T	14,5	60	100/25									
150	120	L150-T	16,2	66	50/25	TNE-T120	B15MD	HT45-E B450ND-BV	HT51 RH50 B500 B500ND	RH60C HT60C B600C B600CND	HT81-UD RHU81-D	HT120 and tools and heads with 130 kN crimping force	ECW-H3D	RHU520
185	150	L185-T	18,0	75	50/25									
240	185	L240-T	20,6	80	30/15	TNE-T120	B15MD	HT45-E B450ND-BV	HT51 RH50 B500 B500ND	RH60C HT60C B600C B600CND	HT81-UD RHU81-D	HT120 and tools and heads with 130 kN crimping force	ECW-H3D	RHU520
300	240	L300-T	23,1	90	20/10									
400	300	L400-T	26,1	100	20/5	TNE-T120	B15MD	HT45-E B450ND-BV	HT51 RH50 B500 B500ND	RH60C HT60C B600C B600CND	HT81-UD RHU81-D	HT120 and tools and heads with 130 kN crimping force	ECW-H3D	RHU520



Made of electrolytic Copper tube with a purity greater than 99.9%, having the same dimensions as T-M series lugs, L-T connectors are annealed and electrolytically Tin plated. They feature an internal taper to ease the introduction of the conductor.

Details of the appropriate crimping tools and dies are shown on page 380.



COLOUR CODED COPPER CRIMPING LUGS

for Copper conductors

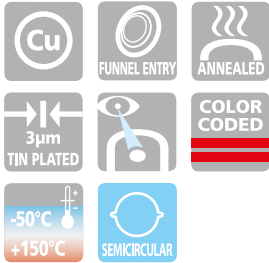
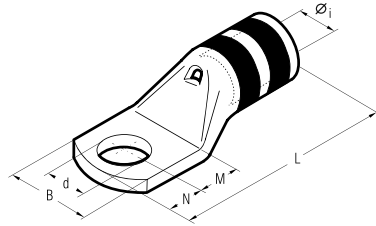

C series lugs are manufactured from electrolytic Copper tube with a purity greater than 99.9%.

The dimensions of the tube are designed to obtain the most efficient electrical conductivity and mechanical strength to resist vibration and pull out.

CEMBRE lugs are annealed to guarantee optimum ductility, an absolute necessity for connectors which will have to withstand the severe deformation arising when compressed and any bending of the palm during installation.

In applications subject to vibration, terminals have to perform a reliable connection, the annealing process plays a vital role in avoiding cracking or breaks between the barrel and palm.

The presence of an inspection hole facilitates full insertion of the conductor. The barrel length has been designed to allow easy and accurate positioning of the dies during the crimping operation.

Lugs are electrolytically Tin plated to avoid oxidation.

The tongue is clearly marked with wire size and die index for CEMBRE tools.

UL listed for US and Canada per UL486A up to 35 KV.

C series lugs are an important part of CEMBRE crimping systems for power carrying conductors.

Details of the appropriate crimping tools and dies are shown on page 379.

CEMBRE technicians are available to provide technical advice as required.

Please consult CEMBRE for products not listed.

Cond. Size sqmm	Conductor		Type	Dimensions mm						Colour Code	Quantity Box/Bag	Mechanical Tools	Hydraulic Tools
	AWG	Size		Ø Stud mm	Øi	B	M	N	L				
10	8	23	4 C8-8	4,6	10,0	5,0	4,0	22,5	4,3	RED	600/50	TN705E	B15MD
			5 C8-10	4,6	10,0	6,5	6,0	26,0	5,3		600/50		
			6 C8-14	4,6	11,0	7,0	6,0	26,5	6,4		600/50		
			8 C8-516	4,6	15,0	9,0	8,0	30,5	8,4		400/50		
			10 C8-38	4,6	18,0	11,0	10,0	34,5	10,5		600/50		
			12 C8-12	4,6	19,0	14,0	12,0	39,5	13,2		600/50		
16	6	40	4 C6-8	5,8	11,5	5,0	4,0	25,5	4,3	BLUE	600/50		
			5 C6-10	5,8	11,5	6,5	6,0	29,0	5,3		600/50		
			6 C6-14	5,8	11,5	7,0	6,0	29,5	6,4		600/50		
			8 C6-516	5,8	15,0	9,0	8,0	33,5	8,4		600/50		
			10 C6-38	5,8	18,0	11,0	10,0	37,5	10,5		600/50		
			12 C6-12	5,8	20,0	14,0	12,0	43,5	13,2		400/50		
25	4	50	4 C4-8	6,2	12,5	5,0	4,0	25,5	4,3	GREY	600/50		
			5 C4-10	6,2	12,5	6,5	6,0	29,0	5,3		600/50		
			6 C4-14	6,2	12,5	7,0	6,0	29,5	6,4		600/50		
			8 C4-516	6,2	15,0	9,0	8,0	33,5	8,4		600/50		
			10 C4-38	6,2	18,0	11,0	10,0	37,5	10,5		400/50		
			12 C4-12	6,2	20,0	14,0	12,0	42,5	13,2		400/50		
35	2	75	4 C3-8	7,0	14,0	5,0	4,0	28,0	4,3	WHITE	600/50		
			5 C3-10	7,0	14,0	6,5	6,0	31,5	5,3		600/50		
			6 C3-14	7,0	14,0	7,0	6,0	32,0	6,4		600/50		
			8 C3-516	7,0	15,0	9,0	8,0	36,0	8,4		600/50		
			10 C3-38	7,0	18,0	11,0	10,0	40,0	10,5		400/50		
			12 C3-12	7,0	21,0	14,0	12,0	45,0	13,2		400/50		
50	1/0	100	5 C2-10	7,6	17,0	6,5	6,0	33,0	5,3	BROWN	400/50		
			6 C2-14	7,6	17,0	7,0	6,0	33,5	6,4		400/50		
			8 C2-516	7,6	17,0	9,0	8,0	37,5	8,4		400/50		
			10 C2-38	7,6	19,0	11,0	10,0	41,5	10,5		400/50		
			12 C2-12	7,6	21,0	14,0	12,0	46,5	13,2		200/50		
			70	2/0	125	6 C1-14	8,9	17,0	7,0		6,0	34,5	6,4
8 C1-516	8,9	17,0				9,0	8,0	38,5	8,4	400/50			
10 C1-38	8,9	19,0				11,0	10,0	42,5	10,5	200/50			
12 C1-12	8,9	21,0				14,0	12,0	47,5	13,2	200/50			
6 C1/0-14	10,0	19,0				8,0	7,0	40,5	6,4	200/25			
8 C1/0-516	10,0	19,0				9,0	8,0	42,5	8,4	200/25			
95	3/0	150	10 C1/0-38	10,0	20,0	11,0	10,0	46,5	10,5	PINK	200/25		
			12 C1/0-12	10,0	21,0	14,0	12,0	51,5	13,2		200/25		
			14 C1/0-916	10,0	25,0	16,0	14,0	55,5	15,0		200/25		
			16 C1/0-58	10,0	26,0	18,0	16,0	59,5	17,0		200/25		
			6 C2/0-14	11,3	21,0	8,0	7,0	44,0	6,4		200/25		
			8 C2/0-516	11,3	21,0	9,0	8,0	46,0	8,4		200/25		
100	4/0	200	10 C2/0-38	11,3	21,0	11,0	10,0	50,0	10,5	BLACK	200/25		
			12 C2/0-12	11,3	22,0	14,0	12,0	55,0	13,2		200/25		
			14 C2/0-916	11,3	25,0	16,0	14,0	59,0	15,0		100/25		
			16 C2/0-58	11,3	26,0	18,0	16,0	63,0	17,0		100/25		
			20 C2/0-34	11,3	29,5	22,0	20,0	75,0	21,0		100/25		
			120	5/0	300	6 C3/0-14	12,4	23,0	8,0		7,0	45,0	6,4
8 C3/0-516	12,4	23,0				9,0	8,0	47,0	8,4	100/25			
10 C3/0-38	12,4	23,0				11,0	10,0	51,0	10,5	100/25			
12 C3/0-12	12,4	24,0				14,0	12,0	56,0	13,2	100/25			
14 C3/0-916	12,4	27,0				16,0	14,0	60,0	15,0	100/25			
16 C3/0-58	12,4	28,0				18,0	16,0	64,0	17,0	100/25			
			20 C3/0-34	12,4	31,5	22,0	20,0	72,0	21,0	100/25			

COLOUR CODED COPPER CRIMPING LUGS

for Copper conductors

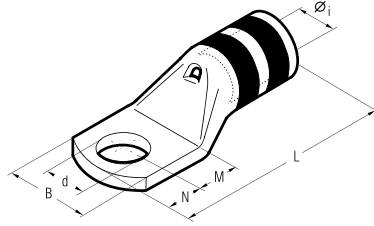

Cond. Size sqmm	Sez. Cond. AWG		Ø Stud mm	Type	Dimensions mm						Colour Code	Quantity Box/Bag	Mechanical Tools	Hydraulic Tools													
	Size	Navy			Øi	B	M	N	L	d				HT120 and tools and heads with 130 kN crimping force	ECW-H3D RHU520												
4/0	200	6	C4/0-14	13,5	25,0	8,0	7,0	50,5	6,4	PURPLE	100/25	TNI20SE	HT51 RH50 B500ND	HT120 and tools and heads with 130 kN crimping force	ECW-H3D RHU520												
		8	C4/0-516	13,5	25,0	9,0	8,0	52,5	8,4		100/25																
		10	C4/0-38	13,5	25,0	11,0	10,0	56,5	10,5		100/25																
		12	C4/0-12	13,5	25,0	14,0	12,0	61,5	13,2		100/25																
		14	C4/0-916	13,5	25,0	16,0	14,0	65,5	15,0		100/25																
		16	C4/0-58	13,5	27,0	18,0	16,0	69,5	17,0		50/25																
120	250	20	C4/0-34	13,5	29,5	22,0	20,0	77,5	21,0	50/25	YELLOW					TNI20SE	HT51 RH50 B500ND	HT120 and tools and heads with 130 kN crimping force	ECW-H3D RHU520								
		6	C250-14	15,2	28,5	8,0	7,0	52,0	6,4	100/25																	
		8	C250-516	15,2	28,5	9,0	8,0	54,0	8,4	100/25																	
		10	C250-38	15,2	28,5	11,0	10,0	58,0	10,5	100/25																	
		12	C250-12	15,2	28,5	14,0	12,0	63,0	13,2	50/25																	
		14	C250-916	15,2	28,5	16,0	14,0	67,0	15,0	50/25																	
150	300	16	C250-58	15,2	28,5	18,0	16,0	71,0	17,0	50/25	WHITE									TNI20SE	HT51 RH50 B500ND	HT120 and tools and heads with 130 kN crimping force	ECW-H3D RHU520				
		20	C250-34	15,2	30,0	22,0	20,0	79,0	21,0	50/25																	
		22	C250-78	15,2	32,0	24,0	23,0	84,0	23,0	50/25																	
		8	C300-516	16,7	31,5	13,0	11,0	69,0	8,4	40/10																	
		10	C300-38	16,7	31,5	13,0	11,0	69,0	10,5	40/10																	
		12	C300-12	16,7	31,5	16,0	14,0	75,0	13,2	40/10																	
185	350	14	C300-916	16,7	31,5	18,0	16,0	79,0	15,0	40/10	RED													TNI20SE	HT51 RH50 B500ND	HT120 and tools and heads with 130 kN crimping force	ECW-H3D RHU520
		16	C300-58	16,7	31,5	19,0	17,0	81,0	17,0	40/10																	
		20	C300-34	16,7	31,5	22,0	20,0	87,0	21,0	40/10																	
		22	C300-78	16,7	31,5	24,0	23,0	92,0	23,0	40/10																	
		10	C350-38	17,6	33,0	13,0	11,0	70,5	10,5	40/20																	
		12	C350-12	17,6	33,0	16,0	14,0	76,5	13,2	40/20																	
400	400	14	C350-916	17,6	33,0	18,0	16,0	80,5	15,0	40/20	BLUE	TNI20SE	HT51 RH50 B500ND	HT120 and tools and heads with 130 kN crimping force	ECW-H3D RHU520												
		16	C350-58	17,6	33,0	19,0	17,0	82,5	17,0	40/20																	
		20	C350-34	17,6	33,0	22,0	20,0	88,5	21,0	40/20																	
		22	C350-78	17,6	37,0	24,0	23,0	93,5	23,0	30/15																	
		10	C400-38	19,2	35,5	13,0	11,0	76,0	10,5	40/20																	
		12	C400-12	19,2	35,5	16,0	14,0	82,0	13,2	40/20																	
240	500	14	C400-916	19,2	35,5	18,0	16,0	86,0	15,0	40/20	BROWN					TNI20SE	HT51 RH50 B500ND	HT120 and tools and heads with 130 kN crimping force	ECW-H3D RHU520								
		16	C400-58	19,2	35,5	19,0	17,0	88,0	17,0	40/20																	
		20	C400-34	19,2	35,5	22,0	20,0	94,0	21,0	40/20																	
		22	C400-78	19,2	35,5	24,0	23,0	99,0	23,0	40/20																	
		10	C500-38	21,1	39,0	13,0	11,0	82,0	10,5	30/15																	
		12	C500-12	21,1	39,0	16,0	14,0	88,0	13,2	30/15																	
300	600	14	C500-916	21,1	39,0	18,0	16,0	92,0	15,0	30/15	GREEN									TNI20SE	HT51 RH50 B500ND	HT120 and tools and heads with 130 kN crimping force	ECW-H3D RHU520				
		16	C500-58	21,1	39,0	19,0	17,0	94,0	17,0	30/15																	
		20	C500-34	21,1	39,0	22,0	20,0	100,0	21,0	20/10																	
		22	C500-78	21,1	39,0	24,0	23,0	105,0	23,0	20/10																	
		12	C600-12	23,7	44,0	20,0	14,0	99,0	13,2	20/10																	
		14	C600-916	23,7	44,0	22,0	16,0	103,0	15,0	20/10																	
750	MCM	16	C600-58	23,7	44,0	22,0	19,0	106,0	17,0	20/10	BLACK													TNI20SE	HT51 RH50 B500ND	HT120 and tools and heads with 130 kN crimping force	ECW-H3D RHU520
		20	C600-34	23,7	44,0	24,0	23,0	112	21,0	10/5																	
		22	C600-78	23,7	44,0	24,0	23,0	112,0	23,0	10/5																	
		12	C750-12	26,0	48,0	22,0	19,0	113,0	13,2	10/5																	
		16	C750-58	26,0	48,0	22,0	19,0	113,0	17,0	10/5																	
		20	C750-34	26,0	48,0	24,0	23,0	119,0	21,0	10/5																	
22	C750-78	26,0	48,0	24,0	23,0	119,0	23,0	10/5																			

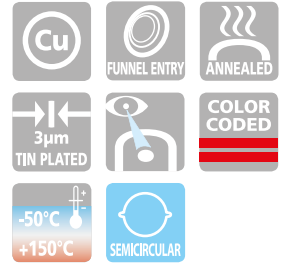

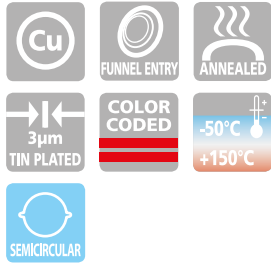
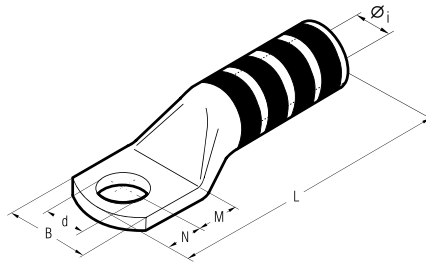

CL series lugs are manufactured from electrolytic Copper tube with a purity greater than 99.9%, for use in heavy duty applications.

The dimensions of the tube are designed to obtain the most efficient electrical conductivity and mechanical strength to resist vibration and pull out.

CEMBRE lugs are annealed to guarantee optimum ductility which is an absolute necessity for connectors which will have to withstand the severe deformation arising when compressed and any bending of the palm during installation.

In applications subject to vibration, terminals have to perform a reliable connection, the annealing process plays a vital role in avoiding cracking or breaks between the barrel and palm.

The long barrel provides better mechanical pull-out strength. Lugs are electrolytically Tin plated to avoid oxidation.

The tongue is clearly marked with wire size and die index for CEMBRE tools.

UL listed for US and Canada per UL486A up to 35 KV.

CL series lugs are an important part of CEMBRE crimping systems for power carrying conductors.

Details of the appropriate crimping tools and dies are shown on page 379.

CEMBRE technicians are available to provide technical advice as required. Please consult CEMBRE for products not listed.

Cond. Size sqmm	Conductor AWG	Ø Stud mm	Type	Dimensions mm						Colour Code	Quantity Box/Bag	Mechanical Tools	Hydraulic Tools						
				Øi	B	M	N	L	d										
10	8	23	5 CL8-10	4,6	10,0	6,5	6,0	37,5	5,3	RED	400/50	TN120SE	HT120 and tools with 130 kN crimping force						
			6 CL8-14	4,6	11,0	7,0	6,0	38,0	6,4	RED	400/50								
			10 CL8-38	4,6	18,0	11,0	10,0	46,0	10,5	RED	400/50								
16	6	60	5 CL6-10	5,8	11,5	6,5	6,0	40,0	5,3	BLUE	400/50			TN120SE	HT120 and tools with 130 kN crimping force				
			6 CL6-14	5,8	11,5	7,0	6,0	40,5	6,4	BLUE	400/50								
			12 CL6-12	5,8	20,0	14,0	12,0	53,5	13,2	BLUE	400/50								
25	4	40	5 CL4-10	6,2	12,5	6,5	6,0	47,0	5,3	GREY	400/50					TN120SE	HT120 and tools with 130 kN crimping force		
			6 CL4-14	6,2	12,5	7,0	6,0	47,5	6,4	GREY	400/50								
			10 CL4-38	6,2	18,0	11,0	10,0	55,5	10,5	GREY	400/50								
35	2	60	5 CL2-10	7,6	17,0	6,5	6,0	46,0	5,3	BROWN	200/50							TN120SE	HT120 and tools with 130 kN crimping force
			6 CL2-14	7,6	17,0	7,0	6,0	46,5	6,4	BROWN	200/50								
			8 CL2-516	7,6	17,0	9,0	8,0	50,5	8,4	BROWN	200/50								
50	1/0	100	12 CL2-12	7,6	21,0	14,0	12,0	59,5	13,2	BROWN	200/50	TN120SE	HT120 and tools with 130 kN crimping force						
			5 CL1-10	8,9	17,0	6,5	6,0	48,0	5,3	GREEN	200/50								
			8 CL1-516	8,9	17,0	9,0	8,0	52,5	8,4	GREEN	200/50								
70	2/0	125	12 CL1-12	8,9	21,0	14,0	12,0	61,5	13,2	GREEN	200/50			TN120SE	HT120 and tools with 130 kN crimping force				
			5 CL1/0-10	10,0	19,0	8,0	7,0	53,5	5,3	PINK	100/50								
			8 CL1/0-516	10,0	19,0	9,0	8,0	55,5	8,4	PINK	100/50								
95	3/0	150	10 CL1/0-38	10,0	20,0	11,0	10,0	59,5	10,5	PINK	100/50					TN120SE	HT120 and tools with 130 kN crimping force		
			12 CL1/0-12	10,0	21,0	14,0	12,0	64,5	13,2	PINK	100/50								
			10 CL2/0-38	11,3	21,0	11,0	10,0	67,5	10,5	BLACK	100/50								
120	250 MCM	250	12 CL2/0-12	11,3	22,0	14,0	12,0	72,5	13,2	BLACK	100/50							TN120SE	HT120 and tools with 130 kN crimping force
			12 CL3/0-12	12,4	24,0	14,0	12,0	71,5	13,2	ORANGE	100/50								
			10 CL4/0-38	13,5	25,0	11,0	10,0	73,5	10,5	PURPLE	60/30								
150	300 MCM	300	12 CL4/0-12	13,5	25,0	14,0	12,0	78,5	13,2	PURPLE	60/30	TN120SE	HT120 and tools with 130 kN crimping force						
			12 CL250-12	15,2	28,5	14,0	12,0	84,0	13,2	YELLOW	50/25								
			12 CL300-12	16,7	31,5	16,0	14,0	98,0	13,2	WHITE	30/15								
185	350 MCM	350	12 CL350-12	17,6	33,0	16,0	14,0	98,0	13,2	RED	30/15			TN120SE	HT120 and tools with 130 kN crimping force				
			12 CL400-12	19,2	35,5	16,0	14,0	107,0	13,2	BLUE	20/10								
			16 CL400-58	19,2	35,5	19,0	17,0	113,0	17,0	BLUE	20/10								
240	500 MCM	400	12 CL500-12	21,1	39,0	16,0	14,0	108,0	13,2	BROWN	20/10					TN120SE	HT120 and tools with 130 kN crimping force		
			16 CL500-58	21,1	39,0	19,0	17,0	114,0	17,0	BROWN	20/10								
			12 CL600-12	23,7	44,0	20,0	14,0	128,5	13,2	GREEN	10/5								
300	600 MCM	400	16 CL600-58	23,7	44,0	22,0	19,0	135,5	17,0	GREEN	10/5							TN120SE	HT120 and tools with 130 kN crimping force
			12 CL750-12	26,0	48,0	22,0	19,0	140,5	13,2	BLACK	10/5								
			16 CL750-58	26,0	48,0	22,0	19,0	140,5	17,0	BLACK	10/5								

Also available with inspection hole.
In case of order, add suffix IH to the part number.
E.g.: CL250IH-12

COLOUR CODED COPPER CRIMPING LUGS

CL-D

double hole long barrel - for Copper conductors

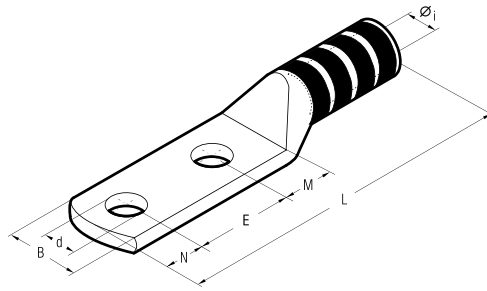

Cond. Size sqmm	Conductor AWG Size	Ø Stud mm	Type	Dimensions mm							Colour Code	Quantity Box/Bag	Mechanical Tools	Hydraulic Tools						
				Øi	B	M	E	N	L	d										
10	8	23	6 CL8-D14	4,6	11,0	7,0	16,0	6,0	53,0	6,4	RED	400/50	B15MD							
			6 CL8-D141	4,6	11,0	7,0	19,0	6,0	56,0	6,4	RED	400/50								
			10 CL8-D38	4,6	18,0	11,0	25,5	10,0	70,5	10,5	RED	400/50								
16	6	40	6 CL6-D14	5,8	11,5	7,0	16,0	6,0	54,5	6,4	BLUE	400/50			B15MD					
			6 CL6-D141	5,8	11,5	7,0	19,0	6,0	57,5	6,4	BLUE	400/50								
			10 CL6-D38	5,8	18,0	11,0	25,5	10,0	72,0	10,5	BLUE	400/50								
25	4	60	12 CL6-DN	5,8	20,0	14,0	44,5	12,0	96,0	13,2	BLUE	400/50					B15MD			
			6 CL4-D14	6,2	12,5	7,0	16,0	6,0	62,0	6,4	GREY	200/50								
			6 CL4-D141	6,2	12,5	7,0	19,0	6,0	65,0	6,4	GREY	200/50								
3	50	100	10 CL4-D38	6,2	18,0	11,0	25,5	10,0	79,5	10,5	GREY	200/50							B15MD	
			12 CL4-DN	6,2	20,0	14,0	44,5	12,0	103,5	13,2	GREY	200/50								
			10 CL3-D38	7,0	18,0	11,0	25,5	10,0	79,5	10,5	WHITE	200/50								
35	2	125	12 CL3-DN	7,0	21,0	14,0	44,5	12,0	103,5	13,2	WHITE	200/50	B15MD							
			6 CL2-D14	7,6	17,0	7,0	16,0	6,0	61,0	6,4	BROWN	200/50								
			6 CL2-D141	7,6	17,0	7,0	19,0	6,0	64,0	6,4	BROWN	200/50								
1	75	200	10 CL2-D38	7,6	19,0	11,0	25,5	10,0	78,5	10,5	BROWN	100/50			B15MD					
			10 CL2-DN38	7,6	19,0	11,0	44,5	10,0	97,5	10,5	BROWN	100/50								
			12 CL2-DN	7,6	21,0	14,0	44,5	12,0	102,5	13,2	BROWN	100/50								
50	1/0	300	6 CL1-D14	8,9	17,0	7,0	16,0	6,0	63,0	6,4	GREEN	200/50					B15MD			
			6 CL1-D141	8,9	17,0	7,0	19,0	6,0	66,0	6,4	GREEN	200/50								
			10 CL1-D38	8,9	19,0	11,0	25,5	10,0	80,5	10,5	GREEN	100/25								
70	2/0	400	12 CL1-DN	8,9	21,0	14,0	44,5	12,0	104,5	13,2	GREEN	100/25							B15MD	
			6 CL1/0-D14	10,0	19,0	7,9	16,0	7,0	68,0	6,4	PINK	100/25								
			6 CL1/0-D141	10,0	19,0	7,9	19,0	7,0	71,0	6,4	PINK	100/25								
95	3/0	600	10 CL1/0-D38	10,0	20,0	10,9	25,5	10,0	83,5	10,5	PINK	100/25	B15MD							
			12 CL1/0-DN	10,0	21,0	14,0	44,5	12,0	107,5	13,2	PINK	100/25								
			6 CL2/0-D14	11,3	21,0	7,8	16,0	7,0	76,0	6,4	BLACK	60/30								
120	MCM	900	6 CL2/0-D141	11,3	21,0	7,8	19,0	7,0	79,0	6,4	BLACK	60/30			B15MD					
			10 CL2/0-D38	11,3	21,0	11,0	25,5	10,0	91,5	10,5	BLACK	60/30								
			12 CL2/0-DN	11,3	22,0	14,0	44,5	12,0	115,5	13,2	BLACK	60/30								
150	MCM	1200	6 CL3/0-D141	12,4	23,3	8,0	19,0	7,0	82,0	6,4	ORANGE	60/30					B15MD			
			10 CL3/0-D38	12,4	23,3	11,0	25,5	10,0	94,5	10,5	ORANGE	60/30								
			12 CL3/0-DN	12,4	24,0	14,0	44,5	12,0	118,5	13,2	ORANGE	60/30								
185	MCM	1500	6 CL4/0-D141	13,5	25,0	13,0	19,0	11,0	94,0	6,4	PURPLE	50/25							B15MD	
			10 CL4/0-D38	13,5	25,0	11,0	25,5	10,0	97,5	10,5	PURPLE	50/25								
			10 CL4/0-DN38	13,5	25,0	11,0	44,5	10,0	116,5	10,5	PURPLE	50/25								
240	MCM	2100	12 CL4/0-DN	13,5	25,0	14,0	44,5	12,0	121,5	13,2	PURPLE	50/25	B15MD							
			10 CL250-D38	15,2	28,5	11,0	25,5	10,0	103,0	10,5	YELLOW	40/20								
			12 CL250-DN	15,2	28,5	14,0	44,5	12,0	127,0	13,2	YELLOW	40/20								
300	MCM	2700	10 CL300-D38	16,7	31,5	13,0	25,5	11,0	116,0	10,5	WHITE	30/15			B15MD					
			12 CL300-DN	16,7	31,5	16,0	44,5	14,0	141,0	13,2	WHITE	30/15								
			6 CL350-D141	17,6	33,0	13,0	19,0	11,0	109,5	6,4	RED	30/15								
300	MCM	2700	10 CL350-D38	17,6	33,0	13,0	25,5	11,0	116,0	10,5	RED	30/15					B15MD			
			12 CL350-DN	17,6	33,0	16,0	44,5	14,0	141,0	13,2	RED	30/15								
			6 CL400-D141	19,2	35,5	13,0	19,0	11,0	118,5	6,4	BLUE	20/10								
300	MCM	2700	10 CL400-D38	19,2	35,5	13,0	25,5	11,0	125,0	10,5	BLUE	20/10							B15MD	
			12 CL400-DN	19,2	35,5	16,0	44,5	14,0	150,0	13,2	BLUE	20/10								
			6 CL500-D141	21,1	39,0	13,0	19,0	11,0	119,5	6,4	BROWN	20/10								
300	MCM	2700	10 CL500-D38	21,1	39,0	13,0	25,5	11,0	126,0	10,5	BROWN	10/5	B15MD							
			12 CL500-DN	21,1	39,0	16,0	44,5	14,0	151,0	13,2	BROWN	10/5								
			10 CL600-D38	23,7	44,0	20,0	25,5	11,0	149,5	10,5	GREEN	20/5								
300	MCM	2700	12 CL600-DN	23,7	44,0	20,0	44,5	14,0	171,5	13,2	GREEN	20/5			B15MD					
			10 CL750-DN38	26,0	48,0	20,0	44,5	11,0	173,5	10,5	BLACK	15/5								
			10 CL750-D38	26,0	48,0	20,0	25,5	11,0	154,5	10,5	BLACK	15/5								
300	MCM	2700	12 CL750-DN	26,0	48,0	20,0	44,5	14,0	176,5	13,2	BLACK	15/5					B15MD			



CL series lugs are manufactured from electrolytic Copper tube with a purity greater than 99.9%.

The dimensions of the tube are designed to obtain the most efficient electrical conductivity and mechanical strength to resist vibration and pull out.

CEMBRE lugs are annealed to guarantee optimum ductility, an absolute necessity for connectors which will have to withstand the severe deformation arising when compressed and any bending of the palm during installation.

In applications subject to vibration, terminals have to perform a reliable connection, the annealing process plays a vital role in avoiding cracking or breaks between the barrel and palm.

The barrel length has been designed to allow easy and accurate positioning of the dies during the crimping operation.

Lugs are electrolytically Tin plated to avoid oxidation.

The tongue is clearly marked with wire size and die index for CEMBRE tools.

UL listed for US and Canada per UL486A up to 35 KV.

CL series lugs are an important part of CEMBRE crimping systems for power carrying conductors.

Details of the appropriate crimping tools and dies are shown on page 379.

CEMBRE technicians are available to provide technical advice as required.

Please consult CEMBRE for products not listed.

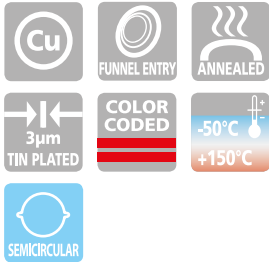
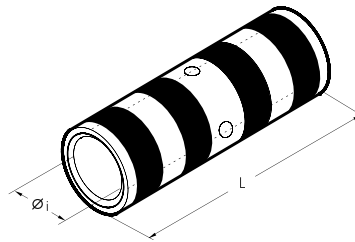

BSCL range of connectors are designed for jointing low voltage conductors in heavy duty applications. Made of electrolytic Copper tube with a purity greater than 99.9%, having the same dimension as C and CL series lugs, BSCL connectors are annealed and electrolytically Tin plated. They feature an internal taper at both ends to ease the introduction of the conductor and a central stop to ensure correct positioning. **UL listed for US and Canada per UL486A up to 35 KV.**

Appropriate crimping tools and dies are shown in details on page 379.

Conductor Size sqmm (AWG)	Conductor Size AWG	Type	Dimensions mm		Colour Code	Quantity Box/Bag	Mechanical Tools			Hydraulic Tools					
			ø1	L			HN1	HN5	TN70	TN120S	B15MD	HT51 RH50 B500ND	HTT120 and tools and heads with 130 kN crimping force	ECW-HBD RHU520	
10	8	BSCL8	4,6	50,5	RED	600/150									
16	6	BSCL6	5,8	50,5	BLUE	400/100									
25	4	BSCL4	6,2	60,5	GREY	200/100									
	3	BSCL3	7,0	60,5	WHITE	200/50									
35	2	BSCL2	7,6	60,5	BROWN	200/50									
	1	BSCL1	8,9	65,5	GREEN	200/50									
50	1/0	BSCL1/0	10,0	73,0	PINK	200/50									
70	2/0	BSCL2/0	11,3	79,0	BLACK	100/50									
95	3/0	BSCL3/0	12,4	79,0	ORANGE	80/40									
	4/0	BSCL4/0	13,5	85,5	PURPLE	50/25									
120	250 MCM	BSCL250	15,2	85,5	YELLOW	50/25									
150	300 MCM	BSCL300	16,7	104,5	WHITE	40/20									
185	350 MCM	BSCL350	17,6	104,5	RED	40/20									
	400 MCM	BSCL400	19,2	111,0	BLUE	20/10									
240	500 MCM	BSCL500	21,1	117,0	BROWN	20/10									
300	600 MCM	BSCL600	23,7	139,5	GREEN	20/10									
	750 MCM	BSCL750	26,0	149,0	BLACK	10/10									

SLEEVE CONNECTORS

for Copper conductors

C-C

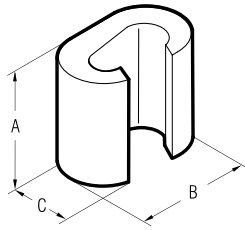

tin plated version

Conductor Size sqmm		Type	Dimensions mm			Quantity Box/Bag	Mechanical Tools	Hydraulic Tools		
Run	Tap		A	B	C			HT45-E B450ND-BV HT45-E B500 B500ND HT51 RH50 B500 RHU81-D	HT81-UD RHU81-D	ECW-H3D
6÷2,5	6÷1,5	C6-C6ST*	9,0	9,8	6,4	1.500/100	HP4-C10			
10	10÷1,5	C10-C10ST*	12,0	12,6	8,4	500/100				
16	16÷1,5	C16-C16ST	17,0	19,4	12,0	500/100				
25÷16	10÷1,5	C25-C10ST	17,0	19,8	13,0	400/50				
25	25÷16	C25-C25ST	17,0	21,4	13,0	300/50				
40÷35	16÷1,5	C35-C16ST	21,0	24,6	15,4	200/25				
40÷35	40÷25	C35-C35ST	21,0	26,6	15,6	200/25				
50	25÷10									
70÷63	25÷1,5	C70-C25N-ST	21,0	26,4	17,5	200/50				
50	25÷4	C50-C25ST	25,0	32,9	21,0	100/25				
50	50÷35	C50-C50ST	26,0	33,0	21,0	100/25				
70÷50	40÷4	C70-C35ST	28,0	33,0	21,0	100/25				
70÷50	70÷35	C70-C70ST	28,0	34,0	21,0	50/25				
100÷95	40÷4	C95-C35ST	29,0	40,6	26,0	50/25				
100÷95	70÷40	C95-C70ST	29,0	41,0	26,0	50/25				
100÷95	100÷63	C95-C95ST	29,0	41,0	26,0	50/25				
125÷110	125÷25	C120-C120ST	30,0	45,0	28,0	30/15				
160÷150	125÷25	C150-C120ST	31,0	45,0	28,0	50/25				
125	125									
150	150÷63	C150-C150ST	30,0	45,0	28,0	50/25				
125	125									
185	100÷16	C185-C95ST	31,0	45,0	28,0	30/15				
185÷120	185÷120	C185-C185ST	22,6	68,0	34,0	30/15				
240÷150	120÷95	C240-C120ST	22,6	68,0	34,0	30/15				

*Given the small size, on these connectors, only the type is engraved

bright surface version

Conductor Size sqmm		Type	Dimensions mm			Quantity Box/Bag	Mechanical Tools	Hydraulic Tools		
Run	Tap		A	B	C			HT45-E B450ND-BV HT45-E B500 B500ND HT51 RH50 B500 RHU81-D	HT81-UD RHU81-D	ECW-H3D
6÷2,5	6÷1,5	C6-C6*	9,0	9,8	6,4	1.000/100	HP4-C10			
10	10÷1,5	C10-C10*	12,0	12,6	8,4	500/100				
16	16÷1,5	C16-C16	17,0	19,4	12,0	500/100				
25÷16	10÷1,5	C25-C10	17,0	19,8	13,0	400/50				
25	25÷16	C25-C25	17,0	21,4	13,0	300/50				
40÷35	16÷1,5	C35-C16	21,0	24,6	15,4	200/25				
40÷35	40÷25	C35-C35	21,0	26,6	15,6	200/25				
50	25÷10									
70÷63	25÷1,5	C70-C25N	21,0	26,4	17,5	200/25				
50	25÷4	C50-C25	25,0	32,9	21,0	100/25				
50	50÷35	C50-C50	26,0	33,0	21,0	100/25				
70÷50	40÷4	C70-C35	28,0	33,0	21,0	100/25				
70÷50	70÷35	C70-C70	28,0	34,0	21,0	50/25				
100÷95	40÷4	C95-C35	29,0	40,6	26,0	50/25				
100÷95	70÷40	C95-C70	29,0	41,0	26,0	50/25				
100÷95	100÷63	C95-C95	29,0	41,0	26,0	50/25				
125÷110	125÷25	C120-C120	30,0	45,0	28,0	30/15				
160÷150	125÷25	C150-C120	31,0	45,0	28,0	30/15				
125	125									
150	150÷63	C150-C150	30,0	45,0	28,0	30/15				
125	125									
185	100÷16	C185-C95	31,0	45,0	28,0	30/15				
185÷120	185÷120	C185-C185	22,6	68,0	34,0	30/15				
240÷150	120÷95	C240-C120	22,6	68,0	34,0	30/15				

*Given the small size, on these connectors, only the type is engraved

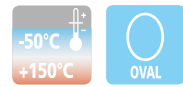

"C" connectors are manufactured from Copper profiles with a purity greater than 99.9%, and are suitable for a variety of uses either to create an earthing network or tapping off from overhead distribution lines. Each connector is marked as follows:

- CEMBRE trade mark
- Reference number
- Conductor size-Run
- Conductor size-Tap
- Number of crimps
- Die reference.

Details of the appropriate crimping tools and dies are shown on page 372.



Example of tap connection

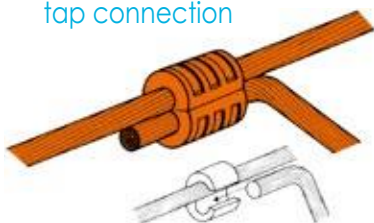

Example of joint connection

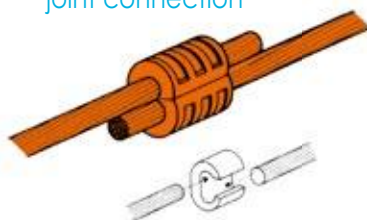

Example of joining two running conductors

Conductor Size sqmm	Type
25-25	C35-C16
35-35	C35-C35
50-50	C70-C70
63-63	C95-C70
70-70	
95-95	C150-C120
120-120	C150-C150
120-120	C185-C95
125-125	

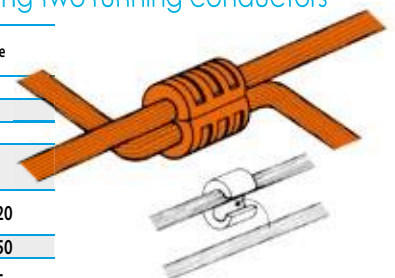

H-H

H CLAMPS

for Copper conductors

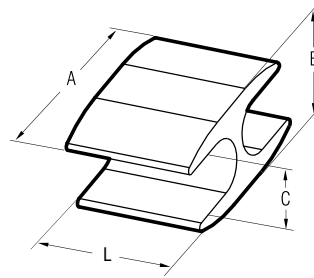

tin plated version



Conductor Size mm ²		Type	Dimensions mm				Quantity	Hydraulic Tools			
Run	Tap		A	B	C	L		HT120 and tools and heads with 130 kN crimping force	ECW-H3D	RHU450	RHU520
70	70	H70-H70ST	34,0	17,0	10,8	28,0	25				
95	95	H95-H95ST	40,0	22,0	13,0	30,0	25				
120	120	H120-H120ST	43,0	24,0	15,5	25,0	15				

bright surface version



Conductor Size mm ²		Type	Dimensions mm				Quantity	Hydraulic Tools			
Run	Tap		A	B	C	L		HT120 and tools and heads with 130 kN crimping force	ECW-H3D	RHU450	RHU520
70	70	H70-H70	34,0	17,0	10,8	28,0	25				
95	95	H95-H95	40,0	22,0	13,0	30,0	25				
120	120	H120-H120	43,0	24,0	15,5	25,0	15				

H clamps are manufactured from Copper profiles with a purity greater than 99.9%, and are suitable for a earthing systems.

Each connector is marked as follows:

- CEMBRE trade mark
- Reference number

features:

- H shape
- For Copper conductors DIN 48201
- Material: Cu ETP (CW004A) according to EN 13605
- Surface: bright and tin plated version
- Electrolytically tin plated to avoid oxidation; min 3µm

Details of the appropriate crimping tools and dies are shown on page 372.

TWIN CABLE TERMINAL LUGS FOR ROUND CONDUCTORS

DK

for Copper conductors

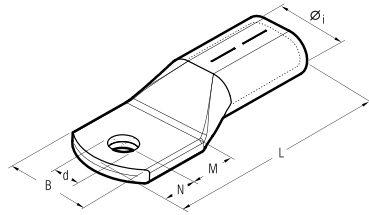

with an M12 hole

Conductor Size mm ²	Type	Dimensions mm							Quantity	Hydraulic Tools
		Øi	B	M	N	L	d			
2 x 50	DK50-M12	20,6x10,75	34,0	22,0	14,5	93,5	13,0	10	HT120 and tools and heads with 130 kN crimping force ECW-H3D RHU450 RHU520	
2 x 70	DK70-M12	23,0x12,0	37,0	22,0	14,5	97,5	13,0	10		
2 x 95	DK95-M12	26,5x12,8	42,0	23,0	16,0	108,0	13,0	10		
2 x 120	DK120-M12	29,5x15,5	48,0	24,0	14,5	115,5	13,0	5		

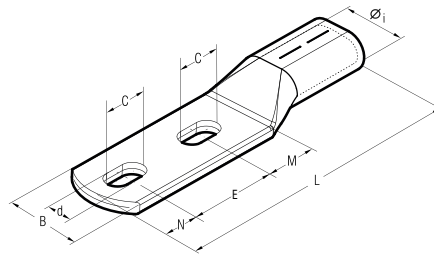
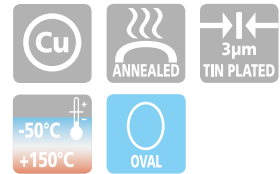

with 2 elongated holes

Conductor Size mm ²	Type	Dimensions mm									Quantity	Hydraulic Tools
		Øi	B	M	N	E	L	C	d			
2 x 70	DK70-2M12-51AS	23,0x12,0	37,0	25,5	21,5	51,0	159,0	24,0	13,0	10	HT120 and tools and heads with 130 kN crimping force ECW-H3D RHU450 RHU520	
2 x 95	DK95-2M12-51AS	26,5x12,8	42,0	25,5	21,5	51,0	167,0	24,0	13,0	10		
2 x 120	DK120-2M12-51AS	29,5x15,5	48,0	25,5	21,5	51,0	175,0	24,0	13,0	10		

DK compression cable lugs are made from Copper tube with a purity greater than 99.9% and are suitable for the compression of 2 round conductors.

Cable lugs with an M12 hole or with 2 elongated holes are available (see tables). The elongated holes 2xM12 allow easy assembly with different fastening points. This enables flexible use in earthing systems.

features:

- For copper conductors DIN 48201
- Material: Cu ETP (CW004A) according to EN13605
- Electrolytically tin plated to avoid oxidation; min 3µm
- Marking: CEMBRE logo; Type, die type (MRD ..- C); Press positions

Details of the appropriate crimping tools and dies are shown on page 372.

for Copper conductors

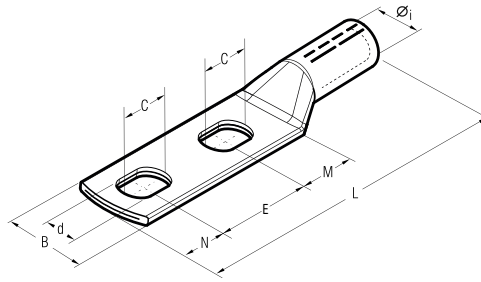

with 2 elongated holes

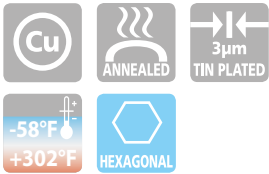

DR compression cable lugs are made from Copper tube with a purity greater than 99.9%. They are available with 2 slotted holes (see tables). The slotted holes 2xM12 enable easy installation with different attachment points.

features:

- For copper conductors DIN 48201
- Material: Cu ETP (CW004A) according to EN13605
- Electrolytically tin plated to avoid oxidation; min 3µm
- Marking: CEMBRE logo; Type, die type (MK.); Press positions

Details of the appropriate crimping tools and dies are shown on page 372.

Conductor Size sqmm	Type	Dimensions mm								Quantity	Mechanical Tools	Hydraulic Tools														
		Øi	B	M	N	E	L	C	d			HT45-E	B450ND-BV	HT51	RH50	B500	B500ND	RH60C	HT60C	B600C	B600CND	HT81-UD	RHU81-D	HT120 and tools and heads with 130 kN crimping force	ECW-H3D	RHU520
70	DR70-2M12-51AS	11,5	24,0	25,5	21,5	51,0	140,0	24,0	13,0	10	TNE-D120	HT45-E	B450ND-BV	HT51	RH50	B500	B500ND	RH60C	HT60C	B600C	B600CND	HT81-UD	RHU81-D	HT120 and tools and heads with 130 kN crimping force	ECW-H3D	RHU520
95	DR95-2M12-51AS	13,5	28,0	25,5	21,5	51,0	150,0	24,0	13,0	10																
120	DR120-2M12-51AS	15,5	32,0	25,5	21,5	51,0	151,0	24,0	13,0	10																

MECHANICAL FIXING LUGS

21..

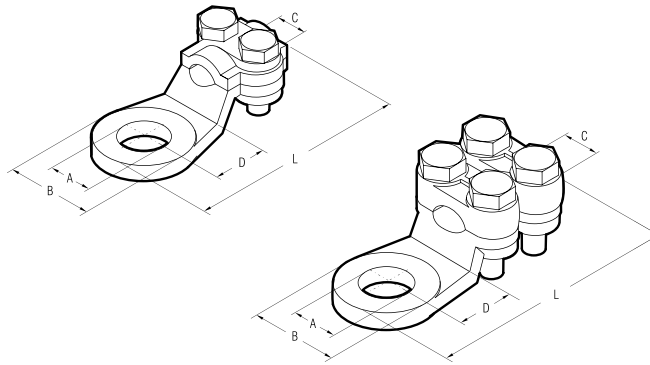

2 bolt fixing lugs

Conductor Size sqmm	Type	Clamping Bolt		Ø A Bolt	Dimensions mm				Quantity
		Ø	Torque Ratio Nm		B	C	D	L	
16	2155	M5	3	M8	18,0	4,5	12,5	39	100
16	2171	M5	3	M10	18,0	4,5	12,5	39	100
25	2156	M5	3	M8	19,5	6,0	13,0	43	150/50
25	2172	M5	3	M10	19,5	6,0	13,0	43	100
35	2157	M5	3	M12	23,0	7,0	15,0	49	100/50
35	2173	M5	3	M14	23,0	7,0	15,0	49	50
50	2174	M6	5	M14	25,0	8,0	17,0	56	50



Material:
Brass CB754S EN 1982 Nickel plated.
Zinc plated Steel bolts.

4 bolt fixing lugs

Conductor Size sqmm	Type	Clamping Bolt		Ø A Bolt	Dimensions mm				Quantity
		Ø	Torque Ratio Nm		B	C	D	L	
50	2158	M6	5	M12	23,5	8	16,0	57	50/25
75	2160	M6	5	M12	28,0	10	20,0	65	25
75	2176	M6	5	M16	28,0	10	20,0	65	25
100	2161*	M6	5	M12	31,0	13	17,0	66	25
125	2162*	M7	10	M15	33,0	14	18,0	71	25
150	2163*	M7	10	M14	34,0	16	19,5	75	25
175	2164*	M7	10	M15	36,0	16	21,0	78	25



* Versions with U-bolts in bent steel

CABLE CLAMPS

23..

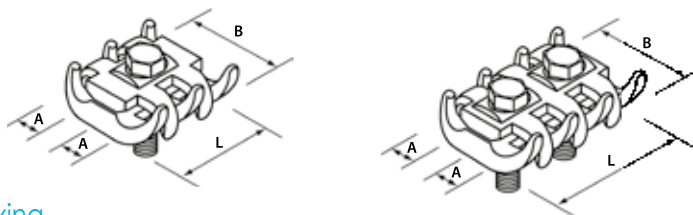

Single bolt fixing

Conductor Size sqmm	Type	Clamping Bolt		A for Cable mm	Dimensions mm		Quantity
		Ø	Torque Ratio Nm		B	L	
6÷16	2323	M6	8	3÷5	24	20,0	150/50
16÷50	2326	M8	15	5÷8	32	28,4	50/25
35÷70	2329	M8	15	7÷12	40	30,0	40/10



2 bolt fixing

Conductor Size sqmm	Type	Clamping Bolt		A for Cable mm	Dimensions mm		Quantity
		Ø	Torque Ratio Nm		B	L	
6÷16	2333	M6	8	3÷5	24,5	30	100/50
16÷50	2336	M8	15	5÷8	32,0	40	40/10
35÷70	2339	M8	15	7÷12	40,0	44	20/10
50÷95	2342	M10	35	8÷14	48,0	48	10
95÷150	2344	M10	35	12÷16	51,0	53	10
150÷300	2346*	M12	60	16÷22	66,0	66	5

Material:
Brass CB754S EN 1982
White zinc plated Steel bolts.
White zinc plated Steel nuts.

* Stainless Steel bolts

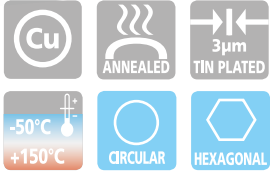
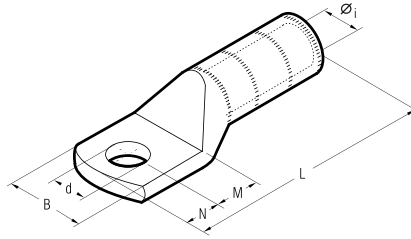

Series CA-M and 2A-M terminals are designed for medium voltage applications up to 35 kV. They are manufactured from Copper tube with a purity greater than 99.9%, annealed and Tin plated. The extended barrel enhances both electrical and mechanical performance. The absence of an inspection hole prevents moisture entry into the crimped joint and makes these terminals suitable for outdoor applications. Details of the appropriate crimping tools and dies are shown on page 373.

Conductor Size (sqmm) & Format	Ø Stud mm	Type	Dimensions mm						Quantity Box/Bag	Hydraulic Tools	
			Øi	B	M	N	L	d			
25 R/BR/BS*	8	CA25-M8	6,8	14,0	9,0	8,0	65,0	8,4	300/50	HT45-E	B450ND-BV
	10	CA25-M10	6,8	18,0	13,0	11,0	72,0	10,5	200/50		
	12	CA25-M12	6,8	21,0	16,0	14,0	78,0	13,2	150/50		
30 RC/S ÷ 40 S	12	CA40S-M12	8,2	21,0	16,0	14,0	79,0	13,2	100/50		
	16	CA40S-M16	8,2	26,0	19,0	17,0	85,0	17,0	100/50		
35 BR/BS*	10	CA35-M10	8,3	21,0	13,0	11,0	73,0	10,5	150/50		
	12	CA35-M12	8,3	21,0	16,0	14,0	79,0	13,2	150/50		
	16	CA35-M16	8,3	26,0	19,0	17,0	85,0	17,0	150/50		
50 RC	12	CA50R-M12	8,7	20,5	16,0	14,0	79,0	13,2	100/50		
50 S	12	CA50S-M12	9,5	21,0	16,0	14,0	79,0	13,2	100/50		
	16	CA50S-M16	9,5	26,0	19,0	17,0	85,0	17,0	100/50		
50 BR/BS*	10	CA50-M10	9,5	21,0	13,0	11,0	73,0	10,5	150/50		
	12	CA50-M12	9,5	21,0	16,0	14,0	79,0	13,2	150/50		
	14	CA50-M14	9,5	25,0	18,0	16,0	83,0	15,0	100/50		
	16	CA50-M16	9,5	26,0	19,0	17,0	85,0	17,0	100/50		
63 S ÷ 70 S	12	CA70S-M12	11,0	28,0	16,0	14,0	81,2	13,2	30/15		
	16	CA70S-M16	11,0	30,0	19,0	17,0	87,2	17,0	50/25		
70 BR/BS*	10	CA70S-M10	11,0	26,0	13,0	11,0	75,2	10,5	50/25		
	12	CA70S-M12	11,0	28,0	16,0	14,0	81,2	13,2	30/15		
	14	CA70S-M14	11,0	28,0	18,0	16,0	85,2	15,0	50/25		
	16	CA70S-M16	11,0	30,0	19,0	17,0	87,2	17,0	50/25		
80 S ÷ 95 RC	12	CA95R-M12	12,0	28,0	16,0	14,0	91,0	13,2	30/15		
	14	CA95R-M14	12,0	29,0	18,0	16,0	95,0	15,0	50/25		
95 S ÷ 100 S	12	CA95S-M12	13,5	28,0	16,0	14,0	91,0	13,2	30/15		
	14	CA95S-M14	13,5	29,0	18,0	16,0	94,5	15,0	50/25		
	16	CA95S-M16	13,5	30,0	20,0	17,0	97,0	17,0	50/25		
95 BR/BS*	10	CA95-M10	13,5	28,0	13,0	11,0	85,0	10,5	50/25		
	12	CA95-M12	13,5	28,0	16,0	14,0	91,0	13,2	50/25		
	16	CA95-M16	13,5	30,0	20,0	17,0	97,0	17,0	50/25		
	120 RC/S ÷ 150 RC	12	CA150R-M12	15,0	31,0	16,0	14,0	97,0	13,2		
14		CA150R-M14	15,0	31,0	18,0	16,0	101,0	15,0	30/15		
120 BR/BS*	12	CA120-M12	15,0	31,0	16,0	14,0	97,0	13,2	30/15		
	16	CA120-M16	15,0	31,0	19,0	17,0	103,0	17,0	30/15		
150 S ÷ 160 RC	12	CA150S-M12	16,5	32,0	16,0	14,0	97,0	13,2	30/15		
	14	CA150S-M14	16,5	32,0	18,0	16,0	101,0	15,0	30/15		
150 BR/BS*	12	CA150-M12	16,5	32,0	16,0	14,0	97,0	13,2	30/15		
	16	CA150-M16	16,5	32,0	19,0	17,0	103,0	17,0	30/15		
160 S ÷ 200 RC	14	CA200R-M14	17,0	32,5	18,0	16,0	101,0	15,0	30/15		
185 BR/BS*	12	CA185-M12	18,0	33,5	16,0	14,0	97,0	13,2	30/15		
	16	CA185-M16	18,0	33,5	19,0	17,0	103,0	17,0	30/15		
200 S ÷ 240 RC	14	CA240R-M14	19,2	43,0	18,0	16,0	107,0	15,0	15/5		
240 S ÷ 315 RC	14	CA315R-M14	21,5	43,0	18,0	16,0	105,0	15,0	15/5		
	12	CA240-M12	20,5	42,0	16,0	14,0	103,0	13,2	15/5		
240 BR/BS*	16	CA240-M16	20,5	42,0	19,0	17,0	109,0	17,0	15/5		
	20	CA240-M20	20,5	42,0	22,0	20,0	115,0	21,0	15/5		
300 BR/BS*	12	CA300-M12	23,0	43,5	16,0	14,0	109,5	13,2	15/5		
	16	CA300-M16	23,0	43,5	19,0	17,0	115,5	17,0	15/5		
	20	CA300-M20	23,0	43,5	22,0	20,0	121,5	21,0	15/5		
315 S	14	CA315S-M14	23,7	44,0	18,0	16,0	105,0	15,0	15/5		

Conductor Format: R = Round, RC = Round Compact, S = Sector, BR = BS EN 60228 Round, BS* = BS EN 60228 size - Sector shaped
 * = Pre-rounding required, consult CEMBRE for appropriate die set

MEDIUM VOLTAGE COPPER TERMINALS

CA-2M

two hole fixing

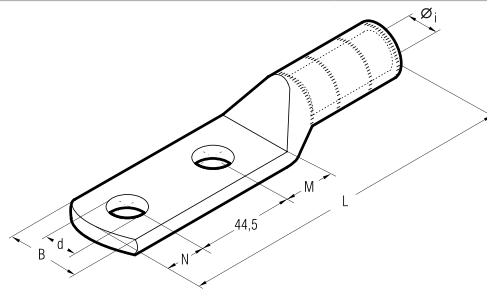

Conductor Size (sqmm) & Format	Ø Stud mm	Type	Dimensions mm						Quantity Box/Bag	Hydraulic Tools
			Øi	B	M	N	L	d		
25 R	8	CA25-2M8	6,8	14,0	10,0	11,0	113,5	8,4	200/50	HT45-E B450ND-BV HT45-E B500ND B550 HT51 RH50 B500 B500ND RHU81-D HT120 and tools and heads with 130 kN crimping force ECW-H3D RHU520
	12	CA25-2M12	6,8	21,0	16,0	14,0	122,5	13,2	100/50	
25 BR/BS*	8	CA25-2M8	6,8	14,0	10,0	11,0	113,5	8,4	200/50	
	10	CA25-2M10	6,8	18,0	13,0	11,0	116,5	10,5	150/50	
30 RC/S ÷ 40 S	12	CA40S-2M12	8,2	21,5	16,0	14,0	123,5	13,2	100/50	
	12	CA25-2M12	6,8	21,0	16,0	14,0	122,5	13,2	150/50	
35 BR/BS*	12	CA35-2M12	8,3	21,5	16,0	14,0	123,5	13,2	100	
50 RC	12	CA50R-2M12	8,7	20,5	16,0	14,0	123,5	13,2	100/50	
50 S	12	CA50S-2M12	9,5	21,0	16,0	14,0	123,5	13,2	100/50	
50 BR/BS*	12	CA50-2M12	9,5	21,0	16,0	14,0	123,5	13,2	90/3	
63 S ÷ 70 S	12	CA70S-2M12	11,0	27,0	16,0	14,0	125,5	13,2	50/25	
70 BR/BS*	12	CA70S-2M12	11,0	27,0	16,0	14,0	125,5	13,2	50/25	
80 S ÷ 95 RC	14	CA95R-2M14	12,0	28,0	18,0	16,0	139,5	15,0	30/15	
95 S ÷ 100 S	14	CA95S-2M14	13,5	29,0	18,0	16,0	139,5	15,0	30/15	
95 BR/BS*	12	CA95-2M12	13,5	28,0	16,0	14,0	135,5	13,2	30/15	
120 RC/S ÷ 150 RC	14	CA150R-2M14	15,0	31,0	18,0	16,0	145,5	15,0	30/15	
120 BR/BS*	12	CA120-2M12	15,0	31,0	16,0	14,0	141,5	13,2	30/15	
150 S ÷ 160 RC	14	CA150S-2M14	16,5	32,0	18,0	16,0	145,5	15,0	30/15	
150 BR/BS*	12	CA150-2M12	16,5	32,0	16,0	14,0	141,5	13,2	30/15	
160 S ÷ 200 RC	14	CA200R-2M14	17,0	32,5	18,0	16,0	145,0	15,0	30/15	
185 BR/BS*	12	CA185-2M12	18,0	32,5	16,0	14,0	141,5	13,2	30/15	
200 S ÷ 240 RC	14	CA240R-2M14	19,2	43,0	18,0	16,0	151,5	15,0	15/5	
240 S ÷ 315 RC	14	CA315R-2M14	21,5	43,0	18,0	16,0	149,5	15,0	20/5	
240 BR/BS*	12	CA240-2M12	20,5	43,0	16,0	14,0	147,5	13,2	15/5	
300 BR/BS*	12	CA300-2M12	23,0	43,0	16,0	14,0	145,5	13,2	15/5	
315 S	14	CA315S-2M14	23,7	44,0	18,0	16,0	149,5	15,0	20/5	

Conductor Format: R = Round, RC = Round Compact, S = Sector, BR = BS EN 60228 Round, BS* = BS EN 60228 size - Sector shaped
* = Pre-rounding required, consult CEMBRE for appropriate die set

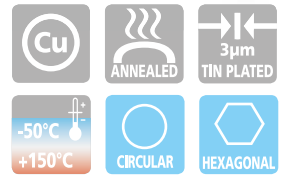

CA-2M and 2A-2M Copper Tube Terminal Lugs are designed for medium voltage applications up to 35 kV. Manufactured from Copper tube with a purity greater than 99.9%, annealed and Tin plated. The extended barrel enhances electrical and mechanical performance.

The absence of an inspection hole prevents moisture entry into the crimped joint. Featuring an extended palm with two fixing holes at 44.5 mm centres.

Details of the appropriate crimping tools and dies are shown on page 373.

MEDIUM VOLTAGE COPPER TERMINALS

2A-2M/55°

palm bent at 55° - two hole fixing

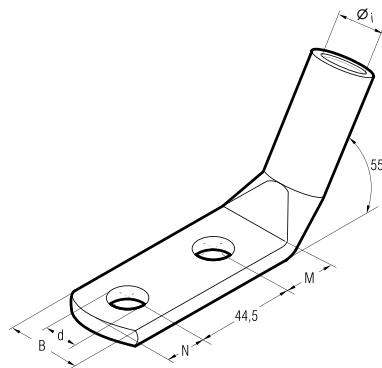

Conductor Size sqmm	Ø Stud mm	Type	Dimensions mm						Quantity Box/Bag	Hydraulic Tools
			Øi	B	M	N	d			
400 R	14	2A80-2M14/55	27,0	51,0	22	16	15	10/5	HT120 and tools and heads with 130 kN crimping force ECW-H3D RHU520	
600 R ÷ 630 R	14	2A120-2M14/55	33,4	61,5	22	16	15	15/3		

R = Round conductors



The 2A-2M/55° Copper Tube Terminal Lugs have the same characteristics as the CA-2M and 2A-2M ranges, with the additional feature of the palm bent at 55°.

Details of the appropriate crimping tools and dies are shown on page 373.

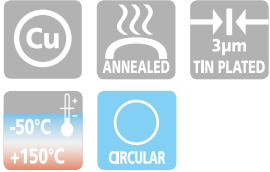
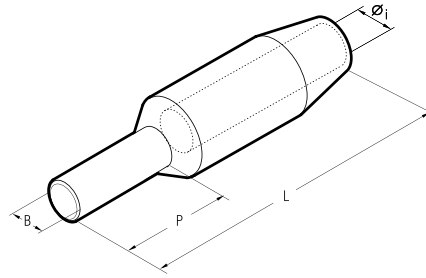

MT-C series connectors are designed for medium voltage applications up to 35 kV. They are manufactured from Copper with a purity greater than 99.9%, annealed and Tin plated. The extended barrel enhances both electrical and mechanical performance. The stalk or pin makes these connectors ideal for terminating conductors into contact blocks. Details of the appropriate crimping tools and dies are shown on page 373.

Conductor Size (sqmm) & Format	Type	Dimensions mm				Quantity Box/Bag	Hydraulic Tools																								
		Øi	B	P	L																										
25 R	MT25-C8	6,8	8,0	35,0	80,0	90/3	HT45-E	B450ND-BV																							
	MT40S-C8	8,2	8,0	35,0	80,0	90/3																									
30 RC/S ÷ 40 S	MT40S-C10	8,2	10,0	35,0	80,0	90/3						HT51	RH50	B500	B500ND	B550															
	MT40S-C14-80	8,2	14,0	80,0	123,0	30/3																									
35 BR/BS*	MT35-C8	8,2	8,0	35,0	80,0	90/3											HT81-UD	RHU81-D													
	MT35-C10	8,2	10,0	35,0	80,0	90/3																									
50 RC	MT35-C14-80	8,2	14,0	80,0	123,0	30/3																HT120									
	MT50R-C8	8,8	8,0	35,0	80,0	90/3																									
50 S	MT50R-C10	8,8	10,0	35,0	80,0	90/3																					HT120				
	MT50S-C8	9,5	8,0	35,0	80,0	90/3																									
50 BR/BS*	MT50S-C10	9,5	10,0	35,0	80,0	90/3	HT120																								
	MT50S-C14-80	9,5	14,0	80,0	123,0	30/3																									
63 S ÷ 70 S	MT50-C8	9,5	8,0	35,0	80,0	90/3						HT120																			
	MT50-C10	9,5	10,0	35,0	80,0	90/3																									
70 BR/BS*	MT50-C14-80	9,5	14,0	80,0	123,0	90/3											HT120														
	MT70S-C10	11,2	10,0	35,0	90,0	30/3																									
80 S ÷ 95 RC	MT70-C10	11,2	10,0	35,0	90,0	30/3																HT120									
	MT95R-C10	12,0	10,0	45,0	110,0	60/3																									
95 S ÷ 100 S	MT95R-C12	12,0	12,0	45,0	110,0	60/3																					HT120				
	MT95S-C10	13,5	10,0	45,0	110,0	60/3																									
95 BR/BS*	MT95S-C12	13,5	12,0	45,0	110,0	60/3	HT120																								
	MT95S-C14-80	13,5	14,0	80,0	145,0	60/3																									
120 RC/S ÷ 150 RC	MT95-C10	13,5	10,0	45,0	110,0	60/3						HT120																			
	MT95-C12	13,5	12,0	45,0	110,0	60/3																									
120 BR/BS*	MT95-C14-80	13,5	14,0	80,0	145,0	60/3											HT120														
	MT150R-C12	15,0	12,0	45,0	110,0	60/3																									
150 S ÷ 160 RC	MT150R-C16	15,0	16,0	45,0	110,0	30/3																HT120									
	MT120-C12	15,0	12,0	45,0	110,0	60/3																									
150 BR/BS*	MT120-C16	15,0	16,0	45,0	110,0	60/3																					HT120				
	MT150S-C12	16,5	12,0	45,0	110,0	60/3																									
160 S ÷ 200 RC	MT150S-C14-80	16,5	14,0	80,0	145,0	45/3	HT120																								
	MT150S-C16	16,5	16,0	45,0	110,0	30/3																									
185 BR/BS*	MT150-C10	16,5	10,0	45,0	110,0	60/3						HT120																			
	MT150-C12	16,5	12,0	45,0	110,0	60/3																									
200 S ÷ 240 RC	MT150-C14-80	16,5	14,0	80,0	145,0	45/3											HT120														
	MT150-C16	16,5	16,0	45,0	110,0	60/3																									
240 S ÷ 315 RC	MT200R-C10	17,0	10,0	45,0	110,0	30/3																HT120									
	MT200R-C16	17,0	16,0	45,0	110,0	30/3																									
240 BR/BS*	MT185-C10	18,0	10,0	45,0	110,0	30/3																					HT120				
	MT185-C16	18,0	16,0	45,0	110,0	30/3																									
300 BR/BS*	MT240R-C12	19,5	12,0	50,0	115,0	30/3	HT120																								
	MT240R-C16	19,5	16,0	50,0	115,0	30/3																									
315 S	MT315R-C16	21,5	16,0	50,0	115,0	30/3						HT120																			
	MT240-C12	20,5	12,0	45,0	110,0	30/3																									
315 S	MT240-C16	20,5	16,0	50,0	115,0	30/3											HT120														
	MT300-C16	23,0	16,0	50,0	115,0	30/3																									
315 S	MT315S-C16	24,0	16,0	60,0	130,0	30/3																HT120									

Conductor Format: R = Round, RC = Round Compact, S = Sector, BR = BS EN 60228 Round, BS* = BS EN 60228 size - Sector shaped
 * = Pre-rounding required, consult CEMBRE for appropriate die set

MEDIUM VOLTAGE COPPER THROUGH CONNECTORS

MT-TD MT-GC

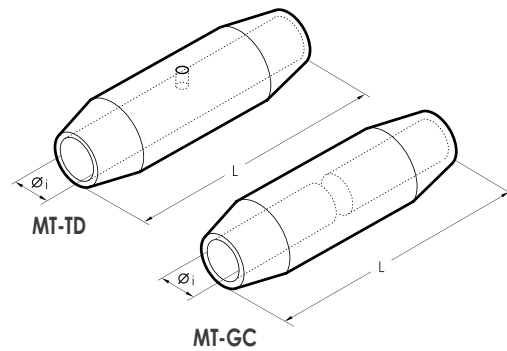

Conductor Size (sqmm) & Format	Type	Type	Dimensions mm		Quantity Box/Bag	Hydraulic Tools			
			øi	L		HT45-E	B450ND-BV	B500ND	B550
25 R/BR/BS*	MT25-TD	MT25-GC	6,8	60,0	90/3	HT45-E	B450ND-BV	B500ND	B550
30 RC/S ÷ 40 S	MT40S-TD	MT40S-GC	8,2	60,0	90/3				
30 BR/BS*	MT35-TD	MT35-GC	8,2	60,0	90/3				
50 RC	MT50R-TD	MT50R-GC	8,7	60,0	90/3				
50 S	MT50S-TD	MT50S-GC	9,5	60,0	90/3				
50 BR/BS*	MT50-TD	MT50-GC	9,5	60,0	90/3				
63 S ÷ 70 S	MT70S-TD	MT70S-GC	11,0	70,0	30/3				
70 BR/BS*	MT70-TD	MT70-GC	11,0	70,0	30/3				
80 S ÷ 95 RC	MT95R-TD	MT95R-GC	12,0	80,0	30/3				
95 S ÷ 100 S	MT95S-TD	MT95S-GC	13,5	80,0	30/3				
95 BR/BS*	MT95-TD	MT95-GC	13,5	80,0	30/3				
120 RC/S ÷ 150 RC	MT150R-TD	MT150R-GC	15,0	80,0	30/3	HT51	RH50	B500E	RHU81-D
120 BR/BS*	MT120-TD	MT120-GC	15,0	80,0	30/3				
150 S ÷ 160 RC	MT150S-TD	MT150S-GC	16,5	80,0	30/3				
150 BR/BS*	MT150-TD	MT150-GC	16,5	80,0	30/3				
160 S ÷ 200 RC	MT200R-TD	MT200R-GC	17,0	100,0	30/3				
185 BR/BS*	MT185-TD	MT185-GC	18,0	100,0	30/3				
200 S ÷ 240 RC	MT240R-TD	MT240R-GC	19,2	100,0	21/3				
240 S ÷ 315 RC	MT315R-TD	MT315R-GC	21,5	100,0	21/3				
240 BR/BS*	MT240-TD	MT240-GC	20,5	100,0	30/3				
300 BR/BS*	MT300-TD	MT300-GC	23,0	100,0	30/3				
315 S	MT315S-TD	MT315S-GC	23,7	100,0	21/3				
400 BR/BS*	MT400-TD	MT400-GC	27,0	120,0	15/3				
500 R	MT500-TD		30,3	118,0	12/3				
600 R ÷ 630 R	MT630-TD		33,4	130,0	9/3				

Conductor Format: R = Round, RC = Round Compact, S = Sector, BR = BS EN 60228 Round, BS* = BS EN 60228 size - Sector shaped
* = Pre-rounding required, consult CEMBRE for appropriate die set



MT-TD and MT-GC series connectors are designed to join conductors in medium voltage applications up to 35 kV.

They are manufactured from Copper with a purity greater than 99.9%, annealed and Tin plated.

MT-GC series feature a solid stop which forms a barrier between the two conductors being joined, this prevents the migration of oils or greases, which may be present, in one cable contaminating the other cable.

MT-TD connectors are unblocked and are suitable for joining cables of the same type.

Details of the appropriate crimping tools and dies are shown on page 373.

AA-M

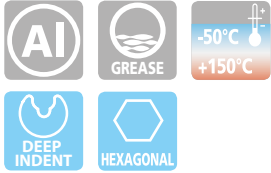

AA-M series terminals are made from Aluminium of a purity equal to or greater than 99,5%. They are designed to accept a variety of conductor forms especially low stranded compacted conductors. Non circular conductors may require pre-rounding prior to introduction to the terminal. Barrels are capped and filled with grease so as to avoid oxidation of the Aluminium. Details of the appropriate crimping tools and dies are shown on page 373-376.

ALUMINIUM TERMINALS

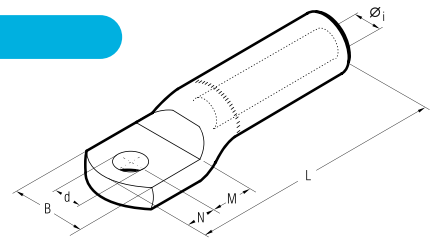

Conductor Size sqmm	Ø Stud mm	Type	Dimensions mm						Quantity Box/Bag	Hydraulic Tools
			Øi	B	M	N	L	d		
16	8	AA16-M8	5,5	21	13	11	77,0	8,4	60/3	HT131-UC RHU131-C B1300-UC
25	8	AA25-M8	6,5	21	13	11	77,0	8,4	60/3	
35	8	AA35-M8	8,0	23	13	11	77,5	8,4	60/3	
	10	AA35-M10	8,0	23	13	11	77,5	10,5	60/3	
50	12	AA50-M12	9,0	26	16	14	91,0	13,2	60/3	
	14	AA50-M14	9,0	26	18	16	95,0	15,0	60/3	
70	12	AA70-M12	11,0	27	16	14	91,0	13,2	45/3	
	14	AA70-M14	11,0	27	18	16	95,0	15,0	45/3	
95	12	AA95-M12	12,5	27	16	14	91,0	13,2	30/3	
	14	AA95-M14	12,5	27	18	16	95,0	15,0	45/3	
120	12	AA120-M12	13,7	35	16	14	115,0	13,2	21/3	
	14	AA120-M14	13,7	35	18	16	119,0	15,0	30/3	
150	12	AA150-M12	15,5	34	16	14	115,0	13,2	45/3	
	14	AA150-M14	15,5	34	18	16	119,0	15,0	30/3	
185	12	AA185-M12	17,0	42	20	14	122,0	13,2	15/3	
	14	AA185-M14	17,0	42	22	16	126,0	15,0	18/3	
240	12	AA240-M12	19,5	44	20	14	122,0	13,2	15/3	
	14	AA240-M14	19,5	44	22	16	126,0	15,0	15/3	
300	12	AA300-34M12	22,5	47	22	14	130,0	13,2	15/3	
	14	AA300-34M14	22,5	47	22	16	132,0	15,0	15/3	
	16	AA300-34M16	22,5	47	22	17	133,0	17,0	15/3	
400	16	AA400-M16	26,0	56	19	17	172,0	17,0	15/3	
	16	AA500-40M16	29,1	57	22	19	177,0	17,0	12/3	
630	16	AA630-M16	32,5	70	22	19	177,0	17,0	9/3	

AAC150-M10

for bimetallic connections in medium/low voltage cabins

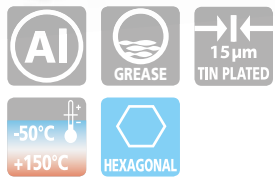

Tin plated aluminum cable lug with single hole for M10 screw, with limited connection, for aluminum cables section 150 mm².

- Characterized by:
- spacer marking for correct compression
 - CEI EN 61238-1 self-certification according to ENEL indications

- presence of grease inside the barrel and closing cap
- Surface electrolytic tin plated with a minimum thickness of 15µm, which helps to increase resistance to chemical agents.

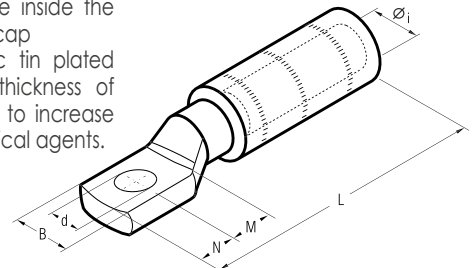

Conductor Size sqmm	Ø Stud mm	Type	Dimensions mm						Quantity Box/Bag	Hydraulic Tools
			Øi	B	M	N	L	d		
150	10	AAC150-M10	15,5	19	16	15	99	10,5	28/4	HT51 RH50 B500 B500ND

AA150S-2M12/29ST

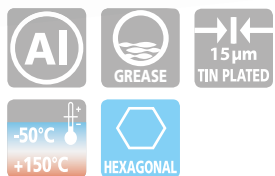

Tin plated aluminum cable lug with double hole for M12 screws, center distance 44.5 mm, for aluminum cables section. 150 mm².

- Characterized by:
- spacer marking for correct compression

- CEI EN 61238-1 self-certification according to ENEL indications
- presence of grease inside the barrel and closing cap
- Surface electrolytic tin plated with a minimum thickness of 15µm, which helps to increase resistance to chemical agents.

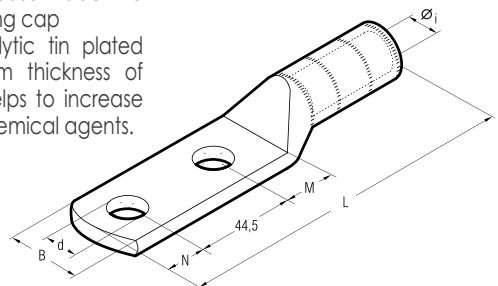

Conductor Size sqmm	Ø Stud mm	Type	Dimensions mm						Quantity Box/Bag	Hydraulic Tools
			Øi	B	M	N	L	d		
150	12	AA150S-2M12/29ST	15,5	29	16	14	144,5	13,2	24/4	HT51 RH50 B500 B500ND

THROUGH CONNECTORS

for Aluminium conductors

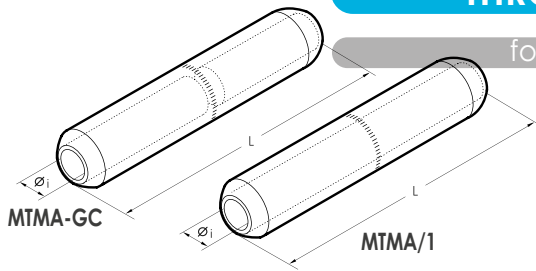

MTMA-GC MTMA/1



Conductor Size sqmm	Type	Type	Dimensions mm		Quantity Box/Bag	Hydraulic Tools			
			øi	L					
10	MTMA10-GC		4,3	90,5	60/3	B1300-JC			
16	MTMA16-GC	MTMA16/1	5,5	90,5	60/3				
25	MTMA25-GC	MTMA25/1	6,5	90,5	60/3				
35	MTMA35-GC	MTMA35/1	8,0	90,5	60/3				
	MTMA35-20-GC		8,0	106,5	30/3				
50	MTMA50-GC	MTMA50/1	9,0	106,5	30/3				
70	MTMA70-GC	MTMA70/1	11,0	106,5	30/3				
95	MTMA95-GC		12,5	110,0	30/3				
		MTMA95/1	12,5	106,5	30/3				
120	MTMA120-GC	MTMA120/1	13,7	133,0	21/3			HT131-JC	
150	MTMA150-GC		15,5	135,0	21/3				
		MTMA150/1	15,5	133,5	21/3				
185	MTMA185-GC	MTMA185/1	17,0	143,5	15/3				
240	MTMA240-GC	MTMA240/1	19,5	143,5	15/3				
300	MTMAD300-GC		22,5	144,5	12/3				
		MTMAD300/1	22,5	135,0	15/3				
	MTMA300-GC		23,3	218,0	15/3				
400		MTMA400/1	26,0	218,0	15/3	ECW-H3D	RHU230-630		
500	MTMA500-GC		29,1	218,5	12/3				
630		MTMA500-40/1	29,1	218,0	15/3				
		MTMA630/1	32,5	218,5	12/3				

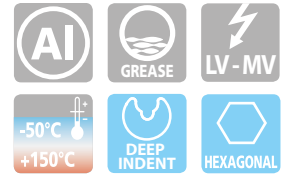

MTMA-GC series through connectors are made from Aluminium of a purity equal to or greater than 99,5%.

They feature a solid stop which creates a barrier between the two sides of conductors to be joined. Barrels are capped and filled with grease so as to avoid oxidation of the connector. MTMA/1 series through connectors are unblocked and are suitable for joining cables of the same type.

Details of the appropriate crimping tools and dies are shown on pages 373-376.

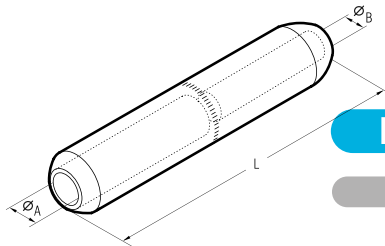

REDUCER THROUGH CONNECTORS

for Aluminium or Copper conductors

MTMA-GC



Conductor Size sqmm		Type	Dimensions mm			Quantity Box/Bag	Hydraulic Tools	
Side A Al	Side B Al/Cu		øA	øB	L			
16	10	MTMA16-10-GC	5,5	4,3	90,5	60/3	B1300-JC	
		MTMA25-10-GC	6,5	4,3	90,5	60/3		
25	16	MTMA25-16-GC	6,5	5,5	90,5	60/3		
		MTMA50-25-GC	9,0	6,5	106,5	30/3		
50	35	MTMA50-35-GC	9,0	8,0	106,5	30/3		
		MTMA70-35-GC	11,0	8,0	106,5	30/3		
70	50	MTMA70-50-GC	11,0	9,0	106,5	30/3		
		MTMA95-50-GC	12,5	9,0	109,4	30/3		
95	70	MTMA95-70-GC	12,5	11,0	106,5	30/3		
		MTMA120-70-GC	13,7	11,0	133,0	21/3		
120	95	MTMA120-95-GC	13,7	12,5	133,0	30/3		
		MTMA150-70-GC	15,5	11,0	133,0	24/3		
150	95	MTMA150-95-GC	15,5	12,5	134,4	21/3		
		MTMA150-120-GC	15,5	13,7	133,0	21/3		
185	120	MTMA185-120-GC	17,0	13,7	143,5	15/3		
		MTMA185-150-GC	17,0	15,5	143,5	15/3		
240	150	MTMA240-150-GC	19,5	15,5	143,5	15/3		
		MTMA240-185-GC	19,5	17,0	143,5	15/3		
300	95	MTMAD300-95-GC	22,5	12,5	144,5	15/3		
		MTMAD300-150-GC	22,5	15,5	144,5	15/3		
		MTMAD300-185-GC	22,5	17,0	144,5	15/3		
		MTMAD300-240-GC	22,5	19,5	144,5	12/3		
400	240	MTMA400-240-GC	26,0	19,5	218,0	15/3	ECW-H3D	RHU230-630
		MTMA400-300-GC	26,0	23,3	218,0	15/3		
500	300	MTMA500-300-GC	29,1	23,3	218,5	12/3		
		MTMA500-400-GC	29,1	26,0	218,5	12/3		



MTMA-GC series reducer through connectors are manufactured to the same specification as MTMA-GC series through connectors. Details of the appropriate crimping tools and dies are shown on pages 373-376.

for non-tension connections on Aluminium conductors according to DIN EN 50182

Tube dimensions according to DIN 46329

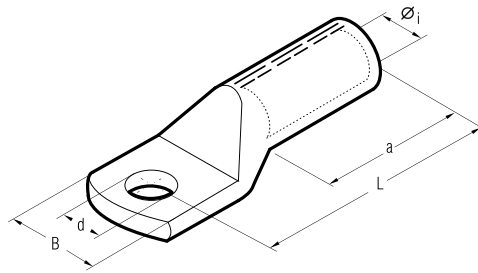

Terminals type AAD.-M.. are made from Aluminium tube of a purity equal or greater than 99,5%. They are suitable for Aluminium conductors according to DIN EN 50182, up to 10 kV.

All terminals are filled with a special grease that avoids Aluminium oxidation after crimping thereby assuring an optimal compression. Barrel is closed with a cap for storage and transport.

Bright surface finish
The following data is stamped on the terminal:

- CEMBRE logo
- Terminal description
- Section
- Fixing bolt size
- Number and position of crimps
- CEMBRE Die reference according to DIN 48083

Details of the appropriate crimping tools and dies are shown on page 381.

Conductor Size	Ø Stud	Ref.	Code	Dimensions mm					Quantity Bag	Hydraulic Tools
				Øi	B	L	d	a		
16 25	8	AAD16-M8	12	5,8	18	52	8,5	32	50	HT 45-E B450ND-BV HT 51 RH50 B500ND RH60C HT60C B600CND HT 81-UD RHU81-D HT 120 and tools and heads with 130 kN crimping force ECW-H3D RHU 450 RHU 520
	10	AAD16-M10	12	5,8	18	52	10,5	32	50	
25 35	8	AAD25-M8	12	6,8	19	60	8,5	37	50	
	10	AAD25-M10	12	6,8	19	60	10,5	37	50	
35 50	8	AAD35-M8	14	8,0	21	67	8,5	42	35	
	10	AAD35-M10	14	8,0	21	67	10,5	42	35	
	12	AAD35-M12	14	8,0	21	67	13,0	42	35	
50 70	8	AAD50-M8	16	9,8	25	72	8,5	42	30	
	10	AAD50-M10	16	9,8	25	72	10,5	42	30	
	12	AAD50-M12	16	9,8	25	72	13,0	42	30	
70 95	10	AAD70-M10	18	11,2	28	83	10,5	52	15	
	12	AAD70-M12	18	11,2	28	83	13,0	52	15	
	16	AAD70-M16	18	11,2	28	83	17,0	52	15	
	10	AAD95-M10	22	13,2	32	90	10,5	55	10	
95 120	12	AAD95-M12	22	13,2	32	90	13,0	55	10	
	16	AAD95-M16	22	13,2	34	90	17,0	55	10	
	10	AAD120-M10	22	14,7	32	91	10,5	55	10	
120 150	12	AAD120-M12	22	14,7	32	91	13,0	55	10	
	16	AAD120-M16	22	14,7	34	91	17,0	55	10	
	10	AAD150-M10	25	16,5	35	104	10,5	60	8	
150 185	12	AAD150-M12	25	16,5	35	104	13,0	60	8	
	16	AAD150-M16	25	16,5	35	104	17,0	60	8	
	20	AAD150-M20	25	16,5	41	104	21,0	60	8	
	12	AAD185-M12	28	18,3	40	105	13,0	60	15	
185 240	16	AAD185-M16	28	18,3	40	105	17,0	60	15	
	20	AAD185-M20	28	18,3	40	105	21,0	60	15	
	12	AAD240-M12	32	21,0	45	119	13,0	70	12	
240 300	16	AAD240-M16	32	21,0	45	119	17,0	70	12	
	20	AAD240-M20	32	21,0	45	119	21,0	70	12	
	12	AAD300-M12	34	23,3	49	125	13,0	70	9	
300	16	AAD300-M16	34	23,3	49	125	17,0	70	9	
	20	AAD300-M20	34	23,3	49	125	21,0	70	9	
	12	AAD400-M12	38	26,0	58	140	13,0	100	3	
400	16	AAD400-M16	38	26,0	58	140	17,0	100	3	
	20	AAD400-M20	38	26,0	58	140	21,0	100	3	
	12	AAD500-M12	44	29,0	63	160	13,0	100	3	
500	16	AAD500-M16	44	29,0	63	160	17,0	100	3	
	20	AAD500-M20	44	29,0	63	160	21,0	100	3	

rm = round stranded
sm = sector stranded
re = round solid
se = sector solid

ALUMINIUM THROUGH CONNECTORS

DSVA

for non-tension connections on Aluminium conductors according to DIN EN 50182

Manufactured according to DIN 46267 Part 2

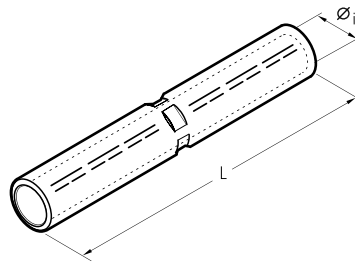

Conductor Size sqmm		Code	Ref.	Dimensions mm		Quantity Bag	Hydraulic Tools													
rm sm	re se			øi	L		HT45-E	B450ND-BV	HT51	RH50	B500	B500ND	RH60C	HT60C	B600C	B600CND	HT81-UD	RHU81-D	ECW-H3D	RHU 450
16	25	12	DSVA16	5.8	55	30														
25	35	12	DSVA25	6.8	70	25														
35	50	14	DSVA35	8.0	85	25														
50	70	16	DSVA50	9.8	85	20														
70	95	18	DSVA70	11.2	105	20														
95	120	22	DSVA95	13.2	105	15														
120	150	22	DSVA120	14.7	105	15														
150	185	25	DSVA150	16.5	125	10														
185	240	28	DSVA185	18.3	125	10														
240	300	32	DSVA240	21.0	145	5														
300		34	DSVA300	23.3	145	10														
400		38	DSVA400	26.0	210	3														
		42	DSVA401	28.0	210	3														
500		44	DSVA500	29.0	210	3														
		46	DSVA501	31.0	210	3														
600		52	DSVA625	35.0	330	4														
800		58	DSVA800	40.0	350	3														
1000		60	DSVA1000	44.0	350	3														

rm = round stranded
sm = sector stranded
re = round solid
se = sector solid



Crimping through connectors type DSV.. are manufactured according to DIN 46267 part 2.

The aluminum tube has a purity equal to or greater than 99.5%.

The crimping through connectors are suitable for aluminum conductors according to DIN EN 50182, up to 10 kV.

All connectors are filled with a special grease that avoids aluminum oxidation after crimp and thus guarantees an optimal compression.

Barrels are capped for storage and transport.

On the connector following information is shown:

- CEMBRE logo
- Connector description
- Section
- Number and position of crimps
- Compression code according to DIN 48083

Details of the appropriate crimping tools and dies are shown on page 381.

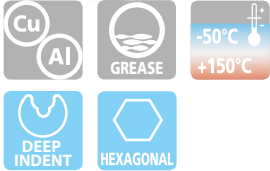
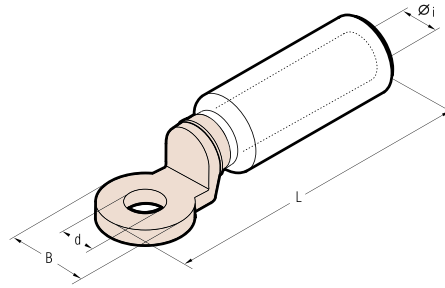

The barrels of series CAA-M connectors are made from Aluminium of a purity equal to or greater than 99,5%.

The barrel is friction welded to the palm thus achieving the best possible transition between the Copper palm and Aluminium barrel.

Barrels are capped and filled with grease so as to avoid oxidation of the Aluminium.

Details of the appropriate crimping tools and dies are shown on pages 373, 376.

Conductor Size sqmm	Ø Stud mm	Type	Dimensions mm				Quantity Box/Bag	Hydraulic Tools	
			Øi	B	L	d			
10	12	CAA10-M12	4,3	24,0	87,0	13,0	60/3	B1300-UC	
16	12	CAA16-M12	5,5	24,0	87,0	13,0	60/3		
25	12	CAA25-M12	6,5	24,0	87,0	13,0	60/3		
35	12	CAA35-M12	8,0	24,0	87,0	13,0	45/3		
	12	CAA35-20-M12	8,0	24,0	87,0	13,0	60/3		
50	12	CAA50-M12	9,0	24,0	87,0	13,0	30/3		
70	12	CAA70-M12	11,0	24,0	87,0	13,0	60/3		
95	10	CAA95-M10	12,5	24,0	87,0	10,5	30/3		
	12	CAA95-M12	12,5	24,0	87,0	13,0	30/3		
120	12	CAA120-M12	13,7	31,0	111,0	13,0	24/3		
150	12	CAA150-M12	15,5	31,0	111,0	13,0	24/3		
185	12	CAA185-M12	17,0	35,0	116,0	13,0	18/3		
240	12	CAA240-M12	19,5	35,0	116,0	13,0	18/3		
	12	CAA300-34-M12	22,5	35,0	120,0	13,0	15/3		
300	14	CAA300-34-M14	22,5	35,0	120,0	15,0	15/3		
	16	CAA300-34-M16	22,5	35,0	120,0	17,0	15/3		
400	16	CAA300-M16	23,3	35,0	152,5	16,5	9/3		
	12	CAA400-M12	26,0	35,0	152,5	13,0	9/3		
500	16	CAA400-M16	26,0	35,0	152,5	16,5	9/3		
	16	CAA500-M16-TNBD	29,1	35,0	152,5	16,5	9/3		
630	8	CAA630-4M8	32,5	60,0	200,0	4 x 9,0*	9/3		

* 4 holes with 30 mm between axes

BIMETALIC CONNECTORS WITH A SHORT BARREL

Copper palm fixing - Aluminium barrels

CBMC-N

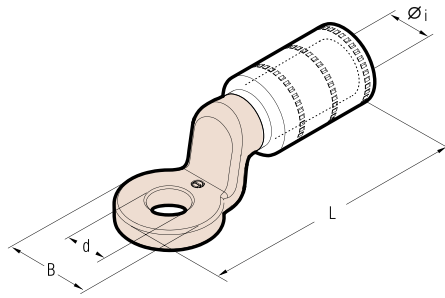

Conductor Size sqmm	Ø Stud mm	Type	Dimensions mm				Quantity Box/Bag	Hydraulic Tools							
			Øi	B	L	d									
35	8	CBMC35-M8N	8,0	17	61	8,5	120/3	HT45-E B450ND-BV	HT51	RH50	B500	RHU81-D	HT 120 and tools and heads with 130 kN crimping force	ECW-H3D	RHU230-630
50	8	CBMC50-M8N	9,0	17	61	8,5	120/3								
70	10	CBMC70-M10N	10,8	21	65	10,5	60/3								
95	10	CBMC95-M10N	12,3	21	65	10,5	60/3								
120	10	CBMC120-M10N	13,3	25	71	10,5	60/3								
	12	CBMC120-M12N	13,3	25	71	12,5	60/3								
150	10	CBMC150-M10N	15,3	25	74	10,5	60/3								
	12	CBMC150-M12N	15,3	29	78	12,5	30/3								
185	10	CBMC185-M10N	16,8	25	74	10,5	30/3								
	12	CBMC185-M12N	16,8	29	78	12,5	30/3								
240	10	CBMC240-M10N	19,3	25	78	10,5	30/3								
	12	CBMC240-M12N	19,3	29	82	12,5	30/3								
300	10	CBMC300-M10N	22,0	28	85	10,5	30/3								
	12	CBMC300-M12N	22,0	28	85	12,5	30/3								
	14	CBMC300-M14N	22,0	34	91	14,5	30/3								

The small size of the CBMC-N series cable lugs facilitates connections in cubicles, circuit breakers and motor terminal boxes. These terminals are designed exclusively for industrial networks and can be compressed with a hexagonal die. **These terminals are tested according to NFC 63-061 class B and IEC 61238-1-3 standards.** Details of the appropriate crimping tools and dies are shown on page 377.

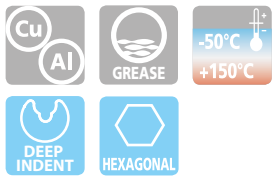
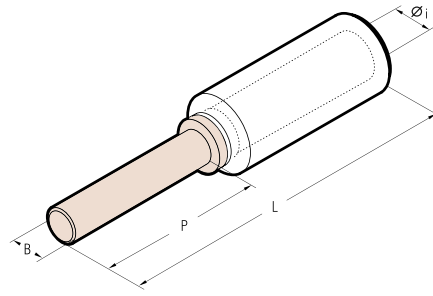

The barrels of series MTA-C connectors are made from Aluminium of a purity equal to or greater than 99,5%.

The barrel is friction welded to the pin thus achieving the best possible transition between the Copper pin and Aluminium barrel.

Barrels are capped and filled with grease so as to avoid oxidation of the Aluminium.

Details of the appropriate crimping tools and dies are shown on pages 373, 376.

Conductor Size sqmm	Type	Dimensions mm				Quantity Box/Bag	Hydraulic Tools
		Øi	B	P	L		
16	MTA16-C	5,5	8	30	82	90/3	HT131-UC RHU131-C B1300-UC
25	MTA25-C	6,5	8	30	82	90/3	
35	MTA35-C	8,0	8	30	82	90/3	
50	MTA50-C	9,0	12	45	97	60/3	
70	MTA70-C	11,0	12	45	97	60/3	
95	MTA95-C	12,5	12	45	97	30/3	
120	MTA120-C	13,7	14	55	125	30/3	
150	MTA150-C	15,5	14	55	125	30/3	
185	MTA185-C	17,0	14	55	125	24/3	
240	MTA240-C	19,5	14	55	125	24/3	

MECHANICAL LUGS

MLA-NC

For Low and Medium voltage Al/Cu conductors

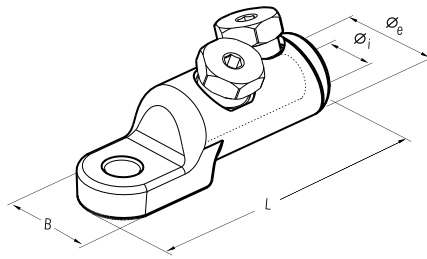

Conductor Size sqmm	Type	Ø Stud mm	Dimensions mm				N° of Bolts	Number of centring devices	Quantity Box/Bag
			Øe	Øi	B	L			
50-240	MLA50-240-12NC	12	33	20,5	33	106,5*	2	3 ● ● ●	1/10

* without centring devices



CEMBRE range-taking mechanical connectors are intended for use with Copper and Aluminium conductors, for low and medium voltage (up to 52kV) installations, in indoor, outdoor and underground applications.

Mechanical connector bodies (pic.1) are made from Aluminium EN-AW 2011 T6 with cross sectional area and barrel length designed

to optimise electrical connectivity. Internal surfaces are protected against oxidation by grease with a very high dropping point, while the Tin plating on external surfaces has a minimum thickness of 12 µm for improved surface protection.

Shear bolts (pic.2) are made from the same material and designed to ensure a reliable electrical con-

nection simply by tightening the bolts with a standard socket until shearing occurs inside the threaded hole without external protrusion. To minimise voltage stresses, connectors are provided with centring devices (pic.3) to improve the alignment of the different conductor sizes.

Key features:

- Wide range of conductor cross sections
- Suitable for Copper and Aluminium conductors
- Tested according to IEC 61238
- Torque controlled to guarantee a good electrical contact
- Reduces inventory levels
- Easy installation - only requires a standard socket
- Reduced installation time

Pic. 1



Conductor Size sqmm	Centring device	
	Color	Type
50 - 70 - 95	Red	
120 - 150	Blue	
185	Yellow	
240	Not required	

Pic. 3

ML-C

MECHANICAL LUGS WITH SYMMETRICAL PALM

For Medium voltage Al/Cu conductors

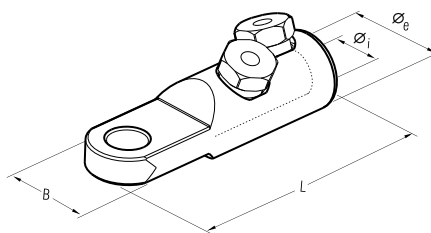

Conductor Size sqmm	Type	Ø Stud mm	Dimensions mm				N° of Bolts	Number of centring devices	Quantity Box/Bag
			Øe	Øi	B	L			
95-240	ML95-240-16C	16	35	20,5	35	124*	2	3 ● ● ●	1/10
150-240	ML150-240-16C	16	35	20,5	35	124*	2	2 ● ●	1/10

* without centring devices

MBS-NC

MECHANICAL SPLICES

For Low and Medium voltage Al/Cu conductors

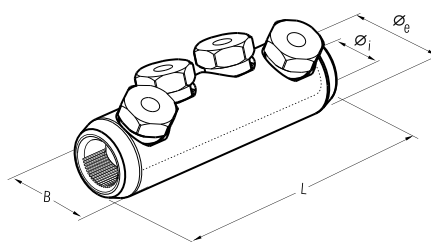

Conductor Size sqmm	Type	Dimensions mm				N° of Bolts	Number of centring devices	Quantity Box/Bag
		Øe	Øi	B	L			
50-240	MBS50-240NC	35	20,5	35	124*	4	3 ● ● ●	1/20

* without centring devices

TERMINAL BLOCKS, FLEXIBLE BUSBAR, BRAIDS AND DISTRIBUTION BLOCKS



symbol description

terminal blocks



Polycarbonate body



Zinc plated Steel screws



Polyamide PA6.6 body



Chrome plated Steel screws



Polypropylene body



Brass clamp



Steatite body



Operating temperature range



Polyvinylchloride insulating sheath



Italian Institute of the Quality Mark type approval



Electrolytically Tin plated Copper interconnections



Lloyd's Register Marine type approval



Electrolytically Tin plated to avoid oxidation



Italian Naval Register type approval



Nominal voltage V



USR-CNR type approval valid for USA and CANADA



Degree of Protection IP20



CE marking



Self-extinguishing class V0 UL94



UKCA marking

example applications

terminal blocks

type
ZETApiù®

Z35T-11 uninterrupted,
main earth loop, terminal block.
Used for equipotential bonding



UNINTERRUPTED
MAIN EARTH
LOOP



Z6-10D terminal blocks
used in a control panel.

SUITABLE
FOR DIN RAIL
MOUNTING



Z16-8D and Z6-6D
mounted on DIN rails.
Used in control panels

type
ZETAmini®

ZETAmini terminal blocks
used for domestic/commercial
applications.



type
ZETAblock®

A typical application of the
Z50-DP12-160 and Z35-DP14B-125
installed in a distribution panel



Z6

SINGLE POLE TERMINAL BLOCKS

indirect clamping - nominal section 6 sqmm



type
ZETApiù®

The "Z...D" version has been designed for mounting on DIN rails



3, 5, 6 and 10 way, single pole terminal blocks for conductor section 1 to 6 sqmm.

Self contained and robust, they are quick and easy to install for both industrial and domestic use. The indirect clamping of the "ZETApiù" terminal blocks guarantees a low and stable contact resistance.

Indirect clamping eliminates damage to the conductor strands. The easy-entry receptacles also grant a fast and reliable insertion of the cable.

Connecting Capacity sqmm	Type	No. of Ways	Nominal Voltage V	Maximum Operating Temperature °C	Insulation Specification	Self Extinguishing Specification	Dimensions mm	Weight g	Quantity
(3 way) 1÷6	Z6-3	3	450	85	IP20	V-0 (UL 94)	23x23xh27,5	15,0	30
	Z6-3D						23x40xh36,5	18,5	10
(5 way) 1÷6	Z6-5	5	450	85	IP20	V-0 (UL 94)	35x23xh27,5	23,0	20
	Z6-5D						35x40xh36,5	26,5	10
(6 way) 1÷6	Z6-6	6	450	85	IP20	V-0 (UL 94)	23x43xh28,5	26,0	15
	Z6-6D						23x53xh33	31,0	10
(10 way) 1÷6	Z6-10	10	450	85	IP20	V-0 (UL 94)	35x43xh28,5	41,0	10
	Z6-10D						35x53xh33	46,0	15

D= Version with clamp for DIN rail

Technical features:

- Self-extinguishing Polycarbonate body
- Tempered Steel clamps
- Electrolytically Tin plated Copper interconnections

Z16

SINGLE POLE TERMINAL BLOCKS

indirect clamping - nominal section 16 sqmm



type
ZETApiù®



3, 4, 5, 8 and 12 way, single pole terminal blocks.

Ideal for use as an equipotential bonding connector for both industrial and domestic use.

Connecting Capacity sqmm	Type	No. of Ways	Nominal Voltage V	Maximum Operating Temperature °C	Insulation Specification	Self Extinguishing Specification	Dimensions mm	Weight g	Quantity
16	Z16-3	3	450	85	IP20	V-0 (UL 94)	38x31,3xh38	52,0	20
	Z16-3D						38x50xh44	55,5	15
16	Z16-4	4	450	85	IP20	V-0 (UL 94)	27x54xh37	50,0	15
	Z16-4D						27x58xh43	54,0	10
16	Z16-5N	5	450	85	IP20	V-0 (UL 94)	61x31,5xh38	64,5	10
	Z16-5ND						61x50xh44	68,0	4
(2 way) 16 + (6 way) 6	Z16-8	8 (2÷6)	450	85	IP20	V-0 (UL 94)	35,5x50xh36,5	50,0	15
	Z16-8D						35,5x57xh42	56,0	10
(2 way) 16 + (10 way) 6	Z16-12	12 (2÷10)	450	85	IP20	V-0 (UL 94)	104,5x32,5xh36,5	115,0	8
	Z16-12D						104,5x50xh42	125,0	5

D= Version with clamp for DIN rail

SINGLE POLE TERMINAL BLOCKS

indirect clamping - nominal section 35 sqmm

type
ZETApiù®

Z35-3



Z35-4



Z35-6



Connecting Capacity sqmm	Type	No. of Ways	Nominal Voltage V	Maximum Operating Temperature °C	Insulation Specification	Self Extinguishing Specification	Dimensions mm	Weight g	Quantity
35	Z35-3	3	450	85	IP20	V-0 (UL 94)	53x48,5xh42	110	10
	Z35-3D						53x50xh48	114	5
35	Z35-4	4	450	85	IP20	V-0 (UL 94)	37x85xh42	129	5
	Z35-4D						37x85xh48	133	5
(2 way) 35 + (4 way) 16	Z35-6	6 (2÷4)	450	85	IP20	V-0 (UL 94)	83x41xh43	130	8
	Z35-6D						83x49xh52	140	5

D= Version with clamp for DIN rail



3, 4 and 6 way, single pole terminal blocks. Ideal for use as an equipotential bonding connector for both industrial and domestic use.

SINGLE POLE TERMINAL BLOCKS

indirect clamping - for earthing applications ⚡

type
ZETApiù®

Z50-10D



Z35T-11
Z35T-11D



Z35-26D



Connecting Capacity sqmm	Type	No. of Ways	Maximum Operating Temperature °C	Self Extinguishing Specification	Dimensions mm	Weight g	Quantity
(1 way) 35 + (10 way) 6	Z35T-11	11	85	V-0 (UL 94)	58x43xh42	70	10
	Z35T-11D	(1+10)			58x53xh47	75	10
(2 way) 35 + (24 way) 10	Z35-26D	26 (2+24)	85	V-0 (UL 94)	151x52xh48	379	4
(2 way) 50 + (8 way) 25	Z50-10D	10 (2+8)	85	V-0 (UL 94)	77,5x55xh49	320	6

D= Version with clamp for DIN rail

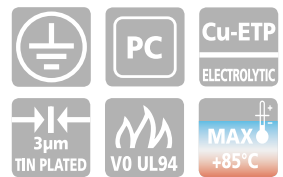































10, 11 and 26 way, single pole terminal blocks. Ideal for use as an equipotential bonding connector for both industrial and domestic use.

CONNECTING CAPACITY OF TERMINAL BLOCKS

indirect clamping

type
ZETApiù®

Type	Nominal Section	No. of Ways x Nominal Section	Connecting Capacity of Each Way* No. of Conductors x Section	Markings
Z6-3 Z6-3D	6□	3 x 6□		   6 mm ² 450 V T 85°C  
Z6-5 Z6-5D	6□	5 x 6□	1 x 6□ R/F 1 x 4□ R/F	
Z6-6 Z6-6D	6□	6 x 6□	1÷2 x 2,5□ R/F 1÷2 x 1,5□ R/F 1÷4 x 1□ R/F	   6 mm ² 450 V T 85°C 
Z6-10 Z6-10D	6□	10 x 6□		
Z16-3 Z16-3D	16□	3 x 16□	1 x 16□ R/F 1 x 10□ R/F 1÷2 x 6□ R/F 1÷3 x 4□ R/F 1÷4 x 2,5□ R/F 1÷8 x 1,5□ R/F	   16 mm ² 450 V T 85°C  
Z16-4 Z16-4D	16□	4 x 16□	1 x 16□ F 1 x 10□ F 1÷2 x 6□ F 1÷3 x 4□ F 1÷4 x 2,5□ F 1÷8 x 1,5□ F	   16 mm ² 450 V T 85°C 
Z16-5N Z16-5ND	16□	5 x 16□	1 x 16□ R/F 1 x 10□ R/F 1÷2 x 6□ R/F 1÷3 x 4□ R/F 1÷4 x 2,5□ R/F 1÷8 x 1,5□ R/F	   16 mm ² 450 V T 85°C 
Z16-8 Z16-8D	16□ / 6□	2 x 16□	1 x 16□ R/F 1 x 10□ R/F 1÷2 x 6□ R/F 1÷3 x 4□ R/F 1÷4 x 2,5□ R/F 1÷8 x 1,5□ R/F	   16-6 mm ² 450 V T 85°C 
		6 x 6□	1 x 6□ R/F 1 x 4□ R/F 1÷2 x 2,5□ R/F 1÷2 x 1,5□ R/F 1÷4 x 1□ R/F	
Z16-12	16□ / 6□	2 x 16□	1 x 16□ F 1 x 10□ F 1÷2 x 6□ F 1÷3 x 4□ F 1÷4 x 2,5□ F	   16-6 mm ² 450 V T 85°C 
Z16-12D		10 x 6□	1 x 6□ F 1 x 4□ F 1÷2 x 2,5□ F 1÷2 x 1,5□ F 1÷4 x 1□ F	

* A mixture of conductor sizes may be connected to the terminal block provided that the sum of their sections is less than the nominal section.
R = Rigid conductor F = Flexible conductor

CONNECTING CAPACITY OF TERMINAL BLOCKS

indirect clamping

type
ZETApìù®

Type	Nominal Section	No. of Ways x Nominal Section	Connecting Capacity of Each Way* No. of Conductors x Section	Markings
Z35-3 Z35-3D	35□	3 x 35□	1 x 35□ R/F 1 x 25□ R/F 1÷2 x 16□ R/F 1÷3 x 10□ R/F 1÷5 x 6□ R/F	CE UK CA 35 mm² 450 V T 85°C
Z35-4 Z35-4D	35□	4 x 35□	1 x 35□ F 1 x 25□ F 1÷2 x 16□ F 1÷3 x 10□ F 1÷6 x 6□ F	CE UK CA 35 mm² 450 V T 85°C
Z35-6 Z35-6D	35□ / 16□	2 x 35□	1 x 35□ R/F 1 x 25□ R/F 1÷2 x 16□ R/F 1÷3 x 10□ R/F 1÷6 x 6□ F	CE UK CA 35~16 mm² 450 V T 85°C
		4 x 16□	1 x 16□ R/F 1 x 10□ R/F 1÷2 x 6□ R/F 1÷3 x 4□ R/F 1÷5 x 2,5□ F	
Z35T-11 Z35T-11D	35□ / 6□	1 x 35□	1 x 35□ R/F 1 x 25□ R/F 1 x 16□ R/F 1 x 10□ R/F	CE UK CA 35~6 mm² T 85°C
		10 x 6□	1 x 6□ R/F 1 x 4□ R/F 1÷2 x 2,5□ R/F 1÷2 x 1,5□ R/F 1÷4 x 1□ R/F	
Z35-26D	35□ / 10□	2 x 35□	1 x 35□ R/F 1 x 25□ R/F 1÷2 x 16□ R/F 1÷3 x 10□ R/F 1÷6 x 6□ R/F	CE UK CA 35~10 mm² T 85°C
		24 x 10□	1 x 10□ R/F 1 x 6□ R/F 1÷2 x 4□ R/F 1÷4 x 2,5□ R/F	
Z50-10D	50□ / 25□	2 x 50□	1 x 50□ R/F 1 x 35□ R/F 1÷2 x 25□ R/F 1÷4 x 16□ R/F	CE UK CA ** 50~25 mm² T 85°C
		8 x 25□	1 x 25□ R/F 1÷2 x 16□ R/F 1÷3 x 10□ R/F 1÷6 x 6□ R/F 1÷9 x 4□ R/F	

* A mixture of conductor sizes may be connected to the terminal block provided that the sum of their sections is less than the nominal section.
R = Rigid conductor F = Flexible conductor

MARKINGS



Italian Institute of the Quality Mark
type approval



Lloyd's Register Marine
type approval



Italian Naval Register
type approval



**
EN60947-1: 2007+A1: 2011: 2014
and EN 60947-7-1: 2002 Norms



Conforms to:

Directive 2014/35/UE

EN 60998-1: 2004 and
EN 60998-2-1: 2004 Norms

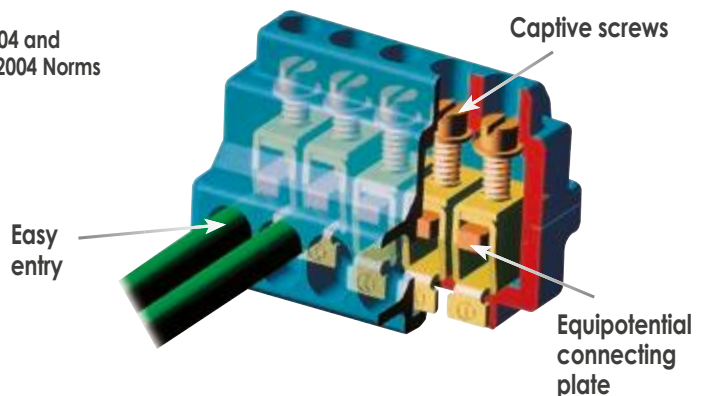

indirect clamping

type
ZETAblock®



Type	No. of poles	No. of Ways per pole	Nominal CSA for each pole sqmm	Maximum operating voltage (Ui)	Impulse voltage (Uimp)	Maximum operating current (In)	Allowable short duration fault current (Icw)	Maximum allowed peak fault current (Ipk)	Self Extinguishing Specification	Dimensions mm	Weight g	Qty
Z25-DP7-100	4	7 (2+5)	(2 way) 25 + (5 way) 6	800 V	8 kV	100 A	3 kA	18 kA	V-0 (UL 94)	70x84xh45	290	2
Z35-DP14-125	4	14 (2+2+10)	(2 way) 35 + (2 way) 16 + (10 way) 6	800 V	8 kV	125 A	4,2 kA	18 kA	V-0 (UL 94)	137x83xh46	700	1
Z35-DP14B-125	2	14 (2+2+10)	(2 way) 35 + (2 way) 16 + (10 way) 6	800 V	8 kV	125 A	4,2 kA	18 kA	V-0 (UL 94)	137x44xh46	360	2
Z50-DP12-160	4	12 (2+4+6)	(2 way) 50 + (4 way) 25 + (6 way) 16	800 V	8 kV	160 A	6 kA	18 kA	V-0 (UL 94)	150x84xh48	780	1

100, 125 and 160A, 2-4 pole distribution blocks with 7, 14 and 12 ways per pole respectively. Accepting a wide cable CSA range (1 - 50 sqmm) and of compact size, Zetablocks are ideal for control cabinets and distribution panels. The lateral arrangement of terminals on upper and lower faces (Z35-DP14B one face only), simplifies connection and promotes tidy, homogeneous cable routing to assist subsequent wiring operations. Easy entry apertures provide quick, effective cable insertion while the indirect clamping feature eliminates damage to cable strands and assures a low, stable contact resistance.

Technical features:

- Self extinguishing antishock Polycarbonate body
- Tempered Steel captive clamping screws and plates
- Electrolytically Tin plated Copper interconnectors

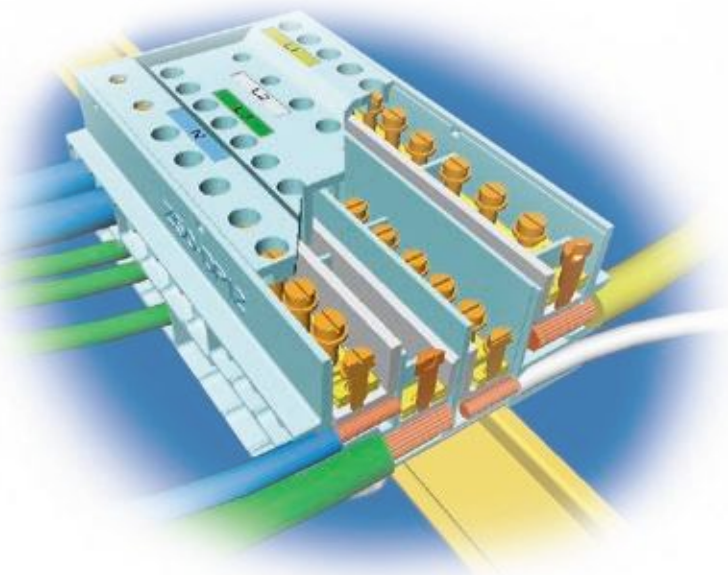

POWER DISTRIBUTION BLOCK

Z-DP

indirect clamping





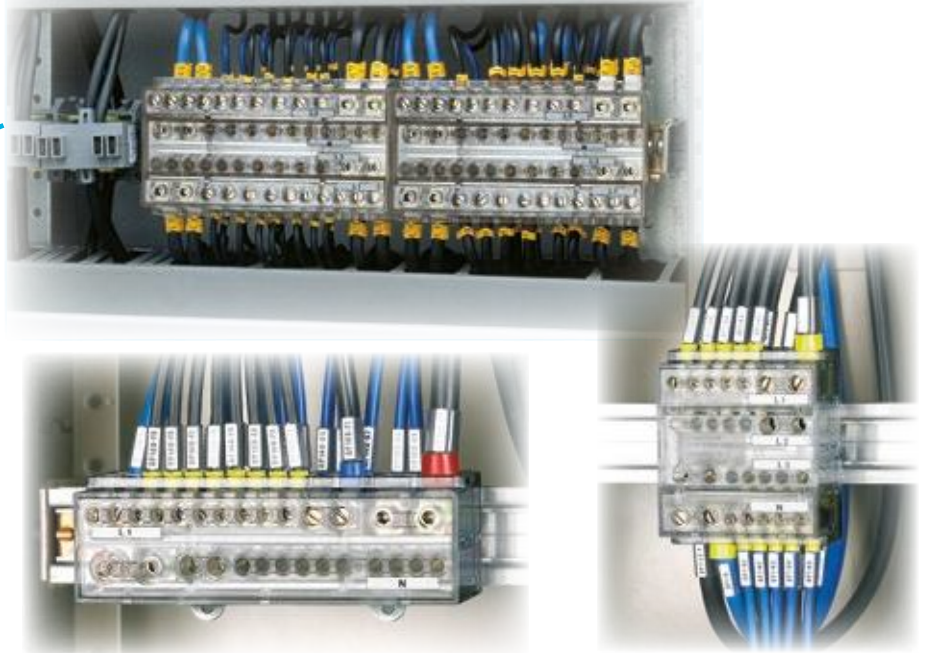



type

ZETAblock®



CONNECTING CAPACITY OF POWER DISTRIBUTION BLOCK

indirect clamping

Type	Nominal Section	No. of Ways x Nominal Section	Connecting Capacity of Each Way No. of Conductors x Section	Markings
Z25-DP7-100	25□/6□	2 x 25□	1 x 25□ F 1 x 16□ F 1÷2 x 10□ F	   25÷6 sqmm
		5 x 6□	1 x 6□ F 1 x 4□ F 1÷2 x 2,5□ F 1÷2 x 1,5□ F 1÷4 x 1□ F	
Z35-DP14-125 Z35-DP14B-125	35□/16□/6□	2 x 35□	1 x 35□ F 1 x 25□ F 1÷2 x 16□ F 1÷3 x 10□ F	   35÷16÷6 sqmm
		2 x 16□	1 x 16□ F 1 x 10□ F 1÷2 x 6□ F 1÷3 x 4□ F 1÷4 x 2,5□ F	
		10 x 6□	1 x 6□ F 1 x 4□ F 1÷2 x 2,5□ F 1÷2 x 1,5□ F 1÷4 x 1□ F	
Z50-DP12-160	50□/25□/16□	2 x 50□	1 x 50□ F 1 x 35□ F 1÷2 x 25□ F	   50÷25÷16 sqmm
		4 x 25□	1 x 25□ F 1 x 16□ F 1÷2 x 10□ F	
		6 x 16□	1 x 16□ F 1 x 10□ F 1÷2 x 6□ F	

F = Flexible conductor

MARKINGS



Italian Institute of the Quality Mark
type approval

Conforms to:
Directive 2014/35/UE

EN 60947-7-1: 2009 Norms

indirect clamping

type
ZETAmini®



Connecting Capacity sqmm	Type	Nominal Voltage V	Maximum Operating Temperature °C	Insulation Specification	Self Extinguishing Specification	Dimensions mm	Weight g	Quantity
2,5	Z2.5-1	450	85	IP20	V-0 (UL 94)	7,6x20xh23,5	3	400/25
6	Z6-1	450	85	IP20	V-0 (UL 94)	11,5x28xh29	6	200/25
10	Z10-1	450	85	IP20	V-0 (UL 94)	15,6x32xh32,5	11	80/10
16	Z16-1	450	85	IP20	V-0 (UL 94)	18x34xh38	15	60/10
25	Z25-1	450	85	IP20	V-0 (UL 94)	20,8x42,5xh43,5	29	50/10
35	Z35-1	450	85	IP20	V-0 (UL 94)	25x45xh51,5	37	40/10

One way, single pole terminal blocks for conductors sections from 0.5 to 35 sqmm.

Self contained and robust, they are ideal for the fast and safe installation for industrial and domestic applications.

The indirect clamping of the "ZETAmini" terminal blocks guarantees a low and stable contact resistance.

The easy-entry receptacle also grants a fast and reliable insertion of the cable.

Technical features:

- Self-extinguishing Polycarbonate body
- Electrolytically Zinc plated, tempered Steel clamp and screw
- Electrolytically Tin plated Steel connection plate

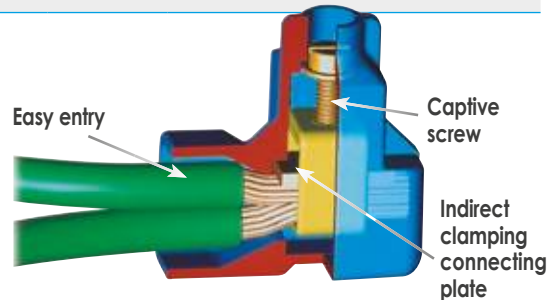

Type	Nominal Section	Connecting Capacity of Each Way* No. of Conductors x Section	Markings
Z2.5-1	2,5□	2 x 2,5□ R/F 2÷3 x 1,5□ R/F 2÷5 x 1,0□ R/F 2÷6 x 0,75□ R/F 2÷10 x 0,5□ R/F 2÷18 x Ø 0,4÷0,6 mm communication type wire	CE UK CA IP20 2,5 sqmm 450V T 85°C IP 20 APPROVED R RIFA
Z6-1	6□	2 x 6□ R/F 2÷3 x 4□ R/F 2÷4 x 2,5□ R/F 2÷6 x 1,5□ R/F 2÷6 x 1□ R/F 2÷10 x 0,75□ R/F 2÷12 x 0,5□ R/F (1 x 6□ F) + (4 x 1,5□ F) (1 x 6□ F) + (2 x 2,5□ F)	CE UK CA IP20 6 sqmm 450V T 85°C IP 20 APPROVED R RIFA
Z10-1	10□	2 x 10□ R/F 2÷3 x 6□ R/F 2÷5 x 4□ R/F 2÷8 x 2,5□ R/F 2÷12 x 1,5□ R/F 2÷20 x 1□ R/F 2÷25 x 0,75□ R/F (1 x 6□ F) + (1 x 4□ F) + (2 x 2,5□ F) + (3 x 1,5□ F)	CE UK CA IP20 10 sqmm 450V T 85°C IP 20 APPROVED R RIFA
Z16-1	16□	2 x 16□ R/F 2÷3 x 10□ R/F 2÷5 x 6□ R/F 2÷8 x 4□ R/F 2÷12 x 2,5□ R/F 2÷18 x 1,5□ R/F	CE UK CA IP20 16 sqmm 450V T 85°C IP 20 APPROVED R RIFA
Z25-1	25□	2 x 25□ R/F 2÷3 x 16□ R/F 2÷4 x 10□ R/F 2÷8 x 6□ R/F 2÷11 x 4□ R/F 4÷16 x 2,5□ R/F	CE UK CA IP20 25 sqmm 450V T 85°C IP 20 APPROVED R RIFA
Z35-1	35□	2 x 35□ R/F 2÷3 x 25□ R/F 2÷4 x 16□ R/F 2÷7 x 10□ R/F 2÷11 x 6□ R/F 4÷17 x 4□ R/F 5÷28 x 2,5□ R/F	CE UK CA IP20 35 sqmm 450V T 85°C IP 20 APPROVED R RIFA

*A mixture of conductor sizes may be connected to the terminal block provided that the sum of their sections is less than twice the nominal section.

R = Rigid conductor F = Flexible conductor

Conforms to:

Directive 2014/35/UE

EN 60998-1: 2004 and

EN 60998-2-1: 2004 Norms

TERMINAL BLOCK TYPE EKL

EKL

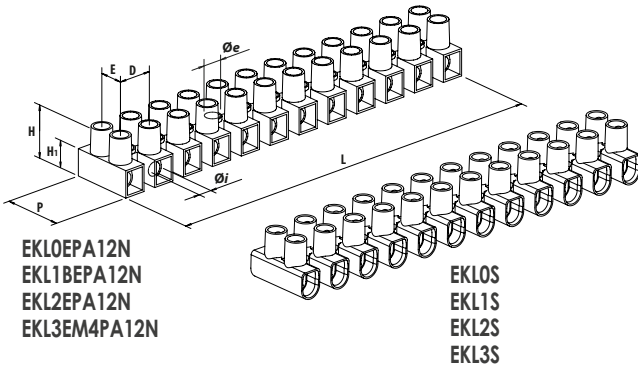

EKLOEPA12N
EKL1BEPA12N
EKL2EPA12N
EKL3EM4PA12N

EKLOS
EKL1S
EKL2S
EKL3S

EKL4BESVCE

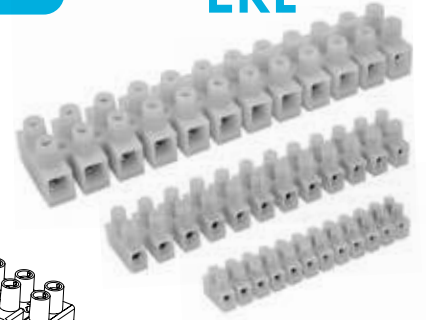

Type 12 Poles of Polyamide (PA6.6)

Type	Nominal section sqmm	Dimensions mm								Screw	Quantity
		Øi	Øe	L 12 poles	H	H1	P	E	D		
□ EKLOEPA12N	2,5	3,0	2,6	94,0	14,5	9,2	16,4	6,0	8,0	M3	50
□ EKL1BEPA12N	4	3,4	3,2	116,2	15,7	8,3	20,2	10,0	10,0	M3	30
□ EKL2EPA12N	10	4,3	3,2	139,8	20,0	10,8	23,1	10,0	12,0	M3,5	20
□ EKL3EM4PA12N	16	5,8	4,1	171,8	24,8	14,7	32,1	13,0	14,5	M4*	25
□ EKL4BEPA12N	25	7,4	4,6	208,5	34,0	14,7	37,5	17,0	18,0	M5	25

□ Nominal voltage: 450 V
Ambient temperature: max 110°C

* Combination head screws

Material:

- Block made of chromium plated Brass
- Screw made of chromium plated Steel

Variants upon request for version en Polyamide PA6.6

N° of poles from 1 to 11:

- replace reference 12 with n° of required poles
- Versions with protection plate: add reference "DSN"

Type 12 Poles of Polypropylene (PP)



Type	Nominal section sqmm	Dimensions mm								Screw	Quantity
		Øi	Øe	L 12 poles	H	H1	P	E	D		
● EKLOS	4	3,2	2,65	94,9	13,0	-	16,6	6,4	8,1	M2,6	50
● EKL1S	6	3,5	3,4	116,5	14,9	-	18,9	7,3	10,0	M3	30
● EKL2S	10	4,3	3,7	133,8	17,3	-	23,4	10,0	11,5	M3,5	15
● EKL3S	16	5,5	4,9	174,5	25,0	-	20,7	11,0	15,0	M4	25
◇ EKL4BESVCE	25	7,0	4,0	187,3	28,0	-	30,0	11,0	16,0	M5	25

● Nominal voltage: 450 V
Ambient temperature: max 80°C

◇ Nominal voltage: 750 V
Ambient temperature: max 80°C

EKL OE PA XX XX

N° poles DSN version with protective blade

DSN

TERMINAL BLOCK TYPE ZS

ZS

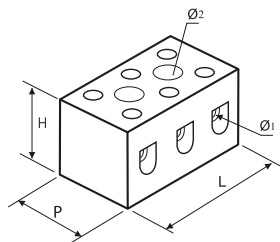

Type	Nominal section sqmm		No. of poles	Dimensions mm					Quantity
	Low Str.	Flex		Ø1	Ø2	L	H	P	
ZS-U6	4/6	4	1	2,8	-	9	18	19	200
ZS-B6	4/6	4	2	2,8	4,0	22	18	19	80
ZS-T6	4/6	4	3	2,8	4,0	36	18	19	60
ZS-U10	10	6	1	4,3	-	13	20	21	200
ZS-B10	10	6	2	4,3	4,8	24	20	21	80
ZS-T10	10	6	3	4,3	4,8	36	20	21	70
ZS-U16	16	10	1	6,1	-	15	22	27	100
ZS-B16	16	10	2	6,1	5,0	31	22	27	50
ZS-T16	16	10	3	6,1	5,0	48	22	27	30



Material:

- insulating body in STEATITE
- screw in GALVANIZED STEEL
- BRASS clamp

Nominal voltage: 450 V
Operating temperature: 350°C

DB/1N



UNIPOLAR DISTRIBUTION BLOCKS

direct clamping

DBLOCK UNIPOLAR SERIES

- 80, 125, 160, 250, 400, 500 A distribution blocks
- Versions available with 6, 7 or 11 outputs (see table)
- Wire entry facilitated by chamfered entry holes and clamping screws
- Terminals maintain excellent stability of the connection over time
- Connection can be expanded through dedicated unipolar jumpers (can be used for types DB125-7/1N and DB160-7/1N)



Type	N° inputs	Connecting Capacity in mm²	N° outputs	Connecting Capacity out mm²	IEC* 60947-7-1		UL* 1059		Allowable short duration fault current (Icw)	Maximum allowed peak fault current (Ipk)	Self Extinguishing Specification	Dimensions mm	Weight g	Qty
					Nominal voltage	Nominal Current	Nominal voltage	Nominal Current						
DB80-6/1N	1	6÷16	6 (4+2)	(4) 2,5÷6 (2) 2,5÷16	1000 V	80 A	600 V	85 A	3 kA	22 kA	V-0 (UL 94)	66x27xh46	70	5
DB125-7/1N	1	10÷35	7 (6+1)	(6) 2,5÷16 (1) 6÷16	1000 V	125 A	600 V	150 A	4.2 kA	30 kA	V-0 (UL 94)	77x29xh46	142	5
DB160-7/1N	1	10÷70	7 (6+1)	(6) 2,5÷16 (1) 6÷16	1000 V	160 A	600 V	200 A	11.8 kA	30 kA	V-0 (UL 94)	77x29xh46	136	5
DB250-11/1N	1	35÷120	11 (2+5+4)	(2) 6÷35 (5) 2,5÷16 (4) 2,5÷10	1000 V	250 A	600 V	255 A	24.5 kA	51 kA	V-0 (UL 94)	96x46xh50	423	3
DB400-11/1N	1	95÷185	11 (2+5+4)	(2) 6÷35 (5) 2,5÷16 (4) 2,5÷10	1000 V	400 A	600 V	335 A	24.5 kA	51 kA	V-0 (UL 94)	96x46xh50	402	3
DB500-11/1N	1	8x24 Flex. Busbar	11 (2+5+4)	(2) 6÷35 (5) 2,5÷16 (4) 2,5÷10	1000 V	500 A	600 V	335 A	24.5 kA	51 kA	V-0 (UL 94)	96x46xh50	388	3

DB/2



BIPOLAR DISTRIBUTION BLOCKS

direct clamping

DBLOCK BIPOLAR SERIES

- 40, 100, 125 A bipolar distribution blocks
- Versions available with 6, 13, 14 or 15 outputs (see table)
- Wire entry facilitated by chamfered entry holes
- Terminals maintain excellent stability of the connection over time



Type	N° inputs	Connecting Capacity in mm²	N° outputs	Connecting Capacity out mm²	Nominal voltage	Nominal Current	Allowable short duration fault current (Icw)	Maximum allowed peak fault current (Ipk)	Self Extinguishing Specification	Dimensions mm	Weight g	Quantity
DB100-6/2	1	10÷25	6 (3+3)	(3) 1,5÷4 / 0,75÷4 (3) 2,5÷6 / 1,5÷6	500 V	100 A	4.5 kA	20 kA	V-0 (UL 94)	50x64xh50	110	1
DB100-13/2	2	10÷25	13 (6+7)	(6) 1,5÷4 / 0,75÷4 (7) 2,5÷6 / 1,5÷6	500 V	100 A	4.5 kA	20 kA	V-0 (UL 94)	50x130xh50	208	1
DB125-6/2	1	10÷35	6 (5+1)	(5) 2,5÷6 / 1,5÷6 (1) 10÷25 / 6÷16	690 V	125 A	4.5 kA	18 kA	V-0 (UL 94)	50x94xh50	160	1
DB125-14/2	1	10÷35	14 (11+3)	(11) 2,5÷6 / 1,5÷6 (3) 10÷25 / 6÷16	690 V	125 A	4.5 kA	18 kA	V-0 (UL 94)	50x162xh50	266	1
DB125-14/2C	2	10÷35 10÷16	13 (11+2)	(11) 2,5÷6 / 1,5÷6 (2) 10÷25 / 6÷16	500 V	125 A	4.5 kA	20 kA	V-0 (UL 94)	50x130xh50	204	1

TETRAPOLAR DISTRIBUTION BLOCKS

DB/4

direct clamping



DBLOCK TETRAPOLAR

- 40, 100, 125, 160 A distribution blocks
- Versions available with 6, 13, 14 or 15 outputs (see table)
- Wire entry facilitated by chamfered entry holes
- Terminals maintain excellent stability of the connection over time

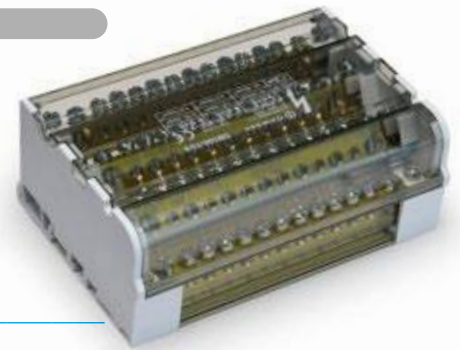

Type	N° inputs	Connecting Capacity in mm²	N° outputs	Connecting Capacity out mm²	Nominal voltage	Nominal Current	Allowable short duration fault current (Icw)	Maximum allowed peak fault current (Ipk)	Self Extinguishing Specification	Dimensions mm	Weight g	Quantity
DB40-11/4	2	6÷16 4÷10	11	1,5÷4 / 0,75÷4	500 V	40 A	4.5 kA	22 kA	V-0 (UL 94)	90x100xh50	351	1
DB100-6/4	1	10÷25	6 (3+3)	(3) 1,5÷4 / 0,75÷4 (3) 2,5÷6 / 1,5÷6	500 V	100 A	4.5 kA	20 kA	V-0 (UL 94)	90x64xh50	230	1
DB100-13/4	2	10÷25	13 (6+7)	(6) 1,5÷4 / 0,75÷4 (7) 2,5÷6 / 1,5÷6	500 V	100 A	4.5 kA	20 kA	V-0 (UL 94)	90x130xh50	444	1
DB125-6/4	1	10÷35	6 (5+1)	(5) 2,5÷6 / 1,5÷6 (1) 10÷25 / 6÷16	690 V	125 A	4.5 kA	20 kA	V-0 (UL 94)	90x109xh50	326	1
DB125-10/4	1	10÷35	10 (7+3)	(7) 2,5÷6 / 1,5÷6 (3) 10÷25 / 6÷16	690 V	125 A	4.5 kA	20 kA	V-0 (UL 94)	90x147xh50	440	1
DB125-10/4C	2	10÷35 10÷16	9 (7+2)	(7) 2,5÷6 / 1,5÷6 (2) 10÷25 / 6÷16	500 V	125 A	4.5 kA	20 kA	V-0 (UL 94)	90x100xh50	306	1
DB125-14/4	1	10÷35	14 (11+1+2)	(11) 2,5÷6 / 1,5÷6 (1) 10÷25 / 6÷16 (2) 10÷35 / 10÷25	690 V	125 A	4.2 kA	14.5 kA	V-0 (UL 94)	90x182xh50	586	1
DB125-14/4C	2	10÷35 10÷16	13 (11+2)	(11) 2,5÷6 / 1,5÷6 (2) 10÷25 / 6÷16	500 V	125 A	4.5 kA	20 kA	V-0 (UL 94)	90x130xh50	398	1
DB160-11/4	1	10÷50	11 (3+7+1)	(3) 10÷35 / 10÷25 (7) 2,5÷6 / 1,5÷6 (1) 2,5÷6 / 1,5÷6	690 V	160 A	8.2 kA	35 kA	V-0 (UL 94)	96x175xh50	738	1



ACCESSORIES

neutral bars



Type	N° inputs	Connecting Capacity in mm²	N° outputs	Connecting Capacity out mm²	Nominal voltage	Nominal Current	Allowable short duration fault current (Icw)	Maximum allowed peak fault current (Ipk)	Type Application	Length mm	Weight g	Quantity
DNB125-9	4	10÷25 / 6÷16	9	2,5÷6 / 1,5÷6	-	125 A	4.5 kA	30 kA	DB125-10/4 DB125-14/4	142	172	1
DNB160-10	4	10÷35 / 10÷25	10	2,5÷16 / 1,5÷16	-	160 A	6.2 kA	35 kA	DB160-11/4	168	192	1



unipolar jumper



Type	Nominal Current	Type Application	Length mm	Weight g	Quantity
DJ160	125 A - 160 A	DB125-7/1N - DB160-7/1N	37	29	5



DJ160



Designation

SFI	8	x 24	x 1
Insulated flexible busbar	Number of strips	Strip width mm	Strip thickness mm

Advantages

Insulated flexible busbar is a self-contained system combining convenient layout and connection with assured insulation and self-supporting construction, resulting in reduced cost installations with extreme ease of use.

Compared to plain busbar:

- Higher current capacity size for size
- Space saving as individual insulated busbars may be positioned in closer proximity
- Layout easier and quicker due to flexibility
- Insulated support not required.

Compared to cables:

- Simple and rapid installation
- Space saving due to tighter bend radius
- Insulated support not required.

Principle of selection

The following charts allow selection of the appropriate configuration based on:

- ambient temperature of 35°C
- required current carrying capacity in Amps
- maximum permitted temperature increase

Example of selection

Required current carrying capacity per phase is 630A. Maximum permitted temperature in the equipment enclosure is 85°C:

- ambient temperature is 35°C
- maximum permitted temperature rise is 85°C - 35°C = 50°C

The possible selections are where the red vertical line (630A) intersects the green temperature band (50°C):

SFI8X24X1
SFI6X32X1
SFI4X40X1

The final selection will depend on limitations relating to connection palm width.

Technical features

PVC Insulation (for width 9 - 50mm):

- Colour: Black
- Density: 1,36 g/cm³
- Hardness: 86 Shore A
- Breaking resistance: ≈ 18 MPa
- Breaking elongation: ≈ 300 %
- Self-extinguishing class: Vo (UL94)

Strip:

- Copper designation: Cu-ETP
- Copper purity min: 99,9%
- Max electrical resistivity at 20°C: 1,7241 μΩ/cm (100% IACS)
- Breaking resistance min: 200MPa
- Breaking elongation min: 30%
- Hardness: <55 HV
- Surface protection: Sm 99
- Thickness of tin plating: 2 ÷ 4 μm

Insulated flexible busbar:

- max working voltage: 1000 V AC /1500 V DC
- Working temperature: -40°C ÷ +105°C
- Average thickness of extruded PVC: 2mm
- Average dielectric strength between conductor and earth: 15 kV/mm (50Hz)
- between conductors: 30 kV/mm (50Hz)

Total conductor c.s.a. sqmm	Type
21,6	SFI3X9X0.8
43,2	SFI6X9X0.8
13,0	SFI2X13X0.5
19,5	SFI3X13X0.5
26	SFI4X13X0.5
39	SFI6X13X0.5
24,8	SFI2X15.5X0.8
37,2	SFI3X15.5X0.8
49,6	SFI4X15.5X0.8
74,4	SFI6X15.5X0.8
124	SFI10X15.5X0.8
40	SFI2X20X1
60	SFI3X20X1
80	SFI4X20X1
100	SFI5X20X1
120	SFI6X20X1
48	SFI2X24X1
72	SFI3X24X1
96	SFI4X24X1
120	SFI5X24X1
144	SFI6X24X1
192	SFI8X24X1
240	SFI10X24X1
64	SFI2X32X1
96	SFI3X32X1
128	SFI4X32X1
160	SFI5X32X1
192	SFI6X32X1
256	SFI8X32X1
320	SFI10X32X1
160	SFI4X40X1
200	SFI5X40X1
240	SFI6X40X1
320	SFI8X40X1
400	SFI10X40X1
200	SFI4X50X1
250	SFI5X50X1
300	SFI6X50X1
400	SFI8X50X1
500	SFI10X50X1
315	SFI5X63X1
378	SFI6X63X1
504	SFI8X63X1
630	SFI10X63X1
320	SFI4X80X1
480	SFI6X80X1
640	SFI8X80X1
800	SFI10X80X1
1000	SFI10X100X1



Concept and design

CEMBRE SFI series insulated flexible busbar comprises a set of Cu strips within an insulated sleeve - for widths 9-50mm this is extruded PVC, for widths 63-100mm it is heat shrunk material.

The dielectric strength of the insulation is guaranteed independent of the eventual formation of the busbar and its working conditions (humidity, temperature and environmental aggressors).

Dimensions

Standard length: 2000 mm (consult us for other lengths)
Strip thickness: 0,5 - 1 mm
Number of strips: 2 - 12.

Applications

- Power distribution, substituting cable with extruded insulation and rigid busbar
- Electrical equipment (racks, circuit breakers, rectifiers)
- Transformers

Current carrying capacity (A)

Temperature increase for each configuration based on an ambient temperature of 35°C

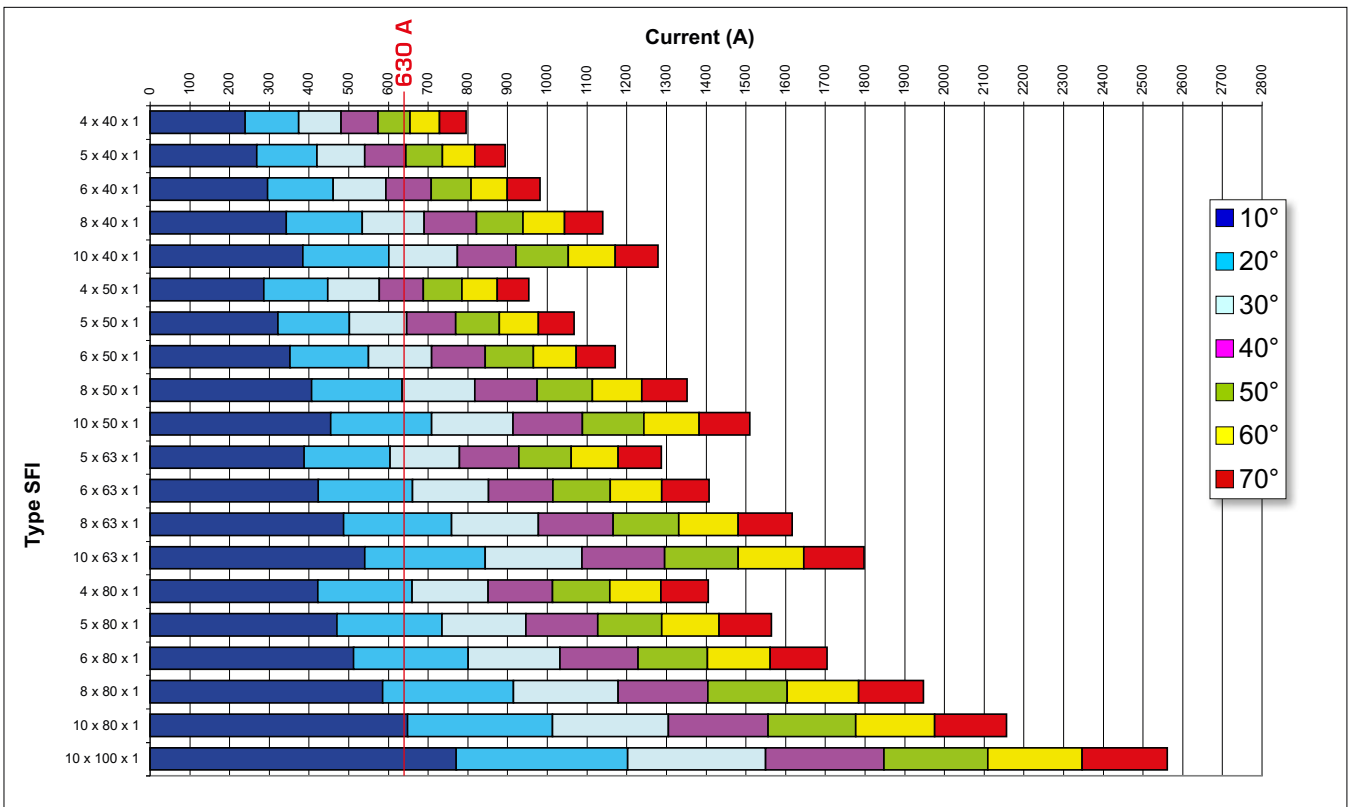
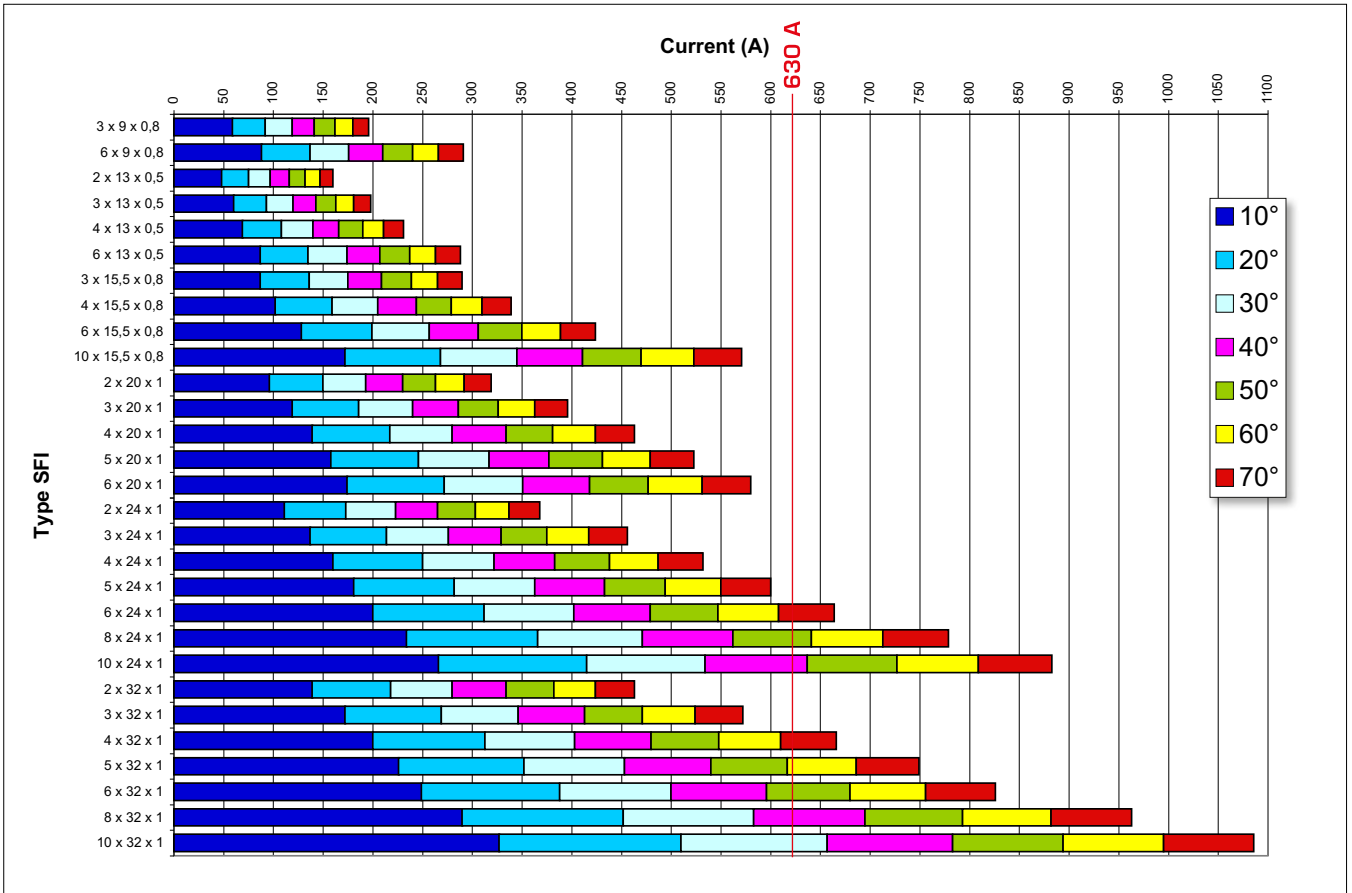

Mechanical bending and torsion testing

Test temperatures: -10°C and $+80^{\circ}\text{C}$.

Bending 180°

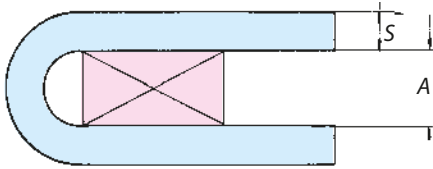

S = Bar thickness (conductor + insulation)
 $A = 2 \times S$

Torsion 90°

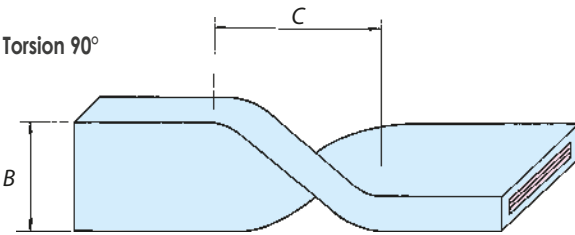

B = Bar width (conductor + insulation)
 $C = 1,5 \times B$

In both cases the tests do not show damage to the insulation



Insulated flexible busbar installation

Bending:

Small section configurations may be bent manually. When tooling is used, protect the insulated sleeve of the busbar from damage. As the Cu strips move relative to each other during bending, this operation should be completed before drilling.

Drilling:

Drilling templates type **MFB 13-40** and type **MFB 50-63** (available as optional extras) are designed to facilitate accurate location of fixing holes in the busbar of $\varnothing 8, 10, 12$ mm.

It is recommended that the insulation of the busbar is not removed before drilling is completed, as it assists the operation.

Template type	includes drilling inserts	for bar width mm
MFB 13-40	SFB13-16	for bar width 13÷15,5 mm
	SFB20-24	for bar width 20÷24 mm
MFB 50-63	SFB32-40	for bar width 32÷40 mm
	SFB50-63	for bar width 50÷63 mm

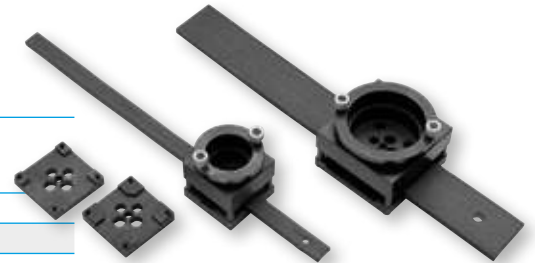

FLEXIBLE BRAIDS

FL

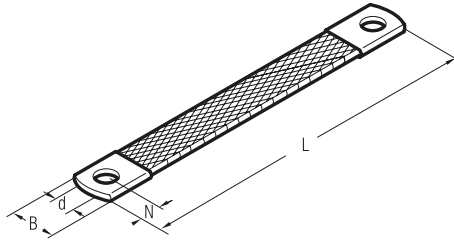

Size sqmm	Ø Stud mm	Type	Dimensions mm				Quantity
			B	N	L	d	
10	8	FL10-150	17	10	150	8,5	50
	8	FL10-200	17	10	200	8,5	50
	8	FL10-250	17	10	250	8,5	50
16	8	FL16-150	17	10	150	8,5	50
	8	FL16-200	17	10	200	8,5	50
	8	FL16-250	17	10	250	8,5	50
	8	FL16-320	17	10	320	8,5	50
	8	FL16-350	17	10	350	8,5	50
	8	FL16-420	17	10	420	8,5	25
	8	FL16-570	17	10	570	8,5	25
	8	FL16-660	17	10	660	8,5	25
25	8	FL25-150	21	10	150	8,5	50
	8	FL25-200	21	10	200	8,5	50
	8	FL25-250	21	10	250	8,5	50
	8	FL25-300	21	10	300	8,5	50



Flexible braids are manufactured from electrolytic Copper wire. Braids of different conductor sizes or lengths are available on request. Standard finish - bright Copper. Flexible braids can be supplied Tin plated, in this case add the suffix "ST" to reference.

E.g.:
 - FL10-150 (Bright Copper)
 - FL10-150-ST (Tin plated)



CABLE TIES

G series, PA6.6 Polyamide

PA 6.6



HF
HALOGEN
FREE



Material: PA6.6 Polyamide
Self-extinguishing V2 (UL 94)
Humidity absorption:
2,5% (at 50% relative humidity)
Operating temperature:
From -40°C to +85°C (continuous)
From -40°C to +120°C (short periods)
Resistant to:
oils, greases, oil products, chlorinated solvents.
Colour: Natural or Black (Ral 2005)

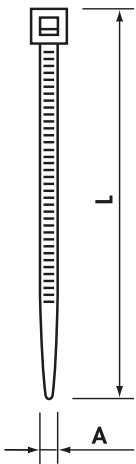

Black ties have higher UV resistance due to increased carbon black loading

Natural ties offer rapid installation due to the low friction coefficient of the material

Cable Ties in PA6.6

Type	L (mm)	A (mm)	Max. Bundle Ø (mm)	Min. Loop Tensile Strength (kg)	Quantity					
G80X2.4	80	2,4	15	8	100					
G80X2.4N					1000					
G80X2.4/M			16		100					
G80X2.4N/M					1000					
G90X2.4	90	2,4	16		8	100				
G90X2.4N						1000				
G100X2.5			100			2,5	22	100		
G100X2.5N								1000		
G100X2.5/M	120	2,5	30	100						
G100X2.5N/M				1000						
G120X2.5	120	2,5	30	8		100				
G120X2.5N						1000				
G140X2.5			140		2,5	33	1000			
G140X2.5N							1000			
G140X2.5/M	160	2,5	40		100					
G140X2.5N/M					1000					
G160X2.5	160	2,5	40		8	100				
G160X2.5N						1000				
G160X2.5/M			200	2,5		53	1000			
G160X2.5N/M							100			
G200X2.5	200	2,5	53	8		100				
G200X2.5N						1000				
G200X2.5/M			250			2,8	65	100		
G200X2.5N/M								1000		
G250X2.8	250	2,8	65		14	100				
G250X2.8N						1000				
G300X2.8			300			2,8	76	100		
G300X2.8N								1000		
G120X3.6	120	3,6	30	18		100				
G120X3.6N						1000				
G140X3.6			140			3,6	33	100		
G140X3.6N								1000		
G140X3.6/M	150	3,6	35		100					
G140X3.6N/M					1000					
G150X3.6	150	3,6	35		18	100				
G150X3.6N						1000				
G180X3.6			180	3,6		44	100			
G180X3.6N							1000			
G200X3.6	200	3,6	53	18		100				
G200X3.6N						1000				
G200X3.6/M			250			3,6	65	100		
G200X3.6N/M								1000		
G250X3.6	250	3,6	65		18	100				
G250X3.6N						1000				
G300X3.6			300			3,6	76	100		
G300X3.6N								1000		
G300X3.6/M	370	3,6	102	100						
G300X3.6N/M				1000						
G370X3.6	370	3,6	102	22		100				
G370X3.6N						1000				
G120X4.8			120		4,8	24	22	100		
G120X4.8N								1000		
G160X4.8	160	4,8	38		22	100				
G160X4.8N						1000				
G190X4.8			190			4,8		46	100	
G190X4.8N									1000	
G190X4.8/M	200	4,8	50	1000						
G190X4.8N/M				100						
G200X4.8	200	4,8	50	22		100				
G200X4.8N						1000				
G200X4.8/M			250		4,8	60	1000			
G200X4.8N/M							100			
G250X4.8/M	250	4,8	60		22	1000				
G250X4.8N/M						1000				
G250X4.8			280			4,8	70	100	100	
G250X4.8N									1000	
G280X4.8	300	4,8	76	100		100				
G280X4.8N						1000				
G300X4.8	300	4,8	76			100	100			
G300X4.8N							1000			
G370X4.8			370		4,8		102		100	100
G370X4.8N										1000
G390X4.8	390	4,8	105		100		100			
G390X4.8N							1000			
G430X4.8	430	4,8	110	100			100			
G430X4.8N							1000			

Minimum order: 1,000 pcs

Minimum order: 100 pcs

Note: In Type, N = Black

Recommended tools are shown on page 219

The dimensions shown in the table must be considered as nominal. CEMBRE reserves the right to make changes without prior notice

CABLE TIES



G series, PA6.6 Polyamide

Cable Ties in PA6.6

Type	L (mm)	A (mm)	Max. Bundle Ø (mm)	Min. Loop Tensile Strength (kg)	Quantity	
G450X4.8	450	4,8	116	22	100	
G450X4.8N						
G530X4.8	530	4,8	140	22		
G530X4.8N						
G150X7.6	150	7,6	33	55		
G150X7.6N						
G200X7.6	200		50			55
G200X7.6N						
G250X7.6	250		65			55
G250X7.6N						
G300X7.6	300		76			55
G300X7.6N						
G370X7.6	370		102			55
G370X7.6N						
G430X7.6	430		125			55
G430X7.6N						
G530X7.6	530	140	55			
G530X7.6N						
G430X9.0	430	9,0	110	80		
G430X9.0N						
G530X9.0	530		140			80
G530X9.0N						
G710X9.0	710		190			80
G710X9.0N						
G780X9.0	780		228		80	
G780X9.0N						
G830X9.0	830		239		80	
G830X9.0N						
G920X9.0	920		263		80	
G920X9.0N						
G1020X9.0	1020	295	80			
G1020X9.0N						
G1220X9.0	1220	365	80			
G1220X9.0N						
G230X12.6	230	12,6	50	115		
G230X12.6N						
G380X12.6	380		106		115	
G480X12.6						480
G480X12.6N						
G580X12.6	580		152		115	
G580X12.6N						
G730X12.6	730		204		115	
G730X12.6N						
G880X12.6	880		248		115	
G880X12.6N						
G1030X12.6	1030		295		115	
G1030X12.6N						

Minimum order: 100 pcs

PA 6.6
V2 UL94
-40°C
+120°C

HF
HALOGEN
FREE



Angled tongue to facilitate easy introduction into the buckle



Rounded corners for increased safety



Note: In Type, N = Black

Recommended tools are shown on page 219

The dimensions shown in the table must be considered as nominal. CEMBRE reserves the right to make changes without prior notice

GR

CABLE TIES

GR series, PA6.6 Polyamide



HF HALOGEN FREE

Same features as G series.
Easy installation without tools.
Released by pressure on the tongue.
Suitable for temporary locking.

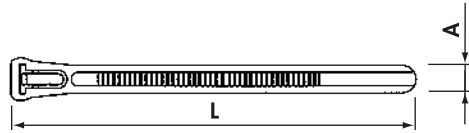

Releasable cable ties in PA6.6

Type	L (mm)	A (mm)	Max. Bundle Ø (mm)	Min. Loop Tensile Strength (kg)	Quantity
GR100X7.6N	100	7,6	20	22,2	100
GR120X7.6N	120		30		
GR150X7.6N	150		35		
GR200X7.6N	200		50		
GR250X7.6N	250		66		
GR300X7.6N	300		80		
GR370X7.6N	370		102		

Recommended tools are shown on page 219

The dimensions shown in the table must be considered as nominal. CEMBRE reserves the right to make changes without prior notice

GFH

CABLE TIES

GFH series, PA6.6 Polyamide



HF HALOGEN FREE



Same features as G series.
Quick and easy identification of bundled conductors.
Write on panel with Felt tip pen.

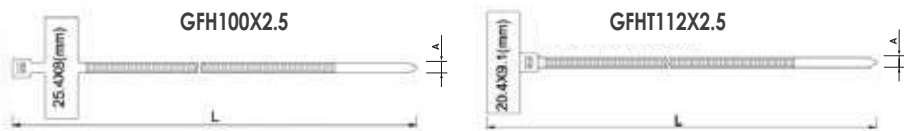

Markable cable ties in PA6.6

Type	L (mm)	A (mm)	Max. Bundle Ø (mm)	Min. Loop Tensile Strength (kg)	Quantity
GFH100X2.5	100	2,5	18	8,1	100
GFHT112X2.5	112				

Recommended tools are shown on page 219

The dimensions shown in the table must be considered as nominal. CEMBRE reserves the right to make changes without prior notice

1600

CABLE TIES

1600 series, Elastomerized Polymer on Polyamide base



HF HALOGEN FREE

Resistant to: UV, salt atmosphere, oils, greases, oil products
Colour: Black

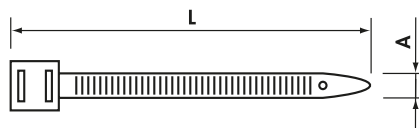

Material: Elastomerized Polymer on Polyamide base
Self-extinguishing HB (UL94)
Halogen free
Operating temperature:
From -45°C to +85°C (continuous)
From -45°C to +120°C (short periods)

Cable Ties in PA12 Polyamide

Type	Head Type	L (mm)	A (mm)	Min. Bundle Ø (mm)	Max. Bundle Ø (mm)	Min. Loop Tensile Strength (kg)	Quantity
1618.90	single	180	9	15	40	40	100
1626.90	double	260	9	30	60	55	100
1636.90	double	360	9	30	93	55	100
1651.90	double	510	9	70	140	55	100
1676.90	double	760	9	70	220	55	100

Recommended tools are shown on page 219

The dimensions shown in the table must be considered as nominal. CEMBRE reserves the right to make changes without prior notice

CABLE TIES

GX

GX series, in Stainless Steel AISI 304

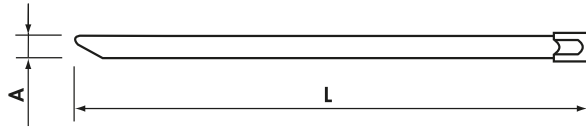

Cable Ties in Stainless Steel

Type	L (mm)	A (mm)	Max. Bundle Ø (mm)	Min. Loop Tensile Strength (kg)	Quantity
GX200X4.5	200	4,5	50	46	100
GX300X4.5	300		76		
GX370X4.5	370		102		
GX520X4.5	520		156		
GX370X7.9	370	7,9	102	114	
GX680X7.9	680		207		
GX1020X7.9	1020		312		

Recommended tools are shown on page 219

The dimensions shown in the table must be considered as nominal. CEMBRE reserves the right to make changes without prior notice

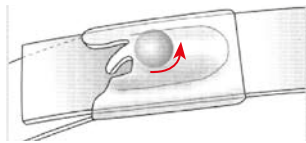

Insert the tongue into the buckle. The internal locking ball rolls freely as the tie is tightened.

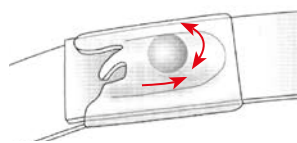

Once the correct tension is reached, use the specific tool to trim the tongue. The ball then wedges into the buckle locking it tightly against both the top and bottom of the tie.



Material: Stainless Steel AISI 304
 Unique ball locking mechanism that allows simple and rapid installation and secure locking.
 Operating temperature: From -80°C to +500°C
 High tensile strength.
 Non-flammability.
 High resistance to acetic acid, alkalies, sulphuric acid, corrosion, etc.
 In general very resistant to most hostile environments.

CABLE TIES

GXAC

GXAC series, 316 Stainless Steel coated with Polyester

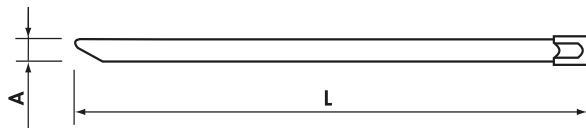

Coated Stainless Steel cable ties

Type	L (mm)	A (mm)	Max. Bundle Ø (mm)	Min. Loop Tensile Strength (kg)	Quantity
GXAC125X4.6	125	4,6	38,0	46	100
GXAC150X4.6	150		46,0		
GXAC200X4.6	200		61,9		
GXAC260X4.6	260		81,0		
GXAC290X4.6	290		90,6		
GXAC360X4.6	360		112,8		
GXAC520X4.6	520		163,8		
GXAC680X4.6	680		214,8		
GXAC840X4.6	840		265,7		
GXAC200X7.9	200		7,9		
GXAC290X7.9	290	90,6			
GXAC360X7.9	360	112,8			
GXAC520X7.9	520	163,8			
GXAC680X7.9	680	214,8			
GXAC840X7.9	840	265,7			

Recommended tools are shown on page 219

The dimensions shown in the table must be considered as nominal. CEMBRE reserves the right to make changes without prior notice

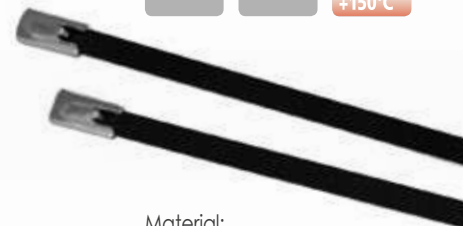

Material: 316 stainless steel for the most corrosive environments coated with Polyester for insulation purpose, and a better outdoor application
 Colour: Black
 Smooth surface and rounded edges assures cable protection and user safety. Equipped with unique ball locking mechanism that allows simple and rapid installation and secure locking.
 Operating temperature: da -40°C a +150°C
 High tensile strength
 Very resistant to ultraviolet radiation and chemical corrosion
 Non flammable

PA6.6 Polyamide



PA 6.6



Material: PA6.6 Polyamide
 Self-extinguishing V2 (UL 94)
 Humidity absorption:
 2,5% (at 50% relative humidity)
 Operating temperature:
 From -40°C to +85°C (continuous)
 From -40°C to +120°C (short periods)

Resistant to:
 oils, bases, greases, oil products,
 chlorinated solvents.
 Colour: Natural

Attention:
acrylic adhesive; to obtain the best result, wait at least 6 - 8 hours before applying the load.

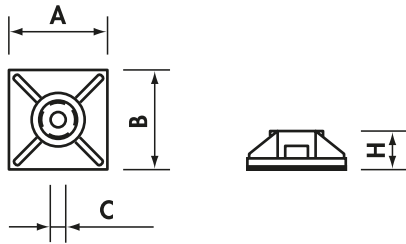

Self adhesive cable tie bases in PA6.6

Type	Max Tie (mm)	A (mm)	B (mm)	C (mm)	H (mm)	Fixing screw hole Ø (mm)	Quantity
AB13*	2,8	13,0	13,0	3,2	3,2	-	100
AB19*	3,6	19,0	19,0	4,0	4,4	3,1	100
AB28*	4,8	28,0	28,0	5,3	5,7	5,5	100

*Add to Ref: N for Black

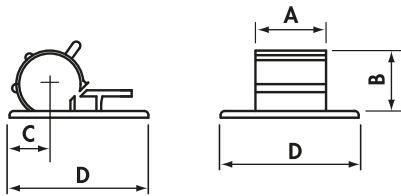

Self adhesive cable clips in PA6.6

Type	Cable Ø (mm)	A (mm)	B (mm)	C (mm)	D (mm)	Quantity
CC8.9	8-9	9,0	12,0	8,0	21,5	100
CC9.12	9-12	12,0	15,0	8,2	21,5	100

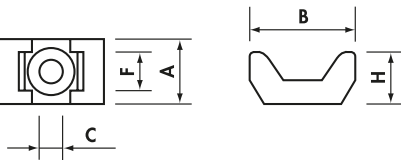

Cable tie saddle clamps in PA6.6

Type	Max Tie (mm)	A (mm)	B (mm)	C (mm)	F (mm)	H (mm)	Quantity
SS4.8-3.7	4,8	9,5	15	3,7	5,0	7,2	100
SS4.8-4.5	4,8	9,5	15	4,5	5,0	7,2	100
SS9-4.5	9	16,0	22	4,5	9,2	9,7	100
SS9-5	9	16,0	22	5,0	9,2	9,7	100
SS9-6.4	9	16,0	22	6,4	9,2	9,7	100

GH8

PA6.6 Polyamide



Same features as G series.
 Push into Ø 8 mm hole.
 Cable tie inserted through slot in head.

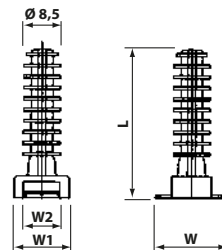

Stud fixing for cable ties in PA6.6

Type	W (mm)	W1 (mm)	W2 (mm)	L (mm)	Fixing hole Ø (mm)	Quantity
GH8	20	15	10	40,5	8	100

INSULATED COVERS

For uninsulated connectors

ES

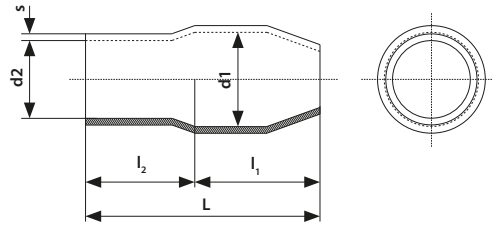

Insulated covers in PVC for general use with CEMBRE A-M copper tube lugs characterised by environmental tolerance, flexibility, not inflammability & stable performance. Widely used for the insulation and protection of connections and electrical terminations.

General features:

- Material: PVC
- Self extinguishing (UL94): V0
- Working temperature: 85 °C
- Colours: red, yellow, blue, black, grey, brown.

Type	Connectors A-M*	d1 Ø	d2 Ø	l1 ±1	l2 ±1	L ±2	s ±0.2	Quantity	Minimum Order Qty
ES03-..	A03	3.3	3.1	7.0	8.0	15.0	0.6	100	3,000
ES06-..	A06	4.5	3.7	8.0	8.0	16.0	0.7	100	
ES1-..	A1	5.7	4.1	9.0	9.0	18.0	0.8	100	
ES2-..	A2	7.2	6.2	11.0	10.0	21.0	1.0	100	1,000
ES3-..	A3	10.0	8.0	15.0	13.0	28.0	1.1	100	
ES5-..	A5	12.0	9.5	15.0	14.0	29.0	1.2	100	
ES10-..	A7, A9, A10	14.0	11.8	17.0	17.0	34.0	1.4	100	500
ES14-..	A12, A14	17.0	13.9	22.0	20.0	42.0	1.5	100	
ES19-..	A17, A19	19.0	16.0	25.0	21.0	46.0	1.5	50	
ES24-..	A20, A24	22.0	18.0	31.0	24.0	55.0	1.7	50	200
ES30-..	A29, A30	24.0	20.0	32.0	28.0	60.0	1.8	50	
ES37-..	A35, A37	26.0	22.0	34.0	31.0	65.0	1.8	50	
ES40-..	A40	32.2	24.0	38.0	31.0	69.0	2.0	50	100
ES48-..	A48	36.5	27.2	42.0	33.0	75.0	2.0	50	
ES80-..	A60, A80	36.7	30.0	42.0	33.0	75.0	2.0	25	

Add the suffix corresponding to the selected colour to the reference:

-BU blue, -GY grey, -BR brown, -BK black, -RE red, -YE yellow,

* See A-M type copper tube lugs on pages 34-35, 37

** Depending on the diameter of the insulated cable



Heat-shrinkable Polyolefin tubing coil for general use; is environmentally neutral, flexible, not inflammable and offers fast heat shrinkage and stable performance.

Main uses include insulation and protection of electrical conductors, connectors and terminations; protection of metal tubes from corrosion; protection of antennae and various identification applications.

For general characteristics and technical specifications see page 108.

- Colours: Black, Red, White, Blue, Transparent, Yellow, Green, Grey, Brown, Yellow/Green.
- Packaging: Coil on Reel

Type	Coil Length	before shrinking		after shrinking		Colour
		Internal Ø mm	Internal Ø mm	Thickness mm	Colour	
TCS12X200BK	200 m	Ø 1,1 mm	Ø 0,50 mm	0,33 mm	BLACK	●
TCS16X200BK	200 m	Ø 1,5 mm	Ø 0,65 mm	0,36 mm	BLACK	●
TCS24X200BK	200 m	Ø 2,5 mm	Ø 1,00 mm	0,45 mm	BLACK	●
TCS32X200BK	200 m	Ø 3,0 mm	Ø 1,30 mm	0,45 mm	BLACK	●
TCS48X100BK	100 m	Ø 4,7 mm	Ø 2,00 mm	0,45 mm	BLACK	●
TCS64X100BK	100 m	Ø 6,5 mm	Ø 3,00 mm	0,56 mm	BLACK	●
TCS95X100BK	100 m	Ø 9,5 mm	Ø 4,50 mm	0,56 mm	BLACK	●
TCS127X100BK	100 m	Ø 12,5 mm	Ø 6,00 mm	0,56 mm	BLACK	●
TCS160X100BK	100 m	Ø 16,5 mm	Ø 8,00 mm	0,70 mm	BLACK	●
TCS190X100BK	100 m	Ø 19,0 mm	Ø 9,00 mm	0,70 mm	BLACK	●
TCS254X50BK	50 m	Ø 26,0 mm	Ø 12,5 mm	0,90 mm	BLACK	●
TCS320X50BK	50 m	Ø 31,5 mm	Ø 15,0 mm	1,00 mm	BLACK	●
TCS381X50BK	50 m	Ø 36,5 mm	Ø 17,5 mm	1,00 mm	BLACK	●
TCS508X25BK	25 m	Ø 50,0 mm	Ø 25,0 mm	1,10 mm	BLACK	●
TCS762X25BK	25 m	Ø 70,0 mm	Ø 36,0 mm	1,30 mm	BLACK	●
TCS1016X25BK	25 m	Ø 100,0 mm	Ø 51,0 mm	1,30 mm	BLACK	●
TCS1260X25BK	25 m	Ø 120,0 mm	Ø 61,0 mm	1,30 mm	BLACK	●
TCS1500X25BK	25 m	Ø 150,0 mm	Ø 76,0 mm	1,30 mm	BLACK	●
TCS16X200RE	200 m	Ø 1,5 mm	Ø 0,65 mm	0,36 mm	RED	●
TCS24X200RE	200 m	Ø 2,5 mm	Ø 1,00 mm	0,45 mm	RED	●
TCS32X200RE	200 m	Ø 3,0 mm	Ø 1,30 mm	0,45 mm	RED	●
TCS48X100RE	100 m	Ø 4,7 mm	Ø 2,00 mm	0,45 mm	RED	●
TCS64X100RE	100 m	Ø 6,5 mm	Ø 3,00 mm	0,56 mm	RED	●
TCS95X100RE	100 m	Ø 9,5 mm	Ø 4,50 mm	0,56 mm	RED	●
TCS127X100RE	100 m	Ø 12,5 mm	Ø 6,00 mm	0,56 mm	RED	●
TCS190X100RE	100 m	Ø 19,0 mm	Ø 9,00 mm	0,70 mm	RED	●
TCS254X50RE	50 m	Ø 26,0 mm	Ø 12,5 mm	0,90 mm	RED	●
TCS16X200WH	200 m	Ø 1,5 mm	Ø 0,65 mm	0,36 mm	WHITE	○
TCS20X200WH	200 m	Ø 2,0 mm	Ø 0,85 mm	0,36 mm	WHITE	○
TCS24X200WH	200 m	Ø 2,5 mm	Ø 1,00 mm	0,45 mm	WHITE	○
TCS32X200WH	200 m	Ø 3,0 mm	Ø 1,30 mm	0,45 mm	WHITE	○
TCS48X100WH	100 m	Ø 4,7 mm	Ø 2,00 mm	0,45 mm	WHITE	○
TCS64X100WH	100 m	Ø 6,5 mm	Ø 3,00 mm	0,56 mm	WHITE	○
TCS95X100WH	100 m	Ø 9,5 mm	Ø 4,50 mm	0,56 mm	WHITE	○
TCS127X100WH	100 m	Ø 12,5 mm	Ø 6,00 mm	0,56 mm	WHITE	○
TCS190X100WH	100 m	Ø 19,0 mm	Ø 9,00 mm	0,70 mm	WHITE	○
TCS254X50WH	50 m	Ø 26,0 mm	Ø 12,5 mm	0,90 mm	WHITE	○
TCS16X200BU	200 m	Ø 1,5 mm	Ø 0,65 mm	0,36 mm	BLUE	●
TCS24X200BU	200 m	Ø 2,5 mm	Ø 1,00 mm	0,45 mm	BLUE	●
TCS32X200BU	200 m	Ø 3,0 mm	Ø 1,30 mm	0,45 mm	BLUE	●
TCS48X100BU	100 m	Ø 4,7 mm	Ø 2,00 mm	0,45 mm	BLUE	●
TCS64X100BU	100 m	Ø 6,5 mm	Ø 3,00 mm	0,56 mm	BLUE	●
TCS95X100BU	100 m	Ø 9,5 mm	Ø 4,50 mm	0,56 mm	BLUE	●
TCS127X100BU	100 m	Ø 12,5 mm	Ø 6,00 mm	0,56 mm	BLUE	●
TCS190X100BU	100 m	Ø 19,0 mm	Ø 9,00 mm	0,70 mm	BLUE	●
TCS254X50BU	50 m	Ø 26,0 mm	Ø 12,5 mm	0,90 mm	BLUE	●
TCS381X50BU	50 m	Ø 36,5 mm	Ø 17,5 mm	1,00 mm	BLUE	●
TCS508X25BU	25 m	Ø 50,0 mm	Ø 25,0 mm	1,10 mm	BLUE	●

TERMOCOIL HEAT-SHRINKABLE TUBING

TCS

flame-retardant Polyolefin - shrinkage ratio 2÷1



Type	Coil Length	before shrinking		after shrinking		Colour
		Internal Ø mm	Internal Ø mm	Thickness mm	Thickness mm	
TCS12X200TR	200 m	Ø 1,1 mm	Ø 0,50 mm	0,33 mm	TRANSPARENT	○
TCS16X200TR	200 m	Ø 1,5 mm	Ø 0,65 mm	0,36 mm	TRANSPARENT	○
TCS24X200TR	200 m	Ø 2,5 mm	Ø 1,00 mm	0,45 mm	TRANSPARENT	○
TCS32X200TR	200 m	Ø 3,0 mm	Ø 1,30 mm	0,45 mm	TRANSPARENT	○
TCS48X100TR	100 m	Ø 4,7 mm	Ø 2,00 mm	0,45 mm	TRANSPARENT	○
TCS64X100TR	100 m	Ø 6,5 mm	Ø 3,00 mm	0,56 mm	TRANSPARENT	○
TCS95X100TR	100 m	Ø 9,5 mm	Ø 4,50 mm	0,56 mm	TRANSPARENT	○
TCS127X100TR	100 m	Ø 12,5 mm	Ø 6,00 mm	0,56 mm	TRANSPARENT	○
TCS160X100TR	100 m	Ø 16,5 mm	Ø 8,00 mm	0,70 mm	TRANSPARENT	○
TCS190X100TR	100 m	Ø 19,0 mm	Ø 9,00 mm	0,70 mm	TRANSPARENT	○
TCS254X50TR	50 m	Ø 26,0 mm	Ø 12,5 mm	0,90 mm	TRANSPARENT	○
TCS320X50BK	50 m	Ø 31,5 mm	Ø 15,0 mm	1,00 mm	TRANSPARENT	○
TCS381X50TR	50 m	Ø 36,5 mm	Ø 17,5 mm	1,00 mm	TRANSPARENT	○
TCS508X25TR	25 m	Ø 50,0 mm	Ø 25,0 mm	1,10 mm	TRANSPARENT	○
TCS762X25TR	25 m	Ø 70,0 mm	Ø 36,0 mm	1,30 mm	TRANSPARENT	○
TCS1016X25TR	25 m	Ø 100,0 mm	Ø 51,0 mm	1,30 mm	TRANSPARENT	○
TCS1260X25TR	25 m	Ø 120,0 mm	Ø 61,0 mm	1,30 mm	TRANSPARENT	○
TCS1500X25TR	25 m	Ø 150,0 mm	Ø 76,0 mm	1,30 mm	TRANSPARENT	○
TCS16X200YE	200 m	Ø 1,5 mm	Ø 0,65 mm	0,36 mm	YELLOW	●
TCS24X200YE	200 m	Ø 2,5 mm	Ø 1,00 mm	0,45 mm	YELLOW	●
TCS32X200YE	200 m	Ø 3,0 mm	Ø 1,30 mm	0,45 mm	YELLOW	●
TCS48X100YE	100 m	Ø 4,7 mm	Ø 2,00 mm	0,45 mm	YELLOW	●
TCS64X100YE	100 m	Ø 6,5 mm	Ø 3,00 mm	0,56 mm	YELLOW	●
TCS95X100YE	100 m	Ø 9,5 mm	Ø 4,50 mm	0,56 mm	YELLOW	●
TCS127X100YE	100 m	Ø 12,5 mm	Ø 6,00 mm	0,56 mm	YELLOW	●
TCS190X100YE	100 m	Ø 19,0 mm	Ø 9,00 mm	0,70 mm	YELLOW	●
TCS254X50YE	50 m	Ø 26,0 mm	Ø 12,5 mm	0,90 mm	YELLOW	●
TCS16X200GN	200 m	Ø 1,5 mm	Ø 0,65 mm	0,36 mm	GREEN	●
TCS24X200GN	200 m	Ø 2,5 mm	Ø 1,00 mm	0,45 mm	GREEN	●
TCS32X200GN	200 m	Ø 3,0 mm	Ø 1,30 mm	0,45 mm	GREEN	●
TCS48X100GN	100 m	Ø 4,7 mm	Ø 2,00 mm	0,45 mm	GREEN	●
TCS64X100GN	100 m	Ø 6,5 mm	Ø 3,00 mm	0,56 mm	GREEN	●
TCS95X100GN	100 m	Ø 9,5 mm	Ø 4,50 mm	0,56 mm	GREEN	●
TCS127X100GN	100 m	Ø 12,5 mm	Ø 6,00 mm	0,56 mm	GREEN	●
TCS190X100GN	100 m	Ø 19,0 mm	Ø 9,00 mm	0,70 mm	GREEN	●
TCS254X50GN	50 m	Ø 26,0 mm	Ø 12,5 mm	0,90 mm	GREEN	●
TCS16X200GY	200 m	Ø 1,5 mm	Ø 0,65 mm	0,36 mm	GREY	●
TCS24X200GY	200 m	Ø 2,5 mm	Ø 1,00 mm	0,45 mm	GREY	●
TCS32X200GY	200 m	Ø 3,0 mm	Ø 1,30 mm	0,45 mm	GREY	●
TCS48X100GY	100 m	Ø 4,7 mm	Ø 2,00 mm	0,45 mm	GREY	●
TCS64X100GY	100 m	Ø 6,5 mm	Ø 3,00 mm	0,56 mm	GREY	●
TCS95X100GY	100 m	Ø 9,5 mm	Ø 4,50 mm	0,56 mm	GREY	●
TCS127X100GY	100 m	Ø 12,5 mm	Ø 6,00 mm	0,56 mm	GREY	●
TCS190X100GY	100 m	Ø 19,0 mm	Ø 9,00 mm	0,70 mm	GREY	●
TCS254X50GY	50 m	Ø 26,0 mm	Ø 12,5 mm	0,90 mm	GREY	●
TCS381X50GY	50 m	Ø 36,5 mm	Ø 17,5 mm	1,00 mm	GREY	●
TCS508X25GY	25 m	Ø 50,0 mm	Ø 25,0 mm	1,10 mm	GREY	●
TCS16X200BR	200 m	Ø 1,5 mm	Ø 0,65 mm	0,36 mm	BROWN	●
TCS24X200BR	200 m	Ø 2,5 mm	Ø 1,00 mm	0,45 mm	BROWN	●
TCS32X200BR	200 m	Ø 3,0 mm	Ø 1,30 mm	0,45 mm	BROWN	●
TCS48X100BR	100 m	Ø 4,7 mm	Ø 2,00 mm	0,45 mm	BROWN	●
TCS64X100BR	100 m	Ø 6,5 mm	Ø 3,00 mm	0,56 mm	BROWN	●
TCS95X100BR	100 m	Ø 9,5 mm	Ø 4,50 mm	0,56 mm	BROWN	●
TCS127X100BR	100 m	Ø 12,5 mm	Ø 6,00 mm	0,56 mm	BROWN	●
TCS190X100BR	100 m	Ø 19,0 mm	Ø 9,00 mm	0,70 mm	BROWN	●
TCS254X50BR	50 m	Ø 26,0 mm	Ø 12,5 mm	0,90 mm	BROWN	●
TCS381X50BR	50 m	Ø 36,5 mm	Ø 17,5 mm	1,00 mm	BROWN	●
TCS508X25BR	25 m	Ø 50,0 mm	Ø 25,0 mm	1,10 mm	BROWN	●
TCS32X200Y/G	200 m	Ø 3,0 mm	Ø 1,30 mm	0,45 mm	YELLOW/GREEN	●
TCS48X100Y/G	100 m	Ø 4,7 mm	Ø 2,00 mm	0,45 mm	YELLOW/GREEN	●
TCS64X100Y/G	100 m	Ø 6,5 mm	Ø 3,00 mm	0,56 mm	YELLOW/GREEN	●
TCS95X100Y/G	100 m	Ø 9,5 mm	Ø 4,50 mm	0,56 mm	YELLOW/GREEN	●
TCS127X100Y/G	100 m	Ø 12,5 mm	Ø 6,00 mm	0,56 mm	YELLOW/GREEN	●
TCS190X100Y/G	100 m	Ø 19,0 mm	Ø 9,00 mm	0,70 mm	YELLOW/GREEN	●
TCS254X50Y/G	50 m	Ø 26,0 mm	Ø 12,5 mm	0,90 mm	YELLOW/GREEN	●
TCS381X50Y/G	50 m	Ø 36,5 mm	Ø 17,5 mm	1,00 mm	YELLOW/GREEN	●
TCS508X25Y/G	25 m	Ø 50,0 mm	Ø 25,0 mm	1,10 mm	YELLOW/GREEN	●



Heat-shrinkable Polyolefin tubing strip for general use; is environmentally neutral, flexible, not inflammable and offers fast heat shrinkage and stable performance.

Main uses include insulation and protection of electrical conductors, connectors and terminations; protection of metal tubes from corrosion; protection of antennae and various identification applications.

For general characteristics and technical specifications see page 108.

- Colours: Black, Red, White, Blue, Transparent, Yellow, Green, Grey, Brown, Yellow/Green.
- Packaging: Strips in Box

Type	Strip Length	before shrinking		after shrinking		Colour	Quantity Strips per box
		Internal Ø mm	Internal Ø mm	Thickness mm	Thickness mm		
TSS12BK	1,22 m	Ø 1,1 mm	Ø 0,5 mm	0,33 mm	0,33 mm	BLACK ●	30
TSS16BK	1,22 m	Ø 1,5 mm	Ø 0,65 mm	0,36 mm	0,36 mm	BLACK ●	30
TSS24BK	1,22 m	Ø 2,5 mm	Ø 1,00 mm	0,45 mm	0,45 mm	BLACK ●	30
TSS32BK	1,22 m	Ø 3,0 mm	Ø 1,30 mm	0,45 mm	0,45 mm	BLACK ●	30
TSS48BK	1,22 m	Ø 4,7 mm	Ø 2,00 mm	0,45 mm	0,45 mm	BLACK ●	30
TSS64BK	1,22 m	Ø 6,5 mm	Ø 3,00 mm	0,56 mm	0,56 mm	BLACK ●	30
TSS95BK	1,22 m	Ø 9,5 mm	Ø 4,50 mm	0,56 mm	0,56 mm	BLACK ●	20
TSS127BK	1,22 m	Ø 12,5 mm	Ø 6,00 mm	0,56 mm	0,56 mm	BLACK ●	15
TSS190BK	1,22 m	Ø 19,0 mm	Ø 9,00 mm	0,70 mm	0,70 mm	BLACK ●	10
TSS254BK	1,22 m	Ø 26,0 mm	Ø 12,5 mm	0,90 mm	0,90 mm	BLACK ●	6
TSS380BK	1,22 m	Ø 36,5 mm	Ø 17,5 mm	1,00 mm	1,00 mm	BLACK ●	4
TSS510BK	1,22 m	Ø 50,0 mm	Ø 25,0 mm	1,10 mm	1,10 mm	BLACK ●	2
TSS12RE	1,22 m	Ø 1,1 mm	Ø 0,5 mm	0,33 mm	0,33 mm	RED ●	30
TSS16RE	1,22 m	Ø 1,5 mm	Ø 0,65 mm	0,36 mm	0,36 mm	RED ●	30
TSS24RE	1,22 m	Ø 2,5 mm	Ø 1,00 mm	0,45 mm	0,45 mm	RED ●	30
TSS32RE	1,22 m	Ø 3,0 mm	Ø 1,30 mm	0,45 mm	0,45 mm	RED ●	30
TSS48RE	1,22 m	Ø 4,7 mm	Ø 2,00 mm	0,45 mm	0,45 mm	RED ●	30
TSS64RE	1,22 m	Ø 6,5 mm	Ø 3,00 mm	0,56 mm	0,56 mm	RED ●	30
TSS95RE	1,22 m	Ø 9,5 mm	Ø 4,50 mm	0,56 mm	0,56 mm	RED ●	20
TSS127RE	1,22 m	Ø 12,5 mm	Ø 6,00 mm	0,56 mm	0,56 mm	RED ●	15
TSS190RE	1,22 m	Ø 19,0 mm	Ø 9,00 mm	0,70 mm	0,70 mm	RED ●	10
TSS254RE	1,22 m	Ø 26,0 mm	Ø 12,5 mm	0,90 mm	0,90 mm	RED ●	6
TSS380RE	1,22 m	Ø 36,5 mm	Ø 17,5 mm	1,00 mm	1,00 mm	RED ●	4
TSS510RE	1,22 m	Ø 50,0 mm	Ø 25,0 mm	1,10 mm	1,10 mm	RED ●	2
TSS12WH	1,22 m	Ø 1,1 mm	Ø 0,5 mm	0,33 mm	0,33 mm	WHITE ○	30
TSS16WH	1,22 m	Ø 1,5 mm	Ø 0,65 mm	0,36 mm	0,36 mm	WHITE ○	30
TSS24WH	1,22 m	Ø 2,5 mm	Ø 1,00 mm	0,45 mm	0,45 mm	WHITE ○	30
TSS32WH	1,22 m	Ø 3,0 mm	Ø 1,30 mm	0,45 mm	0,45 mm	WHITE ○	30
TSS48WH	1,22 m	Ø 4,7 mm	Ø 2,00 mm	0,45 mm	0,45 mm	WHITE ○	30
TSS64WH	1,22 m	Ø 6,5 mm	Ø 3,00 mm	0,56 mm	0,56 mm	WHITE ○	30
TSS95WH	1,22 m	Ø 9,5 mm	Ø 4,50 mm	0,56 mm	0,56 mm	WHITE ○	20
TSS127WH	1,22 m	Ø 12,5 mm	Ø 6,00 mm	0,56 mm	0,56 mm	WHITE ○	15
TSS190WH	1,22 m	Ø 19,0 mm	Ø 9,00 mm	0,70 mm	0,70 mm	WHITE ○	10
TSS254WH	1,22 m	Ø 26,0 mm	Ø 12,5 mm	0,90 mm	0,90 mm	WHITE ○	6
TSS380WH	1,22 m	Ø 36,5 mm	Ø 17,5 mm	1,00 mm	1,00 mm	WHITE ○	4
TSS510WH	1,22 m	Ø 50,0 mm	Ø 25,0 mm	1,10 mm	1,10 mm	WHITE ○	2
TSS12BU	1,22 m	Ø 1,1 mm	Ø 0,5 mm	0,33 mm	0,33 mm	BLUE ●	30
TSS16BU	1,22 m	Ø 1,5 mm	Ø 0,65 mm	0,36 mm	0,36 mm	BLUE ●	30
TSS24BU	1,22 m	Ø 2,5 mm	Ø 1,00 mm	0,45 mm	0,45 mm	BLUE ●	30
TSS32BU	1,22 m	Ø 3,0 mm	Ø 1,30 mm	0,45 mm	0,45 mm	BLUE ●	30
TSS48BU	1,22 m	Ø 4,7 mm	Ø 2,00 mm	0,45 mm	0,45 mm	BLUE ●	30
TSS64BU	1,22 m	Ø 6,5 mm	Ø 3,00 mm	0,56 mm	0,56 mm	BLUE ●	30
TSS95BU	1,22 m	Ø 9,5 mm	Ø 4,50 mm	0,56 mm	0,56 mm	BLUE ●	20
TSS127BU	1,22 m	Ø 12,5 mm	Ø 6,00 mm	0,56 mm	0,56 mm	BLUE ●	15
TSS190BU	1,22 m	Ø 19,0 mm	Ø 9,00 mm	0,70 mm	0,70 mm	BLUE ●	10
TSS254BU	1,22 m	Ø 26,0 mm	Ø 12,5 mm	0,90 mm	0,90 mm	BLUE ●	6
TSS380BU	1,22 m	Ø 36,5 mm	Ø 17,5 mm	1,00 mm	1,00 mm	BLUE ●	4
TSS510BU	1,22 m	Ø 50,0 mm	Ø 25,0 mm	1,10 mm	1,10 mm	BLUE ●	2
TSS12TR	1,22 m	Ø 1,1 mm	Ø 0,5 mm	0,33 mm	0,33 mm	TRANSPARENT ○	30
TSS16TR	1,22 m	Ø 1,5 mm	Ø 0,65 mm	0,36 mm	0,36 mm	TRANSPARENT ○	30
TSS24TR	1,22 m	Ø 2,5 mm	Ø 1,00 mm	0,45 mm	0,45 mm	TRANSPARENT ○	30
TSS32TR	1,22 m	Ø 3,0 mm	Ø 1,30 mm	0,45 mm	0,45 mm	TRANSPARENT ○	30
TSS48TR	1,22 m	Ø 4,7 mm	Ø 2,00 mm	0,45 mm	0,45 mm	TRANSPARENT ○	30
TSS64TR	1,22 m	Ø 6,5 mm	Ø 3,00 mm	0,56 mm	0,56 mm	TRANSPARENT ○	30
TSS95TR	1,22 m	Ø 9,5 mm	Ø 4,50 mm	0,56 mm	0,56 mm	TRANSPARENT ○	20
TSS127TR	1,22 m	Ø 12,5 mm	Ø 6,00 mm	0,56 mm	0,56 mm	TRANSPARENT ○	15
TSS190TR	1,22 m	Ø 19,0 mm	Ø 9,00 mm	0,70 mm	0,70 mm	TRANSPARENT ○	10
TSS254TR	1,22 m	Ø 26,0 mm	Ø 12,5 mm	0,90 mm	0,90 mm	TRANSPARENT ○	6
TSS380TR	1,22 m	Ø 36,5 mm	Ø 17,5 mm	1,00 mm	1,00 mm	TRANSPARENT ○	4
TSS510TR	1,22 m	Ø 50,0 mm	Ø 25,0 mm	1,10 mm	1,10 mm	TRANSPARENT ○	2

TERMOSTRIP HEAT-SHRINKABLE TUBING

TSS

flame-retardant Polyolefin - shrinkage ratio 2÷1

Type	Strip Length	before shrinking		after shrinking		Colour	Quantity Strips per box
		Internal Ø mm	Internal Ø mm	Thickness mm			
TSS12YE	1,22 m	Ø 1,1 mm	Ø 0,5 mm	0,33 mm	YELLOW		30
TSS16YE	1,22 m	Ø 1,5 mm	Ø 0,65 mm	0,36 mm	YELLOW		30
TSS24YE	1,22 m	Ø 2,5 mm	Ø 1,00 mm	0,45 mm	YELLOW		30
TSS32YE	1,22 m	Ø 3,0 mm	Ø 1,30 mm	0,45 mm	YELLOW		30
TSS48YE	1,22 m	Ø 4,7 mm	Ø 2,00 mm	0,45 mm	YELLOW		30
TSS64YE	1,22 m	Ø 6,5 mm	Ø 3,00 mm	0,56 mm	YELLOW		30
TSS95YE	1,22 m	Ø 9,5 mm	Ø 4,50 mm	0,56 mm	YELLOW		20
TSS127YE	1,22 m	Ø 12,5 mm	Ø 6,00 mm	0,56 mm	YELLOW		15
TSS190YE	1,22 m	Ø 19,0 mm	Ø 9,00 mm	0,70 mm	YELLOW		10
TSS254YE	1,22 m	Ø 26,0 mm	Ø 12,5 mm	0,90 mm	YELLOW		6
TSS380YE	1,22 m	Ø 36,5 mm	Ø 17,5 mm	1,00 mm	YELLOW		4
TSS510YE	1,22 m	Ø 50,0 mm	Ø 25,0 mm	1,10 mm	YELLOW		2
TSS12GN	1,22 m	Ø 1,1 mm	Ø 0,5 mm	0,33 mm	GREEN		30
TSS16GN	1,22 m	Ø 1,5 mm	Ø 0,65 mm	0,36 mm	GREEN		30
TSS24GN	1,22 m	Ø 2,5 mm	Ø 1,00 mm	0,45 mm	GREEN		30
TSS32GN	1,22 m	Ø 3,0 mm	Ø 1,30 mm	0,45 mm	GREEN		30
TSS48GN	1,22 m	Ø 4,7 mm	Ø 2,00 mm	0,45 mm	GREEN		30
TSS64GN	1,22 m	Ø 6,5 mm	Ø 3,00 mm	0,56 mm	GREEN		30
TSS95GN	1,22 m	Ø 9,5 mm	Ø 4,50 mm	0,56 mm	GREEN		20
TSS127GN	1,22 m	Ø 12,5 mm	Ø 6,00 mm	0,56 mm	GREEN		15
TSS190GN	1,22 m	Ø 19,0 mm	Ø 9,00 mm	0,70 mm	GREEN		10
TSS254GN	1,22 m	Ø 26,0 mm	Ø 12,5 mm	0,90 mm	GREEN		6
TSS380GN	1,22 m	Ø 36,5 mm	Ø 17,5 mm	1,00 mm	GREEN		4
TSS510GN	1,22 m	Ø 50,0 mm	Ø 25,0 mm	1,10 mm	GREEN		2
TSS12GY	1,22 m	Ø 1,1 mm	Ø 0,5 mm	0,33 mm	GREY		30
TSS16GY	1,22 m	Ø 1,5 mm	Ø 0,65 mm	0,36 mm	GREY		30
TSS24GY	1,22 m	Ø 2,5 mm	Ø 1,00 mm	0,45 mm	GREY		30
TSS32GY	1,22 m	Ø 3,0 mm	Ø 1,30 mm	0,45 mm	GREY		30
TSS48GY	1,22 m	Ø 4,7 mm	Ø 2,00 mm	0,45 mm	GREY		30
TSS64GY	1,22 m	Ø 6,5 mm	Ø 3,00 mm	0,56 mm	GREY		30
TSS95GY	1,22 m	Ø 9,5 mm	Ø 4,50 mm	0,56 mm	GREY		20
TSS127GY	1,22 m	Ø 12,5 mm	Ø 6,00 mm	0,56 mm	GREY		15
TSS190GY	1,22 m	Ø 19,0 mm	Ø 9,00 mm	0,70 mm	GREY		10
TSS254GY	1,22 m	Ø 26,0 mm	Ø 12,5 mm	0,90 mm	GREY		6
TSS380GY	1,22 m	Ø 36,5 mm	Ø 17,5 mm	1,00 mm	GREY		4
TSS510GY	1,22 m	Ø 50,0 mm	Ø 25,0 mm	1,10 mm	GREY		2
TSS12BR	1,22 m	Ø 1,1 mm	Ø 0,5 mm	0,33 mm	BROWN		30
TSS16BR	1,22 m	Ø 1,5 mm	Ø 0,65 mm	0,36 mm	BROWN		30
TSS24BR	1,22 m	Ø 2,5 mm	Ø 1,00 mm	0,45 mm	BROWN		30
TSS32BR	1,22 m	Ø 3,0 mm	Ø 1,30 mm	0,45 mm	BROWN		30
TSS48BR	1,22 m	Ø 4,7 mm	Ø 2,00 mm	0,45 mm	BROWN		30
TSS64BR	1,22 m	Ø 6,5 mm	Ø 3,00 mm	0,56 mm	BROWN		30
TSS95BR	1,22 m	Ø 9,5 mm	Ø 4,50 mm	0,56 mm	BROWN		20
TSS127BR	1,22 m	Ø 12,5 mm	Ø 6,00 mm	0,56 mm	BROWN		15
TSS190BR	1,22 m	Ø 19,0 mm	Ø 9,00 mm	0,70 mm	BROWN		10
TSS254BR	1,22 m	Ø 26,0 mm	Ø 12,5 mm	0,90 mm	BROWN		6
TSS380BR	1,22 m	Ø 36,5 mm	Ø 17,5 mm	1,00 mm	BROWN		4
TSS510BR	1,22 m	Ø 50,0 mm	Ø 25,0 mm	1,10 mm	BROWN		2
TSS16Y/G	1,22 m	Ø 1,5 mm	Ø 0,65 mm	0,36 mm	YELLOW/GREEN		30
TSS24Y/G	1,22 m	Ø 2,5 mm	Ø 1,00 mm	0,45 mm	YELLOW/GREEN		30
TSS32Y/G	1,22 m	Ø 3,0 mm	Ø 1,30 mm	0,45 mm	YELLOW/GREEN		30
TSS48Y/G	1,22 m	Ø 4,7 mm	Ø 2,00 mm	0,45 mm	YELLOW/GREEN		30
TSS64Y/G	1,22 m	Ø 6,5 mm	Ø 3,00 mm	0,56 mm	YELLOW/GREEN		30
TSS95Y/G	1,22 m	Ø 9,5 mm	Ø 4,50 mm	0,56 mm	YELLOW/GREEN		20
TSS127Y/G	1,22 m	Ø 12,5 mm	Ø 6,00 mm	0,56 mm	YELLOW/GREEN		15
TSS190Y/G	1,22 m	Ø 19,0 mm	Ø 9,00 mm	0,70 mm	YELLOW/GREEN		10
TSS254Y/G	1,22 m	Ø 26,0 mm	Ø 12,5 mm	0,90 mm	YELLOW/GREEN		6
TSS380Y/G	1,22 m	Ø 36,5 mm	Ø 17,5 mm	1,00 mm	YELLOW/GREEN		4



flame-retardant Polyolefin - shrinkage ratio 2÷1

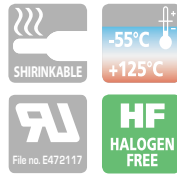

General characteristics:

- Operating temperature: -55°C + 125°C
- Minimum shrinkage temperature: 70°C
- Temperature for complete shrinkage: 110°C
- RoHS compliant
- Colours: Black, Red, White, Blue, Grey, Brown, Yellow/Green.
- Packaging: Roll in Dispenser Box

Heat-shrinkable Polyolefin tubing for general use; is environmentally neutral, flexible, not inflammable and offers fast heat shrinkage and stable performance.

Main uses include insulation and protection of electrical conductors, connectors and terminations; protection of metal tubes from corrosion; protection of antennae and various identification applications.

Technical Specifications:

Property	Test Method	Performance
Traction resistance (MPa):	ASTM D2671	≥10.4
Elongation at failure (%):	ASTM D2671	≥200
Traction resistance after heat aging (MPa):	UL 224 158°Cx168hr	≥7.3
Elongation at failure after heat aging (%):	UL 224 158°Cx168hr	≥100
Heat resistance:	UL 224 250°Cx4hr	No failure
Low temperature flexibility:	UL 224 -30°Cx4hr	No failure
Dielectric strength (kv/mm):	IEC 243	≥15
Insulation resistance:	600V UL 224	No perforation at 2500V
Volume resistance (Ω.cm):	IEC 93	≥1x10 ¹⁴
Corrosive action:	UL 224 158°Cx168hr	Not corrosive
Copper compatibility:	UL 224 158°Cx168hr	Not corrosive
Flammability:	UL 224	VW-1

Type	Reel Length	before shrinking		after shrinking		Colour
		Internal Ø mm	Internal Ø mm	Thickness mm	Thickness mm	
TBS16X20BK	20 m	Ø 1,5 mm	Ø 0,65 mm	0,36 mm	0,36 mm	BLACK ●
TBS24X20BK	20 m	Ø 2,5 mm	Ø 1,00 mm	0,45 mm	0,45 mm	BLACK ●
TBS32X10BK	10 m	Ø 3,0 mm	Ø 1,30 mm	0,45 mm	0,45 mm	BLACK ●
TBS48X10BK	10 m	Ø 4,7 mm	Ø 2,00 mm	0,45 mm	0,45 mm	BLACK ●
TBS64X10BK	10 m	Ø 6,5 mm	Ø 3,00 mm	0,56 mm	0,56 mm	BLACK ●
TBS95X10BK	10 m	Ø 9,5 mm	Ø 4,50 mm	0,56 mm	0,56 mm	BLACK ●
TBS127X10BK	10 m	Ø 12,5 mm	Ø 6,00 mm	0,56 mm	0,56 mm	BLACK ●
TBS190X5BK	5 m	Ø 19,0 mm	Ø 9,00 mm	0,70 mm	0,70 mm	BLACK ●
TBS254X5BK	5 m	Ø 26,0 mm	Ø 12,5 mm	0,90 mm	0,90 mm	BLACK ●
TBS16X20RE	20 m	Ø 1,5 mm	Ø 0,65 mm	0,36 mm	0,36 mm	RED ●
TBS24X20RE	20 m	Ø 2,5 mm	Ø 1,00 mm	0,45 mm	0,45 mm	RED ●
TBS32X10RE	10 m	Ø 3,0 mm	Ø 1,30 mm	0,45 mm	0,45 mm	RED ●
TBS48X10RE	10 m	Ø 4,7 mm	Ø 2,00 mm	0,45 mm	0,45 mm	RED ●
TBS64X10RE	10 m	Ø 6,5 mm	Ø 3,00 mm	0,56 mm	0,56 mm	RED ●
TBS95X10RE	10 m	Ø 9,5 mm	Ø 4,50 mm	0,56 mm	0,56 mm	RED ●
TBS127X10RE	10 m	Ø 12,5 mm	Ø 6,00 mm	0,56 mm	0,56 mm	RED ●
TBS190X5RE	5 m	Ø 19,0 mm	Ø 9,00 mm	0,70 mm	0,70 mm	RED ●
TBS254X5RE	5 m	Ø 26,0 mm	Ø 12,5 mm	0,90 mm	0,90 mm	RED ●
TBS16X20WH	20 m	Ø 1,5 mm	Ø 0,65 mm	0,36 mm	0,36 mm	WHITE ○
TBS24X20WH	20 m	Ø 2,5 mm	Ø 1,00 mm	0,45 mm	0,45 mm	WHITE ○
TBS32X10WH	10 m	Ø 3,0 mm	Ø 1,30 mm	0,45 mm	0,45 mm	WHITE ○
TBS48X10WH	10 m	Ø 4,7 mm	Ø 2,00 mm	0,45 mm	0,45 mm	WHITE ○
TBS64X10WH	10 m	Ø 6,5 mm	Ø 3,00 mm	0,56 mm	0,56 mm	WHITE ○
TBS95X10WH	10 m	Ø 9,5 mm	Ø 4,50 mm	0,56 mm	0,56 mm	WHITE ○
TBS127X10WH	10 m	Ø 12,5 mm	Ø 6,00 mm	0,56 mm	0,56 mm	WHITE ○
TBS190X5WH	5 m	Ø 19,0 mm	Ø 9,00 mm	0,70 mm	0,70 mm	WHITE ○
TBS254X5WH	5 m	Ø 26,0 mm	Ø 12,5 mm	0,90 mm	0,90 mm	WHITE ○
TBS16X20BU	20 m	Ø 1,5 mm	Ø 0,65 mm	0,36 mm	0,36 mm	BLUE ●
TBS24X20BU	20 m	Ø 2,5 mm	Ø 1,00 mm	0,45 mm	0,45 mm	BLUE ●
TBS32X10BU	10 m	Ø 3,0 mm	Ø 1,30 mm	0,45 mm	0,45 mm	BLUE ●
TBS48X10BU	10 m	Ø 4,7 mm	Ø 2,00 mm	0,45 mm	0,45 mm	BLUE ●
TBS64X10BU	10 m	Ø 6,5 mm	Ø 3,00 mm	0,56 mm	0,56 mm	BLUE ●
TBS95X10BU	10 m	Ø 9,5 mm	Ø 4,50 mm	0,56 mm	0,56 mm	BLUE ●
TBS127X10BU	10 m	Ø 12,5 mm	Ø 6,00 mm	0,56 mm	0,56 mm	BLUE ●
TBS190X5BU	5 m	Ø 19,0 mm	Ø 9,00 mm	0,70 mm	0,70 mm	BLUE ●
TBS254X5BU	5 m	Ø 26,0 mm	Ø 12,5 mm	0,90 mm	0,90 mm	BLUE ●

Type	Reel Length	before shrinking		after shrinking		Colour
		Internal Ø mm	Internal Ø mm	Thickness mm	Thickness mm	
TBS16X20GY	20 m	Ø 1,5 mm	Ø 0,65 mm	0,36 mm	0,36 mm	GREY ●
TBS24X20GY	20 m	Ø 2,5 mm	Ø 1,00 mm	0,45 mm	0,45 mm	GREY ●
TBS32X10GY	10 m	Ø 3,0 mm	Ø 1,30 mm	0,45 mm	0,45 mm	GREY ●
TBS48X10GY	10 m	Ø 4,7 mm	Ø 2,00 mm	0,45 mm	0,45 mm	GREY ●
TBS64X10GY	10 m	Ø 6,5 mm	Ø 3,00 mm	0,56 mm	0,56 mm	GREY ●
TBS95X10GY	10 m	Ø 9,5 mm	Ø 4,50 mm	0,56 mm	0,56 mm	GREY ●
TBS127X10GY	10 m	Ø 12,5 mm	Ø 6,00 mm	0,56 mm	0,56 mm	GREY ●
TBS190X5GY	5 m	Ø 19,0 mm	Ø 9,00 mm	0,70 mm	0,70 mm	GREY ●
TBS254X5GY	5 m	Ø 26,0 mm	Ø 12,5 mm	0,90 mm	0,90 mm	GREY ●
TBS16X20BR	20 m	Ø 1,5 mm	Ø 0,65 mm	0,36 mm	0,36 mm	BROWN ●
TBS24X20BR	20 m	Ø 2,5 mm	Ø 1,00 mm	0,45 mm	0,45 mm	BROWN ●
TBS32X10BR	10 m	Ø 3,0 mm	Ø 1,30 mm	0,45 mm	0,45 mm	BROWN ●
TBS48X10BR	10 m	Ø 4,7 mm	Ø 2,00 mm	0,45 mm	0,45 mm	BROWN ●
TBS64X10BR	10 m	Ø 6,5 mm	Ø 3,00 mm	0,56 mm	0,56 mm	BROWN ●
TBS95X10BR	10 m	Ø 9,5 mm	Ø 4,50 mm	0,56 mm	0,56 mm	BROWN ●
TBS127X10BR	10 m	Ø 12,5 mm	Ø 6,00 mm	0,56 mm	0,56 mm	BROWN ●
TBS190X5BR	5 m	Ø 19,0 mm	Ø 9,00 mm	0,70 mm	0,70 mm	BROWN ●
TBS254X5BR	5 m	Ø 26,0 mm	Ø 12,5 mm	0,90 mm	0,90 mm	BROWN ●
TBS16X20Y/G	20 m	Ø 1,5 mm	Ø 0,65 mm	0,36 mm	0,36 mm	YELLOW/GREEN ●
TBS24X20Y/G	20 m	Ø 2,5 mm	Ø 1,00 mm	0,45 mm	0,45 mm	YELLOW/GREEN ●
TBS32X10Y/G	10 m	Ø 3,0 mm	Ø 1,30 mm	0,45 mm	0,45 mm	YELLOW/GREEN ●
TBS48X10Y/G	10 m	Ø 4,7 mm	Ø 2,00 mm	0,45 mm	0,45 mm	YELLOW/GREEN ●
TBS64X10Y/G	10 m	Ø 6,5 mm	Ø 3,00 mm	0,56 mm	0,56 mm	YELLOW/GREEN ●
TBS95X10Y/G	10 m	Ø 9,5 mm	Ø 4,50 mm	0,56 mm	0,56 mm	YELLOW/GREEN ●
TBS127X10Y/G	10 m	Ø 12,5 mm	Ø 6,00 mm	0,56 mm	0,56 mm	YELLOW/GREEN ●
TBS190X5Y/G	5 m	Ø 19,0 mm	Ø 9,00 mm	0,70 mm	0,70 mm	YELLOW/GREEN ●
TBS254X5Y/G	5 m	Ø 26,0 mm	Ø 12,5 mm	0,90 mm	0,90 mm	YELLOW/GREEN ●

CAST RESIN JOINTS

N

cast resin, low voltage through joints



Shells

Manufactured from transparent synthetic material which allows a visual check of the connections before and after casting. The halves of the shell are joined by snap closures which avoid further fixing or sealing.

Shells are left on after casting to provide additional protection against mechanical abrasion, chemical agents and severe weather conditions.



STRAIGHT JOINTS

Type	Dimensions mm				Dimensions Cable	
	L	H	D1(1)	D2(1)	Cable Diameter mm	Indicative Cable Section (2) mm ²
N11	200	50	8	26	8 - 25	4C x 1,5 ÷ 10
N12	260	67	16	32	16 - 31	4C x 10 ÷ 25
N13	360	75	21	38	21 - 36	4C x 35 ÷ 50
N14	400	100	26	41	26 - 39	4C x 50 ÷ 70
N15	530	130	35	56	35 - 54	4C x 95 ÷ 150
N16	700	150	47	74	45 - 72	4C x 185 ÷ 300

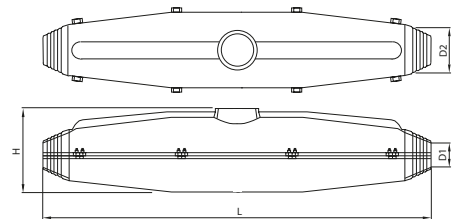

(1) Internal dimension of the shell
 (2) Indicative cable sections are approximate and concern only harmonised, PVC or Rubber insulated cables at a working voltage of 0,6/1 kV



BRANCH JOINTS

Type	Dimensions mm					Dimensions Cable		
	L	H	B	D1(1)	D2(1)	Cable Diameter mm	Indicative Cable Section (2) mm ²	
							Passante	Derivato
NY00	150	47	70	11	20	11 - 20	4C x 1,5 ÷ 2,5	4C x 1,5
NY0	175	60	94	6	22	6 - 21	4C x 4 ÷ 10	4C x 4
NY1	225	75	110	9	26	9 - 24	4C x 6 ÷ 25	4C x 16

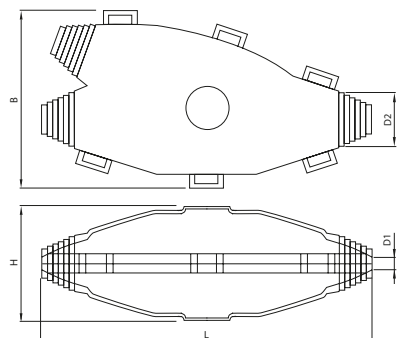

(1) Internal dimension of the shell
 (2) Indicative cable sections are approximate and concern only harmonised, PVC or Rubber insulated cables at a working voltage of 0,6/1 kV

Cast resin technology

PUR-cast resin technology was introduced to seal and protect power, signal and telephone cable joints.

This new generation of two component cast resin has been developed for the most demanding environments and circumstances.

CEMBRE cast resin joints meet the requirements of EN50393 and DIN VDE 57291-2 (VDE0291).

Quick setting properties in humid or even cold conditions make it a fast and reliable solution.

No external measuring or mixing is required as this takes place within an Aluminium foil pouch, avoiding spillage and errors during installation.

Unmixed resin components have a 48 month shelf-life even in the most difficult storage conditions.

Shells are made of durable PET resulting in good hydrophobic properties and excellent impact resistance, while good adhesion to PVC and metals assures a watertight seal.

























Technical characteristic	Test result	Requirement of DIN VDE 0291
Pot life @ 5°C 23°C 35°C	35 min 20 min 15 min	product conforms ± 30%
Reactant open cup flash point	> 200 °C	> 55
Tensile strength	≥ 8.0 Mpa	≥ 5.0
Hot aging	-5 Shore A	-7
Adhesive	> 1500 CP.S	-
Elongation at break	≥ 100%	≥ 50%
Gel time for 300 ml @ Pouch >1000 ml Pouch <1000 ml	23 °C 26 min 17 min	product conforms ± 10% product conforms ± 10%
Max. reaction temp.	60 °C / 333 K	product conforms ± 10%
Total vol. variability when hardening	6 %	max. 6.5 %
Cast resin component open cup flash point	> 200 °C	> 100
Density	1.07 g / cm ³	-
Impact strength	> 10 kJ / m ²	> 10 kJ / m ²
Hardness	75 Shore A	min. 20 Shore D
Expansion coefficient in temp. range 20-50°C	5.9 x 10 ⁻⁴ K ⁻¹	product conforms ± 15%
Thermal conductivity	0.2W x m ⁻¹ x K ⁻¹	product conforms ± 20%
Flammability	Class II c	acc. to DIN VDE 0304, part 3
Water absorption 42 days@50°C	360 mg	max. 400 mg
Electrolytic corrosion	A1	-
Voltage test @ 23°C 80°C	> 20 kV > 10 kV	no breakdown @ test voltage > 20 kV > 20 kV
Dielectric dissipation factor @ 23°C and 50 Hz 23°C and 1k Hz	0.08 0.05	max. 0.1 -
Relative permittivity @ 23°C and 50 Hz @ 23°C and 1k Hz	5 5.1	< 6 -
Tracking resistance	KA 3c	min KA 3c
After 28 days of immersion in 90°C water		
Tensile strength	8.2N/mm ²	≥ 65% of initial value
Elongation at break	60%	≥ 65% of initial value
Hardness	47 Shore	≥ 80% of initial value

CABLE GLANDS AND ACCESSORIES



symbol description

cable glands and accessories

	Polyamide PA6.6 body		V2 UL94 self-extinguishing class
	Polyamide PA6 body		VDE marking
	Neoprene material		ATEX marking
	Polystyrene body		USL-CNL marking valid in USA & CANADA
	Brass body		USR-CNR marking valid in USA & CANADA
	Protected by Nickel plated to avoid oxidation		NEMA marking
	Stainless steel body		CE marking
	Galvanized Steel body		UKCA marking
	Nitrile-butadiene material		Meets the requirements for fire testing of materials and components for trains EN 45545-2:2015
	Polyvinylchloride material		Halogen Free
	EPDM rubber material		
	ABS material		
	Operating temperature range		
	Degree of protection		



range overview

cable glands and accessories

MAXIblock®



POLYAMIDE CABLE GLANDS WITH PROTECTION IP 68

spiralblock®



POLYAMIDE CABLE GLANDS WITH PROTECTION IP 68

MAXIbrass®



NICKEL PLATED BRASS CABLE GLANDS WITH PROTECTION IP 68

MAXIinox

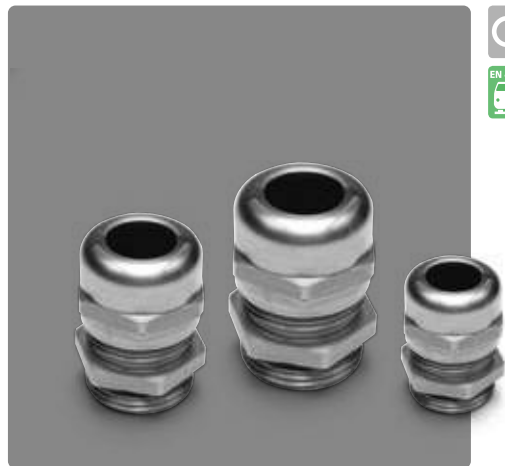

STAINLESS STEEL CABLE GLANDS WITH PROTECTION IP 68

1900

MAXIBLOCK CABLE GLANDS

Polyamide PA6.6

MAXIblock®



Material: POLYAMIDE PA6.6
 self-extinguishing class V2 (UL 94)
 Temperature range:
 -40°C to +100°C (static)
 -20°C to +90°C (dynamic)
 Sealing ring: NEOPRENE®
 External additional sealing ring
 for sizes from M32 to M63
 Protection: IP 68; IP 66
 Colour: RAL 7035 light grey,
 RAL 9005 black, RAL 7001 dark grey

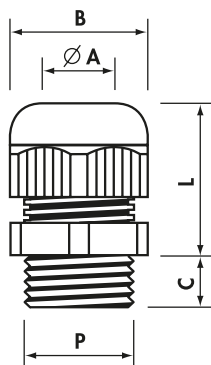

standard

Metric thread M 1.5 pitch CEI EN 60423 CEI EN 62444

Type Light Grey	P	Fixing Hole Ø (mm)	Ø A min-max (mm)	B Spanner (mm)	C (mm)	L min-max (mm)	Quantity
1900.M12	M12x1,5	12,2	3,5- 7	15	8	18-22	100
1900.M16	M16x1,5	16,2	5 -10	19	8	22-27	100
1900.M20	M20x1,5	20,5	7 -13	25	9	24-30	100
1900.M25	M25x1,5	25,4	10 -17	30	10	28-39	50
1900.M32	M32x1,5	32,5	13 -21	36	10	33-44	25
1900.M40	M40x1,5	40,5	19 -28	46	10	36-45	15
1900.M50	M50x1,5	50,5	27 -35	55	12	43-52	10
1900.M63	M63x1,5	64,0	34 -45	66	12	45-55	5

Add to Ref: N for Black, G for Dark Grey

extended cable entry

Metric thread M 1.5 pitch CEI EN 60423 CEI EN 62444

Type Light Grey	P	Fixing Hole Ø (mm)	Ø A min-max (mm)	B Spanner (mm)	C (mm)	L min-max (mm)	Quantity
1940.M20	M20x1,5	20,5	10 -14	27	10	26-31	50
1940.M25	M25x1,5	25,5	13 -18	33	11	30-35	50
1940.M32	M32x1,5	32,5	20 -25	42	12	33-39	25
1940E.M40	M40x1,5	40,5	22 -32	53	14	42-49	10
1941E.M40	M40x1,5	40,5	22 -32	53	18	42-49	10
1940.M40	M40x1,5	40,5	26 -34	53	14	42-49	10
1941.M40	M40x1,5	40,5	26 -34	53	18	42-49	10
1940.M50	M50x1,5	50,5	30 -38	60	14	42-50	5
1940E.M50	M50x1,5	50,5	35 -41	66	14	45-55	5
1940.M63	M63x1,5	64,0	45 -52	75	15	52-60	4

Add to Ref: N for Black

Comparative table of clamping range of plastic cable glands available on page. 396

MAXIBLOCK CABLE GLANDS

Polyamide PA6.6

MAXIblock[®]

1900



reduced cable entry

Metric thread M 1.5 pitch CEI EN 60423 CEI EN 62444

Type Light Grey	P	Fixing Hole Ø (mm)	Ø A min-max (mm)	B Spanner (mm)	C (mm)	L min-max (mm)	Quantity
1910.M12	M12x1,5	12,2	2- 5	15	8	18-22	100
1910.M16	M16x1,5	16,2	3- 7	19	8	22-27	100
1910.M20	M20x1,5	20,5	5-10	25	9	24-30	100
1910.M25	M25x1,5	25,4	7-13	30	10	28-39	50
1910.M32	M32x1,5	32,5	8-14	36	10	33-44	25
1910.M40	M40x1,5	40,5	15-23	46	10	36-45	15
1910.M50	M50x1,5	50,5	20-29	55	12	43-52	10
1910.M63	M63x1,5	64,0	27-39	66	12	45-55	5

Add to Ref: N for Black, G for Dark Grey

extended thread

Metric thread M 1.5 pitch CEI EN 60423 CEI EN 62444

Type Light Grey	P	Fixing Hole Ø (mm)	Ø A min-max (mm)	B Spanner (mm)	C (mm)	L min-max (mm)	Quantity
1901.M12	M12x1,5	12,2	3,5- 7	15	15	18-22	100
1901.M16	M16x1,5	16,2	5 -10	19	15	22-27	100
1901.M20	M20x1,5	20,5	7 -13	25	15	24-30	50
1901.M25	M25x1,5	25,4	10 -17	30	15	30-41	50
1901.M32	M32x1,5	32,5	13 -21	36	15	33-44	25
1901.M40	M40x1,5	40,5	19 -28	46	18	36-45	15
1901.M50	M50x1,5	50,5	27 -35	55	18	43-52	10
1901.M63	M63x1,5	64,0	34 -45	66	18	45-55	5

Add to Ref: N for Black, G for Dark Grey

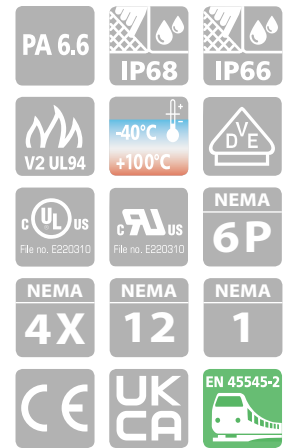

Material: POLYAMIDE PA6.6
self-extinguishing class V2 (UL 94)
Temperature range:
-40°C to +100°C (static)
-20°C to +90°C (dynamic)
Sealing ring: NEOPRENE®
External additional sealing ring
for sizes from M32 to M63
Protection: IP 68; IP 66
Colour: RAL 7035 light grey,
RAL 9005 black, RAL 7001 dark grey

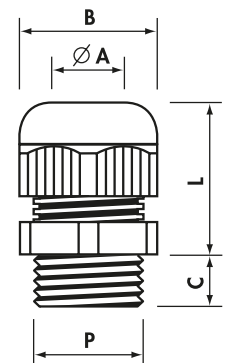

1900

MAXIBLOCK CABLE GLANDS

Polyamide PA6.6

MAXIblock[®]



Material: POLYAMIDE PA6.6
 self-extinguishing class V2 (UL 94)
 Temperature range:
 -40°C to +100°C (static)
 -20°C to +90°C (dynamic)
 Sealing ring: NEOPRENE®
 External additional sealing ring
 for sizes from Pg21 to Pg48
 Protection: IP 68; IP 66
 Colour: RAL 7035 light grey,
 RAL 9005 black, RAL 7001 dark grey

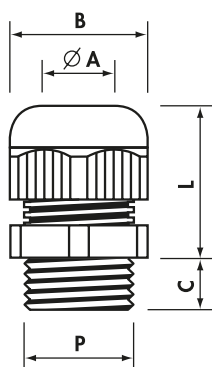

standard

Pg thread DIN 40 430

Type Light Grey	P	Fixing Hole Ø (mm)	Ø A min-max (mm)	B Spanner (mm)	C (mm)	L min-max (mm)	Quantity
1900.07	Pg 7	12,7	3,5- 7	15	8	18-22	100
1900.09	Pg 9	15,5	5 - 8	19	8	22-26	100
1900.11	Pg11	18,8	5 -10	22	8	23-28	100
1900.13	Pg13,5	20,5	7 -12	24	9	24-29	100
1900.16	Pg16	22,6	10 -14	27	10	26-31	50
1900.21	Pg21	28,5	13 -18	33	12	30-35	50
1900.29	Pg29	37,2	18 -25	42	12	33-39	25
1900.36	Pg36	47,2	20 -32	53	14	42-49	10
1900.42	Pg42	54,2	28 -38	60	14	42-50	5
1900.48	Pg48	60,0	37 -45	66	15	45-55	5

Add to Ref: N for Black, G for Dark Grey

reduced cable entry

Pg thread DIN 40 430

Type Light Grey	P	Fixing Hole Ø (mm)	Ø A min-max (mm)	B Spanner (mm)	C (mm)	L min-max (mm)	Quantity
1910.07	Pg 7	12,7	2- 5	15	8	18-22	100
1910.09*	Pg 9	15,5	2- 6	19	8	22-26	100
1910.11	Pg11	18,8	4- 7	22	8	23-28	100
1910.13	Pg13,5	20,5	5-10	24	9	24-29	100
1910.16*	Pg16	22,6	6-12	27	10	26-31	50
1910.21	Pg21	28,5	9-15	33	12	30-35	50
1910.29*	Pg29	37,2	12-20	42	12	33-39	25
1910.36	Pg36	47,2	18-26	53	14	42-49	10
1910.42	Pg42	54,2	25-31	60	14	42-50	5
1910.48*	Pg48	60,0	27-39	66	15	45-55	5

Add to Ref: N for Black

*Not UL approved

MAXIBLOCK CABLE GLANDS

Polyamide PA6.6

MAXIblock[®]

extended thread

Pg thread DIN 40 430

Type Light Grey	P	Fixing Hole Ø (mm)	Ø A min-max (mm)	B Spanner (mm)	C (mm)	L min-max (mm)	Quantity
1901.07	Pg 7	12,7	3,5- 7	15	15	18-22	100
1901.09	Pg 9	15,5	5 - 8	19	15	22-26	100
1901.11	Pg11	18,8	5 -10	22	15	23-28	100
1901.13	Pg13,5	20,5	7 -12	24	15	24-29	100
1901.16	Pg16	22,6	10 -14	27	15	26-31	50
1901.21	Pg21	28,5	13 -18	33	15	30-35	50
1901.29	Pg29	37,2	18 -25	42	15	33-39	25
1901.36	Pg36	47,2	20 -32	53	18	42-49	10
1901.42	Pg42	54,2	28 -38	60	18	42-50	5
1901.48	Pg48	60,0	37 -45	66	18	45-55	5

Add to Ref: N for Black

Material: POLYAMIDE PA6.6
self-extinguishing class V2 (UL 94)
Temperature range:
-40°C to +100°C (static)
-20°C to +90°C (dynamic)
Sealing ring: NEOPRENE®
External additional sealing ring
for sizes from Pg21 to Pg48
Protection: IP 68; IP 66
Colour: RAL 7035 light grey,
RAL 9005 black, RAL 7001 dark grey

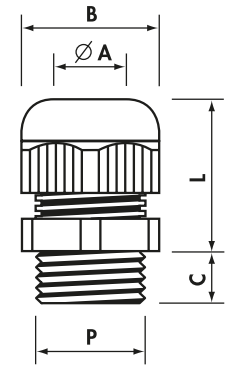

1900

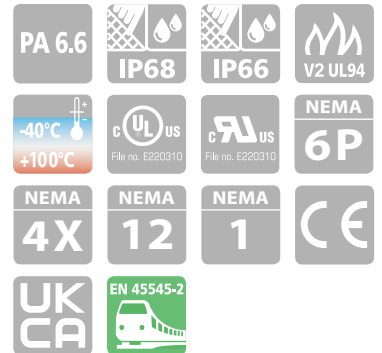

MAXIBLOCK CABLE GLANDS

Polyamide PA6.6

BSP thread ISO 228/1

Type Light Grey	P	Fixing Hole Ø (mm)	Ø A min-max (mm)	B Spanner (mm)	C (mm)	L min-max (mm)	Quantity
1900.14	G1/4"	13,5	3- 6,5	15	8	18-22	100
1900.38	G3/8"	17,0	4- 8	19	8	22-26	100
1900.12	G1/2"	21,5	7-12	24	10	24-29	100
1900.34	G3/4"	27,0	13-18	33	12	30-35	50

Add to Ref: N for Black

Material: POLYAMIDE PA6.6
self-extinguishing class V2 (UL 94)
Temperature range:
-40°C to +100°C (static)
-20°C to +90°C (dynamic)
Sealing ring: NEOPRENE®
Protection: IP 68; IP 66
Colour: RAL 7035 light grey,
RAL 9005 black



1900

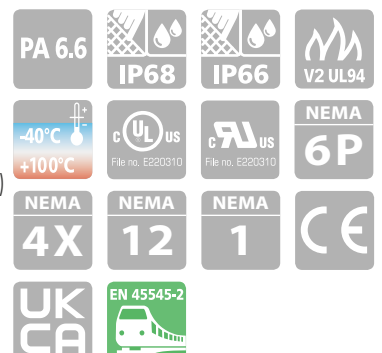

1900/X



MAXIBLOCK CABLE GLANDS

Polyamide PA6.6

Material: POLYAMIDE PA6.6
self-extinguishing class V2 (UL 94)
Temperature range:
-40°C to +100°C (static)
-20°C to +90°C (dynamic)
Sealing ring: NEOPRENE®

External additional sealing ring
for sizes from M32 to M63 and
for sizes from Pg21 to Pg48
Protection: IP 68; IP 66
Colour: RAL 7035 light grey

MAXIBlock®



standard, factory fitted with locknuts with collar

Metric thread M 1.5 pitch CEI EN 60423 CEI EN 62444

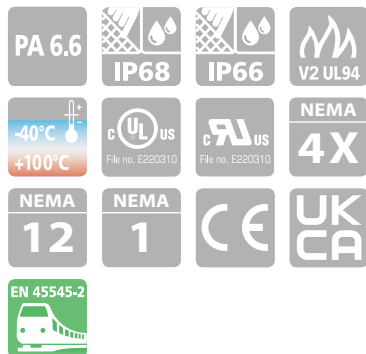

Type	P	Fixing Hole Ø (mm)	Ø A min-max (mm)	B Spanner (mm)	C (mm)	L min-max (mm)	Quantity Box/Bag
1900.M12/X	M12x1,5	12,2	3,5- 7	15	8	18-22	100/10
1900.M16/X	M16x1,5	16,2	5 -10	19	8	22-27	50/10
1900.M20/X	M20x1,5	20,5	7 -13	25	9	24-30	50/10
1900.M25/X	M25x1,5	25,4	10 -17	30	10	28-39	30/10
1900.M32/X	M32x1,5	32,5	13 -21	36	10	33-44	20/10
1900.M40/X	M40x1,5	40,5	19 -28	46	10	36-45	10/5
1900.M50/X	M50x1,5	50,5	27 -35	55	12	43-52	5/5
1900.M63/X	M63x1,5	64,0	34 -45	66	12	45-55	5/5

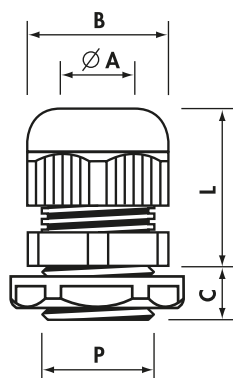

Pg thread DIN 40 430

Type	P	Fixing Hole Ø (mm)	Ø A min-max (mm)	B Spanner (mm)	C (mm)	L min-max (mm)	Quantity Box/Bag
1900.07/X	Pg 7	12,7	3,5- 7	15	8	18-22	100/10
1900.09/X	Pg 9	15,5	5 - 8	19	8	22-26	100/10
1900.11/X	Pg11	18,8	5 -10	22	8	23-28	50/10
1900.13/X	Pg13,5	20,5	7 -12	24	9	24-29	50/10
1900.16/X	Pg16	22,6	10 -14	27	10	26-31	30/10
1900.21/X	Pg21	28,5	13 -18	33	12	30-35	20/10
1900.29/X	Pg29	37,2	18 -25	42	12	33-39	20/10
1900.36/X	Pg36	47,2	20 -32	53	14	42-49	10/5
1900.42/X	Pg42	54,2	28 -38	60	14	42-50	5/5
1900.48/X	Pg48	60,0	37 -45	66	15	45-55	5/5

1951R.M25N

MAXIBLOCK CABLE GLANDS

Polyamide PA6.6



Material: POLYAMIDE PA6.6
self-extinguishing class V2 (UL 94)
Temperature range:
-40°C to +100°C (static)
-20°C to +90°C (dynamic)

Sealing ring "open": NEOPRENE®
Protection: IP 68
Colour: RAL 9005 black

MAXIBlock®

Metric thread M 1.5 pitch CEI EN 60423 CEI EN 62444

Type	P	Fixing Hole Ø (mm)	Ø A min-max (mm)	Ø a min-max (mm)	B Spanner (mm)	C (mm)	L min-max (mm)	Quantity Box/Bag
1901R.M25N	M25x1,5	25,4	17,2	6	30	15	30-41	50

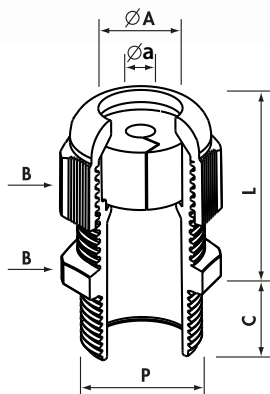

Sealing ring "open"

MAXIBLOCK CABLE GLANDS

Polyamide PA6.6

MAXIblock®

1900DP



standard, factory fitted with Polyethylene foam dustproof discs

Metric thread M 1.5 pitch CEI EN 60423 CEI EN 62444

Type	P	Fixing Hole Ø (mm)	Ø A min-max (mm)	B Spanner (mm)	C (mm)	L min-max (mm)	Quantity
1900DP.M12	M12x1,5	12,2	3,5- 7	15	8	18-22	100
1900DP.M16	M16x1,5	16,2	5 -10	19	8	22-27	100
1900DP.M20	M20x1,5	20,5	7 -13	25	9	24-30	100
1900DP.M25	M25x1,5	25,4	10 -17	30	10	28-39	50
1900DP.M32	M32x1,5	32,5	13 -21	36	10	33-44	25
1900DP.M40	M40x1,5	40,5	19 -28	46	10	36-45	15
1900DP.M50	M50x1,5	50,5	27 -35	55	12	43-52	10
1900DP.M63	M63x1,5	64,0	34 -45	66	12	45-55	5



Material: POLYAMIDE PA6.6
self-extinguishing class V2 (UL 94)
Temperature range:
-40°C to +100°C (static)
-20°C to +90°C (dynamic)
Sealing ring: NEOPRENE®
External additional sealing ring
for sizes from M32 to M63 and
for sizes from Pg21 to Pg48
Protection: IP 68
Colour: RAL 7035 light grey
Dustproof discs: 2 mm thick
Polyethylene foam

Pg thread DIN 40 430

Type	P	Fixing Hole Ø (mm)	Ø A min-max (mm)	B Spanner (mm)	C (mm)	L min-max (mm)	Quantity
1900DP.07	Pg 7	12,7	3,5- 7	15	8	18-22	100
1900DP.09	Pg 9	15,5	5 - 8	19	8	22-26	100
1900DP.11	Pg11	18,8	5 -10	22	8	23-28	100
1900DP.13	Pg13,5	20,5	7 -12	24	9	24-29	100
1900DP.16	Pg16	22,6	10 -14	27	10	26-31	50
1900DP.21	Pg21	28,5	13 -18	33	12	30-35	50
1900DP.29	Pg29	37,2	18 -25	42	12	33-39	25
1900DP.36	Pg36	47,2	20 -32	53	14	42-49	10
1900DP.42	Pg42	54,2	28 -38	60	14	42-50	5
1900DP.48	Pg48	60,0	37 -45	66	15	45-55	5

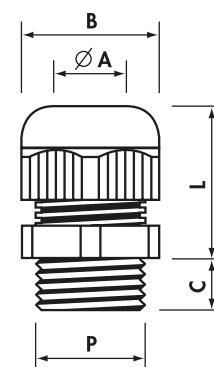

extended cable entry
factory fitted with Polyethylene foam dustproof discs

NEW

Passo METRICO M 1,5 CEI EN 60423 CEI EN 62444

Tipo Grigio Chiaro	P	Foro Fissaggio (mm)	Ø A mini-max (mm)	B Chiave (mm)	C (mm)	L mini-max (mm)	Imballo standard/minimo
1940SDP.M20	M20x1,5	20,5	6 -12	27	10	26-31	50
1940DP.M25	M25x1,5	25,5	13 -18	33	11	30-35	50
1940DP.M32	M32x1,5	32,5	20 -25	42	12	33-39	25
1940EDP.M40	M40x1,5	40,5	22 -32	53	14	42-49	10
1940DP.M50	M50x1,5	50,5	30 -38	60	14	42-50	5

1500

SPIRALBLOCK CABLE GLANDS

Polyamide PA6.6

spiralblock®



Metric thread M 1.5 pitch CEI EN 60423 CEI EN 62444

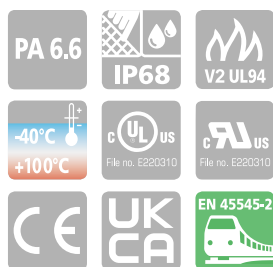

Material: POLYAMIDE PA6.6
self-extinguishing class V2 (UL 94)
Temperature range:
-40°C to +100°C (static)
-20°C to +90°C (dynamic)
Sealing ring: NEOPRENE®
External additional sealing ring
for sizes M32 and Pg21
Protection: IP 68
Colour: RAL 7035 light grey,
RAL 9005 black

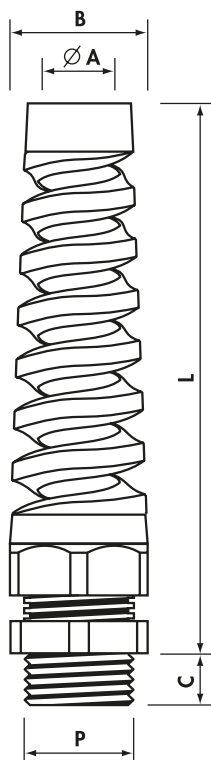

Type Light Grey	P	Fixing Hole Ø (mm)	Ø A min-max (mm)	B Spanner (mm)	C (mm)	L max (mm)	Quantity
1500.M12	M12x1,5	12,2	3,5- 7	15	8	57	100
1500.M16	M16x1,5	16,2	5 -10	19	8	79	50
1500.M20	M20x1,5	20,5	7 -13	25	9	90	25
1500.M25	M25x1,5	25,4	10 -17	30	10	120	20
1500.M32	M32x1,5	32,5	13 -21	36	10	140	10

Add to Ref: N for Black

Pg thread DIN 40 430

Type Light Grey	P	Fixing Hole Ø (mm)	Ø A min-max (mm)	B Spanner (mm)	C (mm)	L max (mm)	Quantity
1500.07	Pg 7	12,7	3,5- 7	15	8	57	100
1500.09	Pg 9	15,5	5 - 8	19	8	68	100
1500.11	Pg11	18,8	5 -10	22	8	80	50
1500.13	Pg13,5	20,5	7 -12	24	10	90	50
1500.16	Pg16	22,6	10 -14	27	10	100	25
1500.21	Pg21	28,5	13 -18	33	12	112	20

Add to Ref: N for Black

BSP thread ISO 228/1

Type Light Grey	P	Fixing Hole Ø (mm)	Ø A min-max (mm)	B Spanner (mm)	C (mm)	L max (mm)	Quantity
1500.14	G1/4"	13,5	3- 6,5	15	8	57	100
1500.38	G3/8"	17,0	4- 8	19	9	68	100
1500.12	G1/2"	21,5	7-12	24	10	90	50
1500.34	G3/4"	27,0	13-18	33	12	112	20

Add to Ref: N for Black

MAXIBLOCK ATEX and UKEX CABLE GLANDS

4900

Polyamide PA6.6

MAXIblock®

Metric thread M 1.5 pitch CEI EN 60423 CEI EN 62444



Type Light Grey	P	Fixing Hole Ø (mm)	Ø A min-max (mm)	B Spanner (mm)	C (mm)	L min-max (mm)	Quantity
4900.M12	M12x1,5	12,2	3,5- 6,5	15	8	18-22	100
4900.M16	M16x1,5	16,2	6,5-10	19	8	22-27	100
4900.M20	M20x1,5	20,5	9 -13	25	9	24-30	100
4900.M25	M25x1,5	25,4	11 -17	30	10	28-39	50
4900.M32	M32x1,5	32,5	16 -21	36	10	33-44	25
4900.M40	M40x1,5	40,5	21 -28	46	10	36-45	15
4900.M50	M50x1,5	50,5	27 -35	55	12	43-52	10
4900.M63	M63x1,5	64,0	35 -42	66	12	45-55	5

extended thread

Type Light Grey	P	Fixing Hole Ø (mm)	Ø A min-max (mm)	B Spanner (mm)	C (mm)	L min-max (mm)	Quantity
4901.M12	M12x1,5	12,2	3,5- 6,5	15	15	18-22	100
4901.M16	M16x1,5	16,2	6,5-10	19	15	22-27	100
4901.M20	M20x1,5	20,5	9 -13	25	15	24-30	50
4901.M25	M25x1,5	25,4	11 -17	30	15	30-41	50
4901.M32	M32x1,5	32,5	16 -21	36	15	33-44	25
4901.M40	M40x1,5	40,5	21 -28	46	18	36-45	15
4901.M50	M50x1,5	50,5	27 -35	55	18	43-52	10
4901.M63	M63x1,5	64,0	35 -42	66	18	45-55	5

Pg thread DIN 40 430

Type Light Grey	P	Fixing Hole Ø (mm)	Ø A min-max (mm)	B Spanner (mm)	C (mm)	L min-max (mm)	Quantity
4900.07	Pg 7	12,7	3,5- 6,5	15	8	18-22	100
4900.09	Pg 9	15,5	6,5- 8	19	8	22-26	100
4900.11	Pg11	18,8	8 -10	22	8	23-28	100
4900.13	Pg13,5	20,5	9 -12	24	9	24-29	100
4900.16	Pg16	22,6	10 -14	27	10	26-31	50
4900.21	Pg21	28,5	14 -18	33	12	30-35	50
4900.29	Pg29	37,2	18 -22	42	12	33-39	25
4900.36	Pg36	47,2	22 -32	53	14	42-49	10
4900.42	Pg42	54,2	28 -38	60	14	42-50	5
4900.48	Pg48	60,0	38 -45	66	15	45-55	5

extended thread

Type Light Grey	P	Fixing Hole Ø (mm)	Ø A min-max (mm)	B Spanner (mm)	C (mm)	L min-max (mm)	Quantity
4901.07	Pg 7	12,7	3,5- 6,5	15	15	18-22	100
4901.09	Pg 9	15,5	6,5- 8	19	15	22-26	100
4901.11	Pg11	18,8	8 -10	22	15	23-28	100
4901.13	Pg13,5	20,5	9 -12	24	15	24-29	100
4901.16	Pg16	22,6	10 -14	27	15	26-31	50
4901.21	Pg21	28,5	14 -18	33	15	30-35	50
4901.29	Pg29	37,2	18 -22	42	15	33-39	25
4901.36	Pg36	47,2	22 -32	53	18	42-49	10
4901.42	Pg42	54,2	28 -38	60	18	42-50	5
4901.48	Pg48	60,0	38 -45	66	18	45-55	5

UK CA 1001 CE 001 Ex II 2 GD

Certificate No IMQ 10 ATEX 028 X
Certificate No EMA 21 UKEX 0084 X

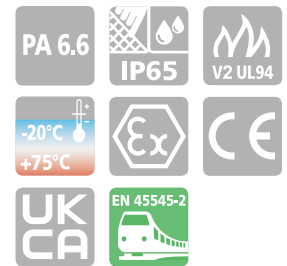

Material: POLYAMIDE PA6.6
self-extinguishing class V2 (UL 94)

Safety level:
Ex eb IIC Gb/Ex tb IIC Db

according to:
EN 60079-0
EN 60079-7
EN 60079-7/A1
EN 60079-31

Areas of utilisation: 1 & 2, 21 & 22
The certification is maintained with and without the aid of the 1143-1142 series locknuts

Temperature range:
-20°C to +75°C (dynamic)
Sealing ring: NEOPRENE®
External additional sealing ring
for sizes from M32 to M63 and
for sizes from Pg21 to Pg48
Protection: IP 65
Colour: RAL 7035 light grey

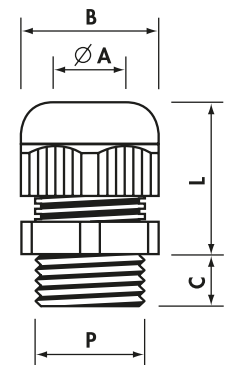

1700 1400

COMPRESSION CABLE GLANDS

Polyamide PA6



Pg thread DIN 40 430 - Dimensions DIN 46 320

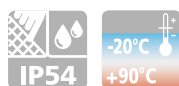

Material: POLYAMIDE PA6 / PA6.6**
self-extinguishing class V0 / V2** (UL 94)
Temperature range:
-20°C to +90°C (dynamic)
Sealing ring: PVC 50 sh A
Protection: IP 54
Colour: RAL 7035 light grey,
RAL 9005 black

Type Light Grey	P	Fixing Hole Ø (mm)	Ø A min-max (mm)	B1 Spanner Head (mm)	B2 Spanner Body (mm)	C (mm)	L min-max (mm)	Quantity Box/Bag
1709	Pg 7	12,7	5,5- 7	15	16	8	16-20	300/100
*1700	Pg 9	15,5	6,5- 8,5	17	20	8	19-22	200/100
*1701	Pg11	18,8	8 -10	19	22	8	21-25	100/100
*1702**	Pg13,5	20,5	8 -11	21	24	9	22-26	100/100
1703	Pg16	22,6	11 -14	23	27	10	24-33	50/50
1704	Pg21	28,5	14,5-18	30	33	11	25-32	50/25
1705	Pg29	37,2	19 -26	40	42	11	27-32	20/10
1706	Pg36	47,2	30 -34	50	53	14	33-42	10/10
1707	Pg42	54,2	30 -38	55	60	13	37-48	5/5
1708	Pg48	60,0	38 -44	60	65	14,5	37-48	5/5

*Add to Ref: N for Black

BSP thread ISO 228/1

Type Light Grey	P	Fixing Hole Ø (mm)	Ø A min-max (mm)	B1 Spanner Head (mm)	B2 Spanner Body (mm)	C (mm)	L min-max (mm)	Quantity Box/Bag
1400	G1/4"	13,5	5,5- 7	15	16	8	16-20	300/100
*1401	G3/8"	17,0	6,5- 8,5	17	20	8	19-22	200/100
*1401B	G3/8"	17,0	8 -10	19	22	8	18-24	100/100
*1402**	G1/2"	21,5	8 -11	21	24	9	22-26	100/100
1403	G5/8"	23,5	11 -14	23	27	10	24-33	50/50
1404	G3/4"	27,0	14,5-18	30	33	11	25-32	50/25
1405	G1"	34,0	17 -22	34	38	11,5	27-35	20/10
1407	G1*1/2	48,0	30 -34	50	53	14	33-42	10/10
1408	G2"	60,0	38 -44	60	65	14,5	37-48	5/5

*Add to Ref: N for Black

Metric thread M 1.5 pitch CEI EN 60423

Type Light Grey	P	Fixing Hole Ø (mm)	Ø A min-max (mm)	B1 Spanner Head (mm)	B2 Spanner Body (mm)	C (mm)	L min-max (mm)	Quantity
1730M20**	M20x1,5	20,5	8-11	21	24	9	22-26	100

Add to Ref: N for Black

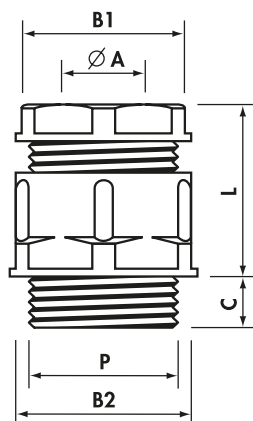

COMPRESSION CABLE GLANDS

Polyamide PA6

1700T



special Internal blanking disc: PVC 50 sh

Pg thread DIN 40 430 - Dimensions DIN 46 320

Type Light Grey	P	Fixing Hole Ø (mm)	Ø A min-max (mm)	B1 Spanner Head (mm)	B2 Spanner Body (mm)	C (mm)	L min-max (mm)	Quantity Box/Bag
*1700T	Pg 9	15,5	6,5- 8,5	17	20	8	19-22	200/100
*1701T	Pg11	18,8	8 -10	19	22	8	21-25	100/100
1702T**	Pg13,5	20,5	8 -11	21	24	9	22-26	100/100

*Add to Ref: N for Black

reduced cable entry

Sealing ring: CHLOROPRENE, concentric, multi-sector

Pg thread DIN 40 430 - Dimensions DIN 46 320

Type Light Grey	P	Fixing Hole Ø (mm)	Ø A min-max (mm)	B1 Spanner Head (mm)	B2 Spanner Body (mm)	C (mm)	L min-max (mm)	Quantity
1702CONC**	Pg13,5	20,5	5,5-13	21	24	9	22-26	100

Add to Ref: N for Black

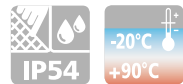

Material: POLYAMIDE PA6 / PA6.6**
self-extinguishing class V0 / V2** (UL 94)
Temperature range:
-20°C to +90°C (dynamic)
Protection: IP 54
Colour: RAL 7035 light grey,
RAL 9005 black

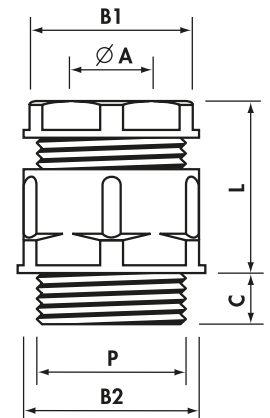

2900

MAXIBRASS CABLE GLANDS

Nickel Plated Brass

MAXIbrass®



Material: NICKEL PLATED BRASS
(CuZn 40 Pb 3)
Sealing-ring: NEOPRENE®
Cable grip insert: POLYAMIDE PA6.6
O-Ring: NITRILE 70 sh A (factory fitted)
Protection: IP 68; IP 66
Temperature range:
-40°C to +100°C (static)
-25°C to +100°C (dynamic)

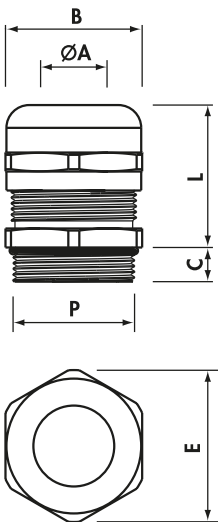

standard

Metric thread M 1.5 pitch CEI EN 60423 CEI EN 62444

Type Nickel Plated Brass	P	Fixing Hole Ø (mm)	Ø A min-max (mm)	B Spanner (mm)	E (mm)	C (mm)	L min-max (mm)	Quantity
2900.M12N	M12x1,5	12,2	3 - 7	16	18	6,5	16-20	100
2900.M16N	M16x1,5	16,2	4,5-10	20	23	7,0	20-25	100
2900.M20N	M20x1,5	20,5	7 -13	24	27	8,0	20-27	50
2900.M25N	M25x1,5	25,4	10 -17	29	32	8,0	24-30	50
2900.M32N	M32x1,5	32,5	11 -21	36	39	9,0	27-34	25
2900.M40N	M40x1,5	40,5	19 -28	45	50	9,0	34-42	10
2900.M50N	M50x1,5	50,5	26 -35	54	60	10,0	35-43	8
2900.M63N	M63x1,5	64,0	34 -45	67	73	15,0	40-52	5
2900.M75N	M75x1,5	76,0	56 -63	80	88	18,0	35-43	3/1

extended cable entry

Metric thread M 1.5 pitch CEI EN 60423 CEI EN 62444

Type Nickel Plated Brass	P	Fixing Hole Ø (mm)	Ø A min-max (mm)	B Spanner (mm)	E (mm)	C (mm)	L min-max (mm)	Quantity
2940.M12N	M12x1,5	12,2	5 - 8	17	19	6,5	17-23	100
2940.M16N	M16x1,5	16,2	7 -12	22	25	7,0	20-26	50
2940.M20N	M20x1,5	20,5	10 -16	29	32	10,0	24-30	50
2940.M25N	M25x1,5	25,4	13 -21	36	39	11,0	27-34	25
2940.M32N	M32x1,5	32,5	18 -25	40	43	12,0	30-37	25
2940.M40N	M40x1,5	40,5	25 -32	50	54	13,0	38-48	10
2940.M50N	M50x1,5	50,5	30 -38	57	61	13,0	39-48	5
2940E.M50N	M50x1,5	50,5	35 -45	67	73	13,0	40-52	5
2940.M63N	M63x1,5	64,0	44 -55	75	83	15,0	40-53	4

Comparative table of clamping range of brass cable glands available on page. 397

MAXIBRASS CABLE GLANDS

Nickel Plated Brass

MAXIbrass®

2900



reduced cable entry

Metric thread M 1.5 pitch CEI EN 60423 CEI EN 62444

Type Nickel Plated Brass	P	Fixing Hole Ø (mm)	Ø A min-max (mm)	B Spanner (mm)	E (mm)	C (mm)	L min-max (mm)	Quantity
2910.M12N	M12x1,5	12,2	1 - 5	16	18	6,5	16-20	100
2910.M16N	M16x1,5	16,2	2,5- 7	20	23	7,0	20-25	100
2910.M20N	M20x1,5	20,5	5 -10	24	27	8,0	20-27	50
2910.M25N	M25x1,5	25,4	6 -13	29	32	8,0	24-30	50
2910.M32N	M32x1,5	32,5	7 -14	36	39	9,0	27-34	25
2910.M40N	M40x1,5	40,5	13 -23	45	50	9,0	34-42	10
2910.M50N	M50x1,5	50,5	20 -29	54	60	10,0	35-43	8
2910.M63N	M63x1,5	64,0	27 -39	67	73	15,0	40-52	5
2910.M75N	M75x1,5	76,0	49 -57	80	88	18,0	35-43	3/1
2910E.M75N	M75x1,5	76,0	45 -51	80	88	18,0	35-43	3/1

extended thread

Metric thread M 1.5 pitch CEI EN 60423 CEI EN 62444

Type Nickel Plated Brass	P	Fixing Hole Ø (mm)	Ø A min-max (mm)	B Spanner (mm)	E (mm)	C (mm)	L min-max (mm)	Quantity
2901.M12N	M12x1,5	12,2	3 - 7	16	18	12	16-20	100
2901.M16N	M16x1,5	16,2	4,5-10	20	23	12	20-25	100
2901.M20N	M20x1,5	20,5	7 -13	24	27	12	20-27	50
2901.M25N	M25x1,5	25,4	10 -17	29	32	12	24-30	50
2901.M32N	M32x1,5	32,5	11 -21	36	39	15	27-34	25
2901.M40N	M40x1,5	40,5	19 -28	45	50	15	34-42	10
2901.M50N	M50x1,5	50,5	26 -35	54	60	15	35-43	8

extended thread and reduced cable entry

Metric thread M 1.5 pitch CEI EN 60423 CEI EN 62444

Type Nickel Plated Brass	P	Fixing Hole Ø (mm)	Ø A min-max (mm)	B Spanner (mm)	E (mm)	C (mm)	L min-max (mm)	Quantity
2911.M12N	M12x1,5	12,2	1 - 5	16	18	12	16-20	100
2911.M16N	M16x1,5	16,2	2,5- 7	20	23	12	20-25	100
2911.M20N	M20x1,5	20,5	5 -10	24	27	12	20-27	50
2911.M25N	M25x1,5	25,4	6 -13	29	32	12	24-30	50
2911.M32N	M32x1,5	32,5	7 -14	36	39	15	27-34	25
2911.M40N	M40x1,5	40,5	13 -23	45	50	15	34-42	10
2911.M50N	M50x1,5	50,5	20 -29	54	60	15	35-43	8

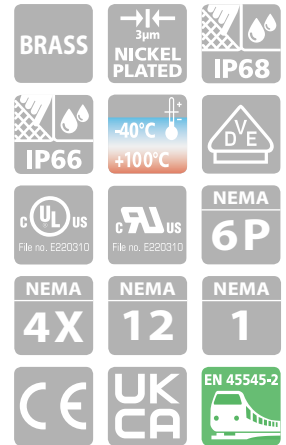

Material: NICKEL PLATED BRASS (CuZn 40 Pb 3)

Sealing-ring: NEOPRENE®

Cable grip insert: POLYAMIDE PA6.6

O-Ring: NITRILE 70 sh A (factory fitted)
 Protection: IP 68; IP 66
 Temperature range:
 -40°C to +100°C (static)
 -25°C to +100°C (dynamic)

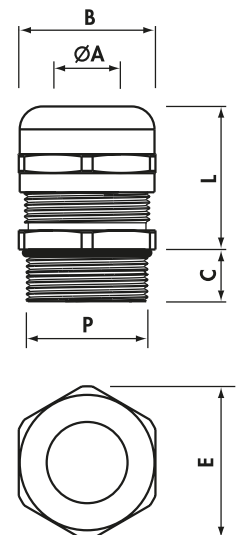



Material: NICKEL PLATED BRASS
(CuZn 40 Pb 3)
Sealing-ring: NEOPRENE®
Cable grip insert: POLYAMIDE PA6.6
O-Ring: NITRILE 70 sh A (factory fitted)
Protection: IP 68; IP 66
Temperature range:
-40°C to +100°C (static)
-25°C to +100°C (dynamic)

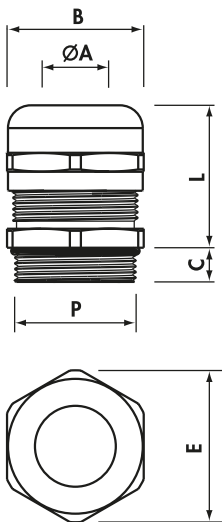

standard

Pg thread DIN 40 430

Type Nickel Plated Brass	P	Fixing Hole Ø (mm)	Ø A min-max (mm)	B Spanner (mm)	E (mm)	C (mm)	L min-max (mm)	Quantity
2900.07N	Pg 7	12,7	3 - 7	16	18	5,0	16-20	100
2900.09N	Pg 9	15,5	4 - 8	17	19	6,0	17-23	100
2900.11N	Pg11	18,8	4,5-10	20	23	6,0	20-25	100
2900.13N	Pg13,5	20,5	5 -12	22	25	6,5	20-26	50
2900.16N	Pg16	22,6	7 -13	24	27	6,5	20-27	50
2900.21N	Pg21	28,5	10 -17	30	33	7,0	24-30	50
2900.29N	Pg29	37,2	17 -25	40	43	8,0	30-37	25
2900.36N	Pg36	47,2	20 -32	50	54	8,0	38-48	10
2900.42N	Pg42	54,2	28 -38	57	63	10,0	39-48	5
2900.48N	Pg48	60,0	34 -45	67	73	15,0	40-52	5

reduced cable entry

Pg thread DIN 40 430

Type Nickel Plated Brass	P	Fixing Hole Ø (mm)	Ø A min-max (mm)	B Spanner (mm)	E (mm)	C (mm)	L min-max (mm)	Quantity
2910.07N	Pg 7	12,7	1 - 5	16	18	5,0	16-20	100
2910.09N	Pg 9	15,5	2 - 6	17	19	6,0	17-23	100
2910.11N	Pg11	18,8	2,5- 7	20	23	6,0	20-25	100
2910.13N	Pg13,5	20,5	4 -10	22	25	6,5	20-26	50
2910.16N	Pg16	22,6	5 -10	24	27	6,5	20-27	50
2910.21N	Pg21	28,5	6 -13	30	33	7,0	24-30	50
2910.29N	Pg29	37,2	11 -20	40	43	8,0	30-37	25
2910.36N	Pg36	47,2	18 -26	50	54	8,0	38-48	10
2910.42N	Pg42	54,2	24 -31	57	63	10,0	39-48	5
2910.48N	Pg48	60,0	27 -39	67	73	15,0	40-52	5

extended thread

Pg thread DIN 40 430

Type Nickel Plated Brass	P	Fixing Hole Ø (mm)	Ø A min-max (mm)	B Spanner (mm)	E (mm)	C (mm)	L min-max (mm)	Quantity
2901.07N	Pg 7	12,7	3 - 7	16	18	12	16-20	100
2901.09N	Pg 9	15,5	4 - 8	17	19	12	17-23	100
2901.11N	Pg11	18,8	4,5-10	20	23	12	20-25	100
2901.13N	Pg13,5	20,5	5 -12	22	25	12	20-26	50
2901.16N	Pg16	22,6	7 -13	24	27	12	20-27	50
2901.21N	Pg21	28,5	10 -17	30	33	12	24-30	50
2901.29N	Pg29	37,2	17 -25	40	43	15	30-37	25
2901.36N	Pg36	47,2	20 -32	50	54	15	38-48	10
2901.42N	Pg42	54,2	28 -38	57	63	15	39-48	5

MAXIBRASS CABLE GLANDS

Nickel Plated Brass

MAXIbrass®

extended thread and reduced cable entry

Pg thread DIN 40 430

Type Nickel Plated Brass	P	Fixing Hole Ø (mm)	Ø A min-max (mm)	B Spanner (mm)	E (mm)	C (mm)	L min-max (mm)	Quantity
2911.07N	Pg 7	12,7	1 - 5	16	18	12	16-20	100
2911.09N	Pg 9	15,5	2 - 6	17	19	12	17-23	100
2911.11N	Pg11	18,8	2,5- 7	20	23	12	20-25	100
2911.13N	Pg13,5	20,5	4 -10	22	25	12	20-26	50
2911.16N	Pg16	22,6	5 -10	24	27	12	20-27	100
2911.21N	Pg21	28,5	6 -13	30	33	12	24-30	50
2911.29N	Pg29	37,2	11 -20	40	43	15	30-37	25
2911.36N	Pg36	47,2	18 -26	50	54	15	38-48	10
2911.42N	Pg42	54,2	24 -31	57	63	15	39-48	5

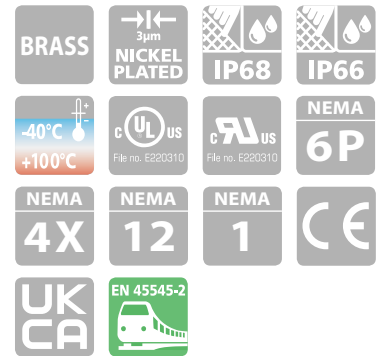

MAXIBRASS CABLE GLANDS

Nickel Plated Brass

standard, factory fitted with Polyethylene foam dustproof discs

Metric thread M 1.5 pitch CEI EN 60423 CEI EN 62444

Type Nickel Plated Brass	P	Fixing Hole Ø (mm)	Ø A min-max (mm)	B Spanner (mm)	E (mm)	C (mm)	L min-max (mm)	Quantity
2900DP.M12N	M12x1,5	12,2	3 - 7	16	18	6,5	16-20	100
2900DP.M16N	M16x1,5	16,2	4,5-10	20	23	7,0	20-25	100
2900DP.M20N	M20x1,5	20,5	7 -13	24	27	8,0	20-27	50
2900DP.M25N	M25x1,5	25,4	10 -17	29	32	8,0	24-30	50
2900DP.M32N	M32x1,5	32,5	11 -21	36	39	9,0	27-34	25
2900DP.M40N	M40x1,5	40,5	19 -28	45	50	9,0	34-42	10
2900DP.M50N	M50x1,5	50,5	26 -35	54	60	10,0	35-43	8
2900DP.M63N	M63x1,5	64,0	34 -45	67	73	15,0	40-52	5

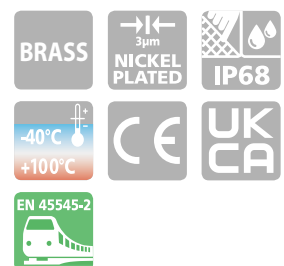

Pg thread DIN 40 430

Type Nickel Plated Brass	P	Fixing Hole Ø (mm)	Ø A min-max (mm)	B Spanner (mm)	E (mm)	C (mm)	L min-max (mm)	Quantity
2900DP.07N	Pg 7	12,7	3 - 7	16	18	5,0	16-20	100
2900DP.09N	Pg 9	15,5	4 - 8	17	19	6,0	17-23	100
2900DP.11N	Pg11	18,8	4,5-10	20	23	6,0	20-25	100
2900DP.13N	Pg13,5	20,5	5 -12	22	25	6,5	20-26	50
2900DP.16N	Pg16	22,6	7 -13	24	27	6,5	20-27	50
2900DP.21N	Pg21	28,5	10 -17	30	33	7,0	24-30	50
2900DP.29N	Pg29	37,2	17 -25	40	43	8,0	30-37	25
2900DP.36N	Pg36	47,2	20 -32	50	54	8,0	38-48	10
2900DP.42N	Pg42	54,2	28 -38	57	63	10,0	39-48	5
2900DP.48N	Pg48	60,0	34 -45	67	73	15,0	40-52	5

Material: NICKEL PLATED BRASS (CuZn 40 Pb 3)
 Sealing-ring: NEOPRENE®
 Cable grip insert: POLYAMIDE PA6.6
 O-Ring: NITRILE 70 sh A (factory fitted)
 Protection: IP 68
 Dustproof discs: 2 mm thick
 Polyethylene foam
 Temperature range:
 -40°C to +100°C (static)
 -25°C to +100°C (dynamic)

5900



MAXIBRASS ATEX and UKEX CABLE GLANDS

Nickel Plated Brass



Safety level: Ex eb IIC Gb/Ex tb IIIC Db
 according to: EN 60079-0
 EN 60079-7
 EN 60079-7/A1; EN 60079-31
 Areas of utilisation: 1 & 2, 21 & 22



Certificate No **IMQ 10 ATEX 028 X**
 Certificate No **EMA 21 UKEX 0084 X**

Metric thread M 1.5 pitch CEI EN 60423 CEI EN 62444



Material: NICKEL PLATED BRASS
 Sealing-ring: NEOPRENE®
 Cable grip insert: POLYAMIDE PA6.6
 O-Ring: NITRILE 70 sh A (factory fitted)
 Temperature range: -25°C to +75°C (dynamic)
 Protection: IP 65
The certification is maintained with and without the aid of the 2033 series locknuts

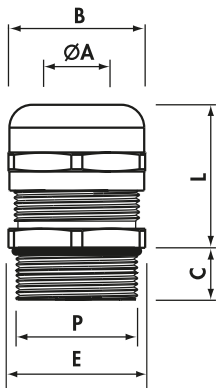

Type Nickel Plated Brass	P	Fixing Hole Ø (mm)	Ø A min-max (mm)	B Spanner (mm)	E (mm)	C (mm)	L min-max (mm)	Quantity
5900.M12N	M12x1,5	12,2	3 - 6,5	16	18	6,5	16-20	100
5900.M16N	M16x1,5	16,2	6,5 - 10	20	23	7,0	20-25	100
5900.M20N	M20x1,5	20,5	10 - 13	24	27	8,0	20-27	50
5900.M25N	M25x1,5	25,4	11 - 17	29	32	8,0	24-30	50
5900.M32N	M32x1,5	32,5	14 - 21	36	39	9,0	27-34	25
5900.M40N	M40x1,5	40,5	21 - 27	45	50	9,0	34-42	10
5900.M50N	M50x1,5	50,5	26 - 35	54	60	10,0	35-43	8
5900.M63N	M63x1,5	64,0	35 - 42	67	73	15,0	40-52	5

extended thread

Type Nickel Plated Brass	P	Fixing Hole Ø (mm)	Ø A min-max (mm)	B Spanner (mm)	E (mm)	C (mm)	L min-max (mm)	Quantity
5901.M12N	M12x1,5	12,2	3 - 6,5	16	18	12	16-20	100
5901.M16N	M16x1,5	16,2	6,5 - 10	20	23	12	20-25	100
5901.M20N	M20x1,5	20,5	10 - 13	24	27	12	20-27	50
5901.M25N	M25x1,5	25,4	11 - 17	29	32	12	24-30	50
5901.M32N	M32x1,5	32,5	14 - 21	36	39	12	27-34	25
5901.M40N	M40x1,5	40,5	21 - 27	45	50	12	34-42	10
5901.M50N	M50x1,5	50,5	26 - 35	54	60	12	35-43	8

20M3



EMC CABLE GLANDS

Nickel Plated Brass

Metric thread M 1.5 pitch CEI EN 60423 CEI EN 62444



Material: NICKEL PLATED BRASS (CuZn 40 Pb 3)
 Sealing-ring: Chloroprene (CR)
 Cable grip insert: PA6.6
 O-Ring: (NBR) (factory fitted)
 Protection: IP 68
 Temperature range:
 -40°C to +100°C (static)
 -25°C to +100°C (dynamic)

Type Nickel Plated Brass	P	Fixing Hole Ø (mm)	Ø A min-max (mm)	B Spanner (mm)	C (mm)	L max (mm)	Quantity Box/Bag
20M3M1261N*	M12x1,5	12,2	3 - 6,5	14	5,0	22,0	300/100
20M3M1661N*	M16x1,5	16,2	5,5 - 10	17	5,5	24,5	200/100
20M3M2061N	M20x1,5	20,5	8 - 13	22	6,0	27,0	100/50
20M3M2561N*	M25x1,5	25,4	11 - 18	30	7,0	31,0	50/25
20M3M3261N*	M32x1,5	32,5	15 - 21	34	8,0	33,0	30/10
20M3M4061N*	M40x1,5	40,5	19 - 27	44	8,0	40,0	20/10
20M3M5061N*	M50x1,5	50,5	26 - 35	55	9,0	48,0	10/5
20M3M6361N*	M63x1,5	64,0	39 - 48	66	10,0	50,0	5/5

*Not UL approved

EMC Cable glands and locknuts are designed to work together in electrical or electronic applications where a metallic cable shielding must be equipotential with a metallic enclosure, in accordance with the EMC directive. Offering IP68 ingress protection at 5 bar pressure, EMC Cable glands will maintain shielding from electromagnetic disturbance in underground applications. EMC locknuts have serrated teeth to maintain electrical contact through paint or surface coatings, a feature which also enhances vibration resistance.

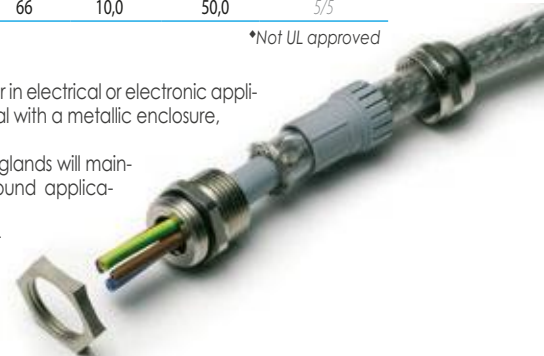

COMPRESSION CABLE GLANDS

Nickel Plated Brass

2003
2002
2001

Sealing ring: RUBBER 55sh A

Metric thread M 1.5 pitch CEI EN 60423 CEI EN 62444

Type Nickel Plated Brass	P	Fixing Hole Ø (mm)	Ø A min-max (mm)	B1 Spanner Head (mm)	B2 Spanner Body (mm)	C (mm)	L min-max (mm)	Quantity Box/Bag
2003M1221N	M12x1,5	12,2	4 - 6	13	14	5	13-16	500/100
2003M1621N	M16x1,5	16,2	8 -10	15	18	5	14-17	200/100
2003M2021N	M20x1,5	20,5	10 -12	20	22	6	16-19	150/50
2003M2521N	M25x1,5	25,4	17 -19	28	30	7	19-23	50/50
2003M3221N	M32x1,5	32,5	26 -28	37	39	8	21-25	100/50
2003M4021N	M40x1,5	40,5	33 -35	47	50	8	24-30	20/20
2003M5021N	M50x1,5	50,5	39 -41	54	57	9	28-34	10/5
2003M6321N	M63x1,5	64,0	43 -45	60	66/68	10	30-36	10/5

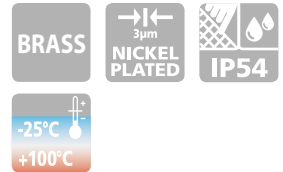

Sealing ring: RUBBER 55sh A

Pg thread DIN 40 430 - Dimensions DIN 46 320

Type Nickel Plated Brass	P	Fixing Hole Ø (mm)	Ø A min-max (mm)	B1 Spanner Head (mm)	B2 Spanner Body (mm)	C (mm)	L min-max (mm)	Quantity Box/Bag
200200721N	Pg 7	12,7	5 - 7	13	14	5	13-16	400/100
200200921N	Pg 9	15,5	8 -10	15	17	6	14-17	300/100
200201121N	Pg11	18,8	8 -10	18	20	6	14-18	200/50
200201321N	Pg13,5	20,5	10 -12	20	22	6,5	16-19	100/50
200201621N	Pg16	22,6	12 -14	22	24	6,5	17-20	50/50
200202121N	Pg21	28,5	17 -19	28	30	7	19-23	50/50
200202921N	Pg29	37,2	26 -28	37	40	8	21-25	15/15
200203621N*	Pg36	47,2	33 -35	47	50	9	24-30	10/10
200204221N	Pg42	54,2	39 -41	54	57	10	28-34	10/10
200204821N*	Pg48	60,0	43 -45	60	64	10	36-45	10/10

* Double sealing ring

Material: NICKEL PLATED BRASS (CuZn 40 Pb 3)
Protection: IP 54

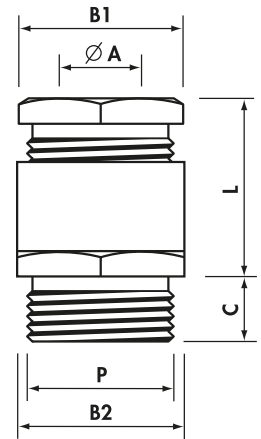

Sealing ring: PVC 50 sh A

BSP thread ISO 228/1

Type Nickel Plated Brass	P	Fixing Hole Ø (mm)	Ø A min-max (mm)	B1 Spanner Head (mm)	B2 Spanner Body (mm)	C (mm)	L min-max (mm)	Quantity Box/Bag
200101441N	G1/4"	13,5	5,5 - 7	13	15	6,5	14-17	400/100
207101441N	G1/4"	13,5	5,5 - 7	13	15**	6,5	14-17	400/100
200103841N	G3/8"	17,0	6,5 - 8,5	17	19	7,5	15-19	200/100
200101241N	G1/2"	21,5	8 -11	21	23	8	17-23	100/100
200105841N	G5/8"	23,5	11 -14	23	25	8,5	20-24	100/50
200103441N	G3/4"	27,0	14,5-17,5	27	29	9	20-26	50/50
200110041N	G1"	34,0	18 -22	34	36	10	23-28	25/25
200111841N	G1"1/8	38,0	21 -26	38	40	10,5	23-28	25/25
200111441N	G1"1/4	42,0	28 -32	42	45	11,5	25-31	20/20
200111241N	G1"1/2	48,0	32 -36	48	50	11,5	28-35	10/10
200120041N	G2"	60,0	38 -42	60	64	13,5	31-37	10/10
• 200121221N*	G2"1/2	76,0	44 -57	80	80	20	32-37	5/5
• 200130021N	G3"	89,0	67 -69	95	95	20	42-52	5/5

• Sealing ring: Chloroprene

* Concentric sealing ring

** Cylindrical body without hexagonal key

7900 7900A

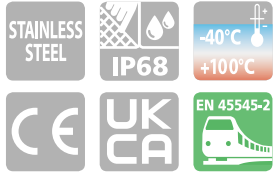

Material:
STAINLESS STEEL AISI 303/316L
Sealing-ring: NEOPRENE®
Cable grip insert: POLYAMIDE PA6.6
O-Ring: NITRILE 70 sh A
(factory fitted)
Protection: IP 68
Temperature range:
-40°C to +100°C (static)
-25°C to +100°C (dynamic)

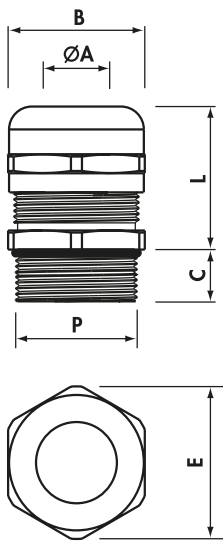

MAXINOX CABLE GLANDS

Stainless Steel AISI 303 (X8 CrNiS 18-9) - Stainless Steel AISI 316L (X2 CrNiMo 17-12-2)

MAXinox

Stainless Steel AISI 303

Metric thread M 1.5 pitch CEI EN 60423 CEI EN 62444

Stainless Steel AISI 303	P	Fixing Hole Ø (mm)	Ø A min-max (mm)	B Spanner (mm)	E (mm)	C (mm)	L min-max (mm)	Quantity Box/Bag
7900.M12	M12x1,5	12,2	3 - 7	16	18	6,5	16-20	90/30
7900.M16	M16x1,5	16,2	4,5-10	20	23	7,0	20-25	120/30
7900.M20	M20x1,5	20,5	7 -13	24	27	8,0	20-27	75/25
7900.M25	M25x1,5	25,4	10 -17	29	32	8,0	24-30	40/20
7900.M32	M32x1,5	32,5	11 -21	36	40	9,0	27-34	15
7900.M40	M40x1,5	40,5	19 -28	45	50	9,0	34-42	15
7900.M50	M50x1,5	50,5	26 -35	54	60	10,0	35-43	10
7900.M63	M63x1,5	64,0	34 -45	67	74	15,0	40-52	5

Stainless Steel AISI 316L

Metric thread M 1.5 pitch CEI EN 60423 CEI EN 62444

Stainless Steel AISI 316L	P	Fixing Hole Ø (mm)	Ø A min-max (mm)	B Spanner (mm)	E (mm)	C (mm)	L min-max (mm)	Quantity Box/Bag
7900A.M12	M12x1,5	12,2	3 - 7	16	18	6,5	16-20	60/20
7900A.M16	M16x1,5	16,2	4,5-10	20	23	7,0	20-25	80/20
7900A.M20	M20x1,5	20,5	7 -13	24	27	8,0	20-27	60/20
7900A.M25	M25x1,5	25,4	10 -17	29	32	8,0	24-30	30/15
7900A.M32	M32x1,5	32,5	11 -21	36	40	9,0	27-34	12
7900A.M40	M40x1,5	40,5	19 -28	45	50	9,0	34-42	10
7900A.M50	M50x1,5	50,5	26 -35	54	60	10,0	35-43	7
7900A.M63	M63x1,5	64,0	34 -45	67	74	15,0	40-52	5

MAXINOX CABLE GLANDS

Stainless Steel AISI 303 (X8 CrNiS 18-9) - Stainless Steel AISI 316L (X2 CrNiMo 17-12-2)

7900 7900A

MAXinox



Stainless Steel AISI 303

Pg thread DIN 40 430

Stainless Steel AISI 303	P	Fixing Hole Ø (mm)	Ø A min-max (mm)	B Spanner (mm)	E (mm)	C (mm)	L min-max (mm)	Quantity Box/Bag
7900.07	Pg 7	12,7	3 - 7	16	18	5,0	16-20	90/30
7900.09	Pg 9	15,5	4 - 8	17	19	6,0	17-23	90/30
7900.11	Pg11	18,8	4,5-10	20	23	6,0	20-25	60/30
7900.13	Pg13,5	20,5	5 -12	22	25	6,5	20-26	90/30
7900.16	Pg16	22,6	7 -13	24	27	6,5	20-27	60/30
7900.21	Pg21	28,5	10 -17	30	33	7,0	24-30	40/20
7900.29	Pg29	37,2	17 -25	40	45	8,0	30-37	30/15
7900.36	Pg36	47,2	20 -32	50	55	8,0	38-48	10
7900.42	Pg42	54,2	28 -38	57	63	10,0	36-46	5
7900.48	Pg48	60,0	34 -45	67	74	15,0	40-52	5

Material:
 STAINLESS STEEL AISI 303/316L
 Sealing-ring: NEOPRENE®
 Cable grip insert: POLYAMIDE PA6.6
 O-Ring: NITRILE 70 sh A
 (factory fitted)
 Protection: IP 68
 Temperature range:
 -40°C to +100°C (static)
 -25°C to +100°C (dynamic)

Stainless Steel AISI 316L

Pg thread DIN 40 430

Stainless Steel AISI 316L	P	Fixing Hole Ø (mm)	Ø A min-max (mm)	B Spanner (mm)	E (mm)	C (mm)	L min-max (mm)	Quantity Box/Bag
7900A.07	Pg 7	12,7	3 - 7	16	18	5,0	16-20	60/20
7900A.09	Pg 9	15,5	4 - 8	17	19	6,0	17-23	60/20
7900A.11	Pg11	18,8	4,5-10	20	23	6,0	20-25	100/20
7900A.13	Pg13,5	20,5	5 -12	22	25	6,5	20-26	100/20
7900A.16	Pg16	22,6	7 -13	24	27	6,5	20-27	40/20
7900A.21	Pg21	28,5	10 -17	30	33	7,0	24-30	60/15
7900A.29	Pg29	37,2	17 -25	40	45	8,0	30-37	20/10
7900A.36	Pg36	47,2	20 -32	50	55	8,0	38-48	7
7900A.42	Pg42	54,2	28 -38	57	63	10,0	36-46	5
7900A.48	Pg48	60,0	34 -45	67	74	15,0	40-52	5

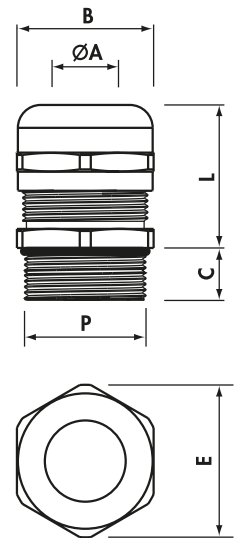

1143
1142
1141

LOCKNUTS WITH COLLAR

Polyamide PA6.6



PA 6.6



Material: POLYAMIDE PA6.6
self-extinguishing class V2 (UL 94)
Temperature range:
-40°C to +100°C (static)
-20°C to +90°C (dynamic)
Colour: RAL 7035 light grey,
RAL 9005 black,
RAL 7001 dark grey

Metric thread M 1.5 pitch CEI EN 60423

Type Light Grey	P	Ø A (mm)	B Spanner (mm)	H (mm)	Quantity Box/Bag
1143M12	M12x1,5	18,5	17	5	1.000/100
1143M16	M16x1,5	24,0	22	5	600/100
1143M20	M20x1,5	29,0	27	6	400/100
1143M25	M25x1,5	35,5	32	6	200/100
1143M32	M32x1,5	45,0	41	7	100/50
1143M40	M40x1,5	55,0	50	7	30
1143M50	M50x1,5	65,0	60	8	30
1143M63	M63x1,5	82,0	75	8	15

Add to Ref: N for Black, G for Dark Grey

Pg thread DIN 40 430 - Dimensions DIN 46 320

Type Light Grey	P	Ø A (mm)	B Spanner (mm)	H (mm)	Quantity Box/Bag
1142007	Pg 7	21	19	5	100
1142009	Pg 9	24	22	5	700/100
1142011	Pg11	26	24	5	500/100
1142013	Pg13,5	29	27	6	400/100
1142016	Pg16	33	30	6	300/100
1142021	Pg21	39	36	7	100/50
1142029	Pg29	50	46	7	50
1142036	Pg36	66	60	8	30
1142042	Pg42	73	65	8	25
1142048	Pg48	78	70	8	20

Add to Ref: N for Black, G for Dark Grey

BSP thread ISO 228/1

Type Light Grey	P	Ø A (mm)	B Spanner (mm)	H (mm)	Quantity Box/Bag
1141012	G1/2"	29	27	6	400/100
1141112	G1"1/2	66	60	8	30
1141200	G2"	78	70	8	20

Add to Ref: N for Black

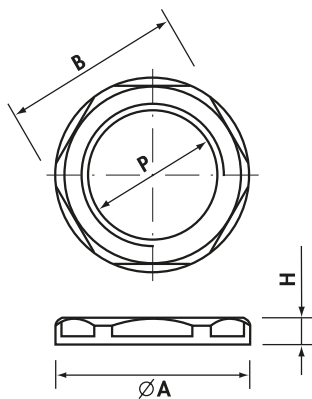

LOCKNUTS WITHOUT COLLAR

Polyamide PA6.6

1112
1710
1410



Metric thread M 1.5 pitch CEI EN 60423

Type Light Grey	P	B Spanner (mm)	H (mm)	Quantity Box/Bag
1112	M12x1,5	17	5	1.000/100
1116	M16x1,5	22	5	700/100
1120	M20x1,5	27	6	400/100
1125	M25x1,5	32	6	300/100
1132	M32x1,5	41	7	100/50
1140	M40x1,5	50	7	30
1150	M50x1,5	60	8	30
1163	M63x1,5	75	8	15

Add to Ref: N for Black



Material: POLYAMIDE PA6.6
self-extinguishing class V2 (UL 94)
Temperature range:
-40°C to +100°C (static)
-20°C to +90°C (dynamic)
Colour: RAL 7035 light grey,
RAL 9005 black

Pg thread DIN 40 430 - Dimensions DIN 46 320

Type Light Grey	P	B Spanner (mm)	H (mm)	Quantity Box/Bag
1719E17*	Pg 7	17	5	1.000/100
1719	Pg 7	19	5	100
1710	Pg 9	22	5	700/100
1711	Pg11	24	5	500/100
1712	Pg13,5	27	6	400/100
1713	Pg16	30	6	300/100
Δ1714E34*	Pg21	34	7	200/100
1714	Pg21	36	7	200/100
1715	Pg29	46	7,5	75/25

Add to Ref: N for Black

Δ Light Grey only

* Not DIN 46 320

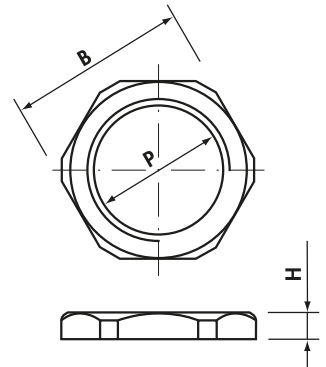

BSP thread ISO 228/1

Type Light Grey	P	B Spanner (mm)	H (mm)	Quantity Box/Bag
1410	G1/4"	19	5	800/100
1411	G3/8"	23	6	600/100
1412	G1/2"	27	6	400/100
1414	G3/4"	34	7	200/100
1415	G1"	40	7	100/50

Add to Ref: N for Black

2033
2032
2031



LOCKNUTS

Nickel Plated Brass

Metric thread M 1.5 pitch CEI EN 60423

Type Nickel Plated Brass	P	B Spanner (mm)	H (mm)	Quantity Box/Bag
2033M12N	M12x1,5	16	2,8	2.000/100
2033M16N	M16x1,5	19	2,8	1.000/100
2033M20N	M20x1,5	24	3,0	600/100
2033M25N	M25x1,5	30	4,0	300/50
2033M32N	M32x1,5	36	4,0	250/25
2033M40N	M40x1,5	45	5,0	100/10
2033M50N	M50x1,5	60	5,0	80/10
2033M63N	M63x1,5	70	5,5	50/5
2033M75N	M75x1,5	80	7,0	25/1

Pg thread DIN 40 430 - Dimensions DIN 46 320

Type Nickel Plated Brass	P	B Spanner (mm)	H (mm)	Quantity Box/Bag
2032007N	Pg 7	16*	2,8	1.500/100
2032009N	Pg 9	18	2,8	1.500/100
2032011N	Pg11	21	3,0	1.000/100
2032013N	Pg13,5	23	3,0	600/100
2032016N	Pg16	26	3,0	600/100
2032021N	Pg21	32	3,5	500/100
2032029N	Pg29	41	4,0	200/50
2032036N	Pg36	51	5,0	100/10
2032042N	Pg42	60	5,0	50/10
2032048N	Pg48	64	5,5	50/10

*Different dimension to DIN 46320

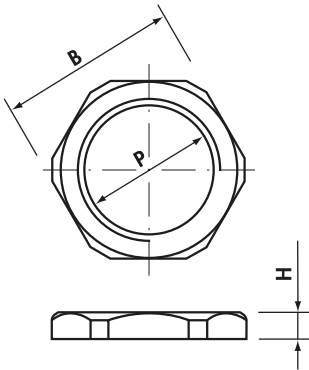

BSP thread ISO 228/1

Type Nickel Plated Brass	P	B Spanner (mm)	H (mm)	Quantity Box/Bag
2031014N	G1/4"	16	3,0	2.400/100
2031038N	G3/8"	19	3,0	1.000/100
2031012N	G1/2"	24	3,5	1.000/100
2031058N	G5/8"	26	4,0	500/50
2031034N	G3/4"	30	4,0	500/50
2031100N	G1"	37	4,0	250/25
2031118N	G1"1/8	41	4,5	100/25
2031114N	G1"1/4	45	4,5	200/20
2031112N	G1"1/2	52	5,5	100/20
2031200N	G2"	64	7,0	50/10
2031212N	G2"1/2	80	7,0	20/5
2031300N	G3"	95	8,0	20/5

EMC LOCKNUTS

Nickel Plated Brass

With serrated teeth to maintain electrical contact

Metric thread M 1.5 pitch CEI EN 60423

Type Nickel Plated Brass	P	B Spanner (mm)	H (mm)	Quantity Box/Bag
20N3M12N	M12x1,5	15	3,5	1000/100
20N3M16N	M16x1,5	19	3,5	1000/100
20N3M20N	M20x1,5	24	3,5	500/100
20N3M25N	M25x1,5	30	4,0	400/100
20N3M32N	M32x1,5	36	4,0	200/100
20N3M40N	M40x1,5	46	4,7	100/50
20N3M50N	M50x1,5	60	5,7	50/50
20N3M63N	M63x1,5	70	6,7	50/25

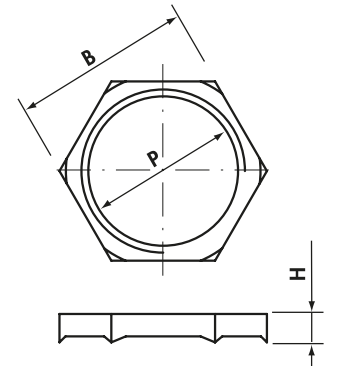

MAXIINOX LOCKNUTS

Stainless Steel AISI 303 (X8 CrNiS 18-9) - Stainless Steel AISI 316L (X2 CrNiMo 17-12-2)

Metric thread M 1.5 pitch CEI EN 60423

Stainless Steel AISI 303	Stainless Steel AISI 316L	P	B Spanner (mm)	H (mm)	AISI 303 Quantity Box/Bag	AISI 316L Quantity Box/Bag
7033M12	7033AM12	M12x1,5	16	2,8	450/30	300/20
7033M16	7033AM16	M16x1,5	20	2,8	450/30	300/20
7033M20	7033AM20	M20x1,5	24	3,5	250/25	200/20
7033M25	7033AM25	M25x1,5	29	4,0	160/20	120/15
7033M32	7033AM32	M32x1,5	36	4,0	105/15	84/12
7033M40	7033AM40	M40x1,5	45	5,0	60/15	40/10
7033M50	7033AM50	M50x1,5	57	5,0	40/10	28/7
7033M63	7033AM63	M63x1,5	70	5,5	32/8	20/5

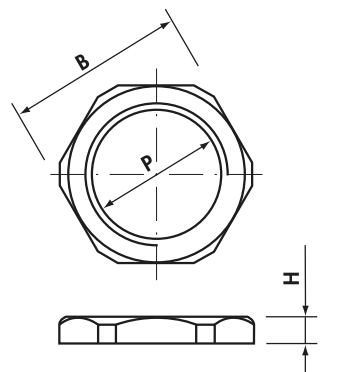

Pg thread DIN 40 430

Stainless Steel AISI 303	Stainless Steel AISI 316L	P	B Spanner (mm)	H (mm)	AISI 303 Quantity Box/Bag	AISI 316L Quantity Box/Bag
7032007	7032A007	Pg 7	16	2,8	450/30	300/20
7032009	7032A009	Pg 9	20	2,8	450/30	300/20
7032011	7032A011	Pg11	22	3,0	300/30	200/20
7032013	7032A013	Pg13,5	22	3,0	300/30	200/20
7032016	7032A016	Pg16	27	3,0	240/30	160/20
7032021	7032A021	Pg21	32	3,5	160/20	150/15
7032029	7032A029	Pg29	41	4,0	60/15	40/10
7032036	7032A036	Pg36	50	5,0	40/10	28/7
7032042	7032A042	Pg42	60	5,0	40/10	20/5
7032048	7032A048	Pg48	64	5,5	32/8	20/5



For cable glands type:

MAXIblock[®]
MAXIbrass[®]
MAXIinox

Plugs



Material: POLYAMIDE PA6.6
 self-extinguishing class V2 (UL 94)
 Temperature range:
 -40°C to +100°C (static)
 -20°C to +90°C (dynamic)
 Colour: RAL 9005 black

Application:
 Blanking the cable entry of cable glands and maintaining IP 68.

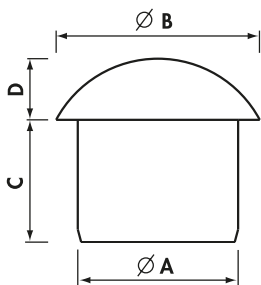

Type	Suitable for				Ø A (mm)	Ø B (mm)	C (mm)	D (mm)	Quantity Box/Bag
	MAXIblock [®]		MAXIbrass [®] MAXIinox						
	1900	1940	2900 / 7900	2940					
TCP5	M12R + Pg7R		M12R		4,5	8,5	10,8	4,5	3.000/100
TCP10	Pg9R		Pg9R		6,0	12,0	12,0	4,5	1.500/100
TCP12	M12 + Pg7		M12 + Pg7		6,8	12,0	12,0	4,5	1.000/100
	M16R + Pg11R		M16R + Pg11R						
TCP15	Pg9		Pg9	M12	8,0	11,0	11,5	5,0	1.500/100
TCP18	M16 + Pg11		M16 + Pg11		9,5	12,5	13,0	5,0	800/100
TCP20	M20R		M20R		10,0	15,0	14,0	6,0	800/100
	Pg13,5 + Pg13,5R		Pg13,5 + Pg13,5R	M16					
	Pg16R		Pg16R						
TCP25	M20 + Pg16	M20	M20 + Pg16		12,5	17,0	15,0	8,0	300/100
TCP30	M25R + M32R		M25R + M32R		12,5	22,5	18,0	9,0	300/100
	Pg21R		Pg21R						
TCP35	M25 + Pg21	M25	M25 + Pg21	M20	16,0	19,5	18,0	8,0	200/100
TCP40	M32		M32	M25	19,0	22,5	19,0	9,0	150/50
TCP45	M40R + Pg29 + Pg36R	M32	M40R + Pg29	M32	22,0	30,0	20,0	10,0	100/50
TCP50	M40 + M50R + Pg42R		M40 + M50R		27,5	38,0	25,0	12,0	50/25
TCP55	Pg36	M40 + M40E	Pg36	M40	31,5	36,5	23,5	12,0	50/25
TCP60	M50		M50		34,5	40,0	23,5	12,0	50/25
TCP65	M63R + Pg42 + Pg48R	M50 + M50E	M63R + Pg42	M50	37,5	48,0	26,5	12,0	30/15
TCP70	M63 + Pg48		M63 + Pg48	M50E	43,0	48,0	26,5	12,0	30/15

R: reduced cable entry

MULTI-ENTRY SEALS FOR CABLE GLANDS

Neoprene® 70 sh A

For cable glands type:

MAXIblock®
MAXIbrass®
MAXIinox

Material: NEOPRENE® 70 sh A
Temperature range:
-40°C to +130°C
Protection: IP 68
Colour: RAL 9005 black

Application:
IP68 sealing of multiple cables
entering cable glands.



36A
36C

Multi-entry seals

Type	Suitable for				No. entries	Ø entries (mm)	Quantity Box/Bag
	MAXIblock®		MAXIbrass® MAXIinox				
	1900	1940	2900 / 7900	2940			
36A3M1623	M16 + Pg11		M16 + Pg11		2	3,0	500/100
36A3M1624	M16 + Pg11		M16 + Pg11		2	4,0	1.000/100
36A3M16322	M16 + Pg11		M16 + Pg11		3	2,2	1.000/100
36A3M2025	M20 + Pg13,5		M20 + Pg13,5 + Pg16	M16	2	5,0	500/100
36A3M2026	M20 + Pg13,5		M20 + Pg13,5 + Pg16	M16	2	6,0	500/100
36A3M2034	M20 + Pg13,5		M20 + Pg13,5 + Pg16	M16	3	4,0	500/100
36A3M2035	M20 + Pg13,5		M20 + Pg13,5 + Pg16	M16	3	5,0	500/100
36A3M20356	M20 + Pg13,5		M20 + Pg13,5 + Pg16	M16	3	5,6	500/100
36A3M2526	M25		M25 + Pg21	M20	2	6,0	300/50
36A3M2536	M25		M25 + Pg21	M20	3	6,0	300/50
36A3M2537	M25		M25 + Pg21	M20	3	7,0	300/50
36A3M2545	M25		M25 + Pg21	M20	4	5,0	300/50
36A3M2546	M25		M25 + Pg21	M20	4	6,0	300/50
36A3M2554	M25		M25 + Pg21	M20	5	4,0	300/50
36C3M252105	M25		M25 + Pg21	M20	2	5+10,5	300/50
36A3M3228	M32		M32	M25	2	8,0	150/50
36A3M3239	M32		M32	M25	3	9,0	150/50
36A3M32465	M32		M32	M25	4	6,5	150/50
36A3M3248	M32		M32	M25	4	8,0	150/50
36A3M4078	M40		M40		7	8,0	100/100
36A3M40106	M40		M40		10	6,0	100/100
36A3M5088	M50 + Pg 36	M40 + M40E	M50 + Pg 36	M40	8	8,0	50/50



2 ENTRIES

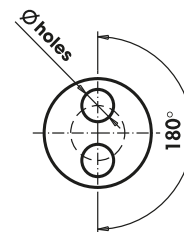

3 ENTRIES

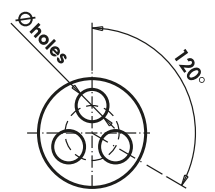

4 ENTRIES

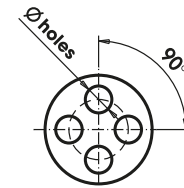

5 ENTRIES

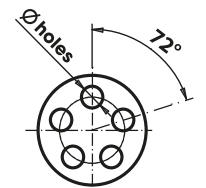

MULTI-ENTRY SEAL PLUGS FOR CABLE GLANDS

Polyamide PA6.6

Material: POLYAMIDE PA6.6
Temperature range:
-40°C to +100°C (static)
-20°C to +90°C (dynamic)
Colour: RAL 7035 light grey

Application:
Plugging unused entries in multi-entry seals and maintaining IP68.



TGM

Multi-entry seal plugs

Type	Suitable for Seal	Ø A (mm)	L (mm)	Quantity Box/Bag
TGM38	36A3M1623	3	10	5.000/100
TGM48	36A3M1624 + 36A3M2034 + 36A3M2554	4	8	5.000/100
TGM58	36A3M2025 + 36A3M2035	5	8	5.000/100
TGM513	36A3M2545	5	13	2.500/50
TGM613	36A3M2526 + 36A3M2536 + 36A3M40106 + 36A3M2546 + 36A3M2026	6	13	2.000/50
TGM713	36A3M2537	7	13	2.000/50
TGM817	36A3M3248 + 36A3M5088 + 36A3M4078 + 36A3M3228	8	17	100

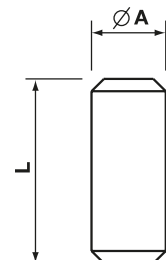

1173M 1153M

ENTRY THREAD ADAPTERS

Polyamide PA6.6



Material: POLYAMIDE PA6.6
self-extinguishing class V2 (UL 94)
Temperature range:
-40°C to +85°C (dynamic)
Protection: IP 54
Protection: IP 68 (*with the aid of FD sealing ring)
Colour: RAL 7035 light grey,
RAL 9005 black



Entry thread enlargers

Metric thread M 1.5 pitch CEI EN 60423

Type	P EXT	P INT	B Spanner (mm)	F (mm)	C (mm)	H (mm)	Quantity Box/Bag
1173M1216	M12x1,5	M16x1,5	20,0	10,5	8,0	21,0	200/100
1173M1620	M16x1,5	M20x1,5	24,0	10,5	8,0	21,0	200/100
1173M2025	M20x1,5	M25x1,5	29,0	10,0	8,0	21,0	100/50
1173M2532	M25x1,5	M32x1,5	36,0	11,5	8,0	23,0	50/50
1173M3240	M32x1,5	M40x1,5	46,0	11,5	10,0	25,0	50/50

* To achieve IP68 rating:

- for all types, a flat FD seal is required between the adapter and the wall
- an additional FD seal must also be fitted between the cable gland and the adapter on sizes M12, M16, M20 and M25. From size M32, the cable glands are already supplied with FD seals
- the IP rating is only guaranteed in combination with Maxiblock cable glands

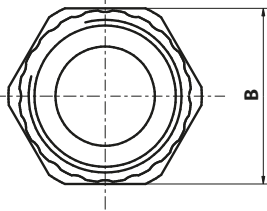
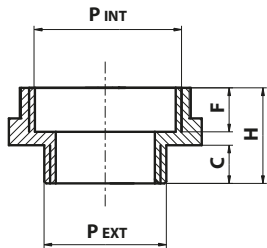

Entry thread reducers

Metric thread M 1.5 pitch CEI EN 60423

Type	P EXT	P INT	B Spanner (mm)	C (mm)	H (mm)	Quantity Box/Bag
1153M1612	M16x1,5	M12x1,5	22,0	8,0	12,0	300/100
1153M2012	M20x1,5	M12x1,5	24,0	8,0	12,0	300/100
1153M2016**	M20x1,5	M16x1,5	24,0	8,0	12,0	300/100
1153M2512	M25x1,5	M12x1,5	29,0	8,0	14,0	200/100
1153M2516	M25x1,5	M16x1,5	29,0	8,0	14,0	150/50
1153M2520**	M25x1,5	M20x1,5	29,0	8,0	14,0	150/50
1153M3216	M32x1,5	M16x1,5	36,0	10,0	16,0	100/50
1153M3220	M32x1,5	M20x1,5	36,0	10,0	16,0	100/50
1153M3225**	M32x1,5	M25x1,5	36,0	10,0	16,0	100/50
1153M4020	M40x1,5	M20x1,5	46,0	10,0	16,0	50/25
1153M4025	M40x1,5	M25x1,5	46,0	10,0	16,0	50/25
1153M4032	M40x1,5	M32x1,5	46,0	10,0	16,0	50/25
1153M5025	M50x1,5	M25x1,5	55,0	12,0	18,0	30/10
1153M5032	M50x1,5	M32x1,5	55,0	12,0	18,0	30/10
1153M5040	M50x1,5	M40x1,5	55,0	12,0	18,0	30/10
1153M6332	M63x1,5	M32x1,5	68,0	12,0	18,0	20/10
1153M6340	M63x1,5	M40x1,5	68,0	12,0	18,0	20/10
1153M6350	M63x1,5	M50x1,5	68,0	12,0	18,0	20/10

* To achieve IP68 rating:

- for all types, a flat FD seal is required between the adapter and the wall
- an additional FD seal must also be fitted between the cable gland and the adapter on sizes M12, M16, M20 and M25. From size M32, the cable glands are already supplied with FD seals
- the IP rating is only guaranteed in combination with Maxiblock cable glands

**Add to Ref: N for Black

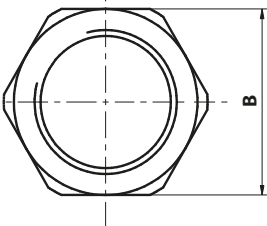
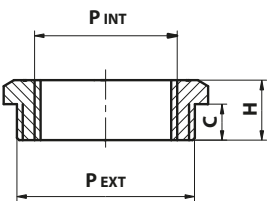

ENTRY THREAD ADAPTERS

Nickel Plated Brass

2093
2043
20A4

Entry thread enlargers

Metric thread M 1.5 pitch CEI EN 60423

Type	P EXT	P INT	Ø A (mm)	C (mm)	H (mm)	Quantity Box/Bag
20931216N	M12x1,5	M16x1,5	18	5	15,5	500/100
20931620N	M16x1,5	M20x1,5	22	5	17,5	300/100
20932025N	M20x1,5	M25x1,5	27	6	20,0	150/50
20932532N	M25x1,5	M32x1,5	34	7	22,5	100/50
20932540N	M25x1,5	M40x1,5	42	7	23,5	50/50
20933240N	M32x1,5	M40x1,5	42	8	24,5	50/50
20933250N	M32x1,5	M50x1,5	52	8	27,5	25/25
20934050N	M40x1,5	M50x1,5	52	8	27,5	25/25
20935063N	M50x1,5	M63x1,5	66	9	31,0	20/10



Entry thread reducers

Metric thread M 1.5 pitch CEI EN 60423

Type	P EXT	P INT	Ø A (mm)	C (mm)	H (mm)	Quantity Box/Bag
20431612N	M16x1,5	M12x1,5	18	5	7,5	1.000/100
20432012N	M20x1,5	M12x1,5	22	6	9,0	600/100
20432016N	M20x1,5	M16x1,5	22	6	9,0	500/100
20432512N	M25x1,5	M12x1,5	27	7	10,0	300/50
20432516N	M25x1,5	M16x1,5	27	7	10,0	300/50
20432520N	M25x1,5	M20x1,5	27	7	10,0	300/100
20433220N	M32x1,5	M20x1,5	34	8	11,0	100/25
20433225N	M32x1,5	M25x1,5	34	8	11,0	150/50
20434025N	M40x1,5	M25x1,5	43	8	11,5	100/25
20434032N	M40x1,5	M32x1,5	43	8	11,5	100/25
20435032N	M50x1,5	M32x1,5	53	9	12,5	50/10
20435040N	M50x1,5	M40x1,5	53	9	12,5	50/25
20436340N	M63x1,5	M40x1,5	66	10	14,0	30/10
20436350N	M63x1,5	M50x1,5	66	10	14,0	30/10

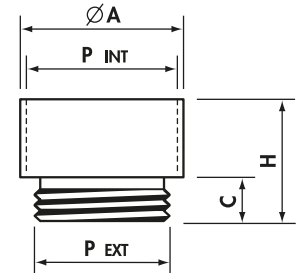

Fig. 1

Entry thread converters - Metric to Pg

Type	P EXT	P INT	Fig.	Ø A (mm)	C (mm)	H (mm)	Quantity Box/Bag
20A42011N	M20x1,5	Pg11	1	22	6,5	17,5	300/100
20A42016N	M20x1,5	Pg16	1	24	6,5	20,0	200/50
20A42513N	M25x1,5	Pg13,5	2	27	7,0	10,0	300/50
20A42516N	M25x1,5	Pg16	2	27	7,0	10,0	300/50
20A43216N	M32x1,5	Pg16	2	36	8,0	11,5	100/25
20A43221N	M32x1,5	Pg21	2	36	8,0	11,5	100/25

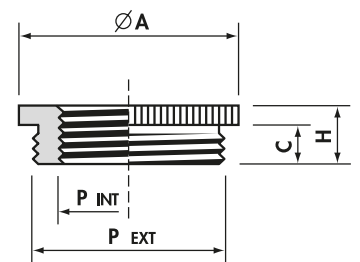

Fig. 2

Entry thread converters - Pg to Metric

20A40916N	Pg 9	M16x1,5	1	20	6,0	15,0	400/100
20A41120N	Pg11	M20x1,5	1	22	6,0	16,0	300/100
20A41320N	Pg13,5	M20x1,5	1	24	6,5	16,5	200/50
20A41620N	Pg16	M20x1,5	2	24	6,5	9,5	50/50
20A42120N	Pg21	M20x1,5	2	30	7,0	10,0	100/100
20A42125N	Pg21	M25x1,5	2	30	7,0	10,0	100/100
20A42925N	Pg29	M25x1,5	2	39	8,0	11,5	50/50

1800 2042

ENTRY THREAD ADAPTERS

Nickel Plated Brass

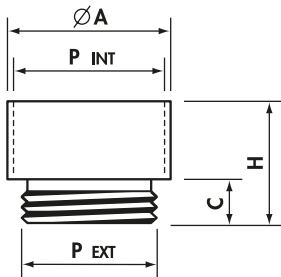

Entry thread enlargers

Pg thread DIN 40 430 - Dimensions DIN 46 320-K

Type	P EXT	P INT	Ø A (mm)	C (mm)	H (mm)	Quantity Box/Bag
180709	Pg 7	Pg 9	17	5,0	15,0	600/100
180911	Pg 9	Pg11	20	6,0	16,5	500/100
180913	Pg 9	Pg13,5	22	6,0	17,5	300/100
181113	Pg11	Pg13,5	22	6,0	17,5	300/100
181116	Pg11	Pg16	24	6,0	18,5	100/50
181316	Pg13,5	Pg16	24	6,5	19,0	200/50
181321	Pg13,5	Pg21	30	6,5	21,0	150/50
181621	Pg16	Pg21	30	6,5	21,0	100/25
182129	Pg21	Pg29	39	7,0	23,0	75/25
182936	Pg29	Pg36	50	8,0	27,5	30/10
183642	Pg36	Pg42	57	9,0	31,0	20/10
184248	pg42	pg48	64	10,0	33,0	20/10

Entry thread reducers

Pg thread DIN 40 430 - Dimensions DIN 46 320-H

Type	P EXT	P INT	Ø A (mm)	C (mm)	H (mm)	Quantity Box/Bag
20420907N	Pg 9	Pg 7	17	6,0	8,5	800/100
20421107N	Pg11	Pg 7	20	6,0	8,5	600/100
20421109N	Pg11	Pg 9	20	6,0	8,5	600/100
20421307N	Pg13,5	Pg 7	22	6,5	9,0	600/100
20421309N	Pg13,5	Pg 9	22	6,5	9,0	600/100
20421311N	Pg13,5	Pg11	22	6,5	9,0	600/100
20421607N	Pg16	Pg 7	24	6,5	9,5	300/50
20421609N	Pg16	Pg 9	24	6,5	9,5	400/100
20421611N	Pg16	Pg11	24	6,5	9,5	400/100
20421613N	Pg16	Pg13,5	24	6,5	9,5	400/100
20422111N	Pg21	Pg11	30	7,0	10,0	200/50
20422113N	Pg21	Pg13,5	30	7,0	10,0	200/50
20422116N	Pg21	Pg16	30	7,0	10,0	200/50
20422916N	Pg29	Pg16	39	8,0	11,5	100/25
20422921N	Pg29	Pg21	39	8,0	11,5	100/25
20423621N	Pg36	Pg21	50	9,0	12,5	50/25
20423629N	Pg36	Pg29	50	9,0	12,5	50/25
20424236N	Pg42	Pg36	57	10,0	14,0	50/25
20424836N	Pg48	Pg36	64	10,0	14,0	25/25
20424842N	Pg48	Pg42	64	10,0	14,0	50/25

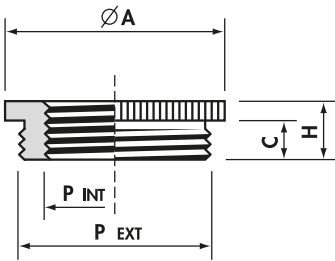



Material:
Zinc plated STEEL UNI 5961/84

Compression washers

Type	Fits thread	Ø E (mm)	Ø I (mm)	Quantity Box/Bag
6010.14	Pg7 + G1/4"	11,0	8,0	15.000/1.000
6010.38	Pg9 + G3/8"	14,5	10,0	5.000/1.000
6010.11	Pg11 + G3/8"	17,0	12,0	5.000/1.000
6010.12	Pg13,5 + G1/2"	18,0	14,0	4.000/1.000
6010.58	Pg16 + G5/8"	20,0	15,5	3.000/1.000
6010.34	G3/4"	24,0	18,5	2.500/500
6010.114	G1"1/4	38,0	33,0	1.000/500
6010.21	Pg21 + G3/4"	26,5	20,0	2.000/500
6010.01	G1"	30,0	24,5	1.500/500
6010.29	Pg29 + G1"1/8	35,0	26,5	1.000/500
6010.36	Pg36 + G1"1/2	45,0	38,0	750/250
6010.42	Pg42	51,0	42,5	500/250
6010.48	Pg48 + G2"	57,0	48,0	400/100

Subject to availability, the compression washers could be of type A or B

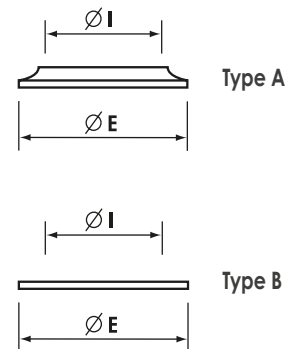

341
342
343
344



SEALING RINGS

PVC 50 sh A

PVC



Material: PVC 50 sh A
Colour: Red

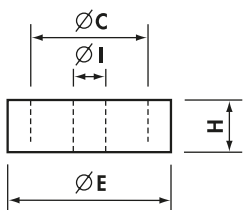
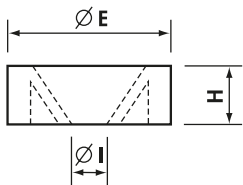
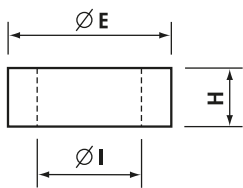

Cylindrical sealing rings

Type	Suitable for Cable Glands IP54 (1700..., 2001..., 2002..., 2003...)	C (mm)	Ø E (mm)	Ø I (mm)	H (mm)	Quantity Box/Bag
3411014	G1/4"	-	10,9	6,7	6,0	1.500/100
3411038	G3/8" + M16	-	14,5	8,5	6,0	1.000/100
3411012	Pg13,5 + G1/2" + M20	-	18,0	11,0	7,5	500/100
3412016	Pg16 + G5/8"	-	20,0	14,0	7,5	300/100
3422016	Pg16 + G5/8"	-	20,0	10,0	7,5	300/100
3411034	G3/4"	-	23,5	17,5	8,0	300/100
3411100	G1"	-	29,0	22,0	10	200/100
3412011	Pg11	-	16,5	10,0	7,0	1.000/100
3412021	Pg21 + M25	-	26,0	18,0	8,5	300/100
3412029	Pg29 + G1"1/8 + M32	-	35,0	26,0	10,0	200/100

Membrane sealing rings

Type	Suitable for Cable Glands IP54 (1700..., 2001..., 2002..., 2003...)	C (mm)	Ø E (mm)	Ø I (mm)	H (mm)	Quantity Box/Bag
3431100	G1"	-	29	15	9,5	200/100

Double sealing rings

Type	Suitable for Cable Glands IP54 (2001..., 2002..., 2003...)	C (mm)	Ø E (mm)	Ø I (mm)	H (mm)	Quantity Box/Bag
3441012	G1/2" + Pg13,5 + M20	13	18,5	8	6,5	500/100
3441034	G3/4"	17	23	12,5	8,5	300/100

SEALING RINGS

Butadiene-Nitrile NBR

1880
1890



Concentric sealing rings

Type	Suitable for Cable Glands IP54 (1700..., 2001..., 2002..., 2003...)	Ø E (mm)	Ø 5 (mm)	Ø 4 (mm)	Ø 3 (mm)	Ø 2 (mm)	Ø 1 (mm)	Ø I (mm)	H (mm)	Quantity Box/Bag
1880	Pg9 + M16	13,3	-	-	-	10,0	7,5	5,0	5,5	1.500/100
1881	Pg11	16,5	-	-	-	12,5	10,0	7,5	6,0	1.000/100
1882	Pg13,5 + M20 + G1/2"	18,3	-	-	-	12,5	10,0	7,5	6,0	800/100
1883	Pg16 + G5/8"	20,4	-	-	15,0	12,5	10,0	7,5	7,0	600/100
1884	Pg21 + M25	26,0	-	-	19,0	16,0	13,0	10,0	8,0	300/100
1884A	Pg21 + M25	26,0	-	-	20,5	18,0	15,0	10,5	8,0	50/25
1885*	Pg29 + M32 + G1"1/8	34,7	-	-	27,0	24,0	21,0	18,0	9,5	150/50
1886	Pg36 + G1"1/2 + M40	44,7	-	-	33,0	30,0	27,0	24,0	12,0	100/50
1887*	Pg42 + M50	51,7	-	-	39,0	36,0	33,0	30,0	14,0	50/25
1888/5	Pg48 + G2" + M63	57,0	45	41	37,0	33,0	29,0	24,0	14,0	75/25
1888*	Pg48 + G2" + M63	57,0	-	-	45,0	42,0	39,0	36,0	14,0	50/25

*material: RUBBER NR



Material:
BUTADIENE-NITRILE NBR
with concentric perforations

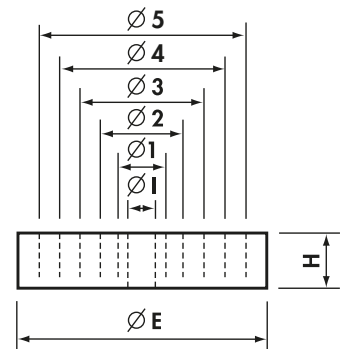

O-rings

Type	Fits thread	Ø E (mm)	Ø I (mm)	Ø H (mm)	Quantity Box/Bag
1889	M12	12,81	9,25	1,78	1.000/1.000
1890	Pg7 + G1/4"	14,38	10,82	1,78	5.000/1.000
1890A	M16 + Pg9 + G3/8"	15,98	12,42	1,78	5.000/1.000
1891	Pg11	19,16	15,60	1,78	5.000/1.000
1891A	M20	20,73	17,17	1,78	5.000/1.000
1892	Pg13,5 + G1/2"	22,33	18,77	1,78	5.000/1.000
1892A	Pg16 + G5/8"	23,91	20,35	1,78	5.000/1.000
1892B	M25	25,51	21,95	1,78	5.000/1.000
1893	Pg21	28,68	25,12	1,78	3.000/500
1893A	M32	30,00	26,00	2,00	500/500
1925.3	G3/4"	30,31	25,07	2,62	1.000/500
1894	G1"	35,06	29,82	2,62	1.000/500
1895	M40 + Pg29 + G1"1/8	39,84	34,60	2,62	1.000/500
1896	G1"1/4	43,01	37,77	2,62	500/500
1897	Pg36 + G1"1/2	49,36	44,12	2,62	800/100
1898	Pg42 + G1"3/4	55,71	50,47	2,62	800/100
1899	Pg48 + G2"	62,06	56,82	2,62	100
1899A	G2"1/2	76,50	69,44	3,53	100/1
1899B	G3"	92,60	81,92	5,34	100/1



Material:
Butadiene-Nitrile 70 sh

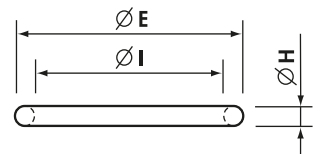

357



Material:
BUTADIENE-STIRENE SBR 70 sh A
Temperature range: -20°C to +70°C
Colour: RAL 7035 light grey

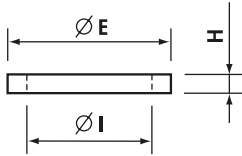

SEALING RINGS

Butadiene-Stirene SBR 70shA

Type	Fits thread	Ø E (mm)	Ø I (mm)	H (mm)	Quantity Box/Bag
3572007	Pg7	16,5	11,5	1,0	4.000/100
3572011	Pg11	23,0	17,5	1,0	2.500/100
35720131	Pg13,5 + M20X1,5 + G1/2"	27,5	20,5	1,4	1.000/100
3572013	Pg13,5	30,0	20,5	2,2	1.000/100
3572016	Pg16	29,0	23,0	2,0	1.000/100
3572021	Pg21	33,5	27,0	3,0	500/100
3573M16	M16x1,5	20,5	16,3	1,0	3.000/100
3573M20	M20X1,5 + Pg13,5 + G1/2"	25,5	20,5	1,0	4.000/100
3573M25	M25x1,5	30,5	25,5	1,0	2.000/100

FD



Material:
NEOPRENE® 80 sh A
Temperature range: -25°C to +100°C
Colour: RAL 9005 black

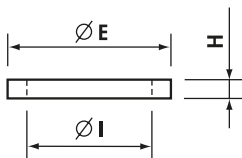

SEALING RINGS

Neoprene® 80 sh A

Type	Fits thread	Ø E (mm)	Ø I (mm)	H (mm)	Quantity Box/Bag
FD M12	M12	16,0	10,0	1,2	2.500/50
FD 7	Pg7 + G1/4"	17,0	11,3	1,2	3.000/50
FD 9	Pg9 + M16	20,0	13,9	1,2	2.000/50
FD M16	M16* + G3/8"	20,0	15,5	1,2	2.000/50
FD 11	Pg11	23,0	17,1	1,2	2.000/50
FD M20	M20	24,0	18,0	1,2	2.000/50
FD 13,5	Pg13,5 + G1/2"	25,0	19,0	1,2	2.500/50
FD 16	Pg16 + G5/8"	27,0	21,0	1,2	1.500/50
FD M25	M25	31,0	23,0	1,2	1.000/50
FD 21	Pg21 + G3/4"	34,5	27,0	1,5	1.000/50
FD M32	M32 + G1"	36,0	30,0	1,3	600/20
FD 29	Pg29 + G1"1/8"	45,0	35,2	1,5	500/25
FD M40	M40 + G1"1/4"	46,0	38,0	1,2	500/20
FD 36	Pg36 + G1"1/2"	53,5	45,6	1,2	250/25
FD M50	M50	55,0	47,5	1,1	10
FD 42	Pg42 + G1"3/4"	62,0	52,0	1,1	10
FD 48	Pg48 + G2"	68,0	58,0	1,1	10
FD M63	M63	68,0	59,0	1,1	500/5

*recommended with set screws

ENTRY PLUGS

Polyamide PA6

Metric thread M 1.5 pitch CEI EN 60423

Type Light Grey	P	Ø A (mm)	C (mm)	Quantity Box/Bag
1053M12	M12x1,5	15	6	100
1053M16*	M16x1,5	20	6	100
1053M20*	M20x1,5	25	7	100
1053M25*	M25x1,5	30	7	100
1053M32*	M32x1,5	37	9	50
1053M40*	M40x1,5	47	9	30
1053M50*	M50x1,5	58	10	20
1053M63	M63x1,5	72	12	10

Add to Ref: N for Black

*Not UL approved

Pg thread DIN 40 430 - Dimensions DIN 46 320

Type Light Grey	P	Ø A (mm)	C (mm)	Quantity Box/Bag
1052007	Pg 7	15	6	100
1052009*	Pg 9	19	6	100
1052011*	Pg11	22	7	100
1052013*	Pg13,5	25	7	100
1052016*	Pg16	27	7	100
1052021	Pg21	33	9	50
1052029*	Pg29	44	9	50/25
1052036	Pg36	55	10	20
1052042	Pg42	62	10	10
1052048	Pg48	69	12	10

Add to Ref: N for Black

*Not UL approved

Polystyrene PS

Metric thread M 1.5 pitch CEI EN 60423

Type Light Grey	P	Ø A (mm)	C (mm)	Quantity Box/Bag
1253M12	M12x1,5	15	6	100
1253M16	M16x1,5	20	6	100
1253M20	M20x1,5	25	7	100
1253M25	M25x1,5	30	7	100
1253M32	M32x1,5	37	9	50
1253M40	M40x1,5	47	9	30
1253M50	M50x1,5	58	10	20
1253M63	M63x1,5	72	12	10

Add to Ref: N for Black

Pg thread DIN 40 430 - Dimensions DIN 46 320

Type Light Grey	P	Ø A (mm)	C (mm)	Quantity Box/Bag
1840	Pg 7	15	6	100
1841	Pg 9	19	6	100
1842	Pg11	22	7	100
1843	Pg13,5	25	7	100
1844	Pg16	27	7	100
1845	Pg21	33	9	50
1846	Pg29	44	9	50/25
1847	Pg36	55	10	20
1848	Pg42	62	10	10
1849	Pg48	69	12	10

Add to Ref: N for Black

1053
1052

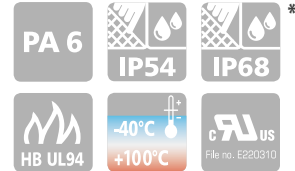

Material: POLYAMIDE PA6 reinforced with fibreglass self-extinguishing class HB (UL 94)

Temperature range:

-40°C to +100°C (static)

-20°C to +90°C (dynamic)

Protection: IP 54

Protection: IP 68 (*with the aid of FD sealing ring)

Colour: RAL 7035 light grey, RAL 9005 black

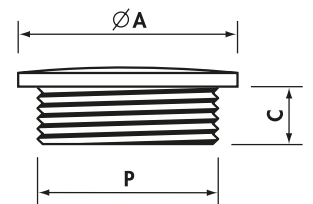

1253
1840



Material: POLYSTYRENE PS

Temperature range:

-20°C to +60°C (dynamic)

Protection: IP 54

Protection: IP 68 (*with the aid of FD sealing ring)

Colour: RAL 7035 light grey, RAL 9005 black

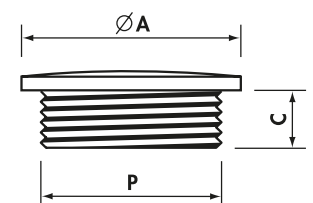



**



Material: POLIAMMIDE PA6 / PA6.6**
self-extinguishing class V0 / V2** (UL 94)

Temperature range:

-20°C to +90°C (dynamic)

Colour: RAL 7035 light grey,
RAL 9005 black

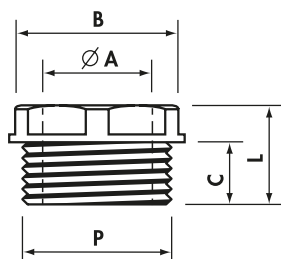

Entry bushes

Pg thread DIN 40 430 - Dimensions DIN 46 320

Type Light Grey	P	Ø A (mm)	B Spanner (mm)	C (mm)	L min-max (mm)	Quantity Box/Bag
*1700.2	Pg 9	10,0	16	9,0	14,0	600/100
*1701.2	Pg11	11,5	19	10,0	15,0	300/100
*1702.2**	Pg13,5	13,5	21	11,0	16,5	300/100
1703.2	Pg16	16,0	23	12,5	18,5	200/50
1704.2	Pg21	22,0	30	12,0	17,5	100/50
1705.2	Pg29	27,0	40	15,0	22,0	50/50

BSP thread ISO 228/1

Type Light Grey	P	Ø A (mm)	B Spanner (mm)	C (mm)	L min-max (mm)	Quantity Box/Bag
*1830	G1/4"	8,5	15	8,5	13,5	800/100
*1831	G3/8"	11,5	17	9,0	14,0	300/100
*1832**	G1/2"	13,0	21	11,0	16,5	300/100

Metric thread M 1.5 pitch CEI EN 60423

Type Light Grey	P	Ø A (mm)	B Spanner (mm)	C (mm)	L min-max (mm)	Quantity Box/Bag
1835	M16x1,5	11,5	17	9	14,0	400/100
*1836**	M20x1,5	13,5	21	11	16,5	300/100

*Add to Ref: N for Black

Blind entry bushes

Pg thread DIN 40 430 - Dimensions DIN 46 320

Type Light Grey	P	Ø A (mm)	B Spanner (mm)	C (mm)	L min-max (mm)	Quantity Box/Bag
*1702.5**	Pg13,5	-	21	11,0	17,0	300/100
1703.5	Pg16	-	23	12,5	18,5	200/100

BSP thread ISO 228/1

Type Light Grey	P	Ø A (mm)	B Spanner (mm)	C (mm)	L min-max (mm)	Quantity Box/Bag
*1861	G3/8"	-	17	9	14	600/100
*1862**	G1/2"	-	21	11	16,5	200/100

Metric thread M 1.5 pitch CEI EN 60423

Type Light Grey	P	Ø A (mm)	B Spanner (mm)	C (mm)	L min-max (mm)	Quantity Box/Bag
*1866**	M20x1,5	-	21	11	17	100

*Add to Ref: N for Black

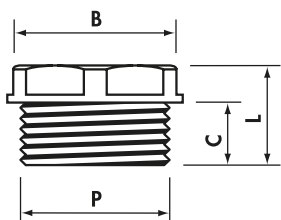

ENTRY PLUGS

Nickel Plated Brass

Metric thread M 1.5 pitch CEI EN 60423

Type Nickel Plated Brass	P	Ø A (mm)	C (mm)	Quantity Box/Bag
2053M12N	M12x1,5	14	5,0	1.500/100
2053M16N	M16x1,5	18	5,0	1.000/100
2053M20N	M20x1,5	22	6,5	400/100
2053M25N	M25x1,5	28	7,0	200/100
2053M32N	M32x1,5	35	8,0	150/25
2053M40N	M40x1,5	44	8,5	100/25
2053M50N	M50x1,5	54	9,0	50/25
2053M63N	M63x1,5	67	10,0	25/25

Pg thread DIN 40 430 - Dimensions DIN 46 320

Type Nickel Plated Brass	P	Ø A (mm)	C (mm)	Quantity Box/Bag
2052007N	Pg 7	14	5,0	1.500/100
2052009N	Pg 9	17	6,0	1.000/100
2052011N	Pg11	20	6,0	500/100
2052013N	Pg13,5	22	6,5	500/100
2052016N	Pg16	24	6,5	500/100
2052021N	Pg21	30	7,0	200/50
2052029N	Pg29	39	8,0	100/25
2052036N	Pg36	50	9,0	50/25
2052042N	Pg42	57	10,0	25/25
2052048N	Pg48	64	10,0	25/25

ENTRY BUSHES

Brass

BSP thread ISO 228/1

Type Brass	P	Ø A (mm)	B Spanner (mm)	C (mm)	L min-max (mm)	Quantity Box/Bag
2021014N	G1/4"	10,0	13	6,0	8,5	1.000/100
2021038N	G3/8"	12,0	17	7,5	10,5	800/100
2021012N	G1/2"	16,0	21	9,5	13,0	400/100
2021058N	G5/8"	18,0	23	10,0	13,5	250/50
2021034N	G3/4"	21,0	27	10,0	14,0	200/50
2021100N	G1"	26,5	34	11,0	15,5	100/50
2021118N	G1"1/8	31,0	38	12,0	16,5	100/25
2021114N	G1"1/4	35,0	42	13,0	18,0	50/25
2021112N	G1"1/2	41,5	48	13,0	18,5	50/25
2021200N	G2"	51,5	60	13,5	19,5	25/25

2053 2052



Material: NICKEL PLATED BRASS (CuZn 40 Pb 3)
 -40°C to +100°C (static)
 -25°C to +100°C (dynamic)
 Protection: IP 54
 Protection: IP 68 (*with the aid of FD sealing ring)

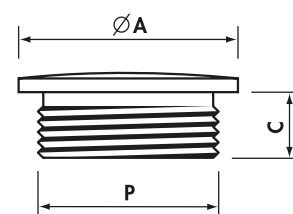

2021



Material: NICKEL PLATED BRASS

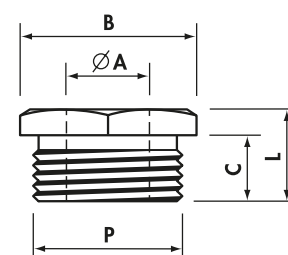

RS



Material: Rubber EPDM halogen-free and chemical resistant
 Temperature range: -40°C to +110°C
 Protection: IP 67
 Colour: RAL 7001 light grey
 Application: IP67 sealing of cables and conduits in Metric and Pg threaded entries through material thickness 0,5-4 mm

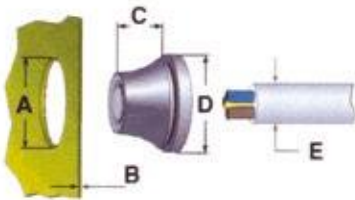

GROMMETS

Rubber EPDM

Fits Metric thread

Type	Fits Threaded Entry	A (mm)	B (mm)	C (mm)	D (mm)	E (mm)	Quantity Box/Bag
RS0407.M12	M12	12,5	0,5 - 2	5,6	20,0	4 - 7	4000/50
RS0509.M16	M16	16,5	1 - 4	11,0	21,0	5 - 9	4000/50
RS0813.M20	M20/Pg13,5	20,5	1 - 4	13,4	25,5	8 - 13	2000/50
RS1117.M25	M25	25,5	1 - 4	15,3	30,5	11 - 17	1500/50
RS1520.M32*	M32	32,5	1 - 4	18,6	38,5	15 - 20	750/25
RS1928.M40	M40	40,5	1 - 4	21,7	48,5	19 - 28	400/25
RS2735.M50*	M50	50,5	1 - 4	25,0	60,5	27 - 35	250/10

*Add to Ref: N for Black

Fits Pg thread

Type	Fits Threaded Entry	A (mm)	B (mm)	C (mm)	D (mm)	E (mm)	Quantity Box/Bag
RS0305.07	Pg 7	12,5	0,5 - 2	5,4	20,0	3 - 5	4000/50
RS0507.09	Pg 9	16,0	1 - 4	10,3	21,0	5 - 7	4000/50
RS0710.11	Pg11	19,0	1 - 4	12,7	24,0	7 - 10	2000/50
RS1014.16	Pg16	23,0	1 - 4	14,7	28,0	10 - 14	1500/50
RS1420.21	Pg21	29,0	1 - 4	17,6	35,0	14 - 20	750/25
RS2026.29	Pg29	38,0	1 - 4	20,0	46,0	20 - 26	400/25
RS2635.36	Pg36	48,0	1 - 4	23,9	58,0	26 - 35	250/10

3600



Material: ABS self-extinguishing class V0 (UL94) UV stabilised
 Glow wire resistance: 750° C (CEI EN 60695-2-1)
 Temperature range: -20°C to +80°C (dynamic)
 Colour: RAL 7035 light grey

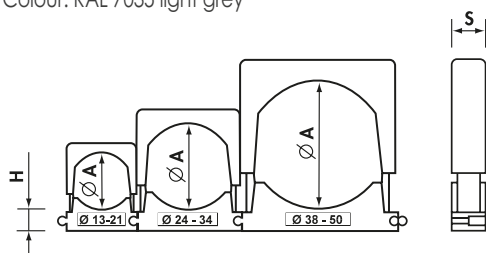

MODULAR RETAINING CLIPS

ABS



Application: Fix SICURclip base to surface using dia. 5 - 6 mm screw (Ref. Fig. A). Insert cable, tubing or flexible conduit. Fit adjustable cover and press to secure. Modular SICURclips of the same or different size may easily be joined together.

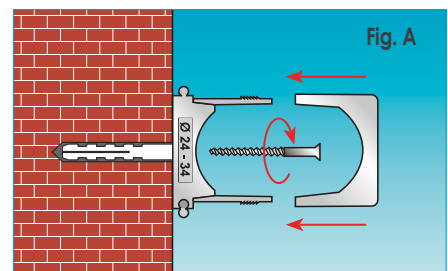

Type	Ø A min-max (mm)	H (mm)	S (mm)	Quantity
3601	13-21	8,5	16	100
3602	24-34	8,5	16	50
3603	38-50	8,5	16	25



SPLIT CABLE ENTRY SYSTEMS FOR PREDETERMINED CABLES AND ACCESSORIES

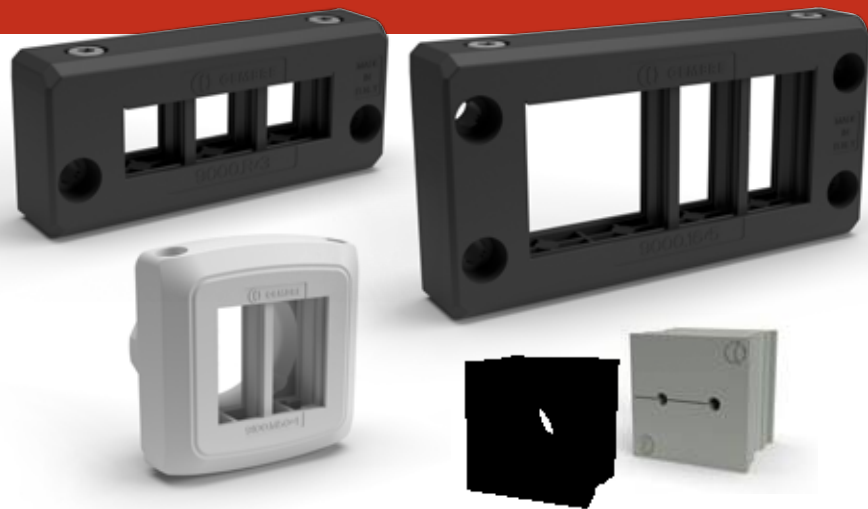

LOTS OF GREAT REASONS FOR CHOOSING EWO



- **Plug & Fix:** quick installation on predetermined cables for signal distribution, sensors and power supply
- **Easy to use:** frame can be fitted after laying the cables, which can also be secured with grommets in the final phase of machine wiring
- **For industrial automation:** ideal for applications in industrial automation, for cable management on the machine
- **Safety without compromise:** extremely safe and protected (IP66) even without an additional external seal
- **Grommets are perfectly enclosed by the frame,** with no protrusions, ensuring IP66 protection and cable sealing in accordance with EN62444

Frame can be fitted after laying the cables, which can also be secured with grommets in the final phase of machine wiring

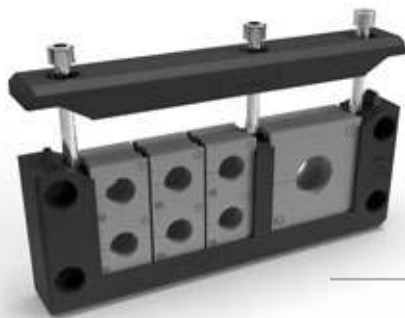

Extremely safe and protected (IP66) thanks to the special overmoulded seal which does not require an external seal



Quick installation on predetermined cables for signal distribution, sensors and power supply



Ideal for applications in industrial automation, for cable management on the machine



Slim and space-saving thanks to the compact design and the absence of an external seal.



SPLIT CABLE ENTRY SYSTEMS FOR PREDETERMINED CABLES

general specifications

- **Slim and space-saving** thanks to the compact design and the absence of an external seal (available as an accessory)
- **Fast and flexible screw fastening:** anti-fall system for easier installation
- **Frame fixing system** using screws on nuts, deep-drawn holes or rivets
- **High quality material:** reinforced PA6.6 fibreglass frame with stainless steel screws and clamping nuts
- **180° of simplicity:** grommets can be mounted freely, without having to be locked in place, and without worrying about the direction of installation



Grommets are perfectly enclosed by the frame, without protrusions, ensuring IP66 protection and cable sealing in accordance with EN62444

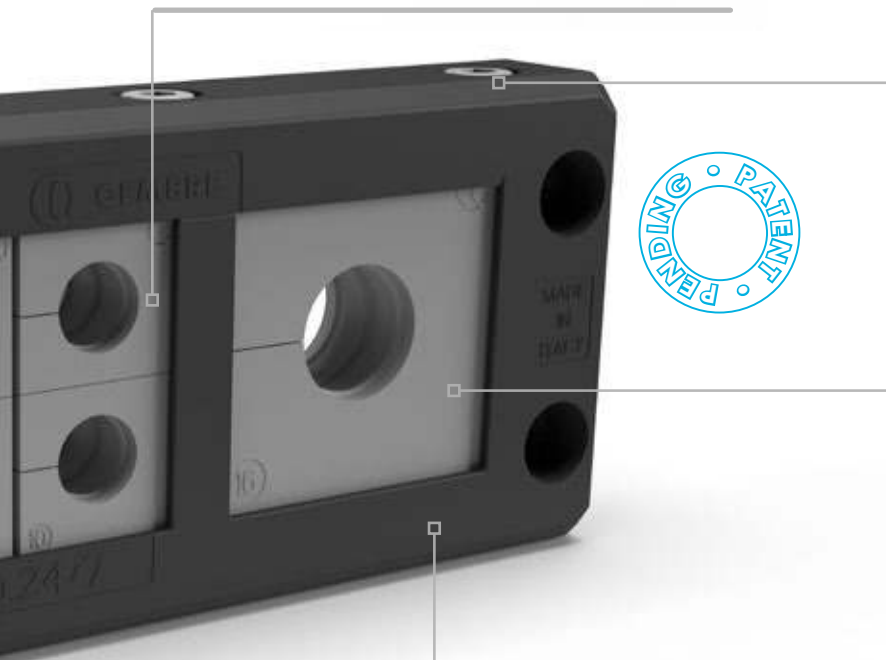
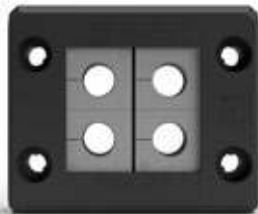

Fast and flexible screw fastening: anti-fall system for easier installation

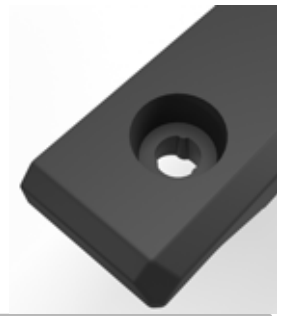

Grommets can be mounted freely, without having to be locked in place, and without worrying about the direction of installation

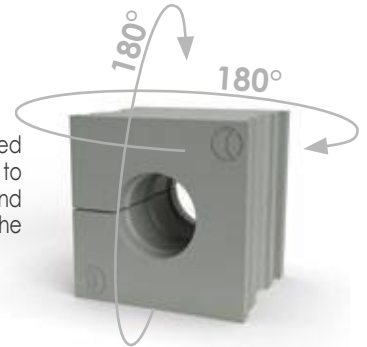

Reinforced PA6.6 fibreglass frame stainless steel screws and clamping nuts



Frame fixing system using screws on nuts, deep-drawn holes or rivets

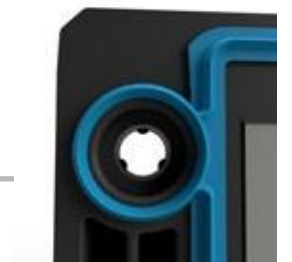

9000.Q

SPLIT CABLE ENTRY SYSTEMS FOR PREDETERMINED CABLES

made in glass-fibre reinforced polyamide PA6.6
with overmoulded seal

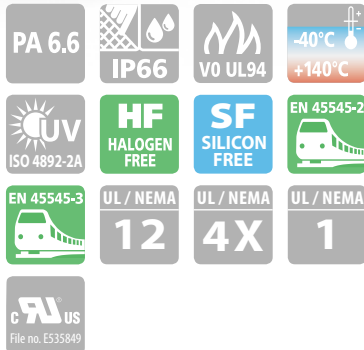

Cable entry system dimensions

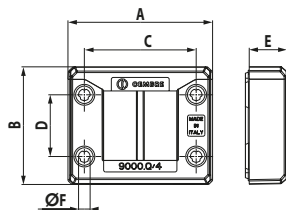

Metal plate perforation dimensions

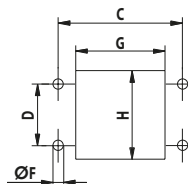

Diagram (grommets not included)



Marking/Approvals



Type

Black (RAL 9005) ■
Units in standard packaging
Units in minimum packaging

9000.Q/4
10
10

9000.Q/1
10
10

Dimensions and Weights

A
B
C
D
E
ØF
G
H
Weight

75 mm
61 mm
58 mm
32 mm
19.5 mm
5.5 mm
43 mm
43 mm
44 g

75 mm
61 mm
58 mm
32 mm
19.5 mm
5.5 mm
43 mm
43 mm
42 g

Material Specifications

Frame material
Light blue overmoulded seal material
Frame fastening screws material
Frame fastening nuts material

PA6.6 + GF
Thermoplastic elastomer (TPE)
Stainless steel (M5x55) Class A2
Stainless steel Class A2

PA6.6 + GF
Thermoplastic elastomer (TPE)
Stainless steel (M5x55) Class A2
Stainless steel Class A2

Technical Specifications

Silicon free
Halogen free
ISO 4892-2A
ROHS compliant
Self-extinguishing class (UL 94)
Temperature range (static)
IP rating (EN 60529)
Number of small grommets, type A
Number of large grommets, type B

YES
YES
YES
YES
V0
-40°C to +140°C
IP 66
4
-

YES
YES
YES
YES
V0
-40°C to +140°C
IP 66
-
1

Certifications

UL/NEMA performance
UL Standard
UL file number
Cable clamping according to EN 62444

12, 4X indoor, 1
50E
E535849
YES

12, 4X indoor, 1
50E
E535849
YES

Accessories upon request

Stainless steel screws for wall attachment
External seal for uneven walls
Grommets
Punching set CEMBRE*

9001.M5X25
9006.Q
4 x type A
RD43X43

9001.M5X25
9006.Q
1 x type B
RD43X43

*see page 305, 343

SPLIT CABLE ENTRY SYSTEMS FOR PREDETERMINED CABLES

9000.10

made in glass-fibre reinforced polyamide PA6.6
with overmoulded seal



Cable entry system dimensions

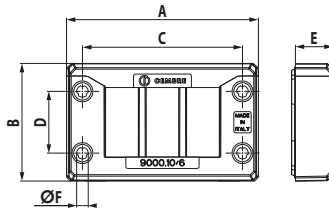

Metal plate perforation dimensions

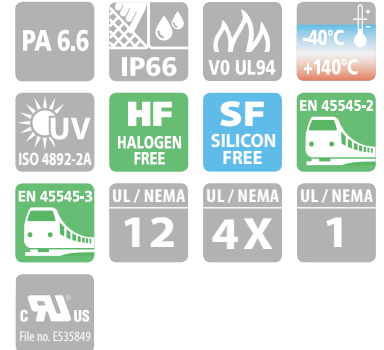
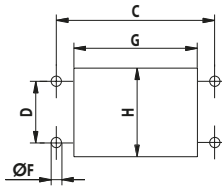

Diagram (grommets not included)



Marking/Approvals



Type

Black (RAL 9005) ■
Units in standard packaging
Units in minimum packaging

9000.10/6
10
10

9000.10/3
10
10

Dimensions and Weights

A
B
C
D
E
ØF
G
H
Weight

99.5 mm
61 mm
83 mm
32 mm
19.5 mm
5.5 mm
65 mm
36/46 mm
56 g

99.5 mm
61 mm
83 mm
32 mm
19.5 mm
5.5 mm
65 mm
36/46 mm
54 g

Material Specifications

Frame material
Light blue overmoulded seal material
Frame fastening screws material
Frame fastening nuts material

PA6.6 + GF
Thermoplastic elastomer (TPE)
Stainless steel (M5x55) Class A2
Stainless steel Class A2

PA6.6 + GF
Thermoplastic elastomer (TPE)
Stainless steel (M5x55) Class A2
Stainless steel Class A2

Technical Specifications

Silicon free
Halogen free
ISO 4892-2A
ROHS compliant
Self-extinguishing class (UL 94)
Temperature range (static)
IP rating (EN 60529)
Number of small grommets, type A
Number of large grommets, type B

YES
YES
YES
YES
V0
-40°C to +140°C
IP 66
6
-

YES
YES
YES
YES
V0
-40°C to +140°C
IP 66
2
1

Certifications

UL/NEMA performance
UL Standard
UL file number
Cable clamping according to EN 62444

12, 4X indoor, 1
50E
E535849
YES

12, 4X indoor, 1
50E
E535849
YES

Accessories upon request

Stainless steel screws for wall attachment
External seal for uneven walls
Grommets
Punching set CEMBRE*

9001.M5X25
9006.10
6 x type A
RD46X65 ; RD36X65

9001.M5X25
9006.10
2 x type A and 1 x type B
RD46X65 ; RD36X65

*see page 305, 343

9000.16

SPLIT CABLE ENTRY SYSTEMS FOR PREDETERMINED CABLES

made in glass-fibre reinforced polyamide PA6.6 with overmoulded seal



PA 6.6	IP66	VO UL94	-40°C +140°C
UV ISO 4892-2A	HF HALOGEN FREE	SF SILICON FREE	EN 45545-2
EN 45545-3	UL / NEMA 12	UL / NEMA 4X	UL / NEMA 1
CUL US File no. E535849			

Cable entry system dimensions

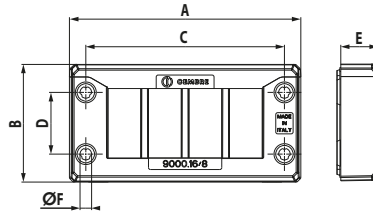

Metal plate perforation dimensions

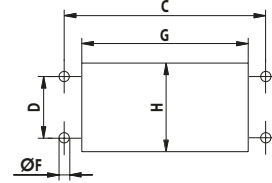

Diagram (grommets not included)



Marking/Approvals



Type

Black (RAL 9005) ■

Units in standard packaging

Units in minimum packaging

Dimensions and Weights

A	120 mm
B	61 mm
C	103 mm
D	32 mm
E	19.5 mm
ØF	5.5 mm
G	86 mm
H	36/46 mm
Weight	62 g

9000.16/8

10

10

Material Specifications

Frame material	PA6.6 + GF
Light blue overmoulded seal material	Thermoplastic elastomer (TPE)
Frame fastening screws material	Stainless steel (M5x55) Class A2
Frame fastening nuts material	Stainless steel Class A2

Technical Specifications

Silicon free	YES
Halogen free	YES
ISO 4892-2A	YES
ROHS compliant	YES
Self-extinguishing class (UL 94)	VO
Temperature range (static)	-40°C to +140°C
IP rating (EN 60529)	IP 66
Number of small grommets, type A	8
Number of large grommets, type B	-

Certifications

UL/NEMA performance	12, 4X indoor, 1
UL Standard	50E
UL file number	E535849
Cable clamping according to EN 62444	YES

Accessories upon request

Stainless steel screws for wall attachment	9001.M5X25
External seal for uneven walls	9006.16
Grommets	8 x type A
Punching set CEMBRE*	RD46X86 ; RD36X86

Frame material	PA6.6 + GF
Light blue overmoulded seal material	Thermoplastic elastomer (TPE)
Frame fastening screws material	Stainless steel (M5x55) Class A2
Frame fastening nuts material	Stainless steel Class A2

Silicon free	YES
Halogen free	YES
ISO 4892-2A	YES
ROHS compliant	YES
Self-extinguishing class (UL 94)	VO
Temperature range (static)	-40°C to +140°C
IP rating (EN 60529)	IP 66
Number of small grommets, type A	4
Number of large grommets, type B	1

UL/NEMA performance	12, 4X indoor, 1
UL Standard	50E
UL file number	E535849
Cable clamping according to EN 62444	YES

Stainless steel screws for wall attachment	9001.M5X25
External seal for uneven walls	9006.16
Grommets	4 x type A and 1 x type B
Punching set CEMBRE*	RD46X86 ; RD36X86



9000.16/5

10

10

Frame material	PA6.6 + GF
Light blue overmoulded seal material	Thermoplastic elastomer (TPE)
Frame fastening screws material	Stainless steel (M5x55) Class A2
Frame fastening nuts material	Stainless steel Class A2

Silicon free	YES
Halogen free	YES
ISO 4892-2A	YES
ROHS compliant	YES
Self-extinguishing class (UL 94)	VO
Temperature range (static)	-40°C to +140°C
IP rating (EN 60529)	IP 66
Number of small grommets, type A	4
Number of large grommets, type B	1

UL/NEMA performance	12, 4X indoor, 1
UL Standard	50E
UL file number	E535849
Cable clamping according to EN 62444	YES

Stainless steel screws for wall attachment	9001.M5X25
External seal for uneven walls	9006.16
Grommets	4 x type A and 1 x type B
Punching set CEMBRE*	RD46X86 ; RD36X86



9000.16/2

10

10

Frame material	PA6.6 + GF
Light blue overmoulded seal material	Thermoplastic elastomer (TPE)
Frame fastening screws material	Stainless steel (M5x55) Class A2
Frame fastening nuts material	Stainless steel Class A2

Silicon free	YES
Halogen free	YES
ISO 4892-2A	YES
ROHS compliant	YES
Self-extinguishing class (UL 94)	VO
Temperature range (static)	-40°C to +140°C
IP rating (EN 60529)	IP 66
Number of small grommets, type A	-
Number of large grommets, type B	2

UL/NEMA performance	12, 4X indoor, 1
UL Standard	50E
UL file number	E535849
Cable clamping according to EN 62444	YES

Stainless steel screws for wall attachment	9001.M5X25
External seal for uneven walls	9006.16
Grommets	2 x type B
Punching set CEMBRE*	RD46X86 ; RD36X86

*see page 305, 343

SPLIT CABLE ENTRY SYSTEMS FOR PREDETERMINED CABLES

9000.24

made in glass-fibre reinforced polyamide PA6.6
with overmoulded seal



Cable entry system dimensions

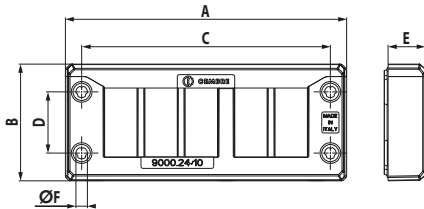

Metal plate perforation dimensions

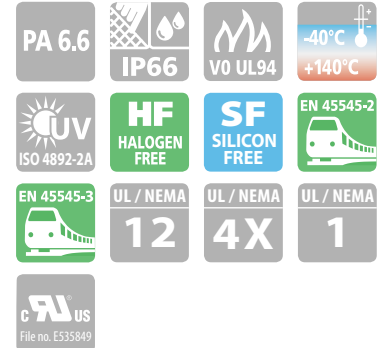
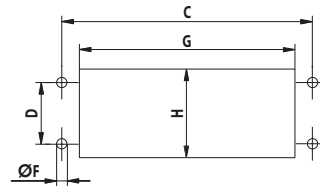
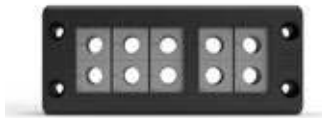

Diagram (grommets not included)



Marking/Approvals



Type

Black (RAL 9005) ■

Units in standard packaging

Units in minimum packaging

9000.24/10

10

10

9000.24/7

10

10

9000.24/4

10

10

Dimensions and Weights

A

147 mm

147 mm

147 mm

B

61 mm

61 mm

61 mm

C

130 mm

130 mm

130 mm

D

32 mm

32 mm

32 mm

E

19.5 mm

19.5 mm

19.5 mm

ØF

5.5 mm

5.5 mm

5.5 mm

G

112 mm

112 mm

112 mm

H

36/46 mm

36/46 mm

36/46 mm

Weight

75 g

73 g

71 g

Material Specifications

Frame material

PA6.6 + GF

PA6.6 + GF

PA6.6 + GF

Light blue overmoulded seal material

Thermoplastic elastomer (TPE)

Thermoplastic elastomer (TPE)

Thermoplastic elastomer (TPE)

Frame fastening screws material

Stainless steel (M5x55) Class A2

Stainless steel (M5x55) Class A2

Stainless steel (M5x55) Class A2

Frame fastening nuts material

Stainless steel Class A2

Stainless steel Class A2

Stainless steel Class A2

Technical Specifications

Silicon free

YES

YES

YES

Halogen free

YES

YES

YES

ISO 4892-2A

YES

YES

YES

ROHS compliant

YES

YES

YES

Self-extinguishing class (UL 94)

V0

V0

V0

Temperature range (static)

-40°C to +140°C

-40°C to +140°C

-40°C to +140°C

IP rating (EN 60529)

IP 66

IP 66

IP 66

Number of small grommets, type A

10

6

2

Number of large grommets, type B

-

1

2

Certifications

UL/NEMA performance

12, 4X indoor, 1

12, 4X indoor, 1

12, 4X indoor, 1

UL Standard

50E

50E

50E

UL file number

E535849

E535849

E535849

Cable clamping according to EN 62444

YES

YES

YES

Accessories upon request

Stainless steel screws for wall attachment

9001.M5X25

9001.M5X25

9001.M5X25

External seal for uneven walls

9006.24

9006.24

9006.24

Grommets

10 x type A

6 x type A and 1 x type B

2 x type A and 2 x type B

Punching set CEMBRE*

RD46X112; RD36X112

RD46X112; RD36X112

RD46X112; RD36X112

*see page 305, 343

9000.R

SPLIT CABLE ENTRY SYSTEMS FOR PREDETERMINED CABLES

made in glass-fibre reinforced polyamide PA6.6
with overmoulded seal

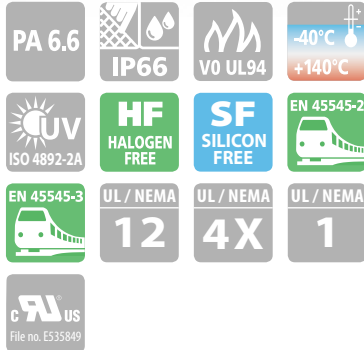

Cable entry system dimensions

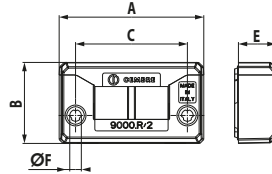

Metal plate perforation dimensions

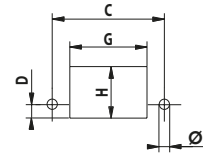

Diagram (grommets not included)



Marking/Approvals



Type

Black (RAL 9005) ■

Units in standard packaging

Units in minimum packaging

Dimensions and Weights

A	75 mm
B	42 mm
C	58 mm
D	5 mm
E	19.5 mm
ØF	5.5 mm
G	43 mm
H	24 mm
Weight	32 g

9000.R/2

10

10

75 mm

42 mm

58 mm

5 mm

19.5 mm

5.5 mm

43 mm

24 mm

32 g

Material Specifications

Frame material	PA6.6 + GF
Light blue overmoulded seal material	Thermoplastic elastomer (TPE)
Frame fastening screws material	Stainless steel (M5x35) Class A2
Frame fastening nuts material	Stainless steel Class A2

PA6.6 + GF

Thermoplastic elastomer (TPE)

Stainless steel (M5x35) Class A2

Stainless steel Class A2

Technical Specifications

Silicon free	YES
Halogen free	YES
ISO 4892-2A	YES
ROHS compliant	YES
Self-extinguishing class (UL 94)	V0
Temperature range (static)	-40°C to +140°C
IP rating (EN 60529)	IP 66
Number of small grommets, type A	2
Number of large grommets, type B	-

YES

YES

YES

YES

V0

-40°C to +140°C

IP 66

2

-

Certifications

UL/NEMA performance	12, 4X indoor, 1
UL Standard	50E
UL file number	E535849
Cable clamping according to EN 62444	YES

12, 4X indoor, 1

50E

E535849

YES

Accessories upon request

Stainless steel screws for wall attachment	9001.M5X25
External seal for uneven walls	9006.R2
Grommets	2 x type A
Punching set CEMBRE*	RD24X43

9001.M5X25

9006.R2

2 x type A

RD24X43

9000.R/3

10

10

99.5 mm

42 mm

83 mm

5 mm

19.5 mm

5.5 mm

65 mm

24 mm

41 g

PA6.6 + GF

Thermoplastic elastomer (TPE)

Stainless steel (M5x35) Class A2

Stainless steel Class A2

YES

YES

YES

YES

V0

-40°C to +140°C

IP 66

3

-

12, 4X indoor, 1

50E

E535849

YES

9001.M5X25

9006.R3

3 x type A

RD24X65

*see page 305, 343

SPLIT CABLE ENTRY SYSTEMS FOR PREDETERMINED CABLES

9000.R

made in glass-fibre reinforced polyamide PA6.6
with overmoulded seal



Cable entry system dimensions

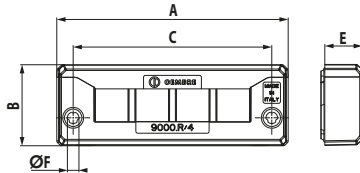

Metal plate perforation dimensions

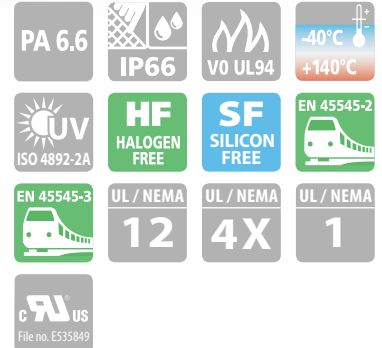
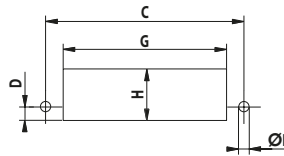

Diagram (grommets not included)



Marking/Approvals



Type

Black (RAL 9005) ■
Units in standard packaging
Units in minimum packaging

Dimensions and Weights

A	120 mm
B	42 mm
C	103 mm
D	5 mm
E	19.5 mm
ØF	5.5 mm
G	86 mm
H	24 mm
Weight	46 g

9000.R/4
10
10

Material Specifications

Frame material
Light blue overmoulded seal material
Frame fastening screws material
Frame fastening nuts material

PA6.6 + GF
Thermoplastic elastomer (TPE)
Stainless steel (M5x35) Class A2
Stainless steel Class A2

Technical Specifications

Silicon free
Halogen free
ISO 4892-2A
ROHS compliant
Self-extinguishing class (UL 94)
Temperature range (static)
IP rating (EN 60529)
Number of small grommets, type A
Number of large grommets, type B

YES
YES
YES
YES
V0
-40°C to +140°C
IP 66
4
-

Certifications

UL/NEMA performance
UL Standard
UL file number
Cable clamping according to EN 62444

12, 4X indoor, 1
50E
E535849
YES

Accessories upon request

Stainless steel screws for wall attachment
External seal for uneven walls
Grommets
Punching set CEMBRE*

9001.M5X25
9006.R4
4 x type A
RD24X86

9000.R/5
10
10

A	147 mm
B	42 mm
C	130 mm
D	5 mm
E	19.5 mm
ØF	5.5 mm
G	112 mm
H	24 mm
Weight	56 g

PA6.6 + GF
Thermoplastic elastomer (TPE)
Stainless steel (M5x35) Class A2
Stainless steel Class A2

YES
YES
YES
YES
V0
-40°C to +140°C
IP 66
5
-

12, 4X indoor, 1
50E
E535849
YES

9001.M5X25
9006.R5
5 x type A
RD24X112

*see page 305, 343

9100.M25

CIRCULAR SPLIT CABLE ENTRY SYSTEMS FOR PREDETERMINED CABLES

made in glass-fibre reinforced polyamide PA6.6
with overmoulded seal



Cable entry system dimensions

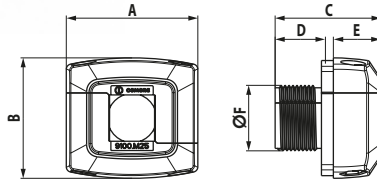

Metal plate perforation dimensions

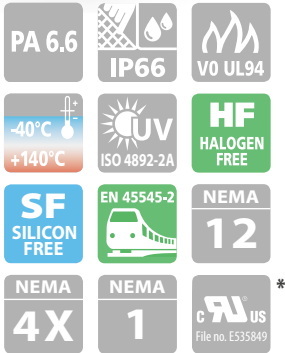
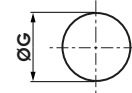

Diagram (grommets not included)



Marking/Approvals

Type

Grey (RAL 7035)

Black (RAL 9005)

Units in standard packaging

Units in minimum packaging

Dimensions and Weights

A

B

C

D

E

ØF

ØG

Weight

Material Specifications

Frame material

Light blue overmoulded seal material

Frame fastening screws material

Frame fastening nuts material

Technical Specifications

Silicon free

Halogen free

ISO 4892-2A

ROHS compliant

Self-extinguishing class (UL 94)

Temperature range (static)

IP rating (EN 60529)

Number of small grommets, type A

Number of large grommets, type B

Counter nut included

Certifications

NEMA performance

UL Standard

UL file number

Cable clamping according to EN 62444

Accessories upon request

Grommets

Punching set CEMBRE**

Split bushing



9100.M25

9100.M25N

10

10

50.0 mm

45.5 mm

40 mm

19 mm

18 mm

M25X1.5

25.4 mm

63 g

PA6.6 + GF

Thermoplastic elastomer (TPE)

Stainless steel (M5x35) Class A2

Stainless steel Class A2

YES

YES

YES

YES

V0

-40°C to +140°C

IP 66

1

-

1143M25

12, 4X indoor, 1

50E

*Pending

YES

1 x type A

RD25.4SS

9110.M25 ; 9110.M25N

**see page 305, 343

CIRCULAR SPLIT CABLE ENTRY SYSTEMS FOR PREDETERMINED CABLES

9100.M32

made in glass-fibre reinforced polyamide PA6.6
with overmoulded seal



Cable entry system dimensions

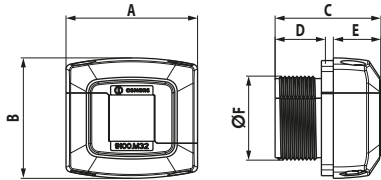

Metal plate perforation dimensions

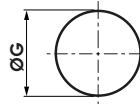

Diagram (grommets not included)

Marking/Approvals

Type

Grey (RAL 7035)

Black (RAL 9005)

Units in standard packaging

Units in minimum packaging

Dimensions and Weights

A

B

C

D

E

ØF

ØG

Weight

Material Specifications

Frame material

Light blue overmoulded seal material

Frame fastening screws material

Frame fastening nuts material

Technical Specifications

Silicon free

Halogen free

ISO 4892-2A

ROHS compliant

Self-extinguishing class (UL 94)

Temperature range (static)

IP rating (EN 60529)

Number of small grommets, type A

Number of large grommets, type B

Counter nut included

Certifications

NEMA performance

UL Standard

UL file number

Cable clamping according to EN 62444

Accessories upon request

Grommets

Punching set CEMBRE**

Split bushing



9100.M32

9100.M32N

10

10

50.0 mm

45.5 mm

40 mm

19 mm

18 mm

M32X1.5

32.5 mm

66 g

PA6.6 + GF

Thermoplastic elastomer (TPE)

Stainless steel (M5x35) Class A2

Stainless steel Class A2

YES

YES

YES

YES

V0

-40°C to +140°C

IP 66

1

-

1143M32

12, 4X indoor, 1

50E

*Pending

YES

1 x type A

RD32.555

9110.M32; 9110.M32N

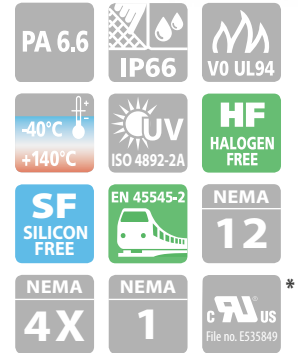

**see page 305, 343

9100.M50

CIRCULAR SPLIT CABLE ENTRY SYSTEMS FOR PREDETERMINED CABLES

made in glass-fibre reinforced polyamide PA6.6
with overmoulded seal



Cable entry system dimensions

Metal plate perforation dimensions

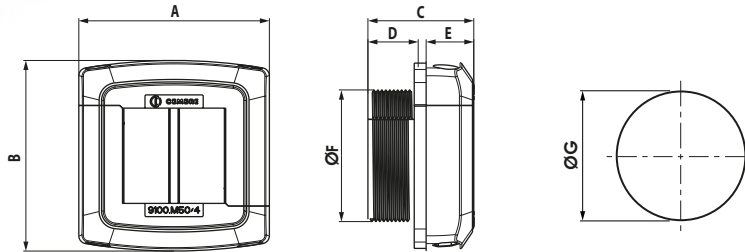
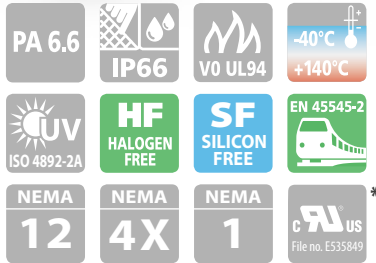

Diagram (grommets not included)

Marking/Approvals

Type

Grey (RAL 7035)

Black (RAL 9005)

Units in standard packaging

Units in minimum packaging

Dimensions and Weights

A

B

C

D

E

ØF

ØG

Weight

Material Specifications

Frame material

Light blue overmoulded seal material

Frame fastening screws material

Frame fastening nuts material

Technical Specifications

Silicon free

Halogen free

ISO 4892-2A

ROHS compliant

Self-extinguishing class (UL 94)

Temperature range (static)

IP rating (EN 60529)

Number of small grommets, type A

Number of large grommets, type B

Counter nut included

Certifications

NEMA performance

UL Standard

UL file number

Cable clamping according to EN 62444

Accessories upon request

Grommets

Punching set CEMBRE**

Split bushing



9100.M50/1

9100.M50/1N

10

10

72 mm

72 mm

40 mm

19 mm

18 mm

M50X1.5

50.5 mm

118 g

PA6.6 + GF

Thermoplastic elastomer (TPE)

Stainless steel (M5x55) Class A2

Stainless steel Class A2

YES

YES

YES

YES

V0

-40°C to +140°C

IP 66

-

1

1143M50

12, 4X indoor, 1

50E

*Pending

YES

1 x type B

RD50.5SS

9110.M50; 9110.M50N



9100.M50/4

9100.M50/4N

10

10

72 mm

72 mm

40 mm

19 mm

18 mm

M50X1.5

50.5 mm

120 g

PA6.6 + GF

Thermoplastic elastomer (TPE)

Stainless steel (M5x55) Class A2

Stainless steel Class A2

YES

YES

YES

YES

V0

-40°C to +140°C

IP 66

4

-

1143M50

12, 4X indoor, 1

50E

*Pending

YES

4 x type A

RD50.5SS

9110.M50; 9110.M50N

**see page 305, 343

CIRCULAR SPLIT CABLE ENTRY SYSTEMS FOR PREDETERMINED CABLES

9100.M63

made in glass-fibre reinforced polyamide PA6.6
with overmoulded seal

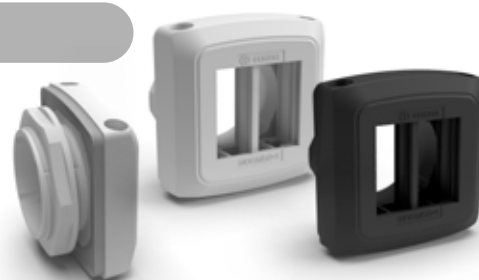

Cable entry system dimensions

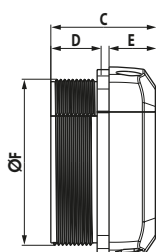
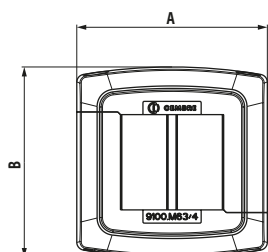

Metal plate perforation dimensions

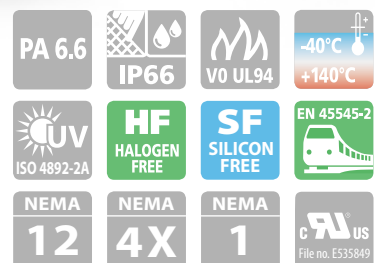
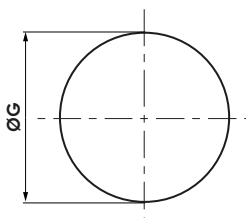

Diagram (grommets not included)



Marking/Approvals



Type

Grey (RAL 7035)

Black (RAL 9005)

Units in standard packaging

Units in minimum packaging

Dimensions and Weights

A

B

C

D

E

ØF

ØG

Weight

9100.M63/1

9100.M63/1N

10

10

72 mm

72 mm

40 mm

19 mm

18 mm

M63X1.5

64 mm

126 g

9100.M63/4

9100.M63/4N

10

10

72 mm

72 mm

40 mm

19 mm

18 mm

M63X1.5

64 mm

128 g

Material Specifications

Frame material

Light blue overmoulded seal material

Frame fastening screws material

Frame fastening nuts material

PA6.6 + GF

Thermoplastic elastomer (TPE)

Stainless steel (M5x55) Class A2

Stainless steel Class A2

PA6.6 + GF

Thermoplastic elastomer (TPE)

Stainless steel (M5x55) Class A2

Stainless steel Class A2

Technical Specifications

Silicon free

Halogen free

ISO 4892-2A

ROHS compliant

Self-extinguishing class (UL 94)

Temperature range (static)

IP rating (EN 60529)

Number of small grommets, type A

Number of large grommets, type B

Counter nut included

YES

YES

YES

YES

V0

-40°C to +140°C

IP 66

-

1

1143M63

YES

YES

YES

YES

V0

-40°C to +140°C

IP 66

4

-

1143M63

Certifications

NEMA performance

UL Standard

UL file number

Cable clamping according to EN 62444

12, 4X indoor, 1

50E

*Pending

YES

12, 4X indoor, 1

50E

*Pending

YES

Accessories upon request

Grommets

Punching set CEMBRE**

Split bushing

1 x type B

RD64SS

9110.M63 ; 9110.M63N

4 x type A

RD64SS

9110.M63 ; 9110.M63N

**see page 305, 343

9.A1D

GROMMETS FOR SPLIT CABLE ENTRY SYSTEMS

in Thermoplastic elastomer (TPE) - Type A small

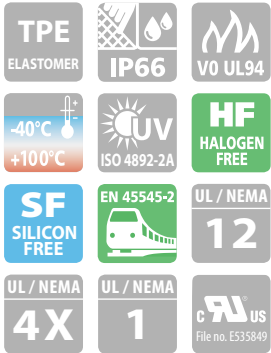
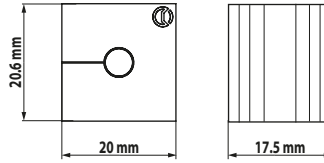

Diagram	Type A	Colour	No. Holes	Hole Position	Cable diameter mm	Weight g	Standard/minimum packaging
	9.AD0	Grey	0	-	-	7.0	100/10
	9.AD0N	Black	0	-	-	7.0	100/10
	9.A1D1	Grey	1	Central	1-2	7.0	100/10
	9.A1D1N	Black	1	Central	1-2	7.0	100/10
	9.A1D2	Grey	1	Central	2-3	6.9	100/10
	9.A1D2N	Black	1	Central	2-3	6.9	100/10
	9.A1D3	Grey	1	Central	3-4	6.9	100/10
	9.A1D3N	Black	1	Central	3-4	6.9	100/10
	9.A1D4	Grey	1	Central	4-5	6.8	100/10
	9.A1D4N	Black	1	Central	4-5	6.8	100/10
	9.A1D5	Grey	1	Central	5-6	6.6	100/10
	9.A1D5N	Black	1	Central	5-6	6.6	100/10
	9.A1D6	Grey	1	Central	6-7	6.4	100/10
	9.A1D6N	Black	1	Central	6-7	6.4	100/10
	9.A1D7	Grey	1	Central	7-8	6.2	100/10
	9.A1D7N	Black	1	Central	7-8	6.2	100/10
	9.A1D8	Grey	1	Central	8-9	6.0	100/10
	9.A1D8N	Black	1	Central	8-9	6.0	100/10
	9.A1D9	Grey	1	Central	9-10	5.8	100/10
	9.A1D9N	Black	1	Central	9-10	5.8	100/10
	9.A1D10	Grey	1	Central	10-11	5.5	100/10
	9.A1D10N	Black	1	Central	10-11	5.5	100/10
	9.A1D11	Grey	1	Central	11-12	5.2	100/10
	9.A1D11N	Black	1	Central	11-12	5.2	100/10
	9.A1D12	Grey	1	Central	12-13	4.8	100/10
	9.A1D12N	Black	1	Central	12-13	4.8	100/10
	9.A1D13	Grey	1	Central	13-14	4.4	100/10
	9.A1D13N	Black	1	Central	13-14	4.4	100/10
	9.A1D14	Grey	1	Central	14-15	4.0	100/10
	9.A1D14N	Black	1	Central	14-15	4.0	100/10
	9.A1D15	Grey	1	Central	15-16	3.6	100/10
	9.A1D15N	Black	1	Central	15-16	3.6	100/10
	9.A1D16	Grey	1	Central	16-16.5	3.4	100/10
	9.A1D16N	Black	1	Central	16-16.5	3.4	100/10
	9.A1D17	Grey	1	Central	16.5-17	3.2	100/10
	9.A1D17N	Black	1	Central	16.5-17	3.2	100/10

Material: THERMOPLASTIC ELASTOMER (TPE)
 self-extinguishing cl. V0 (UL 94)
 Operating temperature range:
 -40°C to +100°C (static)
 Colour:
 • grey RAL 7004
 • black RAL 9005

Application range:
 suitable for housing and clamping
 even pre-wired cables, ensuring
 that the system retains its **IP 66 (EN 60529) protection rating**.
 To be inserted into the seats of the
 frames.

Certifications:
 • UL/NEMA performance:
 12, 4X indoor, 1
 • UL Standard: 50E
 • UL file number: E535849
 • Cable clamping according to
 EN 62444

GROMMETS FOR SPLIT CABLE ENTRY SYSTEMS

9.A2D

in Thermoplastic elastomer (TPE) - Type A small

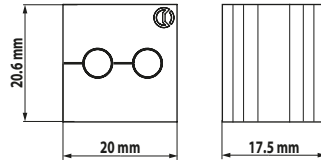
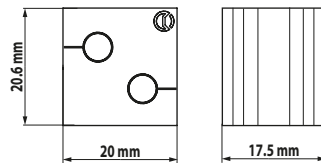
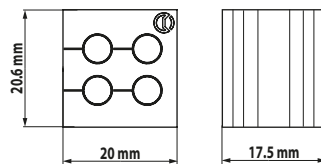

Diagram	Type A	Colour	No. Holes	Hole Position	Cable diameter mm	Weight g	Standard/minimum packaging
	9.A2D2	Grey	2	2 X Standard	2-3	6.9	100/10
	9.A2D2N	Black	2	2 X Standard	2-3	6.9	100/10
	9.A2D3	Grey	2	2 X Standard	3-4	6.7	100/10
	9.A2D3N	Black	2	2 X Standard	3-4	6.7	100/10
	9.A2D4	Grey	2	2 X Standard	4-5	6.5	100/10
	9.A2D4N	Black	2	2 X Standard	4-5	6.5	100/10
	9.A2D5	Grey	2	2 X Standard	5-6	6.2	100/10
	9.A2D5N	Black	2	2 X Standard	5-6	6.2	100/10
	9.A2D6	Grey	2	2 X Standard	6-7	5.9	100/10
	9.A2D6N	Black	2	2 X Standard	6-7	5.9	100/10



	9.A2D7	Grey	2	2 X Oblique	7-8	5.5	100/10
	9.A2D7N	Black	2	2 X Oblique	7-8	5.5	100/10
	9.A2D8	Grey	2	2 X Oblique	8-9	5.0	100/10
	9.A2D8N	Black	2	2 X Oblique	8-9	5.0	100/10



	9.A4D2	Grey	4	4 X Standard	2-3	6.7	100/10
	9.A4D2N	Black	4	4 X Standard	2-3	6.7	100/10
	9.A4D3	Grey	4	4 X Standard	3-4	6.4	100/10
	9.A4D3N	Black	4	4 X Standard	3-4	6.4	100/10
	9.A4D4	Grey	4	4 X Standard	4-5	6.0	100/10
	9.A4D4N	Black	4	4 X Standard	4-5	6.0	100/10
	9.A4D5	Grey	4	4 X Standard	5-6	5.4	100/10
	9.A4D5N	Black	4	4 X Standard	5-6	5.4	100/10
	9.A4D6	Grey	4	4 X Standard	6-7	4.7	100/10
	9.A4D6N	Black	4	4 X Standard	6-7	4.7	100/10

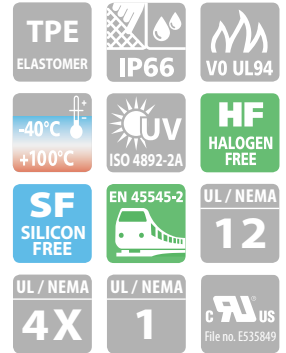

Material: THERMOPLASTIC ELASTOMER (TPE)
 self-extinguishing cl. V0 (UL 94)
 Operating temperature range: -40°C to +100°C (static)
 Colour:
 • grey RAL 7004
 • black RAL 9005

Application range:
 suitable for housing and clamping even pre-wired cables, ensuring that the system retains its **IP 66 (EN 60529) protection rating**.
 To be inserted into the seats of the frames.

Certifications:
 • UL/NEMA performance: 12, 4X indoor, 1
 • UL Standard: 50E
 • UL file number: E535849
 • Cable clamping according to EN 62444

9.B1D

GROMMETS FOR SPLIT CABLE ENTRY SYSTEMS

in Thermoplastic elastomer (TPE) - Type B large

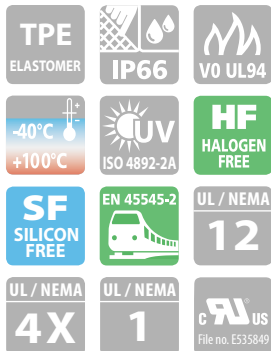
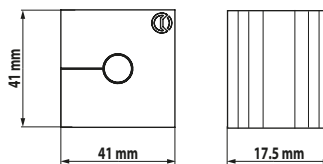
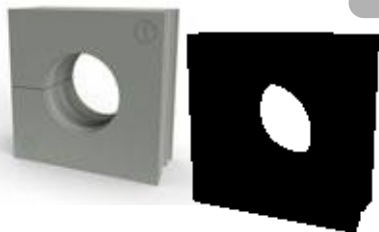

Diagram	Type B	Colour	No. Holes	Hole Position	Cable diameter mm	Weight g	Standard/minimum packaging
	9.BD0	Grey	0	-	-	30	30/10
	9.BD0N	Black	0	-	-	30	30/10
	9.B1D16	Grey	1	Central	16-17	26	30/10
	9.B1D16N	Black	1	Central	16-17	26	30/10
	9.B1D17	Grey	1	Central	17-18	25	30/10
	9.B1D17N	Black	1	Central	17-18	25	30/10
	9.B1D18	Grey	1	Central	18-19	25	30/10
	9.B1D18N	Black	1	Central	18-19	25	30/10
	9.B1D19	Grey	1	Central	19-20	24	30/10
	9.B1D19N	Black	1	Central	19-20	24	30/10
	9.B1D20	Grey	1	Central	20-21	24	30/10
	9.B1D20N	Black	1	Central	20-21	24	30/10
	9.B1D21	Grey	1	Central	21-22	23	30/10
	9.B1D21N	Black	1	Central	21-22	23	30/10
	9.B1D22	Grey	1	Central	22-23	22	30/10
	9.B1D22N	Black	1	Central	22-23	22	30/10
	9.B1D23	Grey	1	Central	23-24	22	30/10
	9.B1D23N	Black	1	Central	23-24	22	30/10
	9.B1D24	Grey	1	Central	24-25	21	30/10
	9.B1D24N	Black	1	Central	24-25	21	30/10
	9.B1D25	Grey	1	Central	25-26	20	30/10
	9.B1D25N	Black	1	Central	25-26	20	30/10
	9.B1D26	Grey	1	Central	26-27	20	30/10
	9.B1D26N	Black	1	Central	26-27	20	30/10
	9.B1D27	Grey	1	Central	27-28	19	30/10
	9.B1D27N	Black	1	Central	27-28	19	30/10
	9.B1D28	Grey	1	Central	28-29	18	30/10
	9.B1D28N	Black	1	Central	28-29	18	30/10
	9.B1D29	Grey	1	Central	29-30	17	30/10
	9.B1D29N	Black	1	Central	29-30	17	30/10
	9.B1D30	Grey	1	Central	30-31	16	30/10
	9.B1D30N	Black	1	Central	30-31	16	30/10
	9.B1D31	Grey	1	Central	31-32	15	30/10
	9.B1D31N	Black	1	Central	31-32	15	30/10
	9.B1D32	Grey	1	Central	32-33	14	30/10
	9.B1D32N	Black	1	Central	32-33	14	30/10
	9.B1D33	Grey	1	Central	33-34	13	30/10
	9.B1D33N	Black	1	Central	33-34	13	30/10
	9.B1D34	Grey	1	Central	34-35	12	30/10
	9.B1D34N	Black	1	Central	34-35	12	30/10

Material: THERMOPLASTIC ELASTOMER (TPE)
 self-extinguishing cl. V0 (UL 94)
 Operating temperature range:
 -40°C to +100°C (static)
 Colour:
 • grey RAL 7004
 • black RAL 9005

Application range:
 suitable for housing and clamping
 even pre-wired cables, ensuring
 that the system retains its **IP 66 (EN 60529) protection rating**.
 To be inserted into the seats of the
 frames.

Certifications:
 • UL/NEMA performance:
 12, 4X indoor, 1
 • UL Standard: 50E
 • UL file number: E535849
 • Cable clamping according to
 EN 62444

BLINDPLUGS

in Polyamide PA6.6

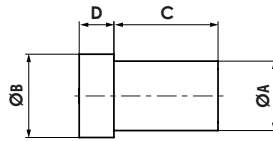

9005.D

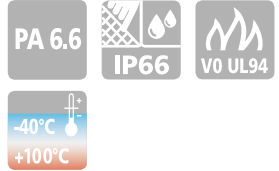

Type	Colour	ØA mm	ØB mm	C mm	D mm	Standard/minimum packaging
9005.D2	White <input type="checkbox"/>	2	4	20	5	250/25
9005.D3	White <input type="checkbox"/>	3	5	20	5	250/25
9005.D4	White <input type="checkbox"/>	4	6	20	5	250/25
9005.D5	White <input type="checkbox"/>	5	7	20	5	250/25
9005.D6	White <input type="checkbox"/>	6	8	20	5	250/25
9005.D7	White <input type="checkbox"/>	7	9	20	5	250/25
9005.D8	White <input type="checkbox"/>	8	10	15	5	250/25
9005.D9	White <input type="checkbox"/>	9	11	15	5	250/25
9005.D10	White <input type="checkbox"/>	10	12	15	5	250/25
9005.D11	White <input type="checkbox"/>	11	13	15	5	250/25
9005.D12	White <input type="checkbox"/>	12	14	15	5	250/25
9005.D13	White <input type="checkbox"/>	13	15	15	5	250/25
9005.D14	White <input type="checkbox"/>	14	16	15	5	250/25
9005.D15	White <input type="checkbox"/>	15	17	15	5	250/25
9005.D16	White <input type="checkbox"/>	16	18	15	5	250/25
9005.D17	White <input type="checkbox"/>	17	19	15	5	250/25

Material: POLYAMIDE PA6.6
 Operating temperature range:
 -40°C to +100°C (static)
 Colour: White

Application range:
 suitable for closing unused
 grommet holes, ensuring that the
 system retains its **IP 66 (EN 60529)**
protection rating.

9006

RECTANGULAR FLAT SEALS

in Nitrile butadiene NBR 70 sh

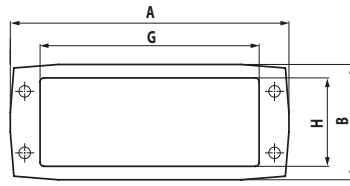

4 holes

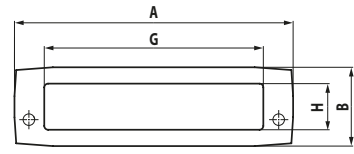

2 holes



Material:
NITRILE BUTADIENE NBR 70 sh
Operating temperature range:
from -30°C to +100°C
Colour: black

Application range:
suitable for maintaining IP 66
(EN 60529) protection rating on
uneven walls.

Type	For Cable Entry system Type	Holes	Colour	A mm	B mm	G mm	H mm	Standard/minimum packaging
9006.Q	9000.Q	4	Black	72	60	45	45	100/10
9006.10	9000.10	4	Black	98	60	67	46	100/10
9006.16	9000.16	4	Black	118	60	88	46	100/10
9006.24	9000.24	4	Black	145	60	114	46	100/10
9006.R/2	9000.R/2	2	Black	72	41	45	24	100/10
9006.R/3	9000.R/3	2	Black	98	41	67	24	100/10
9006.R/4	9000.R/4	2	Black	118	41	88	24	100/10
9006.R/5	9000.R/5	2	Black	145	41	114	24	100/10

INTUMESCENT GASKETS FOR FIRE BARRIERS

9007FR

in intumescent graphite-based material



Gasket dimensions

Metal plate perforation dimensions

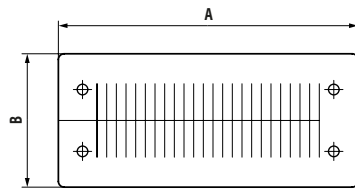

4 holes

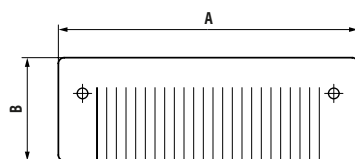
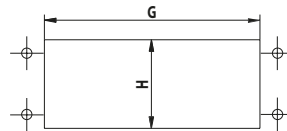

2 holes

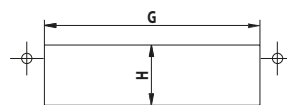

Type	For Cable Entry system Type	Holes	Colour	A mm	B mm	G mm	H mm	Standard/minimum packaging
9007FR.Q	9000.Q	4	Dark grey	83	69	43	43	50/10
9007FR.10	9000.10	4	Dark grey	108	69	65	36/46	50/10
9007FR.16	9000.16	4	Dark grey	128	69	86	36/46	50/10
9007FR.24	9000.24	4	Dark grey	155	69	112	36/46	50/10
9007FR.R/2	9000.R/2	2	Dark grey	83	50	43	24	50/10
9007FR.R/3	9000.R/3	2	Dark grey	108	50	65	24	50/10
9007FR.R/4	9000.R/4	2	Dark grey	128	50	86	24	50/10
9007FR.R/5	9000.R/5	2	Dark grey	155	50	112	24	50/10

The seals are made of a flexible graphite-based intumescent material.

This material expands when exposed to high temperatures. A stable and compact foam is formed that quickly closes spaces and other openings.

This foam acts as a barrier and prevents the propagation of heat, fire and smoke.

Material:
INTUMESCENT graphite-based

Colour: Dark grey

Field of application:
the intumescent seals of the 9007FR series are used on EWO series frames for fire protection according to EN45545-3



adhesive intumescent seal on a roll (5000x18x2.5)

Type	For Cable Entry system Type	Colour	Number of Cable Entry that can be set up with 1 roll	Standard/minimum packaging
9007FR/ROLL	9000.Q	Dark grey	14 pcs	1 roll (5 metres)
	9000.10		12 pcs	
	9000.16		11 pcs	
	9000.24		10 pcs	
	9000.R/2		16 pcs	
	9000.R/3		14 pcs	
	9000.R/4		12 pcs	
	9000.R/5		11 pcs	

accessories on request

Accessories on request	Description	Standard/minimum packaging
Stainless steel screws for wall mounting	9001.M5X25	40
	9001.M5X35	40
	9001.M5X40	40
Stainless steel washers under the screw heads	9001.D5XL	40

9020

PUSH-FIT MOUNTS

in Polyphenylene PPE + Polystyrene PS

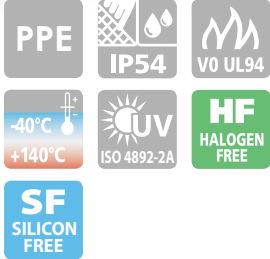

Dimensions of push-fit mounts

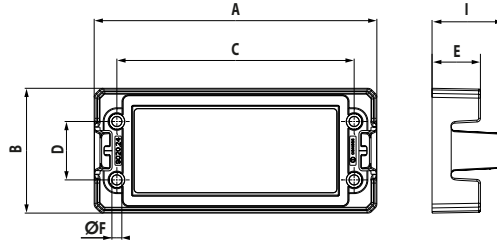

Metal plate perforation dimensions

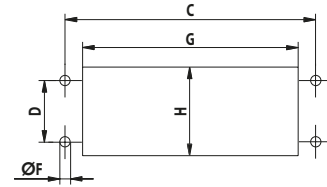

Marking/Approvals



Type

Black (RAL 9005) ■

Units in standard packaging

Units in minimum packaging

9020.Q

10

10

9020.10

10

10

9020.16

10

10

9020.24

10

10

Dimensions and Weights

A	83 mm
B	68 mm
C	58 mm
D	32 mm
E	26.5 mm
ØF	5.5 mm
G	43 mm
H	43 mm
I	39.3 mm
Weight	60 g

A	107 mm
B	68 mm
C	83 mm
D	32 mm
E	26.5 mm
ØF	5.5 mm
G	65 mm
H	36/46 mm
I	39.3 mm
Weight	72 g

A	128 mm
B	68 mm
C	103 mm
D	32 mm
E	26.5 mm
ØF	5.5 mm
G	86 mm
H	36/46 mm
I	39.3 mm
Weight	80 g

A	155 mm
B	68 mm
C	130 mm
D	32 mm
E	26.5 mm
ØF	5.5 mm
G	112 mm
H	36/46 mm
I	39.3 mm
Weight	91 g

A	155 mm
B	68 mm
C	130 mm
D	32 mm
E	26.5 mm
ØF	5.5 mm
G	112 mm
H	36/46 mm
I	39.3 mm
Weight	91 g

Material Specifications

Frame material	PPE + PS
Integrated sale material	Nitrile butadiene NBR 70 sh

Frame material	PPE + PS
Integrated sale material	Nitrile butadiene NBR 70 sh

Frame material	PPE + PS
Integrated sale material	Nitrile butadiene NBR 70 sh

Frame material	PPE + PS
Integrated sale material	Nitrile butadiene NBR 70 sh

Frame material	PPE + PS
Integrated sale material	Nitrile butadiene NBR 70 sh

Technical Specifications

Silicon free	YES
Halogen free	YES
ISO 4892-2A	YES
ROHS compliant	YES
Self-extinguishing class (UL 94)	V0
Temperature range (static)	-40°C to +140°C
IP rating (EN 60529)	IP 54

Silicon free	YES
Halogen free	YES
ISO 4892-2A	YES
ROHS compliant	YES
Self-extinguishing class (UL 94)	V0
Temperature range (static)	-40°C to +140°C
IP rating (EN 60529)	IP 54

Silicon free	YES
Halogen free	YES
ISO 4892-2A	YES
ROHS compliant	YES
Self-extinguishing class (UL 94)	V0
Temperature range (static)	-40°C to +140°C
IP rating (EN 60529)	IP 54

Silicon free	YES
Halogen free	YES
ISO 4892-2A	YES
ROHS compliant	YES
Self-extinguishing class (UL 94)	V0
Temperature range (static)	-40°C to +140°C
IP rating (EN 60529)	IP 54

Silicon free	YES
Halogen free	YES
ISO 4892-2A	YES
ROHS compliant	YES
Self-extinguishing class (UL 94)	V0
Temperature range (static)	-40°C to +140°C
IP rating (EN 60529)	IP 54

Accessories upon request

Stainless steel screws for wall attachment	9001.M5X20
Punching set CEMBRE*	RD43X43

Stainless steel screws for wall attachment	9001.M5X20
Punching set CEMBRE*	RD46X65 ; RD36X65

Stainless steel screws for wall attachment	9001.M5X20
Punching set CEMBRE*	RD46X86 ; RD36X86

Stainless steel screws for wall attachment	9001.M5X20
Punching set CEMBRE*	RD46X112 ; RD36X112

Stainless steel screws for wall attachment	9001.M5X20
Punching set CEMBRE*	RD46X112 ; RD36X112

*see page 305, 343

CLOSING PLATES WITH SCREWS

made of glass-fibre reinforced Polypropylene

9010



Dimensions of closing plates

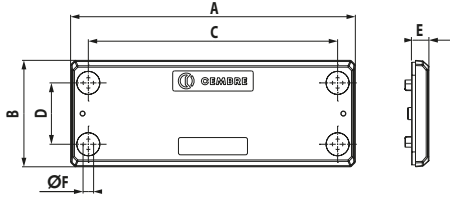

Metal plate perforation dimensions

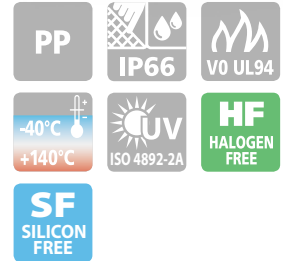
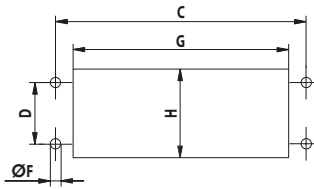

Marking/Approvals	RoHS COMPLIANT 2011/65/EU CE UK CA	RoHS COMPLIANT 2011/65/EU CE UK CA	RoHS COMPLIANT 2011/65/EU CE UK CA	RoHS COMPLIANT 2011/65/EU CE UK CA
Type				
Black (RAL 9005) ■	9010.Q	9010.10	9010.16	9010.24
Units in standard packaging	10	10	10	10
Units in minimum packaging	10	10	10	10
Dimensions and Weights				
A	76.5 mm	101.5 mm	121.5 mm	148.5 mm
B	55.5 mm	55.5 mm	55.5 mm	55.5 mm
C	58 mm	83 mm	103 mm	130 mm
D	32 mm	32 mm	32 mm	32 mm
E	9 mm	9 mm	9 mm	9 mm
ØF	5.5 mm	5.5 mm	5.5 mm	5.5 mm
G	43 mm	65 mm	86 mm	112 mm
H	43 mm	36/46 mm	36/46 mm	36/46 mm
Weight	23 g	30 g	35 g	41 g
Material Specifications				
Frame material	PP + GF	PP + GF	PP + GF	PP + GF
Black overmoulded seal material	Thermoplastic elastomer (TPE)	Thermoplastic elastomer (TPE)	Thermoplastic elastomer (TPE)	Thermoplastic elastomer (TPE)
Technical Specifications				
Silicon free	YES	YES	YES	YES
Halogen free	YES	YES	YES	YES
ISO 4892-2A	YES	YES	YES	YES
ROHS compliant	YES	YES	YES	YES
Self-extinguishing class (UL 94)	V0	V0	V0	V0
Temperature range (static)	-40°C to +140°C	-40°C to +140°C	-40°C to +140°C	-40°C to +140°C
IP rating (EN 60529)	IP 66	IP 66	IP 66	IP 66
Accessories upon request				
Stainless steel screws for wall attachment	9001.M5X20	9001.M5X20	9001.M5X20	9001.M5X20
Punching set CEMBRE*	RD43X43	RD46X65 ; RD36X65	RD46X86 ; RD36X86	RD46X112 ; RD36X112

*see page 305, 343

9010-SO

SNAP-ON CLOSING PLATES

made of glass-fibre reinforced Polypropylene



Dimensions of closing plates

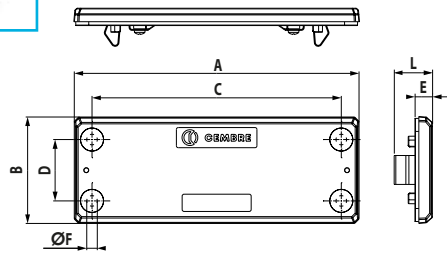

Metal plate perforation dimensions

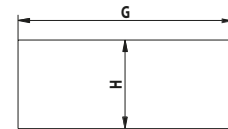

Marking/Approvals



Type

Black (RAL 9005) ■

Units in standard packaging

Units in minimum packaging

Dimensions and Weights

A	76.5 mm
B	55.5 mm
C	58 mm
D	32 mm
E	9 mm
ØF	5.5 mm
G	43 mm
H	43 mm
L	20 mm
Weight	30 g

9010.Q-SO

10

10

9010.10-SO

10

10

9010.16-SO

10

10

9010.24-SO

10

10

Material Specifications

Frame material	PP + GF
Black overmoulded seal material	Thermoplastic elastomer (TPE)
Spring material	Inox

PP + GF
Thermoplastic elastomer (TPE)
Inox

PP + GF
Thermoplastic elastomer (TPE)
Inox

PP + GF
Thermoplastic elastomer (TPE)
Inox

PP + GF
Thermoplastic elastomer (TPE)
Inox

Technical Specifications

Silicon free	YES
Halogen free	YES
ISO 4892-2A	YES
ROHS compliant	YES
Self-extinguishing class (UL 94)	V0
Temperature range (static)	-40°C to +140°C
IP rating (EN 60529)	IP 54
Fastening on sheet metal thicknesses	1.5 to 4 mm

YES
YES
YES
YES
V0
-40°C to +140°C
IP 54
1.5 to 4 mm

YES
YES
YES
YES
V0
-40°C to +140°C
IP 54
1.5 to 4 mm

YES
YES
YES
YES
V0
-40°C to +140°C
IP 54
1.5 to 4 mm

YES
YES
YES
YES
V0
-40°C to +140°C
IP 54
1.5 to 4 mm

Accessories upon request

Punching set CEMBRE*

RD43X43

RD46X65 ; RD36X65

RD46X86 ; RD36X86

RD46X112 ; RD36X112

*see page 305, 343

9110

SPLIT BUSHING FOR CIRCULAR SPLIT CABLE ENTRY SYSTEMS

in Polyamide PA6

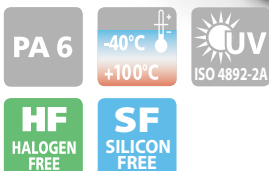
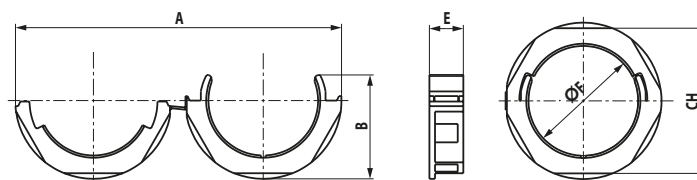

Type	Colour	ØF mm	A mm	B mm	E mm	CH mm	Weight g	Standard/minimum packaging
9110.M25	Grey ■	M25x1.5	74	23	9	32	3	100/10
9110.M25N	Black ■	M25x1.5	74	23	9	32	3	100/10
9110.M32	Grey ■	M32x1.5	92	29	12	40	6	50/10
9110.M32N	Black ■	M32x1.5	92	29	12	40	6	50/10
9110.M50	Grey ■	M50x1.5	144	46	15	64	18	20/10
9110.M50N	Black ■	M50x1.5	144	46	15	64	18	20/10

CABLE ENTRY WITH MEMBRANE TWO-COMPONENT FOR UNMARKED CABLES SERIES 9200

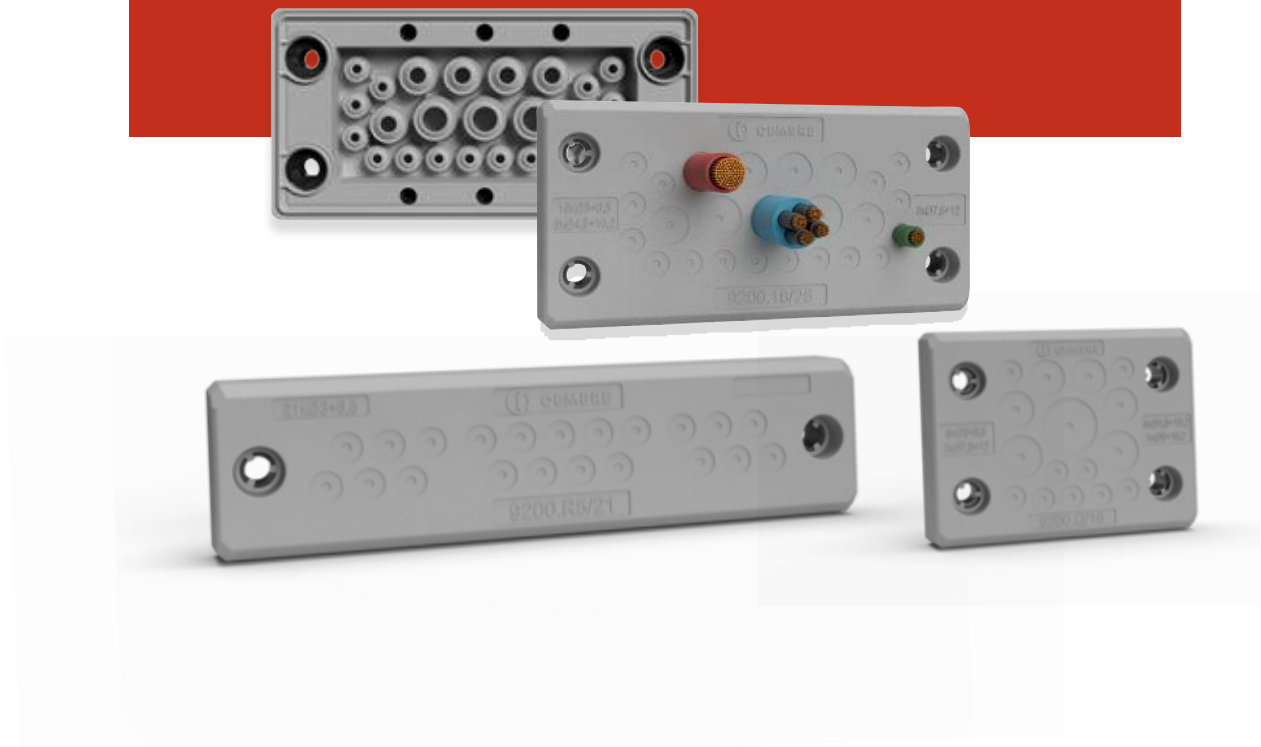

9200.Q

MEMBRANE CABLE ENTRY FOR UNMARKED CABLES

in glass fibre reinforced PP polypropylene + TPE elastomer



NEW PP TPE ELASTOMER

IP66 V0 UL94 -40°C +100°C

UV ISO 4892-2A HF HALOGEN FREE SF SILICON FREE

EN 45545-2 C RU US *

Cable entry system dimensions

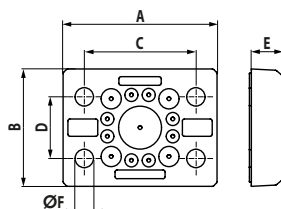

Metal plate perforation dimensions

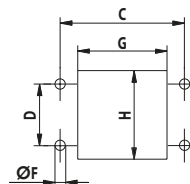

Diagram			
Marking/Approvals	RoHS COMPLIANT 2011/65/EU CE UK CA	RoHS COMPLIANT 2011/65/EU CE UK CA	RoHS COMPLIANT 2011/65/EU CE UK CA
Type	9200.Q/13	9200.Q/16	9200.Q/25
Grey (RAL 7004) <input type="checkbox"/>			
Units in standard packaging	10	10	10
Units in minimum packaging	10	10	10
Dimensions and Weights			
A	80 mm	80 mm	80 mm
B	61 mm	61 mm	61 mm
C	58 mm	58 mm	58 mm
D	32 mm	32 mm	32 mm
E	16 mm	16 mm	16 mm
ØF	5.5 mm	5.5 mm	5.5 mm
G	43 mm	43 mm	43 mm
H	43 mm	43 mm	43 mm
Weight	60 g	60 g	60 g
Material Specifications			
Frame material	PP + GF	PP + GF	PP + GF
Overmoulded material	TPE elastomer	TPE elastomer	TPE elastomer
Technical Specifications			
Silicon free	YES	YES	YES
Halogen free	YES	YES	YES
ISO 4892-2A	YES	YES	YES
ROHS compliant	YES	YES	YES
Self-extinguishing class (UL 94)	V0	V0	V0
Temperature range (static)	-40°C a +100°C	-40°C a +100°C	-40°C a +100°C
IP rating (EN 60529)	IP 66	IP 66	IP 66
Total number of cables	13	16	25
Number of cables x cable Ø range	8 x Ø 3÷6.5 mm 4 x Ø 4.8÷10.2 mm 1 x Ø 16÷22 mm	9 x Ø 3÷6.5 mm 4 x Ø 4.8÷10.2 mm 2 x Ø 7.5÷12 mm 1 x Ø 9÷16.2 mm	25 x Ø 3÷6.5 mm
Certifications			
NEMA performance	12	12	12
UL Standard	50E	50E	50E
UL file number	*Pending	*Pending	*Pending
Accessories upon request			
Stainless steel screws for wall attachment	9001.M5X20	9001.M5X20	9001.M5X20
Punching set CEMBRE**	RD43X43	RD43X43	RD43X43

**see page 305, 343

MEMBRANE CABLE ENTRY FOR UNMARKED CABLES

9200.R5

in glass fibre reinforced PP polypropylene + TPE elastomer



Cable entry system dimensions

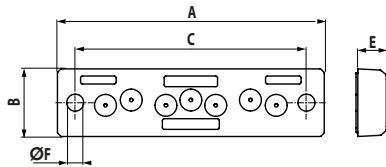

Metal plate perforation dimensions

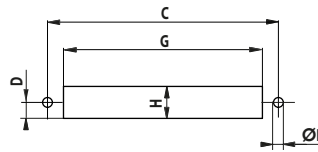

Diagram

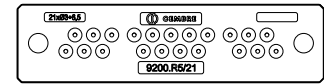
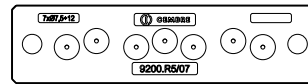

Marking/Approvals



Type

Grey (RAL 7004)

Units in standard packaging

Units in minimum packaging

Dimensions and Weights

A

B

C

D

E

ØF

G

H

Weight

9200.R5/7

10

10

9200.R5/21

10

10

Material Specifications

Frame material

Overmoulded material

PP + GF

TPE elastomer

PP + GF

TPE elastomer

Technical Specifications

Silicon free

Halogen free

ISO 4892-2A

ROHS compliant

Self-extinguishing class (UL 94)

Temperature range (static)

IP rating (EN 60529)

Total number of cables

Number of cables x cable Ø range

YES

YES

YES

YES

V0

-40°C a +100°C

IP 66

7

7 x Ø 7.5÷12 mm

YES

YES

YES

YES

V0

-40°C a +100°C

IP 66

21

21 x Ø 3÷6.5 mm

Certifications

NEMA performance

UL Standard

UL file number

12

50E

*Pending

12

50E

*Pending

Accessories upon request

Stainless steel screws for wall attachment

Punching set CEMBRE**

9001.M5X25

RD24X112

9001.M5X25

RD24X112

**see page 305, 343

in glass fibre reinforced PP polypropylene + TPE elastomer



Cable entry system dimensions

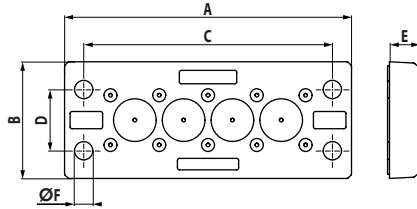

Metal plate perforation dimensions

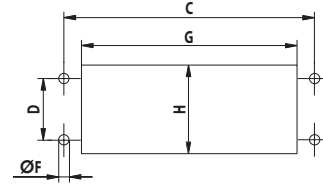

Diagram

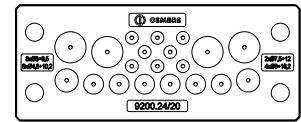
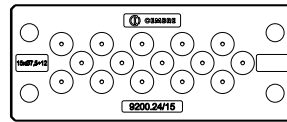
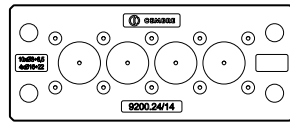

Marking/Approvals



Type

Grey (RAL 7004)

Units in standard packaging

Units in minimum packaging

Dimensions and Weights

A	150 mm
B	61 mm
C	130 mm
D	32 mm
E	16 mm
ØF	5.5 mm
G	112 mm
H	36/46 mm
Weight	110 g

9200.24/14
10
10

9200.24/15
10
10

9200.24/20
10
10

Material Specifications

Frame material	PP + GF
Overmoulded material	TPE elastomer

PP + GF
TPE elastomer

PP + GF
TPE elastomer

PP + GF
TPE elastomer

Technical Specifications

Silicon free	YES
Halogen free	YES
ISO 4892-2A	YES
ROHS compliant	YES
Self-extinguishing class (UL 94)	V0
Temperature range (static)	-40°C a +100°C
IP rating (EN 60529)	IP 66
Total number of cables	14

YES
YES
YES
YES
V0
-40°C a +100°C
IP 66
14

YES
YES
YES
YES
V0
-40°C a +100°C
IP 66
15

YES
YES
YES
YES
V0
-40°C a +100°C
IP 66
20

Number of cables x cable Ø range

10 x Ø 3÷6.5 mm
4 x Ø 16÷22 mm

15 x Ø 7.5÷12 mm

8 x Ø 3÷6.5 mm
6 x Ø 4.8÷10.2 mm
2 x Ø 7.5÷12 mm
4 x Ø 9÷16.2 mm

Certifications

NEMA performance	12
UL Standard	50E
UL file number	*Pending

12
50E
*Pending

12
50E
*Pending

12
50E
*Pending

Accessories upon request

Stainless steel screws for wall attachment	9001.M5X20
Punching set CEMBRE**	RD46X112; RD36X112

9001.M5X20
RD46X112; RD36X112

9001.M5X20
RD46X112; RD36X112

9001.M5X20
RD46X112; RD36X112

**see page 305, 343

MEMBRANE CABLE ENTRY FOR UNMARKED CABLES

9200.24

in glass fibre reinforced PP polypropylene + TPE elastomer



Cable entry system dimensions

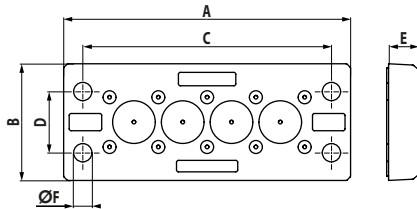

Metal plate perforation dimensions

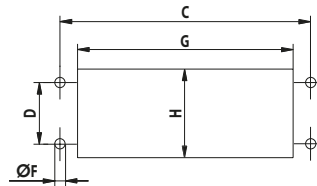

Diagram			
Marking/Approvals			
Type	Grey (RAL 7004) <input type="checkbox"/>		
Units in standard packaging	10	10	10
Units in minimum packaging	10	10	10
Dimensions and Weights			
A	150 mm	150 mm	150 mm
B	61 mm	61 mm	61 mm
C	130 mm	130 mm	130 mm
D	32 mm	32 mm	32 mm
E	16 mm	16 mm	16 mm
ØF	5.5 mm	5.5 mm	5.5 mm
G	112 mm	112 mm	112 mm
H	36/46 mm	36/46 mm	36/46 mm
Weight	110 g	110 g	110 g
Material Specifications			
Frame material	PP + GF	PP + GF	PP + GF
Overmoulded material	TPE elastomer	TPE elastomer	TPE elastomer
Technical Specifications			
Silicon free	YES	YES	YES
Halogen free	YES	YES	YES
ISO 4892-2A	YES	YES	YES
ROHS compliant	YES	YES	YES
Self-extinguishing class (UL 94)	V0	V0	V0
Temperature range (static)	-40°C a +100°C	-40°C a +100°C	-40°C a +100°C
IP rating (EN 60529)	IP 66	IP 66	IP 66
Total number of cables	22	24	25
Number of cables x cable Ø range	6 x Ø 3÷6.5 mm 6 x Ø 4.8÷10.2 mm 10 x Ø 7.5÷12 mm	6 x Ø 3÷6.5 mm 16 x Ø 4.8÷10.2 mm 2 x Ø 7.5÷12 mm	12 x Ø 3÷6.5 mm 7 x Ø 4.8÷10.2 mm 6 x Ø 7.5÷12 mm
Certifications			
NEMA performance	12	12	12
UL Standard	50E	50E	50E
UL file number	*Pending	*Pending	*Pending
Accessories upon request			
Stainless steel screws for wall attachment	9001.M5X20	9001.M5X20	9001.M5X20
Punching set CEMBRE**	RD46X112; RD36X112	RD46X112; RD36X112	RD46X112; RD36X112

**see page 305, 343



NEW **PP** **TPE ELASTOMER**

IP66 **V0 UL94** **-40°C** **+100°C**

UV **HF HALOGEN FREE** **SF SILICON FREE**

EN 45545-2 **C** **UL US**

Cable entry system dimensions

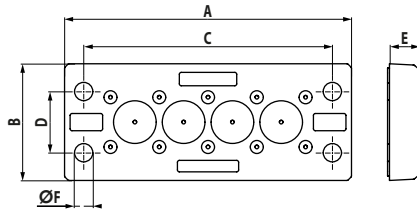

Metal plate perforation dimensions

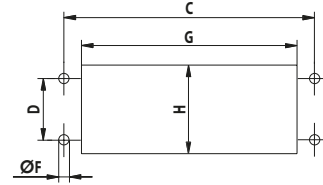

Diagram

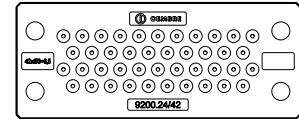
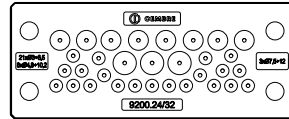
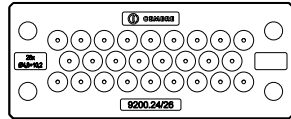

Marking/Approvals



Type

Grey (RAL 7004)

Units in standard packaging

Units in minimum packaging

Dimensions and Weights

A	150 mm
B	61 mm
C	130 mm
D	32 mm
E	16 mm
ØF	5.5 mm
G	112 mm
H	36/46 mm
Weight	110 g

9200.24/26
10
10

9200.24/32
10
10

9200.24/42
10
10

Material Specifications

Frame material	PP + GF
Overmoulded material	TPE elastomer

PP + GF
TPE elastomer

PP + GF
TPE elastomer

PP + GF
TPE elastomer

Technical Specifications

Silicon free	YES
Halogen free	YES
ISO 4892-2A	YES
ROHS compliant	YES
Self-extinguishing class (UL 94)	V0
Temperature range (static)	-40°C a +100°C
IP rating (EN 60529)	IP 66
Total number of cables	26

YES
YES
YES
YES
V0
-40°C a +100°C
IP 66
26

YES
YES
YES
YES
V0
-40°C a +100°C
IP 66
32

YES
YES
YES
YES
V0
-40°C a +100°C
IP 66
42

Number of cables x cable Ø range

26 x Ø 4.8÷10.2 mm

21 x Ø 3÷6.5 mm
8 x Ø 4.8÷10.2 mm
3 x Ø 7.5÷12 mm

42 x Ø 3÷6.5 mm

Certifications

NEMA performance	12
UL Standard	50E
UL file number	*Pending

12
50E
*Pending

12
50E
*Pending

12
50E
*Pending

Accessories upon request

Stainless steel screws for wall attachment	9001.M5X20
Punching set CEMBRE**	RD46X112; RD36X112

9001.M5X20
RD46X112; RD36X112

9001.M5X20
RD46X112; RD36X112

9001.M5X20
RD46X112; RD36X112

**see page 305, 343

**CABLE ENTRY
WITH MEMBRANE
IN RUBBER
FOR UNMARKED
CABLES
SERIES 9220 TYPE A**



9220.24

MEMBRANE CABLE ENTRY FOR UNMARKED CABLES

in TPE elastomer - Type A



Cable entry system dimensions

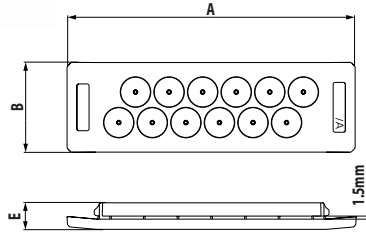

Metal plate perforation dimensions

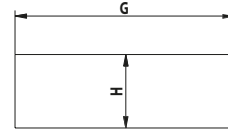

Diagram			
Marking/Approvals			
Type	9220.24/12A	9220.24/14A	9220.24/17A
Grey (RAL 7004) <input type="checkbox"/>			
Units in standard packaging	10	10	10
Units in minimum packaging	10	10	10
Dimensions and Weights			
A	142 mm	142 mm	142 mm
B	44 mm	44 mm	44 mm
E	13 mm	13 mm	13 mm
G	112 mm	112 mm	112 mm
H	36 mm	36 mm	36 mm
Metal plate thickness range	1.5÷2.5 mm	1.5÷2.5 mm	1.5÷2.5 mm
Weight	38 g	43 g	39 g
Material Specifications			
Printed material	TPE elastomer	TPE elastomer	TPE elastomer
Technical Specifications			
Silicon free	YES	YES	YES
Halogen free	YES	YES	YES
ISO 4892-2A	YES	YES	YES
ROHS compliant	YES	YES	YES
Self-extinguishing class (UL 94)	V0	V0	V0
Temperature range (static)	-40°C a +100°C	-40°C a +100°C	-40°C a +100°C
IP rating (EN 60529)	IP 64	IP 64	IP 64
Total number of cables	12	14	17
Number of cables x cable Ø range	12 x Ø 1÷15 mm	14 x Ø 1÷12.5 mm	12 x Ø 1÷13 mm 5 x Ø 1÷10 mm
Certifications			
NEMA performance	12	12	12
UL Standard	50E	50E	50E
UL file number	*Pending	*Pending	*Pending
Accessories upon request			
Punching set CEMBRE**	RD36X112	RD36X112	RD36X112

**see page 305, 343

MEMBRANE CABLE ENTRY FOR UNMARKED CABLES

9220.24

in TPE elastomer - Type A



Cable entry system dimensions

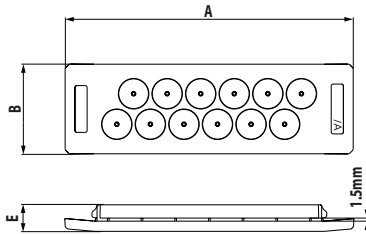

Metal plate perforation dimensions

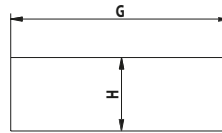

Diagram			
Marking/Approvals			
Type	Grey (RAL 7004)	Grey (RAL 7004)	Grey (RAL 7004)
Units in standard packaging	10	10	10
Units in minimum packaging	10	10	10
Dimensions and Weights			
A	142 mm	142 mm	142 mm
B	44 mm	44 mm	44 mm
E	13 mm	13 mm	13 mm
G	112 mm	112 mm	112 mm
H	36 mm	36 mm	36 mm
Metal plate thickness range	1.5÷2.5 mm	1.5÷2.5 mm	1.5÷2.5 mm
Weight	39 g	47 g	41 g
Material Specifications			
Printed material	TPE elastomer	TPE elastomer	TPE elastomer
Technical Specifications			
Silicon free	YES	YES	YES
Halogen free	YES	YES	YES
ISO 4892-2A	YES	YES	YES
ROHS compliant	YES	YES	YES
Self-extinguishing class (UL 94)	V0	V0	V0
Temperature range (static)	-40°C a +100°C	-40°C a +100°C	-40°C a +100°C
IP rating (EN 60529)	IP 64	IP 64	IP 64
Total number of cables	18	19	26
Number of cables x cable Ø range	4 x Ø 1 ÷ 16 mm 5 x Ø 1 ÷ 12,5 mm 5 x Ø 1 ÷ 11 mm 4 x Ø 1 ÷ 6,5 mm	7 x Ø 1 ÷ 13 mm 12 x Ø 1 ÷ 7 mm	4 x Ø 1 ÷ 16 mm 4 x Ø 1 ÷ 12 mm 16 x Ø 1 ÷ 6,5 mm 2 x ASI
Certifications			
NEMA performance	12	12	12
UL Standard	50E	50E	50E
UL file number	*Pending	*Pending	*Pending
Accessories upon request			
Punching set CEMBRE**	RD36X112	RD36X112	RD36X112

**see page 305, 343

9220.24

MEMBRANE CABLE ENTRY FOR UNMARKED CABLES

in TPE elastomer - Type A



Cable entry system dimensions

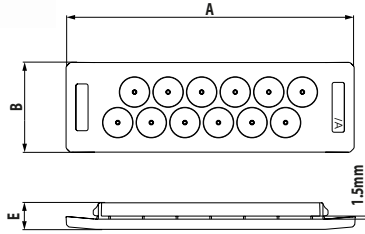

Metal plate perforation dimensions

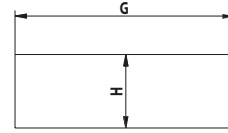

Diagram			
Marking/Approvals			
Type	9220.24/42A	9220.24/48A	9220.24/50A
Grey (RAL 7004) <input type="checkbox"/>			
Units in standard packaging	10	10	10
Units in minimum packaging	10	10	10
Dimensions and Weights			
A	142 mm	142 mm	142 mm
B	44 mm	44 mm	44 mm
E	13 mm	13 mm	13 mm
G	112 mm	112 mm	112 mm
H	36 mm	36 mm	36 mm
Metal plate thickness range	1.5÷2.5 mm	1.5÷2.5 mm	1.5÷2.5 mm
Weight	47 g	44 g	47 g
Material Specifications			
Printed material	TPE elastomer	TPE elastomer	TPE elastomer
Technical Specifications			
Silicon free	YES	YES	YES
Halogen free	YES	YES	YES
ISO 4892-2A	YES	YES	YES
ROHS compliant	YES	YES	YES
Self-extinguishing class (UL 94)	V0	V0	V0
Temperature range (static)	-40°C a +100°C	-40°C a +100°C	-40°C a +100°C
IP rating (EN 60529)	IP 64	IP 64	IP 64
Total number of cables	42	48	50
Number of cables x cable Ø range	12 x Ø 1 ÷ 7.5 mm 17 x Ø 1 ÷ 6.5 mm 12 x Ø 1 ÷ 5 mm 1 x Ø 1 ÷ 4.5 mm	48 x Ø 1 ÷ 6.5 mm	8 x Ø 1 ÷ 9.5 mm 9 x Ø 1 ÷ 6.5 mm 33 x Ø 1 ÷ 5 mm
Certifications			
NEMA performance	12	12	12
UL Standard	50E	50E	50E
UL file number	*Pending	*Pending	*Pending
Accessories upon request			
Punching set CEMBRE**	RD36X112	RD36X112	RD36X112

**see page 305, 343

**CABLE ENTRY
WITH MEMBRANE
IN RUBBER
FOR UNMARKED
CABLES
SERIES 9220 TYPE B**



9220.24

MEMBRANE CABLE ENTRY FOR UNMARKED CABLES

in TPE elastomer - Type B



Cable entry system dimensions

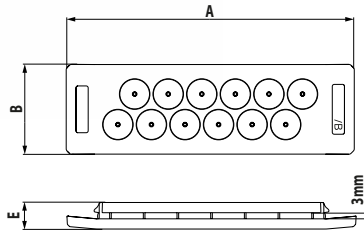

Metal plate perforation dimensions

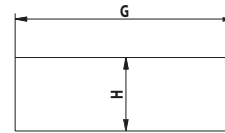

NEW

TPE ELASTOMER

IP64

V0 UL94

-40°C to +100°C

ISO 4892-2A

HF HALOGEN FREE

SF SILICON FREE

EN 45545-2 C

RU US

Diagram			
Marking/Approvals			
Type	9220.24/12B	9220.24/14B	9220.24/17B
Grey (RAL 7004) <input type="checkbox"/>			
Units in standard packaging	10	10	10
Units in minimum packaging	10	10	10
Dimensions and Weights			
A	142 mm	142 mm	142 mm
B	44 mm	44 mm	44 mm
E	13 mm	13 mm	13 mm
G	112 mm	112 mm	112 mm
H	36 mm	36 mm	36 mm
Metal plate thickness range	2.8÷4 mm	2.8÷4 mm	2.8÷4 mm
Weight	36 g	41 g	38 g
Material Specifications			
Printed material	TPE elastomer	TPE elastomer	TPE elastomer
Technical Specifications			
Silicon free	YES	YES	YES
Halogen free	YES	YES	YES
ISO 4892-2A	YES	YES	YES
ROHS compliant	YES	YES	YES
Self-extinguishing class (UL 94)	V0	V0	V0
Temperature range (static)	-40°C a +100°C	-40°C a +100°C	-40°C a +100°C
IP rating (EN 60529)	IP 64	IP 64	IP 64
Total number of cables	12	14	17
Number of cables x cable Ø range	12 x Ø 1÷15 mm	14 x Ø 1÷12.5 mm	12 x Ø 1÷13 mm 5 x Ø 1÷10 mm
Certifications			
NEMA performance	12	12	12
UL Standard	50E	50E	50E
UL file number	*Pending	*Pending	*Pending
Accessories upon request			
Punching set CEMBRE**	RD36X112	RD36X112	RD36X112

**see page 305, 343

MEMBRANE CABLE ENTRY FOR UNMARKED CABLES

in TPE elastomer - Type B

9220.24

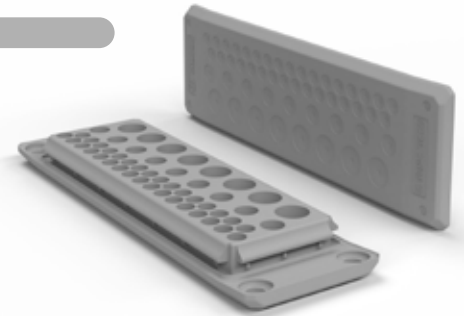

Cable entry system dimensions

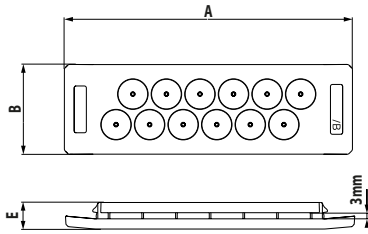

Metal plate perforation dimensions

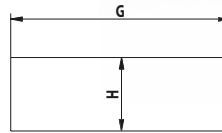

Diagram			
Marking/Approvals			
Type	Grey (RAL 7004) <input type="checkbox"/>	Grey (RAL 7004) <input type="checkbox"/>	Grey (RAL 7004) <input type="checkbox"/>
Units in standard packaging	10	10	10
Units in minimum packaging	10	10	10
Dimensions and Weights			
A	142 mm	142 mm	142 mm
B	44 mm	44 mm	44 mm
E	13 mm	13 mm	13 mm
G	112 mm	112 mm	112 mm
H	36 mm	36 mm	36 mm
Metal plate thickness range	2.8÷4 mm	2.8÷4 mm	2.8÷4 mm
Weight	38 g	45 g	39 g
Material Specifications			
Printed material	TPE elastomer	TPE elastomer	TPE elastomer
Technical Specifications			
Silicon free	YES	YES	YES
Halogen free	YES	YES	YES
ISO 4892-2A	YES	YES	YES
ROHS compliant	YES	YES	YES
Self-extinguishing class (UL 94)	V0	V0	V0
Temperature range (static)	-40°C a +100°C	-40°C a +100°C	-40°C a +100°C
IP rating (EN 60529)	IP 64	IP 64	IP 64
Total number of cables	18	19	26
Number of cables x cable Ø range	4 x Ø 1 ÷ 16 mm 5 x Ø 1 ÷ 12,5 mm 5 x Ø 1 ÷ 11 mm 4 x Ø 1 ÷ 6,5 mm	7 x Ø 1 ÷ 13 mm 12 x Ø 1 ÷ 7 mm	4 x Ø 1 ÷ 16 mm 4 x Ø 1 ÷ 12 mm 16 x Ø 1 ÷ 6,5 mm 2 x ASI
Certifications			
NEMA performance	12	12	12
UL Standard	50E	50E	50E
UL file number	*Pending	*Pending	*Pending
Accessories upon request			
Punching set CEMBRE**	RD36X112	RD36X112	RD36X112

**see page 305, 343

9220.24

MEMBRANE CABLE ENTRY FOR UNMARKED CABLES

in TPE elastomer - Type B

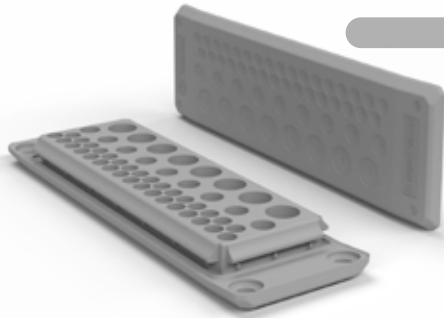

Cable entry system dimensions

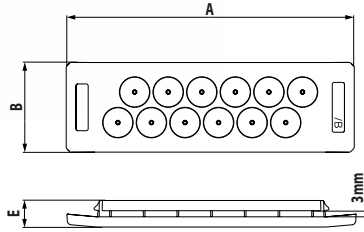

Metal plate perforation dimensions

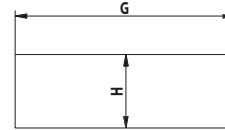

Diagram

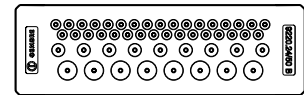
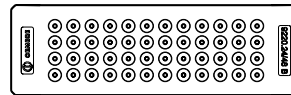
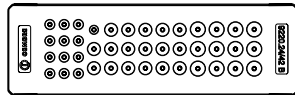

Marking/Approvals



Type

Grey (RAL 7004)

Units in standard packaging

Units in minimum packaging

Dimensions and Weights

A	142 mm
B	44 mm
E	13 mm
G	112 mm
H	36 mm
Metal plate thickness range	2.8÷4 mm
Weight	46 g

A	142 mm
B	44 mm
E	13 mm
G	112 mm
H	36 mm
Metal plate thickness range	2.8÷4 mm
Weight	42 g

A	142 mm
B	44 mm
E	13 mm
G	112 mm
H	36 mm
Metal plate thickness range	2.8÷4 mm
Weight	46 g

Material Specifications

Printed material: TPE elastomer

Printed material: TPE elastomer

Printed material: TPE elastomer

Technical Specifications

Silicon free	YES
Halogen free	YES
ISO 4892-2A	YES
ROHS compliant	YES
Self-extinguishing class (UL 94)	V0
Temperature range (static)	-40°C a +100°C
IP rating (EN 60529)	IP 64
Total number of cables	42

Silicon free	YES
Halogen free	YES
ISO 4892-2A	YES
ROHS compliant	YES
Self-extinguishing class (UL 94)	V0
Temperature range (static)	-40°C a +100°C
IP rating (EN 60529)	IP 64
Total number of cables	48

Silicon free	YES
Halogen free	YES
ISO 4892-2A	YES
ROHS compliant	YES
Self-extinguishing class (UL 94)	V0
Temperature range (static)	-40°C a +100°C
IP rating (EN 60529)	IP 64
Total number of cables	50

Number of cables x cable Ø range

12 x Ø 1 ÷ 7.5 mm
17 x Ø 1 ÷ 6.5 mm
12 x Ø 1 ÷ 5 mm
1 x Ø 1 ÷ 4.5 mm

48 x Ø 1 ÷ 6.5 mm

8 x Ø 1 ÷ 9.5 mm
9 x Ø 1 ÷ 6.5 mm
33 x Ø 1 ÷ 5 mm

Certifications

NEMA performance	12
UL Standard	50E
UL file number	*Pending

NEMA performance	12
UL Standard	50E
UL file number	*Pending

NEMA performance	12
UL Standard	50E
UL file number	*Pending

Accessories upon request

Punching set CEMBRE** RD36X112

Punching set CEMBRE** RD36X112

Punching set CEMBRE** RD36X112

**see page 305, 343

MECHANICAL AND PNEUMATIC TOOLS



SYMBOL DESCRIPTION

professional mechanical tools - hydraulic bench press



Can be operated with one hand



Max cutting diameter



Manual pressure release button



High hardness blades



Ergonomically designed with a sculptured body for operator comfort



Stainless steel blades



Lightweight and balanced for greater control



High tensile steel blades



Dual-compound plastic handles
Greater safety and comfort in handling, thanks to the rubber inserts



Micro-serrated blades for anti-slip purpose



Durable moulded body offering high resistance to wear and damage in all operating conditions



Special Steel frame for high resistance and a long life



Extremely quiet in operation



Protected against accidental intrusions



Max cutting section

SYMBOL DESCRIPTION

professional mechanical tools - hydraulic bench press



Hexagonal crimp



Radial crimp



Indent crimp



Indent crimp



W crimp



Oval crimp



Trapezium crimp



Rhomboidal crimp



Square crimp



CE marking



UKCA marking



CRIMPSTAR®

Manual tool, compact and easy to use, equipped with:

- treated steel crimp jaws with high mechanical properties.
- factory-set ratchet for crimping control (automatic handle opening upon completion of crimping operation).
- Emergency release lever which, if necessary, opens the crimp jaws before their complete closure.
- Ergonomically designed non-slip moulded plastic grips.

HP1

MECHANICAL TOOLS CRIMPSTAR® RANGE

for insulated terminals and connectors



Crimpstar®



The tool HP1 provide cUL® and UL® certified compression when used with CEMBRE VP.



TECHNICAL FEATURES:

Crimping Range	PVC, PC and PA6.6 insulated terminals and connectors for conductor sizes 0,2 to 2,5 sqmm
Dimensions mm	
Length	235
Width	78
Height	19
Weight g	512
Package Dimensions	240 x 81 x 25

HP5

MECHANICAL TOOLS CRIMPSTAR® RANGE

for insulated terminals and connectors



Crimpstar®



The tool HP5 provide cUL® and UL® certified compression when used with CEMBRE RF, BF, GF, RF-F/M/FM, BF-F/M/FM, GF-F/M, RP, BP, GP, PL.



TECHNICAL FEATURES:

Crimping Range	PVC, PC and PA6.6 insulated terminals and connectors for conductor sizes 0,5 to 6 sqmm (for both right and left handed operators)
Dimensions mm	
Length	235
Width	78
Height	19
Weight g	498
Package Dimensions	240 x 81 x 25

MECHANICAL TOOLS CRIMPSTAR® RANGE

HP3

for insulated terminals and connectors

Crimpstar®



TECHNICAL FEATURES

Crimping Range	PVC, PC and PA6.6 insulated terminals and connectors for conductor sizes 0,25 to 6 sqmm
Dimensions mm	
Length	235
Width	78
Height	19
Weight g	498
Package Dimensions	240 x 81 x 25

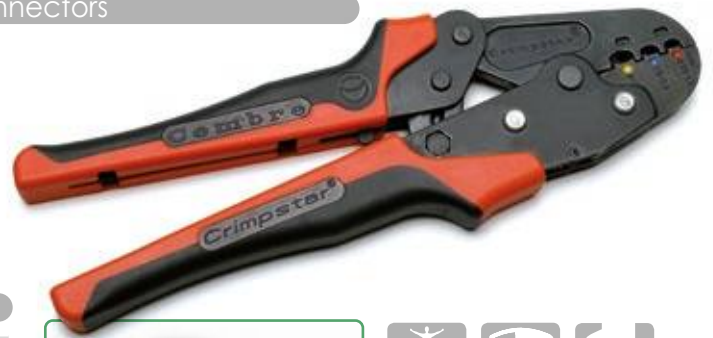

MECHANICAL TOOLS CRIMPSTAR® RANGE

HNN3

for insulated terminals and connectors

Crimpstar®



TECHNICAL FEATURES

Crimping Range	PA6.6 insulated terminals and connectors for conductor sizes 1,5 to 10 sqmm
Dimensions mm	
Length	235
Width	78
Height	19
Weight g	491
Package Dimensions	240 x 81 x 25



MECHANICAL TOOLS CRIMPSTAR® RANGE

HNN4

for insulated terminals and connectors

Crimpstar®



TECHNICAL FEATURES

Crimping Range	PA6.6 insulated terminals and connectors for conductor sizes 10 and 16 sqmm
Dimensions mm	
Length	235
Width	78
Height	19
Weight g	492
Package Dimensions	240 x 81 x 25

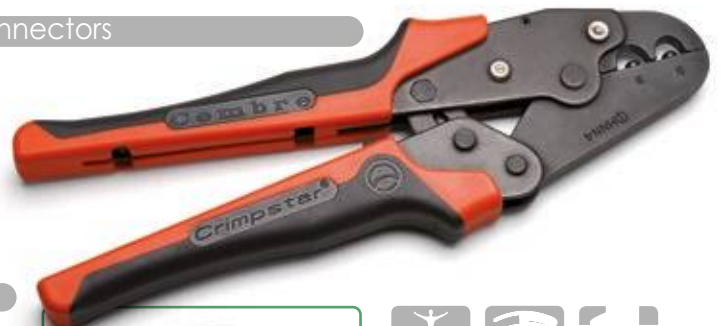

HPH1

MECHANICAL TOOLS CRIMPSTAR® RANGE

for through connectors PE HD insulated, heat shrinkable



TECHNICAL FEATURES

Crimping Range	Through connectors PE HD insulated, heat shrinkable. for conductor sizes 0,5 to 6 sqmm and PA6.6 connectors NL-M, NL-P for conductor sizes 0,25 to 6 sqmm
Dimensions mm	
Length	235
Width	78
Height	19
Weight g	512
Package Dimensions	240 x 81 x 25

HNKE4

MECHANICAL TOOLS CRIMPSTAR® RANGE

for end sleeves



TECHNICAL FEATURES

Crimping Range	End sleeves for conductor sizes 0,5 to 4 sqmm
Dimensions mm	
Length	235
Width	78
Height	19
Weight g	498
Package Dimensions	240 x 81 x 25

MECHANICAL TOOLS CRIMPSTAR® RANGE

HNKE16

for end sleeves

Crimpstar®



TECHNICAL FEATURES

Crimping Range	End sleeves for conductor sizes 4 to 16 sqmm
Dimensions mm	
Length	235
Width	78
Height	19
Weight g	491
Package Dimensions	240 x 81 x 25



MECHANICAL TOOLS CRIMPSTAR® RANGE

HNKE50

for end sleeves

Crimpstar®



TECHNICAL FEATURES

Crimping Range	End sleeves for conductor sizes 25 - 35 - 50 sqmm
Dimensions mm	
Length	235
Width	78
Height	19
Weight g	590
Package Dimensions	240 x 81 x 25



HN1

MECHANICAL TOOLS CRIMPSTAR® RANGE

for uninsulated terminals and connectors



Crimpstar®

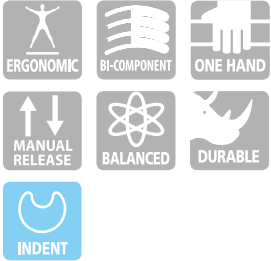

TECHNICAL FEATURES

Crimping Range	Uninsulated terminals and connectors for conductor sizes 0,25 to 10 sqmm
Dimensions mm	
Length	235
Width	78
Height	19
Weight g	480
Package Dimensions	240 x 81 x 25

HN5

MECHANICAL TOOLS CRIMPSTAR® RANGE

for uninsulated terminals and connectors



Crimpstar®



TECHNICAL FEATURES

Crimping Range	Uninsulated terminals and connectors for conductor sizes 10 and 16 sqmm
Dimensions mm	
Length	235
Width	78
Height	19
Weight g	489
Package Dimensions	240 x 81 x 25

MECHANICAL TOOLS CRIMPSTAR® RANGE

HN-A25

for uninsulated terminals and connectors A-M, L-M and L-P series

Crimpstar®



for Cu tube lugs DR (DIN 46235) and through connectors DSV (DIN 46267)

HN-D25

Crimpstar®



for Cu tube lugs HR and through connectors HSV

HN-H25

Crimpstar®



for Cu tube lugs T-M, T-L and through connectors L-T

HN-T25

Crimpstar®



HN-A25 TECHNICAL FEATURES:

Crimping Range

Uninsulated terminals and connectors A-M, L-M and L-P series
for conductor sizes 10 to 25 sqmm

HN-D25 TECHNICAL FEATURES:

Crimping Range

Cu tube lugs DR (DIN 46235) and through connectors DSV (DIN 46267)
for conductor sizes 10 to 25 sqmm

HN-H25 TECHNICAL FEATURES:

Crimping Range

Cu tube lugs HR and through connectors HSV
for conductor sizes 10 to 25 sqmm

HN-T25 TECHNICAL FEATURES:

Crimping Range

Cu tube lugs T-M, T-L and through connectors L-T
for conductor sizes 10 to 25 sqmm



Dimensions mm

Length	230
Width	78
Height	19
Weight g	500
Package Dimensions	240 x 81 x 25

HF1

MECHANICAL TOOLS CRIMPSTAR® RANGE

for open barrel brass terminals



Crimpstar®



TECHNICAL FEATURES

Crimping Range	Open barrel brass terminals for conductors sizes 0,5 to 4 sqmm (not BN-FAB/FAR type)
Dimensions mm	
Length	235
Width	78
Height	19
Weight g	509
Package Dimensions	240 x 81 x 25

HF2

MECHANICAL TOOLS CRIMPSTAR® RANGE

for open barrel brass terminals



Crimpstar®



TECHNICAL FEATURES

Crimping Range	Open barrel brass terminals for conductors sizes 0,08 to 1,3 sqmm (28 to 16 AWG)
Dimensions mm	
Length	235
Width	78
Height	19
Weight g	497
Package Dimensions	240 x 81 x 25

MECHANICAL TOOLS CRIMPSTAR® RANGE

HX1

for coaxial connectors

Crimpstar®



TECHNICAL FEATURES

Crimping Range	Coaxial connectors type RG58, RG59, RG62 and RG 71
Dimensions mm	
Length	235
Width	78
Height	19
Weight g	481
Package Dimensions	240 x 81 x 25



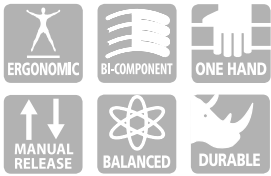

MLRJ1



TECHNICAL FEATURES

Crimping Range	For crimping plugs RJ 11; RJ 12; RJ 14; RJ 22; RJ 45. With cutting and wire-stripping blades
Dimensions mm	
Length	211
Width	75
Height	23
Weight g	526

MLL1



TECHNICAL FEATURES

Crimping Range	For crimping insulated terminals, 0,25 to 6 sqmm side insertion
Dimensions mm	
Length	252
Width	78
Height	23
Weight g	556

MLL90



TECHNICAL FEATURES

Crimping Range	Single aperture, ratchet controlled tool for crimping female connectors, open barrel, flag type 1 to 2,5 sqmm - side insertion
Dimensions mm	
Length	252
Width	78
Height	23
Weight g	558



TECHNICAL FEATURES

Crimping Range	For crimping end sleeves 0,25 to 6 sqmm
Dimensions mm	
Length	198
Width	77
Height	18
Weight g	350



MLS1



TECHNICAL FEATURES

Crimping Range	For crimping end sleeves 6 to 16 sqmm
Dimensions mm	
Length	198
Width	77
Height	18
Weight g	350



MLS2



TECHNICAL FEATURES

Crimping Range	For crimping insulated and uninsulated connectors, 0,25 to 6 sqmm
Dimensions mm	
Length	234
Width	65
Height	15
Weight g	228

ZP2



ND

MECHANICAL TOOLS ND® RANGE

for insulated and uninsulated end sleeves



A generation of tools, with a unique mechanism to reduce operator effort. Small and compact, with ergonomically designed handles for ease of operation.

High quality materials combined with advanced design and manufacturing technology, produce a reliable tool with a guaranteed consistent, crimping operation.



ND1



TECHNICAL FEATURES

Crimping Range	Insulated and uninsulated end sleeves for conductors sizes 0,3 to 1,5 sqmm
Dimensions mm	
Length	190
Width	72
Height	21
Weight g	470

ND2



TECHNICAL FEATURES

Crimping Range	Insulated and uninsulated end sleeves for conductors sizes 1 to 6 sqmm
Dimensions mm	
Length	190
Width	72
Height	21
Weight g	470

ND3



TECHNICAL FEATURES

Crimping Range	Insulated and uninsulated end sleeves for conductors sizes 6 to 16 sqmm
Dimensions mm	
Length	190
Width	72
Height	21
Weight g	470

ND4



TECHNICAL FEATURES

Crimping Range	Insulated and uninsulated end sleeves for conductors sizes 0,5 to 4 sqmm
Dimensions mm	
Length	190
Width	72
Height	21
Weight g	470

Package Dimensions mm	195 x 76 x 20
------------------------------	---------------

MECHANICAL TOOLS ZKE RANGE

for insulated and uninsulated end sleeves

ZKE



The ZKE610N and ZKE616N pliers provide cUL® and UL® certified compression when used with CEMBRE PKE, PKC, PKD and PKT end sleeves.



TECHNICAL FEATURES

Crimping Range	Single aperture, ratchet controlled tool for crimping end sleeves, 0,1 to 10 sqmm side insertion
Dimensions mm	
Length	184
Width	80
Height	26
Weight g	375



ZKE610N



TECHNICAL FEATURES

Crimping Range	Single aperture, ratchet controlled tool for crimping end sleeves, 0,1 to 16 sqmm side insertion
Dimensions mm	
Length	184
Width	80
Height	30,5
Weight g	380



ZKE616N



TECHNICAL FEATURES

Crimping Range	For insulated PA6 and uninsulated end sleeves from 0,5 to 16 sqmm For insulated PA6 'TWIN' end sleeves from 2x 0,5 to 2x10 sqmm
Dimensions mm	
Length	225
Width	52
Height	21
Weight g	290



ZKE2N

HWE1N

MECHANICAL TOOL HWE1N

with interchangeable dies

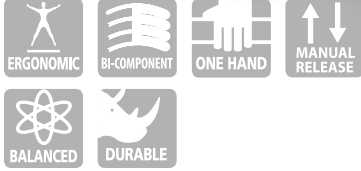

TECHNICAL FEATURES

Dimensions mm

Length	240
Width	79
Height	32,5
Weight g	590

A robust and reliable tool designed to optimise the installers time and effort. A single tool body with a range of interchangeable dies allows a quick and simple transfer from one cable/connector combination to another, across a range of applications.

N.B .: the tool is supplied without dies, for their choice consult the table on the side.

TECHNICAL FEATURES:

- Automatic opening of handles following completion of the crimping operation
- Dull Nickel finish
- Anti-slip handle grips

KIT AVAILABLE ON REQUEST



VALSTAR-N5

comprising:

- HWE1N Manual mechanical tool
- KE16-WE die
- RBY-WE
- all contained in a sturdy plastic case with extra compartments for interchangeable dies



VALSTAR-N6

comprising:

- HWE1N Manual mechanical tool
- HB11 wire stripper
- MC4-WE die
- all contained in a sturdy plastic case with extra compartments for interchangeable dies

INTERCHANGEABLE DIES TO ORDER SEPARATELY



INSULATED CONNECTORS RED, BLUE AND YELLOW

RBY-WE

Size 0,5 to 6 mm²



INSULATED AND UNINSULATED END SLEEVES

KE6-WE

Size 0,5 to 6 mm²

KE16-WE

Size 0,5 to 16 mm²

KE35-WE

Size 16 to 35 mm²



CONNECTORS WITH HEAT SHRINKABLE INSULATION

WLM-WE

Size 0,5 to 6 mm²



UNINSULATED CABLE LUGS

N10-WE

Size 0,5 to 10 mm²



OPEN BARREL BRASS CONNECTORS

F050-WE

Size 0,08 and 0,5 mm²

F075-WE

Size 0,05 and 0,75 mm²

F2.5-WE

Size 0,5 and 2,5 mm²



PHOTOVOLTAIC CONNECTORS (MULTI-CONTACT)

MC3-WE

Size 4 to 6 mm²

MC4-WE

Size 4 to 6 mm²

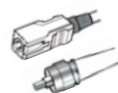

FIBER OPTIC CONNECTOR

ST-WE

SMA, SMB, SFR, ST, SC

SMA-WE

SMA



COAXIAL CONNECTORS

RG71-WE

RG58, RG59, RG62

RG174-WE

RG58, RG174

RG179-WE

RG174, RG179

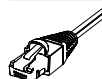

SHIELDED WE CONNECTOR

RJ45-WE

RJ45

MECHANICAL TOOL IDT

with modular interchangeable dies

Dies for photovoltaic connectors



4300-3541
Tyco Solarlok

4300-3539
MC4 Multi Contact

4300-3540
MC3 Multi Contact



TECHNICAL FEATURES

Dimensions mm

Length	234
Width	64
Height	24
Weight g	460

INTERCHANGEABLE DIES TO ORDER SEPARATELY

INSULATED CONNECTORS RED, BLUE, YELLOW and GREEN

4300-3129 Size 0,5 ÷ 2,5 mm ² (Red - Blue)	4300-3128 Size 4 ÷ 6 mm ² (Yellow) Size 0,1 ÷ 0,4 mm ² (Green)
--	---

CONNECTORS WITH HEAT SHRINKABLE INSULATION

4300-3258 Size 0,5 ÷ 2,5 mm ² (Red - Blue)	4300-3262 Size 4 ÷ 6 mm ² (Yellow) Size 0,32 ÷ 0,75 mm ² (Green)
--	---

UNINSULATED CONNECTORS

4300-3137 Size 0,75 ÷ 2,5 mm ²	4300-3241 Size 4 ÷ 10 mm ²
---	---

CONTACTS FOR MULTI POLAR CONNECTORS (eg. ILME, HTS, CONTACT)

4300-3147 Size 0,14 ÷ 4 mm ²	4300-3148 Size 6 ÷ 10 mm ²
---	---

INSULATED AND UNINSULATED END SLEEVES

4300-3127 Size 0,25 ÷ 10 mm ²	4300-3153 Size 16 ÷ 25 mm ²	4300-3154 Size 35 ÷ 50 mm ²
--	--	--

OPEN BARREL CONNECTORS

4300-3146 Size 0,5 ÷ 6 mm ²
--

BNC/TNC CONNECTORS FOR COAXIAL CABLES

4300-3136 RG 58, 59, 62, 71	4300-3140 RG 174, 179
---------------------------------------	---------------------------------

TV - SATELLITE RECEIVER CONNECTORS

4300-3138 RG 6, 59

PHONE CONNECTORS

4300-3144 RJ 45 (LARGE)	4300-3132 RJ 11 (SMALL)
-----------------------------------	-----------------------------------

PHOTOVOLTAIC CONNECTORS (MULTI-CONTACT)

4300-3540 MC3 Size 2,5 - 4/6 mm ²	4300-3539 MC4 Size 2,5/4/6 mm ²	4300-3541 Tyco Solarlok Size 2,5/4/6 mm ²
---	---	---

IDT



A robust and reliable tool designed to optimise the installers time and effort.

A single tool body with a range of interchangeable dies allows a quick and simple transfer from one cable/connector combination to another, across a wide range of applications.

Modular dies may be inserted/extracted without using any tools and are connected in pairs for speed and convenience.

To assist correct die selection, the type of connector is illustrated on each die.

Each die also carries an illustration of the steps in each crimping process, to assist in achieving the best result.



VALSTAR R3 IDT

To order separately - sturdy plastic case designed to store an IDT tool and up to 10 modular dies.

Modular die storage housings are easily combined for convenient transportation



Modular die pack



TN60C

MECHANICAL TOOLS TN RANGE

general features



MAIN APPLICATIONS - max section sqmm

Section sqmm	0.25-1.5	1.5-2.5	4-6	10	16	25	35	50	70	95	120	150	185	240	300	400	500	630	800	1000	
Cu DIN lugs and splices																					
L.V. lugs and splices																					
End sleeves																					

These tools are supplied without dies. For die selection, please refer to chart on pages 354 to 370



Professional manual mechanical tool suitable for crimping connectors up to 300 mm².

It can use all dies common to CEMBRE 60kN heads and tools.

The head rotates 360°, the operator can always crimp in the best position.

Telescopic extendable handles to reduce operator effort during compression. Ergonomic shape of the two-component non-slip plastic handle.



TECHNICAL FEATURES

Dimensions mm

Length (Handles closed)	573
Length (Extended handles)	1.260
Width	168
Height	49
Weight kg	3,7

MECHANICAL TOOLS TN RANGE

for uninsulated terminals and connectors

A-M
SERIES



TECHNICAL FEATURES

TN70SE	TN70	*Uninsulated terminals and connectors for conductor sizes 6 R/F to 70 R/F sqmm
Crimping Range		
Dimensions mm		
Length	450	
Width	127	
Height	47	
Weight kg	2	

*R= Rigid conductor F= Flexible conductor

TECHNICAL FEATURES

TN120SE	TN120S	*Uninsulated terminals and connectors for conductor sizes 10 R/F to 120 R/150 F sqmm
Crimping Range		
Dimensions mm		
Length	700	
Width	170	
Height	47	
Weight kg	3	

*R= Rigid conductor F= Flexible conductor

TN70SE
TN70
TN120SE
TN120S



Professional manual mechanical tool suitable for crimping A-M Cu lugs and non-insulated L-M and L-P connectors.

Heat treated steel crimp jaws. Easily adjustable die positioning by knurled screw and reference vernier scale.

Handles made from anti-slip plastic with hilt.

TN70SE: vernier scale with section of conductors

TN70: vernier scale with connector sizes

TN120SE: vernier scale with section of conductors

TN120S: vernier scale with connector sizes

MECHANICAL TOOLS TN RANGE

for insulated terminals and connectors

ANE
SERIES



TECHNICAL FEATURES

TNN70	*Polyamide PA6.6 insulated terminals and connectors for conductor sizes 10 F to 70 F sqmm
Crimping Range	
Dimensions mm	
Length	450
Width	127
Height	47
Weight kg	2

*F= Flexible conductor

TECHNICAL FEATURES

TNN120	*Polyamide PA6.6 insulated terminals and connectors for conductor sizes 10 F to 120 F sqmm
Crimping Range	
Dimensions mm	
Length	700
Width	170
Height	47
Weight kg	3

*F= Flexible conductor

TNN70
TNN120



Professional manual mechanical tool suitable for the crimping of wire terminals and PA 6.6 insulated connectors.

Heat treated steel crimp jaws. Easily adjustable die positioning by knurled screw and reference vernier scale.

Handles made from anti-slip plastic with hilt.

TNE-A50

MECHANICAL TOOLS TNE RANGE

for uninsulated terminals and connectors

A-M
SERIES



Mechanical tools equipped with rotating dies with hexagonal imprint, suitable for crimping A-M Cu lugs and non-insulated L-M connectors, particularly sturdy and easy to handle.



TECHNICAL FEATURES

Crimping Range	Uninsulated terminals and connectors for conductor sizes 6 to 50 sqmm
Dimensions mm	
Length	386
Width	94
Height	40,5
Weight kg	1,45

TNE-A120

MECHANICAL TOOLS TNE RANGE

for uninsulated terminals and connectors

A-M
SERIES



Mechanical tools equipped with rotating dies with hexagonal imprint, suitable for crimping A-M Cu lugs and non-insulated L-M connectors, particularly sturdy and easy to handle.



TECHNICAL FEATURES

Crimping Range	Uninsulated terminals and connectors for conductor sizes 10 to 120 sqmm
Dimensions mm	
Length	650,5
Width	152
Height	53,5
Weight kg	3,82

MECHANICAL TOOLS TNE RANGE

for Cu tube lugs T-M (NFC 20-130), T-L and through connectors L-T

TNE-T50

T-M
SERIES

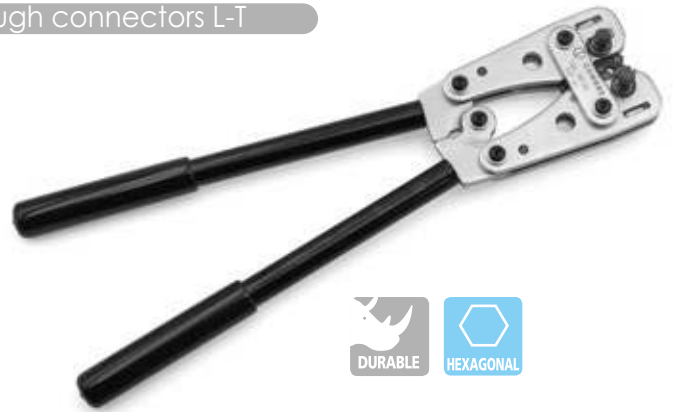

TECHNICAL FEATURES

Crimping Range	for Cu tube lugs T-M (NFC 20-130), T-L and through connectors L-T for conductor sizes 6 to 50 sqmm
Dimensions mm	
Length	386
Width	94
Height	40,5
Weight kg	1,45



Mechanical tools equipped with rotating dies with hexagonal imprint, suitable to crimp Copper lugs T-M series according to (NFC 20-130), T-L and and through connectors L-T, particularly sturdy and easy to handle.

MECHANICAL TOOLS TNE RANGE

for Cu tube lugs T-M (NFC 20-130), T-L and through connectors L-T

TNE-T120

T-M
SERIES

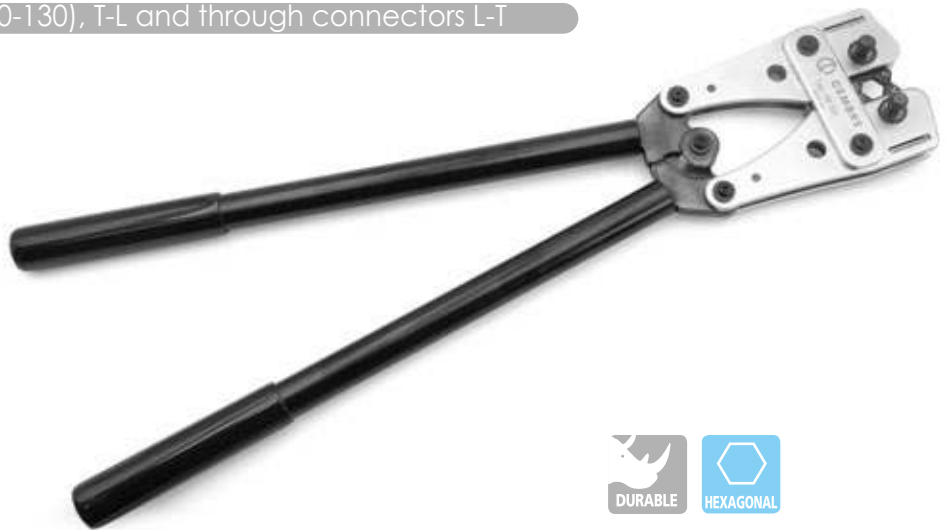

TECHNICAL FEATURES

Crimping Range	for Cu tube lugs T-M (NFC 20-130), T-L and through connectors L-T for conductor sizes 10 to 120 sqmm
Dimensions mm	
Length	650,5
Width	152
Height	53,5
Weight kg	3,82



Mechanical tools equipped with rotating dies with hexagonal imprint, suitable to crimp Copper lugs T-M series according to (NFC 20-130), T-L and and through connectors L-T, particularly sturdy and easy to handle.

TNE-D50

MECHANICAL TOOLS TNE RANGE

for uninsulated terminals and connectors according to DIN 46235 and DIN 46267 T.1



DR
SERIES



Mechanical tools equipped with rotating dies with hexagonal imprint compliant with DIN 480863 suitable to crimp Copper lugs according to DIN 46235 and through connectors according to DIN 46267 T.1, particularly sturdy and easy to handle.



TECHNICAL FEATURES

Crimping Range

Uninsulated terminals and connectors according to DIN 46235 and DIN 46267 T.1 for conductor sizes 6 to 50 sqmm

Dimensions mm

Length	386
Width	94
Height	40,5
Weight kg	1,45

TNE-D120

MECHANICAL TOOLS TNE RANGE

for uninsulated terminals and connectors according to DIN 46235 and DIN 46267 T.1



DR
SERIES



Mechanical tools equipped with rotating dies with hexagonal imprint compliant with DIN 480863 suitable to crimp Copper lugs according to DIN 46235 and through connectors according to DIN 46267 T.1, particularly sturdy and easy to handle.



TECHNICAL FEATURES

Crimping Range

Uninsulated terminals and connectors according to DIN 46235 and DIN 46267 T.1 for conductor sizes 10 to 120 sqmm

Dimensions mm

Length	650,5
Width	152
Height	53,5
Weight kg	3,82

MECHANICAL TOOLS TNE RANGE

for uninsulated copper tube lugs HR and through connectors HSV

HR
SERIES



TECHNICAL FEATURES

Crimping Range	for uninsulated Copper tube lugs HR and through connectors HSV for conductor sizes 6 to 50 sqmm	
Dimensions mm		
Length		386
Width		94
Height		40,5
Weight kg		1,45

TNE-H50

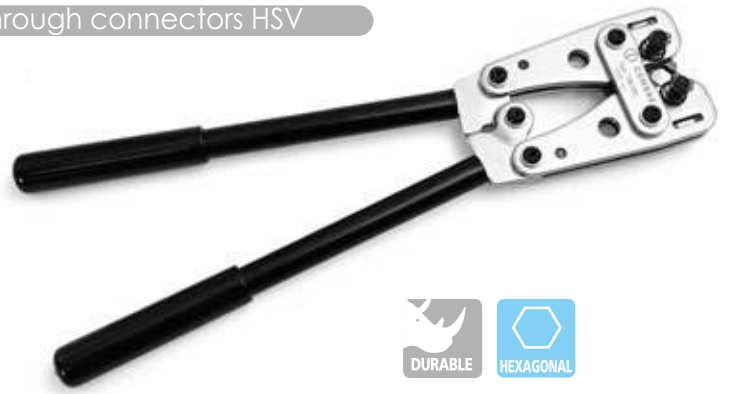

Mechanical tools equipped with rotating dies with hexagonal imprint suitable to crimp Copper tube lugs HR and through connectors HSV, particularly sturdy and easy to handle.

MECHANICAL TOOLS TNE RANGE

for uninsulated copper tube lugs HR and through connectors HSV

HR
SERIES



TECHNICAL FEATURES

Crimping Range	for uninsulated Copper tube lugs HR and through connectors HSV for conductor sizes 10 to 120 mm ²	
Dimensions mm		
Length		650,5
Width		152
Height		53,5
Weight kg		3,82



Mechanical tools equipped with rotating dies with hexagonal imprint suitable to crimp Copper tube lugs HR and through connectors HSV, particularly sturdy and easy to handle.

HB14

WIRE STRIPPERS HB RANGE

for insulated cables



Automatic wire stripper HB14

Automatic stripping force adjustment according to the cable section; the stripping force can be manually adjusted even for very soft or tough insulation for cables from 0,2 to 6,0 sqmm. Stripping length adjustable from 6 to 18 mm. Conductor cut from 0,2 to 2,5 sqmm.

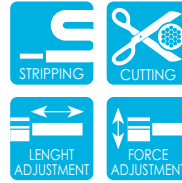

TECHNICAL FEATURES

Dimensions mm	
Length	200
Width	165
Height	28
Weight g	155



HB6



Wire strippers, including stripping die for PVC insulated cables 0,02 to 10 sqmm



Interchangeable stripping dies available upon request:

TECHNICAL FEATURES

Dimensions mm	
Length	191
Width	90
Height	20
Weight g	136



4320-0866, rounded blades suitable for: PVC from 4 to 16 sqmm

4320-0864, flat blade suitable for: PVC from 0,02 to 10 sqmm

4320-0865, 'V' blades suitable for: PTFE from 0,1 to 4 sqmm

PTS4



Wire stripping tool for PVC insulated cables from 0.2 to 6 mm²

TECHNICAL FEATURES

Dimensions mm	
Length	175
Width	90
Height	22
Weight g	200

WIRE STRIPPERS HB RANGE

HB23

for insulated cables

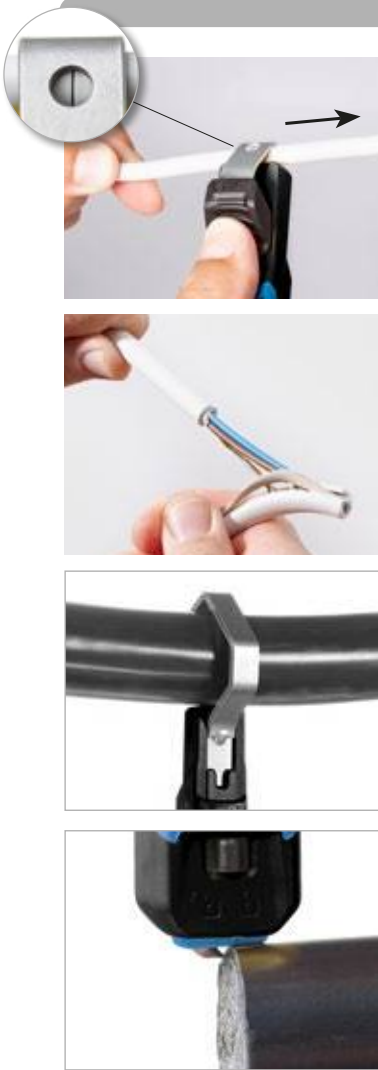

TECHNICAL FEATURES

Dimensions mm

Length	167
Width	32
Height	38
Weight g	124

Bracket Type	Application range	Replacement No.
CB16-HB23	Ø 4-16 mm	No.16
CB28-HB23	Ø 8-28 mm	No.28
CB35-HB23	Ø 27-35 mm	No.35
CB50-HB23	Ø 35-50 mm	No.50
CB70-HB23	Ø 50-70 mm	No.70



Round cable stripper HB23

Round cable cutting system with intelligent, interchangeable bracket. Supplied as standard with brackets for cables No. 28 and 35, for the most common cable types from 8 to 35 mm Ø.

Thanks to this system, all the most common types of cables, from 4 to 70 mm in diameter, can be stripped with just one tool.

Intelligent bracket change according to stripping diameter
blade length: 3.5 mm

Cutting depth adjustment sliding stop to set the height of the hook blade according to insulation
Thickness knife length: 2.8 to 4.6 mm

HB2



Cable stripping tool for circular cables Ø 4,5 to 28,5 mm

TECHNICAL FEATURES

Dimensions mm

Length	135
Width	-
Height	-
Weight g	107

HB3



Wire stripping tool for circular diameters from 4.5 to 40 mm, insulation thickness up to 4.5 mm

TECHNICAL FEATURES

Dimensions mm

Length	167
Width	37
Height	40
Weight g	116

HB17

WIRE STRIPPERS HB RANGE

for all standard insulated round cables



Stripper for all standard insulated round cables HB17

Stripper for all standard insulated round cables, including NYM 3x1,5 bis 5x2,5mm², NHXMH 3x1,5 bis 5x2,5mm² halogenfree.

No cutting depth adjustment required. TiN-coated blades.

Extra blade for longitudinal cut. 6 stripping blades from 0.2 to 4.0 mm².

Dual-compound handle for better grip and more safety.

Pocket clip.



	Ø	8-13 mm		5/16-1/2"			
	mm ²	0,2	0,3	0,8	1,5	2,5	4,0
	AWG	24	22	18	16	14	12

TECHNICAL FEATURES

Dimensions mm

Length	124
Width	25
Height	35
Weight g	42



HB19

WIRE STRIPPERS HB RANGE

for solar cables



Stripper for solar cables HB19

Quick and precise stripping of all standard energy and security cables from 2.5-6mm², double shielded solar cables, shortcut and grounding-proof, flameretardant, halogen-free cables (e. g. NSGAFÖU, VER H07RN-F), with integrated, rotatable length stop for 8.5mm and 15mm stripping length.



TECHNICAL FEATURES

Dimensions mm

Length	124
Width	25
Height	35
Weight g	50



WIRE STRIPPERS HB RANGE

for pvc-insulated data cables

HB20



TECHNICAL FEATURES

Dimensions mm

Length	100
Width	18
Height	18
Weight g	24

Stripper for pvc-insulated data cables HB20

The CEMBRE HB20 is a powerful stripping tool for PVC-insulated data cables (incl. Cat 5, Cat 6, and Cat 7 cables, Twisted-Pair cables) with diameters from 4.5 to 10mm (Ø 0.18-0.39 in.).

No adjustment to the cutting depth to the cable thickness is required, since the unique blade layout lifts the outer insulation carefully and strips the foil shielding. All stripper blades are titanium-nitride coated.



WIRE STRIPPERS HB RANGE

for coaxial cables

HB21



TECHNICAL FEATURES

Dimensions mm

Length	100
Width	18
Height	18
Weight g	21

Stripper for coaxial cables HB21

For quick and easy stripping of most common coaxial-cable types e.g. TV antenna cable types Ø 4,8-7,5mm (Ø 0.19-0.30 in.) and 3x0,75mm² (3x18 AWG) round PVC sheathed cable.



HB22

WIRE STRIPPERS HB RANGE

for insulated round cables



Stripper for insulated round cables HB22

For all common round cables Ø 4-15mm (5/32"-19/32") with PVC-sheathing (e. g. type NYM or flexible cable), rubber or hard plastic sheathing.

For PVC-sheathed flat cables up to 15mm (19/32") width.

TECHNICAL FEATURES

Dimensions mm	
Length	130
Width	25
Height	38
Weight g	49



HB16

WIRE STRIPPERS HB RANGE

for sensor / actuator cables



Automatic wire stripper HB16

Is tightly focussed to the needs of stripping the sheathing of sensor/actuator cables. With their new blade design the tools strip PVC/PUR cable sheathings precisely without damages to the individual conductors or shieldings inside.

The innovative cable scanning system adjusts the stripping blades automatically to the various cable diameters.

So the stripping of the outer sheathing of cables for connecting Sensor/Actuator boxes or bus couplers is being done quickly and safely.

TECHNICAL FEATURES

Dimensions mm	
Length	172
Width	98
Height	30
Weight g	152



CABLE STRIPPING TOOLS HB RANGE

for external sleeves of Low/Medium Voltage cables



Universal cable stripping tool for external sleeves of Low/Medium Voltage cables \varnothing 12,7 to 63,5 mm and primary insulator in XLPE max \varnothing 38,1 mm



HB13UE

for vulcanized extruded semiconductor



The HB12N kit includes:

- HB12N cable stripping tool
- sturdy plastic case



HB12N cable stripping tool removes the semiconductor layer by being manually rotated around the cable while lateral advancement is achieved automatically. Safe and convenient, it can be used on cables with a semi-con diameter between 18 - 60 mm.

HB12N

- Sturdy frame in anodised Aluminium alloy and Steel.
- Special Steel blade with precise cutting depth regulation.
- Stripping operation can start at any point along the conductor.
- Bearing mounted rollers provide smooth cutting action.
- With "REVERSE" function, which allows the removal of semiconductor up to 7 mm thick from the sheath of the cable.
- Double speed for each direction.



HB9

Insulated knife, with curved blade and protective cover. Suitable for insulation and screen removal, equipped with blade guide to avoid damage to strands. Handle is made of a bi-component plastic material.



HB10

Insulated knife has an interchangeable straight blade and plastic blade protector that folds into the handle. Ergonomic handle made of anti shock plastic material

KT

CABLE CUTTERS KT RANGE FOR SMALL SECTIONS

for cutting cables Cu and Al

KT1R



TECHNICAL FEATURES

Cutting Capacity	For cutting cables Cu and Al Ø Max 12 mm
Dimensions mm	
Length	170
Width	65
Height	20
Weight g	230

KT1N



TECHNICAL FEATURES

Cutting Capacity	For cutting cables Cu and Al Ø Max 15 mm
Dimensions mm	
Length	170
Width	65
Height	28
Weight g	264

KT2N



TECHNICAL FEATURES

Cutting Capacity	For cutting cables Cu and Al Ø Max 20 mm
Dimensions mm	
Length	220
Width	65
Height	28
Weight g	350

KT5



TECHNICAL FEATURES

Cutting Capacity	for cutting cables Cu and Al up to max section 25 sqmm
Dimensions mm	
Length	170
Width	52
Weight g	108

RATCHET CABLE CUTTERS KT RANGE

KT

for cutting cables Cu and Al

TECHNICAL FEATURES

Cutting Capacity	For cutting cables Cu and Al Ø max 34 mm
Dimensions mm	
Length	260
Weight g	600

KT3N



Ideal for copper and aluminium cables/wires.
Not suitable for Class 5 and 6 cables, ACSR, armored cables or steel wire.

TECHNICAL FEATURES

Cutting Capacity	For cutting cables Cu and Al Ø max 62 mm
Dimensions mm	
Length	297
Weight g	800

KT4N



Ideal for copper and aluminium cables/wires.
Not suitable for Class 5 and 6 cables, ACSR, armored cables or steel wire.

TECHNICAL FEATURES

Cutting Capacity	For cutting cables Cu and Al Ø Max 45 mm
Dimensions mm	
Length	250
Width	110
Weight g	950



KT45



Ideal for copper and aluminium cables/wires.
Not suitable for ACSR, armored cables or steel wire.

TECHNICAL FEATURES

Cutting Capacity	For cutting cables Cu and Al Ø Max 100 mm
Dimensions mm	
Length	650
Width	250
Weight g	4

KT6



Ideal for copper and aluminium cables/wires.
Not suitable for ACSR, armored cables or steel wire.

CABLE CUTTERS KT RANGE FOR LARGE SECTIONS

for cutting cables Cu and Al

KT7



TECHNICAL FEATURES

Cutting Capacity	For cutting cables Cu and Al Ø Max 27 mm
Dimensions mm	
Length	500
Width	170
Height	50
Weight g	1.260

KT8



TECHNICAL FEATURES

Cutting Capacity	For cutting cables Cu and Al Ø Max 38 mm
Dimensions mm	
Length	570
Weight g	2.300

for cutting cables Cu and Al

5116660250



TECHNICAL FEATURES

Cutting Capacity	For cutting cables Cu and Al Ø max 18 mm
Dimensions mm	
Length	600
Width	140
Weight kg	1,5

5116660500



TECHNICAL FEATURES

Cutting Capacity	For cutting cables Cu and Al Ø max 25,4 mm
Dimensions mm	
Length	800
Width	160
Weight kg	3,0

KTS1632

HAND TOOLS

for cutting and sealing flexible plastic conduit

Cuts and seals flexible plastic conduit in a single operation. Lightweight and easy to operate. Suitable for flexible conduits from $\varnothing 16$ to $\varnothing 32$ mm.

TECHNICAL FEATURES

Dimensions mm

Length	230
Width	58
Thickness	32
Weight kg	0,32



PC1

for cutting plastic pipe

Plastic pipe cutting tool
Cutting capacity: $\varnothing 6$ to $\varnothing 42$ mm.

Body: die-cast aluminium alloy
Blade material: hardened Carbon Steel

TECHNICAL FEATURES

Dimensions mm

Length	195
Width	96
Thickness	27
Weight kg	0,32



Automatic cutting



TECHNICAL FEATURES

Application Range	For plastic cable ties from 2,2 to 4,8 mm
Dimensions mm	
Length	162
Width	133
Height	23
Weight g	208

5527030079

With cutting device



TECHNICAL FEATURES

Application Range	For stainless steel cable ties width up to 7,9 mm
Dimensions mm	
Length	180
Width	141
Height	30
Weight g	558

5523036090

Manual cutting



TECHNICAL FEATURES

Application Range	For plastic cable ties from 4,8 to 9 mm
Dimensions mm	
Length	194
Width	100
Height	25
Weight g	324



VALSTAR-N0 (empty)

Robust plastic case with compartments

- **1 storage compartment** for mechanical tools, type Crimpstar® /ZKE-N/etc.
- **8 storage compartments** for connecting material

Dimensions (LxWxH): 340 x 274 x 71 mm

Weight: 698 g



VALSTAR-N1

Robust plastic case with compartments, containing:

- Tool type **ZKE610N**
- a selection of end sleeves PKC conductor size from 1 to 6 mm²
- Cable ties type G100X2.5

VALSTAR-N1 Material included:

Q.ty	Cond. Size mm ²	Length mm	Color	Type
500	1	14	Yellow	PKC108
500	1.5	14	Red	PKC1508
500	2.5	14	Blue	PKC2508
200	4	18	Grey	PKC410
100	6	20	Black	PKC612
100	-	100 x 2,5	White	G100X2.5

VALSTAR-N2

Robust plastic case with compartments, containing:

- Tool type **ZKE610N**
- a selection of end sleeves PKE conductor size from 1 to 6 mm²
- Cable ties type G100X2.5

VALSTAR-N2 Material included:

Q.ty	Cond. Size mm ²	Length mm	Color	Type
500	1	14	Red	PKE108
500	1.5	14	Black	PKE1508
500	2.5	14	Grey	PKE2508
200	4	18	Orange	PKE410
100	6	20	Green	PKE612
100	-	100 x 2,5	White	G100X2.5

VALSTAR-N3

Robust plastic case with compartments, containing:

- Tool type **ZKE610N**
- a selection of end sleeves PKD conductor size from 1 to 6 mm²
- Cable ties type G100X2.5

VALSTAR-N3 Material included:

Q.ty	Cond. Size mm ²	Length mm	Color	Type
500	1	14	Red	PKD108
500	1.5	14	Black	PKD1508
500	2.5	14	Blue	PKD2508
200	4	18	Grey	PKD410
100	6	20	Yellow	PKD612
100	-	100 x 2,5	White	G100X2.5

for storing connecting material and hand tools



VALSTAR-N4 Material included:

Q.ty	Cond. Size mm²	Description	Type
100	0,25÷1,5	ring terminals	RF-M4
100	1,5÷2,5	ring terminals	BF-M5
100	4÷6	ring terminals	GF-M6
100	0,25÷1,5	female disconnect terminals	RF-F608P
100	1,5÷2,5	female disconnect terminals	BF-F608P
100	0,25÷1,5	butt connectors	PL03-M
	Length mm		
100	100 x 2,5	cable ties	G100X2.5

VALSTAR-N4

Robust plastic case with compartments, containing:

- Tool type **Crimpstar® HP3**.
- An assortment of PVC insulated crimp terminals for conductor sizes from 0,25 to 6 mm².
- Cable ties



VALSTAR-N11

Robust plastic case with compartments, containing:

- Tool type **Crimpstar® HP5**.



VALSTAR-N5

Robust plastic case with compartments, containing:

- Tool type **HWE1N**
- KE16-WE die
- RBY-WE die

VALSTAR-N5 Dies included:

Q.ty	Cond. Size mm ²	Description	Type
1	0,5÷16	Insulated and uninsulated end sleeves	KE16-WE
1	0,5÷6	Insulated connectors red, blue and yellow	RBY-WE



VALSTAR-N6

Robust plastic case with compartments, containing:

- Tool type **HWE1N**
- Tool type **HB11**
- MC4-WE die

VALSTAR-N6 Dies included

Q.ty	Cond. Size mm ²	Description	Type
1	4 ÷ 6	Dies for Multi-Contacts MC4 connectors	MC4-WE

BENCH PRESS TOOLS



PNB-1

BENCH PRESS TOOL

Pneumo-hydraulic with interchangeable dies



Pneumo-hydraulic, production bench press, operated by a manual control, provides a consistent and reliable crimped connection. Extensive range of interchangeable dies available for crimping a wide variety of connectors.

NOTE: for applications not listed, please contact CEMBRE.



PNB-1 detail of the crimping zone with PU-1 guard.

TECHNICAL FEATURES

Nominal operating pressure	6 bar
Dimensions mm	
Width	180
Depth	320
Height	700
Weight kg (without dies)	23

INTERCHANGEABLE DIES (to be ordered separately)

Die Set	Guard*	Connector Type	Nominal Conductor Size sqmm			
PV-1	PU-1	Insulated Connectors	green	0,2÷0,5		
PR-1			red	0,25÷1,5		
PB-1			blue	1,5÷2,5		
PG-1			yellow	4÷6		
PH1-1	PH-1**	Butt connectors PVC insulated	PL03-M	0,25÷1,5		
			PL06-M	1,5÷2,5		
			PL1-M	4÷6		
PH1-1	PH-1**	Through connectors PE HD insulated NL-M, NL-P connectors PA6.6 insulated		0,5÷6		
				0,25÷6		
KE0.75-1	PK-1	End Sleeves		0,3 - 0,5 - 0,75		
KE2.5-1				1 - 1,5 - 2,5		
KE10-1			KE, PK...	4 - 6 - 10		
MTT16-50	ME-1			16		
MTT25-50				25		
N1-1	PU-1	A 03-M.. S 1.5-..	RN-..	0,25 - 1,5		
		A 06-M.. S 2.5-..	BN-..	1,5 - 2,5		
		A 1-M.. S 6-..	GN-..	4 - 6		
ME1-50	ME-1	Uninsulated Copper Lugs	A1-M..	4 - 6		
ME2-50			A2-M.. S10-M..	10		
ME3-50			A3-M..	16		
ME5-50			A5-M..	25		
ME7-50			A7-M..	35		
ME9-50			A9-M..			
ME10-50			A10-M..	50		
ME12-50			A12-M..			
MS6-50			T6-M	4 - 6		
MS10-50			T10-M	10		
MS16-50	ME-1	Uninsulated Copper Lugs	T16-M	16		
MS25-50			T25-M	25		
MS35-50			T35-M	35		
MS50-50			T50-M	50		
MN2RF-50			MN RF-1	Polyamide Insulated Lugs	ANE2-M..	10
MN3RF-50					ANE3-M..	16
MN5RF-50					ANES-M..	25
MN7RF-50	ANE7-M..	35				
		ANE9-M..				

* Supplied as standard with the machine ** Supplied as standard with the die

BENCH PRESS TOOL

Pneumatic

PNB-3

TECHNICAL FEATURES

Nominal operating pressure	6±7 bar
Dimensions mm	
Width	130
Depth	370
Height	195
Weight kg	10,3



PNB-3P detail of the crimping zone.

Pneumatic bench press operated by foot pedal for crimping terminals and connectors 0,25 to 16 sqmm.

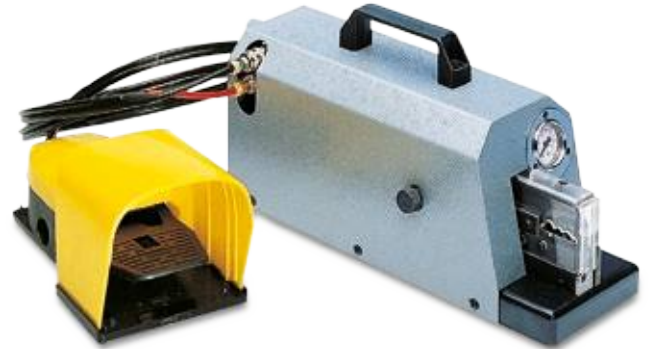

BENCH PRESS RANGE

Type	Connector Type	Conductor Size sqmm
PNB-3P*	Insulated connectors red, blue and yellow	0,25÷6
PNB-3PD	Insulated terminals and butt connectors - frontal insertion	0,25÷6
PNB-3N1	Uninsulated terminals	0,25÷10
PNB-3N5	Uninsulated terminals	10÷16
PNB-3NN3	Polyamide insulated terminals	1,5÷10
PNB-3NN4	Polyamide insulated terminals	10÷16
PNB-3F/M	Bullet connectors	0,5÷2,5

* Will also crimp Polycarbonate fully-insulated terminals if fitted with PNB3F/M positioner, available as an optional accessory (Cod. 6240145)

BENCH PRESS TOOL

Pneumatic with multi-aperture die

PNB-4KE

TECHNICAL FEATURES

Nominal operating pressure	6 bar
Dimensions mm	
Width	120
Depth	160
Height	300
Weight kg	6



PNB-4KE detail of the crimping zone.

Pneumatic bench press, operated by a manual control.

Supplied with a multi-aperture die suitable for crimping insulated and uninsulated end sleeves from 0,3 to 10 sqmm.

Compact and efficient. Easy to operate, producing a secure and reliable crimped connection.



MULTI DIES

Type	Connector Type	Conductor Size sqmm
PNB-4KE	End Sleeves type PK... and type KE	0,3÷10

EPB-1N

ELECTRO-PNEUMATIC BENCH PRESS

automatic stripping / crimping machine for insulated end sleeves



Bench press type EPB-1N, electro-pneumatically operated, is designed for stripping and crimping insulated end sleeves CEMBRE type PKC, PKD and PKE.

The basic configuration processes connectors of c.s.a 0,5/0,75/1,0 and 1,5 mm² with a sleeve lengths of 6, 8, 10 and 12 mm.

Adapter kits are available:

KIT-2.5-EPB1N

for insulated end sleeves c.s.a 2,5 sqmm with a sleeve length of 8, 10 and 12 mm

KIT-4-EPB1N

for insulated end sleeves c.s.a 4,0 sqmm with a sleeve length of 10 mm

Stripping and crimping operations are carried out in quick succession. Adjustable loading speed of vibrating charger.

Quick and easy change of configuration for different connector sizes. Automatic adjustment of operating parameters to suit each configuration.

Modular structure and wear-free components guarantee excellent reliability.



Adapter Kit for insulated end sleeves c.s.a 2,5 sqmm (KIT-2.5-EPB1N) (KIT-4-EPB1N)



TECHNICAL FEATURES

Crimping Range	0,5-1,5 mm ² (basic configuration)
Dimensions mm	
Length	390
Width	240
Height	490
Weight kg	29
Power Supply	230 V/50 Hz (110 V/60 Hz)
Current	0,5 A
Length of crimp	6, 8, 10 and 12 mm
Geometry of crimp	Trapezoidal
Cycle time	2 s
Compressed Air supply	Min. 4 - Max 6 bar
Air consumption	1,2 l/cycle
Cycle controller	Electro-pneumatic, with microprocessor
Counter	Digital



PNEUMATIC CRIMPING TOOLS

Hand held - PNB series

PNB-6KE TECHNICAL FEATURES

Crimping Range	0,25 ÷ 2,5 sqmm / 24 ÷ 14AWG
Dimensions mm	
Length	190
Width Ø	44
Length with spiral hose	2 m
Weight g	450

PNB-7KE TECHNICAL FEATURES

Crimping Range	4 ÷ 10 sqmm / 12 ÷ 8AWG
Dimensions mm	
Length	190
Width Ø	44
Length with spiral hose	2 m
Weight g	450

PNB-6KE and PNB-7KE hand tools facilitate the rapid crimping of insulated end sleeves while avoiding the operator discomfort associated with ordinary manual tools. Lightweight and easy to use, these tools are ideal for panel building applications and component assembly.

Both tools are designed to be maintenance-free and need no routine calibration. A 4-6 bar air supply is required for connection via the quick coupler fitted to the hose supplied with the tool.



PNEUMATIC CRIMPING TOOLS

Bench mounted tools with foot pedal - PNB series

PNB-6KE-T TECHNICAL FEATURES

Crimping Range	0,25 ÷ 2,5 sqmm / 24 ÷ 14AWG
Dimensions mm	
Length	200
Width Ø	135
Height	75
Length with spiral hose	2 m
Weight g	1000

PNB-7KE-T TECHNICAL FEATURES

Crimping Range	4 ÷ 10 sqmm / 12 ÷ 8AWG
Dimensions mm	
Length	200
Width Ø	135
Height	75
Length with spiral hose	2 m
Weight g	1000

PNB-6KE-T and PNB-7KE-T have bench mounts with storage and are foot pedal operated to allow operators to have both hands free when assembling cable harnesses. Both tools are designed to be maintenance-free and need no routine calibration.



A 4-6 bar air supply is required for connection via the quick coupler fitted to the hose supplied with the tool.





Electro-pneumatic, production bench press, controlled by a foot operated pedal. Producing a consistent and reliable crimped connection. Interchangeable application heads available to suit the complete range of Polycarbonate insulated connectors.

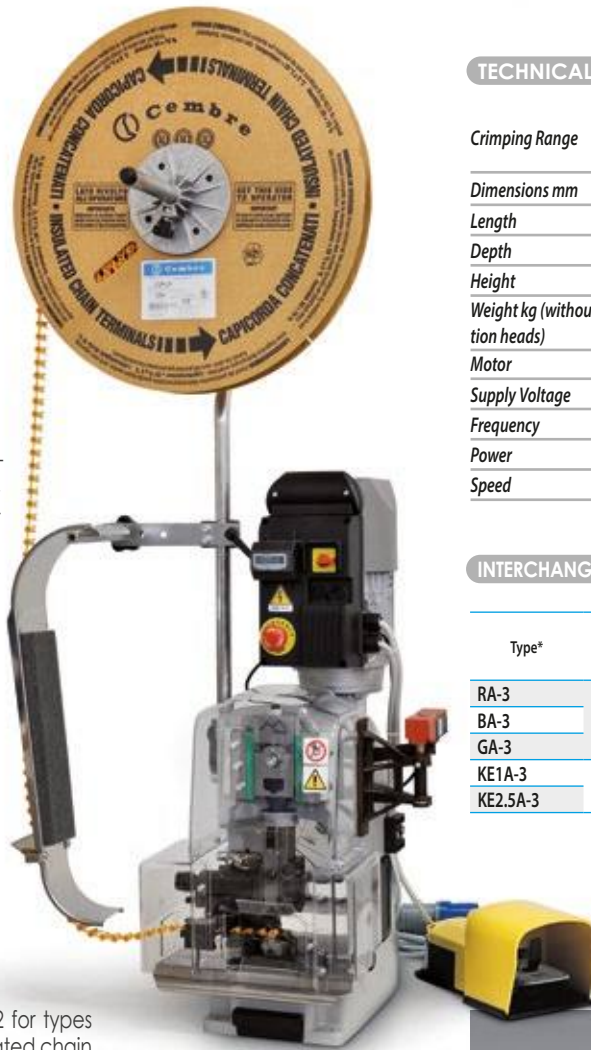

TECHNICAL FEATURES

Crimping Range	Polycarbonate insulated chain terminals 0,25 ÷ 6 mm ² and insulated chain end sleeves 0,5 ÷ 2,5 mm ²
Dimensions mm	
Length	180
Depth	250
Height	620
Weight kg (without application heads)	41
Motor	
Supply Voltage	220 V
Frequency	50 Hz
Power	0,55 kW/0,75 HP
Speed	2.800 g/1'

INTERCHANGEABLE APPLICATION HEADS, SIDE ENTRY WITH PNEUMATIC FEED

Type*	Connectors	Conductor Size sqmm
RA-3	Polycarbonate insulated chain terminals	0,25÷1,5
BA-3		1,5÷2,5
GA-3		4÷6
KE1A-3	Insulated chain end sleeves	0,3÷0,75
KE2.5A-3		1÷2,5

* order as required

See pages 12-13 and 22 for types and features of the insulated chain connectors and end sleeves.



Conforms to DIN Standard 46 228/4



PROFESSIONAL EQUIPMENT



SYMBOL DESCRIPTION

professional equipment



Can be operated with one hand



Special Steel frame for high resistance and a long life



Ergonomically designed with a sculptured body for operator comfort



Chrome Steel Tools



Lightweight and balanced for greater control



Chrome Vanadium Steel Tools



Dual-compound plastic handles
Greater safety and comfort in handling, thanks to the rubber inserts



Aluminum frame



Durable moulded body offering high resistance to wear and damage in all operating conditions



ABS structure



Max cutting section



Luminous flux intensity



High hardness blades



Equipped with USB charging



Stainless steel blades



Equipped with wireless charging



High tensile steel blades



Equipped with magnetic support



Micro-serrated blades for anti-slip purpose



Equipped with power plug

SYMBOL DESCRIPTION

professional equipment



Equipped with dimmer switch



CE marking



Equipped with an ON / OFF motion sensor



UKCA marking



Can be used as an power bank



Operating temperature range



Degree of Protection



Lamp life in Front / Flashlight mode



Autonomy of the lamp at Maximum / Minimum intensity



The light can be tripod mounted



Control with App



Robust-A

Professional scissors with a Special Steel frame for high resistance and long life.

Ergonomic and dual-compound plastic handles: glass fibre reinforced Polyamide and inserts of soft Rubber.

The anti-loosening pivot and bevelled profile allow the accurate and consistent alignment of the blades.

High hardness blades (58 HRC) and an anti-slip serrated edge for making precise cuts even on more difficult materials.

Shaped groove for cutting conductor up to 50 mm².

Supplied with carry case and swivel belt hook.

Special Steel frame for high resistance and a long life



Micro serrated blade



Anti-loosening pivot



Dual-compound material



Case with swivel belt hook

PROFESSIONAL SCISSORS SC6X

SC6X

For flexible conductors Cu-Al

Weighing only 86 grams these lightweight scissors feature tapered blades and ergonomically shaped handles to aid speed of operation and consistent results.

The design of the blades allows the scissors to be used in confined spaces and affords the user minimum effort when cutting conductors.

Handles have an integrated crimping system for end sleeves.

The anti-loosening pivot and bevelled profile allow the accurate and consistent alignment of the blades.

High hardness blades (58 HRC) and an anti-slip serrated edge for making precise cuts even on difficult materials.

Shaped groove for cutting conductor up to 50 mm².

Supplied with carry case and belt fastening system.

lightweight design only 86 grams

Agil-E

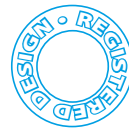

Eyelets aligned when handles in open position

Soft rubber inserts to maximise grip

Crimping system for end sleeves

Shaped groove in each blade for easy cutting up to 50 mm²

Anti-slip serrated edge for making precise cuts even on more difficult materials

High hardness blades (58 HRC)

Anti-loosening pivot

Economically shaped hand grips

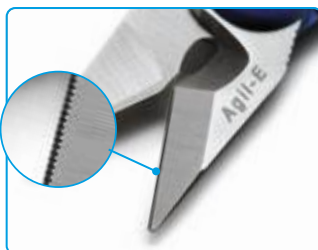

Micro serrated blade



Anti-loosening pivot



Dual-compound material



Case with belt fastening system

SC5X

PROFESSIONAL SCISSORS SC RANGE

For flexible conductors Cu-Al



Professional scissors with a Special Steel frame for high resistance and a long life.

Extremely lightweight and robust for safe, easy handling and comfort. Easy cutting of conductors upto 50 sqmm using the shaped grooves in each blade. Safe and easy operation even when wearing work gloves.

Main Features

Cutting Capacity	for flexible conductors Cu - Al up to max section 50 sqmm
Dimensions mm	
Length	162
Width	77
Height	18
Weight g	121



SC6X

PROFESSIONAL SCISSORS SC RANGE

For flexible conductors Cu-Al



Weighing only 86 grams these lightweight scissors feature tapered blades and ergonomically shaped handles to aid speed of operation and consistent results.

The design of the blades allows the scissors to be used in confined spaces and affords the user minimum effort when cutting conductors.

Handles have an integrated crimping system for end sleeves.

Main Features

Cutting Capacity	for flexible conductors Cu - Al up to max section 50 sqmm
Dimensions mm	
Length	153
Width	73,6
Height	18
Weight g	86



PROFESSIONAL SCISSORS SC RANGE

SC3X

For flexible conductors Cu-Al

Main Features

Cutting Capacity for flexible conductors Cu - Al
up to max section 35 sqmm

Dimensions mm

Length	150
Width	75
Height	20
Weight g	86

Multi-purpose scissors with high hardness blades (56 HRC) and anti slide serrations.

The moulded plastic handles combine a rigid structure with a softer material for finger comfort.

Cutting of flexible conductors up to 35 sqmm



PROFESSIONAL SCISSORS SC RANGE

SC1

For flexible conductors Cu-Al

Main Features

Cutting Capacity for flexible conductors
Cu - Al

Dimensions mm

Length	145
Width	76
Height	17
Weight g	78

Electricians scissors with high tensile steel blades allowing for excellent strength and performance. Specially micro-serrated blades for anti-slip purpose. Handles are made from dual component materials.

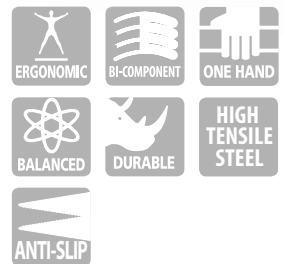

CBL01



CBLIGHT

pocket torch

The handy CBL01 torch is the size of a pen and is equipped with a double light point to illuminate small work areas. The side light allows you to illuminate the area while leaving it in your pocket,

while the front light allows you to inspect less accessible areas. The clip is equipped with a magnet allowing it to be attached to any metal surface, freeing the operator's hands. Supplied with USB charging cable.

Pocket torch CBL01

Main Features

Type	Lumen Front / Flashlight	Duration Front / Flashlight	Energy Class	Magnetic Support	Charging Method	Degree of Protection	Operating Temperature Range °C	Body Material	Lamp Material	Dimensions mm	Weight g
CBL01	150/70	2.5/3.5 h	A++	Yes	USB	IP20	-10/+40	ABS	PC	160x15x20	38

CBL02-W

Tool Type	Plug Type	Supplied Battery Charger Type
CBL02-W	PLUG EU	ASC55-EU with EUROPEAN plug
CBL02-WE	PLUG UK	ASC55-UK with UK plug
CBL02-WA	PLUG USA CAN	ASC30-36-USA/CA (115V) with USA/CANADA plug

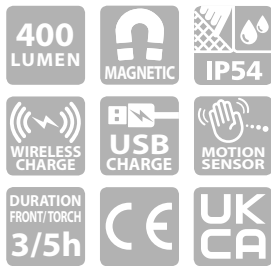

CBLIGHT

head torch

Ideal for any indoor or outdoor activity requiring localised lighting and freedom of action, the CBL02-W head torch

is equipped with a touch sensor allowing operation even while wearing gloves. The light intensity can be modulated via the dimmer function helping to preserve battery life. The CBL02-W is a versatile head torch adjustable by means of an elastic band to fit work helmets of various sizes. Supplied with USB charging cable and charger.

Head torch CBL02-W

Main Features

Type	Lumen Front / Flashlight	Duration Front / Flashlight	Energy Class	Magnetic Support	Charging Method	Degree of Protection	Operating Temperature Range °C	Body Material	Lamp Material	Dimensions mm	Weight g
CBL02-W	400/80	3/5 h	A++	Yes	USB/Wireless	IP54	-10/+40	ABS+PC	PC	78x39x36	105

CBL03-W

Tool Type	Plug Type	Supplied Battery Charger Type
CBL03-W	PLUG EU	ASC55-EU with EUROPEAN plug
CBL03-WE	PLUG UK	ASC55-UK with UK plug
CBL03-WA	PLUG USA CAN	ASC30-36-USA/CA (115V) with USA/CANADA plug



CBLIGHT

multi-purpose lamp

The CBL03-W multi-purpose lamp is a mini-lamp that can be used on a table or hung on metal surfaces thanks to the handy magnet or the suspension hook.

It is equipped with an ergonomic non-slip handle to make it easy to use. The 2 light points with dimmer function allow you to modulate the intensity and battery life as needed. The compact design makes it ideal as a pocket lamp for storage in a jacket pocket or work trousers. Supplied with USB charging cable and charger.

Multi-purpose lamp CBL03-W

Main Features

Type	Lumen Front / Flashlight	Duration Front / Flashlight	Energy Class	Magnetic Support	Charging Method	Degree of Protection	Operating Temperature Range °C	Body Material	Lamp Material	Dimensions mm	Weight g
CBL03-W	300/100	3/6 h	A++	Yes	USB/Wireless	IP65	-10/+40	ABS	PC	133x68x25	190

CBLIGHT

space-saving floor lamp

The most versatile of the family is the CBL04-W, which has a double light point, 2 dimmable light intensities, a rotatable and foldable stem and allows ideal lighting in all conditions.

The double magnetic support and the suspension hook allow the lamp to be secured anywhere with ease.

Designed to be easy to carry in a bag or trouser pocket while also offering excellent battery life and low weight portability.

The compact design ensures the CBL04-W is the ideal solution for inspecting difficult to reach areas. Supplied with USB charging cable and charger.



Space-saving floor lamp CBL04-W

Main Features

Type	Lumen Front / Flashlight	Duration Front / Flashlight	Energy Class	Magnetic Support	Charging Method	Degree of Protection	Operating Temperature Range °C	Body Material	Lamp Material	Dimensions mm	Weight g
CBL04-W	600/100	2.5/8 h	A++	Yes	USB/Wireless	IP54	-10/+40	ABS	PC	175 (325 max) x 44 x 38	246

CBL04-W

Tool Type	Plug Type	Supplied Battery Charger Type
CBL04-W	PLUG EU	ASC55-EU with EUROPEAN plug
CBL04-WE	PLUG UK	ASC55-UK with UK plug
CBL04-WA	PLUG USA CAN	ASC30-36-USA/CA (115V) with USA/CANADA plug



CBLIGHT

portable lamps

An ergonomic bi-component plastic handle makes the CBL05-W the most comfortable and robust lamp in the series, particularly suited to lengthy inspection work.

Featuring two light points, dimmer function and a long battery life.

Equipped with magnetic table support with retractable suspension hook.

Supplied with USB charging cable and charger.



Portable lamps CBL05-W

Main Features

Type	Lumen Front / Flashlight	Duration Front / Flashlight	Energy Class	Magnetic Support	Charging Method	Degree of Protection	Operating Temperature Range °C	Body Material	Lamp Material	Dimensions mm	Weight g
CBL05-W	600/100	2.5/10 h	A++	Yes	USB/Wireless	IP65	-10/+40	PC	PC	205 x 55 x 40	300

CBL05-W

Tool Type	Plug Type	Supplied Battery Charger Type
CBL05-W	PLUG EU	ASC55-EU with EUROPEAN plug
CBL05-WE	PLUG UK	ASC55-UK with UK plug
CBL05-WA	PLUG USA CAN	ASC30-36-USA/CA (115V) with USA/CANADA plug



CBL06

Tool Type	Plug Type	Supplied Battery Charger Type
CBL06	PLUG EU	ASC55-EU with EUROPEAN plug
CBL06E	PLUG UK	ASC55-UK with UK plug
CBL06A	PLUG USA CAN	ASC30-36-USA/CA (115V) with USA/CANADA plug

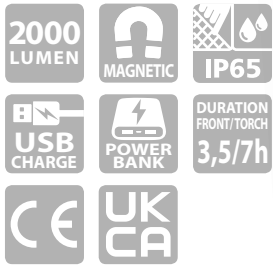

CBLIGHT

portable spotlight for small-medium work environments



The CBL06 portable spotlight meets the requirement of those who need to illuminate small-medium work environments.

The magnetic table mount allows the spotlight to be secured to metal surfaces. The power bank function allows small devices to be charged via the USB output, useful for emergency situations. Supplied with USB charging cable and charger.

Portable spotlight for small-medium work environments CBL06

Main Features

Type	Lumen Front / Flashlight	Duration Front / Flashlight	Energy Class	Magnetic Support	Charging Method	Degree of Protection	Operating Temperature Range °C	Body Material	Lamp Material	Dimensions mm	Weight g
CBL06	2000	3.5/7h	A++	Yes	USB	IP65	-10/+40	ABS	PC	195 x 125 x 48	800

CBL07

Tool Type	Plug Type	Supplied Battery Charger Type
CBL07	PLUG EU	ASC55-EU with EUROPEAN plug
CBL07E	PLUG UK	ASC55-UK with UK plug
CBL07A	PLUG USA CAN	ASC30-36-USA/CA (115V) with USA/CANADA plug

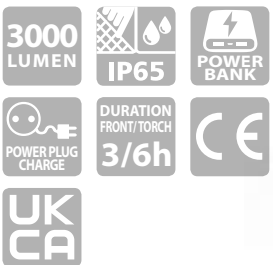

CBLIGHT

portable spotlight for large work environments



The diffused light emitted by the CBL07 spotlight enables the illumination of large areas. Light, practical and sturdy, this spotlight is quick to install. The power bank function allows small devices to be charged via the USB output, useful for emergency situations. Supplied with charger.

Portable spotlight for large work environments CBL07

Main Features

Type	Lumen	Duration	Energy Class	Magnetic Support	Charging Method	Degree of Protection	Operating Temperature Range °C	Body Material	Lamp Material	Dimensions mm	Weight g
CBL07	3000/1500	3/6h	A+	No	Power Plug	IP65	-10/+40	ABS	PC	277 x 213 x 86	1400

CBLIGHT

wireless charging bases

The BCB1-W and BCB2-W charging bases make it possible to keep the lamps fully charged meaning they are always ready for use. The magnetic construction allows quick attachment to metal surfaces along with holding the lamps in place during charging.

The BCB1-W single base is designed to recharge a single lamp. The BCB2-W allows 2 lamps to be charged at the same time. Supplied with USB charging cable and charger.

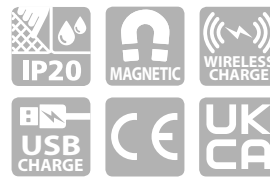

BCB2-W

BCB1-W

Wireless charging bases

Main Features

Type	Magnetic Support	Charging Method	Degree of Protection	Operating Temperature Range °C	Body Material	Dimensions mm	Weight g
BCB1-W	Yes	USB / Wireless	IP20	-10/+40	ABS	150 x 106 x 18 (single)	190
BCB2-W	Yes	USB / Wireless	IP20	-10/+40	ABS	202 x 106 x 18 (double)	270

BCB1-W BCB2-W

Tool Type	Plug Type	Supplied Battery Charger Type
BCB1-W	PLUG EU	ASC55-EU with EUROPEAN plug
BCB1-WE	PLUG UK	ASC55-UK with UK plug
BCB1-WA	PLUG USA/CA	ASC30-36-USA/CA (115V) with USA/CANADA plug
BCB2-W	PLUG EU	ASC55-EU with EUROPEAN plug
BCB2-WE	PLUG UK	ASC55-UK with UK plug
BCB2-WA	PLUG USA/CA	ASC30-36-USA/CA (115V) with USA/CANADA plug

CBLIGHT

extendable tripod

The TRCB2 tripod can be extended up to a maximum of 2.0 m, and offers maximum flexibility to position CBLIGHT lamps at the desired height.

When mounted on the tripod, the light can be tilted at will to provide the optimal beam angle.

Its robust structure makes it safe even when it is fully extended.



Type	Suitable for Lamp Type
TRCB2	CBL06 CBL07

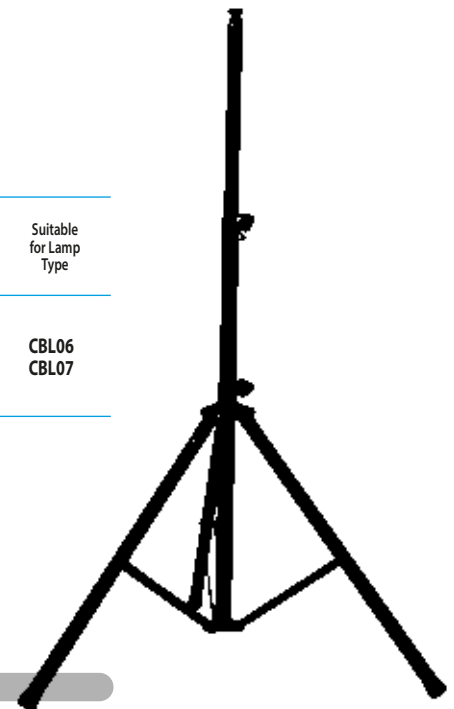

Extendable tripod TRCB2

Main Features

Type	Body Material	Minimum height open mm	Max height open mm	Base Ø maximum mm	Dimensions Closed mm	Weight g
TRCB2	Steel	1130	2000	1000	1030 x 160	3200

TRCB2

CBL08HD



Compatible with the battery system **METABO/CAS**

CBLIGHT HD

multipurpose portable headlight

The powerful and compact CBL08HD work light is designed for professional use.

The headlight is equipped with the latest high COB LED technology performance and provides up to 2000 lumens.

Compatible with METABO/CAS 18V batteries, in alternative can be used with PSCB18-power supply EU for direct power providing unlimited availability of light.

Built-in dimmer function allows you to adjust the emission of light in five different levels.

Integrated power bank with USB socket for charging devices furniture.

The work light is supplied without battery, it can be supplied on request and available as an accessory (see page 243)



Multipurpose portable headlight CBL08HD

Main Features

Type	Lumen	Duration with CB1852L Battery at Intensity Max / Min	Compatible with Batteries METABO /CAS	Bluetooth	Powered with Type (available on request)	Degree of Protection	Degree of Protection Bumps	Operating Temperature Range °C	Body Material	Lamp Material	Dimensions mm	Weight g
CBL08HD	2000	5.75 / 58 h	Yes	No	CB1820L / CB1852L PSCB18-EU	IP30	IK07	-10/+40	AL	PC	161 x 164 x 78	720

CBL09HD



Bluetooth®



Compatible with the battery system **METABO/CAS**

CBLIGHT HD

portable lighthouse for medium environments

The powerful and robust CBL09HD is equipped with the latest COB LED technology and provides up to 4000 lumens, which makes it a all-round universal work beacon for the user more demanding professional.

Compatible with METABO/CAS 18V batteries, in alternative can be used with PSCB18-power supply EU for direct power providing unlimited availability of light.

CBL09HD also has an internal back-up battery that provides up to 2.5 hours more at 400 lumens.

With the easy-to-use BLUETOOTH control app, you have the ability

to control on/off and control up to four working lights via one device mobile.

Built-in dimmer function allows you to adjust the light output in five different levels. Integrated power bank with USB socket for charging mobile devices.

Equipped with an integrated carrying handle.

It can be mounted on a stand CEMBRE TRCB1.

The work light is supplied without battery, it can be supplied on request and available as an accessory (see page 243)



Portable lighthouse for medium environments CBL09HD

Main Features

Type	Lumen	Duration with CB1852L Battery at Intensity Max / Min	Compatible with Batteries METABO /CAS	Bluetooth	Powered with Type (available on request)	Degree of Protection	Degree of Protection Bumps	Operating Temperature Range °C	Body Material	Lamp Material	Dimensions mm	Weight kg
CBL09HD	4000	3 / 31 h	Yes	Yes	CB1820L / CB1852L PSCB18-EU	IP65	IK07	-10/+40	AL	PC	263 x 230 x 119	2.35

CBLIGHT HD

portable lighthouse for large environments

The powerful and robust CBL10HD is equipped with the latest COB LED technology and provides up to 10,000 lumens, which makes a all-round universal work beacon for the user more demanding professional.

Compatible with METABO/CAS 18V batteries, in alternative can be used with PSCB18-power supply EU for direct power providing unlimited availability of light.



CBL10HD also has an internal back-up battery that provides up to 1 hour more at 1,000 lumens.

With the easy-to-use BLUETOOTH control app, you have the ability to control on/off and control up to four working lights via one device mobile.

Built-in dimmer function allows you to adjust the light output in five different levels. Integrated power bank with USB socket for charging mobile devices.

Equipped with an integrated carrying handle.

It can be mounted on a stand CEMBRE TRCB1.

The work light is supplied without battery, it can be supplied on request and available as an accessory (see page 243)



Bluetooth®



Compatible with the battery system METABO/CAS

Portable lighthouse for large environments CBL10HD

Main Features

Type	Lumen	Duration with CB1852L Battery at Intensity Max / Min	Compatible with Batteries METABO /CAS	Bluetooth	Powered with Type (available on request)	Degree of Protection	Degree of Protection Bumps	Operating Temperature Range °C	Body Material	Lamp Material	Dimensions mm	Weight kg
CBL10HD	10,000	1.25/ 12 h	Yes	Yes	CB1820L / CB1852L PSCB18-EU	IP65	IK07	-10/+40	AL	PC	304 x 292 x 131	3.72

CBLIGHT HD

360 degree portable light

CBL11HD provides scattered and uniform light at 360 degrees up to 10,000 lumen which is ideal for the professional requiring lighting that is powerful and efficient for the entire working area. It is ideal for any type of repair, painting or construction work.

Compact design with carrying handle makes it extremely handy and easy to move.



Switch lighting 360degree/180.

Compatible with METABO/CAS 18V batteries, in alternative can be used with PSCB18-power supply EU for direct power providing unlimited availability of light.

CBL11HD also has an internal back-up battery that provides up to 50 minutes more at 1,000 lumens.

With the easy-to-use BLUETOOTH control app, you have the possibility to control on/off and adjust the light output via a mobile device.

Built-in dimmer function allows you to adjust the light output in five different levels. Integrated power bank with USB socket for charging mobile devices.

Equipped with an integrated carrying handle.

It can be mounted on a stand CEMBRE TRCB1.

The work light is supplied without battery, it can be supplied on request and available as an accessory (see page 243)



Bluetooth®



Compatible with the battery system METABO/CAS

360 degree portable light CBL11HD

Main Features

Type	Lumen	Duration with CB1852L Battery at Intensity Max / Min	Compatible with Batteries METABO /CAS	Bluetooth	Powered with Type (available on request)	Degree of Protection	Degree of Protection Bumps	Operating Temperature Range °C	Body Material	Lamp Material	Dimensions mm	Weight kg
CBL11HD	10,000	1 / 22 h	Si	Si	CB1820L / CB1852L PSCB18-EU	IP65	IK07	-10/+40	AL	PC	395 x 200 x 212	3.7

CBL12HD



Compatible with the battery system **METABO/CAS**

CBLIGHT HD

tower lite

CBL12HD is a tripod with two integrated projectors capable of providing up to 5000 lumens. Equipped with flexible and rotatable 360° projectors, the lights can be positioned in different directions to get the angle of desired lighting, providing a perfect condition of lighting for every working need. It is extensible up to 2 meters and has 2 light levels (50-100%).

Compatible with METABO/CAS 18V batteries, in alternative can be used with PSCB18- EU power supply for direct power providing unlimited availability of light. Equipped with integrated handle and fast bending system, TOWER LITE is compact, lightweight and easy to carry. The work light is supplied without battery, it can be supplied on request and available as an accessory (see page 243)



Tower lite CBL12HD

Main Features

Type	Lumen	Duration with CB1852L Battery at Intensity Max / Min	Compatible with Batteries METABO /CAS	Bluetooth	Powered with Type (available on request)	Degree of Protection	Degree of Protection Bumps	Operating Temperature Range °C	Body Material	Lamp Material	Dimensions mm	Weight kg
CBL12HD	5.000	2 / 4.5 h	Yes	No	CB1852L, PSCB18-EU	IP30	IK07	-10/+40	AL	PC	121 x 153 x 892	5.2

TRCB1



MAX 3m

The TRCB1 tripod is extendable by yourself 1.35 m up to a maximum of 3 m, and offers maximum flexibility to position the CBLIGHT HD lights at the desired height. When mounted on the tripod, the light can be tilted as desired to provide the optimal beam angle.

Its robust structure makes it safe even when it is fully extended. Comes with anchor points which offer greater stability if the tripod is exposed to strong wind or you located on an uneven surface.

CBLIGHT HD

tripod

Tripod TRCB1

Main Features

Type	Suitable for Lamp Type	Maximum load kg	Weight kg
TRCB1	CBLO9HD CBL10HD CBL11HD	10	6

MIN 1.35m

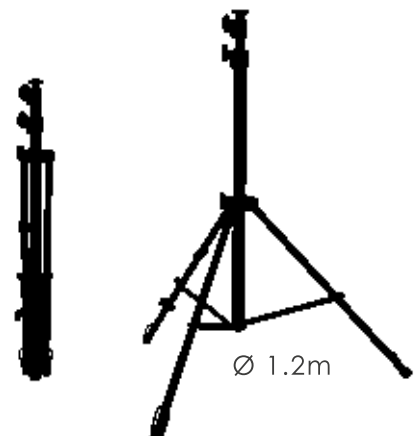

Ø 1.2m

CBLIGHT HD

power supply



Power supply for CBLIGHT HD

Main Features

Type	Input - Output	Suitable for Lamp Type	Degree of Protection	Degree of Protection Bumps	Operating Temperature Range °C	Dimensions mm	Weight kg
PSCB18-EU	100-240V AC 50/60Hz - 18V DC 5A	CBL08HD CBL09HD CBL10HD CBL11HD CBL12HD	IP65	IK07	-10/+40	124 x 83 x 72	1.0

PSCB18-EU

Tool Type	Plug Type
PSCB18-EU	with EUROPEAN plug PLUG EU
PSCB18-UK	with UK plug PLUG UK
PSCB18-USA/CA	with USA/CANADA plug PLUG USA/CA

Power supply for direct power supply of portable lights of the series CEMBRE CBLIGHT HD.

Power supply compatible only with CBLIGHT-HD, not suitable for cordless tools.

CBLIGHT HD

accessories

ASC55-EU

ASC55-EU, charger
(INPUT 220-240 V / 50-60 Hz;
OUTPUT 12-42 V DC / 3.0 A max.)



CB1820L, battery
Li-Ion 18.0V 2.0Ah



CB1820L



CB1852L, battery
Li-Ion 18.0V 5.2Ah



CB1852L



03.61C



Battery adapters for CBLIGHT HD

Smart adapters designed to use 18V/20V batteries from other manufacturers on the CEMBRE CBLIGHT HD series work lights.

Each adapter is compatible with the 18V/20V batteries supplied with the most popular brands of power tools. Simply mount the specific adapter on the work light, connect the battery and you are ready to work.

Type	Suitable for battery type
03.6149C	MILWAUKEE
03.6148C	MAKITA
03.6140C	BOSCH/AMPSHARE
03.6157C	HILTI
03.6142C	DEWALT

MAGNET BRACKET

Compact and very powerful magnetic bracket designed for flexible mounting and positioning of CBL09HD on any metallic surface.

MBCB-1



DOUBLE MAGNET BRACKET

Extremely powerful magnetic bracket designed for flexible mounting and positioning of CBL09HD and CBL10HD on any metallic surface. The bracket has 2 extremely powerful magnets.

MBCB-1D



SCAFFOLDING BRACKET

Specially designed to fix CBL09HD and CBL10HD lamps on scaffoldings. The mount can be attached to any round object Ø40-50 mm.

SBCB-1



insulated



To ensure quick identification, the type and size of the head are indicated in different colours on the back of the handle.

Each individual screwdriver is tested in accordance with EN 60900

The heads are made from Chromium Molybdenum steel with a hardness of 55-59 HRC and are hardened with Phosphoric Manganese Acid to increase corrosion resistance; the size of the insulating cover allows it to be inserted into tight spaces.



Blade type identification on the back of the handle

The CEMBRE range of insulated screwdrivers have dual compound handgrips and an ergonomic design making them particularly practical and comfortable in the

following modes of use:

- Normal
- Fast
- Forced

Chromium Molybdenum steel head with hardness 55-59 HRC and anti-corrosion surface treatment

Narrow insulating cover to allow insertion into tight spaces

Soft and durable hand guard

Ergonomic and shaped hand grip

Coating in dual compound plastic material with soft rubber inserts

Shaped blade for greater resistance and stability



Head type identification codes:

- White - Flat head
- Yellow - "Phillips" cross head
- Green - "Poizdriv" cross head
- Red - "Phillips" combination head
- Blue - "Poizdriv" combination head
- Orange - "Torx" six point star head



Steel tips



Ergonomic handle



Hand guard



Attachment hole

insulated



Flat head screwdrivers



Main Features

Type	Head Dimensions mm		Blade Length mm	Total Length mm	Weight g
	Width	Thickness			
SDC3X100-KV	3	0,5	100	185	32
SDC3.5X100-KV	3,5	0,6	100	185	35
SDC4X100-KV	4	0,8	100	205	58
SDC5.5X125-KV	5,5	1,0	125	230	78
SDC6.5X150-KV	6,5	1,2	150	265	115
SDC8X175-KV	8	1,2	175	298	181

PH Phillips cross head screwdrivers



Main Features

Type	Head Dimensions mm		Total Length mm	Weight g
	Size	Blade Length		
SDC0PH-KV	PH0	60	145	29
SDC1PH-KV	PH1	80	188	64
SDC2PH-KV	PH2	100	215	94

PZ Pozidriv cross head screwdrivers



Main Features

Type	Head Dimensions mm		Total Length mm	Weight g
	Size	Blade Length		
SDC0PZ-KV	PZ0	60	145	29
SDC1PZ-KV	PZ1	80	188	64
SDC2PZ-KV	PZ2	100	215	94

PHSL Phillips combination head screwdrivers



Main Features

Type	Head Dimensions mm		Total Length mm	Weight g
	Size	Blade Length		
SDC1PH-SL-KV	PH1 SL	80	188	65
SDC2PH-SL-KV	PH2 SL	100	215	94

PZSL Pozidriv combination head screwdrivers



Main Features

Type	Head Dimensions mm		Total Length mm	Weight g
	Size	Blade Length		
SDC1PZ-SL-KV	PZ1 SL	80	188	65
SDC2PZ-SL-KV	PZ2 SL	100	215	94

TORX six point star head screwdrivers



Main Features

Type	Head Dimensions mm		Total Length mm	Weight g
	Size	Blade Length		
SDC10TX-KV	TX10	80	185	60
SDC15TX-KV	TX15	80	185	63
SDC20TX-KV	TX20	100	205	68
SDC25TX-KV	TX25	100	205	73
SDC30TX-KV	TX30	115	230	100
SDC40TX-KV	TX40	130	245	118

Flat head screwdriver with mains tester



Main Features

Type	Head Dimensions mm		Total Length mm	Weight g
	Head Size	Length		
SDC3X60-PD	3	65	153	34

A fully functioning flat head screwdriver with a completely transparent handle allowing visibility of the indicator from any angle, ensuring high safety.

- Transparent handle
- High quality head
- Ergonomic design
- Pocket clip with spring



Screwdriver with 45° angled flat head



Main Features

Type	Head Dimensions mm		Blade Length mm	Total Length mm	Weight g
	Width	Thickness			
SDC2.5X55B	2,5	0,55	55	143	28
SDC3.5X55B	3,5	0,55	55	143	29

Screwdriver with angled head, ideal for terminals, sensors and actuators.



Flat head stubby screwdriver



Main Features

Type	Head Dimensions mm		Blade Length mm	Total Length mm	Weight g
	Width	Thickness			
SDCS2.5X55	5,5	2,5	25	75	37



Phillips cross head stubby screwdriver PH



Main Features

Type	Head Dimensions mm		Total Length mm	Weight g
	Size	Blade Length		
SDCS1PH	PH1	25	75	38



Set of 7 Screwdrivers - KSDC7-KV



Main Features

Set consists of: Type	Head Dimensions mm		Total Length mm	Weight g
	Size	Length		
SDC3X100-KV	3	100	185	32
SDC4X100-KV	4	100	205	58
SDC5.5X125-KV	5,5	125	230	78
SDC6.5X150-KV	6,5	150	265	115
SDC0PH-KV	PH0	60	145	29
SDC1PH-KV	PH1	80	188	64
SDC2PH-KV	PH2	100	215	94



PROFESSIONAL HEX SOCKET SCREWDRIVERS

SDC

with reduced shank diameter

Hex socket screwdrivers with reduced shank diameter



Main Features

Type	Head Dimensions mm	Blade Length mm	Total Length mm	Weight g
SDC7X125-HEX	7	125	243	97
SDC8X125-HEX	8	125	243	114
SDC9X125-HEX	9	125	243	132
SDC10X125-HEX	10	125	243	152

- Ergonomic handgrip for comfortable use without strain.
- Reduced external shank diameter allows the tool to be used in narrow spaces (relays and switches).
- Deep point socket ideal for long threads.
- Hexagonal lever point facilitates extra force without strain.
- Standards: ISO 6750 - ISO 2236



Deep point socket



Hexagonal lever point

Reduced shank diameter



UNIVERSAL KEY UKC4

UKC

for switchboards

Universal key for switchboards UKC4

Main Features

Type	Dimensions mm			Weight g
	Length	Width	Height	
UKC4	72	72	14	92

- Universal key for switchboards
 Equipped with:
 Triangular shape 7-8 mm
 Double notch 3-5 mm
 Square shape 5-6, 7-8 mm
 Screwdriver bit and hexagonal holder



UPC-KV
TR-KV
SPC-KV
WPC-KV

PROFESSIONAL PLIERS

insulated



As for all CEMBRE insulated tools, each individual pair of pliers is tested in accordance with EN 60900

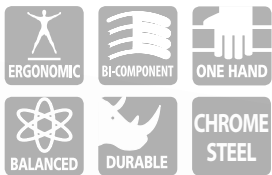

The design of CEMBRE insulated pliers and the use of dual-compound plastic material in the handle cover optimise the distribution of the force over the entire surface in contact with the palm of the hand.

This leads to:

- A reduction of the effort applied
- A greater transmitted force
- Safer grip
- Prevention of injury to the fingers between the handles

Special steel structure particularly resistant, cutting hard wire

Chrome finish

Soft and resistant hand guard

Particularly soft articulated joint

Soft Rubber inserts

Strong and long lasting grip zone

Extra-long cutting edge and large recess for wide cables

Shaped and ergonomic hand grip

Wide and safe hand guard

Insulated handles covered in dual-compound plastic material



Soft articulated joint

Ergonomic hand grip

Gripping and cutting edges



PROFESSIONAL PLIERS

insulated

UPC-KV
TR-KV
SPC-KV
WPC-KV



UPC Universal pliers

Main Features

Type	Total Length mm	Head Dimensions mm		Weight g
		Width	Thickness	
UPC180-KV	180	27	11	287
UPC200-KV	200	32	11,6	381

TR Nippers

Main Features

Type	Total Length mm	Head Dimensions mm		Weight g
		Width	Thickness	
TR160-KV	160	19	10	229

TR Heavy duty nippers

Main Features

Type	Total Length mm	Head Dimensions mm		Weight g
		Width	Thickness	
TR200-KV	200	30	13	306

SPC Straight nose pliers

Main Features

Type	Total Length mm	Head Dimensions mm		Weight g
		Width	Thickness	
SPC200-KV	200	21,5	10,7	257

SPC 45° nose pliers

Main Features

Type	Total Length mm	Head Dimensions mm		Weight g
		Width	Thickness	
SPC200B-KV	200	21,5	10,7	261

WPC Pipe grips

Main Features

Type	Total Length mm	Head Dimensions mm		Weight g
		Width	Thickness	
WPC250-KV	250	29	7,7	380

WSC Wire stripper

Main Features

Type	Total Length mm	Head Dimensions mm		Weight g
		Width	Thickness	
WSC180-KV	180	21,7	9,5	240

For insulated cables from 0,75 to 6 mm²



CEMBRE offers a range of tool holders designed to provide professional users with practical and neat ways to optimise their time and working conditions.

Bag CTSB1

Main Features

Type	Dimensions mm			Weight kg
	Length	Width	Height	
CTSB1	420	250	340	3

Practical tool bag in robust fabric, with 2 separate compartments to neatly arrange hand tools. Additional equipment may be accommodated via handy hooks and external pockets while documents are safely stored inside. A shoulder strap and sturdy metal handle make it easy to carry.



bag kit CTSB1-1

Main Features

Type	Dimensions mm			Kit Weight kg
	Length	Width	Height	
KIT-CTSB1-1	420	250	340	5,6

CTSB1 equipped with selection of tools.

Tools contained in the kit:

Qty	Type	Description
1	SC5X	scissors SC5X
1	SDC3X60-PD	mains tester
1	SDC3X100-KV	screwdriver 3x100
1	SDC3.5X100-KV	screwdriver 3,5x100
1	SDC4X100-KV	screwdriver 4x100
1	SDC5.5X125-KV	screwdriver 5,5x125
1	SDC1PH-KV	screwdriver ph1
1	SDC2PH-KV	screwdriver ph2
1	SDC1PZ-KV	screwdriver pz1
1	SDC2PZ-KV	screwdriver pz2
1	UPC180-KV	pliers 180 mm
1	FLS3	measuring tape 3m
1	KAK9	allen keys
1	HB18	retractable cutter
1	HKS6	pocket hacksaw
1	LVL150	level 150 mm
1	HMR300	hammer



bag kit KIT-CTSB1-3

Main Features

Type	Dimensions mm			Kit Weight kg
	Length	Width	Height	
KIT-CTSB1-3	420	250	340	6,8

CTSB1 equipped with selection of tools.

Tools contained in the kit:

Qty	Type	Description
1	SC5X	scissors SC5X
1	SDC3X60-PD	mains tester
1	SDC3X100-KV	screwdriver 3x100
1	SDC3.5X100-KV	screwdriver 3,5x100
1	SDC4X100-KV	screwdriver 4x100
1	SDC5.5X125-KV	screwdriver 5,5x125
1	SDC1PH-KV	screwdriver ph1
1	SDC2PH-KV	screwdriver ph2
1	SDC1PZ-KV	screwdriver pz1
1	SDC2PZ-KV	screwdriver pz2
1	UPC180-KV	pliers 180 mm
1	TR160-KV	nippers 160 mm
1	PTS4	wire stripper 0,2-6 mm ²
1	FLS5	measuring tape 5 m
1	KAK9	allen keys
1	KRK4	spanners with ratchet
1	UKC4	universal key
1	HB18	retractable cutter
1	HKS6	pocket hacksaw
1	LVL150	level 150 mm
1	HMR300	hammer





Backpack CTBP1

Main Features

Type	Dimensions mm			Weight kg
	Length	Width	Height	
CTBP1	360	110	540	3,1

Practical tool backpack in sturdy fabric, with reinforced non-slip rubber bottom. Equipped with internal and external pockets to arrange the manual tools in a rational way, and a PC pocket. Thanks to the practical front opening and the different compartments, it is possible to insert documents and different equipment. The sturdy rubber handle and comfortable padded shoulder straps make it easy to carry.



Backpack kit CTBP1-1

Main Features

Type	Dimensions mm			Peso Kit kg
	Length	Width	Height	
KIT-CTBP1-1	360	110	540	4,1

CTBP1 equipped with selection of tools.

Tools contained in the kit:

Qty	Type	Description
1	SC5X	scissors SC5X
1	SDC3X60-PD	mains tester
1	SDC3X100-KV	screwdriver 3x100
1	SDC3.5X100-KV	screwdriver 3,5x100
1	SDC4X100-KV	screwdriver 4x100
1	SDC5.5X125-KV	screwdriver 5,5x125
1	SDC1PH-KV	screwdriver ph1
1	SDC2PH-KV	screwdriver ph2
1	UPC180-KV	pliers 180 mm
1	HKS6	pocket hacksaw



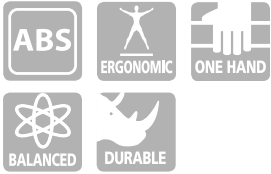

ABS case VAL-GPTP

Main Features

Type	Dimensions mm			Weight kg
	Length	Width	Height	
VAL-GPTP	453	332	190	4,0

Suitcase made of high thickness thermoformed ABS, complete with two tool panels with elastic bands for containing any tool and internal document / tablet pocket. Thermoformed bottom with adjustable dividers. Sturdy aluminum profile with 2 side locks with key. Lid equipped with a stop to limit 90 ° opening and ergonomic handle.





ABS case kit VAL-GTP-1

Main Features

Type	Dimensions mm			Kit Weight kg
	Length	Width	Height	
KIT-VAL-GTP-1	453	332	190	6,6

Case VAL-GTP equipped with selection of tools.

Tools contained in the kit:

Qty	Type	Description
1	SC5X	scissors SC5X
1	SDC3X60-PD	mains tester
1	SDC3X100-KV	screwdriver 3x100
1	SDC3.5X100-KV	screwdriver 3,5x100
1	SDC4X100-KV	screwdriver 4x100
1	SDC5.5X125-KV	screwdriver 5,5x125
1	SDC1PH-KV	screwdriver ph1
1	SDC2PH-KV	screwdriver ph2
1	SDC1PZ-KV	screwdriver pz1
1	SDC2PZ-KV	screwdriver pz2
1	UPC180-KV	pliers 180 mm
1	FLS3	measuring tape 3m
1	KAK9	allen keys
1	HB18	retractable cutter
1	HKS6	pocket hacksaw
1	LVL150	level 150 mm
1	HMR300	hammer

ABS case kit VAL-GTP-2

Main Features

Type	Dimensions mm			Kit Weight kg
	Length	Width	Height	
KIT-VAL-GTP-2	453	332	190	8,2

Case VAL-GTP equipped with selection of tools.



Tools contained in the kit:

Qty	Type	Description
1	SC5X	scissors SC5X
1	SDC3X60-PD	mains tester
1	SDC3X100-KV	screwdriver 3x100
1	SDC3.5X100-KV	screwdriver 3,5x100
1	SDC4X100-KV	screwdriver 4x100
1	SDC5.5X125-KV	screwdriver 5,5x125
1	SDC1PH-KV	screwdriver ph1
1	SDC2PH-KV	screwdriver ph2
1	SDC1PZ-KV	screwdriver pz1
1	SDC2PZ-KV	screwdriver pz2
1	UPC180-KV	pliers 180 mm
1	TR160-KV	nippers 160 mm
1	PTS4	wire stripper 0.2-6 mm ²
1	FLS5	measuring tape 5 m
1	KAK9	allen keys
1	KRK4	spanners with ratchet
1	UKC4	universal key
1	HB18	retractable cutter
1	HKS6	pocket hacksaw
1	LVL150	level 150 mm
1	HMR300	hammer



Case VAL-GPTA-N

Main Features

Type	Dimensions mm			Weight Kg
	Length	Width	Height	
VAL-GPTA-N	470	360	185	4,8

Aluminium case containing two panels with elastic tool holders and an internal pocket for holding documents or a tablet. Thermoformed base with modular dividers. Fitted with an ergonomic carrying handle and a hinged lid with stop to limit the opening to 90°. Equipped with shoulder strap.





Case Kit VAL-GPTA-1

Main Features

Type	Dimensions mm			Kit Weight kg
	Length	Width	Height	
KIT-VAL-GPTA-1	470	360	185	7,4

Case VAL-GPTA-N equipped with selection of tools.

Tools contained in the kit:

Qty	Type	Description
1	SC5X	scissors SC5X
1	SDC3X60-PD	mains tester
1	SDC3X100-KV	screwdriver 3x100
1	SDC3.5X100-KV	screwdriver 3,5x100
1	SDC4X100-KV	screwdriver 4x100
1	SDC5.5X125-KV	screwdriver 5,5x125
1	SDC1PH-KV	screwdriver ph1
1	SDC2PH-KV	screwdriver ph2
1	SDC1PZ-KV	screwdriver pz1
1	SDC2PZ-KV	screwdriver pz2
1	UPC180-KV	pliers 180 mm
1	FLS3	measuring tape 3m
1	KAK9	allen keys
1	HB18	retractable cutter
1	HKS6	pocket hacksaw
1	LVL150	level 150 mm
1	HMR300	hammer

Case Kit VAL-GPTA-2

Main Features

Type	Dimensions mm			Kit Weight kg
	Length	Width	Height	
KIT-VAL-GPTA-2	470	360	185	9,6

Case VAL-GPTA-N equipped with selection of tools.

Tools contained in the kit:

Qty	Type	Description
1	SC5X	scissors SC5X
1	SDC3X60-PD	mains tester
1	SDC3X100-KV	screwdriver 3x100
1	SDC3.5X100-KV	screwdriver 3,5x100
1	SDC4X100-KV	screwdriver 4x100
1	SDC5.5X125-KV	screwdriver 5,5x125
1	SDC1PH-KV	screwdriver ph1
1	SDC2PH-KV	screwdriver ph2
1	SDC1PZ-KV	screwdriver pz1
1	SDC2PZ-KV	screwdriver pz2
1	UPC180-KV	pliers 180 mm
1	TR160-KV	nippers 160 mm
1	PTS4	wire stripper 0.2-6 mm ²
1	FLS5	measuring tape 5 m
1	KAK9	allen keys
1	KRK4	spanners with ratchet
1	UKC4	universal key
1	HB18	retractable cutter
1	HKS6	pocket hacksaw
1	LVL150	level 150 mm
1	HMR300	hammer





Trolley TRL02

Main Features

Type	Dimensions mm				Weight kg
	Length	Width	Closed handle height	Open handle height	
TRL02	480	250	400	1023	4,3

Practical trolley mounted tool bag made of robust fabric, with 2 separate internal compartments to neatly arrange hand tools. Easy front opening access and handy hooks, external pockets providing additional space and a document pouch on the inside of the lid.





Trolley Kit TRL02-1

Main Features

Type	Dimensions mm				Weight Kit kg
	Length	Width	Closed handle height	Open handle height	
KIT-TRL02-1	480	250	400	1023	6,8

Trolley TRL02 equipped with selection of tools.

Tools contained in the kit:

Qty	Type	Description
1	SC5X	scissors SC5X
1	SDC3X60-PD	mains tester
1	SDC3X100-KV	screwdriver 3x100
1	SDC3.5X100-KV	screwdriver 3,5x100
1	SDC4X100-KV	screwdriver 4x100
1	SDC5.5X125-KV	screwdriver 5,5x125
1	SDC1PH-KV	screwdriver ph1
1	SDC2PH-KV	screwdriver ph2
1	SDC1PZ-KV	screwdriver pz1
1	SDC2PZ-KV	screwdriver pz2
1	UPC180-KV	pliers 180 mm
1	FLS3	measuring tape 3m
1	KAK9	allen keys
1	HB18	retractable cutter
1	HKS6	pocket hacksaw
1	LVL150	level 150 mm
1	HMR300	hammer

Trolley Kit TRL02-2

Main Features

Type	Dimensions mm				Weight Kit kg
	Length	Width	Closed handle height	Open handle height	
KIT-TRL02-2	480	250	400	1023	8,0

Trolley TRL02 equipped with selection of tools.

Tools contained in the kit:

Qty	Type	Description
1	SC5X	scissors SC5X
1	SDC3X60-PD	mains tester
1	SDC3X100-KV	screwdriver 3x100
1	SDC3.5X100-KV	screwdriver 3,5x100
1	SDC4X100-KV	screwdriver 4x100
1	SDC5.5X125-KV	screwdriver 5,5x125
1	SDC1PH-KV	screwdriver ph1
1	SDC2PH-KV	screwdriver ph2
1	SDC1PZ-KV	screwdriver pz1
1	SDC2PZ-KV	screwdriver pz2
1	UPC180-KV	pliers 180 mm
1	TR160-KV	nippers 160 mm
1	PTS4	wire stripper 0.2-6 mm ²
1	FLS5	measuring tape 5 m
1	KAK9	allen keys
1	KRK4	spanners with ratchet
1	UKC4	universal key
1	HB18	retractable cutter
1	HKS6	pocket hacksaw
1	LVL150	level 150 mm
1	HMR300	hammer



VAL-GPT KIT-VAL-GPT

PROFESSIONAL TOOL HOLDERS

hard line

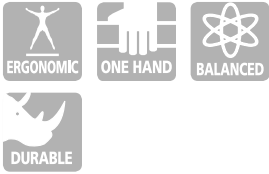

Chest VAL-GPT

Main Features

Type	Dimensions mm			Weight kg
	Length	Width	Height	
VAL-GPT	557	230	245	3,7

Plastic tool chest with small parts holder on the lid; Removable internal tool tray. Metal latches; Aluminium handle and padlock facility. Sufficiently robust to be used as a step when closed. Stackable with other VAL GPT tool chests.



Chest Kit VAL-GPT-1

Main Features

Type	Dimensions mm			Weight Kit kg
	Length	Width	Height	
KIT-VAL-GPT-1	557	230	245	5,48

VAL GPT equipped with selection of tools

Tools contained in the kit:

Qty	Type	Description
1	SC5X	scissors SC5X
1	SDC3X60-PD	mains tester
1	SDC3.5X100-KV	screwdriver 3,5x100
1	SDC4X100-KV	screwdriver 4x100
1	SDC5.5X125-KV	screwdriver 5,5x125
1	SDC6.5X150-KV	screwdriver 6,5x150
1	SDC1PH-KV	screwdriver ph1
1	SDC2PH-KV	screwdriver ph2
1	TR160KV	nippers 160mm
1	FLS3	measuring tape 3m
1	HB18	retractable cutter
1	HKS6	pocket hacksaw
1	LVL150	level 150 mm
1	HMR300	hammer





Pouch CTBB1

Main Features

Type	Dimensions mm			Weight g
	Length	Width	Height	
CTBB1	230	150	50	84

Made from soft and strong fabric, equipped with a fast stud belt fastening. It has handy preformed compartments for holding pliers, scissors and screwdrivers.

With SC5X scissor

Robust-A



Pouch Kit CTBB1-1

Main Features

Type	Dimensions mm			Weight Kit g
	Length	Width	Height	
KIT-CTBB1-1	230	150	50	477

CTBB1 equipped with selection of tools.

Tools contained in the kit:

Qty	Type	Description
1	SC5X	scissors SC5X
1	SDC3X100-KV	screwdriver 3x100
1	SDC3.5X100-KV	screwdriver 3,5x100
1	SDC4X100-KV	screwdriver 4x100
1	SDC1PH-KV	screwdriver ph1
1	SDC2PH-KV	screwdriver ph2

Pouch Kit CTBB1-5

Main Features

Type	Dimensions mm			Weight Kit g
	Length	Width	Height	
KIT-CTBB1-5	230	150	50	442

CTBB1 equipped with selection of tools.

With SC6X scissor

Agil-E



Tools contained in the kit:

Qty	Type	Description
1	SC6X	scissors SC6X
1	SDC3X100-KV	screwdriver 3x100
1	SDC3.5X100-KV	screwdriver 3,5x100
1	SDC4X100-KV	screwdriver 4x100
1	SDC1PH-KV	screwdriver ph1
1	SDC2PH-KV	screwdriver ph2



CW Combination Spanners

Main Features

Type	Hex mm	Open width mm	Ring width mm	Open thickness mm	Ring thickness mm	Total Length mm	Weight g
CW60	6	16	10	4	5	110	15
CW70	7	17	11	4	5	120	19
CW80	8	19	13	4	6	130	24
CW100	10	23	16	5	7	150	35
CW110	11	26	17	5	7	160	47
CW130	13	30	20	6	8	180	68
CW140	14	32	21	6	9	190	79
CW150	15	34	23	6	10	200	89
CW170	17	37	26	7	10	220	124
CW180	18	39	27	7	11	230	149
CW190	19	41	28	7	11	240	166
CW220	22	47	32	8	13	270	227
CW240	24	51	35	8	14	290	293
CW270	27	56	39	9	15	320	374
CW300	30	62	43	10	15	350	475
CW320	32	66	46	10	16	370	580

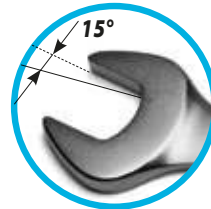

- Chromium-vanadium steel tools
- Satin chrome finish.
- Ring head with 12 grip points, offset with respect to the handle to enable use in narrow spaces
- Open head tilted at 15° to reduce effort applied
- Standards: UNI ISO 3318 - ISO 7738 - DIN 3113



PROFESSIONAL SPANNERS

in Chromium-vanadium steel

KCW



KCW12



KCW12 Combination Spanner Set

Main Features

Type	Dimensions kit mm			Weight g
	Length	Width	Height	
KCW12	460	362	65	1140

Set includes:

KCW12:
 CW60 - CW70 - CW80 - CW100 - CW110
 CW130 - CW140 - CW150 - CW170 - CW180
 CW190 - CW220

Type	mm
CW60	6
CW70	7
CW80	8
CW100	10
CW110	11
CW130	13
CW140	14
CW150	15
CW170	17
CW180	18
CW190	19
CW220	22

KCW16 Combination Spanner Set

Main Features

Type	Dimensions kit mm			Weight g
	Length	Width	Height	
KCW16	712	480	80	3250

Set includes:

KCW16:
 CW60 - CW70 - CW80 - CW100 - CW110
 CW130 - CW140 - CW150 - CW170 - CW180
 CW190 - CW220 - CW240 - CW270 - CW300 - CW320

Type	mm
CW60	6
CW70	7
CW80	8
CW100	10
CW110	11
CW130	13
CW140	14
CW150	15
CW170	17
CW180	18
CW190	19
CW220	22
CW240	24
CW270	27
CW300	30
CW320	32

KCW16





Combination spanners with jointed ratchet head KRK4

Main Features

Type	Dimensions kit mm			Weight g
	Length	Width	Height	
KRK4	335	190	18	390

- Sizes included: 8-10-13-17 mm
- Chromium-vanadium steel
- 180° swivel head
- Ratchet mechanism with 72 teeth and recovery angle of 5°.

Socket set 1/4" drive KRS47

Main Features

Type	Dimensions kit mm			Weight g
	Length	Width	Height	
KRS47	285	136	44	1655

- Standards: UNI ISO 3315 - DIN 3122

Metal case contains:

Qty	description
1	reversible ratchet wrench with socket retention system
2	extensions
1	articulated joint
1	T bar with sliding handle
1	screwdriver style holder
13	sockets 4 to 14 mm
4	extended sockets 8 to 13 mm
3	screwdriver sockets 4 to 6.5 mm
3	screwdriver sockets PH1, PH2, PH3
3	screwdriver sockets PZ1, PZ2, PZ3
6	hex socket spanners 3 to 8 mm
3	hex Allen keys 1.5 to 2.5 mm
6	torx socket keys T10 to T40



PROFESSIONAL TORQUE WRENCHES

TWC

in Chromium-vanadium steel

CEMBRE professional reversible torque wrench range TWC will provide optimum torque setting when the threaded fastenings are paired with the same size sockets.

Correct tightening of threaded fastenings prevents:

- thread damage in case of high loading
- unintentional loosening in case of low loading



TWC10.60-38N Torque Wrench

Main Features

Type	Dimensions mm			Weight g
	Length	Width	Head Width	
TWC10.60-38N	389	33	28	940

- Adjustment range Nm: 10-60
- Drive size in: 3/8"



TWC20.100-38N Torque Wrench

Main Features

Type	Dimensions mm			Weight g
	Length	Width	Head Width	
TWC20.100-38N	428	33	35	1040

- Adjustment range Nm: 20-100
- Drive size in: 3/8"



TWC40.220-12N Torque Wrench

Main Features

Type	Dimensions mm			Weight g
	Length	Width	Head Width	
TWC40.220-12N	507	40	40	1160

- Adjustment range Nm: 40-220
- Drive size in: 3/8"

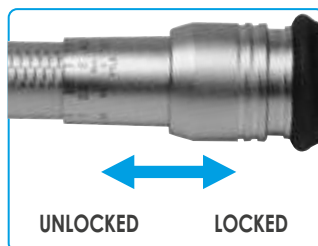
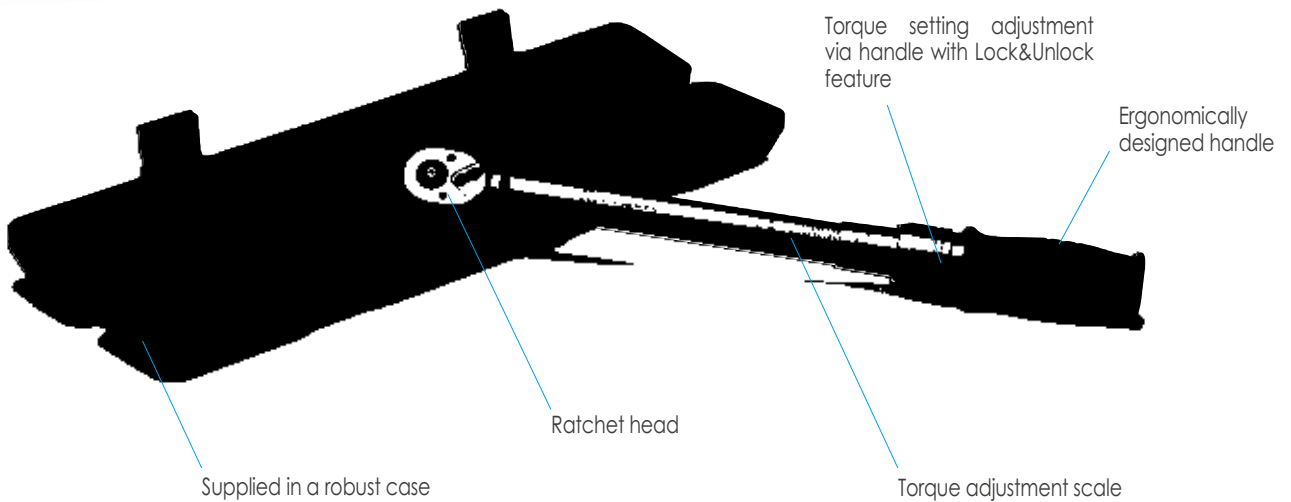



Deep hexagonal sockets 1/2" drive DSC

Main Features

Type	mm	Dimensions mm			Weight g
		Length	Ø Ext. hexagon	Ø Ext. drive	
DSC12-170L	17	77	23,8	22	120
DSC12-190L	19	77	25,7	24	134
DSC12-240L	24	77	31,8	27,8	210
DSC12-300L	30	77	39,9	34	300
DSC12-320L	32	77	41,8	35,8	336

- Chromium-vanadium steel • Satin chrome finish
- Standards: UNI ISO 2725 - DIN 3124



Adapters KA

Main Features

Type	Length	Dimensions mm			Weight g
		Female	Male	Ø Female	
KA14-38	26,5	1/4	3/8	13,9	21
KA38-14	26,3	3/8	1/4	18,8	25
KA38-12	36,1	3/8	1/2	19,2	52
KA12-38	35,99	1/2	3/8	21,7	52

- Chromium-vanadium steel • Satin chrome finish
- Standards: UNI ISO 3316 - DIN 3123



1/2" Reversible ratchet wrench CRH12

Main Features

Type	Dimensions mm			Weight g
	Length	Height	Head Width	
CRH12	260	38	40	547



- Mechanism with 72 teeth and a recovery angle of 5°
- Reversible ratchet system • Ergonomic handle in dual-compound material
- Satin chrome finish • Chromium-vanadium steel
- Standards: UNI ISO 3315 - DIN 3122



1/2" Drive extension 250 mm long EBC12-250

Main Features

Type	Length	Weight g
EBC12-250	250	441

- Socket quick release system • Chromium-vanadium steel
- Satin chrome finish
- Standards: UNI ISO 3316 - DIN 3123



1/2" Drive T bar with sliding handle STBC12-300

Main Features

Type	Dimensions mm			Weight g
	Length	Height	Head Width	
STBC12-300	300	25	24	365

- Chromium-vanadium steel • Satin chrome finish
- Standards: UNI ISO 3315 - DIN 3122



PROFESSIONAL SPANNERS & SOCKETS

in Chromium-vanadium steel

AWC



Adjustable wrench AWC300

Main Features

Type	Dimensions mm			Weight g
	Max Opening	Length	Width	
AWC300	34	300	-	620

- Chromium-vanadium steel wrench
- Phosphate finish
- Equipped with rapid adjustment and gap size measurement scale
- Wide-opening jaws for greater adaptability

PROFESSIONAL SPANNERS & SOCKETS

in Chromium-vanadium steel

KAK



Set of 9 male Allen keys KAK9

Main Features

Type	Dimensions kit mm			Weight g
	Length	Width	Height	
KAK9	300	100	31	430

- Sizes included: 1.5-2-2.5-3-4-5-6-8-10 mm
- Chromium-vanadium steel
- Long reach type
- Spherical head for use up to 30°
- Equipped with carrying case

Tool dimensions

A/F (mm)	(mm)	(mm)
1,5	78	14
2	84	16
2,5	92	18
3	102	20
4	110	24
5	123	28
6	144	32
8	163	36
10	178	40

Hammer HMR300

Main Features

Type	Dimensions mm			Weight g
	Length	Width	Height	
HMR300	300	104	23	300

300 g bench hammer with patented anti-vibration triple compound handle. Aluminium alloy 6082 T6 P-Al Si 1 Mg Mn head. External surface of the handle in Polyamide A2800. Thermoplastic rubber grip. Complete with handle sleeve.



Hammer HMR500W

Main Features

Type	Dimensions mm			Weight g
	Length	Width	Height	
HMR500W	320	106	27	500

500 g bench hammer with Ash handle. Complete with handle sleeve.



Chisel with hand protector BLC250

Main Features

Type	Dimensions mm				Weight g
	Total length	Blade width	Ø shaft	Ø handle	
BLC250	250	23	16	34	492

23 mm Chromium-vanadium steel blade with sturdy thermoplastic hand protector



Centre Punch CPC100-8

Main Features

Type	Dimensions mm			Weight g
	Length	Tip	Hexagon	
CPC100-8	100	3	8	54

Chromium-vanadium steel with Chrome finish



Crowbar CPW500

Main Features

Type	Dimensions mm		Weight g
	Length	Ø Hex. square	
CPW500	500	16	1183

Hexagonal section C40 steel





Special blade and safety lock

Retractable Cutter HB18

Main Features

Type	Dimensions mm			Weight g
	Length	Height	Width	
HB18	170	32	17	223

Replaceable blade, adjustable from 18 mm and internal autoloader with 5 blades. Steel blade, metal handle, with soft Rubber anti-slip coating. Safety lock for blade.



Hacksaw HKS12

Main Features

Type	Dimensions mm			Weight g
	Length	Height	Width	
HKS12	400	140	32	600

Hacksaw with 300 mm blade, dual-compound plastic frame, with soft anti-slip handle for a firm and secure grip. Tensioner in the handle.



Hacksaw HKS6

Main Features

Type	Dimensions mm			Weight g
	Length	Height	Width	
HKS6	270	115	20	215

Hacksaw with 150 mm blade, metal frame, with 6 adjustments of the angle of the blade. Soft Rubber anti-slip handle.



Blade BL12HKS

BL12HKS Spare blade for HKS12 (5 pieces)

Blade BL6HKS

BL6HKS Spare blade for HKS6 (10 pieces)

Files SFC200 - RFC200

Main Features

Second-cut square file SFC200	File Section mm	File Length mm	handle Length mm	Total Length mm	Weight g
		8	200	110	310
Second-cut round file RFC200	File diam. mm	File Length mm	handle Length mm	Total Length mm	Weight g
		8,3	200	110	310

Carbide steel
Hardness 62±2 HRC



Digital Multimeter CM02

Main Features

Type	Dimensions mm			Weight g
	Length	Width	Height	
CM02	190	94	46	400

For measuring:

- AC Current and Voltage, True-rms for accurate check of non-linear signals.
- AC/DC Voltage up to 750V~ and 1.000V=
- AC/DC Current up to 10A
- Resistance
- Continuity
- Capacitance
- Frequency

Special Functions





- Data Hold
- Diode Test
- Transistor hFE Test
- Continuity Buzzer
- Temperature Probe (supplied)
- Auto Power Off

Standards: EN 61326-1: 2006 & CE marking

CM02 Specification

Basic Function	Range	Best Accuracy
DC Voltage	400mV/4V/40V/400V/1000V	$\pm(0,5\%+4)$
AC Voltage	400mV/4V/40V/400V/1000V	$\pm(0,8\%+10)$
DC Current	400 μ A/4000 μ A/40mA/400mA/10A	$\pm(1\%+10)$
AC Current	400 μ A/4000 μ A/40mA/400mA/10A	$\pm(1,5\%+10)$
Resistance	400 Ω /4K Ω /40K Ω /400K Ω /4M Ω /40M Ω	$\pm(0,8\%+4)$
	10nF	$\pm(5\%+20)$
Capacitance	100nF/1 μ F/10 μ F/100 μ F	$\pm(3,5\%+8)$
	1mf/10mF/100mF	$\pm(5\%+10)$
Frequency	100/1000/10k/100k/1M/30Mhz	$\pm(0,5\%+10)$
Temperature	(-20°-1.000)°C	$\pm(1,0\%+5)$

Overvoltage category CAT IV - 600V

			
<p>Devices not directly connected to mains power</p>	<p>Household appliances and portable tools</p>	<p>Fixed installations and connected equipment</p>	<p>Electricity meters, external transformers</p>



TRMS





Measuring Tapes FLS3 - FLS5

Main Features

Type	Tape dimensions		Casing Dimensions mm	Weight g
	Length	Width		
FLS3	3 m	16 mm	71x62x33	166
FLS5	5 m	19 mm	83x71x36	252

Professional measuring tapes with ergonomic hand grip, metal casing and rubber inserts. Tape coating in Polyamide to ensures durability, anti-friction and resistance to corrosion; with integrated magnetic hook. Automatic lock and dual locking button.

Spirit Levels LVL150 – LVL200 – LVL400

Main Features

Type	Dimensions mm		No. of tubes	Weight g
	Length	Width		
LVL150	150	22	2	105
LVL200	200	22	2	157
LVL400	400	22	2	248

Made from robust Aluminium profile, with precision 0.5 to 1 mm. Shock resistant tubes and high absorption protective caps.



Conical stepped drill-bit SC-PG1

Type	Hole Ø range mm	Steps		Drill size mm		Weight g
		N°	Height mm	Length	Stem Ø	
SC-PG1	6-37	12	2	100	10	293

- Point geometry according to DIN 1412 C
- No pre-drilling
- Step angle 90°

SC-PG1 - Hole sizes:

Step	Hole Ø mm	Clearance for PG thread
1	6,0	-
2	9,0	-
3	12,5	7
4	15,2	9
5	18,6	11
6	20,4	13,5
7	22,5	16
8	26,0	-
9	28,3	21
10	30,5	-
11	34,0	-
12	37,0	29



Conical stepped drill-bits - General characteristics

- Spiral shape facilitates quiet operation, precision of cut and removal of swarf
- Cutting capability unaffected by prolonged use
- Suitable for use on Ferrous metals and Thermoplastic materials up to 4 mm thickness
- Material: Cubic Boron Nitride (CBN)
- Corner point 118°
- Polished surface

Conical stepped drill-bit SC-M1

Type	Hole Ø range mm	Steps		Drill size mm		Weight g
		N°	Height mm	Length	Stem Ø	
SC-M1	6,5-40,5	11	2	96	10	303

- Point geometry according to DIN 1412 C
- No pre-drilling
- Step angle 90°

SC-M1 - Hole sizes:

Step	Hole Ø mm	Clearance for Metric thread
1	6,5	-
2	8,5	-
3	10,5	-
4	12,5	M12
5	16,5	M16
6	20,5	M20
7	25,5	M25
8	29,0	-
9	32,5	M32
10	36,5	-
11	40,5	M40



Conical countersink SK9038

Type	Head Dimensions mm		Total Length mm	Weight g
	Length	Ø		
SK9038	36	38	148	128

- Conical flaring for unalloyed steels, with ergonomic handle in two component material.
- 90° head angle
 - 6-edged head
 - Maximum diameter of flaring 38 mm



Sets of 19 Spiral Drill-Bits SB19

Main Features

Ideal for STEEL

Type

SB19

High speed, high performance, steel spiral drill-bits. Cross-wise sharpening allows for good balance, reducing strain during the operation.

Spiral angle: 25-30°

Groove profile: standard

Core: standard

Back angle: 118°

Point geometry: Shape C

Weight: 675 g

Main use: Steel N/mm² <900, Cast iron

Secondary use: Steel N/mm² <1100, Stainless steel, Aluminium, Brass, Bronze.

Type

SB19-TIN

As type SB19 with additional:

TiN coating to increase operating life by 300 - 400%

SB19-TIN



SB19

Spiral Drill-bits SB19:

Spiral Drill-bits SB19-TIN:

Ø mm	Length mm	
	Total	Useable
1	34	12
1,5	40	18
2	49	24
2,5	57	30
3	61	33
3,5	70	39
4	75	43
4,5	80	47
5	86	52
5,5	93	57
6	93	57
6,5	101	63
7	109	69
7,5	109	69
8	117	75
8,5	117	75
9	125	81
9,5	125	81
10	133	87

Set of 7 Hammer Drill-Bits SB7-SDS-PLUS

Main Features

Ideal for WALL

Type

SB7-SDS-PLUS

Drill-bits with a strengthened core, to allow optimum force transmission from start to finish.

Made from steel worked at a low temperature to achieve maximum resistance, and created with a spiral structure for efficient waste extraction during operation.

Suitable for rock, brick work, concrete, cement, granite, tiles and marble. Fits all hammer drills with SDS-Plus and Hilti TE 10 double-groove shanks. Corresponding to standard: ISO 5468-DIN 8039. Weight 752 g.

SB7-SDS-PLUS

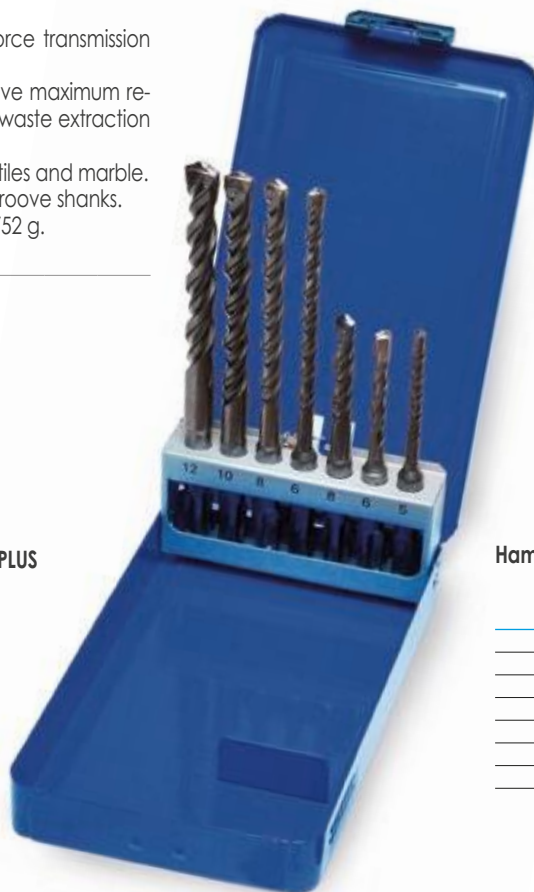

Hammer Drill-bits SB7-SDS-PLUS:

















Ø mm	Length mm	
	Total	Useable
5	110	50
6	110	50
6	160	100
8	110	50
8	160	100
10	160	100
12	160	100

HYDRAULIC TOOLS AND HEADS



SYMBOL DESCRIPTION

hydraulic tools and heads

	Crimping force kN		Provided with a maximum pressure valve that allows to check the correct execution of the compressions or the limit switch control of the blades
	Double speed action: a rapid approach speed and a slower more powerful speed for crimping or cutting		Manual pressure release button
	Openable compression head, ideal for derivations from running conductors		Ergonomically designed with a sculptured body for operator comfort
	Openable cutting head, ideal for cutting running cables		Lightweight and balanced tool for greater control
	Tool with a large 42 mm jaw opening, for easier introduction/removal of large size compression terminations and joints		Dual-compound plastic handles. Greater safety and comfort in handling, thanks to the rubber inserts
	Blades manufactured from high strength special Steel, heat treated to ensure a long service life		Durable moulded body offering high resistance to wear and damage in all operating conditions
	Max cutting diameter		CE marking
	Max hole punching diameter		UKCA marking
	The head can rotate to enable the operator to work in the most comfortable position		
	Can be operated with one hand		

SYMBOL DESCRIPTION

hydraulic tools and heads



Hexagonal crimp



Radial crimp



Indent crimp



Deep indent crimp



Oval crimp



Trapezium crimp



Circular crimp



Max operating pressure



Contains isolated oil



Hydraulic units provide protection against short circuit when accidentally cutting live L.V. / M.V. cables with nominal voltage up to 60 kV



HT45-E

HYDRAULIC CRIMPING TOOL

general features

MAIN APPLICATIONS - max section sqmm

Section sqmm	0,25÷1,5	1,5÷2,5	4÷6	10	16	25	35	50	70	95	120	150	185	240	300	400	500	630	800	1000	
L.V. lugs and splices																					
"C" sleeve Connectors																					

These tools are supplied without dies. For die selection, please refer to chart on pages 368 to 384



Lightweight and compact, this tool is ideal for the compression of connectors for general applications.

Having the benefit of spring loaded handles, the dies can be advanced using only one hand; therefore leaving the other hand free to position the connector.

For ease of operation and comfort of the operator, the tool head can be fully rotated through 180 degrees.

The built-in safety valve will by-pass the oil supply when the maximum pressure is reached, and a pressure releasing system can easily be operated at any stage of the compression.



The operator can advance the dies using only one hand, leaving the other hand free to position the connector.

TECHNICAL FEATURES

Crimping force kN	50
Dimensions mm	
Length	346
Width	130
Weight kg	2,0

STORAGE

Type	VAL-M/L3*
Dimensions mm L x W x H	496 x 296 x 145
Weight kg	2,0
Supplied with the tool	✓

* Suitable for storage of the tool and dies



STORAGE

Type	VAL-75*
Dimensions mm L x W x H	270 x 80 x 30
Weight kg	0,15
Supplied with the tool	✓

* Suitable for storage 5 sets of dies



Openable head, ideal for derivations from running conductors

180° rotatable head, to work in the most comfortable position

Safety valve bypassing the oil supply when the maximum pressure is reached

Pressure releasing system, that can be operated at any stage

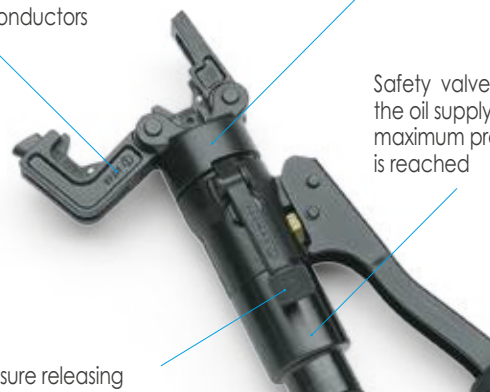

HYDRAULIC CRIMPING TOOL

general features

MAIN APPLICATIONS - max section sqmm

Section sqmm	0.25-1.5	1.5-2.5	4-6	10	16	25	35	50	70	95	120	150	185	200	240	300	400	500	630	800	1000	
L.V. lugs and splices																						
Insulated terminals																						
End sleeves																						
"C" sleeve Connectors																						
H.V. lugs and splices																						

These tools are supplied without dies. For die selection, please refer to chart on pages 368 to 384

STORAGE

Type	VAL-M/L3*
Dimensions mm L x W x H	496 x 296 x 145
Weight kg	2,0
Supplied with the tool	✓

* Suitable for storage of the tool and dies



TECHNICAL FEATURES

Crimping force kN	50
Dimensions mm	
Length	380
Width	130
Weight kg	2,7

New design two speed hydraulic tool, lightweight and compact, this tool is ideal for working in confined spaces.

Having the benefit of spring loaded handles, the dies can be advanced using only one hand; therefore leaving the other hand free to position the connector.

For ease of operation and comfort of the operator, the tool head can be fully rotated through 180 degrees.



STORAGE

Type	VAL-75*
Dimensions mm L x W x H	270 x 80 x 30
Weight kg	0,15
Supplied with the tool	✓

* Suitable for storage 5 sets of dies



The built-in safety valve will by-pass the oil supply when the maximum pressure is reached, and a pressure release system can easily be operated at any stage of the compression.

HT51 COMPRESSION KIT

general features

KIT-HT51-1

Kit includes:

HT51 Hydraulic tool	
VAL-M/L3 plastic carrying case	
VAL-75 plastic case for dies	
8 die sets:	
ME5-50	Hexagonal crimp for low voltage terminals and through connectors from 25 to 240 mm ² A-M family
ME7-50	
ME10-50	
ME14-50	
ME19-50	
ME24-50	
ME30-50	
ME37-50	
ME48-50	

KIT-HT51-MK

Kit includes:

HT51 Hydraulic tool	
VAL-M/L3 plastic carrying case	
VAL-75 plastic case for dies	
9 die sets:	
MK8-50	Hexagonal crimp for low voltage terminals and through connectors from 16 to 185 mm ² DIN 46235 family
MK10-50	
MK12-50	
MK14-50	
MK16-50	
MK18-50	
MK20-50	
MK22-50	
MK25-50	

KIT-HT51-2

Kit includes:

HT51 Hydraulic tool	
VAL-M/L3 plastic carrying case	
VAL-75 plastic case for dies	
6 die sets:	
Nest Indentor	Indent crimp for low voltage general purpose terminals and through connectors from 25 to 120 mm ²
MA5-50 PA5-50	
MA7-50 PA10-50	
MA10-50 PA10-50	
MA14-50 PA19-50	
MA19-50 PA19-50	
MA24-50 PA24-50	

KIT-HT51-1 KIT-HT51-2 KIT-HT51-MK



RH50



Hydraulic presshead complete with quick automatic coupler for connection to a hydraulic pump with a working pressure of 700 bar max. (see page 346-352). RH50 is suitable for installing the same range of connectors as HT51.

HYDRAULIC PRESSHEAD

general features

MAIN APPLICATIONS - max section sqmm

Section sqmm	0,25-1,5	1,5-2,5	4-6	10	16	25	35	50	70	95	120	150	185	200	240	300	400	500	630	800	1000	
L.V. lugs and splices																						
Insulated terminals																						
End sleeves																						
"C" sleeve Connectors																						
H.V. lugs and splices																						

These tools are supplied without dies. For die selection, please refer to chart on pages 368 to 384

TECHNICAL FEATURES

Crimping force kN	50
Max operating pressure bar	700
Dimensions mm	
Length	195
Width	75
Weight kg	1,6

STORAGE

Type	VAL-M2T*
Dimensions mm L x W x H	390 x 310 x 102
Weight kg	1,35
Supplied with the tool	✓

* Suitable for storage of the head and 20 sets of dies



STORAGE

Type	CVB-007
Dimensions mm L x W	350 x 105
Weight kg	0,13
Purchase separately	✓



RHM50



Hydraulic presshead complete with quick automatic coupler for connection to hydraulic pump with working pressure of 700 bar max. (see page 346-352). RHM50 is suitable for installing the same range of connectors as RH50. Particularly suitable for high volume bench crimping.

HYDRAULIC PRESSHEAD

general features

MAIN APPLICATIONS - max section sqmm

Section sqmm	0,25-1,5	1,5-2,5	4-6	10	16	25	35	50	70	95	120	150	185	240	300	400	500	630	800	1000	
L.V. lugs and splices																					
Insulated terminals																					
End sleeves																					

These tools are supplied without dies. For die selection, please refer to chart on pages 368 to 384

TECHNICAL FEATURES

Crimping force kN	50
Max operating pressure bar	700
Dimensions mm	
Length	210
Width	70
Weight kg	1,6

STORAGE

Type	VAL-M2T*
Dimensions mm L x W x H	390 x 310 x 102
Weight kg	1,35
Supplied with the tool	✓

* Suitable for storage of the head and 20 sets of dies



STORAGE

Type	CVB-007
Dimensions mm L x W	350 x 105
Weight kg	0,13
Purchase separately	✓



HYDRAULIC CRIMPING TOOL

HT60C

general features

MAIN APPLICATIONS - max section sqmm

Section sqmm	0,25-1,5	1,5-2,5	4-6	10	16	25	35	50	70	95	120	150	185	240	300	400	500	630	800	1000	
Cu DIN lugs and splices																					
L.V. lugs and splices																					
End sleeves																					

These tools are supplied without dies. For die selection, please refer to chart on pages 368 to 384

STORAGE

Type	CVB-010
Dimensions mm L x W	545 x 160
Weight kg	0,15
Supplied with the tool	✓

TECHNICAL FEATURES

Crimping force kN	60
Dimensions mm	
Length	382
Width	153
Weight kg	3,0



STORAGE

Type	VAL-75*
Dimensions mm L x W x H	270 x 80 x 30
Weight kg	0,15
Purchase separately	✓

*Suitable for storage 5 sets of dies



New design two speed hydraulic tool, lightweight and compact, this tool is ideal for working in confined spaces.

Having the benefit of spring loaded handles, the dies can be advanced using only one hand; therefore leaving the other hand free to position the connector.

For ease of operation and comfort of the operator, the tool head can be fully rotated through 180 degrees. The built-in safety valve will by-pass the oil supply when the maximum pressure is reached, and a pressure release system can easily be operated at any stage of the compression.

HYDRAULIC PRESSHEAD

general features

MAIN APPLICATIONS - max section sqmm

Section sqmm	0,25-1,5	1,5-2,5	4-6	10	16	25	35	50	70	95	120	150	185	240	300	400	500	630	800	1000	
Cu DIN lugs and splices																					
L.V. lugs and splices																					
End sleeves																					

These tools are supplied without dies. For die selection, please refer to chart on pages 368 to 384

TECHNICAL FEATURES

Crimping force kN	60
Max operating pressure bar	700
Dimensions mm	
Length	216
Width	91
Weight kg	1,8

STORAGE

Type	VAL-P26*
Dimensions mm L x W x H	445 x 290 x 115
Weight kg	1,2
Supplied with the tool	✓

*Suitable for storage of the head and 14 sets of dies



Hydraulic presshead complete with quick automatic coupler for connection to a hydraulic pump with a working pressure of 700 bar max. (see page 346-352).

RH60C is suitable for installing the same range of connectors as HT60C.

HT81-UD

HYDRAULIC CRIMPING TOOL

general features

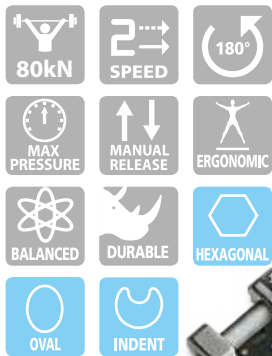

MAIN APPLICATIONS - max section sqmm

Section sqmm	0.25÷1.5	1.5÷2.5	4÷6	10	16	25	35	50	70	95	100	120	150	185	200	240	300	400	500	630	800	1000	
L.V. lugs and splices																							
"C" sleeve Connectors																							
H.V. lugs and splices																							

These tools are supplied without dies. For die selection, please refer to chart on pages 368 to 384

TECHNICAL FEATURES

Crimping force kN	80
Dimensions mm	
Length	485
Width	141
Weight kg	3,4

STORAGE

Type	VAL-M/X2*
Dimensions mm L x W x H	596 x 396 x 185
Weight kg	4,6
Supplied with the tool	✓

* Suitable for storage of the tool and VAL-75



This lightweight and self contained tool, features a patented closure and release mechanism for the die locking pin. A wide range of connectors can be crimped with a small number of die sets due to their unique, double groove styling. Dies for cutting Copper, Aluminum, Aldrey and Aluminum-steel, are also available (see table below). The tool features a double speed action: a fast advancing speed for rapid approach of the dies to the connector and a slower more powerful speed for crimping. For ease of operation and comfort of the operator the tool head can be fully rotated through 180 degrees.

The built-in safety valve will by-pass the oil supply when the maximum pressure is reached, and a pressure releasing system can easily be operated at any stage of the compression.



STORAGE

Type	VAL-75*
Dimensions mm L x W x H	270 x 80 x 30
Weight kg	0,15
Purchase separately	✓

* Suitable for storing five sets of dies



RHU81-D

HYDRAULIC PRESSHEAD

general features



MAIN APPLICATIONS - max section sqmm

Section sqmm	0.25÷1.5	1.5÷2.5	4÷6	10	16	25	35	50	70	95	100	120	150	185	200	240	300	400	500	630	800	1000	
L.V. lugs and splices																							
"C" sleeve Connectors																							
H.V. lugs and splices																							

These tools are supplied without dies. For die selection, please refer to chart on pages 368 to 384

TECHNICAL FEATURES

Crimping force kN	80
Max operating pressure bar	700
Dimensions mm	
Length	235
Width	91
Weight kg	1,9

STORAGE

Type	CVB-007
Dimensions mm L x W	350 x 105
Weight kg	0,13
Supplied with the tool	✓

Hydraulic presshead complete with quick automatic coupler for connection to a hydraulic pump with a working pressure of 700 bar max, (see page 346-352). This lightweight and self contained head, features a patented closure and release mechanism for the die locking pin. The head is easy to use and is ideally suited for crimping in confined spaces. RHU81 is suitable for installing the same range of connectors as HT 81-U.



HT 81-U and RHU 81 ACCESSORIES FOR CUTTING CONDUCTORS

Die Type	Cutting Capacity	Conductor Type	
		Cu, Alu, Aldrey and Alu-Steel	
MB2-80U	Ø 16 mm	This die is suitable to cut steel conductors (R ≤ 160 daN/mm ²) having the most common strandings, i.e.:	
		19 x 1,2 = Ø est. 6,0 mm	7 x 3,0 = Ø est. 9,0 mm
		19 x 2,1 = Ø est. 10,5 mm	19 x 2,3 = Ø est. 11,5 mm
MB3-80U		Suitable to cut aluminium strands of 150 mm ² aluminium-steel conductors, without damage to the steel core.	

HYDRAULIC CRIMPING TOOL

HT120

general features

MAIN APPLICATIONS - max section sqmm

Section sqmm	0.25-1.5	1.5-2.5	4-6	10	16	25	35	50	70	95	120	150	185	200	240	300	400	500	630	800	1000	
L.V. lugs and splices																						
Insulated terminals																						
"C" sleeve Connectors																						
H.V. lugs																						
H.V. Splices*																						

*limited to the cable insulation diameter

These tools are supplied without dies. For die selection, please refer to chart on pages 368 to 384

- 120kN
- SPEED
- 180°
- MAX PRESSURE
- MANUAL RELEASE
- ERGONOMIC
- BALANCED
- DURABLE
- HEXAGONAL
- OVAL
- RADIAL
- INDENT

STORAGE

Type	VAL-M/X2*
Dimensions mm L x W x H	596 x 396 x 185
Weight kg	4,6
Supplied with the tool	✓

*Suitable for storage of the tool and dies

TECHNICAL FEATURES

Crimping force kN	120
Dimensions mm	
Length	490
Width	156
Jaw opening	25
Weight kg	5,7



HT 120-KV
version also available for
Power Supply Companies

This lightweight and self contained tool will accept the semi-circular slotted dies, common to most 130 kN tools.

It is particularly suitable for installing crimp type electrical connectors for overhead line applications.

The tool features a double speed action: a fast advancing speed for rapid approach of the dies to the connector and a slower more powerful speed for crimping.

For ease of operation and comfort of the operator the tool head can be fully rotated through 180 degrees.

The built-in safety valve will by-pass the oil supply when the maximum pressure is reached, and a pressure release system can easily be operated at any stage of the compression.



Die release system, protected from accidental operation



Pressure release trigger, which can be operated at any stage of the compression.



HT131-C

HYDRAULIC CRIMPING TOOL

general features



MAIN APPLICATIONS - max section sqmm

Section sqmm	0.25÷1.5	1.5÷2.5	4-6	10	16	25	35	50	70	95	120	150	185	200	240	300	400	500	630	800	1000	
L.V. lugs and splices																						
Insulated terminals																						
"C" sleeve Connectors																						
H.V. lugs																						
H.V. Splices*																						

*limited to the cable insulation diameter

These tools are supplied without dies. For die selection, please refer to chart on pages 368 to 384

TECHNICAL FEATURES

Crimping force kN	130
Dimensions mm	
Length	473
Width	144
Jaw opening	25
Weight kg	5,5

STORAGE

Type	VAL-M/X2*
Dimensions mm L x W x H	596 x 396 x 185
Weight kg	4,6
Supplied with the tool	✓

*Suitable for storage of the tool and dies



This new model, self contained, robust and sturdy, will accept all semi-circular slotted dies, common to most 130 kN tools.

The tool features a double speed action: a fast advancing speed for rapid approach of the dies to the connector and a slower more powerful speed for crimping.

For ease of operation and comfort of the operator the tool head can be fully rotated through 180 degrees.

The built-in safety valve will by-pass the oil supply when the maximum pressure is reached, and the pressure release system can easily be operated at any stage of compression.

HT131-C COMPRESSION KIT

general features



KIT-HT131-C-1 KIT-HT131-C-2 KIT-HT131-C-MK



KIT-HT131-C-1

Kit includes:

HT131-C Hydraulic tool

VAL-M/X2 plastic carrying case

7 die sets:

ME10-C	Hexagonal crimp for low voltage terminals and through connectors from 50 to 240 mm ² A-M family
ME14-C	
ME19-C	
ME24-C	
ME30-C	
ME37-C	
ME48-C	

KIT-131-C-MK

Kit includes:

HT131-C Hydraulic tool

VAL-M/X2 plastic carrying case

11 die sets:

MK6-C	Hexagonal crimp for low voltage terminals and through connectors from 10 to 240 mm ² DIN 46235 family
MK8-C	
MK10-C	
MK12-C	
MK14-C	
MK16-C	
MK18-C	
MK20-C	
MK22-C	
MK25-C	
MK28-C	

KIT-HT131-C-2

Kit includes:

HT131-C Hydraulic tool

VAL-M/X2 plastic carrying case

11 die sets:

Nest	Indentor	Indent crimp for low voltage general purpose terminals and through connectors from 10 to 240 mm ²
MA2-C		
MA3-C		
MA5-C	PA10-C	
MA7-C		
MA10-C		
MA14-C		
MA19-C	PA24-C	
MA24-C		
MA30-C		
MA37-C	PA48-C	
MA48-C		

RHC131



Hydraulic presshead complete with quick automatic coupler for connection to a hydraulic pump with a working pressure of 700 bar max, (see page 346-352). This new design with improved mechanical features, is suitable for installing the same range of connectors as HT 131-C.

HYDRAULIC PRESSHEAD

general features

MAIN APPLICATIONS - max section sqmm

Section sqmm	0.25÷1.5	1.5÷2.5	4÷6	10	16	25	35	50	70	95	120	150	185	200	240	300	400	500	630	800	1000	
L.V. lugs and splices																						
Insulated terminals																						
"C" sleeve Connectors																						
H.V. lugs																						
H.V. Splices*																						

*limited to the cable insulation diameter

These tools are supplied without dies. For die selection, please refer to chart on pages 368 to 384

TECHNICAL FEATURES

Crimping force kN	130
Max operating pressure bar	700
Dimensions mm	
Length	232
Width	124
Jaw opening	25
Weight kg	3,8

STORAGE

Type	VAL-P26*
Dimensions mm L x W x H	445 x 290 x 115
Weight kg	1,2
Purchase separately	✓

*Suitable for storage of the head and 14 sets of dies



RHM132



Hydraulic presshead complete with quick automatic coupler for connection to a hydraulic pump with a working pressure of 700 bar max, (see page 346-352).

HYDRAULIC PRESSHEAD

general features

MAIN APPLICATIONS - max section sqmm

Section sqmm	0.25÷1.5	1.5÷2.5	4÷6	10	16	25	35	50	70	95	120	150	185	200	240	300	400	500	630	800	1000	
L.V. lugs																						
Insulated terminals																						
H.V. lugs																						

These tools are supplied without dies. For die selection, please refer to chart on pages 368 to 384

Particularly suitable for high volume bench crimping.

TECHNICAL FEATURES

Crimping force kN	130
Max operating pressure bar	700
Dimensions mm	
Length	216
Width	80
Weight kg	3,1

STORAGE

Type	VAL-P26*
Dimensions mm L x W x H	445 x 290 x 115
Weight kg	1,2
Purchase separately	✓

*Suitable for storage of the head and 14 sets of dies



HYDRAULIC CRIMPING TOOL

general features

MAIN APPLICATIONS - max section sqmm

Section sqmm	0.25±1.5	1.5±2.5	4±6	10	16	25	35	50	70	95	120	150	185	200	240	300	400	500	630	800	1000	
L.V. lugs and splices																						
Insulated terminals																						
"C" sleeve Connectors																						
H.V. lugs and splices																						

These tools are supplied without dies. For die selection, please refer to chart on pages 368 to 384

STORAGE

Type	VAL-M/X2*
Dimensions mm L x W x H	596 x 396 x 185
Weight kg	4,6
Supplied with the tool	✓

*Suitable for storage of the tool and dies

TECHNICAL FEATURES

Crimping force kN	130
Dimensions mm	
Length	538
Width	144
Jaw opening	42
Weight kg	7,0

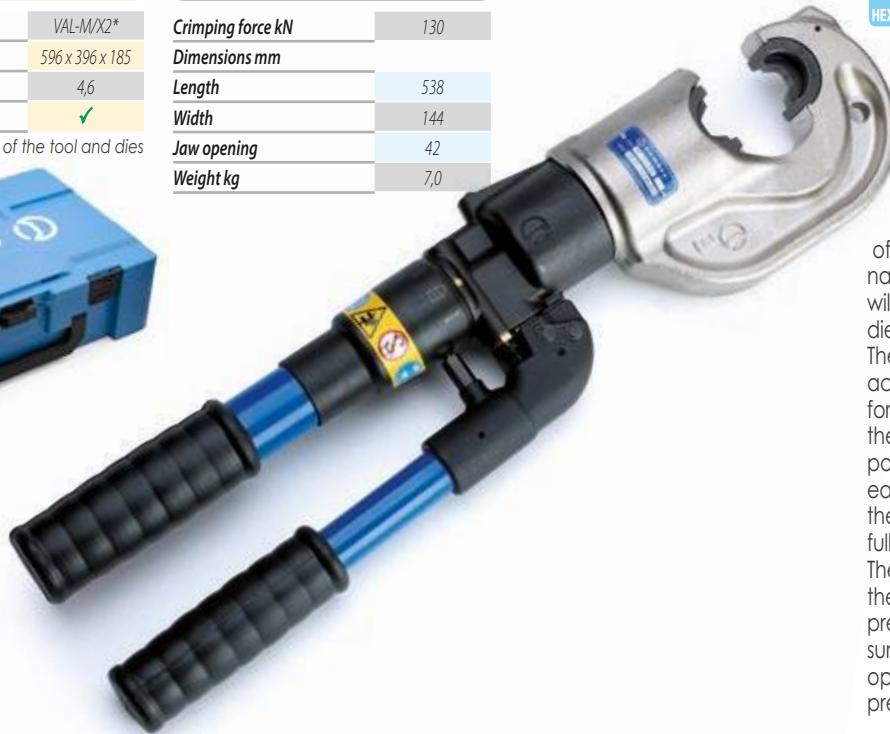

HT131LN-C



Hydraulic "C" head tool with a large 42 mm jaw opening, for easier introduction/removal of large size compression terminations and joints. The HT131LN-C will accept all semi-circular slotted dies, common to most 130 kN tools. The tool features a double speed action: a fast advancing speed for rapid approach of the dies to the connector and a slower more powerful speed for crimping. For ease of operation and comfort of the operator the tool head can be fully rotated through 180 degrees. The built-in safety valve will by-pass the oil supply when the maximum pressure is reached, and the pressure release system can easily be operated at any stage of compression.

HYDRAULIC PRESSHEAD

general features

MAIN APPLICATIONS - max section sqmm

Section sqmm	0.25±1.5	1.5±2.5	4±6	10	16	25	35	50	70	95	120	150	185	200	240	300	400	500	630	800	1000	
L.V. lugs and splices																						
Insulated terminals																						
"C" sleeve Connectors																						
H.V. lugs and splices																						

These tools are supplied without dies. For die selection, please refer to chart on pages 368 to 384

STORAGE

Type	VAL-P26*
Dimensions mm L x W x H	445 x 290 x 115
Weight kg	1,2
Purchase separately	✓

*Suitable for storage of the head and 14 sets of dies

TECHNICAL FEATURES

Crimping force kN	130
Max operating pressure bar	700
Dimensions mm	
Length	298
Width	122
Jaw opening	42
Weight kg	5,4



RHC131LN



Hydraulic head featuring a large 42 mm jaw opening; complete with quick automatic coupler for connection to a hydraulic pump with a working pressure of 700 bar max, (see page 346-352). Is suitable for installing the same range of connectors as HT 131LN-C.

HT131-UC

HYDRAULIC CRIMPING TOOL

general features



MAIN APPLICATIONS - max section sqmm

Section sqmm	0.25÷1.5	1.5÷2.5	4÷6	10	16	25	35	50	70	95	120	150	185	200	240	300	400	500	630	800	1000	
L.V. lugs and splices																						
Insulated terminals																						
"C" sleeve Connectors																						
Alu lugs and splices																						
H.V. lugs and splices																						

These tools are supplied without dies. For die selection, please refer to chart on pages 368 to 384



TECHNICAL FEATURES

Crimping force kN	130
Dimensions mm	
Length	488
Width	149
Weight kg	5,4

STORAGE

Type	VAL-M/X2*
Dimensions mm L x W x H	596 x 396 x 185
Weight kg	4,6
Supplied with the tool	✓

*Suitable for storage of the tool and dies



This robust and self contained tool will accept the accessories for performing the "Deep Stepped Indent" system of crimping on Aluminium cables.

This tool will also accept the semi-circular slotted dies, common to most 130 kN tools.

HT 131-UC performance features are the same as those of HT 131-C.

STORAGE

Type	VAL-130*
Purchase separately	✓

*Suitable for the storage of accessories for crimping Aluminium connectors

RHU131-C

HYDRAULIC PRESSHEAD

general features



MAIN APPLICATIONS - max section sqmm

Section sqmm	0.25÷1.5	1.5÷2.5	4÷6	10	16	25	35	50	70	95	120	150	185	200	240	300	400	500	630	800	1000	
L.V. lugs and splices																						
Insulated terminals																						
"C" sleeve Connectors																						
Alu lugs and splices																						
H.V. lugs and splices																						

These tools are supplied without dies. For die selection, please refer to chart on pages 368 to 384



TECHNICAL FEATURES

Crimping force kN	130
Max operating pressure bar	700
Dimensions mm	
Length	245
Width	89
Weight kg	3,7

STORAGE

Type	VAL-P26*
Dimensions mm L x W x H	445 x 290 x 115
Weight kg	1,2
Purchase separately	✓

*Suitable for storage of the head and 14 sets of dies

Hydraulic presshead complete with quick automatic coupler for connection to a hydraulic pump with a working pressure of 700 bar max, (see page 346-352).

RHU131-C is suitable for installing the same range of connectors as HT 131-UC.

STORAGE

Type	VAL-130*
Dimensions mm L x W x H	360 x 280 x 48
Weight kg	3,0
Purchase separately	✓

*Suitable for the storage of accessories for crimping Aluminium connectors

STORAGE

Type	VAL-130-U*
Dimensions mm L x W x H	450 x 305 x 80
Weight kg	5,0
Purchase separately	✓

*Suitable for storage of the head, semi-circular slotted dies and dies for crimping Aluminium connectors



HYDRAULIC PRESSHEAD

general features

MAIN APPLICATIONS - max section sqmm

Section sqmm	0,25+-1,5	1,5+-2,5	4+-6	10	16	25	35	50	70	95	120	150	185	200	240	300	400	500	630	800	1000	
L.V. lugs and splices																						
Insulated terminals																						
"C" sleeve Connectors																						
H.V. lugs and splices																						

These tools are supplied without dies. For die selection, please refer to chart on pages 368 to 384

STORAGE

Type	VAL-ECW-H3D*
Dimensions mm L x W x H	345 x 205 x 90
Weight kg	4,2
Purchase separately	✓

* Suitable for storage of the head and 10 sets of dies



TECHNICAL FEATURES

Crimping force kN	230
Max operating pressure bar	700
Dimensions mm	
Length	290
Width	120
Weight kg	5,5

Hydraulic presshead complete with quick automatic coupler for connection to a hydraulic pump with a working pressure of 700 bar max, (see page 346-352).



Adaptor type AU230-130D is available as an optional extra enabling the head to utilise the semi-circular slotted dies which are common to most 130 kN tools. Also available is a series of dies for the compression of DIN electrical connectors.

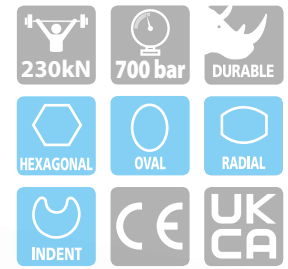

HYDRAULIC PRESSHEAD

general features

MAIN APPLICATIONS - max section sqmm

Section sqmm	0,25+-1,5	1,5+-2,5	4+-6	10	16	25	35	50	70	95	120	150	185	200	240	300	400	500	630	800	1000	
Alu lugs and splices																						
Cu lugs and splices																						

These tools are supplied without dies. For die selection, please refer to chart on pages 368 to 384

STORAGE

Type	VAL-231*
Dimensions mm L x W x H	470 x 273 x 96
Weight kg	7,2
Supplied with the tool	✓
Purchase separately	-

* Suitable for storage of the head and dies for Aluminium compression



TECHNICAL FEATURES

Crimping force kN	230
Max operating pressure bar	700
Dimensions mm	
Length	320
Width	110
Weight kg	6,4



RHU231

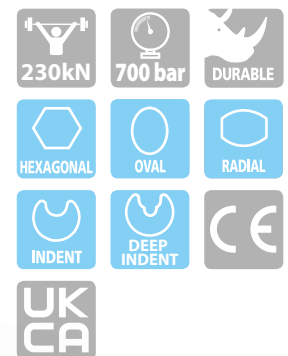

Hydraulic presshead complete with quick automatic coupler for connection to a hydraulic pump with a working pressure of 700 bar max, (see page 346-352).

For crimping up to 500 sqmm Aluminium.

Dies are available also for crimping Copper connectors.

RHU230-630

HYDRAULIC PRESSHEAD

general features

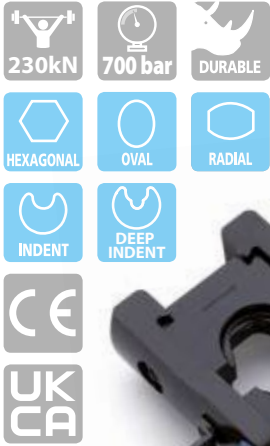

MAIN APPLICATIONS - max section sqmm

Section sqmm	0.25÷1.5	1.5÷2.5	4÷6	10	16	25	35	50	70	95	120	150	185	200	240	300	400	500	630	800	1000	
L.V. lugs and splices																						
Alu lugs and splices																						
"C" sleeve Connectors																						
H.V. lugs and splices																						

These tools are supplied without dies. For die selection, please refer to chart on pages 368 to 384



TECHNICAL FEATURES

Crimping force kN	230
Max operating pressure bar	700
Dimensions mm	
Length	365
Width	193
Weight kg	9,0

STORAGE

Type	VAL-230-630*
Dimensions mm L x W x H	405 x 230 x 145
Weight kg	3,5
Supplied with the tool	✓

*Suitable for storage of the head

STORAGE

Type	VALMAT-230-630*
Dimensions mm L x W x H	290 x 260 x 70
Weight kg	3,1
Purchase separately	✓

*Suitable for storage of the accessories

Hydraulic presshead complete with quick automatic coupler for connection to a hydraulic pump with a working pressure of 700 bar max, (see page 346-352). It allows for crimping up to 630 sqmm Aluminium (according to HN 68 S90). Adapters AU 230-130-C/N, and AU 230-PS/E, are available as an optional extra enabling the head to utilise the semicircular slotted dies which are common to most 130 kN tools.



VAL-230-630

VALMAT-230-630

RHU450

HYDRAULIC PRESSHEAD

general features



MAIN APPLICATIONS - Hexagonal crimp according to DIN 48083 max section sqmm

Section sqmm	0.25÷1.5	1.5÷2.5	4÷6	10	16	25	35	50	70	95	120	150	185	200	240	300	400	500	680	800	1000	1200	
Cu																							
Al																							
Al/St																							

These tools are supplied without dies.

TECHNICAL FEATURES

Crimping force kN	450
Max operating pressure bar	700
Dimensions mm	
Length	260
Width	120
Weight kg	10,3

STORAGE

Type	VAL-450*
Dimensions mm L x W x H	285 x 212 x 124
Weight kg	2,8
Supplied with the tool	✓

* Suitable for storage of the head

Hydraulic presshead complete with quick automatic coupler for connection to a hydraulic pump with a working pressure of 700 bar max, (see page 346-352). Adaptor type AU 450-130 D is available as an optional extra enabling the head to utilise the semi-circular slotted dies which are common to most 130 kN tools.



HYDRAULIC PRESSHEAD

RHU520

general features

MAIN APPLICATIONS - max section sqmm

Section sqmm	0,25÷1,5	1,5÷2,5	4÷6	10	16	25	35	50	70	95	120	150	185	200	240	300	400	500	630	800	1000	1200	
Lugs and splices																							
H.V. overhead lines																							

These tools are supplied without dies. For die selection, please refer to chart on pages 368 to 384

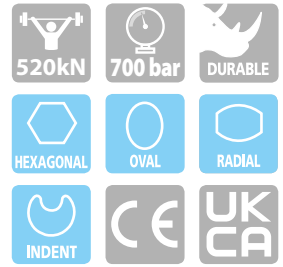

STORAGE

Type	VAL-520*
Dimensions mm L x W x H	384 x 231 x 145
Weight kg	3,2
Purchase separately	✓

*Suitable for storage of the head

TECHNICAL FEATURES

Crimping force kN	520
Max operating pressure bar	700
Dimensions mm	
Length	306
Width	200
Weight kg	18,0

STORAGE

Type	VALMAT-520*
Dimensions mm L x W x H	500 x 310 x 68
Weight kg	5,1
Purchase separately	✓

*Suitable for storage of 10 sets of dies



Hydraulic presshead complete with quick automatic coupler for connection to a hydraulic pump with a working pressure of 700 bar max. (see page 346-352). Adaptor type AU520-130C is available as an optional extra enabling the head to utilise the semi-circular slotted dies which are common to most 130 kN tools.

RHU600

HYDRAULIC PRESSEHEAD

general features



MAIN APPLICATIONS

- "U" Alcoa series die and "L" Burndy series die, etc.
- Aluminium and Copper max size 2156 MCM

These tools are supplied without dies. For die selection, please refer to chart on pages 368 to 384

Hydraulic presshead complete with quick automatic coupler for connection to a hydraulic pump with a working pressure of 700 bar max, (see page 346-352).

TECHNICAL FEATURES

<i>Crimping force kN</i>	600
<i>Max operating pressure bar</i>	700
<i>Dimensions with support mm</i>	
<i>Length</i>	447
<i>Width</i>	241
<i>Weight with support</i>	22,4

STORAGE

<i>Type</i>	VAL-600*
<i>Dimensions mm L x W x H</i>	480 x 235 x 260
<i>Weight kg</i>	8,6
<i>Supplied with the tool</i>	✓

*Suitable for storage of the head



VAL-600

HYDRAULIC PRESSHEAD

RHU1000

general features

These tools are supplied without dies. For die selection, please refer to chart on pages 368 to 384

STORAGE

Type	VAL-1000*
Dimensions mm L x W x H	334x244x435
Weight kg	12
Supplied with the tool	✓

*Suitable for storage of the head

TECHNICAL FEATURES

Crimping force kN	1.100
Max operating pressure bar	700
Dimensions mm	
Length	414
Width	278
Weight kg	50,6

Operable from single or double acting hydraulic power source



VAL-1000



Lifting eye; screwed into the base of the cylinder, allows easy transportation of the head in aerial operation.



RHU 1000 is a 1.100 kN hydraulic presshead for full tension, transmission and substation connections, complete with quick automatic coupler for connection to hydraulic pumps with a working pressure of 700 bar max, (see page 346-352).

The standard version must be operated by a single acting pump; possibility to convert from single to double acting by substitution of the breather valve with a female quick coupling.

RHU1000 will accept all semi-circular slotted dies common to most 100 ton heads as the Alcoa ones.

The die cap is removable for an easy connector positioning; the upper part of the cap automatically rotates during the die changing process to present the correct positioning of the die. Lifting eye included.

Insertion of the upper die:



After substitution of the dies, insert the die cap into the head.



Pull the pin.



The upper part of the cap automatically rotates...



...to the correct position.

HT-TC051

HYDRAULIC CUTTING TOOL

industrial application

MAIN APPLICATIONS

specifically designed to cut Copper, Aluminium and Telecommunications cable having Ø max 50 mm



TECHNICAL FEATURES

Max cutting Ø mm	50
Dimensions mm	
Length	497
Width	129
Weight kg	4,38

STORAGE

Type	CVB-010
Dimensions mm L x W	545 x 160
Weight kg	0,15
Supplied with the tool	✓



Hand operated hydraulic tool specifically designed to cut Copper, Aluminium and Telecommunications cable having a max overall diameter of 50 mm.

The tool features a double speed action: a fast advancing speed for rapid approach of the blades to the cable and a slower more powerful speed for cutting.

The blades are manufactured from high strength special Steel, heat treated to ensure a long service life. The head can be easily opened to allow the cutting of running cables.

The head can rotate through 90 degrees, to enable the operator to work in the most comfortable position.

HT-TC051 features an automatic safety valve to bypass oil when reaching maximum pressure; a pressure release device can also be operated at any stage of operation.

TC050

HYDRAULIC CUTTING HEAD

industrial application

MAIN APPLICATIONS

specifically designed to cut Copper, Aluminium and Telecommunications cable having Ø max 50 mm



TECHNICAL FEATURES

Max cutting Ø mm	50
Max operating pressure bar	700
Dimensions mm	
Length	325
Width	112
Weight kg	3,2

STORAGE

Type	CVB-011
Dimensions mm L x W	360 x 137
Weight kg	0,13
Supplied with the tool	✓



Hydraulic cutting head complete with quick automatic coupler for connection to a hydraulic pump with a working pressure of 700 bar max, (see page 346-352)

TC050 features the same cutting capability as HT-TC051.

HYDRAULIC CUTTING TOOL

industrial application

MAIN APPLICATIONS

specifically designed to cut Copper, Aluminium and Telecommunications cable having Ø max 65 mm

STORAGE

Type	CVB-010
Dimensions mm L x W	545 x 160
Weight kg	0,15
Supplied with the tool	✓

TECHNICAL FEATURES

Max cutting Ø mm	65
Dimensions mm	
Length	523
Width	129
Weight kg	5



HT-TC065



Hand operated hydraulic tool specifically designed to cut Copper, Aluminium and Telecommunications cable having a max overall diameter of 65 mm. The tool features a double speed action.

The blades are manufactured from high strength special Steel, heat treated to ensure a long service life. The head can be easily opened to allow the cutting of running cables.

The head can rotate through 320 degrees, to enable the operator to work in the most comfortable position.

HT-TC065 features an automatic safety valve to bypass oil when reaching maximum pressure; a pressure release device can also be operated at any stage of operation.

HYDRAULIC CUTTING HEAD

industrial application

MAIN APPLICATIONS

specifically designed to cut Copper, Aluminium and Telecommunications cable having Ø max 65 mm

STORAGE

Type	VAL-TC065-SC*
Dimensions mm L x W x H	459 x 231 x 122
Weight kg	3,6
Supplied with the tool	✓

*Suitable for storage of the head

TECHNICAL FEATURES

Max cutting Ø mm	65
Max operating pressure bar	700
Dimensions mm	
Length	426
Width	185
Weight kg	6,3



TC065-SC



Hydraulic cutting head complete with quick automatic coupler for connection to a hydraulic pump with a working pressure of 700 bar max, (see page 346-352)

TC065-SC features the same cutting capability as HT-TC065. The open head and the "scissor" movement of the blades facilitate the cutting of running cables.

HT-TC0851

HYDRAULIC CUTTING TOOL

industrial application

MAIN APPLICATIONS

specifically designed to cut Copper, Aluminium and Telecommunications cable having Ø max 85 mm

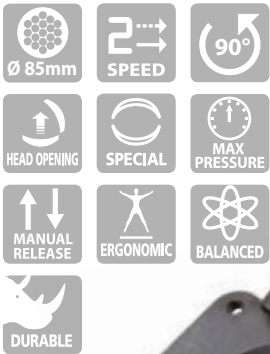

TECHNICAL FEATURES

Max cutting Ø mm	85
Dimensions mm	
Length	652,5
Width	175
Weight kg	6,6

STORAGE

Type	CVB-029/1
Dimensions mm L x W x H	780 x 200
Weight kg	0,426
Supplied with the tool	✓



Hand operated hydraulic tool specifically designed to cut Copper, Aluminium and Telecommunications cable having a max overall diameter of 85 mm.

New model, self contained, robust and sturdy.

The tool features a double speed action: a fast advancing speed for rapid approach of the blades to the cable and a slower more powerful speed for cutting.

The blades are manufactured from high strength special Steel, heat treated to ensure a long service life.

The head can easily be opened to allow the cutting of running cables, and can rotate through 180 degrees, to enable the operator to work in the most comfortable position.

HT-TC0851 features an automatic safety valve to bypass oil when reaching maximum pressure; a pressure release device can also be operated at any stage of operation.

TC085

HYDRAULIC CUTTING HEAD

industrial application

MAIN APPLICATIONS

specifically designed to cut Copper, Aluminium and Telecommunications cable having Ø max 85 mm



TECHNICAL FEATURES

Max cutting Ø mm	85
Max operating pressure bar	700
Dimensions mm	
Length	409
Width	135
Weight kg	4,9

STORAGE

Type	VAL-TC085
Dimensions mm L x W x H	465 x 155 x 65
Weight kg	2,4
Supplied with the tool	✓



Hydraulic cutting head complete with quick automatic coupler for connection to a hydraulic pump with a working pressure of 700 bar max, (see page 346-352)

TC085 features the same cutting capability as HT-TC0851.

HYDRAULIC CUTTING HEAD

industrial application

MAIN APPLICATIONS

specifically designed to cut Copper and Aluminium cable having Ø max 95 mm

STORAGE

Type	VAL-096
Dimensions mm L x W x H	450 x 265 x 145
Weight kg	6,8
Supplied with the tool	✓

TECHNICAL FEATURES

Max cutting Ø mm	95
Max operating pressure bar	700
Dimensions mm	
Length	397
Width	249
Weight kg	7,9



Hydraulic cutting head specifically designed to cut Copper and Aluminium cable having a max overall diameter of 95 mm.

The head is complete with a quick automatic coupler for connection to a hydraulic pump with a working pressure of 700 bar max, (see page 346-352).



HYDRAULIC CUTTING HEAD

industrial application

MAIN APPLICATIONS

specifically designed to cut Copper, Aluminium and Telecommunications cable having Ø max 120 mm

STORAGE

Type	VAL-TC120
Dimensions mm L x W x H	590 x 209 x 84
Weight kg	4,9
Supplied with the tool	✓

TECHNICAL FEATURES

Max cutting Ø mm	120
Max operating pressure bar	700
Dimensions mm	
Length	536
Width	175
Weight kg	9,5



Hydraulic cutting head specifically designed to cut Copper, Aluminium and Telecommunications cable having a max overall diameter of 120 mm.

The head can easily be opened to cut running cables, and the handle allows the most comfortable positioning of the head onto the cable to be cut.

The head is complete with a quick automatic coupler for connection to a hydraulic pump with a working pressure of 700 bar max, (see page 346-352).



TC 120 cutting capacity - a few examples:

Section	Conductor Type
3x150 mm ²	Steel armoured Ø80 mm
1000 mm ²	Cu - EPR rubber insulated; Ø85 mm
1000 mm ²	Cu - EPR rubber insulated + lead sheath; Ø92 mm
1000 mm ²	Cu - EPR rubber insulated + lead sheath + PE sheath; Ø100 mm
240 mm ²	EPR rubber insulated

HT-TC026

HYDRAULIC CUTTING TOOL

overhead line application

MAIN APPLICATIONS

specifically designed to cut Copper, aldrej, Aluminium, Aluminium-Steel cables and Steel ropes, Aluminium and Steel rods having Ø max 25 mm



Hand operated hydraulic tool specifically designed to cut Copper, aldrej, Aluminium, Aluminium-Steel cables and Steel ropes, Aluminium and Steel rods having a max overall diameter of 25 mm.

The tool features a double speed action: a fast advancing speed for rapid approach of the blades to the cable and a slower more powerful speed for cutting.

The blades are manufactured from high strength special Steel, heat treated to ensure a long service life. The head can rotate through 180 degrees, to enable the operator to work in the most comfortable position, and can easily be opened to allow the cutting of running cables.

HT-TC026 features an automatic safety valve to bypass oil when reaching maximum pressure; a pressure release device can also be operated at any stage of operation.

TECHNICAL FEATURES

Max cutting Ø mm	25
Dimensions mm	
Length	382
Width	129
Weight kg	3,2

STORAGE

Type	CVB-001
Dimensions mm L x W	430 x 155
Weight kg	0,15
Supplied with the tool	✓



CUTTING CAPACITY

MATERIAL	TENSILE STRENGTH (daN/mm ²)	MAX CUTTING DIAMETER (mm)	
		HT-TC026 TC 025	HT-TC026Y B-TC250
COPPER	≤ 41	25	
ALUMINIUM	≤ 20	25	
ALMELEC	≤ 34	25	
ROPE & CONDUCTORS	STEEL	INDICATIVE EXAMPLES: 7 x 3,0 : Ø est. = 9,0 mm 19 x 2,1 : Ø est. = 10,5 mm 19 x 2,3 : Ø est. = 11,5 mm	
	MULTI STRANDS STEEL (STRANDS Qty ≥ 200)	18	
RODS	ACSR	25 INDICATIVE EXAMPLES: 26 x 2,50 + 7 x 1,95 : Ø est. = 15,85 26 x 3,06 + 7 x 2,38 : Ø est. = 19,38 26 x 3,60 + 7 x 2,80 : Ø est. = 22,80	
	STEEL	≤ 60	13
		≤ 42	16
	COPPER	≤ 30	20
	≤ 25	23	
ALUMINIUM	≤ 16	25	

TC025

HYDRAULIC CUTTING HEAD

overhead line application

MAIN APPLICATIONS

specifically designed to cut Copper, aldrej, Aluminium, Aluminium-Steel cables and Steel ropes, Aluminium and Steel rods having Ø max 25 mm



Hydraulic cutting head complete with quick automatic coupler for connection to a hydraulic pump with a working pressure of 700 bar max, (see page 346-352) TC025 has the same cutting capability as HT-TC026.

TECHNICAL FEATURES

Max cutting Ø mm	25
Max operating pressure bar	700
Dimensions mm	
Length	213
Width	82
Weight kg	2,0

STORAGE

Type	CVB-007
Dimensions mm L x W	350 x 105
Weight kg	0,13
Supplied with the tool	✓



HYDRAULIC CUTTING TOOL

HT-TC026Y

overhead line application

MAIN APPLICATIONS

specifically designed to cut Copper, aldrej, Aluminum, Aluminum-Steel cables, stay wire and Steel ropes having Ø max 25 mm and Steel earthing rod up to 16 mm.

STORAGE

Type	CVB-001
Dimensions mm L x W	430 x 155
Weight kg	0,15
Supplied with the tool	✓

TECHNICAL FEATURES

Max cutting Ø mm	25
Dimensions mm	
Length	394,5
Width	129
Weight kg	3,35



Hand operated hydraulic tool specifically designed to cut Copper, aldrej, Aluminum, Aluminum-Steel cables, stay wire and Steel ropes having a max overall diameter of 25 mm and Steel earthing rod up to 16 mm. The tool features a double speed action.

The blades are manufactured from high strength special Steel, heat treated to ensure a long service life.

The head can rotate through 180 degrees, to enable the operator to work in the most comfortable position, and can easily be opened to allow the cutting of running cables. HT-TC026Y features an automatic safety valve to bypass oil when reaching maximum pressure; a pressure release device can also be operated at any stage of operation.

Ideal for earthing rod and stay wire

HT-TC026Y cutting capacity - a few examples:

Ø		EARTHING RODS AND STAY WIRES
mm	in.	
14,2	/	STEEL EARTHING ROD, COPPER PLATED; Tensile strength = 79 daN/mm ²
12,7	1/2"	STEEL EARTHING ROD, COPPER PLATED; Tensile strength = 69 daN/mm ²
15,6	/	STEEL EARTHING ROD; Tensile strength = 69 daN/mm ²
15,9	5/8"	STEEL EARTHING ROD, COPPER PLATED (CON ED - ILLINOIS); Tensile strength = 57 daN/mm ²
15,9	5/8"	STEEL EARTHING ROD, COPPER PLATED (CON ED - STATEN ISLAND); Tensile strength = 78 daN/mm ²
19	3/4"	STEEL EARTHING ROD, COPPER PLATED; Tensile strength = 74 daN/mm ²
9,15 (3,05x7)	/	STAY WIRE
10,8 (3,6x7)	/	STAY WIRE (PORTLAND GENERAL ELECTRIC)
11,1 (3,7x7)	/	STAY WIRE (PORTLAND GENERAL ELECTRIC)
12,3 (4,1x7)	/	STAY WIRE (PORTLAND GENERAL ELECTRIC)
12,6 (4,2x7)	/	STAY WIRE (PORTLAND GENERAL ELECTRIC)

HT-TC041N

HYDRAULIC CUTTING TOOL

overhead line application



MAIN APPLICATIONS

specifically designed to cut Copper, aldrej, Aluminium, Aluminium-Steel cables and Steel ropes, Aluminium and Steel rods having Ø max 45 mm

TECHNICAL FEATURES

Max cutting Ø mm	45
Dimensions mm	
Length	550
Width	144
Weight kg	5,8

STORAGE

Type	CVB-010
Dimensions mm L x W x H	545 x 160
Weight kg	0,286
Supplied with the tool	✓



Hand operated hydraulic tool specifically designed to cut Copper, aldrej, Aluminium, Aluminium-Steel cables and Steel ropes, Aluminium and Steel rods having a max overall diameter of 45 mm.

New model, even more self contained, robust and sturdy. The blades are manufactured from high strength special Steel, heat treated to ensure a long service life. The head can rotate through 180 degrees, to enable the operator to work in the most comfortable position, and can easily be operated at any stage of operation.

HT-TC041N features an automatic safety valve to bypass oil when reaching maximum pressure; a pressure release device can also be operated at any stage of operation.

CUTTING CAPACITY

MATERIAL	TENSILE STRENGTH (daN/mm ²)	MAX CUTTING DIAMETER (mm)	
		HT-TC041N	TC04N B-TC450
ROPE & CONDUCTORS	COPPER	≤ 41	45
	ALUMINIUM	≤ 20	45
	ALMELEC	≤ 34	45
	STEEL	≤ 180	INDICATIVE EXAMPLES: 7 x 3,0 : Ø est. = 9,0 mm 19 x 2,1 : Ø est. = 10,5 mm 19 x 2,3 : Ø est. = 11,5 mm
	MULTI STRANDS STEEL (STRANDS Qty ≥ 200)	≤ 180	18
	ACSR	≤ 180	45 INDICATIVE EXAMPLES: 26 x 2,50 + 7 x 1,95 : Ø est. = 15,85 26 x 3,06 + 7 x 2,38 : Ø est. = 19,38 26 x 3,60 + 7 x 2,80 : Ø est. = 22,80 54 x 3,50 + 19 x 2,10 : Ø est. = 31,50 54 x 4,36 + 19 x 2,62 : Ø est. = 39,20
RODS	STEEL	≤ 60	18
		≤ 42	20
	COPPER	≤ 30	30
		≤ 25	32
ALUMINIUM	≤ 16	45	

TC04N

HYDRAULIC CUTTING HEAD

overhead line application



MAIN APPLICATIONS

specifically designed to cut Copper, aldrej, Aluminium, Aluminium-Steel cables and Steel ropes, Aluminium and Steel rods having Ø max 45 mm

TECHNICAL FEATURES

Max cutting Ø mm	45
Max operating pressure bar	700
Dimensions mm	
Length	311
Width	100
Weight kg	4,0

STORAGE

Type	VAL-04
Dimensions mm L x W x H	350 x 125 x 68
Weight kg	2,0
Supplied with the tool	✓



Hydraulic cutting head complete with quick automatic coupler for connection to a hydraulic pump with a working pressure of 700 bar max, (see page 346-352) TC04N has the same cutting capability as HT-TC041N.



HYDRAULIC CUTTING TOOL

overhead line application

MAIN APPLICATIONS

specifically designed to cut Copper, Aluminum, Aluminum-Steel cables (ACSR) having Ø max 50 mm
Not suitable for cutting stay wire, Steel rope or earthing rod

STORAGE

Type	CVB-010
Dimensions mm L x W	545 x 160
Weight kg	0,15
Supplied with the tool	✓

TECHNICAL FEATURES

Max cutting Ø mm	50
Dimensions mm	
Length	503
Width	129
Weight kg	4,7



Hand operated hydraulic tool specifically designed to cut Copper, Aluminum, Aluminum-Steel cables (ACSR) having a max overall diameter of 50 mm. The HT-TC051Y is provided with a two stage hydraulic system, which advances the blades quickly to the cable. This proven system saves operator time and effort.

HT-TC051Y

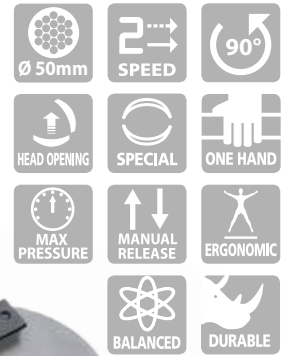

The HT-TC051Y is provided with an automatic safety valve to bypass oil when reaching max pressure. This means safety to the operator and protection to the blades. The blades are manufactured from high strength special Steel, heat treated to ensure a long service life. The shape of the blades provides a "clean" cut. The head can be opened to allow cutting of running cables and ropes. The head rotates 90 degrees allowing the operator to perform the cut in the most comfortable position. The tool is supplied complete with canvas bag 010 for protection and storage when not in use.

HYDRAULIC CUTTING HEAD

overhead line application

MAIN APPLICATIONS

specifically designed to cut Copper, Aluminum, Aluminum-Steel cables (ACSR) having Ø max 50 mm
Not suitable for cutting stay wire, Steel rope or earthing rod

STORAGE

Type	CVB-011
Dimensions mm L x W x H	360 x 137
Weight kg	0,13
Supplied with the tool	✓

TECHNICAL FEATURES

Max cutting Ø mm	50
Max operating pressure bar	700
Dimensions mm	
Length	331
Width	112
Weight kg	3,3



Hydraulic cutting head complete with quick automatic coupler for connection to a hydraulic pump with a working pressure of 700 bar max. (see page 346-352). TC050Y features the same cutting capability as HT-TC051Y.

HT-TC055

HYDRAULIC CUTTING TOOL

overhead line application

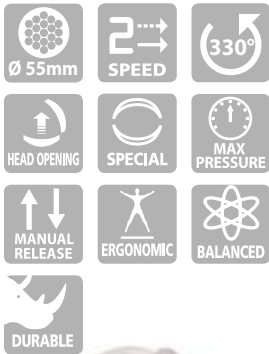

MAIN APPLICATIONS

specifically designed to cut Copper, aldrej, Aluminium, Aluminium-Steel cables and Steel ropes, Aluminium and Steel rods having Ø max 55 mm

TECHNICAL FEATURES

Max cutting Ø mm	55
Dimensions mm	
Length	595
Width	144
Weight kg	8,3

STORAGE

Type	CVB-029/1
Dimensions mm L x W x H	780 x 200
Weight kg	0,426
Supplied with the tool	✓



Hand operated hydraulic tool specifically designed to cut Copper, aldrej, Aluminium, Aluminium-Steel cables and Steel ropes, Aluminium and Steel rods having a max overall diameter of 55 mm.

The HT-TC055 is provided with a two stage hydraulic system, which advances the blades quickly to the cable. This proven system saves operator time and effort.

The HT-TC055 is provided with an automatic safety valve to bypass oil when reaching max pressure. This means safety to the operator and protection to the blades.

The blades are manufactured from high strength special Steel, heat treated to ensure a long service life.

The shape of the blades provides a "clean" cut. The head can be opened to allow cutting of running cables and ropes. The head rotates 330 degrees allowing the operator to perform the cut in the most comfortable position.

CUTTING CAPACITY

MATERIAL	TENSILE STRENGTH (daN/mm ²)	MAX CUTTING DIAMETER (mm)	
		HT-TC055	TC055 B-TC550
COPPER	≤ 41	55	
ALUMINIUM	≤ 20	55	
ALMELEC	≤ 34	55	
STEEL	≤ 180	INDICATIVE EXAMPLES: 7 x 3,0 : Ø est. = 9,0 mm 19 x 2,1 : Ø est. = 10,5 mm 19 x 2,3 : Ø est. = 11,5 mm	
MULTI STRANDS STEEL (STRANDS Qty ≥ 200)	≤ 180	22	
ACSR	≤ 180	50 INDICATIVE EXAMPLES: 26 x 2,50 + 7 x 1,95 : Ø est. = 15,85 26 x 3,06 + 7 x 2,38 : Ø est. = 19,38 26 x 3,60 + 7 x 2,80 : Ø est. = 22,80 26 x 4,44 + 7 x 3,45 : Ø est. = 28,14 54 x 3,50 + 19 x 2,10 : Ø est. = 31,50 54 x 4,36 + 19 x 2,62 : Ø est. = 39,20 83 x 4,60 + 16 x 2,80 : Ø est. = 50,00	
GUY WIRE (GW15-9/16-188)	Extra high strenght grade	7 x 4,77 : Ø est. = 14,30 mm	
RODS	STEEL	≤ 60	20
		≤ 42	22
	COPPER	≤ 30	34
		≤ 25	38,5
	ALUMINIUM	≤ 16	50

TC055

HYDRAULIC CUTTING HEAD

overhead line application



MAIN APPLICATIONS

specifically designed to cut Copper, aldrej, Aluminium, Aluminium-Steel cables and Steel ropes, Aluminium and Steel rods having Ø max 55 mm

TECHNICAL FEATURES

Max cutting Ø mm	55
Max operating pressure bar	700
Dimensions mm	
Length	357
Width	134
Weight kg	6,6

STORAGE

Type	VAL-TC055
Dimensions mm L x W x H	384 x 231 x 145
Weight kg	3,7
Supplied with the tool	✓



Hydraulic cutting head complete with quick automatic coupler for connection to a hydraulic pump with a working pressure of 700 bar max, (see page 346-352)

TC055 has the same cutting capability as HT-TC055.



PIERCING HEADS

general features

RHT160

Max piercing Ø mm	21
Max hole distance from bar edge (mm)	30
Max operating pressure bar	700
Dimensions mm	
Length	240
Width	153
Weight kg	6,5

RHT160-60N

Max piercing Ø mm	21
Max hole distance from bar edge (mm)	60
Max operating pressure bar	700
Dimensions mm	
Length	240
Width	181
Weight kg	9,2

STORAGE

Type	VAL-160*
Dimensions mm L x W x H	283 x 180 x 100
Weight kg	2,3
Supplied with the tool	✓

*Suitable for storage of the head



RHT160 RHT160-60N



Hydraulic head complete with automatic quick coupler, for piercing holes of various diameters in Copper, Aluminium and Steel bars with max. thickness of 10 mm. This compact and handy tool is widely used for transformer room connections, control switch boards and power plants. For operation the head must be joined to a hydraulic pump developing a pressure of 700 bar (see page 346-352).

Available accessories (to be ordered separately):

Piercing Ø mm	6,5	8,5	9	10,5	11	13	13,5	14	15	17	19	21
Type (Kit Punch+Die)	RT6.5	RT8.5	RT9	RT10.5	RT11	RT13	RT13.5	RT14	RT15	RT17	RT19	RT21

Max. thickness

Hole diameter (mm)	6,5	8,5	9	10,5	11	13	13,5	14	15	17	19	21
Max thickness strep in Copper	10	10	10	10	10	10	10	10	10	10	8	8
Max thickness strep in Steel	10	10	10	10	10	9	9	9	8	7	6	4
Punch die/set	RT6.5	RT8.5	RT9	RT10.5	RT11	RT13	RT13.5	RT14	RT15	RT17	RT19	RT21

HT-FL75

PULLER-TYPE HOLE PUNCHING TOOLS

general features

MAIN APPLICATIONS

specifically designed for hole punching stainless Steel, mild Steel, fibreglass and plastic sheet materials up to 3,5 mm thickness



Hand operated hydraulic tool specifically designed for hole punching stainless Steel, mild Steel, fibreglass and plastic sheet materials up to 3,5 mm thickness. Compact, lightweight and easy to handle. The balanced punching head pivots 180deg through a full 360deg rotation for ease of use in confined spaces.

The tool is supplied complete with plastic case VAL P28 for protection and storage when not in use.

Supplied with Pullers TD-11, TD-19 and spiral bit Ø 11,5 mm.

For the punch-die selection chart see page 305.



TECHNICAL FEATURES

Max Punching Ø mm	140
Dimensions mm	
Length	452
Width	138
Weight kg	3,67

STORAGE

Type	VAL-M/L3*
Dimensions mm L x W x H	496 x 296 x 145
Weight kg	2,0
Supplied with the tool	✓

*Adatta a contenere l'utensile ed i suoi accessori



Universal joint allows punching head to pivot 180deg over a full 360deg rotation.

KIT-HT-FL75-1 KIT-HT-FL75-2 KIT-HT-FL75-3



HOLE PUNCHING KIT

general features

KIT-HT-FL75-1

Kit includes:

HT-FL75 Puller-type hole punching hydraulic tool
VAL-M/L3 plastic carrying case with accessories
Puller TD-11
Puller TD-19
spiral bit Ø 11,5 mm

4 KIT for round punch:

KIT-RD18.8SS	Pg11
KIT-RD20.5SS	Pg13.5
KIT-RD22.6SS	Pg16
KIT-RD28.5SS	Pg21

KIT-HT-FL75-3

Kit includes:

HT-FL75 Puller-type hole punching hydraulic tool
VAL-M/L3 plastic carrying case with accessories
Puller TD-11
Puller TD-19
spiral bit Ø 11,5 mm

6 KIT for round punch:

KIT-RD15.5SS	Pg9
KIT-RD18.8SS	Pg11
KIT-RD20.5SS	Pg13.5 ISO20
KIT-RD22.6SS	Pg16
KIT-RD28.5SS	Pg21
KIT-RD30.5SS-19	G7/8"

KIT-HT-FL75-2

Kit includes:

HT-FL75 Puller-type hole punching hydraulic tool
VAL-M/L3 plastic carrying case with accessories
Puller TD-11
Puller TD-19
spiral bit Ø 11,5 mm

5 KIT for round punch:

KIT-RD16.2SS	ISO16
KIT-RD20.5SS	Pg13.5 ISO20
KIT-RD25.4SS	ISO25
KIT-RD32.5SS	ISO32
KIT-RD40.5SS	ISO40

PULLER-TYPE HOLE PUNCHING HEAD

RH-FL75

general features

MAIN APPLICATIONS

specifically designed for hole punching stainless Steel, mild Steel, fibreglass and plastic sheet materials up to 3,5 mm thickness



STORAGE

Type	VAL-M/S1
Dimensions mm L x W x H	396 x 296 x 145
Weight kg	1,57
Supplied with the tool	✓

TECHNICAL FEATURES

Max Punching Ø mm	140
Max operating pressure bar	700
Dimensions mm	
Length	163
Width	106
Weight kg	1,9

Hydraulic head, for hole punching stainless Steel, mild Steel, fibreglass and plastic sheet materials up to 3,5 mm thickness. Compact and lightweight, easy to handle in confined spaces due to a rotating 90deg quick automatic coupler for connection to

a hydraulic pump with a working pressure of 700 bar max (see page 346-352). Supplied with Pullers TD-11, TD-19 and spiral bit Ø 11,5 mm. For the punch-die selection chart see table below.



HT-FL75 and RH-FL75 Punching accessories available

Round punch

Hole diameter		Material max thickness (mm)			Pilot hole Ø (mm)	Type	
Nominal Ø (mm)	Ø (inch)	Pg	ISO	Stainless Steel		Mild Steel	Puller
15,5	.610	Pg9	-	-	11,5	TD-11	RD15.5SS
16,2	.638	-	ISO-16	-			RD16.2SS
17,0	.669	-	-	G3/8"			RD17.5SS
17,5	.689	-	-	-			RD18.8SS
18,8	.740	Pg11	-	-			RD19.1SS
19,1	.752	-	-	-			RD20.5SS
20,5	.807	Pg 13,5	ISO-20	-			RD21.5SS
21,5	.846	-	-	G1/2"			RD22.6SS
22,6	.890	Pg16	-	-			RD23.8SS
23,8	.937	-	-	G5/8"			RD25.4SS
25,4	1.000	-	ISO-25	-			RD27.5SS
27,0	1.063	-	-	G3/4"			RD28.5SS
28,5	1.122	Pg21	-	-			RD30.5SS
30,5	1.201	-	-	G7/8"			RD28.5SS-19
28,5	1.122	Pg 21	-	-			RD30.5SS-19
30,5	1.201	-	-	G7/8"			RD31.8SS
31,8	1.252	-	-	-			RD32.5SS
32,5	1.279	-	ISO-32	-			RD34SS
34,0	1.338	-	-	G1"			RD34.6SS
34,6	1.362	-	-	-			RD37.2SS
37,2	1.464	Pg29	-	-			RD38.1SS
38,1	1.500	-	-	-			RD38.5SS
38,5	1.515	-	-	G1"1/8"			RD40.5SS
40,5	1.594	-	ISO-40	-			RD41.3SS
41,3	1.626	-	-	-			RD42.5SS
42,5	1.673	-	-	G1"1/4"			RD43.2SS
43,2	1.701	-	-	-			RD44.5SS
44,5	1.752	-	-	-			RD47.2SS
47,2	1.858	Pg36	-	-	RD48.5SS		
48,5	1.909	-	-	G1"1/2"	RD50.5SS		
50,5	1.988	-	ISO-50	-	RD51.4SS		
51,4	2.023	-	-	-	RD52.4SS		
52,4	2.063	-	-	-	RD54.2SS		
54,2	2.134	Pg42	-	G1"3/4"	RD60.5SS		
60,0	2.362	Pg48	-	G2"	RD60.5SS		
60,5	2.381	-	-	-	RD64SS		
64,0	2.520	-	ISO-63	-	RD65SS		
65,0	2.559	-	-	-	RD76SS		
76,0	2.992	-	-	G2"1/2"	RD76.5SS		
76,5	3.011	-	-	-	RD80.5SS		
80,5	3.169	-	-	-	RD89SS		
89,0	3.503	-	-	G3"	RD90SS		
90,0	3.543	-	-	-	RD100SS		
100,0	3.937	-	-	2	RD102SS		
102,0	4.015	-	-	2	RD114SS		
114,0	4.488	-	-	2	RD120SS		
120,0	4.724	-	-	1,5	RD140SS		
140,0	5.512	-	-	1,5			

* Puller included in the kit

"D" punch

Hole diameter		Material max thickness (mm)		Pilot hole Ø (mm)	Type	
Nominal (mm)	(inch)	Stainless Steel	Mild Steel		KIT (Punch+die + Puller)	
(a)38,3 x (b)36,6	(a)1.507 x (b)1.442	2,5	3,5	18,5	RD 18D	
(a)43,1 x (b)41,5	(a)1.696 x (b)1.632				RD 24D	

Stainless Steel = Rm= 700 N/mm² · Mild Steel = Rm= 500 N/mm²

Square punch

Hole diameter		Material max thickness (mm)		Pilot hole Ø (mm)	Type	Application Cable Entry Frames
Nominal (mm)	(inch)	Stainless Steel	Mild Steel			
21,0 x 21,0	.827 x .827	2,5	3,5	12,0	KIT (Punch+die + Puller)	RD21X21
43,0 x 43,0	1.693 x 1.693					RD43X43
46,0 x 46,0	1.811 x 1.811	1,5	2,0	26,5	KIT (Punch+die + Puller)	RD46X46
68,0 x 68,0	2.677 x 2.677					RD68X68
92,0 x 92,0	3.622 x 3.622					RD92X92
126,0 x 126,0	4.960 x 4.960					RD126X126
138,0 x 138,0	5.433 x 5.433	1,0	1,5	28,5	RD138X138	

Rectangular punch

Hole diameter		Material max thickness (mm)		Pilot hole Ø (mm)	Type	Application Cable Entry Frames
Nominal (mm)	(inch)	Stainless Steel	Mild Steel			
18,0 x 46,0	.709 x 1.811	2,0	2,0	16,5	KIT (Punch+die + Puller)	RD18X46
22,0 x 30,0	.866 x 1.181					RD22X30
22,0 x 46,0	.866 x 1.811					RD22X46
24,0 x 43,0	.945 x 1.693					RD24X43
24,0 x 65,0	.945 x 2.559					RD24x65
24,0 x 86,0	.945 x 3.386					RD24X86
24,0 x 112,0	.945 x 4.409					RD24X112
29,0 x 71,0	1.141 x 2.795					RD29X71
35,0 x 65,0	1.377 x 2.559					RD35X65
35,0 x 86,0	1.377 x 3.385					RD35X86
35,0 x 112,0	1.377 x 4.409					RD35X112
36,0 x 46,0	1.417 x 1.811					RD36X46
36,0 x 65,0	1.417 x 2.559	RD36X65				
36,0 x 86,0	1.417 x 3.386	RD36X86				
36,0 x 112,0	1.417 x 4.409	RD36X112				
37,0 x 54,0	1.456 x 2.125	1,5	2,0	26,5	KIT (Punch+die + Puller)	RD37X54
37,0 x 67,0	1.456 x 2.637					RD37X67
37,0 x 88,0	1.456 x 3.464					RD37X88
37,0 x 104,0	1.456 x 4.094					RD37X104
37,0 x 115,0	1.456 x 4.527					RD37X115
46,0 x 54,0	1.811 x 2.126					RD46X54
46,0 x 65,0	1.811 x 2.559					RD46X65
46,0 x 72,0	1.811 x 2.835					RD46X72
46,0 x 86,0	1.811 x 3.386					RD46X86
46,0 x 92,0	1.811 x 3.622					RD46X92
46,0 x 107,0	1.811 x 4.212					RD46X107
46,0 x 112,0	1.811 x 4.409					RD46X112
50,0 x 98,0	1.968 x 3.858	RD50X98				
67,0 x 126,0	2.637 x 4.960	RD67X126				
72,0 x 136,0	2.834 x 5.354	RD72X136				

Stainless Steel = Rm= 700 N/mm² · Mild Steel = Rm= 500 N/mm²

Use of non-CEMBRE punching accessories

Type	Punch & Die	Pilot hole Ø mm
TRD-9.4C (*)	GREENLEE 3/8" - 24 UNF	Ø 10.0
TRD-M11C (*)	BM, COSMEC (M11x1.5), IMB 9602	Ø 11.5
TD-M16C	BM, COSMEC (M16x1.5)	Ø 16.5
TD-27	BM, COSMEC (Ø105=Ø1140)	Ø 27.5
TD-14X14-M14	BM, COSMEC 46x46	Ø 18.8
TD-120X20-M20	BM, COSMEC 92x92	Ø 27.5
TD-20X20-M20 (with plug)	BM, COSMEC 42x95	Ø 27.5
TGD-13.5X13.5-M13	BM, COSMEC 40x40; 45x45; 46x46 (M13)	Ø 18.8
TGD-10X10-M9	BM, COSMEC 006505	Ø 13.8
TD-9	IMB 9601	Ø 9.5
TD-16	IMB 9603	Ø 16.5
TD-10X10-M10 (with plug)	IMB 9623	Ø 14.5
TD-14X14-M14/1"	IMB 9625	Ø 19.5
TD-20 (without plug)	IMB 9626	Ø 27.5
TD-20X20-M20-C (with plug)	IMB 9626	Ø 27.5

(*) The washer supplied with the KIT must be threaded onto the draw stud and positioned between the head and the die to allow the die to rest correctly



RHTD270

Suitable for splitting nuts mm	16(M10)=27(M18)
Max operating pressure bar	700
Weight kg	1,76

RHTD410T

Suitable for splitting nuts mm	27(M18)=41(M27)
Max operating pressure bar	700
Weight kg	4,9

Hydraulic nut splitting head complete with automatic quick coupler. For operating the head must be joined to a hydraulic pump developing a pressure of 700 bar (see page 346-352).

Dimensions mm

	RHTD270	RHTD410T
A	40,5	77
B	25	41
C	105,5	222
D	54	75,5
E	7,5	21,5

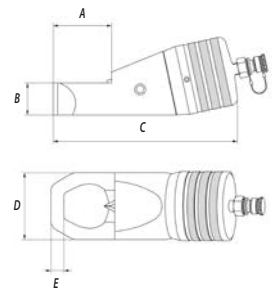

STORAGE

Type	VAL-P4
Dimensions mm L x W x H	315 x 300 x 95
Weight kg	0,93
Supplied with the tool	✓



Application range

Type	HEXAGONAL NUTS		SQUARE NUTS	
RHTD270	16	M 10	17	M 10
	17	M 10	19	M 12
	18	M 12	22	M 14
	19	M 12	24	M 16
	21	M 14	27	M 18
	22	M 14		
	24	M 16		
RHTD410T	27	M 18	27	M 18
	27	M 18	27	M 18
	30	M 20	30	M 20
	32	M 22	32	M 22
	34	M 22	34	M 24
	36	M 24	36	M 27
	41	M 27		

CORDLESS HYDRAULIC TOOLS



SYMBOL DESCRIPTION

cordless hydraulic tools

	Crimping force kN		The adaptive control function guarantees optimisation of the compression cycle, automatically interrupting it when the two dies meet, thus ensuring correct and precise compression
	18.0 V Li-Ion high power batteries		HOLD function piston advancement block allows the connector to be held without compressing it, facilitating the complete insertion of the conductor and verification of correct positioning
	Double speed action: a rapid approach speed and a slower more powerful speed for crimping or cutting		Equipped with safety valve as a additional safety element for the operator
	Openable compression head, ideal for derivations from running conductors		Provided with a maximum pressure sensor that allows to check the correct execution of the compressions
	Openable cutting head, ideal for cutting running cables		Pressure release button
	Tool with a large 42 mm jaw opening, for easier introduction/removal of large size compression terminations and joints		Extremely quiet in operation
	blades manufactured from high strength special Steel, heat treated to ensure a long service life		Very little vibration
	Max cutting diameter		Ergonomically designed with a sculptured body for operator comfort
	Max hole punching diameter		Lightweight and balanced tool for greater control
	The head can rotate to enable the operator to work in the most comfortable position		LED lighting of the working area
	OLED display with multi-function capacitive touch button: Crimping force being generated, Battery power availability, Tool identification, LED state, Reset, No. of operational and service crimping cycles, Tool service required		Dual-compound plastic body Greater safety and comfort in handling, thanks to the rubber inserts
	Battery condition displayed to show the residual battery power		Ensures optimal use of energy available
	Switch protected against accidental operation		Durable moulded body offering high resistance to wear and damage in all operating conditions
	Can be operated with one hand		Crimping cycle data (up to 200,000 events) is automatically stored on a memory card for transfer to PC by USB interface

SYMBOL DESCRIPTION

cordless hydraulic tools



Operating temperature range between -15 and +50°C



UKCA marking



Hexagonal crimp



"Bilinear" configuration
CEMBRE bilinear tools have their mechanical centre of gravity nearest to the operator's wrist to optimise the overall ergonomics of the tool and provide a wider support for the hand



Radial crimp



"Pistol" configuration
The new design and mass distribution favour the easy handling during use



Indent crimp



"Standard" configuration
The design allows the maximum stability and comfort in handling and ergonomics



Deep indent crimp



Oval crimp



Smart Release Technology
Automatic retraction of the ram only occurs when the operator releases the start button, this allows visual verification of the die to ensure that they have fully met prior to releasing



Trapezium crimp



Electronic Pressure Sensor
The EPS guarantees the precision of the crimping operation, checking the actual value of pressure and informing the operator of possible errors



Circular crimp



Electronic Cut Sensor
The ECS guarantees the precision of the cutting operation, checking the complete stroke of the blades and informing the operator about possible errors.



Max operating pressure



Safe Cut Technology
Fitted with LED indicators and a buzzer to communicate during progress and at the completion of the cutting operation.



Manual pressure release button



Fitted with an integral socket, for connection to a 12 V dc external power supply



Radio Remote Control
Radio control device to utility cable cutting operations in limited access locations, eg. in man-holes, to enable working from a safe distance.



Contains isolated oil



Data recording and intelligent control allow complete verification of operational parameters. SMARTOOL technology enables the user to store data from up to 200,000 cycles on the integrated memory card for transfer to a computer via a USB cable



Hydraulic units provide protection against short circuit when accidentally cutting live L.V. / M.V. cables with nominal voltage up to 60 kV



CE marking

18.0 V - 5.2 AH CORDLESS TOOL FEATURES

general features

- 1 Head rotates through 180°
- 2 Switch protected against accidental operation
- 3 Pressure release button
- 4 Slot-in battery with release button
- 5 LED lighting of the working area
- 6 Motor ventilation
- 7 Bi-component body for increased impact resistance
- 8 Multifunction OLED display with touch button
- 9 Improved balance for better handling
- 10 Anatomically shaped grip for greater comfort
- 11 18.0 V - 5.2 Ah Li-Ion high power batteries
- 12 SMARTOOL technology for viewing and downloading operational data



SUPPLIED WITH

- 1 CB1852L, 18.0 V - 5.2 Ah Li-Ion high power battery (2 pcs.)
 - 2 ASC55-EU Battery charger with EUROPEAN plug
ASC55-UK Battery charger with UK plug
ASC55-USA/CA, AC charger (115V) with USA/CANADA plug
ASC55-AUS/NZ, AC charger with AUSTRALIAN/NEW ZEALAND plug
(INPUT 220-240 V / 50-60 Hz; OUTPUT 12-42 V DC / 3.0 A max.)
 - 3 USB cable
 - 4 Shoulder strap
- Plastic or Metal carrying case



Multifunction OLED display:

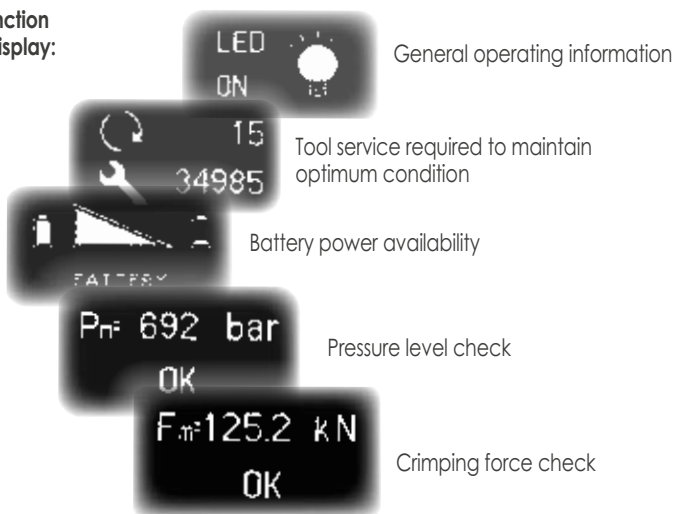

18.0 V - 2.0 AH CORDLESS TOOL FEATURES

general features

- 1 Bilinear mechanical design
- 2 Smart Release system to automatically retract the ram at the end of the crimping cycle
- 3 OLED multifunctional display with touch button
- 4 Electronic Pressure Sensor (EPS)
- 5 SMARTOOL technology for viewing and downloading operational data
- 6 Illumination of working area via 4 x LED lights
- 7 Bi-component plastic body
- 8 Head rotates for ease of operation in confined spaces
- 9 Switch protected against accidental operation
- 10 Pressure release button
- 11 Slot-in battery with release button
- 12 Battery condition displayed to show the residual battery power
- 13 Motor ventilation
- 14 The tools are fitted with a maximum pressure valve to indicate a correct crimping operation or the full extent of the ram travel
- 15 Can be operated with one hand
- 16 Extremely quiet in operation with very little vibration
- 17 Anatomically shaped grip for greater comfort
- 18 18.0 V - 2.0 Ah Li-Ion high power batteries



New Range *nd*



B15MD



SUPPLIED WITH

- 1 CB1820L, 18.0 V - 2.0 Ah Li-Ion high power battery (2 pcs.)
- 2 ASC55-EU Battery charger with EUROPEAN plug
ASC55-UK Battery charger with UK plug
ASC55-USA/CA, AC charger (115V) with USA/CANADA plug
ASC55-AUS/NZ, AC charger with AUSTRALIAN/NEW ZEALAND plug
(INPUT 220-240 V / 50-60 Hz; OUTPUT 12-42 V DC / 3.0 A max.)
- 3 USB cable (not for B15MD)
 - Wrist strap
 - Plastic carrying case



B15MD

18.0 V CORDLESS HYDRAULIC CRIMPING TOOL

general features

Tool Type	Plug Type	Supplied Battery Charger Type
B15MD	PLUG EU	ASC55-EU with EUROPEAN plug
B15MDE	PLUG UK	ASC55-UK with UK plug
B15MA	PLUG USA CAN	ASC55-USA/CA (115V) with USA/CANADA plug
B15MDT	PLUG AUS NZ	ASC55-AUS/NZ with AUSTRALIAN/NEW ZEALAND plug

MAIN APPLICATIONS - max section sqmm

Section sqmm	0,25÷1,5	1,5÷2,5	4÷6	10	16	25	35	50	70	95	120	150	185	240	300	400	500	630	800	1000	
Copper lugs and splices																					
Insulated terminals																					
End sleeves																					

These tools are supplied without dies. For die selection, please refer to chart on pages 368 to 384



The tool is supplied as:

- Basic tool with battery and wrist strap
- Spare battery
- Battery charger
- Plastic carrying case suitable for storing the tool and accessories

TECHNICAL FEATURES

Crimping force kN	15
Dimensions mm	
Length	335
Height	124
Width	79
Battery	18.0V 2.0Ah
Weight kg (with Battery)	1,74

STORAGE

Type	VAL-P22
Dimensions mm L x W x H	465 x 315 x 116
Weight kg	1,5
Supplied with the tool	✓

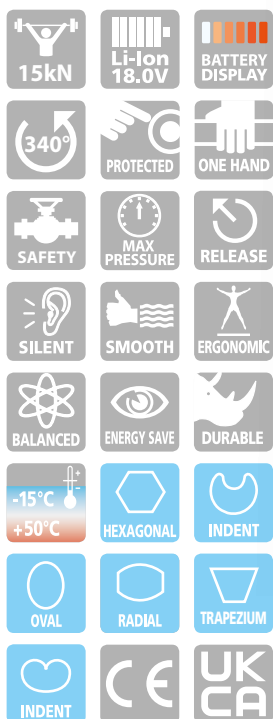

Can be operated with one hand. Balanced for greater control. Head rotates by 340° for ease of operation in confined spaces. The tool is fitted with a maximum pressure valve. Extremely quiet, minimal vibration. Durable moulded body offering high resistance to wear and damage in all operating conditions. Equipped with Li-Ion 18.0V - 2.0Ah rechargeable high capacity batteries. The battery is equipped with LED indicators to show the remaining battery life at any time by pressing the adjacent button. Supplied in a robust plastic case to accommodate the tool and all the accessories. Two batteries and charger included. Many different interchangeable crimping dies available. Operating temperature: -15 to +50 °C

Many different interchangeable crimping dies available

Conductor Size sqmm (AWG)	Connector Type	Die Set
0,25 ÷ 16	22 ÷ 6 A...; L...-M; L...-P; S...; RN...; BN...; GN...	MA03/3-15
1,5 ÷ 10	16 ÷ 8 A...; L...-M; L...-P	ME03/2-15
10 ÷ 16	8 ÷ 6 A...; 2A...; L...-M; L...-P	ME2/3-15
4 ÷ 10	12 ÷ 8 T... (NF C 20130 style); L...-T	MS4/10-15
10 ÷ 16	8 ÷ 6 T... (NF C 20130 style); L...-T	MS10/16-15
10 ÷ 16	8 ÷ 6 HR...; HSV...	MH10/16-15
6 ÷ 16	10 ÷ 6 DR... (DIN 46235 style); DSV... (DIN 46267 T1 style)	MK5/8-15
10 ÷ 16	8 ÷ 6 ANE...; AN...; IN...; EN...	NN4-15
0,25 ÷ 6	22 ÷ 10 R...; B...; G...; PL...; NL...	RBG-15
0,25 ÷ 6	22 ÷ 10 R...; B...; G... (not suffix P, RF/BF-BF)	RBV-15 with positioner
0,3 ÷ 4	22 ÷ 12 PKE; PKC; PKD; PKT; KE	KE4-15
4 ÷ 16	12 ÷ 6 PKE; PKC; PKD; PKT; KE	KE16-15
16 ÷ 35	6 ÷ 2 PKE; PKC; PKD; PKT; KE	KE35-15
2,5 - 4 - 6	14 - 12 - 10 CS4 (for photovoltaic systems)	MCS4-15

18.0 V CORDLESS HYDRAULIC CRIMPING TOOL

general features

MAIN APPLICATIONS - max section sqmm

Section sqmm	0.25-1.5	1.5-2.5	4-6	10	16	25	35	50	70	95	120	150	185	240	300	400	500	600	800	1000	
L.V. lugs and splices																					
"C" sleeve Connectors																					

These tools are supplied without dies. For die selection, please refer to chart on pages 368 to 384

TECHNICAL FEATURES

Crimping force kN	50
Dimensions mm	
Length	364
Height	126
Width	79
Battery	18.0V 2.0Ah
Weight kg (with Battery)	2,6

STORAGE

Type	VAL-P22
Dimensions mm L x W x H	465 x 315 x 116
Weight kg	1,5
Supplied with the tool	✓



B450ND-BV is a new generation of hand-held cordless tools, characterised by a "Bi-linear" mechanical design. B450ND-BV is suitable for crimping electrical connectors onto conductor cross sections up to 150 mm² and uses the die sets common to all CEMBRE 45 kN tools and heads. Equipped with Li-Ion 18.0V - 2.0Ah rechargeable high capacity batteries. The battery is equipped with LED indicators to show the remaining battery life at any time by pressing the adjacent button. Weight and balance have been reconfigured to yield improvements in handling and convenience. Quieter operation, illumination of the working area via LED lights and a minimum of vibration enhance the tool's practicality. It is also a feature that the operating data is stored on a memory card for transfer to PC by USB interface (SMARTOOL technology).



The tool is supplied as:

- Basic tool with battery and wrist strap
- Battery charger
- USB cable
- Plastic carrying case suitable for storing the tool and accessories

B450ND-BV

Tool Type	Plug Type	Supplied Battery Charger Type
B450ND-BV	PLUG EU	ASC55-EU with EUROPEAN plug
B450ND-BVE	PLUG UK	ASC55-UK with UK plug
B450ND-BVA	PLUG USA/CA	ASC55-USA/CA (115V) with USA/CANADA plug
B450ND-BVT	PLUG AU/NZ	ASC55-AUS/NZ with AUSTRALIAN/NEW ZEALAND plug

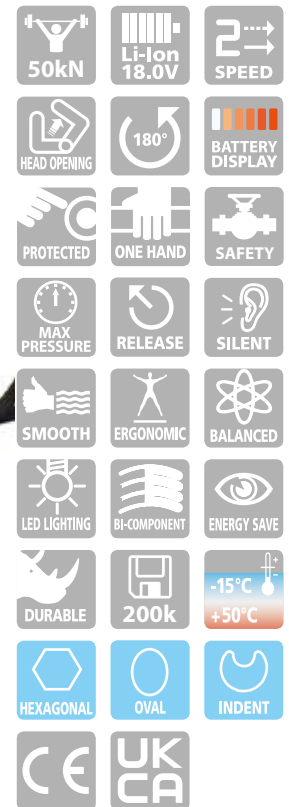

KIT-B450ND-BV-ME

COMPRESSION KIT

general features

The kit includes the B450ND-BV battery-powered hydraulic tool (50 kN) complete with 7 pairs of dies (from 25 to 150 mm²) and a practical and sturdy case for transporting the tool and its accessories.



KIT-B450ND-BV-ME

Kit includes:

- B450ND-BV cordless hydraulic tool
- VALP22 plastic carrying case with accessories
- CB1820L Battery Li-Ion 18.0 V - 2.0 Ah
- ASC55-EU Battery Charger

7 die sets:

- ME5
- ME7
- ME10
- ME14
- ME19
- ME24
- ME30

Hexagonal crimp for low voltage terminals and through connectors from 25 to 150 mm² A-M family

B500ND

18.0 V CORDLESS HYDRAULIC CRIMPING TOOL

general features

Tool Type	Plug Type	Supplied Battery Charger Type
B500ND	PLUG EU	ASC55-EU with EUROPEAN plug
B500NDE	PLUG UK	ASC55-UK with UK plug
B500NDA	PLUG USA/CA	ASC55-USA/CA (115V) with USA/CANADA plug
B500NDT	PLUG AU/NZ	ASC55-AUS/NZ with AUSTRALIAN/NEW ZEALAND plug

MAIN APPLICATIONS - max section sqmm

Section sqmm	0.25-1.5	1.5-2.5	4-6	10	16	25	35	50	70	95	120	150	185	200	240	300	400	500	630	800	1000	
L.V. lugs and splices																						
Insulated terminals																						
End sleeves																						
"C" sleeve Connectors																						
H.V. lugs and splices																						

These tools are supplied without dies. For die selection, please refer to chart on pages 368 to 384



TECHNICAL FEATURES

Crimping force kN	60
Dimensions mm	
Length	396
Height	126
Width	79
Battery	18.0V 2.0Ah
Weight kg (with Battery)	3,15

STORAGE

Type	VAL-P22
Dimensions mm L x W x H	465 x 315 x 116
Weight kg	1,5
Supplied with the tool	✓

B500ND is the first of a new generation of hand-held cordless tools, characterised by a "Bilinear" mechanical design. Equipped with a Smart Release system which automatically retracts the ram at the end of the operating cycle.

B500ND is suitable for crimping electrical connectors onto conductor cross sections up to 300 mm² and uses the die sets common to all CEMBRE 50kN tools and heads.

The tool is supplied as:

- Basic tool with battery and wrist strap
- Spare battery, Battery charger, USB cable
- Plastic carrying case suitable for storing the tool and accessories

KIT-B500ND-1 KIT-B500ND/320F

B500ND COMPRESSION/CUTTING KIT

general features

KIT-B500ND-1

Kit includes:

- B500ND cordless hydraulic tool
- VALP22 plastic carrying case with accessories

8 die sets:

ME5-50	Hexagonal crimp for low voltage terminals and through connectors from 25 to 240 mm ² A-M family
ME7-50	
ME10-50	
ME14-50	
ME19-50	
ME24-50	
ME30-50	
ME37-50	



KIT-B500ND/320F

Kit includes:

- B500ND cordless hydraulic tool
- B-TC320NDF cordless hydraulic cutting tool
- VAL-M/X5 plastic carrying case with accessories

8 die sets:

ME5-50	Hexagonal crimp for low voltage terminals and through connectors from 25 to 240 mm ² A-M family
ME7-50	
ME10-50	
ME14-50	
ME19-50	
ME24-50	
ME30-50	
ME37-50	



18.0 V CORDLESS HYDRAULIC CRIMPING TOOL

B540ND6

general features

MAIN APPLICATIONS - max section AWG

- Copper lugs and splices 300 MCM
- Aluminium lugs and splices 4/0
- Aluminium H taps 4/0 - 4/0

TECHNICAL FEATURES

Crimping force kN	54
Dimensions mm	
Length	495
Height	145
width	88
Battery	18.0V 2.0Ah
Weight kg (with Battery and CDD6N)	3,4

STORAGE

Type	VAL-P60
Dimensions mm L x W x H	620 x 360 x 138
Weight kg	2,4
Supplied with the tool	✓



The professional tool ideal for OH lines and residential service applications.

The tool is supplied as:

- Basic tool with jaws CDD6N, battery and wrist strap
- Spare battery
- Battery charger
- USB cable
- Plastic carrying case suitable for storing the tool and accessories



Tool Type	Plug Type	Supplied Battery Charger Type
B540ND6	PLUG EU	ASC55-EU with EUROPEAN plug
B540ND6E	PLUG UK	ASC55-UK with UK plug

54kN	Li-Ion 18.0V	SPEED
HEAD OPENING	180°	OLED
BATTERY DISPLAY	PROTECTED	ONE HAND
SAFETY	MAX PRESSURE	RELEASE
SILENT	SMOOTH	ERGONOMIC
BALANCED	LED LIGHTING	B+COMPONENT
ENERGY SAVE	DURABLE	200k
-15°C	+50°C	HEXAGONAL
CIRCULAR	CE	UK CA

B540ND6 is the first of a new generation of hand-held cordless tools, characterised by a "Bilinear" mechanical structure. Equipped with intelligent auto-return at the end of the operating cycle (Smart Release). Equipped with Li-Ion 18.0V - 2.0Ah rechargeable high capacity batteries. Jaws rotate by 180° for ease of operation in confined spaces.

Fitted with a maximum pressure sensor for enhanced precision and repeatability of the maximum pressure cycle, and a pressure relief valve providing additional safety for the operator.

Interchangeable Jaws

Many different CEMBRE interchangeable crimping and cutting jaws are available upon request .

CDD6N jaws



CMB4N jaws



CDD6-6N jaws



CMB5N jaws



CDD6-8N jaws



CMB6N jaws



INTERCHANGEABLE CRIMPING AND CUTTING JAWS

CAT.No	GROOVES	CRIMPING DIE COMPATIBILITY	
CDD6N	"D3" TO ACCEPT ALL "W" STYLE CRIMPING DIES + "BG" FIXED GROOVE	FCI Burndy	W, X Series
		Greenlee	KD6 Series
		IlSCO	ND Series
		Huskie	HT-58 Series
CDD6-6N	"D3" TO ACCEPT ALL "W" STYLE CRIMPING DIES	Panduit	CD-2001 series
		FCI Burndy	W, X Series
		Greenlee	KD6 Series
		IlSCO	ND Series
CDD6-8N	"D3" TO ACCEPT ALL "W" STYLE CRIMPING DIES + "O" FIXED GROOVE	Huskie	HT-58 Series
		Panduit	CD-2001 series
		FCI Burndy	W, X Series
		Greenlee	KD6 Series
CMB4N	Cutting jaws for underground: Aluminum & Copper stranded cables. Max opening 32 mm	IlSCO	ND Series
		Huskie	HT-58 Series
		Panduit	CD-2001 series
CMB5N	Cutting jaws for OHL: up to 200 mm ² ACSR and BLX cable		
CMB6N	Cutting jaws for guy wires: Up to Ø 10 mm galvanised steel wire (<1250N/mm ²)		

B500

18.0 V CORDLESS HYDRAULIC CRIMPING TOOL

general features

Tool Type	Plug Type	Supplied Battery Charger Type
B500	PLUG EU	ASC55-EU with EUROPEAN plug
B500E	PLUG UK	ASC55-UK with UK plug
B500A	PLUG USA/CA	ASC55-USA/CA (115V) with USA/CANADA plug
B500T	PLUG AUS/NZ	ASC55-AUS/NZ with AUSTRALIAN/NEW ZEALAND plug

MAIN APPLICATIONS - max section sqmm

Section sqmm	0.25-1.5	1.5-2.5	4-6	10	16	25	35	50	70	95	120	150	185	200	240	300	400	500	630	800	1000	
L.V. lugs and splices																						
Insulated terminals																						
End sleeves																						
"C" sleeve Connectors																						
H.V. lugs and splices																						

These tools are supplied without dies. For die selection, please refer to chart on pages 368 to 384



B500-KV version also available for Power Supply Companies

TECHNICAL FEATURES

Crimping force kN	63
Dimensions mm	
Length	300
Height	343
Width	83
Battery	18.0V 5.2Ah
Weight kg (with Battery)	4,2

STORAGE

Type	VAL-P38
Dimensions mm L x W x H	520 x 432 x 126
Weight kg	2,6
Supplied with the tool	✓



- The tool is supplied as:
- Basic tool with battery and shoulder strap
 - Spare battery
 - Battery charger
 - USB cable
 - Plastic carrying case suitable for storing the tool and 14 die sets

The 63 kN B500 is suitable for a wide range of connectors up to 300 sqmm using die sets common to the CEMBRE 50 kN tooling range. Equipped with Li-Ion 18.0V - 5.2Ah rechargeable high capacity batteries.

The OLED display provides essential real time operating data, including:

- generated crimping force thus verifying accordance with best practice
- battery charge status
- general operating information
- the number of work cycles completed and remaining before recommended maintenance.

KIT-B500-1 KIT-B500-2 KIT-B500-MK

B500 COMPRESSION KIT

general features

KIT-B500-1

Kit includes:

B500 cordless hydraulic tool	
VAL-P38 plastic carrying case with accessories	
8 die sets:	
ME5-50	
ME7-50	
ME10-50	
ME14-50	
ME19-50	Hexagonal crimp terminals and through connectors from 25 to 240 mm ² A-M family
ME24-50	
ME30-50	
ME37-50	
ME48-50	

KIT-B500-2

Kit includes:

B500 cordless hydraulic tool		
VAL-P38 plastic carrying case with accessories		
6 die sets:		
Nest	Indentor	
MA5-50	PA5-50	Indent crimp for low voltage general purpose terminals and through connectors from 25 to 120 mm ²
MA7-50	PA10-50	
MA10-50	PA10-50	
MA14-50	PA19-50	
MA19-50	PA19-50	
MA24-50	PA24-50	

KIT-B500-MK

Kit includes:

B500 cordless hydraulic tool	
VAL-P38 plastic carrying case with accessories	
10 die sets:	
MK8-50	
MK10-50	
MK12-50	
MK14-50	
MK16-50	Hexagonal crimp terminals and through connectors from 16 to 240 mm ² DIN 46235 family
MK18-50	
MK20-50	
MK22-50	
MK25-50	
MK28-50	

18.0 V CORDLESS HYDRAULIC CRIMPING TOOL

BA500

general features

MAIN APPLICATIONS - max section sqmm

Section sqmm	0.25÷1.5	1.5÷2.5	4÷6	10	16	25	35	50	70	95	120	150	185	200	240	300	400	500	630	800	1000	
L.V. lugs and splices																						
Insulated terminals																						
End sleeves																						
"C" sleeve Connectors																						
H.V. lugs and splices																						

These tools are supplied without dies. For die selection, please refer to chart on pages 368 to 384

TECHNICAL FEATURES

Crimping force kN	60
Dimensions mm	
Length	300
Height	343
Width	83
Battery	18.0V 5.2Ah
Weight kg (with Battery)	4,2

ADAPTIVE
AC
CONTROL



STORAGE

Type	VAL-MX3
Dimensions mm L x W x H	596 x 396 x 185
Weight kg	3,5
Supplied with the tool	✓



The tool is supplied as:

- Basic tool with battery and shoulder strap
- Spare battery
- Battery charger
- USB cable
- Plastic carrying case suitable for storing the tool and accessories

Perfect for installing compression electrical connectors on conductors up to 300 mm², the BA500 with adaptive control is the ideal solution for all electrical compression needs.

This innovative tool uses the series of dies compatible with the 50 kN tools and heads produced by CEMBRE, guaranteeing maximum versatility and reliability.

Equipped with high-capacity 18 V 5.2 Ah Li-Ion batteries, it offers optimal performance for long work sessions.

The advanced OLED display allows you to easily monitor various parameters, including:

- **Force developed:** to verify the correct execution of the compression
- **Battery charge status**
- **General operating information**
- **Number of work cycles** completed and remaining: to plan maintenance

The BA500 is the tool that guarantees precision, efficiency and control in every operation.



Adaptive control

The **ADAPTIVE CONTROL** function guarantees optimisation of the crimping cycle, automatically interrupting the cycle when the two dies come into contact.

This innovative approach eliminates the need to reach maximum pressure at each cycle, as is the case with traditional tools, reducing tool wear and ensuring the same quality standards as maximum pressure crimping.

The advantages?

- **Less mechanical stress on the tool and longer component life**
- **Energy savings and longer battery life**

At the end of each cycle, the system provides an analysis of the energy reduction compared to the standard cycle, indicating the percentage savings (**SAVED ...%**). Using the **HOLD** function, the tool stops automatically when the dies come into contact with the connector, without deforming it, this allows it to be held in place, facilitating complete insertion of the conductor and allowing correct positioning to be checked before crimping, thus **reducing errors**. A smart solution for precise, efficient and long-lasting operations.

Tool Type	Plug Type	Supplied Battery Charger Type
BA500	PLUG EU	ASC55-EU with EUROPEAN plug
BA500E	PLUG UK	ASC55-UK with UK plug
BA500A	PLUG USA/CA	ASC55-USA/CA (115V) with USA/CANADA plug



B600CND

18.0 V CORDLESS HYDRAULIC CRIMPING TOOL

general features

Tool Type	Plug Type	Supplied Battery Charger Type
B600CND	PLUG EU	ASC55-EU with EUROPEAN plug
B600CND-E	PLUG UK	ASC55-UK with UK plug
B600CND-A	PLUG USA/CA	ASC55-USA/CA (115V) with USA/CANADA plug

MAIN APPLICATIONS - max section sqmm

Section sqmm	0.25-1.5	1.5-2.5	4-6	10	16	25	35	50	70	95	120	150	185	240	300	400	500	630	800	1000	
Cu DIN lugs and splices																					
L.V. lugs and splices																					
End sleeves																					

These tools are supplied without dies. For die selection, please refer to chart on pages 368 to 384

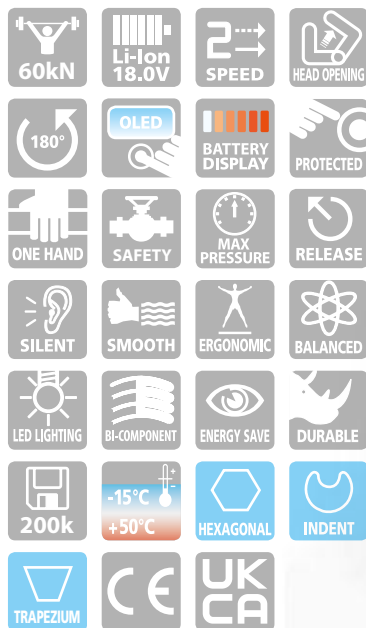

B600CND is a new generation of hand-held cordless tools, characterised by a "Bilinear" mechanical design. Equipped with a Smart Release system which automatically retracts the ram at the end of the

operating cycle. B600CND is suitable for crimping electrical connectors onto conductor cross sections up to 300 mm². Equipped with Li-Ion 18.0V - 2.0Ah rechargeable high capacity bat-



STORAGE

Type	VAL-M/L1
Dimensions mm L x W x H	496 x 296 x 145
Weight kg	2,3
Supplied with the tool	✓



teries. Head rotate by 180° for ease of operation in confined spaces. Fitted with a maximum pressure sensor for enhanced precision and repeatability of the maximum pressure cycle, and a pressure relief valve providing additional safety for the operator.

TECHNICAL FEATURES

Crimping force kN	60
Dimensions mm	
Length	397
Height	126
Width	79
Battery	18.0V 2.0Ah
Weight kg (with Battery)	3,15

The tool is supplied as:

- Basic tool with battery and wrist strap
- Spare battery
- Battery charger
- USB cable
- Plastic carrying case suitable for storing the tool and accessories

The EPS guarantees the precision of the crimping operation, checking the actual value of pressure and informing the operator about possible errors (EPS). The OLED display provides essential real time operating data, including:

- generated crimping force thus verifying accordance with best practice
- battery charge status
- general operating information
- the number of work cycles completed and remaining before.

KIT-B600CND-MK KIT-B600CND-MH

B600CND COMPRESSION KIT

general features



The tool is supplied as:

- Basic tool with battery and wrist strap
- Spare battery
- Battery charger
- USB cable
- Plastic carrying case suitable for storing the tool and accessories



KIT-B600CND-MK

Kit includes:

B600CND cordless hydraulic tool
VAL-M/L1 plastic carrying case with accessories

9 die sets:

MK10-60C
MK12-60C
MK14-60C
MK16-60C
MK18-60C
MK20-60C
MK22-60C
MK25-60C
MK28-60C

Hexagonal crimp for low voltage terminals and through connectors from 25 to 240 mm² DIN 46235 family

KIT-B600CND-MH

Kit includes:

B600CND cordless hydraulic tool
VAL-M/L1 plastic carrying case with accessories

9 die sets:

MH25-60
MH35-60
MH50-60
MH70-60
MH95-60
MH120-60
MH150-60
MH185-60
MH240-60

Hexagonal crimp for low voltage terminals and through connectors from 25 to 240 mm² de 16 à 240 mm²

18.0 V CORDLESS HYDRAULIC CRIMPING TOOL

general features

MAIN APPLICATIONS - max section sqmm

Section sqmm	0.25-1.5	1.5-2.5	4-6	10	16	25	35	50	70	95	120	150	185	240	300	400	500	630	800	1000	
Cu DIN lugs and splices																					
L.V. lugs and splices																					
End sleeves																					

These tools are supplied without dies. For die selection, please refer to chart on pages 368 to 384

TECHNICAL FEATURES

Crimping force kN	60
Dimensions mm	
Length	300
Height	350
Width	83
Battery	18.0V 5.2Ah
Weight kg (with Battery)	4,5

STORAGE

Type	VAL-P61
Dimensions mm L x W x H	520 x 432 x 126
Weight kg	2,6
Supplied with the tool	✓



The tool is supplied as:

- Basic tool with battery and shoulder strap
- Spare battery
- Battery charger
- USB cable
- Plastic carrying case suitable for storing the tool and accessories



B600C

Tool Type	Plug Type	Supplied Battery Charger Type
B600C	PLUG EU	ASC55-EU with EUROPEAN plug
B600CE	PLUG UK	ASC55-UK with UK plug
B600CA	PLUG USA/CA	ASC55-USA/CA (115V) with USA/CANADA plug



The B600C is a new generation of portable cordless tools that are characterized by even better functionality. The B600C is suitable for crimping cable lugs and connectors up to 300 mm².

Equipped with Li-Ion 18.0V - 5.2Ah rechargeable high capacity batteries.

The OLED display provides essential real time operating data, including:

- generated crimping force thus verifying accordance with best practice
- battery charge status
- general operating information
- the number of work cycles completed and remaining before recommended maintenance.

B1350-C

18.0 V CORDLESS HYDRAULIC CRIMPING TOOL

general features

Tool Type	Plug Type	Supplied Battery Charger Type
B1350-C	PLUG EU	ASC55-EU with EUROPEAN plug
B1350-CE	PLUG UK	ASC55-UK with UK plug
B1350-CA	PLUG USA CAN	ASC55-USA/CA (115V) with USA/CANADA plug
B1350-CT	PLUG AUS NZ	ASC55-AUS/NZ with AUSTRALIAN/NEW ZEALAND plug

MAIN APPLICATIONS - max section sqmm

Section sqmm	0.25±1.5	1.5±2.5	4-6	10	16	25	35	50	70	95	120	150	185	200	240	300	400	500	630	800	1000	
L.V. lugs and splices																						
Insulated terminals																						
"C" sleeve Connectors																						
H.V. lugs																						
H.V. Splices*																						

*limited to the cable insulation diameter

These tools are supplied without dies. For die selection, please refer to chart on pages 368 to 384



TECHNICAL FEATURES

Crimping force kN	132
Dimensions mm	
Length	338
Height	344
Width	83
Jaw Opening mm	25
Battery	18.0V 5.2Ah
Weight kg (with Battery)	6,5

STORAGE

Type	VAL-P39
Dimensions mm L x W x H	520 x 432 x 126
Weight kg	2,6
Supplied with the tool	✓



The tool is supplied as:

- Basic tool with battery and shoulder strap
- Spare battery
- Battery charger
- USB cable
- Plastic carrying case suitable for storing the tool and 8 die sets

B1350-C is suitable for a wide range of connectors up to 400 sqmm using die sets common to the CEM-BRE 130 kN tooling range.

Equipped with Li-Ion 18.0V - 5.2Ah rechargeable high capacity batteries.

The OLED display provides essential real time operating data, including:

- generated crimping force thus verifying accordance with best practice
- battery charge status
- general operating information
- the number of work cycles completed and remaining before recommended maintenance.



B1350-C-KV version also available for Power Supply Companies

18.0 V CORDLESS HYDRAULIC CRIMPING TOOL

general features

MAIN APPLICATIONS - max section sqmm

Section sqmm	0.25-1.5	1.5-2.5	4-6	10	16	25	35	50	70	95	120	150	185	200	240	300	400	500	630	800	1000	
L.V. lugs and splices																						
Insulated terminals																						
"C" sleeve Connectors																						
H.V. lugs and splices																						

These tools are supplied without dies. For die selection, please refer to chart on pages 368 to 384

TECHNICAL FEATURES

Crimping force kN	132
Dimensions mm	
Length	395
Height	372
Width	83
Jaw Opening mm	42
Battery	18.0V 5.2Ah
Weight kg (with Battery)	8,1

STORAGE

Type	VAL-P39
Dimensions mm L x W x H	520 x 432 x 126
Weight kg	2,6
Supplied with the tool	✓



The tool is supplied as:

- Basic tool with battery and shoulder strap
- Spare battery
- Battery charger
- USB cable
- Plastic carrying case suitable for storing the tool and 8 die sets

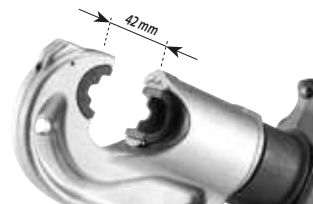

B1350L-C version, featuring a large 42 mm jaw opening, for an easier introduction/removal of large size compression terminations and joints.



B1350L-C-KV version also available for Power Supply Companies

B1350L-C

Tool Type	Plug Type	Supplied Battery Charger Type
B1350L-C	PLUG EU	ASC55-EU with EUROPEAN plug
B1350L-CE	PLUG UK	ASC55-UK with UK plug
B1350L-CA	PLUG USA CAN	ASC55-USA/CA (115V) with USA/CANADA plug
B1350L-CT	PLUG A NZ AUS	ASC55-AUS/NZ with AUSTRALIAN/NEW ZEALAND plug



B1350L-C is suitable for a wide range of connectors up to 400 sqmm using die sets common to the CEMBRE 130 kN tooling range. Equipped with Li-Ion 18.0V - 5.2Ah rechargeable high capacity batteries.

The OLED display provides essential real time operating data, including:

- generated crimping force thus verifying accordance with best practice
- battery charge status
- general operating information
- the number of work cycles completed and remaining before recommended maintenance.

B1350-UC

18.0 V CORDLESS HYDRAULIC CRIMPING TOOL

general features

Tool Type	Plug Type	Supplied Battery Charger Type
B1350-UC	PLUG EU	ASC55-EU with EUROPEAN plug
B1350-UCE	PLUG UK	ASC55-UK with UK plug
B1350-UCA	PLUG USA	ASC55-USA/CA (115V) with USA/CANADA plug
B1350-UCT	PLUG AU	ASC55-AUS/NZ with AUSTRALIAN/NEW ZEALAND plug

MAIN APPLICATIONS - max section sqmm

Section sqmm	0.25±1.5	1.5±2.5	4-6	10	16	25	35	50	70	95	120	150	185	200	240	300	400	500	680	800	1000	
L.V. lugs and splices																						
Insulated terminals																						
"C" sleeve Connectors																						
Alu lugs and splices																						
H.V. lugs and splices																						

These tools are supplied without dies. For die selection, please refer to chart on pages 368 to 384



132kN	Li-Ion 18.0V	SPEED
180°	OLED	BATTERY DISPLAY
PROTECTED	ONE HAND	SAFETY
MAX PRESSURE	RELEASE	SILENT
SMOOTH	ERGONOMIC	BALANCED
LED LIGHTING	BI-COMPONENT	ENERGY SAVE
DURABLE	200k	-15°C +50°C
HEXAGONAL	RADIAL	INDENT
DEEP INDENT	OVAL	CIRCULAR
CE	UK	CA

B1350-UC will accept the accessories for performing the "Deep Stepped Indent" system of crimping on Aluminium cables. The B1350-UC will accept all semi-circular slotted dies, common to most 12 tons tools (U dies). Equipped with Li-Ion 18.0V - 5.2Ah rechargeable high capacity batteries.

The OLED display provides essential real time operating data, including:

- generated crimping force thus verifying accordance with best practice
- battery charge status
- general operating information
- the number of work cycles completed and remaining before recommended maintenance.

TECHNICAL FEATURES

Crimping force kN	132
Dimensions mm	
Length	351
Height	369
Width	83
Battery	18.0V 5.2Ah
Weight kg (with Battery)	6,3

STORAGE

Type	VAL-P39
Dimensions mm L x W x H	520 x 432 x 126
Weight kg	2,6
Supplied with the tool	✓



The tool is supplied as:

- Basic tool with battery and shoulder strap
- Spare battery
- Battery charger
- USB cable
- Plastic carrying case suitable for storing the tool and 8 die sets

STORAGE

Type	VAL-130*
Dimensions mm L x W x H	360 x 280 x 48
Weight kg	3,0
Purchase separately	✓

*Suitable for the storage of accessories for crimping Aluminium connectors



VAL-130

18.0 V CORDLESS HYDRAULIC CRIMPING TOOL

B1300-C

general features

MAIN APPLICATIONS - max section sqmm

Section sqmm	0.25-1.5	1.5-2.5	4-6	10	16	25	35	50	70	95	120	150	185	200	240	300	400	500	630	800	1000	
L.V. lugs and splices																						
Insulated terminals																						
"C" sleeve Connectors																						
H.V. lugs																						
H.V. Splices*																						

*limited to the cable insulation diameter

These tools are supplied without dies. For die selection, please refer to chart on pages 368 to 384

TECHNICAL FEATURES

Crimping force kN	132
Dimensions mm	
Length	406
Height	239
Width	102,5
Jaw Opening mm	25
Battery	18.0V 5.2Ah
Weight kg (with Battery)	6,8

STORAGE

Type	VAL-P44
Dimensions mm L x W x H	680 x 473 x 151
Weight kg	3,7
Supplied with the tool	✓

The tool is supplied as:

- Basic tool with battery and shoulder strap
- Spare battery
- Battery charger
- USB cable
- Plastic carrying case suitable for storing the tool and 12 die sets



B1300-C is suitable for a wide range of connectors up to 400 sqmm using die sets common to the CEMBRE 130 kN tooling range. Equipped with Li-Ion 18.0V - 5.2Ah rechargeable high capacity batteries.



B1300-C-KV version also available for Power Supply Companies

Tool Type	Plug Type	Supplied Battery Charger Type
B1300-C	PLUG EU	ASC55-EU with EUROPEAN plug
B1300-CE	PLUG UK	ASC55-UK with UK plug
B1300-CA	PLUG USA CAN	ASC55-USA/CA (115V) with USA/CANADA plug
B1300-CT	PLUG AUZ NZL	ASC55-AUS/NZ with AUSTRALIAN/NEW ZEALAND plug



B1300-C COMPRESSION KIT

general features

KIT-B1300-C-1

Kit includes:	
B1300-C cordless hydraulic tool	
VAL-P44 plastic carrying case with accessories	
7 die sets:	
ME10-C	Hexagonal crimp for low voltage terminals and through connectors from 50 to 240 mm ² A-M family
ME14-C	
ME19-C	
ME24-C	
ME30-C	
ME37-C	
ME48-C	

KIT-B1300-C-2

Kit includes:		
B1300-C cordless hydraulic tool		
VAL-P44 plastic carrying case with accessories		
11 die sets:		
Nest	Indentor	Indent crimp for low voltage general purpose terminals and through connectors from 10 to 240 mm ²
MA2-C		
MA3-C		
MA5-C	PA10-C	
MA7-C		
MA10-C		
MA14-C		
MA19-C	PA24-C	
MA24-C		
MA30-C		
MA37-C	PA48-C	
MA48-C		

KIT-B1300-C-1 KIT-B1300-C-2 KIT-B1300-C-MK

KIT-B1300-C-MK

Kit includes:	
B1300-C cordless hydraulic tool	
VAL-P44 plastic carrying case with accessories	
11 die sets:	
MK6-C	Hexagonal crimp for low voltage terminals and through connectors from 10 to 240 mm ² DIN 46235 family
MK8-C	
MK10-C	
MK12-C	
MK14-C	
MK16-C	
MK18-C	
MK20-C	
MK22-C	
MK25-C	
MK28-C	

B1300L-C

18.0 V CORDLESS HYDRAULIC CRIMPING TOOL

general features

Tool Type	Plug Type	Supplied Battery Charger Type
B1300L-C	PLUG EU	ASC55-EU with EUROPEAN plug
B1300L-CE	PLUG UK	ASC55-UK with UK plug
B1300L-CA	PLUG USA	ASC55-USA/CA (115V) with USA/CANADA plug
B1300L-CT	PLUG AU/NZ	ASC55-AUS/NZ with AUSTRALIAN/NEW ZEALAND plug

MAIN APPLICATIONS - max section sqmm

Section sqmm	0.25±1.5	1.5±2.5	4±6	10	16	25	35	50	70	95	120	150	185	200	240	300	400	500	630	800	1000	
L.V. lugs and splices																						
Insulated terminals																						
"C" sleeve Connectors																						
H.V. lugs and splices																						

These tools are supplied without dies. For die selection, please refer to chart on pages 368 to 384

TECHNICAL FEATURES

Crimping force kN	132
Dimensions mm	
Length	471
Height	239
Width	102,5
Jaw Opening mm	42
Battery	18.0V 5.2Ah
Weight kg (with Battery)	8,0

STORAGE

Type	VAL-P44
Dimensions mm L x W x H	680 x 473 x 151
Weight kg	3,7
Supplied with the tool	✓



The B1300L-C version, featuring a large 42 mm jaw opening, for an easier introduction/removal of large size compression terminations and joints.

B1300L-C is suitable for a wide range of connectors up to 400 sqmm using die sets common to the CEMBRE 130 kN tooling range. Equipped with Li-Ion 18.0V - 5.2Ah rechargeable high capacity batteries.

The OLED display provides essential real time operating data, including:

- generated crimping force thus verifying accordance with best practice
- battery charge status
- general operating information
- the number of work cycles completed and remaining before recommended maintenance.

The tool is supplied as:

- Basic tool with battery and shoulder strap
- Spare battery
- Battery charger
- USB cable
- Plastic carrying case suitable for storing the tool and 12 die sets



B1300L-C-KV version also available for Power Supply Companies

18.0 V CORDLESS HYDRAULIC CRIMPING TOOL

general features

MAIN APPLICATIONS - max section sqmm

Section sqmm	0.25÷1.5	1.5÷2.5	4÷6	10	16	25	35	50	70	95	120	150	185	200	240	300	400	500	630	800	1000	
L.V. lugs and splices																						
Insulated terminals																						
"C" sleeve Connectors																						
Alu lugs and splices																						
H.V. lugs and splices																						

These tools are supplied without dies. For die selection, please refer to chart on pages 368 to 384

TECHNICAL FEATURES

Crimping force kN	132
Dimensions mm	
Length	423
Height	239
Width	102,5
Battery	18.0V 5.2Ah
Weight kg (with Battery)	6,5



STORAGE

Type	VAL-P44
Dimensions mm L x W x H	680 x 473 x 151
Weight kg	3,7
Supplied with the tool	✓



The tool is supplied as:

- Basic tool with battery and shoulder strap
- Spare battery
- Battery charger
- USB cable
- Plastic carrying case suitable for storing the tool and 12 die sets

STORAGE

Type	VAL-130*
Dimensions mm L x W x H	360 x 280 x 48
Weight kg	3,0
Purchase separately	✓

*Suitable for the storage of accessories for crimping Aluminium connectors



VAL-130

B1300-UC

Tool Type	Plug Type	Supplied Battery Charger Type
B1300-UC	PLUG EU	ASC55-EU with EUROPEAN plug
B1300-UCB	PLUG UK	ASC55-UK with UK plug
B1300-UCA	PLUG USA	ASC55-USA/CA (115V) with USA/CANADA plug
B1300-UCT	PLUG NZ AUS	ASC55-AUS/NZ with AUSTRALIAN/NEW ZEALAND plug



B1300-UC will accept the accessories for performing the "Deep Stepped Indent" system of crimping on Aluminium cables.

The B1300-UC will accept all semi-circular slotted dies, common to most 12 tons tools (U dies).

Equipped with Li-Ion 18.0V - 5.2Ah rechargeable high capacity batteries.

The OLED display provides essential real time operating data, including:

- generated crimping force thus verifying accordance with best practice
- battery charge status
- general operating information
- the number of work cycles completed and remaining before recommended maintenance.

B-TC250ND

18.0 V CORDLESS HYDRAULIC CUTTING TOOL

overhead line application

MAIN APPLICATIONS

specifically designed to cut Copper, aldrej, Aluminium, Aluminium-Steel cables and Steel ropes, Aluminium and Steel rods having Ø max 25 mm

Tool Type	Plug Type	Supplied Battery Charger Type
B-TC250ND	PLUG EU	ASC55-EU with EUROPEAN plug
B-TC250NDE	PLUG UK	ASC55-UK with UK plug
B-TC250YNDA	PLUG USA/CA	ASC55-USA/CA (115V) with USA/CANADA plug
B-TC250NDT B-TC250YNDT	PLUG AUS/NZ	ASC55-AUS/NZ with AUSTRALIAN/NEW ZEALAND plug



TECHNICAL FEATURES

Max cutting Ø mm	25
Dimensions mm	
Length	401
Height	126
Width	79
Battery	18.0V 2.0Ah
Weight kg (with Battery)	3,5

STORAGE

Type	VAL-P22
Dimensions mm L x W x H	465 x 315 x 116
Weight kg	1,5
Supplied with the tool	✓



The tool is supplied as:

- Basic tool with battery and wrist strap
- Spare battery
- Battery charger
- USB cable
- Plastic carrying case suitable for storing the tool and accessories

B-TC250ND is a new generation of hand-held cordless tools, characterised by a "Bilinear" mechanical design.

B-TC250ND is specifically designed to cut Copper, aldrej, Aluminium, Aluminium-Steel cables and Steel ropes, Aluminium and Steel rods having a max overall diameter of 25 mm.

The blades are manufactured from high strength special Steel, heat treated to ensure a long service life. New Li-Ion 18.0V - 2.0Ah batteries offer a higher capacity, while greater cutting speed and cutting force result from a revitalised hydraulic system with double speed action.

The battery is equipped with led indicators that indicate the remaining battery life at any time by pressing the adjacent button.

Quieter operation, illumination of the working area via LED lights and a minimum of vibration enhance the tool's practicality. Two batteries and charger included.

Same charger of all our tools. Operating temperature: -15 to +50 °C

CUTTING CAPACITY - a few examples

	MATERIAL	TENSILE STRENGTH (daN/mm ²)	MAX CUTTING DIAMETER (mm)		
			B-TC250ND B-TC250YNDA	B-TC250NDE B-TC250NDT	B-TC250YNDT
ROPE & CONDUCTORS	COPPER	≤ 41	25		
	ALUMINIUM	≤ 20	25		
	ALMELEC	≤ 34	25		
	STEEL	≤ 180	INDICATIVE EXAMPLES: 7 x 3,0 : Ø est. = 9,0 mm 19 x 2,1 : Ø est. = 10,5 mm 19 x 2,3 : Ø est. = 11,5 mm		
	MULTI STRANDS STEEL (STRANDS Qty ≥ 200)	≤ 180	18		
	ACSR	≤ 180	25 INDICATIVE EXAMPLES: 26 x 2,50 + 7 x 1,95 : Ø est. = 15,85 26 x 3,06 + 7 x 2,38 : Ø est. = 19,38 26 x 3,60 + 7 x 2,80 : Ø est. = 22,80		
RODS	STEEL	≤ 60	13		
		≤ 42	16		
	COPPER	≤ 30	20		
		≤ 25	23		
	ALUMINIUM	≤ 16	25		

18.0 V CORDLESS HYDRAULIC CUTTING TOOL

overhead line application

MAIN APPLICATIONS

specifically designed to cut Copper, aldrej, Aluminium, Aluminium-Steel cables and Steel ropes, Aluminium and Steel rods having Ø max 32 mm

TECHNICAL FEATURES

Max cutting Ø mm	32
Dimensions mm	
Length	443
Height	126
Width	79
Battery	18.0V 2.0Ah
Weight kg (with Battery)	3,95

STORAGE

Type	VAL-MX1
Dimensions mm L x W x H	596 x 396 x 185
Weight kg	4,6
Supplied with the tool	✓



The tool is supplied as:

- Basic tool with battery and wrist strap
- Spare battery
- Battery charger
- USB cable
- Plastic carrying case suitable for storing the tool and accessories



CUTTING CAPACITY - a few examples

Section mm ²	Ø mm	Stranding	Cable Type
120	13,3 mm	-	RIM120
50	8,9	7 x 2,95 mm	Bronze
70	10,3	19 x 2,06 mm	Bronze
95	12,5	19 x 2,50 mm	Bronze
70	10,7	19/2,14	Aluminium
95	12,5	19/2,5	Aluminium
150	15,75	37/2,25	Aluminium
323	23,25	19/4,65	Aluminium
415	-	37/3,78	Aluminium
35/6	8,1	6/2,70 + 1/2,70	Aluminium-steel
50/8	9,6	6/3,20 + 1/3,20	Aluminium-steel
50/30	11,7	12/2,33 + 7/2,33	Aluminium-steel
70/12	11,6	26/1,85 + 7/1,44	Aluminium-steel
95/15	13,4	26/2,15 + 7/1,67	Aluminium-steel
150/25	17,3	26/2,70 + 7/2,10	Aluminium-steel
170/40	18,95	30/2,79 + 7/2,79	Aluminium-steel
185/30	19,0	26/3,00 + 7/2,33	Aluminium-steel
230/30	21,0	24/3,5 + 7/2,33	Aluminium-steel
240/40	21,9	26/3,45 + 7/2,68	Aluminium-steel
495/35	29,9	45/3,74 + 7/2,49	Aluminium-steel
297,7 (OSPREY)	22,33	18/4,47 + 1/4,47	Aluminium-steel
327,9 (DOVE)	23,55	26/3,72 + 7/2,84	Aluminium-steel
239	20,1	37/2,87	Rope Aluminium Alloy
50	11,0	Class 5	Aluminium flex
95	18,5 mm	-	Steel flex
153	16,0	19/3,2	Cu
70	19,5	2214/0,2	Cu extra flex
16	9,0	126/0,4	Cu flex
120	19,9	608/0,5	Cu flex
240	-	1221/0,5	Cu flex

B-TC320ND

Tool Type	Plug Type	Supplied Battery Charger Type
B-TC320ND	PLUG EU	ASC55-EU with EUROPEAN plug
B-TC320NDE	PLUG UK	ASC55-UK with UK plug
B-TC320NDA	PLUG USA CAN	ASC55-USA/CA (115V) with USA/CANADA plug
B-TC320NDT	PLUG AUZ NZ	ASC55-AUS/NZ with AUSTRALIAN/NEW ZEALAND plug



B-TC320ND is a new generation of hand-held cordless tools, characterised by a "Bilinear" mechanical design.

B-TC320ND is specifically designed to cut Copper, aldrej, Aluminium, Aluminium-Steel cables and Steel ropes, Aluminium and Steel rods having a max overall diameter of 32 mm.

The blades are manufactured from high strength special Steel, heat treated to ensure a long service life. New Li-Ion 18.0V - 2.0Ah batteries offer a higher capacity, while greater cutting speed and cutting force result from a revitalised hydraulic system with double speed action.

The battery is equipped with led indicators that indicate the remaining battery life at any time by pressing the adjacent button. Quieter operation, illumination of the working area via LED lights and a minimum of vibration enhance the tool's practicality.

Two batteries and charger included.

Same charger of all our tools.

Operating temperature:

-15 to +50 °C

B-TC250

18.0 V CORDLESS HYDRAULIC CUTTING TOOL

overhead line application

MAIN APPLICATIONS

specifically designed to cut Copper, aldrej, Aluminium, Aluminium-Steel cables and Steel ropes, Aluminium and Steel rods having Ø max 25 mm

Tool Type	Plug Type	Supplied Battery Charger Type
B-TC250	PLUG EU	ASC55-EU with EUROPEAN plug
B-TC250E	PLUG UK	ASC55-UK with UK plug
B-TC250YA	PLUG USA CAN	ASC55-USA/CA (115V) with USA/CANADA plug
B-TC250T	PLUG AUS NZ	ASC55-AUS/NZ with AUSTRALIAN/NEW ZEALAND plug



TECHNICAL FEATURES

Max cutting Ø mm	25
Dimensions mm	
Length	300
Height	337
Width	83
Battery	18.0V 5.2Ah
Weight kg (with Battery)	4,65

STORAGE

Type	VAL-P40
Dimensions mm L x W x H	520 x 432 x 126
Weight kg	2,6
Supplied with the tool	✓



The tool is supplied as:

- Basic tool with battery and shoulder strap
- Spare battery
- Battery charger
- USB cable
- Plastic carrying case suitable for storing the tool and accessories

Next generation of 18.0 V cordless hydraulic cutting tool specifically designed to cut Copper, aldrej, Aluminium, Aluminium-Steel cables and Steel ropes, Aluminium and Steel rods having a max overall diameter of 25 mm.

The blades are manufactured from high strength special Steel, heat treated to ensure a long service life.

New Li-Ion 18.0V - 5.2Ah batteries offer a higher capacity, while greater cutting speed and cutting force result from a revitalised hydraulic system with double speed action.

The battery is equipped with LED indicators to show the remaining battery life at any time by pressing the adjacent button.

The head can rotate through 180 degrees, to enable the operator to work in the most comfortable position, and can easily be opened to allow cutting of running cables. Rubber grip inserts, low noise and minimal vibration aid operator comfort while additional convenience and safety are provided by LED lighting of the working area. Operating temperature: -15 to +50 °C

CUTTING CAPACITY - a few examples

MATERIAL	TENSILE STRENGTH (daN/mm ²)	MAX CUTTING DIAMETER (mm)	
		B-TC250 B-TC250YA	B-TC250E B-TC250T
ROPE & CONDUCTORS	COPPER	≤ 41	25
	ALUMINIUM	≤ 20	25
	ALMELEC	≤ 34	25
	STEEL	≤ 180	INDICATIVE EXAMPLES: 7 x 3,0 : Ø est. = 9,0 mm 19 x 2,1 : Ø est. = 10,5 mm 19 x 2,3 : Ø est. = 11,5 mm
	MULTI STRANDS STEEL (STRANDS Qty ≥ 200)	≤ 180	18
	ACSR	≤ 180	25 INDICATIVE EXAMPLES: 26 x 2,50 + 7 x 1,95 : Ø est. = 15,85 26 x 3,06 + 7 x 2,38 : Ø est. = 19,38 26 x 3,60 + 7 x 2,80 : Ø est. = 22,80
RODS	STEEL	≤ 60	13
		≤ 42	16
	COPPER	≤ 30	20
		≤ 25	23
ALUMINIUM	≤ 16	25	

18.0 V CORDLESS HYDRAULIC CUTTING TOOL

overhead line application

B-TC450

MAIN APPLICATIONS

specifically designed to cut Copper, aldrej, Aluminium, Aluminium-Steel cables and Steel ropes, Aluminium and Steel rods having Ø max 45 mm

TECHNICAL FEATURES

Max cutting Ø mm	45
Dimensions mm	
Length	407
Height	401
Width	88
Battery	18.0V 5.2Ah
Weight kg (with Battery)	6,7

STORAGE

Type	VAL-P40
Dimensions mm L x W x H	520 x 432 x 126
Weight kg	2,6
Supplied with the tool	✓



The tool is supplied as:

- Basic tool with battery and shoulder strap
- Spare battery
- Battery charger
- USB cable
- Plastic carrying case suitable for storing the tool and accessories

Tool Type	Plug Type	Supplied Battery Charger Type
B-TC450	PLUG EU	ASC55-EU with EUROPEAN plug
B-TC450E	PLUG UK	ASC55-UK with UK plug
B-TC450A	PLUG USA/CA	ASC55-USA/CA (115V) with USA/CANADA plug



CUTTING CAPACITY - a few examples

	MATERIAL	TENSILE STRENGTH (daN/mm ²)	MAX CUTTING DIAMETER (mm)	
			B-TC450	B-TC450E B-TC450A
ROPE & CONDUCTORS	COPPER	≤ 41	45	
	ALUMINIUM	≤ 20	45	
	ALMELEC	≤ 34	45	
	STEEL	≤ 180	INDICATIVE EXAMPLES: 7 x 3,0 : Ø est. = 9,0 mm 19 x 2,1 : Ø est. = 10,5 mm 19 x 2,3 : Ø est. = 11,5 mm	
	MULTI STRANDS STEEL (STRANDS Qty ≥ 200)	≤ 180	18	
RODS	ACSR	≤ 180	45 INDICATIVE EXAMPLES: 26 x 2,50 + 7 x 1,95 : Ø est. = 15,85 26 x 3,06 + 7 x 2,38 : Ø est. = 19,38 26 x 3,60 + 7 x 2,80 : Ø est. = 22,80 54 x 3,50 + 19 x 2,10 : Ø est. = 31,50 54 x 4,36 + 19 x 2,62 : Ø est. = 39,20	
	STEEL	≤ 60	18	
		≤ 42	20	
	COPPER	≤ 30	30	
		≤ 25	32	
	ALUMINIUM	≤ 16	45	

Next generation of 18.0 V cordless hydraulic cutting tool specifically designed to cut Copper, aldrej, Aluminium, Aluminium-Steel cables and Steel ropes, Aluminium and Steel rods having a max overall diameter of 45 mm.

The blades are manufactured from high strength special Steel, heat treated to ensure a long service life.

New Li-Ion 18.0V - 5.2Ah batteries offer a higher capacity, while greater cutting speed and cutting force result from a revitalised hydraulic system with double speed action.

The battery is equipped with LED indicators to show the remaining battery life at any time by pressing the adjacent button.

The head can rotate through 180 degrees, to enable the operator to work in the most comfortable position, and can easily be opened to allow cutting of running cables.

Rubber grip inserts, low noise and minimal vibration aid operator comfort while additional convenience and safety are provided by LED lighting of the working area.

Operating temperature:

-15 to +50 °C

B-TC500Y

18.0 V CORDLESS HYDRAULIC CUTTING TOOL

overhead line application

MAIN APPLICATIONS

specifically designed to cut Copper, Aluminum, Aluminum-Steel cables (ACSR) having Ø max 50 mm

Not suitable for cutting stay wire, Steel rope or earthing rod

Tool Type	Plug Type	Supplied Battery Charger Type
B-TC500Y	PLUG EU	ASC55-EU with EUROPEAN plug
B-TC500YE	PLUG UK	ASC55-UK with UK plug
B-TC500YA	PLUG USA	ASC55-USA/CA (115V) with USA/CANADA plug



TECHNICAL FEATURES

Max cutting Ø mm	50
Dimensions mm	
Length	405
Height	398
Width	83
Battery	18.0V 5.2Ah
Weight kg (with Battery)	5,8

STORAGE

Type	VAL-P40
Dimensions mm L x W x H	520 x 432 x 126
Weight kg	2,6
Supplied with the tool	✓



The tool is supplied as:

- Basic tool with battery and shoulder strap
- Spare battery
- Battery charger
- USB cable
- Plastic carrying case suitable for storing the tool and accessories

Next generation of 18.0 V cordless hydraulic cutting tool specifically designed to cut Copper, Aluminum, Aluminum-Steel cables (ACSR) having a max overall diameter of 50 mm. The blades are manufactured from high strength special Steel, heat treated to ensure a long service life.

New Li-Ion 18.0V - 5.2Ah batteries offer a higher capacity, while greater cutting speed and cutting force result from a revitalised hydraulic system with double speed action.

The battery is equipped with LED indicators to show the remaining battery life at any time by pressing the adjacent button.

The head can rotate through 90 degrees, to enable the operator to work in the most comfortable position, and can easily be opened to allow cutting of running cables.

Rubber grip inserts, low noise and minimal vibration aid operator comfort while additional convenience and safety are provided by LED lighting of the working area.

Operating temperature:
-15 to +50 ° C

18.0 V CORDLESS HYDRAULIC CUTTING TOOL

overhead line application

B-TC550

MAIN APPLICATIONS

specifically designed to cut Copper, Aldey, Aluminium, Aluminium-Steel cables and Steel ropes, Aluminium and Steel rods having Ø max 55 mm

TECHNICAL FEATURES

Max cutting Ø mm	55
Dimensions mm	
Length	441
Height	424
Width	87
Battery	18.0V 5.2Ah
Weight kg (with Battery)	8,9

STORAGE

Type	VAL-P40
Dimensions mm L x W x H	520 x 432 x 126
Weight kg	2,6
Supplied with the tool	✓



The tool is supplied as:

- Basic tool with battery and shoulder strap
- Spare battery
- Battery charger
- USB cable
- Plastic carrying case suitable for storing the tool and accessories

CUTTING CAPACITY - a few examples

	MATERIAL	TENSILE STRENGTH (daN/mm ²)	MAX CUTTING DIAMETER (mm)	
			B-TC550 B-TC550A	B-TC550E B-TC550T
ROPE & CONDUCTORS	COPPER	≤ 41	55	
	ALUMINIUM	≤ 20	55	
	ALMELEC	≤ 34	55	
	STEEL	≤ 180	INDICATIVE EXAMPLES: 7 x 3,0 : Ø est. = 9,0 mm 19 x 2,1 : Ø est. = 10,5 mm 19 x 2,3 : Ø est. = 11,5 mm	
	MULTI STRANDS STEEL (STRANDS Qty ≥ 200)	≤ 180	22	
	ACSR	≤ 180	50 INDICATIVE EXAMPLES: 26 x 2,50 + 7 x 1,95 : Ø est. = 15,85 26 x 3,06 + 7 x 2,38 : Ø est. = 19,38 26 x 3,60 + 7 x 2,80 : Ø est. = 22,80 26 x 4,44 + 7 x 3,45 : Ø est. = 28,14 54 x 3,50 + 19 x 2,10 : Ø est. = 31,50 54 x 4,36 + 19 x 2,62 : Ø est. = 39,20 83 x 4,60 + 16 x 2,80 : Ø est. = 50,00	
	GUY WIRE (GW15-9/16-188)	Extra high strength grade	7 x 4,77 : Ø est. = 14,30 mm	
RODS	STEEL	≤ 60	20	
		≤ 42	22	
	COPPER	≤ 30	34	
		≤ 25	38,5	
	ALUMINIUM	≤ 16	50	

Tool Type	Plug Type	Supplied Battery Charger Type
B-TC550	PLUG EU	ASC55-EU with EUROPEAN plug
B-TC550E	PLUG UK	ASC55-UK with UK plug
B-TC550A	PLUG USA	ASC55-USA/CA (115V) with USA/CANADA plug
B-TC550T	PLUG AUZ	ASC55-AUS/NZ with AUSTRALIAN/NEW ZEALAND plug



Next generation of 18.0 V cordless hydraulic cutting tool. Specifically designed to cut Copper, Aldey, Aluminium, Aluminium-Steel cables and Steel ropes, Aluminium and Steel rods having a max overall diameter of 55 mm.

The blades are manufactured from high strength special Steel, heat treated to ensure a long service life.

New Li-Ion 18.0V - 5.2Ah batteries offer a higher capacity, while greater cutting speed and cutting force result from a revitalised hydraulic system with double speed action. The battery is equipped with LED indicators to show the remaining battery life at any time by pressing the adjacent button.

The head can rotate through 330 degrees, to enable the operator to work in the most comfortable position, and can easily be opened to allow cutting of running cables.

Rubber grip inserts, low noise and minimal vibration aid operator comfort while additional convenience and safety are provided by LED lighting of the working area. Operating temperature:

-15 to +50 °C

B-TC320NDF



Tool Type	Plug Type	Supplied Battery Charger Type
B-TC320NDF	PLUG EU	ASC55-EU with EUROPEAN plug
B-TC320NDFE	PLUG UK	ASC55-UK with UK plug
B-TC320NDFEA	PLUG USA/CA	ASC55-USA/CA (115V) with USA/CANADA plug
B-TC320NDFET	PLUG AUS/NZ	ASC55-AUS/NZ with AUSTRALIAN/NEW ZEALAND plug



18.0 V CORDLESS HYDRAULIC CUTTING TOOL

industrial application

MAIN APPLICATIONS

specifically designed to cut Copper, Aluminium and Telecommunications cable having Ø max 32 mm

B-TC320NDF is a new generation of hand-held cordless tools, characterised by a "Bilinear" mechanical design. Specifically designed to cut Copper, Aluminium and telecommunication cable having a max overall diameter of 32 mm.

The blades are manufactured from high strength special Steel, heat treated to ensure a long service life.

The tool is supplied as:

- Basic tool with battery and wrist strap
- Spare battery
- Battery charger
- USB cable
- Plastic carrying case suitable for storing the tool and accessories

TECHNICAL FEATURES

Max cutting Ø mm	32
Dimensions mm	
Length	443
Height	126
Width	79
Battery	18.0V 2.0Ah
Weight kg (with Battery)	4,0

STORAGE

Type	VAL-M/X1
Dimensions mm L x W x H	596 x 396 x 185
Weight kg	4,6
Supplied with the tool	✓



B-TC400ND-SC



Tool Type	Plug Type	Supplied Battery Charger Type
B-TC400ND-SC	PLUG EU	ASC55-EU with EUROPEAN plug
B-TC400ND-SCE	PLUG UK	ASC55-UK with UK plug
B-TC400ND-SCA	PLUG USA/CA	ASC55-USA/CA (115V) with USA/CANADA plug



18.0 V CORDLESS HYDRAULIC CUTTING TOOL

industrial application

MAIN APPLICATIONS

specifically designed to cut Copper, Aluminium and Telecommunications cable having Ø max 40 mm

B-TC400ND-SC is a new generation of hand-held cordless tools, characterised by a "Bilinear" mechanical design. Specifically designed to cut Copper, Aluminium and telecommunication cable having a max overall diameter of 40 mm.

The blades are manufactured from high strength special Steel, heat treated to ensure a long service life.

The tool is supplied as:

- Basic tool with battery and wrist strap
- Spare battery
- Battery charger
- USB cable
- Plastic carrying case suitable for storing the tool and accessories

TECHNICAL FEATURES

Max cutting Ø mm	40
Dimensions mm	
Length	466
Height	111
Width	80
Battery	18.0V 2.0Ah
Weight kg (with Battery)	3,55

STORAGE

Type	VAL-M/X1
Dimensions mm L x W x H	596 x 396 x 185
Weight kg	4,6
Supplied with the tool	✓



18.0 V CORDLESS HYDRAULIC CUTTING TOOL

industrial application

MAIN APPLICATIONS

specifically designed to cut Copper, Aluminium and Telecommunications cable having Ø max 52,5 mm

TECHNICAL FEATURES

Max cutting Ø mm	52,5
Dimensions mm	
Length	529
Height	135
Width	79
Battery	18.0V 2.0Ah
Weight kg (with Battery)	3,91



STORAGE

Type	VAL-M/X1
Dimensions mm L x W x H	596 x 396 x 185
Weight kg	4,6
Supplied with the tool	✓



The tool is supplied as:

- Basic tool with battery and wrist strap
- Spare battery
- Battery charger
- USB cable
- Plastic carrying case suitable for storing the tool and accessories



B-TC500ND-SC

Tool Type	Plug Type	Supplied Battery Charger Type
B-TC500ND-SC	PLUG EU	ASC55-EU with EUROPEAN plug
B-TC500ND-SCE	PLUG UK	ASC55-UK with UK plug
B-TC500ND-SCA	PLUG USA CAN	ASC55-USA/CA (115V) with USA/CANADA plug
B-TC500ND-SCT	PLUG AUZ	ASC55-AUS/NZ with AUSTRALIAN/NEW ZEALAND plug



B-TC500ND-SC is a new generation of hand-held cordless tools, characterised by a "Bilinear" mechanical design.

B-TC500ND-SC is specifically designed to cut Copper, Aluminium and telecommunication cable having a max overall diameter of 52,5 mm.

The blades are manufactured from high strength special Steel, heat treated to ensure a long service life. New Li-Ion 18.0V - 2.0Ah batteries offer a higher capacity, while greater cutting speed and cutting force result from a revitalised hydraulic system with double speed action.

The battery is equipped with led indicators that indicate the remaining battery life at any time by pressing the adjacent button.

The head can rotate through 180 degrees, to enable the operator to work in the most comfortable position, and can easily be opened to allow cutting of running cables.

Quieter operation, illumination of the working area via LED lights and a minimum of vibration enhance the tool's practicality.

Two batteries and charger included.

Same charger of all our tools.

Operating temperature:

-15 to +50 °C

B-TC500

18.0 V CORDLESS HYDRAULIC CUTTING TOOL

industrial application

MAIN APPLICATIONS

specifically designed to cut Copper, Aluminium and Telecommunications cable having Ø max 50 mm

Tool Type	Plug Type	Supplied Battery Charger Type
B-TC500	PLUG EU	ASC55-EU with EUROPEAN plug
B-TC500E	PLUG UK	ASC55-UK with UK plug
B-TC500A	PLUG USA CAN	ASC55-USA/CA (115V) with USA/CANADA plug
B-TC500T	PLUG AUS NZ	ASC55-AUS/NZ with AUSTRALIAN/NEW ZEALAND plug



TECHNICAL FEATURES

Max cutting Ø mm	50
Dimensions mm	
Length	405
Height	398
Width	83
Battery	18.0V 5.2Ah
Weight kg (with Battery)	5,8

STORAGE

Type	VAL-P40
Dimensions mm L x W x H	520 x 432 x 126
Weight kg	2,6
Supplied with the tool	✓



The tool is supplied as:

- Basic tool with battery and shoulder strap
- Spare battery
- Battery charger
- USB cable
- Plastic carrying case suitable for storing the tool and accessories

Next generation of 18.0 V cordless hydraulic cutting tool specifically designed to cut Copper, Aluminium and telecommunication cable having a max overall diameter of 50 mm.

The blades are manufactured from high strength special Steel, heat treated to ensure a long service life.

New Li-Ion 18.0V - 5.2Ah batteries offer a higher capacity, while greater cutting speed and cutting force result from a revitalised hydraulic system with double speed action.

The battery is equipped with LED indicators to show the remaining battery life at any time by pressing the adjacent button.

The head can rotate through 90 degrees, to enable the operator to work in the most comfortable position, and can easily be opened to allow cutting of running cables.

Rubber grip inserts, low noise and minimal vibration aid operator comfort while additional convenience and safety are provided by LED lighting of the working area.

Operating temperature: -15 to +50 °C

18.0 V CORDLESS HYDRAULIC CUTTING TOOL

industrial application

B-TC650

MAIN APPLICATIONS

specifically designed to cut Copper, Aluminium and Telecommunications cable having Ø max 65 mm



TECHNICAL FEATURES

Max cutting Ø mm	65
Dimensions mm	
Length	429
Height	415
Width	83
Battery	18.0V 5.2Ah
Weight kg (with Battery)	6,4



STORAGE

Type	VAL-P40
Dimensions mm L x W x H	520 x 432 x 126
Weight kg	2,6
Supplied with the tool	✓



The tool is supplied as:

- Basic tool with battery and shoulder strap
- Spare battery
- Battery charger
- USB cable
- Plastic carrying case suitable for storing the tool and accessories

Tool Type	Plug Type	Supplied Battery Charger Type
B-TC650	PLUG EU	ASC55-EU with EUROPEAN plug
B-TC650E	PLUG UK	ASC55-UK with UK plug
B-TC650A	PLUG USA CAN	ASC55-USA/CA (115V) with USA/CANADA plug
B-TC650T	PLUG A NZ AUS	ASC55-AUS/NZ with AUSTRALIAN/NEW ZEALAND plug



Next generation of 18.0 V cordless hydraulic cutting tool specifically designed to cut Copper, Aluminium and telecommunication cable having a max overall diameter of 65 mm.

The blades are manufactured from high strength special Steel, heat treated to ensure a long service life.

New Li-Ion 18.0V - 5.2Ah batteries offer a higher capacity, while greater cutting speed and cutting force result from a revitalised hydraulic system with double speed action. The battery is equipped with LED indicators to show the remaining battery life at any time by pressing the adjacent button.

The head can rotate through 335 degrees, to enable the operator to work in the most comfortable position, and can easily be opened to allow cutting of running cables.

Rubber grip inserts, low noise and minimal vibration aid operator comfort while additional convenience and safety are provided by LED lighting of the working area.

Operating temperature:

-15 to +50 °C

B-TC650-SC

18.0 V CORDLESS HYDRAULIC CUTTING TOOL

industrial application

MAIN APPLICATIONS

specifically designed to cut Copper, Aluminium and Telecommunications cable having Ø max 65 mm

Tool Type	Plug Type	Supplied Battery Charger Type
B-TC650-SC	PLUG EU	ASC55-EU with EUROPEAN plug
B-TC650-SCE	PLUG UK	ASC55-UK with UK plug
B-TC650-SCA	PLUG USA CAN	ASC55-USA/CA (115V) with USA/CANADA plug
B-TC650-SCT	PLUG AUS NZ	ASC55-AUS/NZ with AUSTRALIAN/NEW ZEALAND plug



TECHNICAL FEATURES

Max cutting Ø mm	65
Dimensions mm	
Length	503
Height	464
Width	105
Battery	18.0V 5.2Ah
Weight kg (with Battery)	7,7

STORAGE

Type	VAL-B-TC950
Dimensions mm L x W x H	565 x 410 x 132
Weight kg	6,7
Supplied with the tool	✓

Next generation of 18.0 V cordless hydraulic cutting tool specifically designed to cut Copper, Aluminium and telecommunication cable having a max overall diameter of 65 mm.

The blades are manufactured from high strength special Steel, heat treated to ensure a long service life.

The open head and the "scissor" movement of the blades facilitate the cutting of running cables.

New Li-Ion 18.0V - 5.2Ah batteries offer a higher capacity, while greater cutting speed and cutting force result from a revitalised hydraulic system with double speed action.

The battery is equipped with LED indicators to show the remaining battery life at any time by pressing the adjacent button.

The head can rotate through 180 degrees, to enable the operator to work in the most comfortable position, and can easily be opened to allow cutting of running cables.

Rubber grip inserts, low noise and minimal vibration aid operator comfort while additional convenience and safety are provided by LED lighting of the working area.

Operating temperature: -15 to +50 °C



The tool is supplied as:

- Basic tool with battery and shoulder strap
- Spare battery
- Battery charger
- USB cable
- Metal carrying case suitable for storing the tool and accessories

18.0 V CORDLESS HYDRAULIC CUTTING TOOL

industrial application

B-TC950

MAIN APPLICATIONS

specifically designed to cut Copper, Aluminium and Telecommunications cable having Ø max 95 mm



TECHNICAL FEATURES

Max cutting Ø mm	95
Dimensions mm	
Length	518
Height	468
Width	83
Battery	18.0V 5.2Ah
Weight kg (with Battery)	7,8

STORAGE

Type	VAL-B-TC950
Dimensions mm L x W x H	565 x 410 x 132
Weight kg	6,7
Supplied with the tool	✓



The tool is supplied as:

- Basic tool with battery and shoulder strap
- Spare battery
- Battery charger
- USB cable
- Metal carrying case suitable for storing the tool and accessories

Tool Type	Plug Type	Supplied Battery Charger Type
B-TC950	PLUG EU	ASC55-EU with EUROPEAN plug
B-TC950E	PLUG UK	ASC55-UK with UK plug
B-TC950A	PLUG USA CAN	ASC55-USA/CA (115V) with USA/CANADA plug
B-TC950T	PLUG AUZ NZ	ASC55-AUS/NZ with AUSTRALIAN/NEW ZEALAND plug

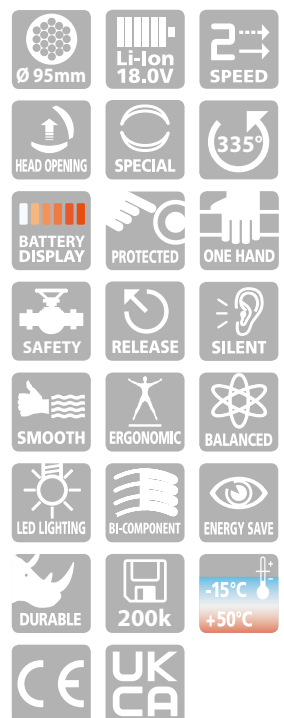

Next generation of 18.0 V cordless hydraulic cutting tool specifically designed to cut Copper, Aluminium and telecommunication cable having a max overall diameter of 95 mm.

The blades are manufactured from high strength special Steel, heat treated to ensure a long service life.

New Li-Ion 18.0V - 5.2Ah batteries offer a higher capacity, while greater cutting speed and cutting force result from a revitalised hydraulic system with double speed action.

The battery is equipped with LED indicators to show the remaining battery life at any time by pressing the adjacent button.

The head can rotate through 335 degrees, to enable the operator to work in the most comfortable position, and can easily be opened to allow cutting of running cables.

Rubber grip inserts, low noise and minimal vibration aid operator comfort while additional convenience and safety are provided by LED lighting of the working area.

Operating temperature:

-15 to +50 °C

B-TC4500

18.0 V CORDLESS HYDRAULIC CUTTING TOOL

overhead line application

MAIN APPLICATIONS

specifically designed to cut Copper, aldrej, Aluminium, Aluminium-Steel cables and Steel ropes, Aluminium and Steel rods having Ø max 45 mm

Tool Type	Plug Type	Supplied Battery Charger Type
B-TC4500	PLUG EU	ASC55-EU with EUROPEAN plug
B-TC4500E	PLUG UK	ASC55-UK with UK plug
B-TC4500A	PLUG USA/CA	ASC55-USA/CA (115V) with USA/CANADA plug
B-TC4500T	PLUG AU/NZ	ASC55-AUS/NZ with AUSTRALIAN/NEW ZEALAND plug



TECHNICAL FEATURES

Max cutting Ø mm	45
Dimensions mm	
Length	486
Height	239
Width	103
Battery	18.0V 5.2Ah
Weight kg (with Battery)	6,44

STORAGE

Type	VAL-P44
Dimensions mm L x W x H	680 x 473 x 151
Weight kg	3,7
Supplied with the tool	✓



The tool is supplied as:

- Basic tool with battery and shoulder strap
- Spare battery
- Battery charger
- USB cable
- Plastic carrying case suitable for storing the tool and accessories

Next generation of 18.0 V cordless hydraulic cutting tool specifically designed to cut Copper, aldrej, Aluminium, Aluminium-Steel cables and Steel ropes, Aluminium and Steel rods having a max overall diameter of 45 mm.

The blades are manufactured from high strength special Steel, heat treated to ensure a long service life.

New Li-Ion 18.0V - 5.2Ah batteries offer a higher capacity, while greater cutting speed and cutting force result from a revitalised hydraulic system with double speed action.

The battery is equipped with LED indicators to show the remaining battery life at any time by pressing the adjacent button.

The head can rotate through 180 degrees, to enable the operator to work in the most comfortable position, and can easily be opened to allow cutting of running cables. Rubber grip inserts, low noise and minimal vibration aid operator comfort while additional convenience and safety are provided by LED lighting of the working area. Operating temperature: -15 to +50 °C

CUTTING CAPACITY - a few examples

	MATERIAL	TENSILE STRENGTH (daN/mm ²)	MAX CUTTING DIAMETER (mm)
			B-TC4500
ROPE & CONDUCTORS	COPPER	≤ 41	45
	ALUMINIUM	≤ 20	45
	ALMELEC	≤ 34	45
	STEEL	≤ 180	INDICATIVE EXAMPLES: 7 x 3,0 : Ø est. = 9,0 mm 19 x 2,1 : Ø est. = 10,5 mm 19 x 2,3 : Ø est. = 11,5 mm
	MULTI STRANDS STEEL (STRANDS Qty ≥ 200)	≤ 180	18
RODS	ACSR	≤ 180	45 INDICATIVE EXAMPLES: 26 x 2,50 + 7 x 1,95 : Ø est. = 15,85 26 x 3,06 + 7 x 2,38 : Ø est. = 19,38 26 x 3,60 + 7 x 2,80 : Ø est. = 22,80 54 x 3,50 + 19 x 2,10 : Ø est. = 31,50 54 x 4,36 + 19 x 2,62 : Ø est. = 39,20
	STEEL	≤ 60	18
		≤ 42	20
	COPPER	≤ 30	30
		≤ 25	32
ALUMINIUM	≤ 16	45	

18.0 V CORDLESS HYDRAULIC FRAME-TYPE HOLE PUNCHING TOOL

B-FC470

general features

MAIN APPLICATIONS

specifically designed to punching holes from 15,5 up to 47,2 mm diameter

TECHNICAL FEATURES

Max hole punch Ø mm	47,2
Max centre of hole to edge of trunking (mm)	53,5
Dimensions mm	
Length	379
Height	346
Width	83
Battery	18.0V 5.2Ah
Weight kg (with Battery)	6,2

STORAGE

Type	VAL-FC470
Dimensions mm L x P	559 x 459 x 131
Weight kg	6,7
Supplied with the tool	✓



The tool is supplied as:

- Basic tool with battery and shoulder strap
- Spare battery
- Battery charger
- USB cable
- Metal carrying case suitable for storing the tool and accessories



Table denotes the punch/die set reference, for each hole size. Suitable for punching holes in mild Steel, fiberglass or plastic material, up to 2 mm thick.

Hole Dimensions					Maximum thickness of mild Steel (mm)	Type
Nominal		Pg	ISO	Inch		
Ø (mm)	Ø (inch)					
15,5	.610	Pg9	-	-	2	RD15.5SS-FC
16,2	.638	-	ISO-16	-		RD16.2SS-FC
17,5	.689	-	-	-		RD17.5SS-FC
18,8	.740	Pg11	-	-		RD18.8SS-FC
19,1	.752	-	-	-		RD19.1SS
20,5	.807	Pg 13,5	ISO-20	-		RD20.5SS
22,6	.890	Pg16	-	-		RD22.6SS
23,8	.937	-	-	5/8"		RD23.8SS
25,4	1.000	-	ISO-25	-		RD25.4SS
27,0	1.063	-	-	3/4"		RD27.5SS
28,5	1.122	Pg21	-	-		RD28.5SS
30,5	1.201	-	-	7/8"		RD30.5SS
31,8	1.252	-	-	-		RD31.8SS
32,5	1.279	-	ISO-32	-		RD32.5SS
34,6	1.362	-	-	-		RD34.6SS
37,2	1.464	Pg29	-	-		RD37.2SS
38,1	1.500	-	-	-		RD38.1SS
40,5	1.594	-	ISO-40	-		RD40.5SS-FC
41,3	1.626	-	-	-		RD41.3SS-FC
42,5	1.673	-	-	1 1/4"		RD42.5SS-FC
43,2	1.701	-	-	-		RD43.2SS-FC
44,5	1.752	-	-	-		RD44.5SS-FC
47,2	1.858	Pg36	-	-		RD47.2SS-FC

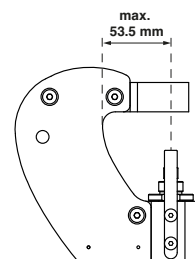

Tool Type	Plug Type	Supplied Battery Charger Type
B-FC470	PLUG EU	ASC55-EU with EUROPEAN plug
B-FC470E	PLUG UK	ASC55-UK with UK plug
B-FC470A	PLUG USA CAN	ASC55-USA/CA (115V) with USA/CANADA plug

Next generation of 18.0 V cordless hydraulic cutting tool specifically designed to punching holes from 15,5 up to 47,2 mm diameter in the side wall of trunking without the need for pre drilling.

New Li-Ion 18.0V - 5.2Ah batteries offer a higher capacity, while greater punch speed and punching force result from a revitalised hydraulic system with double speed action. The battery is equipped with led indicators that indicate the remaining battery life at any time by pressing the adjacent button. The head can rotate through 180 degrees, to enable the operator to work in the most comfortable position, and can easily be opened to allow cutting of running cables.

Rubber grip inserts, low noise and minimal vibration aid operator comfort while additional convenience and safety are provided by LED lighting of the working area.

Operating temperature:

-15 to +50 °C

Also available in the hand operated mechanical version MT-FC48N (see page 178).

B-FL750ND

18.0 V CORDLESS HYDRAULIC PULLER-TYPE HOLE PUNCHING TOOL

general features

Tool Type	Plug Type	Supplied Battery Charger Type
B-FL750ND	PLUG EU	ASC55-EU with EUROPEAN plug
B-FL750NDE	PLUG UK	ASC55-UK with UK plug
B-FL750NDA	PLUG USA CAN	ASC55-USA/CA (115V) with USA/CANADA plug
B-FL750NDT	PLUG AUS NZ	ASC55-AUS/NZ with AUSTRALIAN/NEW ZEALAND plug

MAIN APPLICATIONS

specifically designed for hole punching stainless Steel, mild Steel, fiberglass and plastic sheet materials up to 3,5 mm thickness



B-FL750ND is a new generation of hand-held cordless tools, characterised by a "Bilinear" mechanical design. B-FL750ND is specifically designed for hole punching stainless Steel, mild Steel, fiberglass and plastic sheet materials up to 3,5 mm thickness. New Li-Ion 18.0V - 2.0Ah batteries offer a higher capacity, while greater punch speed and punching force result from a revitalised hydraulic system with double speed action. The battery is equipped with LED indicators that indicate the remaining battery life at any time by pressing the adjacent button.

The balanced punching head pivots 180deg through a full 360deg rotation for ease of use in confined spaces.

Rubber grip inserts, low noise and minimal vibration aid operator comfort while additional convenience and safety are provided by LED lighting of the working area.

For the punch-die selection chart see page 343.

Operating temperature: -15 to +50 °C

TECHNICAL FEATURES

Max Punching Ø mm	140
Dimensions mm	
Length	467
Height	126
Width	79
Battery	18.0V 2.0Ah
Weight kg (with Battery)	4,1

STORAGE

Type	VAL-M/X1
Dimensions mm L x W x H	596 x 396 x 185
Weight kg	4,6
Supplied with the tool	✓



The tool is supplied as:

- Basic tool with battery and wrist strap
- Spare battery
- Battery charger
- USB cable
- Puller TD-11
- Puller TD-19
- Spiral bit Ø 11,5 mm
- Plastic carrying case suitable for storing the tool and accessories

KIT-B-FL750ND-1 KIT-B-FL750ND-3

The kit is supplied as:

- Basic tool with battery and wrist strap
- Spare battery (KIT-B-FL750ND-1)
- Battery charger
- USB cable
- Puller TD-11
- Puller TD-19
- Spiral bit Ø 11,5 mm
- Plastic carrying case suitable for storing the tool and accessories



KIT FOR HOLE PUNCHING

general features

KIT-B-FL750ND-1

Kit includes:

B-FL750ND cordless hydraulic puller-type hole punching tool

VAL-M/X1 plastic carrying case with accessories

Puller TD-11

Puller TD-19

spiral bit Ø 11,5 mm

4 KIT for round punch:

KIT-RD18.8SS Pg11

KIT-RD20.5SS Pg13.5 ISO20

KIT-RD22.6SS Pg16

KIT-RD28.5SS Pg21

KIT-B-FL750ND-3

Kit includes:

B-FL750ND cordless hydraulic puller-type hole punching tool

VAL-M/X1 plastic carrying case with accessories (1 battery)

Puller TD-11

Puller TD-19

spiral bit Ø 11,5 mm

4 KIT for round punch:

KIT-RD20.5SS Pg13.5 ISO20

KIT-RD22.6SS Pg16

KIT-RD25.4SS ISO-25

KIT-RD32.5SS ISO-32

18.0 V CORDLESS HYDRAULIC PULLER-TYPE HOLE PUNCHING TOOL

general features

MAIN APPLICATIONS

specifically designed for hole punching stainless Steel, mild Steel, fiberglass and plastic sheet materials up to 3,5 mm thickness

TECHNICAL FEATURES

Max Punching Ø mm	140
Dimensions mm	
Length	363
Height	366
Width	83
Battery	18.0V 5.2Ah
Weight kg (with Battery)	5,1

STORAGE

Type	VAL-P56
Dimensions mm L x W x H	690 x 446 x 179
Weight kg	5,5
Supplied with the tool	✓



The tool is supplied as:

- Basic tool with battery and shoulder strap
- Spare battery
- Battery charger; USB cable
- Puller TD-11; Puller TD-19
- Spiral bit Ø 11,5 mm
- Plastic carrying case suitable for storing the tool and accessories



Universal joint allows punching head to pivot 180deg over a full 360deg rotation.

B-FL750

Tool Type	Plug Type	Supplied Battery Charger Type
B-FL750	PLUG EU	ASC55-EU with EUROPEAN plug
B-FL750E	PLUG UK	ASC55-UK with UK plug
B-FL750A	PLUG USA CAN	ASC55-USA/CA (115V) with USA/CANADA plug
B-FL750T	PLUG NZ AUS	ASC55-AUS/NZ with AUSTRALIAN/NEW ZEALAND plug



Next generation of 18.0 V cordless hydraulic tool specifically designed for hole punching stainless Steel, mild Steel, fiberglass and plastic sheet materials up to 3,5 mm thickness. New Li-Ion 18.0V - 5.2Ah batteries offer a higher capacity than 14.4 V 3 Ah, while greater punch speed and punching force result from a revitalised hydraulic system with double speed action. The battery is equipped with LED indicators to show the remaining

battery life at any time by pressing the adjacent button.

The balanced punching head pivots 180deg through a full 360deg rotation for ease of use in confined spaces.

Rubber grip inserts, low noise and minimal vibration aid operator comfort while additional convenience and safety are provided by LED lighting of the working area.

For the punch-die selection chart see page 343.

Operating temperature: -15 to +50 ° C

KIT-B-FL750-1

KIT FOR HOLE PUNCHING

general features



TECHNICAL FEATURES

Max Punching Ø mm	140
Dimensions mm	
Length	363
Height	366
Width	83
Battery	18.0V 5.2Ah
Weight kg (with Battery)	5,1

STORAGE

Type	VAL-P56
Dimensions mm L x W x H	690 x 446 x 179
Weight kg	5,5
Supplied with the tool	✓



The tool is supplied as:

- Basic tool with battery and shoulder strap
- Spare battery
- Battery charger
- USB cable
- Puller TD-11, Puller TD-19
- Spiral bit Ø 11,5 mm
- Plastic carrying case suitable for storing the tool and accessories

KIT-B-FL750-1

Kit includes:

B-FL750 cordless hydraulic puller-type hole punching tool

VAL-P56 plastic carrying case with accessories

Puller TD-11

Puller TD-19

spiral bit Ø 11,5 mm

4 KIT for round punch:

KIT-RD18.8SS Pg11

KIT-RD20.5SS Pg13.5

KIT-RD22.6SS Pg16

KIT-RD28.5SS Pg21



PUNCHING ACCESSORIES AVAILABLE

for B-FL750ND, B-FL750 and KIT-B-FL750-1

Round punch

Hole diameter					Material max thickness (mm)		Pilot hole Ø (mm)	Type	
Nominal Ø (mm)	Ø (inch)	Pg	ISO	GAS	Stainless Steel	Mild Steel		KIT (Punch + Die)	Puller
15,5	.610	Pg9	-	-	2,5 mm (0.1 in.) Rm= 700 N/mm ²	3,5 mm (0.14 in.) Rm= 510 N/mm ²	KIT	TD-11	
16,2	.638	-	ISO-16	-					
17,0	.669	-	-	G3/8"					
17,5	.689	-	-	-					
18,8	.740	Pg11	-	-					
19,1	.752	-	-	-					
20,5	.807	Pg 13,5	ISO-20	-					
21,5	.846	-	-	G1/2"					
22,6	.890	Pg16	-	-					
23,8	.937	-	-	G5/8"					
25,4	1.000	-	ISO-25	-					
27,0	1.063	-	-	G3/4"					
28,5	1.122	Pg21	-	-					
30,5	1.201	-	-	G7/8"					
28,5	1.122	Pg 21	-	-	2,5 mm (0.1 in.) Rm= 700 N/mm ²	3,5 mm (0.14 in.) Rm= 510 N/mm ²	KIT	TD-19	
30,5	1.201	-	-	G7/8"					
31,8	1.252	-	-	-					
32,5	1.279	-	ISO-32	-					
34,0	1.338	-	-	G1"					
34,6	1.362	-	-	-					
37,2	1.464	Pg29	-	-					
38,1	1.500	-	-	-					
38,5	1.515	-	-	G1"1/8"					
40,5	1.594	-	ISO-40	-					
41,3	1.626	-	-	-					
42,5	1.673	-	-	G1"1/4"					
43,2	1.701	-	-	-					
44,5	1.752	-	-	-					
47,2	1.858	Pg36	-	-					
48,5	1.909	-	-	G1"1/2"					
50,5	1.988	-	ISO-50	-					
51,4	2.023	-	-	-					
52,4	2.063	-	-	-					
54,2	2.134	Pg42	-	G1"3/4"					
60,0	2.362	Pg48	-	G2"					
60,5	2.381	-	-	-					
64,0	2.520	-	ISO-63	-					
65,0	2.559	-	-	-					
76,0	2.992	-	-	G2"1/2"					
76,5	3.011	-	-	-					
80,5	3.169	-	-	-					
89,0	3.503	-	-	G3"					
90,0	3.543	-	-	-					
100,0	3.937	-	-	-					
102,0	4.015	-	-	-					
114,0	4.488	-	-	-					
120,0	4.724	-	-	-					
140,0	5.512	-	-	-					

Stainless Steel = Rm= 700 N/mm² - Mild Steel = Rm= 510 N/mm²

* Puller included in the kit



Square punch

Hole diameter		Material max thickness (mm)		Pilot hole Ø (mm)	Type	Application Cable Entry Frames
Nominal (mm)	(inch)	Stainless Steel	Mild Steel			
21,0 x 21,0	.827 x .827	2,5	3,5	12,0	RD21X21	-
43,0 X 43,0	1.693 x 1.693	1,5	2,0	26,5	RD43X43	9000.Q/9200.Q
46,0 x 46,0	1.811 x 1.811				RD46X46	-
68,0 x 68,0	2.677 x 2.677				RD68X68	-
92,0 x 92,0	3.622 x 3.622				RD92X92	-
126,0 x 126,0	4.960 x 4.960	1,0	1,5	28,5	RD126X126	-
138,0 x 138,0	5.433 x 5.433				RD138X138	-

Rectangular punch

Hole diameter		Material max thickness (mm)		Pilot hole Ø (mm)	Type	Application Cable Entry Frames
Nominal (mm)	(inch)	Stainless Steel	Mild Steel			
18,0 x 46,0	.709 x 1.811	2,0	2,0	16,5	RD18X46	-
22,0 x 30,0	.866 x 1.181				RD22X30	-
22,0 x 46,0	.866 x 1.811				RD22X46	-
24,0 x 43,0	.945 x 1.693				RD24X43	9000.R-2
24,0 x 65,0	.945 x 2.559				RD24x65	9000.R-3
24,0 x 86,0	.945 x 3.386				RD24X86	9000.R-4
24,0 x 112,0	.945 x 4.409				RD24X112	9000.R-5/9200.R5
29,0 x 71,0	1.141 x 2.795				RD29X71	-
35,0 x 65,0	1.377 x 2.559				RD35X65	-
35,0 x 86,0	1.377 x 3.385				RD35X86	-
35,0 x 112,0	1.377 x 4.409				RD35X112	-
36,0 x 46,0	1.417 x 1.811				RD36X46	-
36,0 x 65,0	1.417 x 2.559				RD36X65	9000.10
36,0 x 86,0	1.417 x 3.386				RD36X86	9000.16
36,0 x 112,0	1.417 x 4.409	RD36X112	9000.24/9200.24 9220.24			
37,0 x 54,0	1.456 x 2.125	RD37X54	-			
37,0 x 67,0	1.456 x 2.637	RD37X67	-			
37,0 x 88,0	1.456 x 3.464	RD37X88	-			
37,0 x 104,0	1.456 x 4.094	RD37X104	-			
37,0 x 115,0	1.456 x 4.527	RD37X115	-			
46,0 x 54,0	1.811 x 2.126	RD46X54	-			
46,0 x 65,0	1.811 x 2.559	RD46X65	9000.10			
46,0 x 72,0	1.811 x 2.835	RD46X72	-			
46,0 x 86,0	1.811 x 3.386	RD46X86	9000.16			
46,0 x 92,0	1.811 x 3.622	RD46X92	-			
46,0 x 107,0	1.811 x 4.212	RD46X107	-			
46,0 x 112,0	1.811 x 4.409	RD46X112	9000.24/9200.24			
50,0 x 98,0	1.968 x 3.858	RD50X98	-			
67,0 x 126,0	2.637 x 4.960	RD67X126	-			
72,0 x 136,0	2.834 x 5.354	RD72X136	-			

Stainless Steel = Rm= 700 N/mm² - Mild Steel = Rm= 510 N/mm²

"D" punch

Hole dimensions		Material max thickness (mm)		Pilot hole Ø (mm)	Type
Nominal (mm)	(inch)	Stainless Steel	Mild Steel		
(a)38,3 x (b)36,6	(a)1.507 x (b)1.442	2,5	3,5	18,5	RD 18D
(a)43,1 x (b)41,5	(a)1.696 x (b)1.632				RD 24D

Stainless Steel = Rm= 700 N/mm² - Mild Steel = Rm= 510 N/mm²

Use of non-CEMBRE punching accessories

Type	Punch & Die	Pilot hole Ø mm
TRD-9.4C (*)	GREENLEE 3/8" - 24 UNF	Ø 10.0
TRD-M11C (*)	BM, COSMEC (M11x1.5), IMB 9602	Ø 11.5
TD-M16C	BM, COSMEC (M16x1.5)	Ø 16.5
TD-27	BM, COSMEC (Ø105=Ø140)	Ø 27.5
TD-14X14-M14	BM, COSMEC 46x46	Ø 18.8
TD-120X20-M20	BM, COSMEC 92x92	Ø 27.5
TD-20X20-M20 (with plug)	BM, COSMEC 42x95	Ø 27.5
TGD-13.5X13.5-M13	BM, COSMEC 40x40; 45x45; 46x46 (M13)	Ø 18.8
TGD-10X10-M9	BM, COSMEC 006505	Ø 13.8
TD-9	IMB 9601	Ø 9.5
TD-16	IMB 9603	Ø 16.5
TD-10X10-M10 (with plug)	IMB 9623	Ø 14.5
TD-14X14-M14/1"	IMB 9625	Ø 19.5
TD-20 (without plug)	IMB 9626	Ø 27.5
TD-20X20-M20-C (with plug)	IMB 9626	Ø 27.5

(*) The washer supplied with the KIT must be threaded onto the draw stud and positioned between the head and the die to allow the die to rest correctly

B-TD270

18.0 V CORDLESS HYDRAULIC NUT SPLITTING TOOL

general features

Tool Type	Plug Type	Supplied Battery Charger Type
B-TD270	PLUG EU	ASC55-EU with EUROPEAN plug
B-TD270E	PLUG UK	ASC55-UK with UK plug
B-TD270A	PLUG USA	ASC55-USA/CA (115V) with USA/CANADA plug
B-TD270T	PLUG AUS	ASC55-AUS/NZ with AUSTRALIAN/NEW ZEALAND plug



B-TD270

Crimping force kN	100
Dimensions mm	
Length (with tube and head)	1.292,5
Height	350
Depth	83
Battery	18.0V 5.2Ah
Weight kg (with battery)	5,5

18.0 V battery operated hydraulic tool suitable for splitting fastening bushes, hexagonal and square nuts with spanner from 16 to 27 mm.



B-TD410T

Tool Type	Plug Type	Supplied Battery Charger Type
B-TD410T	PLUG EU	ASC55-EU with EUROPEAN plug
B-TD410TE	PLUG UK	ASC55-UK with UK plug
B-TD410TA	PLUG USA	ASC55-USA/CA (115V) with USA/CANADA plug
B-TD410T-T	PLUG AUS	ASC55-AUS/NZ with AUSTRALIAN/NEW ZEALAND plug



B-TD410T

Crimping force kN	230
Dimensions mm	
Length (with tube and head)	1.360
Height	350
Depth	83
Battery	18.0V 5.2Ah
Weight kg (with battery)	8,8

18.0 V battery operated hydraulic tool suitable for splitting fastening bushes, hexagonal and square nuts with spanner from 27 to 41 mm.



Application range

Type	HEXAGONAL NUTS		SQUARE NUTS	
	mm	Ø	mm	Ø
B-TD270	16	M 10	17	M 10
	17	M 10	19	M 12
	18	M 12	22	M 14
	19	M 12	24	M 16
	21	M 14	27	M 18
	22	M 14		
	24	M 16		
B-TD410T	27	M 18	27	M 18
	27	M 18	27	M 18
	30	M 20	30	M 20
	32	M 22	32	M 22
	34	M 22	34	M 24
	36	M 24	36	M 27
	41	M 27		

STORAGE

Type	CVB-030
Dimensions mm L x W x H	497 x 266 x 455
Weight kg	1,4
Supplied with the tool	✓



HYDRAULIC PUMPS AND UNITS



PO7000

HYDRAULIC PUMP

foot operated



Foot operated double speed pump, developing a maximum pressure of 700 bar. The pump is supplied with 3 m long high pressure flexible hose complete with female self-lock quick coupler. Pressure can be withdrawn at any time during operation by depressing the release lever. A solid shaped stand gives the pump stability during operation.

TECHNICAL FEATURES

Operating pressure bar	700
Dimensions mm	
Length	680
width	200
Height	163
Weight kg	9,8

STORAGE

Type	VAL-P21
Dimensions mm L x W x H	820 x 430 x 290
Weight kg	6,74
Supplied with the pump	✓



CPP-0

HYDRAULIC PUMP

foot operated



The CPP-0 air hydraulic power unit intensifies an air supply of 5÷8 bar (73-115 psi) to a power crimping or cutting force of up to 700 bar (10.000 psi) depending upon the input pressure. The control pedal allows for advancing and pressure release at any stage of the operation. The unit is provided with a 2 m high pressure flexible hose, including a 3/8" NPT female self-lock quick coupler.

TECHNICAL FEATURES

Operating pressure bar	700
Dimensions mm	
Length	320
width	150
Height	200
Weight kg	6,8

HYDRAULIC PUMP

powered by single-phase electric motor

CPE-1 CPE-1-110



TECHNICAL FEATURES

Operating pressure bar	700
Dimensions mm	
Length	372
width	223
Height	482
Weight kg	21

The pump is supplied with:

- high pressure flexible hose with male and female automatic quick coupler
- remote hand controller
- external supply connection cable



Electrically driven hydraulic pump, powered by a 230V / 50-60Hz single-phase electric motor. The remote hand controller allows advancement and pressure release on completion of the crimping operation.

The mechanically actuated emergency button located on the pump body allows the pressure release at any time in case of power shortage.

Also available CPE-1-110 version for 110-115V / 50-60Hz. Both models are IP 55 rated.

Available as optional accessories:

- Remote foot controller RCP-B70.
- Transportation trolley CS-CPE-1
- Control handle integrated with 3 m length flex hoses ERCH-WH

ERCH-WH



RCP-B70



CS-CPE-1



B1300PL

PORTABLE ELECTRO-HYDRAULIC PUMP

battery operated

Tool Type	Plug Type	Supplied Battery Charger Type
B1300PL	PLUG EU	ASC55-EU with EUROPEAN plug
B1300PLE	PLUG UK	ASC55-UK with UK plug
B1300PLA	PLUG USA CAN	ASC55-USA/CA (115V) with USA/CANADA plug
B1300PLT	PLUG AUS	ASC55-AUS/NZ with AUSTRALIAN/NEW ZEALAND plug



TECHNICAL FEATURES

Operating pressure bar	700
Dimensions mm	
Length	354
width	103
Height	240
Battery	18.0V 5.2Ah
Weight kg (with Battery)	4,0

STORAGE

Type	VAL-P51
Dimensions mm L x W x H	690 x 446 x 179
Weight kg	5,5
Supplied with the pump	✓



The B1300PL pump is supplied with:

- 0,9 m flexible hose complete with male + female 3/8" NPT self-lock quick couplers.
- 18,0 V - 4,0 Ah Li-Ion high power battery
- Battery charger
- Shoulder strap
- Plastic carrying case suitable for storing the tool and accessories, type VALP51

New portable electro-hydraulic pump B1300PL is battery operated for independent use. Having the inherent strengths of the CEMBRE 18V tool range the B1300PL is a compact, lightweight pump suitable for a wide range of applications. New Li-Ion 18 V 5.2 Ah batteries offer a high capacity, while improved operating speed results from a revitalised hydraulic system with double speed action. A security valve assures operator safety. Designed with improved handling characteristics, B1300PL is easily manageable during the operating process and, by the use of bi-component plastics, has a shell with high resistance to wear and damage.

Rubber grip inserts, low noise and minimal vibration aid operator comfort while additional convenience and safety are provided by LED lighting of the working area.

Pressure can be released at any time using the appropriate button.

APPLICATION RANGE

Crimping	Cutting	Punching
up to 130 kN	up to TC 050	RH-FL75 RH-FC48N

PORTABLE ELECTRO-HYDRAULIC PUMP

battery operated

B68M-P18

TECHNICAL FEATURES

Operating pressure bar	700
Dimensions mm	
Length	364
width	186
Height	236
Battery	18.0V 5.2Ah
Weight kg (with Battery)	5,6

STORAGE

Type	CVB-031
Dimensions mm L x W x H	620 x 300 x 320
Weight kg	2,4
Supplied with the pump	✓



The B68M-P18 pump is supplied with:

- Remote control provides LED working lights and an OLED display
- 2 m flexible hose complete with rotatable Q14-F quick coupler on the pump and female 3/8" NPT self-lock quick couplers
- 18.0 V - 5.2 Ah Li-Ion high power battery (2 pcs.)
- Canvas bag suitable for storing the tool and accessories
- Battery charger
- Shoulder strap



APPLICATION RANGE

Crimping	Cutting	Punching
up to 230 kN	up to TC 120	RH-FL75 RH-FC48N

Example of operating information on OLED display:



Operating mode



Battery level



Release mode



No. of cycles



Pressure mode



Motor temperature

New portable electro-hydraulic pump B68M-P18 is battery operated for independent use.

Having the inherent strengths of the CEMBRE 18V tool range, the B68M-P18 is a lightweight high capacity pump equipped with an innovative remote control suitable for a wide range of applications. New Li-Ion 18V - 5.2 Ah batteries offer a high capacity, while improved operating speed results from a revitalised hydraulic system with double speed action.

A maximum pressure sensor assures greater precision and repeatability of the pressure cycle, while a security valve doubles the provision for operator safety.

The unit has a manual pressure release button in case of emergency. Easy access to the oil reservoir is by means of an oil top-up inlet. The innovative remote control provides LED working lights and an OLED display of essential real time

Tool Type	Plug Type	Supplied Battery Charger Type
B68M-P18	PLUG EU	ASC55-EU with EUROPEAN plug
B68M-P18E	PLUG UK	ASC55-UK with UK plug
B68M-P18A	PLUG USA/CA	ASC55-USA/CA (115V) with USA/CANADA plug
B68M-P18T	PLUG AU/NZ	ASC55-AUS/NZ with AUSTRALIAN/NEW ZEALAND plug



tool operating information including:

- Operating mode selection
- Release mode selection: Smart release, manual release
- Minimum set pressure and momentary pressure reached expressed in bar allows verification of correct operation
- Battery charge level
- No. of cycles performed
- No. of cycles before scheduled recommended maintenance
- Motor temperature

The pump features a rubber pocket to store and protect the remote control.

Low noise levels aid operator comfort while additional convenience and safety are provided by LED lighting on the remote control.

Selecting the SMART release mode on the OLED display allows the operating pressure to be maintained until the operating button is released, thus allowing the operator to make a visual check of, say, the crimped connection.



PORTABLE ELECTRO-HYDRAULIC PUMPS B70M-P36 RANGE

battery operated



Easily accessible oil top-up inlet



Toggle button for direct operation via the pump



Remote electrical hand or foot controller connection

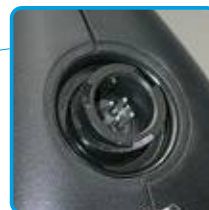

High pressure hose connects to automatic self-lock quick coupling with protective cap



Automatic battery connection system



New generation pumps B70M-P36 are powered by an all new 36.0V 8.0Ah Li-Ion high capacity rechargeable battery providing independence and portability. Fitted with a maximum pressure sensor (EPS) for enhanced precision and repeatability of the maximum pressure cycle, and a pressure relief valve providing additional safety for the operator. These units feature the Smart Release system which automatically retracts the ram at the end of the operating cycle. The manual toggle button can be used to operate and release the pressure directly from the pump. (inhibited when the remote control is used for safety reasons). Oil top-up inlet for easy access to the oil reservoir. Extremely compact and suitable for a wide range range of applications. The CEMBRE logo acts as an indicator by changing colour to provide the operator with instantaneous visual confirmation of the pumps status, such as: pump ready, pump in use, end of cycle, cycle error, anomaly, maintenance required. The new design and ergonomic weight distribution allows the pump to be easily handled during use.

The rigid structure of the plastic body ensures adequate mechanical protection and guarantees IP44M protection due to the presence of gaskets at the interface of the body shells. The ergonomically designed handle helps to increase operator comfort when moving the pump. Quieter operation, and the absence of vibrations ensure maximum operator comfort. Equipped with a 3m long high pressure hose complete with a male quick coupling on the pump and a self-locking female quick coupling. The pressure can be released at any time using the pressure release button.

The unit features an OLED display to provide essential real time tool operating information including:

- Operating mode selection (cutting, crimping or piercing)
- Release mode selection (Smart release, manual release)
- Minimum set pressure and snapshot pressure reached in bar/psi to allow verification of correct operation
- Battery charge level
- No. of cycles performed
- No. of cycles before scheduled recommended maintenance
- Motor temperature

- Operational command (hand controller or manual on the pump)



Can be used in vertical or horizontal position

OLED multifunctional display

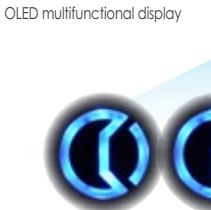

Smart Logo



Manual pressure release button



Pump on (constant) In action (pulse) End of cycle Cycle error Anomaly Maintenance

PORTABLE ELECTRO-HYDRAULIC PUMP

battery operated

B70M-P36

- 1 Portable electro-hydraulic pump, 36V battery for independent use, developing 700 bar pressure
- 2 CB3680L Battery 36 V - 8.0 Ah Li-Ion
- 3 ASC145-EU External battery charger
- 4 USB cable
- 5 Shoulder strap
- 6 CVB-037 Canvas rucksack for carrying accessories
- 7 3 m flexible hose complete with male + female 3/8" NPT self-lock quick couplers
- 8 ERCH Remote control

APPLICATION RANGE

Crimping	Cutting	Punching
up to 600 kN	up to TC120	RH-FL75 RH-FC48N



B70M-P36

Tool Type	Plug Type	Supplied Battery Charger Type
B70M-P36	PLUG EU	ASC55-EU with EUROPEAN plug
B70M-P36E	PLUG UK	ASC55-UK with UK plug
B70M-P36A	PLUG USA/CA	ASC55-USA/CA (115V) with USA/CANADA plug
B70M-P36T	PLUG AU/NZ	ASC55-AUS/NZ with AUSTRALIAN/NEW ZEALAND plug

TECHNICAL FEATURES

Operating pressure bar	700
Dimensions mm	
Length	405
width	161
Height	335
Battery	36V 6.2Ah
Weight kg (with Battery)	10.3*

*without accessories

PORTABLE ELECTRO-HYDRAULIC PUMP

battery operated

B70M-P36-CH

- 1 Portable electro-hydraulic pump, 36V battery for independent use, developing 700 bar pressure
- 2 CB3680L Battery 36 V - 8.0 Ah Li-Ion
- 3 ASC145-EU External battery charger
- 4 USB cable
- 5 Shoulder strap
- 6 CVB-037 Canvas rucksack for carrying accessories
- 9 ERCH-WH Remote hand controller integrated with 3 m length flexible hose complete with male + female 3/8" NPT self-lock quick couplers

APPLICATION RANGE

Crimping	Cutting	Punching
up to 600 kN	up to TC120	RH-FL75 RH-FC48N



B70M-P36-CH

Tool Type	Plug Type	Supplied Battery Charger Type
B70M-P36-CH	PLUG EU	ASC55-EU with EUROPEAN plug
B70M-P36E-CH	PLUG UK	ASC55-UK with UK plug
B70M-P36A-CH	PLUG USA/CA	ASC55-USA/CA (115V) with USA/CANADA plug

TECHNICAL FEATURES

Operating pressure bar	700
Dimensions mm	
Length	405
width	161
Height	335
Battery	36V 6.2Ah
Weight kg (with Battery)	10.3*

*without accessories

Variously supplied with different versions:



ACCESSORIES FOR B70M-P36

purchase separately

TRS-B70
Canvas rucksack
(for carrying the pump)



ERCH-WH
Remote hand controller integrated
with 3 m length flexible hose



Operating
push-button



Pressure release button

SH-B70
Hook for hanging the pump
from a ladder



RCP-B70
Portable remote foot control



VAL-P18
Durable transport case for pump
and accessories.



COMBINATIONS OF PUMPS AND HYDRAULIC HEADS

		HYDRAULIC PUMPS						
		PO7000	CPE1	CPP-0	B1300PL	B68M-P18	B70M-P36	B70M-P36-CH
HYDRAULIC HEADS	RH50 RHM50	✓	✓	✓	✓	✓	✓	✓
	RH60C	✓	✓	✓	✓	✓	✓	✓
	RH61	✓	✓	✓	✓	✓	✓	✓
	RHC131 RHM132	✓	✓	✓	✓	✓	✓	✓
	RHC131LN	✓	✓	✓	✓	✓	✓	✓
	RHU131	✓	✓	✓	✓	✓	✓	✓
	ECW-H3D	✓	✓	✓	-	✓	✓	✓
	RHU450	✓	✓	✓	-	-	✓	✓
	RHU520	✓	✓	✓	-	-	✓	✓
	RHU600	✓	✓	-	-	-	✓	-
	TC025	✓	✓	✓	✓	✓	✓	✓
	TC04N	✓	✓	✓	✓	✓	✓	✓
	TC050	✓	✓	✓	✓	✓	✓	✓
	TC055	✓	✓	✓	-	✓	✓	✓
	TC065SC	✓	✓	✓	-	✓	✓	✓
	TC085	✓	✓	✓	-	✓	✓	✓
	TC096	✓	✓	✓	-	✓	✓	✓
	TC120	✓	✓	✓	-	✓	✓	✓
	RH-FL75	✓	✓	✓	✓	✓	✓	✓
	RHT160 RHT160-60N	✓	✓	✓	✓	✓	✓	✓
RHTD...	✓	✓	✓	✓	✓	✓	✓	

HYDRAULIC UNIT

CP1131

pump PO7000 + head RHC131

MAIN APPLICATIONS - max section sqmm

Section sqmm	0.25-1.5	1.5-2.5	4-6	10	16	25	35	50	70	95	120	150	185	200	240	300	400	500	630	800	1000	
L.V. lugs and splices																						
Insulated terminals																						
"C" sleeve Connectors																						
H.V. lugs																						
H.V. Splices*																						

*limited to the cable insulation diameter

These tools are supplied without dies. For die selection, please refer to chart on pages 368 to 384

TECHNICAL FEATURES

Crimping force kN	130
Dimensions mm	
Dimensions pump L x W x H	680 x 200 x 163
Dimensions head L x H	232 x 124
length flexible hose	3 m
Weight unit kg	13,6

STORAGE

Type	VAL-P21*
Dimensions mm L x W x H	820 x 430 x 290
Weight kg	6,74
Supplied with the unit	✓

*Supplied with the unit, suitable for storage of 24 semi-circular slotted dies

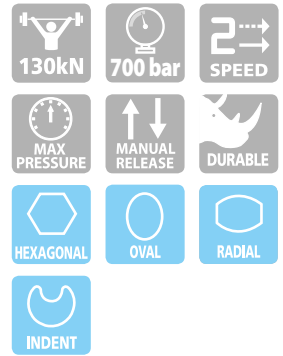

HYDRAULIC UNIT

CPU1131-C

pump PO7000 + head RHU131-C

MAIN APPLICATIONS - max section sqmm

Section sqmm	0.25-1.5	1.5-2.5	4-6	10	16	25	35	50	70	95	120	150	185	200	240	300	400	500	630	800	1000	
L.V. lugs and splices																						
Insulated terminals																						
"C" sleeve Connectors																						
Alu lugs and splices																						
H.V. lugs and splices																						

These tools are supplied without dies. For die selection, please refer to chart on pages 368 to 384

TECHNICAL FEATURES

Crimping force kN	130
Dimensions mm	
Dimensions pump L x W x H	680 x 200 x 163
Dimensions head L x H	245 x 89
length flexible hose	3 m
Weight unit kg	13,5

STORAGE

Type	VAL-P21*
Dimensions mm L x W x H	820 x 430 x 290
Weight kg	6,74
Supplied with the unit	✓

*Supplied with the unit, suitable for storage of 24 semi-circular slotted dies and accessories for crimping Aluminium connectors

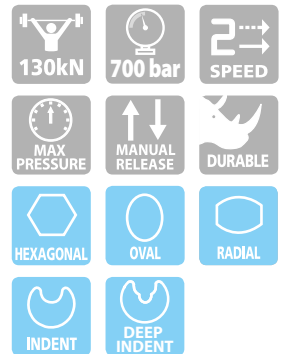

CPU1230-3D

HYDRAULIC UNIT

pump PO7000 + head ECW-H3D



MAIN APPLICATIONS - max section sqmm

Section sqmm	0.25-1.5	1.5-2.5	4-6	10	16	25	35	50	70	95	120	150	185	200	240	300	400	500	630	800	1000	
L.V. lugs and splices																						
Insulated terminals																						
"C" sleeve Connectors																						
H.V. lugs and splices																						

These tools are supplied without dies. For die selection, please refer to chart on pages 368 to 384



*Supplied with the unit, suitable for storage of 24 semi-circular slotted dies and adaptors and dies specific for head ECW-H3D

TECHNICAL FEATURES

Crimping force kN	230
Dimensions mm	
Dimensions pump L x W x H	680 x 200 x 163
Dimensions head L x H	290 x 120
Length flexible hose	3 m
Weight unit kg	15,3

STORAGE

Type	VAL-P21*
Dimensions mm L x W x H	820 x 430 x 290
Weight kg	6,74
Supplied with the unit	✓

CP1096

HYDRAULIC CUTTING UNIT

pump PO7000 + head TC096



TECHNICAL FEATURES

Max cutting Ø mm	95
Dimensions mm	
Dimensions pump L x W x H	680 x 200 x 163
Dimensions head L x H	397 x 249
Length flexible hose	3 m
Weight unit kg	17,7

STORAGE

Type	VAL-CP096
Dimensions mm L x W x H	785 x 430 x 175
Weight kg	10,0
Supplied with the unit	✓

CP1120

HYDRAULIC CUTTING UNIT

pump PO7000 + head TC120

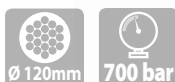

TECHNICAL FEATURES

Max cutting Ø mm	120
Dimensions mm	
Dimensions pump L x W x H	680 x 200 x 163
Dimensions head L x H	536 x 175
Length flexible hose	3 m
Weight unit kg	19,3

STORAGE

Type	VAL-22-TC120
Dimensions mm L x W x H	766 x 305 x 191
Weight kg	8,3
Supplied with the unit	✓

HYDRAULIC CUTTING UNITS

CP-W-KV

according to DIN EN 50340 - VDE 0682 part 661



GS approval
n. ET 23008

Hydraulic units provide protection against short circuit when accidentally cutting live L.V. / M.V. cables with nominal voltage up to 60 kV.



CP 1086-W-1000-KV

TECHNICAL FEATURES

Max cutting Ø mm	85
Dimensions mm	
Dimensions pump L x W x H	680 x 200 x 163
Dimensions head L x H	405 x 143
Length flexible hose	10 m
Weight unit kg	16,6



CP 1096-W-1000-KV

TECHNICAL FEATURES

Max cutting Ø mm	95
Dimensions mm	
Dimensions pump L x W x H	680 x 200 x 163
Dimensions head L x H	407 x 245
Length flexible hose	10 m
Weight unit kg	19,0



CP 1120-W-1000-KV

TECHNICAL FEATURES

Max cutting Ø mm	120
Dimensions mm	
Dimensions pump L x W x H	680 x 200 x 163
Dimensions head L x H	556 x 185
Length flexible hose	10 m
Weight unit kg	20,2



Available as optional accessories:

- EK100 earth cable for the pump (1 m length)
- EK500P earth cable for the head (5 m length) with earth rod and canvas bag



STORAGE

Type	VAL-CP096-W
Dimensions mm L x W x H	785 x 430 x 175
Weight kg	10,0
Supplied with the unit	✓



insulated

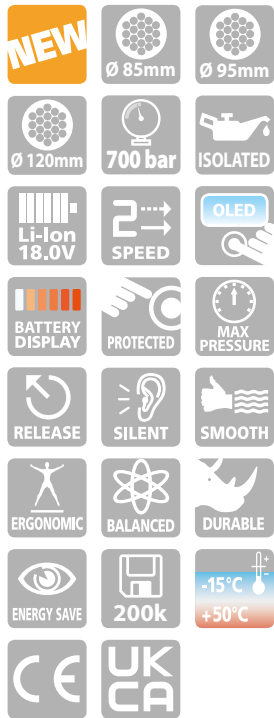

The CP1300P...-KV insulated units fit between the CP-W-KV pedal units and the B68-RC3 radio-controlled units to best meet customer needs. They are composed of 2 elements, the pump common to all cutting heads, and the heads.

The battery-powered pump for autonomous use is among the lightest on the market; powered by 18V - 8Ah lithium ion batteries, they provide high capacity while a double-speed hydraulic system guarantees rapid execution of the work cycle. The steel body guarantees longevity, the extreme compactness makes it versatile in use. The electronic system is designed to avoid running out of battery while cutting cables.

The heads are instead designed to cover the most common range of cables with 2 guillotine versions (85 and 120) and a scissor version (96). Body and blades are made of special heat-treated steel to ensure longevity and sturdiness during the cutting operation.

Pump and heads are both equipped with an earthing point to better adapt to the procedures of each individual utility.

Like all CEMBRE KV type equipment, they require the use of special dielectric oil.



CP1300P-85-KV

CP1300P-85-KV TECHNICAL FEATURES

Max cutting Ø mm	85
Dimensions mm	
Dimensions pump L x W x H	377 x 102 x 239
Dimensions head L x H	405 x 143
Length flexible hose	10 m
Weight unit kg	11.6



CP1300P-96-KV

CP1300P-96-KV TECHNICAL FEATURES

Max cutting Ø mm	95
Dimensions mm	
Dimensions pump L x W x H	377 x 102 x 239
Dimensions head L x H	407 x 245
Length flexible hose	10 m
Weight unit kg	14.6



CP1300P-120-KV

CP1300P-120-KV TECHNICAL FEATURES

Max cutting Ø mm	120
Dimensions mm	
Dimensions pump L x W x H	377 x 102 x 239
Dimensions head L x H	556 x 185
Length flexible hose	10 m
Weight unit kg	15.4

The 10m high pressure hose is connected to the heads in a fixed manner while the connection to the pump is quick with a locking ring, to avoid accidental disconnection.

STORAGE

Type	VAL-CP096-W
Dimensions mm L x W x H	785 x 430 x 175
Weight kg	10,0
Supplied with the unit	✓

Available as optional accessories:

- CVB-031 Canvas bag
- EK100 Earth cable for the pump (1 m length)
- EK500P Earth cable for the head (5 m length) with earth rod and canvas bag



CVB-031



EK500P



EK100



PORTABLE BATTERY HYDRAULIC CUTTING UNITS

radio controlled - for remote cutting operations



B68RC3



Tool Type	Plug Type	Supplied Battery Charger Type
B68RC3-85 B68RC3-96 B68RC3-120	PLUG EU	ASC55-EU with EUROPEAN plug
B68RC3-85E B68RC3-96E B68RC3-120E	PLUG UK	ASC55-UK with UK plug

B68RC3-85

TECHNICAL FEATURES

Max cutting Ø mm	85
Dimensions mm	
Dimensions pump L x W x H	417 x 236 x 212
Dimensions head L x H	409 x 174 x 140
Weight unit kg	13,68

B68RC3-96

TECHNICAL FEATURES

Max cutting Ø mm	95
Dimensions mm	
Dimensions pump L x W x H	417 x 236 x 212
Dimensions head L x H	498 x 249 x 147
Weight unit kg	17,24

B68RC3-120

TECHNICAL FEATURES

Max cutting Ø mm	120
Dimensions mm	
Dimensions pump L x W x H	417 x 236 x 212
Dimensions head L x H	536 x 223 x 140
Weight unit kg	18,44



The heart of each unit is the new portable pump B68M-P18-KV-RC3, battery operated for independent use. Having the inherent strengths of the CEMBRE 18V tool range, the B68M-P18-KV-RC3 is a lightweight high capacity pump equipped with an innovative radio remote control designed specifically for man-hole environments to allow operators to control and operate the pump out of the man-hole at a safe distance.

New Li-Ion 18V - 8Ah batteries provide high capacity while improved operating speed results from a revitalized hydraulic system with double speed action.

A maximum pressure sensor assures greater precision and repeatability

of the pressure cycle, while a security valve doubles the provision for operator safety.

The unit is fitted with a patented unique system for stopping the pump when the cutting head sensor signals that its blades have travelled fully.

At this point the LED indicator and buzzer notify the operator of the successful completion of the cutting operation. For this reason, each pump is paired to its specific cutting head only and it must be considered as a complete unit.

The innovative remote control function is able to work in man-hole environment where radio communication is normally more complicated.

The unit features an OLED display to provide essential real time tool operating information including:

- Operating mode selection (cutting or crimping)
- Release mode selection (Smart release, manual release)
- Minimum set pressure and momentary pressure reached in bar/psi to allow verification of correct operation
- Battery charge level
- No. of cycles performed
- No. of cycles before scheduled recommended maintenance
- Motor temperature
- Operating command (radio or manual).

Supplied with:

- Radio remote control (2405 ÷ 2480 MHz)
- CB1880L, Li-Ion 18.0 V 8.0 A h Battery (2 pcs)
- ASC55-EU, Battery charger
- 10 m length high pressure flexible hose
- USB cable
- Shoulder strap
- VAL-B68RC3 Metal Carrying Case

Available as optional accessories:

- CVB-031 Canvas bag
- EK100 Earth cable for the pump (1 m length)
- EK500P Earth cable for the head (5 m length) with earth rod and canvas bag



STORAGE

Type	VAL-B68RC3
Dimensions mm L x W x H	665 x 422 x 260
Weight kg	17,4
Supplied with the unit	✓



B68M-P18-KV-RC1

PORTABLE BATTERY INSULATED HYDRAULIC PUMP

radio controlled



New portable battery hydraulic pump B68M-P18-KV-RC1 is battery operated for independent use.

Extremely compact and light in weight, it is suitable for a wide range of applications.

The B68M-P18-KV-RC1 is a light-weight high capacity pump equipped with an innovative radio remote control designed specifically for man-hole environments to allow operators to control and operate the pump out of the man-hole at a safe distance.

The LED indicator and buzzer notify the operator of the successful completion of the cutting or crimping operation.

The manual toggle button can be used to operate and release the pressure directly from the pump (inhibited when the remote control is used for safety reasons).

Fast compression or cutting speeds are guaranteed by a two-speed hydraulic system; it is also equipped with a pressure sensor and a safety valve, the first to guarantee greater precision and repeatability of the maximum cycle pressure, the second as a redundant safety element for the operator.

The ergonomically designed handle helps to increase operator comfort when moving the pump.

The plastic material body ensures adequate mechanical protection in all conditions of use, thanks to its rigid structure; greater safety and comfort in handling, thanks to the ergonomic handle.

It is equipped with an automatic locking female quick coupling with 138-F safety ring nut for the connection of flexible hoses with high dielectric power.

The pressure can be released at any time using the pressure release button.

The unit features an OLED display to provide essential real time tool operating information including:

- Operating mode selection (cutting or crimping)
- Release mode selection (Smart release, manual release)
- Minimum set pressure and momentary pressure reached in bar/psi to allow verification of correct operation
- Battery charge level
- No. of cycles performed
- No. of cycles before scheduled recommended maintenance
- Motor temperature
- Operating command (radio or manual).

Supplied with:

- Radio remote control (2405 ÷ 2480 MHz)
- CB1880L, Li-Ion 18.0 V 8.0 A h Battery (2 pcs)
- ASC55-EU, Battery charger
- USB cable
- Shoulder strap
- CVB-031 Canvas bag



CVB-031

TECHNICAL FEATURES

Operating pressure bar	700
Dimensions mm	
Length	350
width	212
Height	236
Battery	18.0V 8.0Ah
Weight kg (with Battery)	6

STORAGE

Type	CVB-031
Dimensions mm L x W x H	620 x 300 x 320
Weight kg	2,4
Supplied with the pump	✓



LED indicators and buzzer



OLED multifunctional display



Automatic battery connection system



Pressure release button

PORTABLE ELECTRO-HYDRAULIC INSULATED PUMP

B1300PK-KV

battery operated

TECHNICAL FEATURES

Operating pressure bar	700
Dimensions mm	
Length	377
width	102
Height	239
Battery	18.0V 8.0Ah
Weight kg (with Battery)	4.0



The B1300P-KV pump is supplied with:

- 18.0 V - 8.0 Ah Li-Ion high power battery (1 pcs)
- Battery charger
- Shoulder strap

APPLICATION RANGE

Crimping	Cutting	Punching
up to 130 kN	up to TC 050	RH-FL75 RH-FC48N

New B1300P-KV portable electro-hydraulic insulated pump powered by Li-Ion 18V - 8.0Ah battery having the same characteristics as the B1300PL version except for the insulated oil and the insulated female quick coupling with automatic locking I38-F.

The unit features an OLED display to provide essential real time tool operating information including:

- Minimum set pressure and momentary pressure reached in bar/psi to allow verification of correct operation
- Battery charge level
- No. of cycles performed
- No. of cycles before scheduled recommended maintenance
- CEMBRE logo, tool model and serial number.

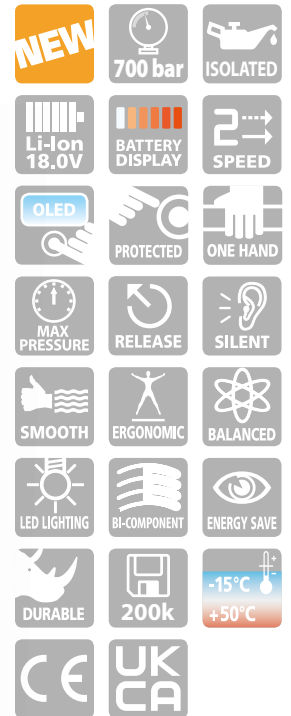

The pump can be connected to hydraulic heads and insulated flexible hoses (supplied on request) equipped with I38 series quick coupling (see page 346)



Ergonomic shape for optimal comfort



OLED multifunctional display



Automatic battery connection system



Insulated female quick coupling with automatic locking I38-F

CB BH ASC CFC BPS

Accessories for cordless tools



battery

	Type	Description	Technology	Ah	V
STANDARD	CB1820L	CB1820L 18V-2.0Ah battery	Li-Ion	2.0	18
	CB1852L	CB1852L 18V-5.2Ah battery	Li-Ion	5.2	18
	CB1880L	CB1880L 18V-8.0Ah battery	Li-Ion	8.0	18
	CB3662L	CB3662L 36V-6.2Ah battery	Li-Ion	6.2	36
	CB3680L	CB3680L 36V-8.0Ah battery	Li-Ion	8.0	36
ON REQUEST	CB1430L	CB1430L 14.4V-3.0Ah battery	Li-Ion	3.0	14.4
	CB9630H	CB9630H 9.6V-3.0Ah battery	Ni-MH	3.0	9.6
	CB1430H	CB1430H 14.4V-3.0Ah battery	Ni-MH	3.0	14.4
	BH2433	BH2433 24V-3.3Ah battery	Ni-MH	3.3	24



battery charger



CFC230N
CFC120YN

Type	Description	V
ASC55-EU / ASC55-UK / ASC55-AUS/NZ	battery charger 220-240V 50-60Hz	18
ASC55-USA/CA	battery charger 115V 60Hz	18
ASC145-EU / ASC145-UK / ASC145-AUS/NZ	battery charger 220-240V 50-60Hz	10.8 - 36
ASC145-AUS/NZ	battery charger 115V 60Hz	10.8 - 36
ASC145DUO-EU / ASC145DUO-UK	battery charger 220-240V 50-60Hz	12 - 36
ASC145DUO-USA/CA	battery charger 115V 60Hz	12 - 36
ASC55-MULTI8-EU	8 position multiple charger 220-240V 50-60Hz	12 - 36
ASC55-MULTI8-US	8 position multiple charger 110V 60Hz	12 - 36
CFC230N	battery charger 230V AC	14.4
CFC120YN	battery charger 120V AC	14.4

Battery and battery charger kit

KIT



KIT-18..EU/..

Kit

KIT Type	Description	Battery				Battery charger Type
		Type	Q.ty	Ah	V	
KIT-1820.EU/2	2 batteries + 1 battery charger	CB1820L	2	2.0	18	ASC55-EU
KIT-1820.EU/1	1 battery + 1 battery charger	CB1820L	1	2.0	18	ASC55-EU
KIT-1852.EU/2	2 batteries + 1 battery charger	CB1852L	2	5.2	18	ASC55-EU
KIT-1852.EU/1	1 battery + 1 battery charger	CB1852L	1	5.2	18	ASC55-EU
KIT-1880.EU/2	2 batteries + 1 battery charger	CB1880L	2	8.0	18	ASC55-EU
KIT-1880.EU/1	1 battery + 1 battery charger	CB1880L	1	8.0	18	ASC55-EU

Power supplies

BPS



BPS230.96



BPS230.14

power supplies

Type	Description	V
BPS230.96	BPS230.96 (230V -9.6V) power supplies	9.6
BPS230.14	BPS230.14 (230V -14.4V) power supplies	14.4

others

Type	Description
6000354	Shoulder strap for battery tools
6006309	USB2.0/MINI USB B M-M 1.8 m cable black



6000354



6006309

VAL

Accessories for storage of dies



VALMAT-C/15



VALMAT



VAL-130



VALMAT-230-630



VALMAT-520

cases - bags



CVB-013

VAL-75

Tipo	Descrizione
VALMAT-C/15	Plastic carrying case suitable for the storage of 15 semicircular dies
VALMAT	Metal carrying case suitable for the storage of semicircular dies
VALMAT-230-630	Metal carrying case suitable for the storage of accessories for crimping Aluminium connectors
VALMAT-520	Metal carrying case suitable for storage of 10 sets of hexagonal dies for the head RHU520
VAL-130	Metal carrying case suitable for the storage of accessories for crimping Aluminium connectors
VAL-75	Plastic case suitable for containing tool dies for HT81-U; RHU81; RH50; RHM50
CVB-013	Canvas bag

CVB

Transport accessories



CVB-030



CVB-037



CVB-031



VAL-P18

canvas bag - trolley

Type	Description
CVB-030	Canvas bag for carrying tools and accessories
CVB-031	Canvas bag for the transport of pump and accessories
CVB-037	Canvas rucksack for transporting pump and accessories
VAL-P18	Wheeled transport case for pump and accessories

NEW



KIT-ME-50

Kit includes:

9 die sets:

ME5-50	Hexagonal crimp for low voltage terminals and through connectors from 25 to 240 mm ² A-M family
ME7-50	
ME10-50	
ME14-50	
ME19-50	
ME24-50	
ME30-50	
ME37-50	
ME48-50	

KIT-MH-50

Kit includes:

10 die sets:

MH16-50	Hexagonal crimp for low voltage terminals and through connectors from 16 to 240 mm ² HR family
MH25-50	
MH35-50	
MH50-50	
MH70-50	
MH95-50	
MH120-50	
MH150-50	
MH185-50	
MH240-50	

KIT-MK-50/CU

Kit includes:

10 die sets:

MK8-50	Hexagonal crimp for low voltage terminals and through connectors from 16 to 240 mm ² DIN 46235 family
MK10-50	
MK12-50	
MK14-50	
MK16-50	
MK18-50	
MK20-50	
MK22-50	
MK25-50	
MK28-50	



KIT-MA/PA-50

Kit includes:

6 die sets:

Nest	Indentor	Indent crimp for low voltage general purpose terminals and through connectors from 25 to 120 mm ²
MA5-50	PA5-50	
MA7-50	PA10-50	
MA10-50		
MA14-50	PA19-50	
MA19-50	PA24-50	



KIT-ME-45 (for HT45 and B450ND-BV)

Kit includes:

7 die sets:

ME5	Hexagonal crimp for low voltage terminals and through connectors from 25 to 150 mm ² A-M family
ME7	
ME10	
ME14	
ME19	
ME24	
ME30	



KIT-ME-60C/1

Kit includes:

11 die sets:

ME5-60C	Hexagonal crimp for low voltage terminals and through connectors from 25 to 300 mm ² A-M family
ME7-60C	
ME10-60C	
ME14-60C	
ME19-60C	
ME24-60C	
ME29-60C	
ME30-60C	
ME37-60C	
ME48-60C	
ME60-60C	

KIT-MH-60C

Kit includes:

9 die sets:

MH25-60C	Hexagonal crimp for low voltage terminals and through connectors from 25 to 240 mm ² HR family
MH35-60C	
MH50-60C	
MH70-60C	
MH95-60C	
MH120-60C	
MH150-60C	
MH185-60C	
MH240-60C	

KIT-MK-60C/CU

Kit includes:

9 die sets:

MK10-60C	Hexagonal crimp for low voltage terminals and through connectors from 25 to 240 mm ² DIN 46235 family
MK12-60C	
MK14-60C	
MK16-60C	
MK18-60C	
MK20-60C	
MK22-60C	
MK25-60C	
MK28-60C	

NEW

Modular system

Efficient, organised, and easy-to-move transport of the entire work kit is essential for performing operations quickly and effectively. The new VAL-M series includes an extensive selection of backpacks, bags, trolleys, and cases in various sizes and formats, all specifically designed to securely hold and transport CEMBRE's connector-matrix-head-tool systems with ease.

The design of the VAL-M transport accessories ensures key advantages in any situation: complete functionality, maximum compatibility, perfect modularity, exceptional comfort, and superior maneuverability.

**Features**

- Robust and simple transport solution for tools and accessories
 - Easy to store
 - Rotary interlock connection allows one-handed operation
 - Ergonomic handle on top and front
 - High quality locking mechanisms
- Stackable





cases - bags - trolleys

Type	Description
VAL-M/KIT1	Case for transporting connectors and accessories - dimensions 252x167xh63
VAL-M/KIT2	Case for transporting connectors and accessories - dimensions 440x346xh95
VAL-M/KIT2-8	Case with 8 compartments (modules 10x15.5 cm) for transporting connectors and accessories dimensions 440x346xh95 mm
VAL-M/KIT2-48	Case with 48 compartments (modules 5x5 cm) for transporting connectors and accessories dimensions 440x346xh95 mm
VAL-M/S0	Modular case for transporting tools and accessories - dimensions 396x296xh145
VAL-M/L0	Modular case for transporting tools and accessories - dimensions 496x296xh145
VAL-M/H0	Modular case for transporting tools and accessories - dimensions 496x296xh280
VAL-M/X0	Modular case for transporting tools and accessories - dimensions 596x396xh185
CTSB2	Modular bag for transporting tools and accessories
RPL01-M	Rollplate for VAL-M cases...



CTSB2



RPL01-M

TF

Accessories for non-insulated hydraulic pumps



non-insulated flexible hoses (extensions)

Type	Length m	Quick Coupler	Description
TF300-Q38FM	3	F/M	High pressure flexible hose fitted with automatic quick couplers
TF600-Q38FM	6	F/M	High pressure flexible hose fitted with automatic quick couplers
TF200-Q14FM	2	F/M	High pressure flexible hose fitted with automatic quick couplers
TF500-Q38FM	5	F/M	High pressure flexible hose fitted with automatic quick couplers
TF1000-Q38FM	10	F/M	High pressure flexible hose fitted with automatic quick couplers
ERCH-WH	3	F/M	Remote hand controller integrated with high pressure flexible hose complete with automatic quick couplers for B70M-P36; CPE-1

Q-M, Q-F

Quick couplers for non-insulated flexible hoses



Q14-MS

Q14-MS
Male automatic coupler for hydraulic heads (1/4" NPT).



Q38-F

Q38-F
Female automatic coupler with safety ring for hydraulic pumps and flexible hoses (3/8" NPT).



Q38-MS

Q38-MS
Male automatic coupler for flexible hoses (3/8" NPT).

TF-I

Accessories for insulated hydraulic pumps



TF..-I..

insulated flexible hoses (extensions)

Type	Length m	Insulated Quick Coupler	Description
TF1000-I38FM-KVE	10	F/M	10 m long high pressure flexible hose equipped with insulated oil with high dielectric power and with "insulated" type quick couplers with automatic locking, complete with case
TF500-I38FM-KV	5	F/M	5 m long high pressure flexible hose equipped with insulated oil with high dielectric power and with "insulated" type quick couplers with automatic locking

I-F, I-M

Quick couplers for insulated flexible hoses



I38-F

I38-F
Female automatic coupler with safety ring for insulated hydraulic pumps and flexible hoses (3/8" NPT).



I38-MS

I38-MS
Male automatic coupler for insulated flexible hoses (3/8" NPT).

MBS-RH

Accessory for hydraulic heads



The MBS-RH bench vice has been designed to clamp the high pressure hose via the female quick coupling and securely and stably fix the CEMBRE hydraulic heads for compression and cutting to the bench.



TECHNICAL FEATURES































































Dimensions mm

width	80
Height	190
Max. height fixing to the table	600
Min. height fixing to the table	200
Weight kg	2,174



DIE SELECTOR CHART



DIE SELECTOR CHART

APPLICATION	CONDUCTOR		CONNECTOR			HYDRAULIC TOOLS						
						B15MD		HT45-E B450ND-BV		HT51 RH50 B500 B500ND		
						DIE SET	NEST	INDEN-TOR	DIE SET	NEST	INDEN-TOR	DIE SET
COPPER CONDUCTORS	Conductor Size sqmm		TERMINAL		SPLICE	DIE SET	NEST	INDEN-TOR	DIE SET	NEST	INDEN-TOR	DIE SET
	Low Str.	Flex										
	A..M..	0,25 ÷ 2,5	A 03-M.. A 06-M..		L 03-M / L 03-P L 06-M / L 06-P	ME03/2-15  MA03/3-15 						
	A..2M..	4 ÷ 6	A 1-M.. A 1-L..		L 1-M L 1-P	ME03/2-15  MA03/3-15 	MA1 	PA1	ME1 	MA1-50 	PA1-50	ME1-50 
		10	A2-M.. A2-L.. A2-P12 A2-U..	A2-2M..	L 2-M L 2-P	ME03/2-15  ME2/3-15  MA03/3-15 			ME2 			ME2-50 
	A..L..	16	A3-M.. A3-L.. A3-P14 A3-P22R.. A3-U..	A3-2M..	2A 3-M.. L 3-M L 3-P	ME2/3-15  MA03/3-15 	MA2.3 			MA2.3-50 		
	A..P..	25	A5-M.. A5-L.. A5-P16 A5-P22R..	A5-2M..	2A 5-M.. L 5-M L 5-P		MA5 		ME5 	MA5-50 		ME5-50 
	A..PR..	35	A 7-M.. A 7-L.. A 7-P20	A7-2M..	2A 7-M.. L 7-M L 7-P		MA7 		ME7 	MA7-50 		ME7-50 
	A..U..	50	A 10-M.. A 10-L.. A 10-P25	A10-2M..	2A 10-M.. 2A10-2M.. L 10-M L 10-P		MA10 	PA10	ME10 	MA10-50 	PA10-50	ME10-50 
		70	A 14-M.. A 14-L.. A 14-P30	A14-2M..	2A 14-M.. 2A14-2M.. L 14-M L 14-P				ME14 	MA14-50 		ME14-50 
									ME17 		PA19-50	ME17-50 
	2A..M..	95	A 19-M.. A 19-L..	A19-2M..	2A 19-M.. 2A19-2M.. L 19-M L 19-P				ME19 	MA19-50 		ME19-50 
		120	A 24-M.. A 24-L..	A24-2M..	2A 24-M.. 2A24-2M.. L 24-M L 24-P				ME24 	MA24-50 	PA24-50	ME24-50 
		150	A 30-M.. A 30-L..	A30-2M..	2A 30-M.. 2A30-2M.. L 30-M L 30-P				ME30 			ME30-50 
	2A..2M..	185	A 37-M.. A 37-L.. A 37-4ESI	A37-2M..	2A 37-M.. 2A37-2M.. L 37-M L 37-P							ME37-50 
		240	A 48-M.. A 48-L.. A 48-4ESI	A48-2M..	2A 48-M.. 2A48-2M.. L 48-M L 48-P							ME48-50 
	L..M..	300	A 60-M.. A 60-L.. A 60-4ESI	A60-2M..	2A 60-M.. 2A60-2M.. L 60-M L 60-P							ME60-50** 
		400	A 80-M.. A 80-4ESI	A80-2M..	2A 80-M.. 2A80-2M.. L 80-M							
	L..P..	500	A 100-M.. A 100-4ESI	A100-2M..	2A 100-M.. 2A100-2M.. L 100-M							
		630	A 120-M.. A 120-4ESI	A120-2M..	2A 120-M.. 2A120-2M.. L 120-M							
A..4ESI	800	A 160-M.. A 160-4ESI	A160-2M..	2A 160-M.. 2A160-2M.. L 160-M								
	1000	A 200-M..		2A 200-M.. 2A200-2M.. L 200-M								
EXTRA FLEXIBLE COPPER CONDUCTORS		35	A 9-M..				MA9 	PA10	ME9 	MA9-50 	PA10-50	ME9-50 
		50	A 12-M..						ME12 	MA12-50 		ME12-50 
	A..M..	70	A 17-M..						ME17 	MA17-50 	PA 19-50	ME17-50 
		95	A 20-M..						ME20 	MA20-50 		ME20-50 
		120	A 29-M..						ME29 			ME29-50 
		150	A 35-M..									ME35-50 
		185	A 40-M..									ME40-50 

 = Hexagonal crimp (use one size up with fine stranded conductors, E.G.: 95i fine stranded use A19-.. + ME 19 or A 20-.. + ME 20)

  = Indent crimp

* Contact Cembre for appropriate die set

DIE SELECTOR CHART

HYDRAULIC TOOLS														
HT60C RH60C B600C B600CND		HT81-UD RHU81-D ◊			HT 120 and tools and heads with 130 kN crimping force				ECW-H3D			RHU 520		
DIE SET	NEST	INDEN- TOR	DIE SET	NEST	INDEN- TOR	DIE SET	NEST	INDENTOR	DIE SET	NEST	INDENTOR	DIE SET		
ME1-60C (1)	MA1-50 (1)	PA1-50	ME1-50 (1)											
ME2-60C (1)	MA2.3-50 (1)	PA5-50	ME2-50 (1)	MA2-C (1)	PA10-C	ME2-C (1)	Adaptor AU230-130-D with die set MA..-C and indentor PA..-C	Adaptor AU230-130-D with die set ME..-C	Adaptor AU520-130-C with die set MA..-C and indentor PA..-C	Adaptor AU 520-130 C with die set ME..-C				
ME3-60C (1)			ME3-50 (1)	MA3-C (1)		ME3-C (1)								
ME5-60C (1)	MA5-50 (1)	ME5-50 (1)	MA5-C (1)	ME5-C (1)										
ME7-60C (1)	MA7-50 (1)	ME7-50 (1)	MA7-C (1)	ME7-C (1)										
ME10-60C (2)	MA10-50 (1)	ME10-50 (2)	MA10-C (1)	ME10-C (1)										
ME14-60C (2)	MA14-50 (1)	PA19-50	ME14-50 (2)	MA14-C (1)	ME14-C (1)									
ME17-60C (2)			ME17-50 (2)	ME17-C (1)										
ME19-60C (2)	MA19-50 (1)	ME19-50 (2)	MA19-C (1)	ME19-C (1)										
ME24-60C (2)	MA24-50 (1)	PA24-50	ME24-50 (2)	MA24-C (1)	ME24-C (1)									
ME30-60C (3)			ME30-50 (3)	MA30-C (1)	ME30-C (1)									
ME37-60C (3)			ME37-50 (3)	MA37-C (1)	ME37-C (1)									
ME48-60C (3)			ME48-50 (3)	MA48-C (1)	ME48-C (2)									
ME60-60C (4)				MA60-C (1)	PA60-C	ME60-C (3)								
						ME80-C (3)	MA80-3D (1)	PA100-3D	ME80-3D (2)	MA80-520 (1)	PA120-520	ME80-520 (2)		
							MA100-3D (1)		ME100-3D (2)	MA100-520 (1)		ME100-520 (2)		
							MA120-3D (1)		PA120-3D	ME120-3D (2)		MA120-520 (1)	ME120-520 (2)	
										MA160-520 (1)	PA200-520	ME160-520 (2)		
										MA200-520 (1)		ME200-520 (2)		
ME9-60C (1)	MA9-50 (1)	PA10-50	ME9-50 (1)	MA9-C (1)	PA10-C	ME9-C (1)	Adaptor AU 230-130 D with die set MA..-C and indentor PA..-C	Adaptor AU 230-130 D with die set ME..-C	Adaptor AU520-130-C with die set MA..-C and indentor PA..-C	Adaptor AU 520-130 C with die set ME..-C				
ME12-60C (2)	MA12-50 (1)	PA 19-50	ME12-50 (2)	MA12-C (1)	PA24-C	ME12-C (1)								
ME17-60C (2)	MA17-50 (1)		ME17-50 (2)	MA17-C (1)		ME17-C (1)								
ME20-60C (2)	MA20-50 (1)	ME20-50 (2)	MA20-C (1)	ME20-C (1)										
ME29-60C (3)			ME29-50 (3)	MA29-C (1)	ME29-C (1)									
ME35-60C (3)			ME35-50 (3)	MA35-C (1)	PA48-C	ME35-C (1)								
ME40-60C (3)			ME40-50 (3)	MA40-C (1)	ME40-C (1)									

N.B.: Number inside symbol indicates the number of crimps on A-M barrel

** Only for B500, B500ND and RH50.

◊ The Type HT81-UD and RHU81-D Tools use the same dies as the HT51, with the aid of a Type 6522051 spring

DIE SELECTOR CHART





	APPLICATION	CONDUCTOR	CONNECTOR						
COPPER CONDUCTORS		Conductor Size Flex sqmm	TERMINAL						
		10	ANE2-M..	ANE2-P12	ANE2-U..	AN2-M..	IN2-M..	EN2-M.. ENR2-M..	
		16	ANE3-M..	ANE3-P14	ANE3-U..	AN3-M..	IN3-M..	EN3-M..	
		25	ANE5-M..	ANE5-P16		AN5-M..			
		35	ANE7-M..	ANE7-P20		AN7-M..	IN7-M..	EN7-M..	
		50	ANE10-M..			AN10-M..	IN10-M..	EN10-M.. ENR10-M..	
		70	ANE14-M..			AN14-M..	IN14-M..	EN14-M..	
		95	ANE19-M..			AN19-M..	IN19-M..	EN19-M..	
		120	ANE24-M..			AN24-M..	IN24-M..	EN24-M..	
		150	ANE30-M..			AN30-M..	IN30-M..	EN30-M..	
		150					IN37-M.. INR37-M..		
		185					IN48-M..	EN48-M..	
240					IN60-M..	EN60-M..			
300					IN80-M..	EN80-M..			
EXTRA FLEXIBLE COPPER CONDUCTORS		35	ANE9-M..						
		50	ANE12-M..						
		70	ANE17-M..						
		95	ANE20-M..						
		120	ANE29-M..						
		150	ANE35-M..						
COPPER CONDUCTORS		Conductor Size Flex sqmm	TERMINAL						
		0,3 ÷ 4	PKD506÷PKD418	PKE508÷PKE418	PKC508÷PKC418	KE506÷KE412			
		4 ÷ 16	PKD410÷PKD1618	PKE410÷PKE1618	PKC410÷PKC1618	KE410÷KE1616			
		16	PKD16..	PKE16..	PKC16..	KE16..			
		25	PKD25..	PKE25..	PKC25..	KE25..			
		35	PKD35..		PKC35..	KE35..			
		50	PKD50..		PKC50..				
		70			PKC70..				
		95			PKC95..				
	120			PKC120..					
		Conductor Size Flex sqmm	TERMINAL						
		2 x 0,5	PKT508 PKT510						
		2 x 0,75	PKT7508 PKT7510						
		2 x 1	PKT108 PKT110						
		2 x 1,5	PKT1508 PKT1512						
		2 x 2,5	PKT2510 PKT2512						
		2 x 4	PKT412						
		2 x 6	PKT614						
2 x 10		PKT1014							
2 x 16	PKT1614								

 = Indent crimp
  = Radial crimp
  = Trapezium crimp

DIE SELECTOR CHART

HYDRAULIC TOOLS									
B15MD	HT45-E B450ND-BV	HT51 RH50 B500 B500ND	HT60C RH60C B600C B600CND	HT 120 and tools and heads with 130 kN crimping force			ECW-H3D		
DIE SET		DIE SET		NEST	INDENTOR	DIE SET	NEST	INDENTOR	
NN4-15		MN2RF-50		MN2-C	PN7-C	MN2RF-C	Adaptor AU230-130-D with die set MN...-C and indentor PN...-C or with die set MN...RF-C and die set MN...F-C		
		MN3RF-50		MN3-C		MN3RF-C			
		MN5RF-50		MN5-C		MN5RF-C			
		MN7RF-50		MN7-C		MN7RF-C			
		MN10RF-50		MN10-C	PN14-C	MN10RF-C			
		MN14RF-50		MN14-C		MN14RF-C			
		MN19RF-50		MN19-C	PN24-C	MN19RF-C			
		MN24RF-50		MN24-C		MN24RF-C			
				MN30-C	PN37-C	MN30RF-C			
				MN37-C		MN37RF-C			
				MN48-C	PN48-C	MN48RF-C			
				MN60-C	PN60-C				
						MN80-3D	PN80-3D		
		MN7RF-50		MN9-C	PN14-C	MN7RF-C	Adaptor AU230-130-D with die set MN...-C and indentor PN...-C or with die set MN...RF-C and die set MN...F-C		
		MN12F-50		MN12-C		MN12F-C			
		MN17F-50		MN17-C	PN24-C	MN17F-C			
		MN20F-50		MN20-C		MN20F-C			
				MN29-C	PN37-C	MN29F-C			
				MN35-C		MN35F-C			
DIE SET		DIE SET							
KE4-15			MTT6-60C						
KE16-15			MTT10-60C						
KE35-15		MTT16-50	MTT16-60C						
		MTT25-50	MTT25-60C						
		MTT35-50	MTT35-60C						
		MTT50-50	MTT50-60C						
		MTT70-50	MTT70-60C						
		MTT95-50	MTT95-60C						
		MTT120-50	MTT120-60C						
DIE SET	COMP. APERTURE		DIE SET						
KE4-15	1								
	1,5								
	2,5								
	2,5								
KE4-15 KE16-15	4								
KE16-15	6								
	10								
KE16-15 KE35-15	16		MTT16-50						
KE35-15	35		MTT35-50						

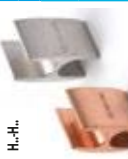
DIE SELECTOR CHART



APPLICATION	CONDUCTOR		CONNECTOR		HYDRAULIC TOOLS						ECW-H3D	RHU520			
	Conductor Size sqmm		CONNECTOR		HT45-E	HT51	HT60C	HT81-UD	HT120 and tools and						
	Run	Tap	CONNECTOR	CONNECTOR	B450ND-BV	B500E	B600C	RHU81-D	heads with 130 kN						
TAP-OFF ON COPPER CONDUCTOR	 C...-ST  C...-C	6 ÷ 1,5	C6-C6ST	C6-C6	MC6	MC6-50		MC6-50							
		10	C10-C10ST	C10-C10	MC10	MC10-50		MC10-50		MC10-C					
		16	C16-C16ST	C16-C16											
		25 ÷ 16	C25-C10ST	C25-C10											
		25	C25-C25ST	C25-C25											
		40 ÷ 35	C35-C16ST	C35-C16											
		40 ÷ 35	C35-C35ST	C35-C35											
		50													
		70 ÷ 63	C70-C25NST	C70-C25N											
		50	C50-C25ST	C50-C25											
		*50	C50-C50ST	C50-C50											
		*70 ÷ 50	C70-C35ST	C70-C35											
		*70 ÷ 50	C70-C70ST	C70-C70											
		100 ÷ 95	C95-C35ST	C95-C35											
		100 ÷ 95	C95-C70ST	C95-C70											
		100 ÷ 95	C95-C95ST	C95-C95											
		125 ÷ 110	C120-C120ST	C120-C120											
		160 ÷ 150	C150-C120ST	C150-C120											
		125													
		150	C150-C150ST	C150-C150											
125															
185	C185-C95ST	C185-C95													
185 ÷ 120	C185-C185ST	C185-C185													
240 ÷ 150	C240-C120ST	C240-C120													
COPPER CONDUCTORS	 H...  DK...-M...  DR...-2M12-51AS	Conductor Size sqmm		CONNECTOR		CONNECTOR		CONNECTOR		CONNECTOR		CONNECTOR			
		Run	Tap	CONNECTOR		CONNECTOR		CONNECTOR		CONNECTOR		CONNECTOR			
		70	70	H70-H70	H70-H70ST										
		95	95	H95-H95	H95-H95ST										
		120	120	H120-H120	H120-H120ST										
		Cond. Size sqmm		CONNECTOR		CONNECTOR		CONNECTOR		CONNECTOR		CONNECTOR		CONNECTOR	
		2x 50		DK50-M12		DK50-M12		DK50-M12		DK50-M12		DK50-M12		DK50-M12	
		2x 70		DK70-M12		DK70-M12		DK70-M12-51AS		DK70-M12-51AS		DK70-M12-51AS		DK70-M12-51AS	
		2x 95		DK95-M12		DK95-M12		DK95-M12-51AS		DK95-M12-51AS		DK95-M12-51AS		DK95-M12-51AS	
		2x 120		DK120-M12		DK120-M12		DK120-M12-51AS		DK120-M12-51AS		DK120-M12-51AS		DK120-M12-51AS	

○ = Hexagonal crimp ○ = oval crimp ○ = circular crimp *When using die set type MC70-50, the conductors marked with a star must be annealed. ○ The Type H81-UD and RHU81-D Tools use the same dies as the HT51, with the aid of a Type 632051 spring

DIE SELECTOR CHART

APPLICATION	CONDUCTOR		CONNECTOR		HYDRAULIC TOOLS						
	CONDUCTOR		CONNECTOR		HT45-E B450ND-BV	HT51 RH50 B500ND	HT81-UD RHU81-D Ø	HT 120 and tools and heads with 130 kN crimping force		ECW-H3D	RHU520
	Cond. Size sqmm	TERMINAL	TERMINAL	TERMINAL	DIESET	DIESET	DIESET	DIESET	DIESET	DIE SET	DIE SET
 H.V. COPPER CONDUCTORS	25 R	MT25-ID	MT25-GC	CA25-ML, CA25-2ML, MT25-C.	MMT25-50	MMT25-U	MMT25-C				
	35 RC/Δ ÷ 40 S	MT40S-ID	MT40S-GC	CA40S-ML, CA40S-2ML, MT40S-C.	MMT50-50	MMT50-U	MMT50-C				
	50 RC	MT50R-ID	MT50R-GC	CA50R-ML, CA50R-2ML, MT50R-C.	MMT95-50	MMT95-U	MMT95-C				
	50 S	MT50S-ID	MT50S-GC	CA50S-ML, CA50S-2ML, MT50S-C.							
	63 S ÷ 70 S	MT70S-ID	MT70S-GC	CA70S-ML, CA70S-2ML, MT70S-C.							
	80 S ÷ 95 RC	MT95R-ID	MT95R-GC	CA95R-ML, CA95R-2ML, MT95R-C.							
	95 S ÷ 100 S	MT95S-ID	MT95S-GC	CA95S-ML, CA95S-2ML, MT95S-C.							
	120 RC/S ÷ 150 RC	MT150R-ID	MT150R-GC	CA150R-ML, CA150R-2ML, MT150R-C.							
	150 S ÷ 160 RC	MT150S-ID	MT150S-GC	CA150S-ML, CA150S-2ML, MT150S-C.							
	160 S ÷ 200 RC	MT200R-ID	MT200R-GC	CA200R-ML, CA200R-2ML, MT200R-C.							
185 BR/BS	MT185-ID	MT185-GC	CA185-ML, CA185-2ML, MT185-C.								
200 S ÷ 240 RC	MT240R-ID	MT240R-GC	CA240R-ML, CA240R-2ML, MT240R-C.								
240 S ÷ 315 RC	MT315R-ID	MT315R-GC	CA315R-ML, CA315R-2ML, MT315R-C.								
315 S	MT315S-ID	MT315S-GC	CA315S-ML, CA315S-2ML, MT315S-C.								
400 R	MT400-ID		2A80-ML, 2A80-2ML, ME80-C						ME80-3D	ME80-520	
500 R	MT500-ID		2A100-ML, 2A100-2ML, ME100-3D						ME100-3D	ME100-520	
600 R ÷ 630 R	MT630-ID		2A120-ML, 2A120-2ML, ME120-3D						ME120-3D	ME120-520	

DIE SELECTOR CHART FOR DEEP STEPPED INDENTING WITH CONTAINING DIES

APPLICATION	CONDUCTOR	CONNECTOR		HYDRAULIC TOOLS						
	CONDUCTOR	LUGS	CONDUCTOR	DIE HOLDER	DIE	DIE	DIE	DIE	DIE	DIE
	Conductor Size sqmm	LUGS	CONDUCTOR	DIE HOLDER	DIE	DIE	DIE	DIE	DIE	DIE
 ALUMINIUM CONDUCTORS	10	CAA10-M.		AU130-150	MV35	MUA35	PS130-35/E			
	16	CAA16-M.	MTA16-C							
	25	CAA25-M.	MTA25-C							
	35	CAA35-M.	MTA35-C							
	50	CAA50-M.	MTA50-C							
	70	CAA70-M.	MTA70-C							
	95	CAA95-M.	MTA95-C							
	120	CAA120-M.	MTA120-C							
	150	CAA150-M.	MTA150-C							
	185	CAA185-M.	MTA185-C							
240	CAA240-M.	MTA240-C		AU130-240	MV240	MUA240	PS130-240/E			
300	CAA300-34M.				MUA300-34					
 ALUMINIUM CONDUCTORS	16	AA16-M.								
	25	AA25-M.								
	35	AA35-M.								
	50	AA50-M.								
	70	AA70-M.								
	95	AA95-M.								
	120	AA120-M.								
150	AA150-M.									
185	AA185-M.									
240	AA240-M.									
300	AA300-34M.									

◊ The Type HT81-UD and RHU81-D Tools use the same dies as the HT51, with the aid of a Type 6S22051 spring

◊ = Deep indent crimp ◊ = Hexagonal crimp ◊ = circular crimp

DIE SELECTOR CHART FOR DEEP STEPPED INDENTING WITH CONTAINING DIES

ALUMINIUM CONDUCTORS	Conductor Size sqmm		SPLICE		Conductor Size sqmm		SPICES		DIE HOLDER		DIE		INDENTOR	
	Al	Al/Cu	MTMA10-GC	MTMA16/1	MTMA16-GC	MTMA16	MTMA16-10GC	MVM35	MUA35	MVM35	MUA35	PS130-35/E		
	10		MTMA10-GC	MTMA16/1	MTMA16-GC	MTMA16	MTMA16-10GC							
	16		MTMA16-GC	MTMA25/1	MTMA25-GC	MTMA25	MTMA25-10GC							
	25		MTMA25-GC	MTMA35/1	MTMA35-GC	MTMA35	MTMA35-16GC							
	35		MTMA35-GC	MTMA50/1	MTMA50-GC	MTMA50	MTMA50-25GC							
	50		MTMA50-GC	MTMA70/1	MTMA70-GC	MTMA70	MTMA70-35GC							
	70		MTMA70-GC	MTMA95/1	MTMA95-GC	MTMA95	MTMA95-50GC							
	95		MTMA95-GC	MTMA120/1	MTMA120-GC	MTMA120	MTMA120-70GC							
	120		MTMA120-GC	MTMA150/1	MTMA150-GC	MTMA150	MTMA150-70GC							
	150		MTMA150-GC	MTMA185/1	MTMA185-GC	MTMA185	MTMA185-120GC							
	185		MTMA185-GC	MTMA240/1	MTMA240-GC	MTMA240	MTMA240-150GC							
	240		MTMA240-GC	MTMAD300/1	MTMAD300-GC	MTMAD300	MTMAD300-185GC							
	300		MTMAD300-GC				MTMAD300-185GC							
							MTMAD300-240GC							







MTMA...GC

ALUMINIUM CONDUCTORS

= Deep indent crimp





PRE-ROUNDERS SELECTION		DIE-SUPPORT		DIES DESCRIPTION		DIES SEQUENCE	
ALUMINIUM CONDUCTOR SIZE sqmm	PRE-ROUNDER	DIE-SUPPORT	1) AU 130... DIE-HOLDER	Used to house dies and pre-rounders.	CONDUCTOR ROUNDING	CRIMPING	
25	UP 130-25		2) UP 130... PRE-ROUNDERS	Used to round aluminium sectoral conductors in order to introduce them into circular connectors. Each pre-rounder is made of two parts: the upper part is housed in die-holder AU 130... and the lower part is locked onto AC 130-P... die support.	1	1	
35	UP 130-35		3) AC 130-P... DIE-SUPPORT	Houses lower part of pre-rounder UP 130....	2	4	
50	UP 130-50	AC 130-P	4) MUA... DIES	Containing dies.	3	5	
70	UP 130-70		5) PS 130... E INDENTORS	Such indentors are specifically engineered for deep indentation of aluminium conductors of any stranding configuration.			
95	UP 130-95						
120	UP 130-120						
150	UP 130-150						
185	UP 130-185						
240	UP 130-240						

DIE SELECTOR CHART

APPLICATION	CONDUCTOR	CONDUCTOR	CONDUCTOR	HYDRAULIC TOOLS																	
				HT 120 and tools and heads with 130 kN crimping force			HT131-UC			RHU131-C			B1300-UC			ECW-H3D			RHU230-630		
				HEXAGONAL CRIMP	DIE SET	DIE HOLDER	DIE	INDENTOR	DIE SET	ADAPTOR	INDENT CRIMP	DIE	INDENTOR	DIE SET	ADAPTOR	INDENT CRIMP	DIE	INDENTOR			
 CMA...ML	Conductor Size sqmm	LUGS		HEXAGONAL CRIMP	DIE SET	DIE HOLDER	DIE	INDENTOR	DIE SET	ADAPTOR	INDENT CRIMP	DIE	INDENTOR	DIE SET	ADAPTOR	INDENT CRIMP	DIE	INDENTOR			
	300	CAA300-34-M..		HEXAGONAL CRIMP	MK34L-C	AU130-240	MUA300-34	PS130-240/E													
	300	CAA300-M16																			
	400	CAA400-M16																			
	500	CAA500-M16TMBD																	PS230-400-5E		
	630	CAA630-4M8																	PS230-630-6E		
 AA...ML	Conductor Size sqmm	LUGS		HEXAGONAL CRIMP	DIE SET	DIE HOLDER	DIE	INDENTOR	DIE SET	ADAPTOR	INDENT CRIMP	DIE	INDENTOR	DIE SET	ADAPTOR	INDENT CRIMP	DIE	INDENTOR			
	300	AA300-34-M..		HEXAGONAL CRIMP	MK34L-C	AU130-240	MUA300-34	PS130-240/E													
	300	AA300-M16																			
	400	AA400-M16																			
	500	AA500-40-M16																	PS230-400-5E		
	630	AA630-M16																	PS230-630-6E		
 MTMA...	Conductor Size sqmm	SPLICES	SPLICES	HEXAGONAL CRIMP	DIE SET	DIE HOLDER	DIE	INDENTOR	DIE SET	ADAPTOR	INDENT CRIMP	DIE	INDENTOR	DIE SET	ADAPTOR	INDENT CRIMP	DIE	INDENTOR			
	300	MTMAD300/1	MTMAD300-GC	HEXAGONAL CRIMP	MK34L-C	AU130-240	MUA300-34	PS130-240/E													
				Conductor Size sqmm	95	MTMAD300-95-GC															
				150	MTMAD300-150-GC																
				185	MTMAD300-185-GC																
	300	MTMAD300-GC	MTMAD300-240-GC	HEXAGONAL CRIMP																	
				Conductor Size sqmm	240	MTMA400-240-GC															
	400	MTMA400/1	MTMA400-GC	HEXAGONAL CRIMP																	
	500	MTMA500-40/1	MTMA500-GC	HEXAGONAL CRIMP																	
				Conductor Size sqmm	240	MTMA400-240-GC															
	500	MTMA500-GC	MTMA500-300-GC	HEXAGONAL CRIMP																	
				Conductor Size sqmm	300	MTMA400-300-GC															
630	MTMA630/1	MTMA630-GC	HEXAGONAL CRIMP																		
			Conductor Size sqmm	400	MTMA400-300-GC																
 AAC150-M10  AA150S-2M12/295T	CONDUCTOR	CONDUCTOR	CONDUCTOR	HEXAGONAL CRIMP	DIE SET	DIE HOLDER	DIE	INDENTOR	DIE SET	ADAPTOR	INDENT CRIMP	DIE	INDENTOR	DIE SET	ADAPTOR	INDENT CRIMP	DIE	INDENTOR			
	Conductor Size sqmm	LUGS	LUGS	HEXAGONAL CRIMP																	
	150	AAC150-M10	AAC150-M10	HEXAGONAL CRIMP																	

 = Deep indent crimp
 = Hexagonal crimp

DIE SELECTOR CHART

APPLICATION	CONDUCTOR	ALUMINIUM CONNECTORS AND BIMETALLIC (Al - Cu)				HYDRAULIC TOOLS						
		LUGS	LUGS	LUGS	SPLICE	HT45-E B450ND-BV	HT51 RH50 B500ND	HT81-UD RHU81-D ◊	HT 120 and tools and heads with 130 kN crimping force	ECW-H3D	RHU450	RHU520
 CAA-M.	Conductor Size sqmm	CAA10-M.			MTMA10-..	HEXAGONAL DIE SET	HEXAGONAL DIE SET	HEXAGONAL DIE SET	HEXAGONAL DIE SET	HEXAGONAL DIE SET	HEXAGONAL DIE SET	HEXAGONAL DIE SET
	10											
	16	CAA16-M.	MTA16-C	AA16-M.	MTMA16-..	MK16B-50	MK16B-50	MK16B-50	MK16-C			
	25	CAA25-M.	MTA25-C	AA25-M.	MTMA25-..							
 MTA-C	35	CAA35-M.	MTA35-C	AA35-M.	MTMA35-..							
	35	CAA35-20-M.	MTA35-20-C14-60		MTMA35-20-..							
 AA-M.	50	CAA50-M.	MTA50-C	AA50-M.	MTMA50-..	MK20	MK20B-50	MK20B-50	MK20-C			
	70	CAA70-M.	MTA70-C.	AA70-M.	MTMA70-..							
 MTMA.	95	CAA95-M.	MTA95-C.	AA95-M.	MTMA95-..							
	120	CAA120-M.	MTA120-C.	AA120-M.	MTMA120-..							
	150	CAA150-M.	MTA150-C.	AA150-M.	MTMA150-..							
	185	CAA185-M.	MTA185-C.	AA185-M.	MTMA185-..							
	240	CAA240-M.	MTA240-C.	AA240-M.	MTMA240-..							
	300	CAA300-34-M.		AA300-34-M.	MTMAD300.							
	300	CAA300-M.		AA300-M.	MTMA300-..							
	400	CAA400-M.		AA400-M16	MTMA400-..							
	500	CAA500-M16TN8D		AA500-40M16	MTMA500-40/1							
	500				MTMA500-GC							
	630	CAA630-4M8		AA630-M16	MTMA630-GC							

◊ = Hexagonal crimp

◊ The Type HT81-UD and RHU81-D Tools use the same dies as the HT51, with the aid of a Type 6522051 spring

ALUMINIUM CONDUCTORS



DIE SELECTOR CHART

APPLICATION	CONDUCTOR	BIMETALLIC CONNECTORS (Al - Cu)	HYDRAULIC TOOLS					
			HT45-E B450ND-BV	HT51 RH50 B500 B500ND	HT81-UD RHU81-D ◊	HT 120 and tools and heads with 130 kN crimping force	ECW-H3D	RHU230-630
	Conductor Size sqmm	LUGS	HEXAGONAL DIE SET	HEXAGONAL DIE SET	HEXAGONAL DIE SET	HEXAGONAL DIE SET	HEXAGONAL DIE SET	HEXAGONAL DIE SET
 CBMC...M..	35	CBMC35-M..	M140	M140/9-50	M140/9-50	M140/2X9-C		
	50	CBMC50-M..	M140	M140/9-50	M140/9-50	M140/2X9-C		
	70	CBMC70-M1..	M173	M173/9-50	M173/9-50	M173/2X9-C		
	95	CBMC95-M..	M173	M173/9-50	M173/9-50	M173/2X9-C		
	120	CBMC120-M..	M173	M173/9-50	M173/9-50	M173/2X9-C		
	150	CBMC150-M..		M235/9-50	M235/9-50	M235/2X9-C		
	185	CBMC185-M..		M235/9-50	M235/9-50	M235/2X9-C		
	240	CBMC240-M..		M235/9-50	M235/9-50	M235/2X9-C		
	300	CBMC300-M..		M260/9-50	M260/9-50	M260/9-C		
								Adaptor AU230-130D with die set M...C

◊ = Hexagonal crimp

◊ The Type HT81-UD and RHU81-D Tools use the same dies as the HT51, with the aid of a Type 6522051 spring

DIE SELECTOR CHART

APPLICATION	CONDUCTOR	CONNECTOR		B15MD DIE SET	HT45-E B450ND-BV DIE SET	HT51 B500 B500ND DIE SET	HT60C B600C B600CND DIE SET	HYDRAULICTOOLS		HT 120 and tools and heads with 130 kN crimping force	ECW-H3D DIE SET	RHU520 DIE SET	
		CONDUCTOR	LUGS					SPICES	HT81-UD RHU81-D V DIE SET				HT60C B600CND DIE SET
 Q.. DIN 46234	6-10		Q10..										
	10-16		Q16..										
	16-25		Q25..										
	25-35		Q35..										
	35-50		Q50..										
	50-70		Q70..										
	70-95		Q95..										
	95-120		Q120..										
	120-150		Q150..										
	150-185		Q185..										
	185-240		Q240..										
	 DR.. DIN 46235 - 46267 T.1	6		DR6..N	DSV6								
		10		DR10..N	DSV10	MKS5/8-15	MKS5-50	MKS5-60C	MKS5-50	MKS5-60C	MKS5-50		
		16		DR16..N	DSV16		MKS6-50	MKS6-60C	MKS6-50	MKS6-60C	MKS6-50		
		25		DR25..N	DSV25		MKS8-50	MKS8-60C	MKS8-50	MKS8-60C	MKS8-50		
		35		DR35..N	DSV35		MKS10-50	MKS10-60C	MKS10-50	MKS10-60C	MKS10-50		
		50		DR50..N	DSV50		MKS12-50	MKS12-60C	MKS12-50	MKS12-60C	MKS12-50		
		70		DR70..N	DSV70		MKS14-50	MKS14-60C	MKS14-50	MKS14-60C	MKS14-50		
95			DR95..N	DSV95		MKS16-50	MKS16-60C	MKS16-50	MKS16-60C	MKS16-50			
240			DR240..N	DSV240		MKS18-50	MKS18-60C	MKS18-50	MKS18-60C	MKS18-50			
300			DR300..N	DSV300		MKS20-50	MKS20-60C	MKS20-50	MKS20-60C	MKS20-50			
400			DR400..N	DSV400		MKS22-50	MKS22-60C	MKS22-50	MKS22-60C	MKS22-50			
500			DR500..N	DSV500		MKS25-50	MKS25-60C	MKS25-50	MKS25-60C	MKS25-50			
625			DR625..N	DSV625		MKS28-50	MKS28-60C	MKS28-50	MKS28-60C	MKS28-50			
800			DR800..N	DSV800		MKS32-50*	MKS32-60C	MKS32-50	MKS32-60C	MKS32-50			
1000			DR1000..N	DSV1000									
 HR..N HR5..N HR10..N HR16..N HR25..N HR35..N HR50..N HR70..N HR95..N HR120..N HR150..N HR185..N HR240..N HR300..N HR400..N HR500..N HSV.. COPPER CONDUCTORS		6	HR6..N	HR56..N	HSV6								
		10	HR10..N	HR510..N	HSV10	MH10	MH10-50	MH10-60C	MH10-50	MH10-60C	MH10-50		
		16	HR16..N	HR516..N	HSV16	MH16	MH16-50	MH16-60C	MH16-50	MH16-60C	MH16-50		
	25	HR25..N	HR525..N	HSV25	MH25	MH25-50	MH25-60C	MH25-50	MH25-60C	MH25-50			
	35	HR35..N	HR535..N	HSV35	MH35	MH35-50	MH35-60C	MH35-50	MH35-60C	MH35-50			
	50	HR50..N	HR550..N	HSV50	MH50	MH50-50	MH50-60C	MH50-50	MH50-60C	MH50-50			
	70	HR70..N	HR570..N	HSV70	MH70	MH70-50	MH70-60C	MH70-50	MH70-60C	MH70-50			
	95	HR95..N	HR595..N	HSV95	MH95	MH95-50	MH95-60C	MH95-50	MH95-60C	MH95-50			
	120	HR120..N	HR5120..N	HSV120	MH120	MH120-50	MH120-60C	MH120-50	MH120-60C	MH120-50			
	150	HR150..N	HR5150..N	HSV150	MH150	MH150-50	MH150-60C	MH150-50	MH150-60C	MH150-50			
	185	HR185..N	HR5185..N	HSV185		MH185-50	MH185-60C	MH185-50	MH185-60C	MH185-50			
	240	HR240..N	HR5240..N	HSV240		MH240-50	MH240-60C	MH240-50	MH240-60C	MH240-50			
	300	HR300..N	HR5300..N	HSV300		MH300-50*	MH300-60C	MH300-50	MH300-60C	MH300-50			
	400												
	500												
	630												

 = Indented crimp

 = Hexagonal crimp

◊ The Type HT81-UD and RHU81-D Tools use the same dies as the HT51, with the aid of a Type 6522051 spring

NB: for through connectors this is the number of crimps per conductor * Only for: B500, B500ND and RH50

DIE SELECTOR CHART

APPLICATION	CONDUCTOR		CONNECTOR		HYDRAULIC TOOLS			
	Conductor Size sqmm	Conductor Size AWG	LUGS	SPLICE	HT 120 and tools and heads with 130 kN crimping force		HT 51 RH50 B500 B500ND	
					DIE SET	DIE SET	DIE SET	DIE SET
C...	10	8	C8..	BSCl8	ME03/2-15	MY2-50	MY2-C	RHU520
CL...	16	6	C6..	BSCl6	MA03/3-15	MY3-50	MY3-C	
CL...	25	4	C4..	BSCl4		MY4-50	MY4-C	
CL...	35	3	C3..	BSCl3		MY5-50	MY5-C	
CL...	50	2	C2..	BSCl2		MY6-50	MY6-C	
CL...	70	1	C1..	BSCl1		MY7-50	MY7-C	
CL...	95	1/0	C1/0.	BSCl1/0		MY10-50	MY10-C	Adaptor AU520-130-C with die set MY.-C
CL...	120	2/0	C2/0.	BSCl2/0		MY14-50	MY14-C	
CL...	150	3/0	C3/0.	BSCl3/0		MY16-50	MY16-C	
CL...	185	4/0	C4/0.	BSCl4/0		MY19-50	MY19-C	
BSCL	240	250 MCM	C250..	BSCl250		MY24-50	MY24-C	
BSCL	300	300 MCM	C300..	BSCl300		MY30-50	MY30-C	
BSCL	350	350 MCM	C350..	BSCl350		MY36-50	MY36-C	
BSCL	400	400 MCM	C400..	BSCl400		MY37-50	MY37-C	
BSCL	500	500 MCM	C500..	BSCl500		MY48-50	MY48-C	
BSCL	600	600 MCM	C600..	BSCl600		MY60-C	MY60-C	
BSCL	750	750 MCM	C750..	BSCl750		MY76-C	MY76-C	



N.B.: Number inside symbol indicates the number of crimps for C short barrel lugs only.

○ = Circular crimp ◡ = Indent crimp ◡ = Hexagonal crimp

COPPER CONDUCTORS





DIE SELECTOR CHART

APPLICATION	CONDUCTOR	CONNECTOR	HYDRAULIC TOOLS						HYDRAULIC TOOLS							
			B15MD	HT45-E B450ND-BV	HT51 B500 B500ND	HT60C RH60C B600CND B600CND TN60C	HT81-UD RHU81-D Ø	HT120 and tools and heads with 130 kN crimping force	ECW-H3D	RHU520						
Conductor Size sqmm	TERMINAL SPLICE	DIE SET	NEST	INDENTOR	DIESET	NEST	INDENTOR	DIESET	NEST	INDENTOR	DIESET	NEST	INDENTOR	DIESET	NEST	INDENTOR
<p style="text-align: center;">COPPER CONDUCTORS</p> <div style="display: flex; justify-content: space-around; align-items: center;"> <div style="text-align: center;">  T-M </div> <div style="text-align: center;">  L-L </div> <div style="text-align: center;">  T-L </div> </div>	4-6	T6-M. T6-L.	L6-T.	MS4/10-15	MA1	PA1	MS6	MA1-50	PA1-50	MS6-50	MA1-50	PA1-50	MS6-50	MA1-50	PA1-50	MS6-C
	10	T10-M. T10-L.	L10-T.	MS4/10-15 MS10/16-15	MA2.3	PA5	MS10	MA2.3-50	PA5-50	MS10-50	MA2-C	PA10-C	MS10-50	MA2-C	PA10-C	MS10-C
	16	T16-M. T16-L.	L16-T.	MS10/16-15	MA5	PA10	MS16	MA7-50	PA10-50	MS16-50	MA5-50	PA10-50	MS16-50	MA3-C	PA10-C	MS16-C
	25	T25-M. T25-L.	L25-T.		MA7		MS25	MA10	PA19-50	MS25-50	MA5-50	PA19-50	MS25-50	MA19-C	PA24-C	MS25-C
	35	T35-M. T35-L.	L35-T.		MA10		MS35	MA14-50	PA24-50	MS35-50	MA7-50	PA24-50	MS35-50	MA14-C	Adaptor AU230-130-D with die set MA...-C and indentor PA...-C	MS35-C
	50	T50-M. T50-L.	L50-T.				MS50	MA19-50	Adaptor AU520-130-C with die set MA...-C with indentor and indentor PA...-C	MS50-50	MA10-50	Adaptor AU230-130-D with die set MA...-C and indentor PA...-C	MS50-50	MA19-C	Adaptor AU520-130-C with die set MA...-C with indentor and indentor PA...-C	MS50-C
	70	T70-M. T70-L.	L70-T.				MS70	MA24-50	MS70-50	MA14-50	MA14-50	MS70-50	MA14-C	MS70-C	MS70-C	
	95	T95-M. T95-L.	L95-T.				MS95		MS95-50	MA19-50	MA19-50	MS95-50	MA19-C	MS95-C	MS95-C	
	120	T120-M. T120-L.	L120-T.				MS120		MS120-50	MA24-50	MA24-50	MS120-50	MA24-C	MS120-C	MS120-C	
	150	T150-M. T150-L.	L150-T.				MS150		MS150-50	MA30-C	MA30-C	MS150-50	MA30-C	MS150-C	MS150-C	
	185	T185-M. T185-L.	L185-T.						MS185-50	MA37-C	MA37-C	MS185-50	MA37-C	MS185-C	MS185-C	
	240	T240-M. T240-L.	L240-T.						MS240-50	MA48-C	MA48-C	MS240-50	MA48-C	MS240-C	MS240-C	
	300	T300-M. T300-L.	L300-T.						MS300-50*	MA60-C	MA60-C	MS300-50*	MA60-C	MS300-C	MS300-C	
	400	T400-M. T400-L.	L400-T.											MS400-C	MS400-C	

* Only for B500, B500ND and RH50 ◊ The type HT81-UD and RHU81-D Tools use the same dies as the HT51, with the aid of a Type 6522051 spring



DIE SELECTOR CHART

APPLICATION	HYDRAULIC TOOLS											
	Conductor Size sqmm		MATERIAL (Al)		HT45-E B450ND-BV	HT51 RH50 B500 B500ND	HT60C RH60C B600C B600CND	HT81-UD RHU81-D Ø	HT 120 and tools and heads with 130 kN crimping force	ECW-H3D	RHU450	RHU520
	mm/sm	re/se	LUGS	SPLICES	DIE SET	DIE SET	DIE SET	DIE SET	DIE SET	DIE SET	DIE SET	DIE SET
 AAD.  DSVA.	10	16										
	16	25	AAD16-M..		MK12B (4)	MK12B-50 (4)	MK12B-60C (4)	MK12B-50 (4)	MK12-C (2)			
	16	25		DSVA16	MK12B (3)	MK12B-50 (3)	MK12B-60C (3)	MK12B-50 (3)	MK12-C (1)			
	25	35	AAD25-M..	DSVA25	MK12B (4)	MK12B-50 (4)	MK12B-60C (4)	MK12B-50 (4)	MK12-C (2)			
	35	50	AAD35-M..	DSVA35	MK14B (3)	MK14B-50 (3)	MK14B-60C (3)	MK14B-50 (3)	MK14-C (2)			
	50	70	AAD50-M..	DSVA50	MK16B (5)	MK16B-50 (5)	MK16B-60C (5)	MK16B-50 (5)	MK16-C (2)			
	70	95	AAD70-M..	DSVA70	MK18B (6)	MK18B-50 (6)	MK18B-60C (6)	MK18B-50 (6)	MK18-C (3)			
	95	120	AAD95-M..	DSVA95	MK22B (6)	MK22B-50 (6)	MK22B-60C (6)	MK22B-50 (6)	MK22-C (3)			
	120	150	AAD120-M..	DSVA120	MK22B (6)	MK22B-50 (6)	MK22B-60C (6)	MK22B-50 (6)	MK22-C (3)			
	150	185	AAD150-M..	DSVA150		MK25B-50 (6)	MK25B-60C (6)	MK25B-50 (6)	MK25-C (3)			
185	240	AAD185-M..	DSVA185		MK28B-50 (6)	MK28B-60C (6)	MK28B-50 (6)	MK28L-C (3)				
240	300	AAD240-M..	DSVA240		MK32B-50 (8)	MK32B-60C (8)		MK32L-C (3)				
300		AAD300-M..	DSVA300			MK34B-60C (8)		MK34L-C (3)				
400		AAD400-M..	DSVA400 / DSVA401						MK38-3D (4)	MK38-450 (4)	MK38-520 (4)	
500		AAD500-M..	DSVA500 / DSVA501						MK44-3D (4)	MK44-450 (4)	MK44-520 (4)	
625			DSVA625							MK52-450 (5)	MK52-520 (5)	
800			DSVA800							MK58-450 (5)	MK58-520 (5)	
1000			DSVA1000							MK60-450 (5)	MK60-520 (5)	





















mm = round stranded
 sm = sector stranded
 re = round solid
 se = sector solid

⬡ = Hexagonal crimp

NB: for through connectors this is the number of crimps per conductor

⬢ The Type HT81-UD and RHU81-D Tools use the same dies as the HT51, with the aid of a Type 6522051 spring

MUT DIES CROSS REFERENCE CHART

DIE INDEX	DIETYPE			
	 14.6 tons tools 131 series	 6 tons tools 51 series	 6 tons tools 45 series	 6 & 6.4 tons tools 54 & 55 series
161	MUT9999-C	MUT9999-50	MUT9999	MUT9999-W
162	MUT9998-C	MUT9998-50	MUT9998	MUT9998-W
163	MUT9997-C	MUT9997-50	MUT9997	MUT9997-W
164	MUT9996-C	MUT9996-50	MUT9996	MUT9996-W
166	MUT9995-C	MUT9995-50	MUT9995	MUT9995-W
167	MUT9958-C	-	-	MUT9958-W
168	MUT9974-C	-	-	-
169	MUT9979-C	-	-	-
170	MUT9973-C	-	-	-
203	MUT9943-C	MUT9943-50	-	MUT9943-W
204	MUT9941-C	MUT9941-50	-	MUT9941-W
209	MUT9972-C	-	-	-
239	MUT9993-C	MUT9993-50	MUT9993	MUT9993-W
242	MUT9967-C	-	-	-
243	MUT9991-C	MUT9991-50	MUT9991	MUT9991-W
247	-	MUT9954-50	-	MUT9954-W
249	MUT9990-C	MUT9990-50	MUT9990	MUT9990-W
253	MUT9957-C	-	-	-
255	MUT9962-C	-	-	-
261	MUT9956-C	-	-	-
296*	 MUT9924-C	-	-	-
297*	 MUT9923-C	-	-	-
298*	 MUT9921-C	-	-	-
299*	 MUT9918-C	-	-	-
300*	 MUT9916-C	-	-	-
305	MUT9977-C	-	-	-
316	MUT9976-C	-	-	-
317	MUT9965-C	-	-	-
322	MUT9971-C	-	-	-
324*	 MUT9920-C	-	-	-
327	MUT9961-C	-	-	-
346*	 MUT9928-C	-	-	-
348*	 MUT9926-C	-	-	-
373	MUT9989-C	MUT9989-50	-	MUT9989-W
374*	 MUT9929-C	-	-	-
375*	 MUT9927-C	-	-	-
467*	 MUT9922-C	-	-	-
470*	 MUT9919-C	-	-	-
471*	 MUT9925-C	-	-	-
472*	 MUT9917-C	-	-	-
473*	 MUT9915-C	-	-	-
490	MUT9966-C	-	-	-
642	MUT9970-C	-	-	-
654	MUT9975-C	MUT9975-50	-	-
655	MUT9968-C	-	-	-
658	MUT9988-C	MUT9988-50	-	MUT9988-W
659	MUT9987-C	MUT9987-50	MUT9987	MUT9987-W
936*	 MUT9914-C	-	-	-
698	MUT9986-C	MUT9986-50	MUT9986	MUT9986-W
699	MUT9985-C	MUT9985-50	-	MUT9985-W
708	MUT9959-C	-	-	-
756	MUT9964-C	-	-	-
788	MUT9950-C	-	-	-
790	MUT9969-C	-	-	-
BG	MUT9984-C	MUT9984-50	-	MUT9984-W
C	MUT9983-C	MUT9983-50	MUT9983	MUT9983-W
D	MUT9978-C	-	-	-
D3	MUT9981-C	MUT9981-50	-	-
E	MUT9982-C	MUT9982-50	-	MUT9982-W
F	MUT9960-C	-	-	-
K840	-	-	-	MUT9942-W
N	MUT9955-C	-	-	-
O	MUT9980-C	MUT9980-50	-	MUT9980-W

*Stainless steel dies

RHU600 DIES CROSS REFERENCE CHART

DIE INDEX	DIE TYPE			
	CEMBRE	ALCOA	HUSKIE	BURNDY
10SH	M10SH-600	6010SH	HA60-01	-
12SH	M12SH-600	6012SH	HA60-02	-
14SH	M14SH-600	6014SH	HA60-03	-
16SH	M16SH-600	6016SH	HA60-04	-
18SH	M18SH-600	6018SH	HA60-05	-
20SH	M20SH-600	6020SH	HA60-06	-
74SH	M74SH-600	6074SH	HA60-07	-
75SH	M75SH-600	6075SH	HA60-08	-
76SH	M76SH-600	6076SH	HA60-09	-
76.1SH	M76.1SH-600	6076.1SH	-	-
20AH	M20AH-600	6020AH	HA60-20	20AH60
24AH	M24AH-600	6024AH	HA60-21	24AH60
27AH	M27AH-600	6027AH	HA60-22	27AH60
30AH	M30AH-600	6030AH	HA60-23	30AH60
34AH	M34AH-600	6034AH	HA60-24	34AH60
36AH	M36AH-600	6036AH	HA60-25	36AH60
38AH	M38AH-600	6038AH	HA60-26	38AH60
40AH	M40AH-600	6040AH	HA60-27	40AH60
74AH	M74AH-600	6074AH	HA60-28	-
75AH	M75AH-600	6075AH	HA60-29	75AH60
76AH	M76AH-600	6076AH	HA60-30	76AH60
07CD	M7CD-600	6007CD	HA60-40	07CD60
08CD	M8CD-600	6008CD	HA60-41	08CD60
09CD	M9CD-600	6009CD	HA60-42	09CD60
10CD	M10CD-600	6010CD	HA60-43	10CD60
11CD	M11CD-600	6011CD	HA60-44	11CD60
12CD	M12CD-600	6012CD	HA60-45	12CD60
13CD	M13CD-600	6013CD	HA60-46	13CD60
14CD	M14CD-600	6014CD	HA60-47	14CD60
15CD	M15CD-600	6015CD	HA60-48	15CD60
16CD	M16CD-600	6016CD	HA60-49	16CD60
17CD	M17CD-600	6017CD	HA60-50	17CD60

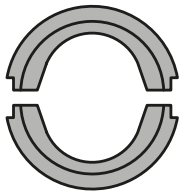
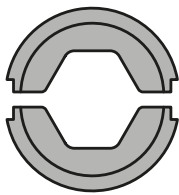

RHU1000 DIES CROSS REFERENCE CHART

DIE INDEX	DIETYPE		
	 CEMBRE	ALCOA	HUSKIE
10SH	M10SH-1000	10010SH	HA100-01
12SH	M12SH-1000	10012SH	HA100-02
14SH	M14SH-1000	10014SH	HA100-03
16SH	M16SH-1000	10016SH	HA100-04
18SH	M18SH-1000	10018SH	HA100-05
20SH	M20SH-1000	10020SH	HA100-06
76SH	M76SH-1000	10076SH	-
20AH	M20AH-1000	10020AH	HA100-20
24AH	M24AH-1000	10024AH	HA100-21
27AH	M27AH-1000	10027AH	HA100-22
30AH	M30AH-1000	10030AH	HA100-23
34AH	M34AH-1000	10034AH	HA100-24
36AH	M36AH-1000	10036AH	HA100-25
38AH	M38AH-1000	10038AH	HA100-26
40AH	M40AH-1000	10040AH	HA100-27
76AH	M76AH-1000	10076AH	HA100-30
42AH	M42AH-1000	10042AH	HA100-34
44AH	M44AH-1000	10044AH	HA100-36
48AH	M48AH-1000	10048AH	HA100-38
07CD	M7CD-1000	10007CD	HA100-40
08CD	M8CD-1000	10008CD	HA100-41
09CD	M9CD-1000	10009CD	HA100-42
10CD	M10CD-1000	10010CD	HA100-43
11CD	M11CD-1000	10011CD	HA100-44
12CD	M12CD-1000	10012CD	HA100-45
13CD	M13CD-1000	10013CD	HA100-46
14CD	M14CD-1000	10014CD	HA100-47
15CD	M15CD-1000	10015CD	HA100-48
16CD	M16CD-1000	10016CD	HA100-49
17CD	M17CD-1000	10017CD	HA100-50
18CD	M18CD-1000	10018CD	HA100-51
19CD	M19CD-1000	10019CD	HA100-52
20CD	M20CD-1000	10020CD	HA100-53

APPENDIX



Comparison of AWG, MCM and Metric conductor cross sections

CONDUCTORS SECTIONS

Conversion Table AWG, MCM / mm²

[AWG]	Actual conductor csa mm ²	Comparable metric csa mm ²	[MCM]	Actual conductor csa mm ²	Comparable metric csa mm ²
27	0,10		250	127	120
26	0,13	0,14	300	152	150
25	0,16	-	350	177	185
24	0,21	0,2	400	203	-
23	0,26	0,25	500	253	240
22	0,33	0,34	600	304	300
21	0,41	-	700	355	-
20	0,52	0,5	800	405	400
19	0,65	-	900	456	-
18	0,82	0,75	1000	507	500
17	1,04	1	1250	633	625
16	1,31	-	1500	760	800
15	1,65	1,5	1750	887	-
14	2,08	-	2000	1010	1000
13	2,63	2,5			
12	3,31	-			
11	4,15	4			
10	5,27	6			
9	6,62	-			
8	8,35	-			
7	10,6	10			
6	13,3	-			
5	16,8	16			
4	21,2	-			
3	26,7	25			
2	33,6	35			
1	42,4	-			
1/0	53,4	50			
2/0	67,5	70			
3/0	85,0	95			
4/0	107,2	120			

MAXIMUM DIAMETERS OF CIRCULAR COPPER CONDUCTORS: SOLID, NON COMPACTED STRANDED AND FLEXIBLE

Cross sectional area [mm ²]	Conductors in cables for fixed installations		Flexible conductors (Classes 5 and 6) Maximum diameter [mm]
	Solid (Class 1) Maximum diameter [mm]	Stranded (Class 2) Maximum diameter [mm]	
0,5	0,9	1,1	1,1
0,75	1	1,2	1,3
1	1,2	1,4	1,5
1,5	1,5	1,7	1,8
2,5	1,9	2,2	2,4
4	2,4	2,7	3
6	2,9	3,3	3,9
10	3,7	4,2	5,1
16	4,6	5,3	6,3
25 ^a	5,7	6,6	7,8
35 ^a	6,7	7,9	9,2
50 ^a	7,8	9,1	11
70 ^a	9,4	11	13,1
95 ^a	11	12,9	15,1
120 ^a	12,4	14,5	17
150 ^a	13,8	16,2	19
185	15,4	18	21
240	17,6	20,6	24
300	19,8	23,1	27
400	22,2	26,1	31
500	-	29,2	35
630	-	33,2	39
800	-	37,6	-
1000	-	42,2	-

NOTE: The values given for flexible conductors represent both class 5 and class 6 conductors.

^a Solid copper conductor having cross-sectional areas of 25 mm² and above are for particular types of cable, e.g. mineral insulated, and not for general purposes.

MINIMUM AND MAXIMUM DIAMETERS OF STRANDED COMPACTED CIRCULAR COPPER, ALUMINIUM AND ALUMINIUM ALLOY CONDUCTORS

Cross-sectional area [mm ²]	Stranded compacted circular conductors (Class 2)	
	Minimum diameter [mm]	Maximum diameter [mm]
10	3,6	4,0
16	4,6	5,2
25	5,6	6,5
35	6,6	7,5
50	7,7	8,6
70	9,3	10,2
95	11,0	12,0
120	12,3	13,5
150	13,7	15,0
185	15,3	16,8
240	17,6	19,2
300	19,7	21,6
400	22,3	24,6
500	25,3	27,6
630	28,7	32,5

NOTES: - The dimensional limits of Aluminium conductors with cross-sectional areas above 630 mm² are not given as the compaction technology is not generally established.

- The values are given for compacted copper conductors in the size range 1,5 mm² to 6 mm².

MINIMUM AND MAXIMUM DIAMETERS OF CIRCULAR ALUMINIUM CONDUCTORS

Cross-sectional area [mm ²]	Solid conductors (Class 1)	
	Minimum diameter [mm]	Maximum diameter [mm]
10	3,4	3,7
16	4,1	4,6
25	5,2	5,7
35	6,1	6,7
50	7,2	7,8
70	8,7	9,4
95	10,3	11,0
120	11,6	12,4
150	12,9	13,8
185	14,5	15,4
240	16,7	17,6
300	18,8	19,8
400	21,2	22,2
500	24,0	25,1
630	27,3	28,4
800	30,9	32,1
1000	34,8	36,0
1200	37,8	39,0

IEC 60228 : 2004 - 11 conductor tables

CLASS 1:

SOLID CONDUCTORS FOR SINGLE-CORE AND MULTI-CORE CABLES

Nominal cross-sectional area [mm ²]	Maximum resistance of conductor at 20 °C		
	Circular, annealed Copper conductors		Aluminium and Aluminium alloy conductors, circular or shaped c [ohm/km]
	Plain [ohm/km]	Metal [ohm/km]	
0,5	36	36,7	-
0,75	24,5	24,8	-
1	18,1	18,2	-
1,5	12,1	12,2	-
2,5	7,41	7,56	-
4	4,61	4,70	-
6	3,08	3,11	-
10	1,83	1,84	3,08 a
16	1,15	1,16	1,91 a
25	0,727 ^b	-	1,20 ^a
35	0,524 ^b	-	0,868 ^a
50	0,387 ^b	-	0,641
70	0,268 ^b	-	0,443
95	0,193 ^b	-	0,320 d
120	0,153 ^b	-	0,253 d
150	0,124 ^b	-	0,206 d
185	0,101 ^b	-	0,164 d
240	0,0775 ^b	-	0,125 d
300	0,0620 b	-	0,100 d
400	0,0465 b	-	0,0778
500	-	-	0,0605
630	-	-	0,0469
800	-	-	0,0367
1000	-	-	0,0291
1200	-	-	0,0247

^a Aluminium conductors 10 mm² to 35 mm² circular only

^b Solid Copper conductors having nominal cross-sectional area of 25 mm² and above are for particular types of cable, e.g. mineral insulated, and not for general purposes.

^c For solid Aluminium alloy conductors, having the same nominal cross-sectional area as an Aluminium conductor, the resistance value given in the table should be multiplied by a factor of 1,162 unless otherwise agreed between the manufacturer and the purchaser.

^d For single core cables, four sectoral shaped conductors may be assembled into a single circular conductor. The maximum resistance of the assembled conductor shall be 25% of that of the individual component conductors.

CLASS 2:

STRANDED CONDUCTORS FOR SINGLE-CORE AND MULTI-CORE CABLES

Nominal cross-sectional area [mm ²]	Minimum number of wires in the conductor						Maximum resistance of conductor at 20 °C		
	Circular		Circular compacted		Shaped		Annealed copper conductor		Aluminium or aluminium alloy conductor ^c [ohm/km]
	Cu	Al	Cu	Al	Cu	Al	Plain wires [ohm/km]	Metal-coated wires [ohm/km]	
0,5	7	-	-	-	-	-	36,0	36,7	-
0,75	7	-	-	-	-	-	24,5	24,8	-
1,0	7	-	-	-	-	-	18,1	18,2	-
1,5	7	-	6	-	-	-	12,1	12,2	-
2,5	7	-	6	-	-	-	7,41	7,56	-
4	7	-	6	-	-	-	4,61	4,70	-
6	7	-	6	-	-	-	3,08	3,11	-
10	7	7	6	6	-	-	1,83	1,84	3,08
16	7	7	6	6	-	-	1,15	1,16	1,91
25	7	7	6	6	6	6	0,727	0,734	1,20
35	7	7	6	6	6	6	0,524	0,529	0,868
50	19	19	6	6	6	6	0,387	0,391	0,641
70	19	19	12	12	12	12	0,268	0,270	0,443
95	19	19	15	15	15	15	0,193	0,195	0,320
120	37	37	18	15	18	15	0,153	0,154	0,253
150	37	37	18	15	18	15	0,124	0,126	0,206
185	37	37	30	30	30	30	0,0991	0,100	0,164
240	61	61	34	30	34	30	0,0754	0,0762	0,125
300	61	61	34	30	34	30	0,0601	0,0607	0,100
400	61	61	53	53	53	53	0,0470	0,0475	0,0778
500	61	61	53	53	53	53	0,0366	0,0369	0,0605
630	91	91	53	53	53	53	0,0283	0,0286	0,0469
800	91	91	53	53	-	-	0,0221	0,0224	0,0367
1000	91	91	53	53	-	-	0,0176	0,0177	0,0291
1200			b				0,0151	0,0151	0,0247
1400 a			b				0,0129	0,0129	0,0212
1600			b				0,0113	0,0113	0,0186
1800 a			b				0,0101	0,0101	0,0165
2000			b				0,0090	0,0090	0,0149
2500			b				0,0072	0,0072	0,0127

^a Non-preferred sizes. Other non-preferred sizes are recognized for some specialized applications but are not within the scope of this standard.

^b The minimum number of wires for these sizes is not specified. These sizes may be constructed from 4, 5 or 6 equal segments (Milliken).

^c For stranded Aluminium alloy conductors having the same nominal cross-sectional area as an Aluminium conductor the resistance value should be agreed between the manufacturer and the purchaser.

IEC 60228 : 2004 - 11 conductor tables

CLASS 5:

FLEXIBLE COPPER CONDUCTORS FOR SINGLE-CORE AND MULTI-CORE CABLES

Nominal cross-sectional [mm ²]	Maximum diameter of wires in conductor [mm]	Maximum resistance of conductor at 20 °C	
		Plain wires [ohm/km]	Metal-coated wires [ohm/km]
0,5	0,21	39	40,1
0,75	0,21	26	26,7
1	0,21	19,5	20
1,5	0,26	13,3	13,7
2,5	0,26	7,98	8,21
4	0,31	4,95	5,09
6	0,31	3,3	3,39
10	0,41	1,91	1,95
16	0,41	1,21	1,24
25	0,41	0,78	0,795
35	0,41	0,554	0,565
50	0,41	0,386	0,393
70	0,51	0,272	0,277
95	0,51	0,206	0,21
120	0,51	0,161	0,164
150	0,51	0,129	0,132
185	0,51	0,106	0,108
240	0,51	0,080	0,081
300	0,51	0,064	0,065
400	0,51	0,048	0,049
500	0,61	0,038	0,039
630	0,61	0,028	0,029

CLASS 6:

FLEXIBLE COPPER CONDUCTORS FOR SINGLE-CORE AND MULTI-CORE CABLES

Nominal cross-sectional [mm ²]	Maximum diameter of wires in conductor [mm]	Maximum resistance of conductor at 20 °C	
		Plain wires [ohm/km]	Metal-coated wires [ohm/km]
0,5	0,16	39	40,1
0,75	0,16	26	26,7
1	0,16	19,5	20
1,5	0,16	13,3	13,7
2,5	0,16	7,98	8,21
4	0,16	4,95	5,09
6	0,21	3,3	3,39
10	0,21	1,91	1,95
16	0,21	1,21	1,24
25	0,21	0,78	0,795
35	0,21	0,554	0,565
50	0,31	0,386	0,393
70	0,31	0,272	0,277
95	0,31	0,206	0,21
120	0,31	0,161	0,164
150	0,31	0,129	0,132
185	0,41	0,106	0,108
240	0,41	0,080	0,081
300	0,41	0,064	0,065

- H** Cable conforming to harmonised standards
- A** Recognised national type of cable
- N** Other type of national cable

- 00** Less than 100 / 100 V
- 01** Above 100 / 100 V and less than 300 / 300 V
- 03** 300 / 300 V
- 05** 300 / 500 V
- 07** 450 / 750 V
- 1** 0,6 / 1 kV

- B** Ethylenpropylene rubber for working temperature of 60° C
- N** Polychloroprene
- N2** Polychloroprene for welding cables
- Q** Polyurethane
- R** Rubber
- V** Common-quality PVC
- V2** PVC for working temperatures of 90° C
- V3** PVC for low temperature cables
- V4** Reticulate PVC
- V5** Oil-resistant PVC
- Z** Polyolefin mixture

- C** Concentric Copper core
- C4** Copper braid screen on multiple cores
- C5** Copper braid screen on single cores
- C7** Screen made of Copper straps or ribbons

- Z2** Round Steel strand armour
- Z3** Steel strap armour
- Z4** Steel ribbon armour
- Z5** Steel strand braid

- H** Flat divisible cable with or without sheath
- H2** Flat indivisible cable
- H3** Flat cable with cores separated by a slat
- H6** Flat cable with three or more cores
- H7** Cable with double-layered insulation
- H8** Extendable cord

- D** Flexible core for weldings cables
- E** Very flexible core for welding cables
- F** Flexible core for moving connections
- H** Very flexible core for moving connections
- K** Flexible core for fixed laying
- R** Rigid round cord
- U** Round rigid single strand

REFERENCE TO THE STANDARDS

RATED VOLTAGE

INSULATION AND SHEATH MATERIAL

SCREENS

ARMOURS

CONSTRUCTIVE FORM OF THE CABLE

CONDUCTOR FLEXIBILITY DEGREE

UL and VDE marking of cable glands

MAXIblock® *spiralblock*®

Type (°)	Thread	COMPRESSION RANGE Ø (min-max)				IMPACT CATEGORY (°)	MARKING
		Nominal [mm]	UL 514B		EN 62444 [mm]		
			[mm]	[inches]			
1900.M12	M12x1,5	3,5-7	4,5	0,18	3,5-7	1	USR-CNR / VDE
1900.M16	M16x1,5	5-10	7	0,28	7-10	1	USR-CNR / VDE
1900.M20	M20x1,5	7-13	13	0,51	8-13	3	USL-CNL / VDE
1900.M25	M25x1,5	10-17	17	0,67	10-17	3	USL-CNL / VDE
1900.M32	M32x1,5	13-21	15-21	0,60-0,83	15-21	3	USL-CNL / VDE
1900.M40	M40x1,5	19-28	21-28	0,83-1,10	19-28	3	USL-CNL / VDE
1900.M50	M50x1,5	27-35	27-34	1,06-1,34	27-35	3	USL-CNL / VDE
1900.M63	M63x1,5	34-45	35	1,38	34-45	3	USL-CNL / VDE
1910.M12	M12x1,5	2-5	3-5	0,12-0,20	2-5	1	USR-CNR / VDE
1910.M16	M16x1,5	3-7	5-7	0,20-0,28	5-7	1	USR-CNR / VDE
1910.M20	M20x1,5	5-10	5-10	0,20-0,40	6-10	3	USR-CNR / VDE
1910.M25	M25x1,5	7-13	6-13	0,24-0,51	7-13	3	USR-CNR / VDE
1910.M32	M32x1,5	8-14	7-14	0,28-0,55	8-14	3	USR-CNR / VDE
1910.M40	M40x1,5	15-23	17-23	0,67-0,91	15-23	3	USL-CNL / VDE
1910.M50	M50x1,5	20-29	20-29	0,79-1,14	21-29	3	USL-CNL / VDE
1910.M63	M63x1,5	27-39	29-35	1,14-1,38	28-39	3	USL-CNL / VDE
1901.M12	M12x1,5	3,5-7	4,5	0,18	3,5-7	1	USR-CNR / VDE
1901.M16	M16x1,5	5-10	7	0,28	7-10	1	USR-CNR / VDE
1901.M20	M20x1,5	7-13	13	0,51	8-13	3	USL-CNL / VDE
1901.M25	M25x1,5	10-17	17	0,67	10-17	3	USL-CNL / VDE
1901.M32	M32x1,5	13-21	15-21	0,60-0,83	15-21	3	USL-CNL / VDE
1901.M40	M40x1,5	19-28	21-28	0,83-1,10	19-28	3	USL-CNL / VDE
1901.M50	M50x1,5	27-35	27-34	1,06-1,34	27-35	3	USL-CNL / VDE
1901.M63	M63x1,5	34-45	35	1,38	34-45	3	USL-CNL / VDE
1940.M20	M20x1,5	10-14	10-14	0,40-0,55	10-14	2	USR-CNR / VDE
1940.M25	M25x1,5	13-18	13-18	0,51-0,71	13-18	2	USL-CNL / VDE
1940.M40	M40x1,5	26-34	26-34	1,02-1,34	26-34	3	USL-CNL / VDE
1940E.M40	M40x1,5	22-32	23-32	0,91-1,26	22-32	3	USL-CNL / VDE
1500.M12	M12x1,5	3,5-7	4,5	0,18	3,5-7	1	USR-CNR / VDE
1500.M16	M16x1,5	5-10	7	0,28	7-10	1	USR-CNR / VDE
1500.M20	M20x1,5	7-13	13	0,51	8-13	3	USL-CNL / VDE
1500.M25	M25x1,5	10-17	17	0,67	10-17	3	USL-CNL / VDE
1500.M32	M32x1,5	13-21	15-21	0,60-0,83	15-21	3	USL-CNL / VDE

MAXIbrass®

Type	Thread	COMPRESSION RANGE Ø (min-max)				IMPACT CATEGORY (°)	MARKING
		Nominal [mm]	UL 514B		EN 62444 [mm]		
			[mm]	[inches]			
2900.M12N	M12x1,5	3-7	3-7	0,12-0,28	3-7	5	USR-CNR / VDE
2900.M16N	M16x1,5	4,5-10	6-10	0,24-0,39	4,5-10	6	USR-CNR / VDE
2900.M20N	M20x1,5	7-13	8-13	0,31-0,51	7-13	6	USL-CNL / VDE
2900.M25N	M25x1,5	10-17	13-17	0,51-0,67	11-17	6	USL-CNL / VDE
2900.M32N	M32x1,5	11-21	13-21	0,51-0,83	13-21	6	USL-CNL / VDE
2900.M40N	M40x1,5	19-28	21-28	0,83-1,10	19-28	6	USL-CNL / VDE
2900.M50N	M50x1,5	26-35	27-35	1,06-1,38	26-35	6	USL-CNL / VDE
2900.M63N	M63x1,5	34-45	34-45	1,33-1,77	34-45	6	USL-CNL / VDE
2910.M12N	M12x1,5	1-5	2-5	0,08-0,20	2-5	5	USR-CNR / VDE
2910.M16N	M16x1,5	2,5-7	3,5-7	0,14-0,28	4-7	6	USR-CNR / VDE
2910.M20N	M20x1,5	5-10	5-10	0,20-0,39	5,5-10	6	USR-CNR / VDE
2910.M25N	M25x1,5	6-13	8-13	0,31-0,51	6-13	6	USR-CNR / VDE
2910.M32N	M32x1,5	7-14	7-14	0,28-0,55	9-14	6	USR-CNR / VDE
2910.M40N	M40x1,5	13-23	15-23	0,59-0,90	17-23	6	USL-CNL / VDE
2910.M50N	M50x1,5	20-29	20-29	0,79-1,14	25-29	6	USL-CNL / VDE
2910.M63N	M63x1,5	27-39	28-39	1,10-1,54	31-39	6	USL-CNL / VDE
2901.M12N	M12x1,5	3-7	3-7	0,12-0,28	3-7	5	USR-CNR / VDE
2901.M16N	M16x1,5	4,5-10	6-10	0,24-0,39	4,5-10	6	USR-CNR / VDE
2901.M20N	M20x1,5	7-13	8-13	0,31-0,51	7-13	6	USL-CNL / VDE
2901.M25N	M25x1,5	10-17	13-17	0,51-0,67	11-17	6	USL-CNL / VDE
2901.M32N	M32x1,5	11-21	13-21	0,51-0,83	13-21	6	USL-CNL / VDE
2901.M40N	M40x1,5	19-28	21-28	0,83-1,10	19-28	6	USL-CNL / VDE
2901.M50N	M50x1,5	26-35	27-35	1,06-1,38	26-35	6	USL-CNL / VDE
2911.M12N	M12x1,5	1-5	2-5	0,08-0,20	2-5	5	USR-CNR / VDE
2911.M16N	M16x1,5	2,5-7	3,5-7	0,14-0,28	4-7	6	USR-CNR / VDE
2911.M20N	M20x1,5	5-10	5-10	0,20-0,39	5,5-10	6	USR-CNR / VDE
2911.M25N	M25x1,5	6-13	8-13	0,31-0,51	6-13	6	USR-CNR / VDE
2911.M32N	M32x1,5	7-14	7-14	0,28-0,55	9-14	6	USR-CNR / VDE
2911.M40N	M40x1,5	13-23	15-23	0,59-0,90	17-23	6	USL-CNL / VDE
2911.M50N	M50x1,5	20-29	20-29	0,79-1,14	25-29	6	USL-CNL / VDE
2940.M12N	M12x1,5	5-8	5-8	0,20-0,31	5-8	5	USR-CNR / VDE
2940.M16N	M16x1,5	7-12	8-12	0,31-0,47	8-12	6	USR-CNR / VDE
2940.M20N	M20x1,5	10-16	12-16	0,47-0,63	12-16	6	USR-CNR / VDE
2940.M25N	M25x1,5	13-21	14-21	0,55-0,83	13-21	6	USL-CNL / VDE
2940.M32N	M32x1,5	18-25	21-25	0,83-0,98	18-25	6	USL-CNL / VDE
2940.M40N	M40x1,5	25-32	25-32	0,98-1,26	25-32	6	USL-CNL / VDE
2940.M50N	M50x1,5	30-38	30-37	1,18-1,46	30-38	6	USL-CNL / VDE
2940E.M50N	M50x1,5	35-45	35-41	1,38-1,61	35-45	6	USL-CNL / VDE

(°) Add to Ref: N for Black, G for Dark Grey

(*) EN 62444 § 9.5

VDE: Licence nos 40008472, 40008474, 40008475 and 40008476

USL-CNL: UL LISTING file no E220310; control no 48SB valid in USA & Canada

USR-CNR: UL RECOGNITION file no E220310 valid in USA & Canada (with reduced tightening force)

MAXIblock® *spiralblock*®

Type (°)	Thread	COMPRESSION RANGE Ø (min-max)				MARKING
		Nominal [mm]	UL 514B		MARKING	
			[mm]	[inches]		
1900.07	Pg 7	3,5-7	4,5-6,5	0,18-0,25	USR-CNR	
1900.09	Pg 9	5-8	6-8	0,24-0,31	USR-CNR	
1900.11	Pg 11	5-10	6,5-9,5	0,26-0,37	USR-CNR	
1900.13	Pg 13,5	7-12	8-11,5	0,31-0,45	USL-CNL	
1900.16	Pg 16	10-14	10,5-14	0,41-0,55	USL-CNL	
1900.21	Pg 21	13-18	13-18	0,51-0,71	USL-CNL	
1900.29	Pg 29	18-25	22-25	0,87-0,98	USL-CNL	
1900.36	Pg 36	20-32	21,5-32	0,85-1,26	USR-CNR	
1900.42	Pg 42	28-38	32-38	1,26-1,49	USR-CNR	
1900.48	Pg 48	34-45	35	1,38	USL-CNL	
1910.07	Pg 7	2-5	3-5	0,12-0,20	USR-CNR	
1910.11	Pg 11	4-7	4-7	0,16-0,28	USR-CNR	
1910.13	Pg 13,5	5-10	10	0,39	USR-CNR	
1910.21	Pg 21	9-15	10-14	0,39-0,55	USR-CNR	
1910.36	Pg 36	18-26	18-26	0,71-1,02	USR-CNR	
1910.42	Pg 42	25-31	25-31	0,98-1,22	USL-CNL	
1901.07	Pg 7	3,5-7	6,5	0,26	USR-CNR	
1901.09	Pg 9	5-8	6-8	0,24-0,31	USR-CNR	
1901.11	Pg 11	5-10	6,5-9,5	0,26-0,37	USR-CNR	
1901.13	Pg 13,5	7-12	8-11,5	0,31-0,45	USL-CNL	
1901.16	Pg 16	10-14	10,5-14	0,41-0,55	USL-CNL	
1901.21	Pg 21	13-18	13-18	0,51-0,71	USL-CNL	
1901.29	Pg 29	18-25	22-25	0,87-0,98	USL-CNL	
1901.36	Pg 36	20-32	21,5-32	0,85-1,26	USR-CNR	
1901.42	Pg 42	28-38	32-38	1,26-1,49	USL-CNL	
1901.48	Pg 48	34-45	35	1,38	USL-CNL	
1500.07	Pg 7	3,5-7	4,5-6,5	0,18-0,25	USR-CNR	
1500.09	Pg 9	5-8	6-8	0,24-0,31	USR-CNR	
1500.11	Pg 11	5-10	6,5-9,5	0,26-0,37	USR-CNR	
1500.13	Pg 13,5	7-12	8-11,5	0,31-0,45	USL-CNL	
1500.16	Pg 16	10-14	10,5-14	0,41-0,55	USL-CNL	
1500.21	Pg 21	13-18	13-18	0,51-0,71	USL-CNL	

1900.14	G1/4"	3-6,5	4,5-6,5	0,18-0,25	USR-CNR
1900.38	G3/8"	4-8	6-8	0,24-0,31	USR-CNR
1900.12	G1/2"	7-12	8-11,5	0,31-0,45	USL-CNL
1900.34	G3/4"	13-18	13-18	0,51-0,71	USL-CNL
1500.14	G1/4"	3-6,5	4,5-6,5	0,18-0,25	USR-CNR
1500.38	G3/8"	4-8	6-8	0,24-0,31	USR-CNR
1500.12	G1/2"	7-12	8-11,5	0,31-0,45	USL-CNL
1500.34	G3/4"	13-18	13-18	0,51-0,71	USL-CNL

MAXIbrass®



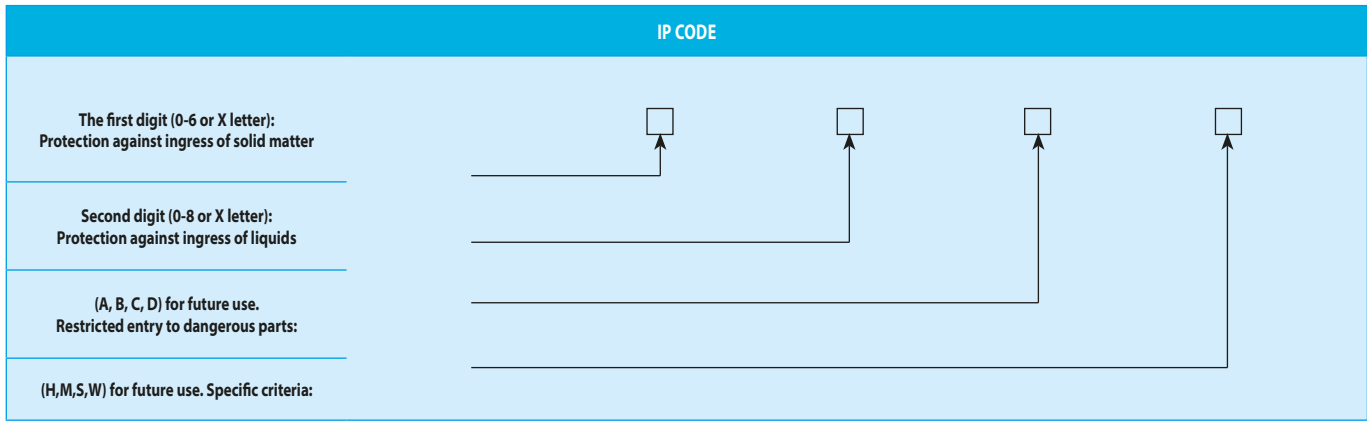

Type	Thread	COMPRESSION RANGE Ø (min-max)				MARKING
		Nominal [mm]	UL 514B		MARKING	
			[mm]	[inches]		
2900.07N	Pg 7	3-7	3-7	0,12-0,28	USR-CNR	
2900.09N	Pg 9	4-8	4-8	0,16-0,31	USR-CNR	
2900.11N	Pg 11	4,5-10	6-10	0,24-0,39	USR-CNR	
2900.13N	Pg 13,5	5-12	10-12	0,39-0,47	USL-CNL	
2900.16N	Pg 16	7-13	10-13	0,39-0,51	USL-CNL	
2900.21N	Pg 21	10-17	12-17	0,47-0,67	USL-CNL	
2900.29N	Pg 29	17-25	18-25	0,71-0,98	USL-CNL	
2900.36N	Pg 36	20-32	23-32	0,91-1,26	USL-CNL	
2900.42N	Pg 42	28-38	28-35	1,10-1,38	USL-CNL	
2900.48N	Pg 48	34-45	34-45	1,33-1,77	USL-CNL	
2910.07N	Pg 7	1-5	2-5	0,08-0,20	USR-CNR	
2910.09N	Pg 9	2-6	3-6	0,12-0,24	USR-CNR	
2910.11N	Pg 11	2,5-7	3,5-7	0,14-0,28	USR-CNR	
2910.13N	Pg 13,5	4-10	5,5-10	0,22-0,39	USR-CNR	
2910.16N	Pg 16	5-10	6-10	0,24-0,39	USR-CNR	
2910.21N	Pg 21	6-13	7-13	0,28-0,51	USR-CNR	
2910.29N	Pg 29	11-20	12-20	0,47-0,79	USR-CNR	
2910.36N	Pg 36	18-26	19-26	0,75-1,02	USL-CNL	
2910.42N	Pg 42	24-31	24-31	0,94-1,22	USL-CNL	
2910.48N	Pg 48	27-39	31-39	1,22-1,54	USL-CNL	
2901.07N	Pg 7	3-7	3-7	0,12-0,28	USR-CNR	
2901.09N	Pg 9	4-8	4-8	0,16-0,31	USR-CNR	
2901.11N	Pg 11	4,5-10	6-10	0,24-0,39	USR-CNR	
2901.13N	Pg 13,5	5-12	10-12	0,39-0,47	USL-CNL	
2901.16N	Pg 16	7-13	10-13	0,39-0,51	USL-CNL	
2901.21N	Pg 21	10-17	12-17	0,47-0,67	USL-CNL	
2901.29N	Pg 29	17-25	18-25	0,71-0,98	USL-CNL	
2901.36N	Pg 36	20-32	23-32	0,91-1,26	USL-CNL	
2901.42N	Pg 42	28-38	28-35	1,10-1,38	USL-CNL	
2911.07N	Pg 7	1-5	2-5	0,08-0,20	USR-CNR	
2911.09N	Pg 9	2-6	3-8	0,12-0,31	USR-CNR	

Ingress protection (IP) rating according to EN 60529 - CEI 70-1

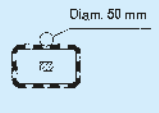
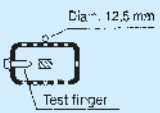

1st CHARACTERISTIC NUMBER:

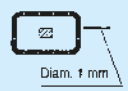



PROTECTION AGAINST INGRESS OF SOLID MATTER

PROTECTION	0	1	2	3	4	5	6
Protection against ingress of solid matter caused by		solid bodies measuring over 50 mm	solid bodies measuring over 12,5 mm	solid bodies measuring over 2,5 mm	solid bodies measuring over 1 mm	powder in harmful quantities	Powder (completely protected)
Test method		 Accessibility gauge ø 50 mm	 Accessibility gauge ø 12,5 mm	 Accessibility gauge ø 2,5 mm	 Accessibility gauge ø 1 mm	 talcum powder	 talcum powder

Ingress protection (IP) rating according to EN 60529 - CEI 70-1

2nd CHARACTERISTIC NUMBER:

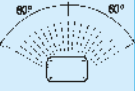
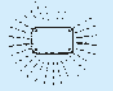
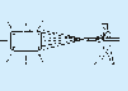
PROTECTION AGAINST INGRESS OF LIQUIDS

PROTECTION	0	1	2	3	4	5	6	7	8
Protection against ingress of liquids caused by		Drops of water falling vertically	Vertical drops of water with inclination of casing up to 15°	Rain	Sprays of water	Jets of water	Powerful jets of water	Temporary Immersion	Permanent Immersion
Test method									Agreement between manufacturer and user but more severe than 7

1st ADDITIONAL LETTER:

RESTRICTED ENTRY TO DANGEROUS PARTS

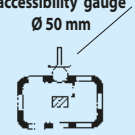
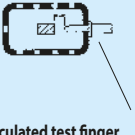
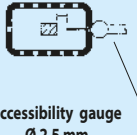
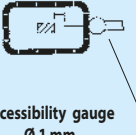
RESTRICTED ENTRY	A	B	C	D
Restricted entry to dangerous parts caused by	back of hand	finger	tool	wire
Test method				

2nd ADDITIONAL LETTER :

MEANING OF THE SECOND ADDITIONAL LETTER

SPECIFIC CRITERIA	H	M	S	W
Specific criteria	High voltage equipment	Tested against negative effects of water penetration, when the moveable parts of the equipment (e.g. wheels of a revolving machine) are moving	Tested against the negative effects of water penetration, when the moveable parts of the equipment (e.g. wheels of a revolving machine) are stationary	Suitable for use in environmental conditions as specified and equipped with additional measures of protection

Overview of NEMA ratings

National Electrical Manufacturers Association, or NEMA, is an organization that deals with technical standards for the manufacturing of electrical equipment and medical imaging equipment.

Most commonly, they are known for their rating system, known as NEMA Rating which classifies the level of protection an enclosure has against environmental elements. They are closely related to IP Ratings, but they allow for additional environmental elements such as corrosion.

NEMA is an American standard whereas IP is a European standard. NEMA ratings are used exclusively for enclosures, but IP ratings can be used for all kind of devices.

There is no direct correlation between NEMA ratings and IP ratings!

Understanding NEMA Ratings: Definition, NEMA Chart, and FAQs - Engineer Fix

NEMA ratings start at level 1 all the way up to NEMA level 13. Each NEMA rating means a different level of protection.

NEMA RATING	DESCRIPTION	ENVIRONMENTAL REQUIREMENTS	MECHANICAL REQUIREMENTS
NEMA 1	Indoor use	Dust-tight	Basic protection
NEMA 2	Indoor use	Drip-tight	Basic protection
NEMA 3	Outdoor use	Rain-tight	Basic protection
NEMA 3R	Outdoor use	Rain-tight	Protection from falling ice and sleet
NEMA 4	Outdoor use	Water-tight	Protection from falling ice and sleet
NEMA 4X	Outdoor use	Water-tight	Protection from corrosion
NEMA 6	Submersible	Water-tight	Protection from corrosion
NEMA 7	Explosion-proof	Protection from ignitable dust, and fibers	Protection from mechanical damage and corrosion
NEMA 8	Explosion-proof	Protection from ignitable gases and vapors	Protection from mechanical damage and corrosion
NEMA 9	Explosion-proof	Protection from ignitable gases, vapors, and dusts	Protection from mechanical damage and corrosion
NEMA 10	Explosion-proof	Protection from ignitable dusts	Protection from mechanical damage and corrosion
NEMA 11	Explosion-proof	Protection from ignitable fibers	Protection from mechanical damage and corrosion
NEMA 12	Indoor use	Dust-tight	Protection from dripping water and non-corrosive liquids
NEMA 13	Indoor use	Dust-tight	Protection from dripping water and oil

NEMA ratings to find in Cembre products

6P Rating

NEMA 6P enclosures are applicable indoors and outdoors. They prevent accidental human contact with electrical components.

They also protect against:

- Falling earth
- Direct water from the hose
- Damage caused by ice forming on the enclosure surface
- Water ingress from temporary immersion

4X Rating

NEMA 4X IP rated enclosures are ideal for protection against limiting accidental human contact and:

- Dust carried by the wind
- Sleet
- To snow
- Water sprayed from the hose
- Falling earth
- Corrosion

Enclosed equipment will remain safe even if snow settles on the storage facility.

12 Rating

NEMA 12 enclosures are made with holes and are recommended for indoor installation.

They provide electrical components with some protection against:

- Dangerous materials
- Falling earth
- High speed dust, lint, fibers
- Liquids that drip or splash slightly

Overview of NEMA ratings

TEST DESCRIPTION	POLYMERIC MATERIAL - MAXIBLOCK			METALLIC MATERIAL - MAXIBRASS
	6P RATING	4X RATING	12 RATING	6P RATING
FLAMMABILITY	Yes For hole diameter >28,7mm (from Pg29 or M32)	Yes For hole diameter >28,7mm (from Pg29 or M32)	Yes	NO (metals exempted)
RESISTANCE TO IMPACT	Yes For hole diameter >28,7mm (from Pg29 or M32)	Yes For hole diameter >28,7mm (from Pg29 or M32)	Yes	NO (metals exempted)
CORROSION	NO (polymers exempted)	NO (polymers exempted)	NO (polymers exempted)	Yes
GASKET OIL IMMERSION	-	-	Yes	-
GASKET MATERIAL AGING	Yes	Yes	Yes	Yes
INGRESS OF WATER (HOSEDOWN)	Yes	Yes	-	Yes
PROLONGED WATER SUBMERSION	Yes	-	-	Yes
ATOMIZED WATER	-	-	Yes	-

Flammability

All of the following results shall be obtained:

- The material shall not continue to burn for more than 1 minute after the fifth 5-second application of the test flame, with an interval of 5 seconds between application of the flame.
- Flaming drops or flaming or glowing particles that ignite surgical cotton 305 mm (12 inch) below the test specimen shall not be emitted by the test sample at any time during the test, and
- No visible flame shall be observed on the surface of the enclosure opposite to the surface that the test flame is applied during the test. In addition, unless otherwise specified in the relevant end-product standard, no opening greater than 3 mm shall appear after the test and the sample has cooled for 30 seconds.

Resistance to impact

The equipment shall withstand the impact without occurrence of any of the following:

- Making uninsulated live part accessible to contact (use the accessibility probe of the product standard for this evaluation);
- Producing a condition that might affect the mechanical performance of the equipment; or
- Producing a condition that would increase the likelihood of an electric shock.

Corrosion

600-Hour Salt Spray Test

1200-Hour Moist Carbon Dioxide-Sulfur Dioxide-Air Test

Gasket oil immersion

Gasket material, if used in a Type 12, 12K, or 13 enclosure, shall not swell more than 25 percent or shrink more than one percent as a result of immersion in ASTM Reference Oil No. 3 (see ASTM D471 Standard Test Method for Rubber Property-Effect of Liquids for oil specifications) or IRM Immersion 903 (see ASTM D5964) for 70 hours at room temperature.

Gasket material aging

Gasket material used in a Type 2, 3, 3X, 3RX, 3S, 3SX, 4, 4X, 5, 6, 6P, 12, 12K, or 13 enclosure shall be subjected to a temperature of 69 to 70°C (156 to 158°F) in circulating air for 168 hours.

Ingress of water (Hosedown)

The enclosure and its external mechanisms shall be subjected to a stream of water from a hose that has a 25 mm (1 in) inside diameter nozzle that delivers at least 240 L (65 gal) per minute.

Prolonged water submersion

Submerge the complete enclosure, connected as intended for use, in water so that the highest point of the enclosure is 1.8 m (6 ft.) below the surface for a period of 24 hours. The enclosure need not be submerged to a depth of 1.8 m (6 ft.) if the equivalent pressure differential between the interior and exterior be achieved by pressuring the water around the enclosure to simulate a depth of 1.8 m (6 ft.).

Atomized water

The enclosure shall be subjected to a spray of atomized water using a nozzle that produces a round pattern 75 to 100 mm (3 to 4 in.) in diameter when measured 300 mm (12 in.) from the nozzle. The air pressure shall be 200 kPa (30 psi). Not less than 4.8 mL/linear cm (5 oz./linear ft.) shall be applied at rate of 11.4 L/hour (3 gal/hour).

The nozzle shall be held from 300 to 380 mm (12 to 15 in.) from the enclosure, and the spray of water shall be directed one time at all point of potential dust entry, such as seams.

Flammability test for products and materials

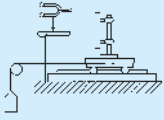
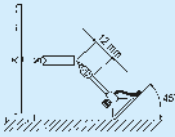
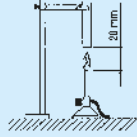
TYPE OF TEST	TEST EQUIPMENT	COMPLIANCE WITH STANDARDS	OBJECTIVE OF TEST	TEST RESULTS	TEST CONDITIONS		
					heat source	length of test	characteristic features
CHARACTERISTIC FEATURES		IEC 695-2-1 CEI 50-11 DIN VDE 0471-2-1	Check that abnormal heating produced by overcurrent and bad contacts does not compromise the safety of the insulating material. Lighting test. The wire is pressed against the sample using force and penetrates up to 7 mm.	Any sign of flame starting must stop within 30 sec. of removing the glowing wire. TEST TEMPERATURE <ul style="list-style-type: none"> • 650° for materials which do not support parts under tension • 750° for materials which support parts under tension of moving sockets and plugs • 850° for materials which support parts under tension of fixed sockets and switches 	Glow-wire 4 mm in diameter	Wire applied for 30 seconds	Flame extinction time
NEEDLE FLAME		IEC 695-2-1 CEI 50-11	Simulates the effect small flames have which may occur due to internal faults of products in order to judge the fire risk.	<ul style="list-style-type: none"> • the sample does not catch fire • the flame and incandescent particles do not spread the fire • combustion lasts less than 30 seconds 	Bunsen burner flame	Flame applied for (Ta) 5, 10, 20, 30, 60, 120 sec. According to particular standards	The degree of severity: flame application time (Ta)
UL (UNDERWRITER LABORATORIES)		UL 94	Measuring of time the sample continues to burn after the direct flame has been removed.	<ul style="list-style-type: none"> • V0 if the test specimen burns for less than 10 sec. before self-extinguishing • V1 if it burns for less than 30 sec. • V2 if it burns for less than 30 sec. with incandescent dripping. • HB if it burns for more than 30 seconds (sample thickness less than 3 mm: max. combustion speed 75 mm/min - sample thickness between 3 and 13 mm: max. combustion speed 40 mm/min) <p>Note</p> <ul style="list-style-type: none"> • HB rating: equivalent to ASTM D 635 or IEC 60695-11-10 • Grades V-0, V-1, V-2: equivalent to ASTM D 3801 or IEC 60695-11-10 	Bunsen burner flame	Flame applied for 10 seconds twice following	Length of combustion

Recommended torque settings for cable glands

MAXIblock[®], spiralblock[®], MAXIbrass[®], MAXIinox[®] METRIC THREADS, TO OBTAIN IP68 INGRESS PROTECTION IN ACCORDANCE WITH EN 60529/A2

	THREAD CABLE GLAND	CABLE GLAND	
		metallic	non-metallic
		torque (Nm)	
Torque values apply to mounting in a threaded entry and to use with a locknut	M12 x 1,5	6.0	2.7
	M16 x 1,5	6.0	5.0
	M20 x 1,5	8.0	7.0
	M25 x 1,5	8.0	7.5
	M32 x 1,5	18.0	8.0
	M40 x 1,5	18.0	8.0
	M50 x 1,5	18.0	15.0
	M63 x 1,5	25.0	15.0

MAXIblock[®], spiralblock[®], MAXIbrass[®], MAXIinox[®] PG THREADS, TO OBTAIN IP68 INGRESS PROTECTION IN ACCORDANCE WITH EN 60529/A2

	THREAD CABLE GLAND	CABLE GLAND	
		metallic	non-metallic
		torque (Nm)	
Torque values apply to mounting in a threaded entry and to use with a locknut	Pg7	6.25	2.5
	Pg9	6.25	3.75
	Pg11	6.25	3.75
	Pg13,5	7.5	5.0
	Pg16	7.5	5.0
	Pg21	10.0	7.5
	Pg29	15.0	8.0
	Pg36	25.0	10.0
	Pg42	25.0	10.0
	Pg48	25.0	15.0

MAXIblock[®], spiralblock[®] GAS THREADS, TO OBTAIN IP68 INGRESS PROTECTION IN ACCORDANCE WITH EN 60529/A2

	THREAD CABLE GLAND	NON-METALLIC CABLE GLAND
		torque (Nm)
		Torque values apply to mounting in a threaded entry and to use with a locknut
G3/8"	5	
G1/2"	6	
G3/4"	10	

Cable glands installation:

- 1) Before proceeding with the installation, inspect the cable gland; installation must be performed by qualified personnel and with suitable tools.
- 2) Cable glands must be used in their original supplied condition with no modifications.
- 3) Torque values listed in the catalogue are intended as the recommended level for reaching the correct IP protection level and achieving the required cable retention properties. As the torque depends on the type of insulation of the conductor used, it is responsibility of the user to define the ideal torque for their specific application.
- 4) Both the body and head of the cable gland must be correctly tightened; excessive or reduced tightening may compromise the protection level and the cable retention performance.
- 5) Loosening a cable gland already installed and then tightening again may result in a reduction of the IP protection level achieved and compromise the cable retention properties. In these instances, we recommend replacement of the cable gland.

Operating temperatures:

Dynamic range:

in this temperature range the cable gland withstands shocks and stresses with an energy value equivalent to the declared impact category according to EN 62444.

Static range:

in this temperature range the cable gland, properly installed in compliance with technical requirements, must not be further strained with stress or forces (shock, vibration, pressure, etc.). The same conditions also apply to both the enclosure and the wire to which the cable gland has been assembled.

Recommended torque settings for entry plugs

PLASTIC ENTRY PLUGS METRIC AND PG THREADS, TO OBTAIN IP54 / IP68 INGRESS PROTECTION

PLASTIC ENTRY PLUGS		TORQUE (Nm)		DEGREE OF PROTECTION
METRIC	Pg	Applied to PLUG	Applied to LOCKNUT	
M12 - M16	Pg7 - Pg9	1	1.5	• IP 54 • IP 68 (if applied with FD sealing rings)
M20 - M25	Pg11 - Pg13,5 - Pg16 - Pg21	1.5	3	
M32 - M40	Pg29	3	6	
M50 - M63	Pg36 - Pg42 - Pg48	6	10	

BRASS ENTRY PLUGS METRIC AND PG THREADS, TO OBTAIN IP54 / IP68 INGRESS PROTECTION

BRASS ENTRY PLUGS		TORQUE (Nm)		DEGREE OF PROTECTION
METRIC	Pg	Applied to PLUG	Applied to LOCKNUT	
M12 - M16 - M20 - M25	Pg7 - Pg9 - Pg11 Pg13,5 - Pg16 - Pg21	2	4	• IP 54 • IP 68 (if applied with FD sealing rings)
M32 - M40 - M50 - M63	Pg29 - Pg36 - Pg42 - Pg48	3	6	

Recommended torque settings for entry thread enlargers and reducers

RECOMMENDED TORQUE SETTINGS FOR PLASTIC ENTRY THREAD ENLARGERS AND REDUCERS METRIC, TO OBTAIN IP54 / IP68 INGRESS PROTECTION

	METRIC THREAD	TYPE	TORQUE (Nm)	DEGREE OF PROTECTION
	MALE - FEMALE			
ENTRY THREAD REDUCERS	M16 - M12	1153M1612	2,0	• IP 54 • IP 68 (if applied with FD sealing rings)
	M20 - M12	1153M2012		
	M20 - M16	1153M2016		
	M25 - M12	1153M2512		
	M25 - M16	1153M2516		
	M25 - M20	1153M2520		
	M32 - M16	1153M3216	4,0	
	M32 - M20	1153M3220		
	M32 - M25	1153M3225		
	M40 - M20	1153M4020		
	M40 - M25	1153M4025	7,5	
	M40 - M32	1153M4032		
	M50 - M25	1153M5025		
	M50 - M32	1153M5032		
	M50 - M40	1153M5040		
	M63 - M32	1153M6332		
M63 - M40	1153M6340	2,0		
M63 - M50	1153M6350			
M12 - M16	1173M1216			
M16 - M20	1173M1620			
ENTRY THREAD ENLARGERS	M20 - M25	1173M2025	4,0	
	M25 - M32	1173M2532		
	M32 - M40	1173M3240		



Identification & Labelling

systems

the system includes:

- Thermal transfer printer for sheet media
- Thermal transfer printer for roll media
- Embosser
- Manual system
- Accessories
- Labels

M4



ROLLY



GENERAL TERMS AND CONDITIONS OF SALE

1. GENERAL TERMS

- 1.1 For the purpose of these GENERAL TERMS AND CONDITIONS OF SALE (the "Terms and Conditions"), the following definitions shall apply:
 - «Seller»: CEMBRE S.p.A. and its affiliates;
 - «Affiliate»: any entity directly or indirectly, through one or more intermediaries, controlling, controlled by, or under common control with CEMBRE S.p.A.;
 - «Buyer»: any professional or entrepreneur purchasing the Products from the Seller;
 - «Products»: the goods manufactured and/or sold by the Seller;
 - «Order(s)»: each proposal for the purchase of the Products submitted by the Buyer to the Seller in writing;
 - «Sale(s)»: each single sale agreement entered into further to the receipt by the Buyer of the written order confirmation of the Seller.
- 1.2 These Terms and Conditions govern the sale of equipment, components, parts, and materials (the "Products") supplied by the Seller to the Buyer. Any specific supply agreement, order confirmation, quotation, these Terms and Conditions and the purchase order form the Sales Agreement ("Agreement") between the parties. In the event of a conflict between these documents, precedence shall apply in accordance with the order listed in the previous sentence.
- 1.3 CEMBRE's quotation, proposal or order confirmation is conditional on the Buyer's acceptance of these Terms and Conditions. Buyer's silence or acceptance/use of the Products or services related to any purchase order shall constitute tacit approval of these Terms and Conditions.
- 1.4 Any additional or conflicting terms included in the Buyer's request for quotation/proposal, specifications, purchase order or any other written or oral communication are not binding on CEMBRE unless separately signed by CEMBRE. CEMBRE's failure to object to Buyer's additional or conflicting terms (including the Buyer's Terms and Conditions of Purchase) does not operate as a waiver of any terms contained herein.

2. ORDERING PROCEDURES

- 2.1 Offers of the Seller are not binding. This shall also apply if the Seller has provided the Buyer with catalogues, technical documentation (e.g. drawings, plans, calculations, references to DIN standards), other product descriptions or documents - also in electronic form - to which the Seller reserves property rights and copyrights pursuant to Clause 8.
- 2.2 Unless otherwise agreed, the information in offers and order confirmations shall refer to the contents of the respectively valid price lists, catalogues or other documents - also in electronic form, including technical data sheets, of the Seller.
- 2.3 All orders must be sent in writing and include all the details for a correct identification of the Products and Services requested. The minimum order amount is € 250.
- 2.4 The order is an irrevocable proposal to buy, but it is accepted by the Seller only following order acknowledgement / confirmation or execution.
- 2.5 The Buyer may request in writing to cancel or modify the order only prior to its execution and the Seller may at its own discretion accept or reject such request. Only cancellations and modifications expressly accepted by the Seller in writing shall be valid and effective.

3. PRICING AND PAYMENT TERMS

- 3.1 Unless otherwise specified in writing, Seller's quotations have a 30-day validity, after which they will automatically expire.
- 3.2 Prices quoted in price-lists and marketing materials are not binding and cannot be considered a "public offer". Unless otherwise agreed in writing, prices are always quoted based on delivery term FCA (Incoterms latest version) net of any applicable statutory value added /goods and services tax and of any applicable taxes and duties.
- 3.3 The Seller reserves the right to update the price-list without prior notice; the new release of the price-list will apply to all the Orders placed after the date such new release is issued and sent to the Buyer. Invoices will be issued in accordance with the prices in force on the date of the order confirmation or as otherwise agreed in specific supply agreements.
- 3.4 In the event of late payment, the Seller will have the right to charge overdue interest in accordance with the provisions of law no. 231/2002. Any further claim for damages caused by delay shall remain unaffected.
- 3.5 In the event of payment arrears, suspension of payments and if circumstances become known which are likely to reduce the creditworthiness of the customer, the Seller shall be entitled, after having granted a period of grace, to declare all claims arising from the entire business relationship with the customer immediately due for payment. Discount agreements, rebates and the like shall be deemed forfeited in this case.
- 3.6 Failure to pay or delayed payments above 30 days also entitle the Seller to suspend the delivery of the Products and terminate every single Sale entered into. The suspension of the delivery of the Products or the termination of any Sale shall not entitle the Buyer to claim for any compensation.
- 3.7 Any complaints regarding the Products and/or their delivery shall not be grounds for suspending or delaying the payment.
- 3.8 In the event of default or risk of insolvency concerning the Buyer, the Seller will be entitled to:
 - demand payment in advance or suitable guarantees; and/or
 - suspend deliveries; and/or
 - demand immediate payment of all the invoices already issued, regardless of the payment term therein indicated; and/or
 - terminate any existing sale agreement.

4. DELIVERY

- 4.1 Except as otherwise agreed upon in writing between the parties, the Seller shall deliver the Products FCA its premises (INCOTERMS latest version). If required, the Seller shall take care of the shipment of the Products at the Buyer's costs and expenses. In this last case delivery shall be considered to have taken place when the Products are transferred to the forwarder.
- 4.2 In case of missing or damaged goods during transport, the Buyer must formulate all the necessary reservations on the delivery note of said goods at the time of delivery. Such reservations must also be confirmed in writing to the Seller within 48 hours of the date of the delivery, by registered mail with return receipt.
- 4.3 The Seller cannot be held liable for delays in deliveries in the following circumstances:
 - acts of God or other extraordinary events beyond reasonable control, resulting in interruption of the manufacturing process, including shortage of energy and/or raw materials, pandemics strikes, embargoes or trade restrictions;
 - delays due to the Buyer, particularly when the Buyer failed to provide the information required to execute the order;
 - overdue payments, pursuant to arts. 1460 and 1461 of the Civil Code.
- 4.4 Penalties for late delivery may be charged by the Buyer only when expressly agreed in a specific supply agreement, and in any case up to a maximum amount equal to the price of the delayed delivery.
- 4.5 The Buyer shall not reject partial deliveries or late deliveries. All costs resulting from the rejection of goods will be charged to the Buyer. Excess deliveries for the purpose of rounding up to the packing quantity shall be deemed to be contractual performance and shall be paid by Buyer.
- 4.6 Goods returned at the request of the Buyer can only be accepted if the Seller has agreed in writing. The returned parts must be in their original packaging, come from the current product range and be in saleable condition. The return shipment must be carriage paid and at the risk of the Buyer. From the purchase price to be refunded, a depreciation fee will be deducted based on the actual conditions of the goods, their age and original price. Depreciation shall not apply to goods returned under section 5 and 6 hereinafter, provided that the return was authorized by the Seller. Custom-made products or articles which are not included in the current catalogue will not be taken back. Returned goods that are not accepted by the Seller will be shipped back to Buyer (freight paid by the Buyer) or scrapped upon the Buyer's authorization.
- 4.7 In the event of modifications to the order required by the Buyer, the delivery deadline will automatically be extended for the time necessary to implement the required modification.

5. CONFORMITY

- 5.1 Complaints about apparent defects or non-conformity of the product delivered in relation to the purchase order or the packing slip must be notified to the Seller in writing within 48 hours after receipt of the products, subject to forfeiture. The Buyer loses the right to claim if the goods are not inspected immediately after delivery.
- 5.2 In the absence of a specific agreement on quality, the features contained in a specification, a product-specific technical data sheet or an equivalent description by the Seller shall be deemed to be the relevant quality. Insignificant deviations shall not constitute a defect.
- 5.3 All actions regarding non-conformities detected by the Buyer must be agreed upon in advance with the Seller's quality department; in particular, the Buyer must not charge any costs not agreed upon in advance between the Parties.

GENERAL TERMS AND CONDITIONS OF SALE

6. WARRANTY AND LIABILITY

- 6.1 Unless otherwise agreed upon in writing, the Seller warrants that the Products are free from defects in material, design and manufacturing and fit for use. No guarantee is given herein by the Seller on the conformity of any Product with the law and regulations in countries outside EU and the UK. No other warranties, express or implied, are made with respect to the Products including, but not limited to, any implied warranty of merchantability or fitness for a particular purpose.
- 6.2 Unless otherwise agreed upon in writing, the warranty shall be valid for a period of one year from the date of delivery to the Buyer. Warranty is provided only on tools or machines with a serial number or other identification number that allows traceability. The warranty is, however, excluded if the Products have already been processed by the Buyer or incorporated in products, machinery or plants of the Buyer or of third parties.
- 6.3 Claims for defective Products shall be made in writing within eight working days from discovery.
- 6.4 The defective Products shall be returned to the Seller at the Buyer's cost upon Seller's request. The Seller's sole obligation (and Buyer's sole remedy) for any breach of warranty under the foregoing warranty shall be to repair (at location designated by Seller) or replace DAP the original point of delivery the defective goods, within a reasonable time. In the event that the Seller, for any reason, is unable to return a repaired or replaced product under warranty to the Buyer, it will proceed at its own discretion to refund the price paid, or replace the product with another having equal or superior characteristics. The Buyer will waive any claim for damage compensation once the warranty has been fulfilled and the Product has been repaired or replaced. The warranty shall not cover defects due to environmental or stress testing, misuse, failure to observe the Seller's instructions regarding the functioning, maintenance and the storage of the Products, repairs or modifications made by the Buyer or a third party without prior written authorization of the Seller, improper installation, transportation or handling.
- 6.5 Direct interventions on site are not included in the warranty; if expressly requested by the Buyer they are subject to charge, according to the Seller's tariffs.
- 6.6 Warranty repair/replacements may be suspended in the event of insolvency of the Buyer or overdue invoices.
- 6.7 Save for the case of fraud or gross negligence, the Seller shall bear no liability for damages to property or third parties other than that expressly provided by virtue of any mandatory law provisions. In any case, the Seller shall not be liable for indirect or consequential damages of whatsoever nature as, by way of example, production losses or unearned profits. In any case, Buyer's right to damages shall be limited to a maximum amount equal to the value of the Products showing defects or faults.
- 6.8 The Seller shall bear no liability for damages to property or third parties other than that expressly provided by virtue of any mandatory law provisions. The Seller will not, under any circumstances, be liable for the cost of removal or reinstallation of goods or the cost of disassembly or reassembly or for loss of business or goodwill or profits or for cost of inspection or storage or for any incidental and consequential damages of any nature which may arise from the sale of goods to the Buyer. When liability cannot be excluded by virtue of mandatory law provisions, Buyer's right to damages shall in any case be limited to a maximum amount equal to the value of the Products showing defects or faults.
- 6.9 The Seller has taken out suitable insurance policies covering general liability in connection with the Products.
- 6.10 Cembre products are intended for professional users (B2B); the applicability of consumer protection regulations, including those related to warranty, is expressly excluded. The sale of Cembre products through channels accessible to consumers is expressly prohibited, and vendors who contravene this prohibition will assume all civil and criminal liability towards third parties and the competent authorities.

7. EXPORT CONTROL REGULATIONS

- 7.1 The Seller shall not be obligated to fulfil this agreement if such fulfilment is prevented by any impediments arising out of national or international foreign trade or customs requirements or any embargoes or other sanctions or restrictions.
- 7.2 The Buyer is aware that the Products are intended to be sold and used exclusively for civil purposes, to the exclusion of any military or nuclear applications, or applications related to the development and production of chemical weapons and weapons of mass destruction.
- 7.3 The Buyer is aware that under the EU regulations, re-exportation to Russia and re-exportation for use in Russia of goods or technologies listed in Annexes XI, XX, XXXV and XL of EU Reg. 2014/833, dual-use products and firearms and ammunition listed in Annex I of EU Regulation n. 258/2012 are prohibited. Re-export to Belarus and re-export for use in Belarus of the goods or technologies listed in Annexes XVI, XVII, XXVIII, XXX, as well as firearms and ammunition listed in Annex I of Regulation (EU) No. 258/2012 are also prohibited. The Buyer consequently undertakes to comply with the trade restrictions issued by the EU authorities, as subsequently amended and supplemented.
- 7.4 If the Buyer transfers the Products to a third party, the Buyer shall comply with all applicable national and international (re-) export control regulations.
- 7.5 The Buyer shall cooperate with the Seller to provide the information concerning end users, destination and intended use of goods supplied by CEMBRE, in case this is necessary due to customs control activities or export control regulations.
- 7.6 Violations of this section 7 shall entitle the Seller to terminate any existing sale agreement at any time without notice.

8. INTELLECTUAL PROPERTY, CONFIDENTIALITY AND PRIVACY

- 8.1 The use of CEMBRE trademarks is governed by the General Terms and Conditions, published on the website <https://www.cembre.com/en/terms-and-condition>, which the Buyer is obliged to comply with. It is prohibited to relabel and repackage the Products without CEMBRE's written authorization.
- 8.2 Each party will retain ownership of its Intellectual Property developed before or outside the scope of the sale agreement. If any Intellectual Property is developed under the sale agreement, the parties shall execute a separate agreement regarding the ownership thereof.
- 8.3 Seller expressly reserves the copyright to its catalogues, technical documentation (e.g. drawings, plans, calculations, data sheets), other product descriptions or documents - also in electronic form. The Buyer is only granted a non-exclusive right of use.
- 8.4 All drawings and technical documents relating to the Products submitted by one party to the other shall remain exclusive property of the submitting party and can only be used for the purpose for which they were provided. The receiving party is not allowed to use such documents otherwise, to procure copies thereof, to reproduce and to disclose them to a third party without consent of the submitting party. The end user of the Products shall not be deemed as a third party for the purpose of this section.
- 8.5 Any liability of the Seller is excluded if the Buyer is responsible for the infringement of property rights, in particular because he has modified the object of performance, used it in breach of contract or taken it to a place other than the place of destination without the Seller's consent.
- 8.6 If the Seller manufactures goods according to drawings, samples or other information provided by the Buyer (OEM products) and if the property rights of third parties are infringed in the process, the Buyer shall indemnify the Seller from all claims for damages resulting from this.
- 8.7 The Seller warrants that the personal data received from the Buyer will be processed in full compliance with the applicable data protection regulations.
- 8.8 Violations of this section 8 shall entitle the Seller to terminate any existing sale agreement at any time without notice.

9. APPLICABLE LAW AND JURISDICTION

- 9.1 The place of performance for the delivery together with any subsequent performance on the part of the Seller is the Seller's registered office.
- 9.2 Place of jurisdiction is the registered office of the Seller. The Seller is also entitled to take legal action at the Buyer's registered office.
- 9.3 The legal relations between the Seller and the Buyer shall be governed by Italian law to the exclusion of the U.N. Convention on the International Sale of Goods (CISG).
- 9.4 The Buyer acknowledges that the CEMBRE Group has adopted a Code of Ethics and an Anti-Corruption Policy and undertakes to comply with the provisions of such documents, available at www.cembre.com, abstaining from any unlawful conducts. Failure to comply with any of the provisions of the Code of Ethics and/or of the Anti-Corruption Policy will result in a serious breach of contractual obligations and will entitle CEMBRE to terminate the contract with immediate effect, without prejudice to compensation for damages.

10. FORCE MAJEURE AND HARDSHIP

- 10.1 No failure, omission or delay of the Seller in the performance of any obligation shall be deemed a breach of the agreement nor create any liability hereunder, if the failure, omission or delay shall arise from acts of God, laws, rules, regulations or orders of any governmental authority, floods, fires, explosions, storms, earthquakes, acts of war (declared or undeclared), rebellion, insurrections, riot, sabotage, shortages of fuel, power, energy resources, and/or raw material, invasion, epidemic, quarantine, accident, strikes, lockouts, labor disputes, or any other comparable cause beyond the reasonable control of the Seller.
- 10.2 If, during the term of the contract, events occur which have not been contemplated by the Parties and which fundamentally alter the equilibrium of the contract, thereby placing an excessive burden on the Seller in the performance of its contractual obligations (hardship), the Seller shall have the power to make any revision to the contract that it finds just and equitable in the circumstances, or to terminate the contract at a date and on terms to be fixed.

Rev. n. 3/2024

THE CEMBRE GROUP

PRODUCTION Units

CEMBRE SpA - Italy



CEMBRE Ltd - UK



CEMBRE Sarl - France



CEMBRE SLU - Spain



COMMERCIAL Units

CEMBRE GmbH - Germany



CEMBRE BV - Eindhoven, Netherland



CEMBRE Inc - USA



CEMBRE Co. Ltd. - Shanghai, China



Making the right connections

CEMBRE products are intended for professional users (B2B). The applicability of consumer protection regulations, including those related to warranty, is expressly excluded. Please refer to the manufacturer's website, www.cembre.com, for any information regarding product terms and conditions of sales and warranty. The sale of CEMBRE products through channels accessible to consumers is expressly prohibited, and vendors who contravene this prohibition will assume all civil and criminal liability towards third parties and the competent authorities.

Copyright © 2025 All rights reserved.

All contents of this catalog belong to CEMBRE S.p.A. Any reproduction, even in part, is prohibited without prior written permission from CEMBRE. All images are included for illustration purposes; CEMBRE reserves the right to make changes and improvements to the products without notice. Procedures for the use of the products shown should not be inferred from this document, but from the specific use and maintenance manuals provided with the products.

Edited by CEMBRE SpA - TIBER Group Press (BS), June 2025

Code 6260474



Где купить:
ООО "КОМПАНИЯ ОПТУЛС"
г.Москва, ул.Бирюлёвская, д.53, корп. 2, офис 113
Tel.: +7 (495) 646-00-96
E-Mail: sale@opttools.ru
Internet: www.opttools.ru



CONTACT US

CEMBRE S.p.A.
via Serenissima, 9
25135 Brescia
Italy
Ph +39 030 36921
ufficio.vendite@cembre.com
sales@cembre.com

CEMBRE Ltd.
Dunton Park,
Kingsbury Road,
Curdworth,
Sutton Colfield,
West Midlands, B76 9EB
United Kingdom
Ph +44 01675 470440
sales@cembre.co.uk

CEMBRE S.a.r.l.
Tour Part-Dieu
129 rue Servient
69003 Lyon
France
Tel +33 04 20 93 01 70
info@cembre.fr

CEMBRE SLU
Calle Verano 6 y 8
Pl Las Monjas
28850 Torrejón de Ardoz
Madrid - Spain
Ph +34 91 4852580
comercial@cembre.es

CEMBRE GmbH
Geschäftsbereich
Energie- und Bahntechnik
Heidemannstr. 166
80939 München - Germany
Ph + 49 89-3580676
info@cembre.de
Geschäftsbereich
Industrie und Handel
Boschstraße 7
71384 Weinstadt - Germany
Ph +49 7151-20536-60
info-w@cembre.de

CEMBRE B.V.
Luchthavenweg 53
5657EA Eindhoven
The Netherlands
info@cembre.nl

CEMBRE Inc.
Raritan Center Business Park
300 Columbus Circle-S.F.
Edison, NJ 08837 USA
Ph +1 (732) 225-7415
sales.us@cembre.com

Midwest Office
1051 Perimeter Dr #470
Schaumburg, IL 60173

**Cembre Electrical
Connections Shanghai Ltd.**
Room 2201,
Jin Hang Mansion, NO.83
Wan Hang Du Road,
Jing An District,
Shanghai
info@cembre.cn
sales@cembre.cn

FOLLOW US

