

MOBILITY

SELECTION 2019 / EN



NEW



WT 1056 11
TOOL
RUCKSACK
PROFI



WK 1072 L
TOOL BAG



1110 WMW-5-03
TOOL ASSORTMENT
for WORKMO® W3,
110 pieces

GEDORE @WORK

IDEALLY EQUIPPED FOR STORAGE AND ACCESSORIES



THERE ARE LOTS OF GREAT TRANSPORTATION SOLUTIONS

from the company to the place of work. WORKMO® and the Mixx&Click system are GEDORE's modular, mobile tool storage systems. Where to do with all the tools when you are on a ladder, on a top-floor gable, in the pit or under the hydraulic lift? That's when you need a central, mobile tray or store for tools and incidentals!

Hands free for working, holding on or securing things and yet with the tool you need always to hand - no problem as long as you have the right storage system and accessories.

Available in the GEDORE @work range are not only tool cases and belts with a host of optional bags, holsters and hooks but also rucksacks and tool vests. Tools are securely kept in them and are always to hand when needed.





ALL @WORK PRODUCTS

ensure no freedom-of-movement restrictions, tool weight optimum distribution and every bag holding what it is meant to hold. Thus the material is particularly rugged, long-lasting, easy to clean and with the capacity to take up considerable loads. All made possible thanks to a smart mix of leather and synthetics and reinforced base inserts. As such, even large, heavy bags remain stable with no wearing through of the bottom or sides. All bags are finished in double-stitch safety seams. Attached holders and bag covers are even reinforced, in part, with safety rivets. Nothing gets lost thanks to absolutely secure fasteners. Tools and incidentals, such as bits and screws, remain in place.

And the best thing is that all bags, holsters and belts of the @work series are combinable. Besides the extended functions, diversity and appearance have undergone changes. Along with the new bags and scope for individualisation, the tried-and-tested @work products have also been redesigned.

1 Practical

- › Tools always to hand
- › Optimum, clear compartment arrangement
- › Sufficient storage space

2 Rugged

- › Low-on-wear leather and synthetic mix for durability
- › Safety rivets and seams for extreme robustness
- › Low intrinsic weight and high load-carrying capacity
- › Stability even with heavy contents
- › Easy to clean:



3 Safe

- › Optimum weight distribution
- › Unlimited freedom of movement
- › Hands free for securing and working
- › Secure fasteners

4 Individual

- › Combinable with other @work products
- › Available empty or with a range of tools
- › Extendable at any time
- › Adjustable belt and fastener sizes

WT 1056 1

HEAVY-DUTY BELT

with cushioning

- › Fits waist size from 80-120 cm
- › Strongly cushioned for maximum comfort
- › Made from leather



L	W	max. load capacity kg	Code	No.	
1330	145	12	1802410	WT 1056 1	0.446

WT 1056 2

UNIVERSAL POUCH

- › Leather pocket for knives
- › Hammer holder with metal hooks
- › Hook for tape measure



W	H	max. load capacity kg	Code	No.	
290	290	5	1811096	WT 1056 2	0.434

WT 1056 2-001

TOOL SET @WORK

4 pieces

- › Practical set for dry walling and renovation, new construction and conversion work
- › Tools carried around securely, efficiently and always to hand



Contents	pieces	Code	No.
Universal pouch No. WT 1056 2, Carpenter's hammer No. 75 ST, 600 g, Steel tape measure No. 4534-3, tape L. 3 m, Pocket knife No. 0059-10, blades L. 100 mm	4	3100545	WT 1056 2-001

WT 1056 3

DRILL HOLSTER

- › Suitable for drill-machines and battery-drills
- › With pockets for screws and bits
- › Securing loop to prevent loss



W	H	max. load capacity kg	Code	No.	
210	320	4	1818147	WT 1056 3	0.184

WT 1056 4

HAMMER HOLDER

with metal hooks

- › Holds any claw hammer at a comfortable angle
- › Enables boundless freedom of movement
- › Polyester
- › Stainless tab



W	H	max. load capacity kg	Code	No.	
100	160	3	1818155	WT 1056 4	0.118

WT 1056 4-001 TOOL SET @WORK

2 pieces

- > Ideal for the building trade and especially for formwork
- > Carpenter's hammer carried around securely, efficiently and always at hand



Contents		pieces	Code	No.
Hammer holder with metal hooks No. WT 1056 4, Carpenter's hammer No. 75 ST, 600 g		2	3100561	WT 1056 4-001

WT 1056 5 THREE-POUCH BELT SET

- > Fits waist size from 80-120 cm
- > 4 holsters, 5 storage pockets and 1 eyelet for tape measure



W	H	max. load capacity kg	Code	No.	
690	270	10	1818163	WT 1056 5	0.830

WT 1056 5-001 TOOL SET @WORK

6 pieces

- > Practical set for boarding work
- > Tools carried around securely, efficiently and always to hand



Contents		pieces	Code	No.
Three-pouch belt set No. WT 1056 5		6	3100588	WT 1056 5-001
Steel tape measure No. 4534-3, tape L. 3 m				
Pocket knife No. 0059-10, blades L. 100 mm				
Carpenter's hammer No. 75 ST, 600 g				
Wrecking bar No. 120-350, 350 mm				
Pincer No. 8381-225 TL, 225 mm				

WT 1056 6 ELECTRICIANS' POUCH

- > Generous pouch space
- > Pockets for screwdrivers
- > Extra pocket for insulation stripping knife
- > Holding shackle for insulating tape



W	H	max. load capacity kg	Code	No.	
240	320	3	1818171	WT 1056 6	0.424

WT 1056 6-001 TOOL SET @WORK 15 pieces

- > Electrical wiring and repairs made easy
- > Carrying around done securely, efficiently and everything always to hand



Contents	pieces	Code	No.
WT 1056 6, Electricians' pouch	15	3100596	WT 1056 6-001
⊖ VDE Screwdriver slotted No. VDE 2172, 3.5 5.5 mm, SLIM,			
⊕ VDE Screwdriver cross-slotted No. VDE 2162 PH 1 2, SLIM,			
⊕⊖ VDE Screwdriver cross-slotted No. VDE 2164 SL/PH 2 SLIM,			
⊖ Voltage tester slotted No. VDE 4616, 12-1000 V, 3 mm,			
VDE Stripping pliers No. VDE 8098-160 H, 160 mm, 2C handle, VDE Power side cutter No. VDE 8314-160 H, 160 mm,			
VDE Multiple pliers No. VDE 8131 AB-200 H, 200 mm, VDE Cable shears No. VDE 8094, 200 mm,			
VDE Cable knife No. VDE 4522, 180 mm, Multi-use cable knife No. 4529, blade L. 145 mm,			
Insulating tape No. 4629, 10 m, Multi-fitting key ELECTRO No. 45 E			

WT 1056 7 HEAVY-DUTY BELT SET

- > Heavily padded belt for superior comfort when fully loaded
- > Fits waist size from 80-120 cm
- > Leather basic belt
- > All inclusive: Holster, hammer holder, 2 pockets and mobile phone holder - available separately No. WT 1056 7-1



Description	↳ mm	max. load capacity kg	Code	No.	kg
Heavy-duty belt set	1330	12	1818198	WT 1056 7	1.106
Mobile phone holder		-	1963171	WT 1056 7-1	0.052

WT 1056 8 DUO POUCH

- > Leather pocket for knives
- > 2 large storage pockets



W	H	max. load capacity kg	Code	No.	kg
240	280	3	1818201	WT 1056 8	0.348

WT 1056 9 TOOL-ROLL

- > 12 inside pockets for slim tools, e.g. combination spanners or screwdrivers
- > Tools not supplied



W	H	max. load capacity kg	Code	No.	
320	350	2	1818228	WT 1056 9	0.260

WT 1056 9-001 TOOL SET @WORK 13 pieces

- > Combination spanner in classic tool roll
- > Easy to carry around, space-saving storage
- > Tools clearly spread out and ready-for-use



Contents	pieces	Code	No.
Wallet No. WT 1056 9	13	3100634	WT 1056 9-001
Combination spanner set No. 7-0112, AF 6 7 8 9 10 11 12 13 14 15 17 19 mm			

WT 1056 9-003 TOOL SET @WORK 10 pieces

- > Basic tool set in classic tool roll
- > Ideal for minor repairs in the home
- > Easy to carry around, space-saving storage
- > Tools clearly spread out and ready-for-use



Contents	pieces	Code	No.
Universal pliers No. 142 10 TL, 10", Power combination pliers No. 8250-180 TL, 180 mm, Power side cutter No. 8316-160 TL, 160 mm, 3C screwdriver slotted No. 2150, 4 5.5 6.5 8 mm, 3C screwdriver cross-slotted No. 2160SK PH 1 2, Wallet No. WT 1056 9	10	3100650	WT 1056 9-003

S7 R-04 COMBINATION RATCHET SPANNER SET 4 pieces

- > Most popular sizes as a set
- > Flat pattern
- > UD profile
- > High torque transfer
- > Working angle: 7° from 10 to 13 mm, 6° from 17 to 19 mm
- > For ratchet loosening and fast tightening
- > In practical bag



Contents	pieces	Code	No.	
7 R 10 13 17 19	4	2303949	S7 R-04	0.680

WT 1056 11

TOOL RUCKSACK PROFI

empty

- > With extra large storage space
- > Tools not included



W	H	D	max. load capacity kg	Code	No.	
300	400	120	15	1818244	WT 1056 11	2.696

WT 1056 12

TOOL RUCKSACK SOFT

- > SOFT rucksack, extremely light and yet strong
- > Extremely comfortable to carry
- > Strong industrial seams
- > Non-tearing polyester fabric



W	H	D	max. load capacity kg	Code	No.	
380	410	70	12	1818252	WT 1056 12	1.600

WT 1056 13

TOOL VEST

- > Universal size with 4 lateral buckles
- > Tear-resistant polyester fabric and suede
- > Tools not supplied



W	H	max. load capacity kg	Code	No.	
480	660	5	1818260	WT 1056 13	0.818

TC 1500 CT1 L

TEXTILE CASE

empty, for 1500 CT1 modules

- > Robust textile bag with a strong Velcro fastening and handle
- > Textile bag compatible with GEDORE module system 1500 CT
- > Of splash-proof canvass
- > Tools not supplied



W	D	H	Code	No.
337	185	60	3100693	TC 1500 CT1 L

TC 666-MU-20 BIT BOX WITH RATCHET 1/4" IN TEXTILE CASE 35 pieces

- > Ultra thin-walled 1/4" socket sets
- > Suitable for mechanical and hand-operated use
- > Robust textile bag with a strong Velcro fastening and handle
- > Ensure your tools are always to hand in our water- and dirt-resistant bags
- > Non-slip tool storage
- > GEDORE Check-Tool system



Ratchet	Sockets	Accessories	pieces	Code	No.	
GEDORE ratchet 1/4" 2093 U-20	1/4" impact socket 4.5 5 5.5 6 7 8 9 10 11 12 13 mm 1/4" screwdriver bit hex, 4 5 6 8 mm 1/4" screwdriver bit TX, T10 T15 T20 T25 T27 T30 T40 1/4" screwdriver bit cross-head PH1 PH2 PH3 1/4" screwdriver bit cross-head PZ1 PZ2 PZ3 1/4" screwdriver bit slotted, 4.5 5.5 6.5 mm	Universal extension 1/4" 50 mm Bit adapter 1/4" square - 1/4" hexagon Adaptor 1/4" outer hex - 1/4" outer square	35	3085015	TC 666-MU-20	0.593

TC 19-20-MU-10 SOCKET SET 1/4"-1/2" IN TEXTILE CASE 52 pieces

- > Tools in metric sizes
- > With robust reversible ratchet with push-button release
- > Robust textile bag with a strong Velcro fastening and handle
- > Foam module compatible with GEDORE tool trolley
- > Ensure your tools are always to hand in our water- and dirt-resistant bags
- > Non-slip tool storage
- > GEDORE Check-Tool system



Ratchet	Sockets	Accessories	pieces	Code	No.	
U-10 1993 U-10 T U-3 2093 U-3 T	C19 10 12 13 15 16 17 18 19 22 24 27 30 32 D 20 4 5 6 7 8 9 10 11 12 13 680 4 5.5 6.5 685 3 4 5 6 685 X 5 6 8 687 TX T10 T15 T20 T25 T27 T30 T40 690 1 2 690 PZD 1 2 3	Universal extension 1/2" no. 1990 KR-10 2090-4 620 676 699	52	3085031	TC 19-20-MU-10	3.3

TC 19-MU-10

SOCKET SET 1/2"

IN TEXTILE CASE

16 pieces

- › Tools in metric sizes
- › With robust reversible ratchet with push-button release
- › Robust textile bag with a strong Velcro fastening and handle
- › Textile bag compatible with GEDORE module system 1500 CT
- › Foam module compatible with GEDORE tool trolley
- › GEDORE Check-Tool system



Sockets	Ratchet	Accessories	pieces	Code	No.	kg
1/2" C19 10 12 13 15 16 17 18 19 22 24 27 30 32	U-10 1993 U-10T	1/2" 1990 KR-5 1/2" 1990 -10	16	3085023	TC 19-MU-10	2.8

WK 1041 L

GEDORE TOOL CASE LARGE

empty

- › Sturdy aluminium frame with edge protectors, trays made of impact-resistant ABS plastic
- › When open, the case lid is prevented from locking unintentionally by the safety lid holder snapping into place
- › A4 document compartment in the lid
- › Variably divisible bottom tray
- › Lockable with two-tilt cylinder locks and a combination lock
- › Removable tool panel with 22 tool pockets at the front and back in the lid
- › Removable cover for bottom tray with 15 tool pockets



W	D	H	Code	No.	kg
490	395	185	3065405	WK 1041 L	4.9

1041-001

BASIC TOOL SET IN CASE

74 pieces

- › Basic set for all trades
- › Practical assortment for on-site use
- › Packed in a strong plastic case made from impact-proof ABS
- › Robust aluminium frame
- › Robust companion – whenever the right tools have always to be on hand



Contents	W	D	H	pieces	Code	No.	
Combination spanner no. 7, 10 13 17 19 22 mm Bit socket wrench no. 666-U-20, with ratchet 1/4" 35 pcs Hexagon socket key no. 42, 2 2.5 3 4 5 6 8 10 mm, in holder Adjustable wrench, open end no. 60 P 8 ⊖ 3C screwdriver slotted no. 2150, 3 4 5.5 6.5 8 mm ⊕ 3C screwdriver cross-slotted no. 2160, PH 0 1 2 Recoilless and engineer's hammer KOMBI-PLUS R no. 247 H-30, head D.30 mm Pocket measuring callipers no. 710 Steel tape measure no. 4534-3, tape L. 3 m ⊖ Voltage tester slotted no. 4615 3, 220-250 V, 3mm Stripping pliers no. 8098-160 JC, 160 mm 2C handle Multiple pliers no. 8133-200 JC, 200 mm 2C handle Power combination pliers no. 8250-180 JC, 180 mm 2C handle Power side cutter no. 8316-160 JC, 160 mm 2C handle Universal pliers no. 142 10 JC, 10" Striking tools set no. 106, 6 pcs Cable knife no. 0513-09, blades L.90 mm Wire brush no. 644, triple row + Volume tool bag WK 1041 L	490	395	185	74	3082121	1041-001	10.6

1041-002

PROFI TOOL SET IN CASE

100 pieces

- > Professional set for all trades
- > Practical assortment for on-site use
- > Packed in a strong plastic case made from impact-proof ABS
- > Robust aluminium frame
- > Robust companion – whenever the right tools have always to be at hand



Contents	W	D	H	pieces	Code	No.	
Combination spanner No. 1 B, AF 8 10 13 17 19 22 mm 1/2" socket No. 19, AF 8 10 13 17 19 22 mm 1/2" extension No. 1990-5 1/2" reversible ratchet No. 1993 U-20 Spring steel socket rail for 14 sockets 1/2" VH 19 1/4" Bit socket wrench box No. 666-U-20, with ratchet 35 pcs Hexagon socket key set No. H 42-10, in holder 10 pcs Hexagon socket key set TX No. H 43 TX-88, in holder 8 pcs Adjustable wrench, open end No. 60 P 8, 8" Striking tools set No. 106, 6 pcs Grip wrench No. 137 10 10 Square bladed awl No. 156 S Recoilless and engineer's hammer KOMBI-PLUS R No. 247 H-30 Hobby saw No. 406 Cable knife No. 0513-09 Spark plug brush No. 647 Pocket measuring callipers No. 710 ⊖ 3C screwdriver slotted No. 2150, 3 4 5.5 6.5 8 mm ⊕ 3C screwdriver cross-slotted No. 2160, PH 0 1 2 ⊕ 3C screwdriver cross-slotted No. 2160, PZ 1 2 Steel tape measure No. 4534-3, tape L. 3 m ⊖ Voltage tester slotted No. 4615 3, 220-250 V, 3mm Small universal scissors No. 8096-140 Stripping pliers No. 8098-160 JC, 160 mm 2C handle Multiple pliers No. 8133-200 JC, 200 mm 2C handle Combination pliers 8245-180 JC, 180 mm 2C handle Power side cutter No. 8316-160 JC, 160 mm 2C handle Universal pliers No. 142 10 TL, 10" + Tool case large No. WK 1041 L	490	395	185	100	3082148	1041-002	12.9

1041-003

VDE TOOL SET IN CASE

74 pieces

- > VDE basic range
- > Practical assortment for on-site use
- > Packed in a strong plastic case made from impact-proof ABS
- > Robust aluminium frame
- > Robust companion – whenever the right tools have always to be at hand



Contents	W	D	H	pieces	Code	No.	kg
Combination spanner No. 7, AF 10 13 17 19 22 mm, 1/4" Bit socket wrench box No. 666-U-20, with ratchet 35 pcs, Hexagon socket key set No. PH 42-88, AF 2 2,5 3 4 5 6 8 10 mm, Adjustable wrench, open end No. 60 P 8, 8", ⊖ VDE Screwdriver slotted No. VDE 2170, 3 3.5 4 5.5 6.5 8 mm, ⊕ VDE Screwdriver cross-slotted No. 2160 PH 0 1 2, Recoilless and engineer's hammer KOMBI-PLUS R 247 H-30, VDE Cable knife No. VDE 4522, 180 mm, Steel tape measure No. 4534-3, tape L. 3 m, ⊖ Voltage tester slotted No. 4615 3, 220-250 V, 3mm, VDE stripping pliers VDE 8098-160 H, VDE Multiple pliers No. VDE 8131 AB-200 H, VDE Power combination pliers No. VDE 8250-180 H, VDE Power side cutter No. VDE 8316-180 H, VDE Universal pliers No. VDE 146 10, 10", Striking tools set No. 106, 6 pcs, Cable knife No. 0513-09, blades L.90mm + Volume tool bag WK 1041 L	490	395	185	74	3082156	1041-003	10.3

WK 1040 L

GEDORE ROLLER TOOL CASE

empty

- > Handle with user-friendly telescopic grip
- > Widely spaced wheels with two inline castors for pulling without tipping
- > Sturdy aluminium frame with edge protectors, trays made of impact-resistant ABS plastic
- > A4 document compartment in lid and bottom tray with dividers
- > Lockable with two-tilt cylinder locks and a combination lock
- > Removable tool panel with 22 tool pockets at the front and back in the lid
- > Removable cover for bottom tray with 15 tool pockets



W	D	H	Code	No.	kg
490	395	240	3065391	WK 1040 L	6.2

WK 1072 L

TOOL BAG

empty

- > With carrying and strap
- > With plenty of compartments and additional elastic holders
- > Plastic hard-shell bottom prevents moisture absorption from below
- > Dimensionally stable
- > 26.2 l utilisable capacity



W	D	H	Code	No.	kg
515	335	360	3100421	WK 1072 L	2.400

S 1072-001

TOOL BAG WITH TOOLS

29 pieces

- > With carrying and strap
- > With plenty of compartments and additional elastic holders
- > Plastic hard shell bottom, no moisture absorption
- > Dimensionally stable
- > Starter package for any handyman



Contents	W	D	H	pieces	Code	No.	
Combination spanner 10 13 14 17 19, Socket 10 13 14 17 19 mm, Extension 125 mm, Reversible ratchet 1/2", 3C screwdriver slotted 5.5x1x100mm 8x1.2x150mm, 3C screwdriver PH 1 2, Hexagon socket key 2 2.5 3 4 5 6 8 mm, Universal pliers 12" 17 settings, Voltage tester 220-250 V, Tape measure L. 3m, Power combination pliers L.180 mm, Flat chisel L.150 mm, Engineer's hammer 300 g	515	335	360	29	3100448	S 1072-001	5.9

1000

TOOL CASE TOURING

49 pieces

- > Universal GEDORE tool set, 49 pieces,
for highest requirements
- > Neatly and clearly arranged tools - laid out in
foam cut out tool control system
- > Space-saving and robust in tough plastic case,
resistant to oil



   mm

Contents	W	D	H	pieces	Code	No.	
Combination spanner No. 7, AF 6 7 8 10 11 12 13 14 15 17 19 mm 1/2" socket hex No.19, AF 10 11 12 13 14 15 17 19 22 mm Extension 1/2" No. 1990-5 -10, 125 250 mm Universal joint 1/2" No. 1995, 73.5 mm Reversible ratchet 1/2" No. 1993 U-20, 270 mm Hexagon socket key set No. PH 42-88, 2-10 mm in holder 8 pcs ⊖ 3C screwdriver slotted No. 2150, 4 5.5 6.5 mm ⊕ 3C screwdriver cross-slotted No. 2160 PH 1 2 ⊖ Voltage tester 220-250 V, slotted No. 4615 3, 3 mm Cable knife No. 0513-09, 195mm, Universal pliers No. 142 10 TL, 10" Power side cutter No. 8316-160 JC, 160 mm 2C handle Multiple pliers No. 8133-180 JC, 180 mm 2C handle Engineers' hammer ROTBAND-PLUS No. 600 H-300, 300 g Striking tools set No. 106 6 pcs, in PVC holder No. 106 + case WK 1000 L	430	360	149	49	6600780	1000	7.0

GEDORE WORKMO® – THE MOBILE ORDERLY ARRANGEMENT, TRANSPORT AND WORKING SYSTEM

Thanks to the modular and ergonomic design, the GEDORE WORKMO® system efficiently unites transport, orderliness and workplace. The box modules are quickly and easily transformable into portable units. They, in turn, are lightweight, load-securing and crash-tested. The assembled box modules provide for a dependable tool/working station. As such, WORKMO® is ideally adaptable to the needs of every operation and brings about maximum flexibility and professional support on a daily basis. Optional castors also allow use as a mobile workstation. Equipping the WORKMO® drawers with pre-configured tool sets in matching foam inserts and the scope of the GEDORE iMOD range for individualising tool module requirements round off the overall package. Practically all requirements are thus covered.

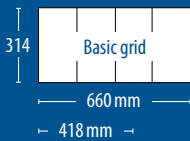

The drawer sizes and module variants are shown on a joint basic grid. The raster determines the drawers (blue) which are individually combinable with the tool modules (coloured). Configuration examples are on the right.

FEATURES

WORKMO

1 Light:

- > Low weight due to aluminium-plastic mix
- > Ergonomic working heights

2 Individual:

- > WORKMO® adapts exactly to the requirements of your individual working day
- > With the foam configurator the tool equipment can be arranged individually

3 Compatible:

- > with the Sortimo® L-BOXX® range
- > with the GEDORE tool modules 1500 ES/1500 CT

4 Sturdy:

- > Robust handling – lockable - durable
- > Rounded plastic edges for impact and scratch protection

5 Drawer equipment:

- > Ideal for fitting out with WORKMO® modules complete with GEDORE tools
- > Modules for two drawer widths

6 Flexible:

- > Expandable at any time (with castors, worktop etc.)
- > For further system components see Sortimo®

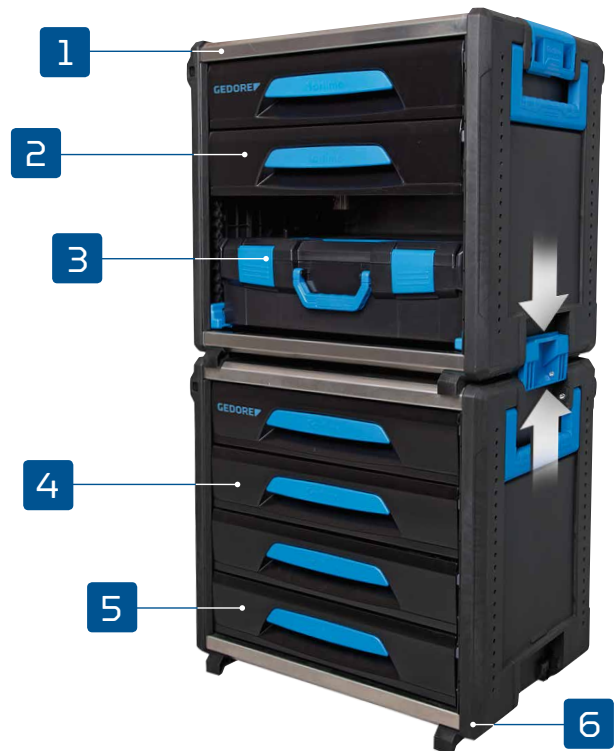

Drawer W2



Drawer W3



Drawer sizes with the WORKMO® box module equipping grid

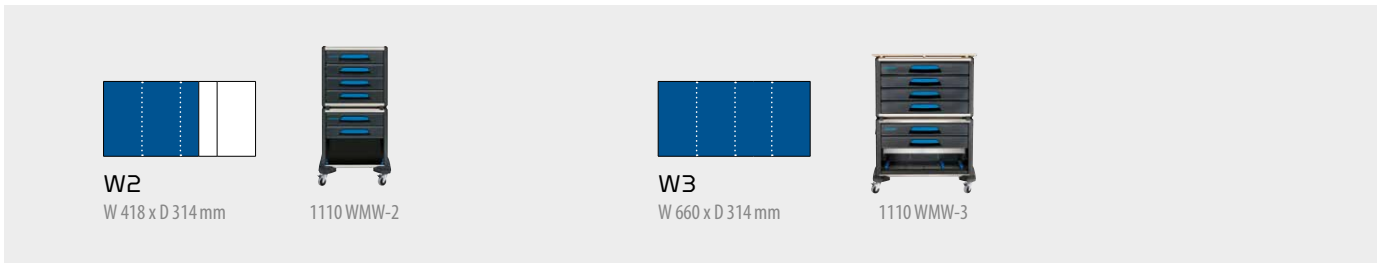

Module variants for fitting out individually



Configuration example



GEDORE INDIVIDUAL "I-MODULES"



You haven't found the right tool modules for yourself?

Why not create your perfection in tool orderliness in line with corporate design requests and your process specifications - We look forward to hearing from you!

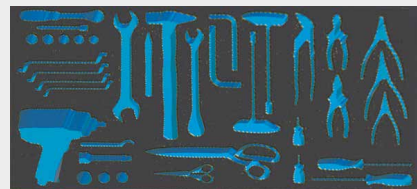

1110 WMW-2 TOOL TROLLEY WORKMO W2

- > Modular tool trolley
- > Ideal for transportation from the workshop to changing workplaces
- > 6 drawers fully extendable suited for GEDORE 1500 ES/1500 CT modules
- > One compartment with locking device for GEDORE L-BOXX® 136 no. 1100 L (not included)
- > **Compatible with Sortimo® interior vehicle fittings and load safety**
- > Dimensions: W 526 x D 396 x H 1172 mm
- > **Weight benefit** (up to 50 % lighter than comparable solutions!)



W	D	H	Code	No.	
526	396	1172	2954435	1110 WMW-2	42.6

WORKMO® W2 AS SET WITH ASSORTMENT

1110 WMW-S-02 TOOL ASSORTMENT FOR WORKMO W2

72 pieces

- > Modular tool trolley
- > Ideal for major and minor maintenance and assembly work
- > For industry, the trades, automotive and the ambitious do-it-yourselfers
- > The right GEDORE assortment, as required, for trainees, apprentices and do-it-yourselfers



Contents	W	D	H	pieces	Code	No.	
Workshop trolley No. 1110 WMW-2	526	396	1172	4	3005186	1110 WMW-S-02	50.5
GEDORE L-BOXX® 136 No. 1100 L							
Tool assortment No.1 1110 CTB2-01							
Tool assortment No.1 1110 CTB2-02							

1110 CTB2-01

TOOL ASSORTMENT

in CT module for W2, 22 pieces

- > Composition of GEDORE tool assortment based on daily workshop routines
- > For industry, the trades, automotive and the ambitious do-it-yourselfers
- > CTB2 modules fit into the WORKMO® tool trolley drawers and the L-BOXX® 136 tool box



Contents	W	D	H	pieces	Code	No.	
Combination spanner No. 7, AF 10 12 13 14 15 16 17 18 19 22 24 27 mm	417	314	35	22	3005224	1110 CTB2-01	3.4
Engineers' hammer No. 4 E-500, 500 g							
Centre punch No. 100-12, 120x12x5 mm							
Pin punch No. 119-4 -5 -6 -8, Ø 5 6 8 mm							
Flat chisel No. 97-250, 250 mm							
Cross-cut chisel No. 98-125, 125 mm							
Drift punch No. 99 12-5 12-8, Ø 5 8 mm							

1110 CTB2-02

TOOL ASSORTMENT

in CT module for W2, 49 pieces

- > Composition of GEDORE tool assortment based on daily workshop routines
- > For industry, the trades, automotive and the ambitious do-it-yourselfers
- > Impact cap screwdriver, positive-fit joint of handle and blade for an optimum transmission of force
- > CTB2 modules fit into the WORKMO® tool trolley drawers and the L-BOXX® 136 tool box

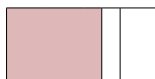

Contents	W	D	H	pieces	Code	No.	
⊖ 3C screwdriver slotted No. 2154SK 3.5 5.5 6.5 8 mm	417	314	35	49	3005232	1110 CTB2-02	2.2
⊕ 3C screwdriver cross-slotted No. 2160SK PH 1 2							
Hexagon socket key set No. PH 42-88, 6kt SW 2 2,5 3 4 5 6 8 10 mm							
Universal pliers No. 142 10 TL, 10"							
Multiple pliers No. 8133-200 JC, 200 mm 2C handle							
Power side cutter No. 8316-180 JC, 180 mm 2C handle							
1/4" Bit box No. 666-032-A, 32 pcs							

1110 WM 24

TOOL BOX MODULE WORKMO W2

4 drawers H6

- > 4 drawers fully extendable suited for GEDORE 1500 ES/1500 CT modules
- > Lightweight and stable aluminium/plastic mix
- > Compatible with Sortimo® interior vehicle fittings and load safety
- > Crash tested
- > Load capacity per drawer 30 kg
- > Dimensions: B 526 x D 396 x H 506 mm
- > Drawer size inside B 418 x D 314 x H 89 mm



W	D	H	Code	No.	
526	396	506	2954311	1110 WM 24	21.9

1110 WM 221

TOOL BOX MODULE WORKMO W2

2 drawers H6, compartment for L-BOXX®

- > 2 drawers fully extendable suited for GEDORE 1500 ES/1500 CT modules
- > A lock-fitted compartment for GEDORE L-BOXX® 136 No. 1100 L (not included in the scope of delivery)
- > Lightweight and stable aluminium/plastic mix
- > Compatible with Sortimo® interior vehicle fittings and load safety
- > Crash tested
- > Load capacity per drawer 30 kg
- > Dimensions: B 526 x D 396 x H 506 mm
- > Drawer size inside B 418 x D 314 x H 89 mm



W	D	H	Code	No.	kg
526	396	506	2954338	1110 WM 221	15.3

1110 WMHP 2

WOOD PLATE

for WorkMo W2

- > 20 mm thick multiplex beech wood worktop
- > Add to WorkMo boxes W2 to get an additional work surface



W	D	H	Code	No.	kg
571	426	20	2954362	1110 WMHP 2	4.5

1110 WMR 24

ROLLER

for WorkMo W2

- > A coupler lever connects the roller to the WorkMo boxes
- > Extra lashing points make for safe transfers of another load as well
- > Loading capacity: 200 kg



W	D	H	Code	No.	kg
612	493	144	3002721	1110 WMR 24	8.0

1110 WMW-3 TOOL TROLLEY WORKMO W3

- > Modular tool trolley
- > Ideal for transportation from the workshop to changing workplaces
- > 6 drawers fully extendable suited for GEDORE 1500 ES/1500 check tool modules
- > 1 compartment with locking device for GEDORE L-BOXX® 136 no. 1100 L and GEDORE S-BOXX® no. 1110 WMSB 3 (both not included)
- > **Compatible with Sortimo® interior vehicle fittings and load safety**
- > Dimensions: W 789 x D 396 x H 1172 mm
- > **Weight benefit** (up to 50 % lighter than comparable solutions!)



W	D	H	Code	No.	
789	396	1172	2954443	1110 WMW-3	52.8

WORKMO® W3
AS SET WITH ASSORTMENT

1110 WMW-S-03 TOOL ASSORTMENT FOR WORKMO W3

110 pieces

- > Modular tool trolley
- > Ideal for major and minor maintenance and assembly work
- > For industry, the trades, automotive and the ambitious do-it-yourselfers
- > The right GEDORE assortment, as required, for trainees, apprentices and do-it-yourselfers



1100 L



1100 CTB3-01



1100 CTB3-02

Contents	W	D	H	pieces	Code	No.	
Workshop trolley No. 1110 WMW-3 GEDORE L-BOXX® 136 No. 1100 L S-BOXX® B3 No. 1110 WMSB 3 Tool assortment No. 1110 CTB3-01 Tool assortment No. 1110 CTB3-02	789	396	1172	110	3005194	1110 WMW-S-03	64.3

1110 CTB3-01

TOOL ASSORTMENT

in CT module for W3, 43 pieces

- > Composition of GEDORE tool assortment based on daily workshop routines
- > For industry, the trades, automotive and the ambitious do-it-yourselfers
- > CTB3 modules fit into the WORKMO® tool trolley drawers



Contents	W	D	H	pieces	Code	No.	
Combination spanner No. 7, AF 10 12 13 14 15 16 17 18 19 22 24 27 mm	660	314	35	43	3005240	1110 CTB3-01	6.1
Engineers' hammer No. 4 E-500, 500 g							
Centre punch No. 100-12, 120x12x5 mm							
Pin punch No. 119-4 -5 -6 -8, Ø 4 5 6 8 mm							
Flat chisel No. 97-250, 250x24 mm							
Cross-cut chisel No. 98-125, 125x10x5 mm							
Drift punch No. 99 12-5 12-8, Ø 120x12x5 mm							
1/2" socket No. 19, AF 8 9 10 11 12 13 14 15 16 17 18 19 20 22							
24 27 30 32 mm							
1/2" reversible ratchet No. 1993 U-20							
1/2" universal extension No. 1990 KR-5 -7, 125 180 mm							

1110 CTB3-02

TOOL ASSORTMENT

in CT module for W3, 65 pieces

- > Composition of GEDORE tool assortment based on daily workshop routines
- > For industry, the trades, automotive and the ambitious do-it-yourselfers
- > Impact cap screwdriver, positive-fit joint of handle and blade for an optimum transmission of force
- > CTB3 modules fit into the WORKMO® tool trolley drawers

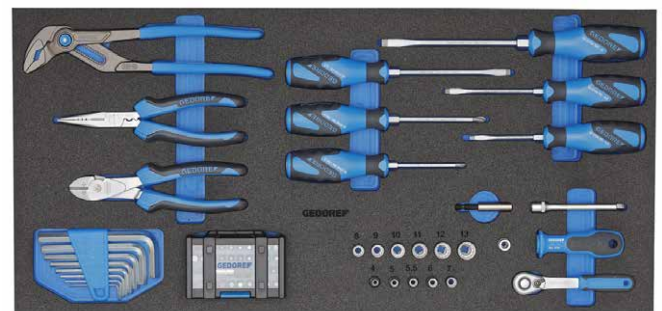

Contents	W	D	H	pieces	Code	No.	
⊖ 3C screwdriver slotted No. 2154SK 3.5 5.5 6.5 8 mm	660	314	35	65	3005267	1110 CTB3-02	2.8
⊕ 3C screwdriver cross-slotted No. 2160SK PH 1 2							
Hexagon socket key set No. PH 42-88, 6kt SW 2 2,5 3 4 5 6 8 10 mm							
Universal pliers No. 142 10 TL, 10"							
Multiple pliers No. 8133-200 JC, 200 mm							
Power side cutter No. 8316-180 JC, 180 mm							
1/4" Bit box No. 666-032-A, 32 pcs							
Bit adapter No. 620, 1/4" hex x 1/4" square							
1/4" multi-handle No. 676							
1/4" bit holder No. 699, hex							
1/4" socket No. D 20, AF 4 5 5,5 6 7 8 9 10 11 12 13 MM							
1/4" reversible ratchet No. 2093 U-20							
1/4" universal extension No. 2090 KR-4, 97 mm							

1110 WM 34

TOOL BOX MODULE WORKMO W3

4 drawers H6

- > 4 drawers fully extendable suited for GEDORE 1500 ES/1500 check tool modules
- > Lightweight and stable aluminium/plastic mix
- > Compatible with Sortimo® interior vehicle fittings and load safety
- > Crash tested
- > Load capacity per drawer 60 kg
- > Drawer size inside B 660 x D 314 x H 89 mm



W	D	H	Code	No.	
789	396	506	2954346	1110 WM 34	27.9

1110 WM 321

TOOL BOX MODULE WORKMO W3

2 drawers H6, compartment for L-BOXX® + S-BOXX®

- > 2 drawers fully extendable suited for GEDORE 1500 ES/1500 check tool modules
- > A lock-fitted compartment for GEDORE L-BOXX® 136 No. 1100 L and for GEDORE S-BOXX® No. 1110 WMSB 3 (none of the two included in the scope of delivery)
- > Lightweight and stable aluminium/plastic mix
- > Compatible with Sortimo® interior vehicle fittings and load safety
- > Crash tested
- > Load capacity per drawer 60 kg
- > Drawer size inside B 660 x D 314 x H 89 mm



W	D	H	Code	No.	
789	396	506	2954354	1110 WM 321	22.1

1110 WMHP 3

WOOD PLATE

for WorkMo W3

- > 20 mm thick multiplex beech wood worktop
- > Add to WorkMo boxes W3 to get an additional work surface



W	D	H	Code	No.	
834	426	20	2954370	1110 WMHP 3	4.5

1110 WMR 34

ROLLER

for WorkMo W3

- > A coupler lever connects the roller to the WorkMo boxes
- > Extra lashing points make for safe transfers of another load as well
- > Loading capacity: 200 kg



W	D	H	Code	No.	
854	493	144	3002713	1110 WMR 34	9.0

1110 WMS 23

LOCKING SYSTEM

for WorkMo W2+W3

- › Protects drawers and BOXX[®]es against extraction
- › Secures the tools against unauthorised access



Code	No.	kg
2954389	1110 WMS 23	0.920

1110 WMR 23

ROLLER SKIDS, PAIR

for WorkMo W2+W3

- › Makes the tool box modules mobile
- › 4 swivel castors, 2 with total brake
- › Max. load capacity: 150 kg (per roller skid 75 kg)



Wheel diameter	Code	No.	kg
100	2954397	1110 WMR 23	3.2

1110 WMT 23

DIVIDER SET

for WorkMo drawers W2+W3

- › To divide the drawers
- › 3 lengthwise dividers and mounting brackets



W	H	Code	No.	kg
311	62	2954419	1110 WMT 23	0.270

1110 WMSB 3

S-BOXX[®] W3

with window

- › Viewing window for a quick visual check of the contents
- › Ideal for the storage of expendables, such as screws etc.
- › Load capacity 12 kg



W	D	H	Code	No.	kg
147	351	153	2954427	1110 WMSB 3	0.680

THE GEDORE MIXX&CLICK KIT

The Sortimo transport box system is perfect for mobile deployment requirements. The MIXX&CLICK kit is based on the proven GEDORE L-BOXX® 136 with front grips and tool board in the lid and the GEDORE i-BOXX® 72. These are multiply compatible and therefore extremely flexible. A high degree of individualisation is realizable. Thus, the MIXX&CLICK system features, in particular, a wide scope for combinations as a result of the pre-configured GEDORE tool ranges. Even modules from other manufacturers, such as Bosch electrical instruments, can be used. Together with other components from the Sortimo® range of tools (transport boxes and system components) a well-organized “to go” workshop is built up to match your personal requirements.

FEATURES



1

Tool board

> for re-equipping or customizing the L-BOXX® depending on the work involved



2

Tool modules

> for equipping the L-BOXX® with 1/2 and 2/2 modules



3

i-BOXX® RACK-ACTIVE click system

> ensures your i-BOXX® tool assortments are securely transported. It is compatible with all L-BOXX®es



4

L-BOXX® roller

> Fit and click to attach roller and BOXX®

The heart of the kit - GEDORE L-BOXX® 136 with front grip powered by Sortimo® - features:

- › Strong construction
- › Easy and convenient transfer of tools to where they are needed
- › Impact-resistant ABS plastic
- › Standard lid handle to carry the L-BOXX® horizontally
- › Additional kind-to-hands front grip to carry the L-BOXX® vertically
- › Splash-proof
- › GEDORE tool board for a clearer arrangement and more storage space
- › Easy-click system: Practical plug connection for two or more L-BOXX®es, for a secure grip and easy transport
- › No-problem integration in vehicles with the TÜV-tested Sortimo® vehicle fittings



2 STRONG PARTNERS - 1 SYSTEM

MOBILITY IN PERFECTION

Sortimo®
Intelligent Mobility

- › Tools, machines and material must be easily, safely, quickly and conveniently transported to the place of use i.e. in a preferably resources-saving manner.
- › Lengthy loading times must be avoided at all costs - guaranteed load securing is a pre-condition here!
- › GEDORE's Sortimo® transport box system relies on a tried-and-tested mobility standard.
- › The perfect alliance for intelligent, efficient process and project design planning.

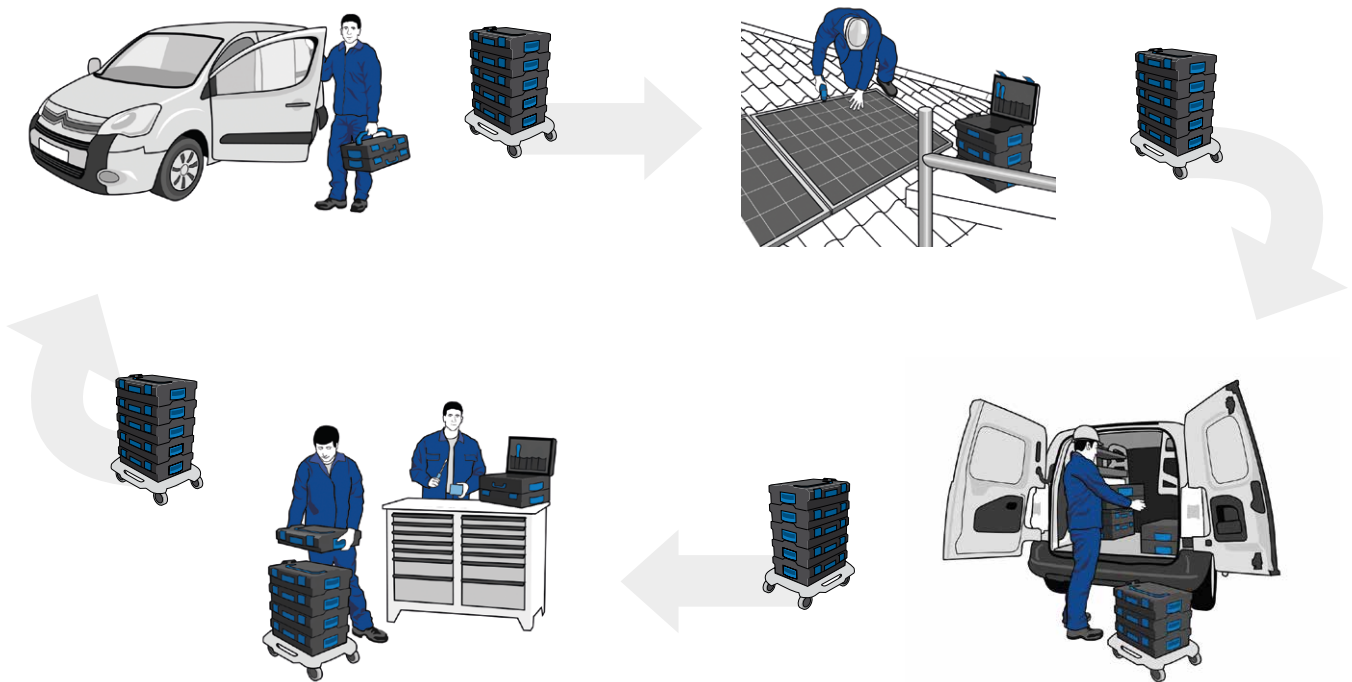

Your advantage

- › Intelligent order systems
- › Flexible, modular and individual
- › Ideal for mobile deployments
- › Diverse and highly efficient
- › Quick accessing of tools - perfect organisation
- › Transport box standard - e.g. compatible with electrical tool manufacturers
- › Guaranteed safety

For your safety

- › The GEDORE L-BOXX®es are fully compatible with Sortimo® vehicle fittings.
- › GEDORE L-BOXX® quality is constantly examined on the basis of the strict Sortimo® directives. Sortimo® has its quality endorsed through crash tests organized by the TÜV.
- › If it comes to the worst, then the tools stay where they belong - securely in their GEDORE L-BOXX®

1100-004 STARTER TOOL ASSORTMENT in GEDORE L-BOXX® 136, 30 pieces

- > Tools in metric sizes
- > Robust reversible ratchet with push-button release
- > GEDORE L-BOXX® 136 with an easy click attaching system



Contents	pieces	Code	No.	
Combination spanner No. 1 B, AF 8 10 13 16 17 18 19 22 24 mm	30	3085287	1100-004	8.4
1/2" socket No. C19, AF 10 12 13 16 17 18 19 22 24 27 mm				
1/2" extension No. 1990, 125 mm				
1/2" reversible ratchet No. 1993 U-10 T				
⊖ 3C screwdriver slotted No. 2150, 4 5.5 6.5 mm				
⊕ 3C screwdriver cross-slotted No. 2160 PH 1 2				
⊖ Voltage tester slotted 4615, 3 mm				
Universal pliers No. 142 10 TL, 10"				
Multiple pliers No. 8133-180 JC, 180 mm 2C handle				
Power side cutter No. 8316-180 JC, 180 mm 2C handle				

1100-BASIC STARTER TOOL ASSORTMENT in GEDORE L-BOXX® 136, 23 pieces

- > Basic set for all trades
- > GEDORE L-BOXX® 136 with an easy click attaching system



Description	Contents	pieces	Code	No.	
Starter assortment in L-BOXX 136, 23 pcs	Combination spanner No. 7, AF 10 12 13 14 15 16 17 18 19mm Universal cable knife No. 4528, blade L. 50 mm Wood sectioned folding ruler No. 4533-2. 2 m Hobby saw No.406, blade L. 145 mm Flat chisel No. 95-200, 200x23x13 mm Engineers' hammer No. 600 H-500, 500 g Multiple pliers No. 8133-180 JC, 180 mm 2C handle Power side cutter No. 8316-180 JC, 180 mm 2C handle Universal pliers No. 142 10 TL, 10" ⊖ 3C screwdriver slotted No. 2150, 4 5.5 6.5 mm ⊕ 3C screwdriver cross-slotted No. 2160SK PH 1 2 ⊖ Voltage tester slotted No. 4615 3, 220-250 V, 3mm + GEDORE L-BOXX® 136 No. 1100 L	23	2835983	1100-BASIC	6.1
Starter assortment in 2/2 L-BOXX 136 module	Combination ratchet spanner No. 7 R, AF 10 12 13 14 15 16 17 18 19 mm Universal cable knife No. 4528, blade L. 50 mm Wood sectioned folding ruler No. 4533-2. 2 m Hobby saw No.406, blade L. 145 mm Flat chisel No. 95-200, 200x23x13 mm Engineers' hammer No. 600 H-500, 500 g	14	2835967	1100 CT2-BASIC	2.4

1100-01

MECHANIC TOOL ASSORTMENT

in GEDORE L-BOXX® 136, 58 pieces

- › Suitable for tradesmen
- › Practical assortment for on-site use
- › Check-Tool insert for quick check of completeness
- › GEDORE L-BOXX® 136 with an easy click attaching system



Description	Contents	pieces	Code	No.	
GEDORE L-BOXX 136 with assortment Mechanic, 58 pcs	1/2" reversible ratchet No. 1993 U-20 1/2" extension No. 1990-10, 250 mm 1/2" universal joint No. 1995 1/2" socket No. 19, AF 10 11 12 13 14 15 16 17 18 19 21 22 24 mm Adjustable wrench, open end No. 60 CP 8, 8" Universal pliers No. 142 10 JC, 10" 2C handle Power side cutter No. 8316-160 JC, 160 mm 2C handle Multiple pliers No. 8133-180 JC, 180 mm 2C handle Engineers' hammer No. 600 H-500, 500 g Bricklayer's chisel No. 110-256, 250x16 mm Multi fitting key UNIVERSAL No. 45 S, for control cabinets and locking devices Miniature LED lamp No. TFK 649 Swivel end No. E-649 F for LED lamp No. TFK 649 Cable knife No. 0063-08, blades L. 80 mm Hexagon socket key set No. H 42-10, hex 1.3 1.5 2 2.5 3 4 5 6 8 10 mm Hexagon socket key No. SCL 43 TX-80, T9 T10 T15 T20 T25 T30 T40 ⊕ VDE Screwdriver set No. VDE 2170-2160 PH-077 slotted 2.5 4 5.5, cross-slotted PH 0 1 2 ⊖ Voltage tester slotted No. 4615 3, 220-250 V, 3mm Wood sectioned folding ruler No. 4533-2, 2 m Key file set No. 8728, flat, three-edged, square, half-round, round file ⊖ Voltage tester slotted No. 4615 3, 220-250 V, 3mm + GEDORE L-BOXX® 136 No. 1100 L	58	2658194	1100-01	9.5
Assortment Mechanic, in 2/2 L-BOXX 136 Module, 26 pcs	1/2" reversible ratchet No. 1993 U-20 1/2" extension No. 1990-10, 250 mm 1/2" universal joint No. 1995 1/2" socket No. 19, AF 10 11 12 13 14 15 16 17 18 19 21 22 24 mm Adjustable wrench, open end No. 60 CP 8, 8" Universal pliers No. 142 10 JC, 10" Power side cutter No. 8316-160 JC, 160 mm 2C handle Multiple pliers No. 8133-180 JC, 180 mm 2C handle Engineers' hammer No. 600 H-500, 500 g Bricklayer's chisel No. 110-256, 250x16 mm Multi fitting key UNIVERSAL No. 45 S, for control cabinets and locking devices Miniature LED lamp No. TFK 649 Swivel end No. E-649 F for LED lamp No. TFK 649 Cable knife No. 0063-08, blades L. 80 mm	26	2936828	1100 CT2-01	6.8

1101-7-7 R COMBINATION SPANNER SET in i-BOXX® 72, 15 pieces

- > Often used spanner sizes as practical ratchet wrench
- > In GEDORE i-BOXX® 72 No. 1101 L
- > Compatible with GEDORE i-BOXX® Rack active No. 1101 K



Contents	W	D	H	pieces	Code	No.	kg
Combination ratchet spanner No. 7 R, AF 10 13 17 19 mm	367	316	72	15	2836114	1101-7-7 R	2.900
Combination spanner No. 7, AF 6 8 11 12 14 15 16 18 21 22 24 mm							

1101-19 SOCKET SET 1/2" in i-BOXX® 72, 21 pieces

- > In GEDORE i-BOXX® 72 No. 1101 L
- > Compatible with GEDORE i-BOXX® Rack active No. 1101 K



Contents	W	D	H	pieces	Code	No.	kg
1/2" socket No. 19, AF 8 9 10 11 12 13 14 15 16 17 18 19 21 22 24 27 30 32 mm	367	316	72	21	2836084	1101-19	4.050
1/2" reversible ratchet No. 1993 U-20							
1/2" universal extension No. 1990 KR-5 -10, 125 250 mm							

1101-D 20 SOCKET SET 1/4" in i-BOXX® 72, 58 pieces

- > For universal use with sockets and bits
- > In GEDORE i-BOXX® 72 No. 1101 L
- > Compatible with GEDORE i-BOXX® Rack active No. 1101 K



Contents	W	D	H	pieces	Code	No.	kg
1/4" socket No. 20, AF 4 4.5 5 5.5 6 7 8 mm, 1/4" reversible ratchet 2093 U-20, 1/4" extension No. 2090-2 -4, 55 97 mm, 1/4" universal joint No. 2095, Bit adapter No. 620, 1/4" hex x 1/4" square, 1/4" multi-handle No. 676, Adaptor No. 673 6.3, 1/4" hex x 1/4" square, 1/4" bit holder No. 699, hex, ⊖ 1/4" screwdriver bit slotted No.680, 4 5.5 6.5 8 mm, ⊙ 1/4" screwdriver bit hex No. 685, 3 4 5 6 8 10 mm, ⊙ 1/4" screwdriver bit XZN No. 685 X, M5 M6 M8, ⊖ 1/4" screwdriver bit cross-slotted No.690, PH 1 2 3, ⊕ 1/4" screwdriver bit cross-slotted No. 690, PZ 1 2 3, ⊙ 1/4" screwdriver bit TX No. 687, T6 T7 T8 T9 T10 T15 T20 T25 T27 T30 T40, ⊙ 1/4" screwdriver bit TX with hole No. 688 T10 T15 T20 T25 T27 T30 T40, Inset box No. E-1101 BT, with two partitions	367	316	72	58	2836165	1101-D 20	2.000

1101-142-2150 PLIERS/SCREWDRIVER ASSORTMENT in i-BOXX® 72, 9 pieces

- > In GEDORE i-BOXX® 72 No. 1101 L
- > Compatible with GEDORE i-BOXX® Rack active No. 1101 K



Contents	W	D	H	pieces	Code	No.	
⊖ 3C screwdriver slotted No. 2150, 4 5.5 6.5 mm	367	316	72	9	2836149	1101-142-2150	1.900
⊕ 3C screwdriver cross-slotted No. 2160 PH 1 2							
⊖ Voltage tester slotted No. 4615 3, 220-250 V, 3mm							
Multiple pliers No.8133-180 JC, 180 mm 2C handle							
Power side cutter No. 8316-160 JC, 160 mm 2C handle							
Universal pliers No. 142 10TL, 10"							

1100 W-001 TOOL BOARD WITH PLIERS/SCREWDRIVER ASSORTMENT 9 pieces

- > Fitted-out lid tool board for re-equipping L-BOXX®s
- > A non-equipped lid tool board can be ordered under No. ET-1100 W
- > **Empty tool board for re-equipping on Page 46**



Contents	W	H	pieces	Code	No.	
Multiple pliers No. 8133-180 JC, 180 mm 2C handle	37.5	31	9	2836181	1100 W-001	1.795
Power side cutter No. 8316-180 JC, 180 mm 2C handle						
Universal pliers No. 142 10TL, 10"						
⊖ 3C screwdriver slotted No. 2150, 4 5.5 6.5 mm						
⊕ 3C screwdriver cross-slotted No. 2160 PH 1 2						
⊖ Voltage tester slotted No. 4615, 3 mm						
+ tool board No. ET-1100 W						
Multiple pliers No. 8133-180 JC, 180 mm 2C handle			9	2836211	S 1100 W-001	1.100
Power side cutter No. 8316-180 JC, 180 mm 2C handle						
Universal pliers No. 142 10TL, 10"						
⊖ 3C screwdriver slotted No. 2150, 4 5.5 6.5 mm						
⊕ 3C screwdriver cross-slotted No. 2160 PH 1 2						
⊖ Voltage tester slotted No. 4615, 3 mm						

1100 W-002 VDE TOOL BOARD WITH VDE PLIERS/SCREWDRIVER ASSORTMENT

9 pieces

- › Fitted-out lid tool board for re-equipping L-BOXX®s
- › A non-equipped lid tool board can be ordered under No. ET-1100 W
- › Empty tool board for re-equipping on Page 46



1100 W-002 VDE



Contents	W	H	pieces	Code	No.	kg
VDE Side cutter No. VDE 8314-160 H, 160 mm	37.5	31	9	2836203	1100 W-002 VDE	1.520
VDE Bent nose telephone pliers No. VDE 8132-160 H, 160 mm						
⊖ VDE Screwdriver slotted No. VDE 2170, 2.5 3.5 5.5 mm						
⊕ VDE Screwdriver cross-slotted No. VDE 2160 PH 1 2						
⊕ VDE Screwdriver cross-slotted No. VDE 2160 PZ 1 2						
+ tool board No. ET-1100						
VDE Side cutter No. VDE 8314-160 H, 160 mm			9	2836238	S 1100 W-002 VDE	0.800
VDE Bent nose telephone pliers No. VDE 8132-160 H, 160 mm						
⊖ VDE Screwdriver slotted No. VDE 2170, 2.5 3.5 5.5 mm						
⊕ VDE Screwdriver cross-slotted No. VDE 2160 PH 1 2						
⊕ VDE Screwdriver cross-slotted No. VDE 2160 PZ 1 2						

1101-001 SET OF CIRCLIP PLIERS

in i-BOXX® 72, 8 pieces

- › For internal and external circlip rings
- › Straight and 90° angled tips
- › Transparent cover for a quick overview
- › In GEDORE i-BOXX® 72 No. 1101 L
- › Compatible with GEDORE i-BOXX® Rack active No. 1101 K

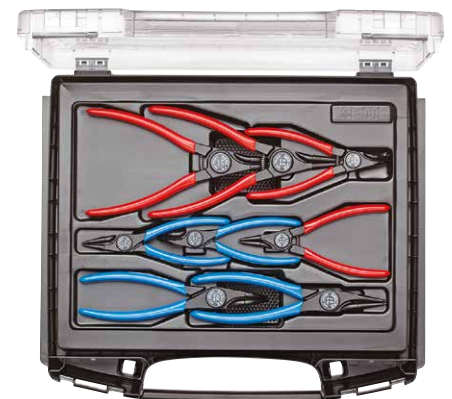

Contents	W	D	H	pieces	Code	No.	kg
Circlip pliers for external retaining rings No. A, straight and angled at 90°	367	316	72	8	1692275	1101-001	1.550
Circlip pliers for internal retaining rings No. J, straight and angled at 90°							

1101-004 SET OF CIRCLIP PLIERS in i-BOXX® 72, 8 pieces

- > Particularly suitable for barely accessible places
- > Circlip pliers with straight and 45° angled tips
- > For installation and removal of internal and external retaining rings up to a 60 mm size
- > Transparent cover for a quick overview
- > In GEDORE i-BOXX® 72 No. 1101 L
- > Compatible with GEDORE i-BOXX® Rack active No. 1101 K

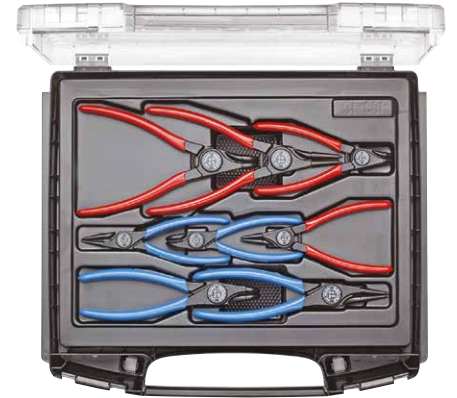

Contents	W	D	H	pieces	Code	No.	
Circlip pliers for external retaining rings No. A, straight and angled at 45°	367	316	72	8	2148706	1101-004	1.550
Circlip pliers for internal retaining rings No. J, straight and angled at 45°							

1102-001 SET OF CIRCLIP PLIERS in L-BOXX® Mini, 4 pieces

- > For internal and external circlip rings
- > Straight and 90° angled tips
- > Divider set included
- > Ideal for keeping small parts

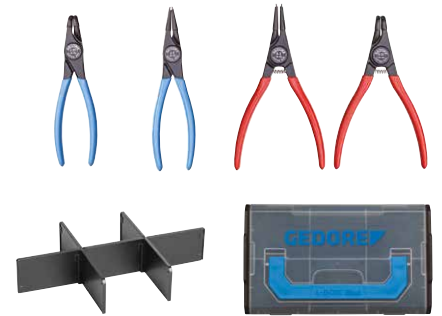

Contents	W	D	H	pieces	Code	No.	
Circlip pliers for external retaining rings No. A, straight and angled at 90°	260	155	63	4	1692283	1102-001	1.029
Circlip pliers for internal retaining rings No. J, straight and angled at 90°							

1101-002 PLIERS SET in i-BOXX® 72, 6 pieces

- > Practical set composition in sturdy plastic case

Stripping pliers no. 8098-160 JC

- > Self-opening, spring and locking screw for wires 0.8 - 6.0 mm²

Power combination pliers no. 8250-180 JC

- > For toughest-possible continuous use. Considerable leverage for easy cutting

Power side cutter no. 8316-180 JC

- > Good lever action for easy cutting, induction-hardened precision blades, hardness 63 - 65 HRC

Needle nose pliers no. 8132-160 JC

- > Needle nose, long jaws, straight gripping faces, serrated for holding, gripping, bending and cutting

Needle nose pliers no. 8120-160 JC

- > Long jaws, serrated gripping faces, for holding and bending work

Round nose pliers no. 8122-160 JC

- > Long jaws, serrated gripping faces for bending work

- > In GEDORE i-BOXX® 72 no. 1101 L

- > Compatible with GEDORE i-BOXX® Rack active no. 1101 K



Contents	W	D	H	pieces	Code	No.	
Stripping pliers no. 8098-160 JC, 160 mm 2C handle, Flat nose pliers no. 8120-160 JC, 160 mm 2C handle, Round nose pliers no. 8122-160 JC, 160 mm 2C handle, Bent nose pliers no. 8132-160 JC, 160 mm 2C handle, Power combination pliers no. 8250-180 JC, 180 mm 2C handle, Power side cutter no. 8316-180 JC, 180 mm 2C handle	367	316	72	6	1708155	1101-002	1.740

1102-003

PLIERS SET

in L-BOXX® Mini, 3 pieces

> Practical set composition in sturdy plastic case

Bent nose telephone pliers No. 8132-160 JC

> Long, flat-round jaws, straight gripping faces, serrated for holding, gripping, bending and cutting

Power combination pliers No. 8250-180 JC

> Considerable leverage for firm gripping and cutting
> For flat and round material

Power side cutter No. 8316-160 JC

> Good lever action for easy cutting



Contents	W	D	H	pieces	Code	No.	kg
Bent nose telephone pliers No. 8132-160 JC, 160 mm 2C handle	260	155	63	3	1692305	1102-003	1.010
Power combination pliers No. 8250-180 JC, 180 mm 2C handle							
Power side cutter No. 8316-180 JC, 180 mm 2C handle							

1102-007

PLIERS SET

in L-BOXX® Mini, 3 pieces

> Practical set composition in sturdy plastic case

Bent nose telephone pliers No. 8132-200 JC

> Long, flat-round jaws, straight gripping faces, serrated
> For holding, gripping, bending and cutting

Power side cutter No. 8314-180 JC

> Slim head - ideal for confined spaces

Universal pliers No. 142 10 TL

> Offset gripping faces for self-gripping of nuts and pipes



Contents	W	D	H	pieces	Code	No.	kg
Bent nose telephone pliers No. 8132-200 JC, 200 mm 2C handle	260	155	63	3	2951789	1102-007	1.195
Power side cutter No. 8314-180 JC, 180 mm 2C handle							
Universal pliers No. 142 10 TL, 10"							

1102-008

PLIERS SET

in L-BOXX® Mini, 3 pieces

> Practical set composition in sturdy plastic case

Universal pliers 142 7 TL

> Offset gripping faces for self-gripping of nuts and pipes

Power side cutter 8316-160 JC

> Good lever action for easy cutting

Multiple pliers 8133-200 JC

> Multifunctional pliers for the mechanical and electronic use

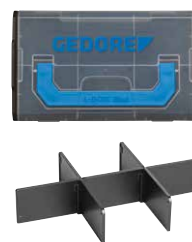

Contents	W	D	H	pieces	Code	No.	kg
Power side cutter No. 8316-160 JC, 160 mm 2C handle	260	155	63	3	2951797	1102-008	0.980
Multiple pliers no. 8133-200 JC, 200 mm 2C handle							
Universal pliers no. 142 7 TL							

1100-02

TOOL CASE ELECTRICIAN

in GEDORE L-BOXX® 136, 36 pieces

- > Particularly suitable for electricians
- > Practical assortment for on-site use
- > Check-Tool insert for quick check of completeness
- > GEDORE L-BOXX® 136 with an easy click attaching system



Description	Contents	W	D	H	pieces	Code	No.	
GEDORE L-BOXX 136 with assortment Electrician 36 pcs	Bricklayer's chisel No. 110-256, 250x16 mm Electricians' chisel No. 112-2510, square 250x10x7 mm Engineers' hammer No. 600 H-500, 500 g Adjustable wrench, open end No. 60 CP 8, 8" Universal pliers No. 142 10 JC, 10" Stripping pliers No. 8097, Automatic Multiple pliers No. 8133-180 JC, 180 mm 2C handle VDE Side cutter No. VDE 8314-160 H, 160 mm VDE Bent nose pliers No. VDE 8132-200 H, 200 mm VDE Bent nose pliers No. VDE 8132 AB-200 H, angled 200 mm VDE Stripping pliers No. VDE 8098-160 H, 160 mm VDE Cable shears No. VDE 8094, 200 mm Universal cable knife No. 4528, blade L. 50 mm Insulating tape No. 4629, tape L. 10 m Scraper No. 0175-06, blade W. 60 mm Hexagon socket key No. H 42-10, hex 1.3 1.5 2 2.5 3 4 5 6 8 10 mm ⊕ ⊖ VDE Screwdriver set No. VDE 2170-2160 PH-077, slotted 2.5 4 5.5 6.5 mm, cross-slotted PH 0 1 2 ⊖ Voltage tester slotted No. 4615 3, 220-250 V, 3mm ⊖ Voltage tester slotted No. VDE 4616, 12-1000 V, 3 mm Multi-fitting key ELECTRO No. 45 E Wood sectioned folding ruler No. 4533-2. 2 m + GEDORE L-BOXX® 136 No. 1100 L	442	357	151	36	2658208	1100-02	7.7
Assortment Electrician, in 2/2 L-BOXX 136 Module, 15 pcs	Bricklayer's chisel No. 110-256, 250x16 mm Electricians' chisel No. 112-2510, square 250x10x7 mm Engineers' hammer No. 600 H-500, 500 g Adjustable wrench, open end No. 60 CP 8, 8" Universal pliers No. 142 10 JC, 10" Stripping pliers No. 8097, Automatic Multiple pliers No. 8133-180 JC, 180 mm VDE Side cutter No. VDE 8314-160 H, 160 mm VDE Bent nose pliers No. VDE 8132-200 H, 200 mm VDE Bent nose pliers No. VDE 8132 AB-200 H, angled 200 mm VDE Stripping pliers No. VDE 8098-160 H, 160 mm VDE Cable shears No. VDE 8094, 200 mm Universal cable knife No. 4528, blade L. 50 mm Insulating tape No. 4629, tape L. 10 m Scraper No. 0175-06, blade W. 60 mm	442	357	151	15	2936836	1100 CT-02	3.9

1101-003 VDE VDE TOOL SET in i-BOXX® 72, 8 pieces

- > VDE basic assortment
- > In GEDORE i-BOXX® 72 No. 1101 L
- > Compatible with GEDORE i-BOXX® Rack active No. 1101 K



Contents	W	D	H	pieces	Code	No.	kg
VDE Bent nose pliers No. VDE 8132-200 JC, 200 mm 2C handle	367	316	72	8	1828045	1101-003 VDE	2.300
VDE Power combination pliers No. VDE 8250-180 H, 180 mm, 2C handle							
VDE Power side cutter No. VDE 8314-160 H, 160 mm							
⊖ VDE Screwdriver slotted No. VDE 2170, 4 5,5 mm							
⊕ VDE Screwdriver cross-slotted No. VDE 2160 PH 1 2							
⊖ Voltage tester slotted No. VDE 4615, 12-1000 V, 3 mm							

1100-1094 VDE TOOL ASSORTMENT HYBRID in GEDORE L-BOXX® 136, 53 pieces

- > The perfect range of tools for repairs and maintenance of hybrid and electric vehicles
- > For vehicles of all the manufacturers
- > All tools insulated on the basis of EN 60900/EC 60900
- > GEDORE L-BOXX® 136 with easy click attaching system compatible with the Sortimo® vehicle interior fittings in your service mobile



Contents	W	D	H	pieces	Code	No.	kg
3/8" VDE Socket No. VDE 30, SW 6 8 9 10 11 12 13 14 15 16 17 18 19 20 22 mm	442	357	151	53	2979063	1100-1094	8.3
3/8" VDE Screwdriver bit socket No. VDE INX 30, AF 8 10 12 mm							
3/8" VDE Extension No. VDE 3090 -3 -6, 75 150 mm							
3/8" VDE Reversible ratchet No. VDE 3093 U							
⊖ VDE Screwdriver slotted No. VDE 2170, 2.5 3.5 4 5.5 mm							
⊕ VDE Screwdriver cross-slotted No. VDE 2160 PH 1 2 3							
⊕ VDE Screwdriver TX No. VDE 2163 TX T20 T25 T30							
VDE Cable shears No. VDE 8094, 200 mm							
VDE Universal pliers No. VDE 146 10, 10"							
VDE Power combination pliers No. VDE 8250-200 H, 200 mm, 2C handle							
VDE Power side cutter No. VDE 8314-180 H, 180 mm							
VDE Bent nose pliers No. VDE 8132 AB-200 JC, 200 mm angled 2C handle							
VDE Flat nose pliers No. VDE 8120-160 H, 160 mm, 2C handle							
VDE Cable knife No. VDE 4522, 180 mm							
Meter connection fitting No. V 914, Size 1 2 3							

1102-002 VDE VDE PLIERS SET in L-BOXX® Mini, 3 pieces

- Practical set composition in sturdy plastic cases
- Handles with VDE insulating sleeves up to 1000 V, acc. to EN 60900/IEC 60900

VDE Bent nose pliers No. VDE 8132-160 H

- Long, flat-round jaws, straight gripping faces, serrated

VDE Power combination pliers No. VDE 8250-180 H

- For heavy continuous use

VDE Side cutter No. VDE 8314-160 H

- Slim head - ideal for confined spaces



Contents	W	D	H	pieces	Code	No.	
VDE Bent nose telephone pliers No. VDE 8132-160 JC, 160 mm, VDE Power combination pliers No. VDE 8250-180 H, 180 mm, VDE Power side cutter No. VDE 8314-160 H, 160 mm	260	155	63	3	1692291	1102-002 VDE	0.998

1102-004 VDE VDE PLIERS SET in L-BOXX® Mini, 3 pieces

- Practical set composition in sturdy plastic cases
- Handles with VDE insulating sleeves up to 1000 V, acc. to EN 60900/IEC 60900

VDE Stripping pliers No. VDE 8098-160 H

- Brass adjusting screw for cutting depth adjustment, opening stop for wires 0.8 - 6.0 mm²

VDE Power combination pliers No. VDE 8250-180 H

- To cut all wire types including piano wire, 1.6 mm

VDE Side cutter No. VDE 8314-160 H

- Slim head - ideal for confined spaces



Contents	W	D	H	pieces	Code	No.	
VDE Stripping pliers No. VDE 8098-160 H, 160 mm, VDE Power combination pliers No. VDE 8250-180 H, 180 mm, VDE Power side cutter No. VDE 8314-160 H, 160 mm	260	155	63	3	1708244	1102-004 VDE	1.026

1102-005 VDE VDE PLIERS SET in L-BOXX® Mini, 3 pieces

- Slim PZ screwdriver, VDE multiple pliers and VDE power side cutter
- Handles with VDE insulating sleeves up to 1000 V, to EN 60900/JEC 60900

VDE 2162 PZ VDE screwdriver SLIM DRIVE

- Ultra-small blade diameter yet with full mechanical and electrical safety

VDE 8131 AB VDE multiple pliers

- Cable cutter: for easy cutting of cables up to 5x2.5 mm² or Ø 12 mm
- Stripping blades: Stripping possibility for wires 1.5 mm² and 2.5 mm²
- Crimp profile: Crimping of conductor end-sleeves

VDE 8314 VDE side cutters

- Slim head - ideal for confined spaces

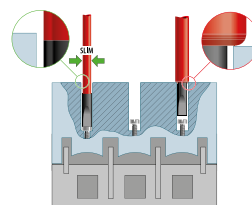

Contents	W	D	H	pieces	Code	No.	
VDE Power side cutter no. VDE 8314-180 H, 180 mm, VDE Multiple pliers no. VDE 8131 AB-200 JC, 200 mm angled, VDE Screws cross-slotted no. VDE 2162 PZ 1, SLIM	260	157	63	3	2951762	1102-005 VDE	0.955

1102-006 VDE VDE TOOL SET in L-BOXX® Mini, 4 pieces

- › For all usual electric master cabinets incl. multi fitting key
- › In GEDORE L-BOXX® Mini, incl. divider set
- › Handles with VDE insulation up to 1000 V, acc. to EN 60900/IEC 60900, insulating sleeves

VDE Multiple pliers No. VDE 8131 AB-200 H

- › Cable cutter: enables easy cutting of cables up to 5x2.5 mm² and Ø 12 mm
- › Stripping blades: stripping option for wires of 1.5 mm² and 2.5 mm²
- › Crimp profile: crimping of conductor end-sleeves

VDE Screwdriver SLIM DRIVE No. VDE 2172 3.5

- › Ultra-small blade diameter yet with full mechanical and electrical safety
- › No problems in reaching screws deeply embedded in screw shafts

VDE Screwdriver SLIM DRIVE PlusMinus No. VDE 2164 SL/PH 2

- › Positive-fit joint of handle and blade for optimum transmission of force
- › Ultra-small blade diameter yet with full mechanical and electrical safety
- › No problems in reaching screws deeply embedded in screw shafts

Multi fitting key ELECTRO No. 45 E

- › For all current electric master cabinets
- › Magnetic bit adaptor 1/4", supplied with one bit PH 2
- › Screwdriver function with retaining clip



Contents	W	D	H	pieces	Code	No.	kg
VDE Multiple pliers No. VDE 8131 AB-200 H, angled 200 mm	260	155	63	4	2951770	1102-006 VDE	0.860
⊖ VDE Screwdriver slotted No. VDE 2172, 3.5 mm SLIM							
⊕⊖ VDE Screwdriver cross-slotted No. VDE 2164 SL/PH 2 SLIM							
Multi-fitting key ELECTRO No. 45 E							

1100-03 INSTALLATION TOOL ASSORTMENT in GEDORE L-BOXX® 136, 44 pieces

- › Particularly suitable for professions in the sanitary, heating and air conditioning fields
- › Practical assortment for on-site use
- › Check-Tool insert for quick check of completeness
- › Two stacked Check-Tool inserts



Description	Contents	W	D	H	pieces	Code	No.	
GEDORE L-BOXX 136 with assortment Installation 44 pcs	Combination ratchet spanner No. 7 R, AF 10 13 17 19 24 mm Highly efficient, three-position pipe wrench ECK-SCHWEDE-snap 1.1/2" 100 1.1/2, 1.1/2" Universal pliers No. 142 10 TL, 10" Plumbing wrench No. 322000, 260 mm Pipe deburring reamer No. 232001, Ø 4-32 mm Pipe cutter No. 225011, niro Ø 6-35 mm Miniature pipe cutter MINI-QUICK No. 231000, Ø 4-16 mm Radiator valve spanner set No. 381000 with extension 1/2" No. 1990-5 Combination stepped key No. 380100, with 5 steps 3/8"-1" Engineers' hammer ROTBAND-PLUS No. 600 H-500 with hickory handle, 500 g Bricklayer's chisel No. 110-256, 250x16 mm Hexagon socket key No. SCL 43 TX-80, T9 T10 T15 T20 T25 T30 T40 ⊖ Voltage tester slotted No. VDE 4615, 12-1000 V, 3 mm Profi-key UNIVERSAL No. universal 45 P, for air-conditioning and locking devices Hexagon socket key No. H 42-10, hex 1.3 1.5 2 2.5 3 4 5 6 8 10 mm Basin wrench No. 316500, 260 mm Wood sectioned folding ruler No. 4533-2. 2 m ⊕ VDE Screwdriver set No. VDE 2170-2160 PH-077, slotted 2.5 4 5.5 6.5 mm, cross-slotted PH 0 1 2	442	357	151	44	2658216	1100-03	10.3

1100 CT2-03 INSTALLATION TOOL ASSORTMENT in 2/2 L-BOXX 136 module

- > Tool set in Check-tool modules (CT)
- > Optical completeness thanks to 2-colour foam inserts
- > Slip-free, grip recesses
- > Resistant to oil and grease
- > For equipping an existing L-BOXX® 136



1100 CT2-03-100 B



1100 CT2-03-600 D

Description	Contents	W	D	H	pieces	Code	No.	
Assortment Installation, in 2/2 L-BOXX 136 module, 13 pcs	Combination ratchet spanner No. 7 R, AF 10 13 17 19 24 mm Highly efficient, three-position pipe wrench ECK-SCHWEDE-snap 1.1/2" 100 1.1/2, 1.1/2" Universal pliers No. 142 10 TL, 10" Plumbing wrench No. 322000, 260 mm Pipe deburring reamer No. 232001, Ø 4-32 mm Pipe cutter No. 225011, niro Ø 6-35 mm Miniature pipe cutter MINI-QUICK No. 231000, Ø 4-16 mm Radiator valve spanner set No. 381000 with extension 1/2" No. 1990-5 Combination stepped key No. 380100, with 5 steps 3/8"-1"	442	357	151	13	2940590	1100 CT2-03-100 B	4.4
Assortment Installation, in 2/2 L-BOXX 136 module, 23 pcs	Engineers' hammer ROTBAND-PLUS No. 600 H-500 with hickory handle, 500 g Bricklayer's chisel No. 110-256, 250x16 mm Hexagon socket key No. SCL 43 TX-80, T9 T10 T15 T20 T25 T30 T40 ⊖ Voltage tester slotted No. VDE 4615, 12-1000 V, 3 mm Profi-key UNIVERSAL No. universal 45 P, for air-conditioning and locking devices Hexagon socket key No. 42, hex AF 1.3 1.5 2 2.5 3 4 5 6 8 10 mm Basin wrench No. 316500, 260 mm	442	357	151	23	2940604	1100 CT2-03-600 D	2.6

1101-2333

TOOL SET

in i-BOXX® 72

- › For flaring copper and light-alloy pipes of various hardnesses
- › Flange cone 90° hardened = 45° angled from pipe
- › For cooling systems and refrigeration technique
- › Complete set for metric and metric/inch pipes
- › In GEDORE i-BOXX® 72 No. 1101 L
- › Compatible with GEDORE i-BOXX® Rack active No. 1101 K



Model	Contents	W	D	H	Code	No.	kg
Metric sizes	for metric pipes 4, 4.75, 6, 8, 10, 12, 14 mm 1 flaring tool No. 233000 1 clamping jaw 4-14 mm No. 233101 1 cone 180° No. 233200 1 pipe cutter 3-35 mm Ø No. 2250 3 1 GEDORE i-BOXX® 72 No. 1101 L	367	316	72	4555550	1101-233301	2.9

1101-2340

DOUBLE FLARING TOOL SET

in i-BOXX® 72

- › For standard-compliant (DIN 74234) double flaring tools
- › For brake lines, coolant lines, hydraulic and pneumatic pipes with a wall thickness of 0.7 to 1.0 mm
- › Clamping jaws made from steel, smooth inside, phosphated
- › Complete set for metric and metric/inch pipes
- › In GEDORE i-BOXX® 72 No. 1101 L
- › Compatible with GEDORE i-BOXX® Rack active No. 1101 K



Model	Contents	W	D	H	Code	No.	kg
Metric sizes	for metric pipes 1 basic frame No. 234000 1 clamping jaw metric No. 234101 6 cones 4,75-10 mm No. 234204-234210 2 cones No. 234790 + 234801 1 miniature pipe cutter 4-16 mm Ø No. 231000 1 pipe deburring reamer Ø 4-32 mm No. 232001 1 GEDORE i-BOXX® 72 No. 1101 L	367	316	72	4505530	1101-234001	3.0
Metric and imperial sizes	for metric + inch pipes 1 basic frame No. 234000 2 clamping jaws No. 234101 + 234102 6 cones 4,75-10 mm No. 234204-234210 4 cones 3/16-3/8" No. 234303-234306 3 cones No. 234790 + 234801-802 1 miniature pipe cutter 4-16 mm Ø No. 231000 1 pipe deburring reamer Ø 4-32 mm No. 232001 1 GEDORE i-BOXX® 72 No. 1101 L	367	316	72	4662980	1101-234013	4.2

1100-2431

MANUAL BENDING TOOL SET

in GEDORE L-BOXX® 136, 9 pieces

- > Sizes from 6 to 15 mm Ø, up to 180°
- > Easy bending with reversible ratchet 1/2" in long version
- > For soft copper pipes EN 1057 (also with fixed coating), thin-walled precision steel pipes as well as pipes in non-ferrous metals
- > For clamping in a vice or useable as bending pliers
- > 7 bending formers for pipes with Ø 10, 12, 14, 15, 18, 20 and 22 mm and corresponding counter-supports
- > GEDORE L-BOXX® 136 with an easy click attaching system



Contents	W	D	H	pieces	Code	No.	
1 bending lever No. 243010	442	357	151	9	4568450	1100-243100	7.4
1 tool holding fixture No. 243070							
1 reversible ratchet 1/2" No. 1993 U-10 L							
5 pipe bending formers Ø 6, 8, 10, 12, 15 mm							
1 pipe cutter 3-35 mm Ø No. 2250 3							
+ GEDORE L-BOXX® 136 No. 1100 L							

1100-2456

BENDING TOOL SET

hydraulic, in GEDORE L-BOXX® 136, 12 pieces

- > Sizes from 10 to 22 mm Ø, up to 90°
- > For soft copper pipes EN 1057 up to 22 mm (also heat-insulated), composite pipes up to 20 mm as well as precision steel pipes EN 10305-3 (DIN 2394) up to 18 x 1.5 mm
- > 7 bending formers for pipes with Ø 10, 12, 14, 15, 18, 20 and 22 mm and corresponding counter-supports
- > Hydraulic drive without great effort
- > With pipe cutter No. 2250 3
- > GEDORE L-BOXX® 136 with an easy click attaching system



Contents	W	D	H	pieces	Code	No.	
1 basic unit, hydraulic No. 245670	442	357	151	12	2963531	1100-245680	6.9
7 aluminium bending formers for pipes of Ø 10, 12, 14, 15, 18, 20, 22 mm							
3 counter-supports Ø 6-12, 14-17, 18-22 mm							
1 pipe cutter 3-35 mm Ø No. 2250 3							
+ GEDORE L-BOXX® 136 No. 1100 L							

1100-2456

BENDING TOOL SET

hydraulic, heavy-duty, in GEDORE L-BOXX® 136

- > Sizes from 6 to 22 mm Ø, up to 90°
- > For soft copper pipes EN 1057 up to 22 mm (also heat-insulated), composite pipes up to 20 mm, precision steel pipes EN 10305-3 (DIN 2394) up to 18 x 2 mm, as well as annealed stainless steel pipes up to 18 x 1.2 mm
- > 10 bending formers for pipes with Ø 6, 8, 10, 12, 14, 15, 16, 18, 20 and 22 mm and corresponding counter-supports
- > Hydraulic drive without great effort
- > With pipe cutter No. 2180 3
- > GEDORE L-BOXX® 136 with an easy click attaching system



Contents	W	D	H	pieces	Code	No.	kg
1 basic unit, hydraulic No. 245670	442	357	151	15	2963558	1100-245681	9.6
10 aluminium bending formers for pipes of Ø 6, 8, 10, 12, 14, 15, 16, 18, 20, 22 mm							
1 counter-support Ø 6-12 mm							
2 counter-supports reinforced Ø 14-17, 18-22 mm							
1 pipe cutter 3-35 mm Ø No. 2180 3							
+ GEDORE L-BOXX® 136 No. 1100 L							

1101-2785

MANUAL BENDING TOOL SET

in i-BOXX® 72, 9 pieces

- > Sizes from 3 to 10 mm up to 180°
- > For precision steel pipes EN 10305-3 (DIN 2394), hydraulic pipes EN 10305-1 (DIN 2391), and bendable stainless steel pipes with 0.75 - 1.0 mm wall thicknesses
- > 5 aluminium bending formers for pipes with Ø 3-4, 5, 6, 8 and 10 mm
- > For clamping in a vice or useable as bending pliers
- > With pipe cutter No. 231011 and pipe deburring reamer No. 232501
- > In GEDORE i-BOXX® 72 No. 1101 L
- > Compatible with GEDORE i-BOXX® Rack active No. 1101 K



Contents	W	D	H	pieces	Code	No.	kg
1 basic frame 3-10 mm No. 278570	367	316	72	9	1589849	1101-278501	2.4
1 bending lever 3-10 mm No. 278581							
5 aluminium bending formers for pipes with Ø 3-4, 5, 6, 8, 10 mm							
1 miniature pipe cutter 4-16 mm Ø No. 231011							
1 pipe deburring reamer 8-35 mm Ø No. 232501							
+ GEDORE i-BOXX® 72 No. 1101 L							

1100-2786

MANUAL BENDING TOOL SET

in GEDORE L-BOXX® 136, 12 pieces

- > Sizes from 6 to 18 mm up to 180°
- > For precision steel pipes EN 10305-3 (DIN 2394), hydraulic pipes EN 10305-1 (DIN 2391) with 1.0 - 2.0 mm wall thicknesses, composite pipes up to 16 mm as well as bendable stainless steel pipes with 1.0 - 1.5 mm wall thicknesses
- > 8 bending formers for pipes with Ø 6, 8, 10, 12, 14, 15, 16, 18 mm
- > For clamping in a vice or in stationary use in combination with tripod No. 268500
- > With pipe cutter No. 2180 3
- > GEDORE L-BOXX® 136 with an easy click attaching system



Contents	W	D	H	pieces	Code	No.	
1 basic frame 6-18 mm No. 278670	442	357	151	12	1611526	1100-278601	8.3
1 bending lever 6-18 mm attachable No. 278680							
8 aluminium bending formers for pipes with Ø 6, 8, 10, 12, 14, 15, 16, 18 mm							
1 pipe cutter 3-35 mm Ø No. 2180 3							
1 pin punch 3 mm							
+ GEDORE L-BOXX® 136 No. 1100 L							

1100-2788

MANUAL BENDING TOOL SET

in GEDORE L-BOXX® 136, 16 pieces

- > Sizes from 3 to 18 mm up to 180°
- > For precision steel pipes EN 10305-3 (DIN 2394), hydraulic pipes EN 10305-1 (DIN 2391) with 0.75 - 2.0 mm wall thicknesses, composite pipes up to 16 mm as well as bendable stainless steel pipes with 1.0 - 1.5 mm wall thicknesses
- > 10 aluminium bending formers for pipes with Ø 3-4, 5, 6, 8, 10, 12, 14, 15, 16 and 18 mm
- > For clamping in a vice
- > Can be used as bending pliers up to size 10 mm
- > As from sizes 12 mm also for stationary use with tripod No. 268500
- > With pipe cutter No. 2180 3
- > GEDORE L-BOXX® 136 with an easy click attaching system



Contents	W	D	H	pieces	Code	No.	
1 basic frame 3-10 mm No. 278570	442	357	151	16	2963515	1100-278801	8.7
1 bending lever 3-10 mm No. 278581							
1 basic frame 6-18 mm No. 278670							
1 bending lever 6-18 mm attachable No. 278680							
10 aluminium bending formers for pipes with Ø 3-4, 5, 6, 8, 10, 12, 14, 15, 16, 18 mm							
1 pipe cutter 3-35 mm Ø No. 2180 3							
1 pin punch 3 mm							
+ GEDORE L-BOXX® 136 No. 1100 L							

1101-5705 SET OF ARC PUNCHES

in i-BOXX® 72, 18 pieces

- > To DIN 7200 Form A
- > For stamping out cardboard, leather, rubber, sealing materials and other soft materials
- > In GEDORE i-BOXX® 72 No. 1101 L
- > Compatible with GEDORE i-BOXX® Rack active No. 1101 K



Contents	W	D	H	pieces	Code	No.	
Hole diameter 2, 3, 4, 5, 6, 7, 8, 9, 10, 11, 12, 13, 14, 15, 16, 18, 20, 22 mm + GEDORE i-BOXX® 72 No. 1101 L	367	316	72	18	2963469	1101-570500	3.830

1100-1.04 UNIVERSAL PULLER SET

in GEDORE L-BOXX® 136, 13 pieces

- > 12 different pullers can be combined
- > External Ø up to 130 mm, internal Ø up to 170 mm with a 200 mm clamping reach
- > Two and three-arm cross-beam
- > All-steel slim hooks and extensions
- > Extra-slim pulling legs for cramped spaces are attached for self-mounting
- > GEDORE L-BOXX® 136 with an easy click attaching system



Description	Contents	W	D	H	pieces	Code	No.	
Internal extractor assortment in L-BOXX 136	Universal puller HIGH POWER No. 1.04/HP1A-B, 2-arm, 130x100 mm Cross-beam No. 107/1A03, 3-arm 180 mm Pulling leg No. 106/A-100-B, all-steel, leg brake 3x extension No. 106/A-100-VB with leg brake 100 mm 3x pulling leg No. 106/A-100-S, slim 100 mm 3x pulling leg No. 106/S101-S, without clamping part Spindle No. 1.1406200, 17 M14x1,5 200 mm + GEDORE L-BOXX® 136 No. 1100 L	442	357	151	13	2838362	1100-1.04	6.3
Universal puller set, in 2/2 L-BOXX 136 Module	Universal puller HIGH POWER No. 1.04/HP1A-B, 2-arm, 130x100 mm Cross-beam No. 107/1A03, 3-arm 180 mm Pulling leg No. 106/A-100-B, all-steel, leg brake 3x extension No. 106/A-100-VB with leg brake 100 mm 3x pulling leg No. 106/A-100-S, slim 100 mm 3x pulling leg No. 106/S101-S, without clamping part Spindle No. 1.1406200, 17 M14x1,5 200 mm	442	357	151	13	2836068	1100 CT2-1.04	4.1

1100-1.04/12A PULLER SET INTERNAL/EXTERNAL

Suppliable in GEDORE L-BOXX® 136

- > For clamping depths up to Ø 200 mm external, Ø 70-260 mm internal, and clamping reach up to 300 mm
- > Quick-release pulling legs with integral T-profile for a better transmission of force
- > The forged leg feet are very slim particularly suitable for barely accessible places
- > In 3 of 4 spindles the spindle tip (ball/tip) can be rotated
- > Max. capacity 3 and 5 t
- > GEDORE L-BOXX® 136 with an easy click attaching system



Description	Contents	W	D	H	pieces	Code	No.	
Puller set internal/external, in L-BOXX 136	Universal puller No. 1x 1.04/1A, 2-arm 130x100 mm Universal puller No. 1.04/2A 2-arm 200x150 mm Extension with leg brake No. 106/A-100-VB, 100 mm Extension with leg brake No. 106/B-150-VB, 150 mm Spindle No. 1.1406200 SW 17 M14x1.5 200 mm Spindle No. 1.2106350KS, 22, G 1/2", 350 mm, with ball tip + GEDORE L-BOXX® 136 No. 1100 L	442	357	151	7	2927241	1100-1.04/12A	9.6
Puller set internal/external, in 2/2 L-BOXX 136 module	Universal puller No. 1x 1.04/1A, 2-arm 130x100 mm Universal puller No. 1.04/2A 2-arm 200x150 mm Extension with leg brake No. 106/A-100-VB, 100 mm Extension with leg brake No. 106/B-150-VB, 150 mm Spindle No. 1.1406200 SW 17 M14x1.5 200 mm Spindle No. 1.2106350KS, 22, G 1/2", 350 mm, with ball tip	442	357	151	6	2927268	1100 CT-1.04/12A	7.4

1100-1.30 INTERNAL EXTRACTOR SET

in GEDORE L-BOXX® 136, 7 pieces

- > Sliding hammer 1.7 kg and counter-support brace
- > GEDORE L-BOXX® 136 with an easy click attaching system

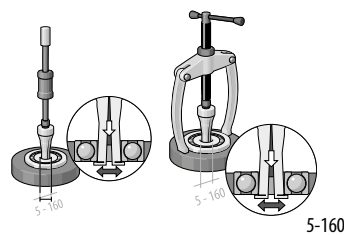



Description	Contents	W	D	H	pieces	Code	No.	
Internal extractor assortment in L-BOXX 136	Internal extractor No. 1.30/2, 12-15 mm Internal extractor No. 1.30/3, 15-19 mm Internal extractor No. 1.30/4, 19-25 mm Internal extractor No. 1.30/4A, 25-30 mm Internal extractor No. 1.30/45, 30-35 mm Counter-brace No. 1.36/1 for 1.30/0 - 1.30/5 Sliding hammer No. 1.35/2, 500 mm, 1,7 kg + GEDORE L-BOXX® 136 No. 1100 L	442	357	151	8	2836041	1100-1.30	7.2
Internal extractor assortment in 2/2 L-BOXX 136 module	Internal extractor No. 1.30/2, 12-15 mm Internal extractor No. 1.30/3, 15-19 mm Internal extractor No. 1.30/4, 19-25 mm Internal extractor No. 1.30/4A, 25-30 mm Internal extractor No. 1.30/45, 30-35 mm Counter-brace No. 1.36/1 for 1.30/0 - 1.30/5 Sliding hammer No. 1.35/2, 500 mm, 1,7 kg	442	357	151	7	2836025	1100 CT-1.30	5.0

1100-1.41/2A SEPARATOR AND PULLER SET

in GEDORE L-BOXX® 136, 21 pieces

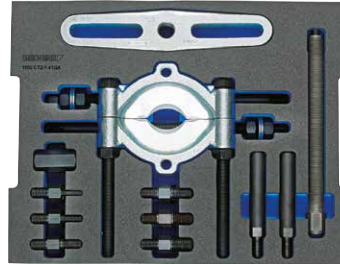
- › For clamping depths from Ø 22 to 115 mm and clamping reach up to 295 mm
- › For loosening and pulling tightly-seated parts e.g. taper roller bearings and inner bearing races
- › GEDORE L-BOXX® 136 with an easy click attaching system





Description	Contents	W	D	H	pieces	Code	No.	
Separator and puller set in L-BOXX 136	Separator puller No. 1x 1.38/2, 70-215 mm Separator No. 1.40/2, 22-115 mm Set of threaded inserts No. 1.81/20, for 1 and 2-hole applications, M14x1.5 2x extension No. 1.38/CV M14x1.5 + GEDORE L-BOXX® 136 No. 1100 L	442	357	151	22	2927284	1100-1.41/2A	11.5
Separator and puller set in 2/2 L-BOXX 136 module	Separator puller No. 1x 1.38/2, 70-215 mm Separator No. 1.40/2, 22-115 mm Set of threaded inserts No. 1.81/20, for 1 and 2-hole applications, M14x1.5 2x extension No. 1.38/CV M14x1.5	442	357	151	21	2927292	1100 CT2-1.41/2A	7.9

1101-1.29/1K BALL BEARING EXTRACTOR SET

in i-BOXX® 72

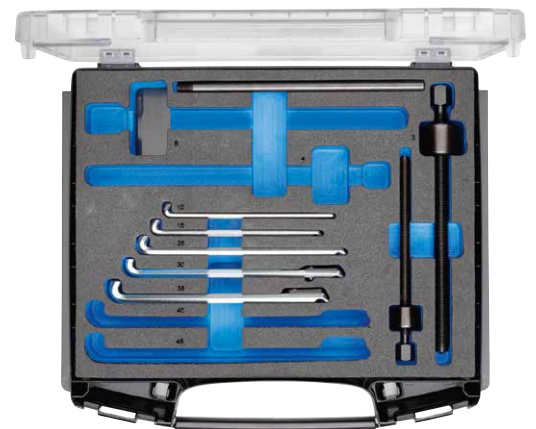
- › Ball bearing extractor set for more than 30 ball bearings
- › For removing ball bearings that are both on a shaft and in a housing
- › Non-destructive removal of deep-groove ball bearings without dismantling the shaft; no necessity to drill open the bearing cage (no chippings)
- › In GEDORE i-BOXX® 72 No. 1101 L
- › Compatible with GEDORE i-BOXX® Rack active No. 1101 K



for ball bearing No.	Contents	W	D	H	pieces	Code	No.	
6000 6001 6002 6003 6004 6005 6006 6007 6008 6009 6010 6011 6012 6200 6201 6202 6203 6204 6205 6206 6207 6300 6301 6302 6303 6304 6305 6306 6307 6403 6404	2 Heads with spindle No. 1.29/1 + 1.29/3 5 Hook sets No. 1.29/10 - 1.29/35 1 Plug-in handle No. 1.29/0 GEDORE i-BOXX 72	367	316	72	9	2963485	1101-1.29/1K	3.050
	2 Heads with spindle No. 1.29/1 + 1.29/3 5 Heads with spindle No. 1.29/10 - 1.29/35 1 Plug-in handle No. 1.29/0	367	316	72	8	2964414	1101 CT-1.29/1K	1.750

1101-1.29/3K BALL BEARING EXTRACTOR SET in i-BOXX® 72

- > Ball bearing extractor set for more than 40 ball bearings
- > For removing ball bearings that are both on a shaft and in a housing
- > Non-destructive removal of deep-groove ball bearings without dismantling the shaft; no necessity to drill open the bearing cage (no chippings)
- > In GEDORE i-BOXX® 72 No. 1101 L
- > Compatible with GEDORE i-BOXX® Rack active No. 1101 K



for ball bearing No.	Contents	W	D	H	pieces	Code	No.	kg
6000 6001 6002 6003 6004 6005 6006	4 Heads with spindle No. 1.29/1 - 1.29/5	367	316	72	13	2964392	1101-1.29/3K	5.780
6007 6008 6009 6010 6011 6012 6200	7 Hook sets No. 1.29/10 - 1.29/45							
6201 6202 6203 6204 6205 6206 6207	1 Plug-in handle No. 1.29/0							
6208 6209 6210 6211 6212 6213 6300	GEDORE i-BOXX 72							
6301 6302 6303 6304 6305 6306 6307	4 Heads with spindle No. 1.29/1 - 1.29/5	367	316	72	12	2964430	1101 CT-1.29/3K	6.195
6308 6309 6310 6311 6403 6404 6405	7 Heads with spindle No. 1.29/10 - 1.29/45							
6406 6407	1 Handle No. 1.29/0							

1100 L GEDORE L-BOXX® 136 with easy carry handle

- > Impact-resistant ABS plastic
- > Splash-proof
- > With tool board for order and more storage space
- > Easy click plug-system: practical plug connection for two or more L-BOXX®es, for secure grip and easy to carry



W	D	H	Code	No.	kg
442	357	151	2823691	1100 L	2.2

1100 R GEDORE L-BOXX® ROLLER

- > Practical, mobile trolley for all L-BOXX® types
- > Simply fit and click into place
- > Four swivel castors for self-assembly of which two have brakes
- > Load capacity up to 100 kg



W	D	H	Code	No.	kg
646	492	184	2823756	1100 R	4.4

ET-1100 W

LID TOOL BOARD

empty

- > For or retrofittable for any L-BOXX®
- > Rubber straps and pockets for inserting tools
- > For orderliness and more storage space
- > Mounting material is included in delivery



W	D	H	Code	No.	
375	20	310	2678322	ET-1100 W	0.400

1101 L

GEDORE I-BOXX® 72

- > Small parts case with transparent cover for getting an immediate impression
- > Ideal for keeping small parts and accessories
- > Optional inset boxes i3 for an individual range
- > Comfort handle



W	D	H	Code	No.	
367	316	72	2823705	1101 L	0.900

1101 K

GEDORE I-BOXX® RACK ACTIVE

- > Shelf-like holder for any i-BOXX® 72
- > Easy click attaching system, thus compatible with the GEDORE L-BOXX® 136 or with any other L-BOXX® on the market





W	D	H	Code	No.	
442	357	100	2823713	1101 K	1.100

1102 L

GEDORE L-BOXX® MINI

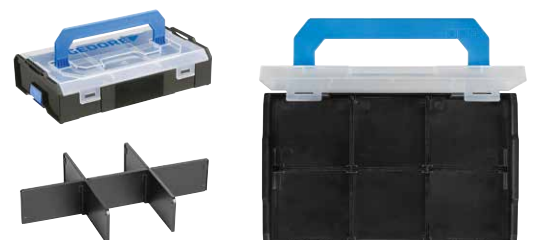
- > Can be used together with the GEDORE BOXX®-system
- > Especially suitable for small tool sets
- > Also usable as small parts box, incl. divider set



W	D	H	Code	No.	
260	155	63	2950529	1102 L	0.4

E-1101 BT GEDORE INSETBOX 13

- > For GEDORE i-BOXX® 72
- > For keeping small parts
- > Further subdivision possible with the 2 partitions



W	D	H	Code	No.	
260	78	63	2840006	E-1101 BT	0.100

922 WORK GLOVES M-PACT

- > For strongest demands in use
- > Extra finger-tip reinforcement
- > Hook and loop fastener of sleeve band
- > Can also be used as ankle guards
- > Ergonomic inside hand reinforcement



Size	Code	No.	
S/8	1938738	922 8	0.050
M/9	1938746	922 9	0.050
L/10	1938754	922 10	0.050
XL/11	1938762	922 11	0.050
XXL/12	1938770	922 12	0.050

920 WORK GLOVES FASTFIT

- > For universal use
- > Snug fitting



Size	Code	No.	
S/8	1938576	920 8	0.080
M/9	1938584	920 9	0.080
L/10	1938592	920 10	0.080
XL/11	1938606	920 11	0.080
XXL/12	1938614	920 12	0.080

WT 1056 10 KNEE PADS pair

- > Breathable 3D fabric for wear comfort the whole day long
- > Soft lining for comfortable kneeling
- > Velcro fasteners with elastic bands for ease in putting on and taking off
- > Universal size



Code	No.	
1818236	WT 1056 10	0.180

GEDORE

TOOLS FOR LIFE

GEDORE Werkzeugfabrik GmbH & Co. KG

Remscheider Straße 149
42899 Remscheid · GERMANY
Tel. + 49 (0) 21 91- 596 - 0
Fax + 49 (0) 21 91- 596 - 230
info@gedore.com
www.gedore.com

Vertrieb Deutschland

Tel. + 49 (0) 21 91- 596 - 900
Fax + 49 (0) 21 91- 596 - 999

Sales International

Tel. + 49 (0) 21 91- 596 - 910
Fax + 49 (0) 21 91- 596 - 911

GEDORE Automotive GmbH

Breslauer Straße 41
78166 Donaueschingen · GERMANY
Tel. +49 711 83223-0
Fax +49 711 83223-90

GEDORE Torque Solutions GmbH

Bertha-Benz-Straße 12
71665 Vaihingen/Enz · GERMANY
Tel. +49 7042 9441-0
Fax +49 7042 9441-41
info@loesomat.de

Brands of the GEDORE Group

gedore.com · oxsenkopf.com

gedore.com

Your dealer / stamp:

ООО "КОМПАНИЯ ОПТУЛС"

Москва, ул.Иловайская, д.3

Тел.: +7 (495) 646-00-96

sale@opttools.ru

www.opttools.ru

Delivery without decoration. Technical specifications subject to modifications.
No liability for printing errors. Please ask your local dealer.

Valid from 01/04/2019 until 31/03/2020