



**BERNSTEIN**  
TOOLS FOR ELECTRONICS



**BALL JOINT - VICES  
BALL JOINT - HOLDER  
AND EQUIPMENT**

Vers.01

**GET IN CONTACT WITH US****BERNSTEIN****Werkzeugfabrik  
Steinrücke GmbH**

Industrie Hof Trecknase 1  
42897 Remscheid

Tel. + 49 (0) 2191 - 9650 - 0  
Fax + 49 (0) 2191 - 9650 - 30

sales@bernstein-tools.de

**VISIT US ON THE WEB**

We update our product information on a regular basis and automatically using our Product Information System. This enables the quick and up-to-date compilation of customer-specific data feeds for your own digital sale activities. Take advantage of this service and always keep Bernstein product information up to date!

**www.bernstein-tools.de**

Product videos and blog posts round off our online offering. Furthermore, we also respect the traditional sales channel via specialist retailers and offer the option to present your webshop as an online sales platform for products by BERNSTEIN.

**SYMBOL LEGEND****NEU**

New product



Number of tools in sets



Weight



Dimensions



ESD protection (EPA suitable)



VDE tested

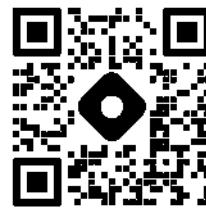



## BALL JOINT CLAMPING DEVICES FIRM HOLD IN EVERY POSITION

Due to their complex geometry, workpieces, components or assemblies need to be able to be turned and held in different orientations during processing, servicing or repair.

We offer various retaining tools to overcome such challenges. Our SPANNFIX product series ranges from classic vice heads to special equipment for the electronics industry to variable and versatile bases.

In all of our SPANNFIX products, we manufacture our high-grade, precise ball joint from steel, the ball joint can be moved in many different positions and fixed steplessly with a simple press of the lever.

The different heads and bases in our SPANNFIX product line allow flexible working in any place or situation. Depending on the application, they can be combined with each other.

For example, many of our various bases are used to hold cameras, monitors or other components. The possibilities are endless.

Get in touch with us if you can't find what you're looking for in our product range. Together we will find a solution.

[sales@bernstein-tools.de](mailto:sales@bernstein-tools.de)

## CLAMPING TOOLS WITH BALL JOINT

### WHAT OUR CLAMPING TOOLS DISTINGUISHES

These are multifunctional clamping devices, the **perfect third hand** at the workplace, extremely flexible, can be fixed very quickly with high holding force.

Individual adjustment of the working height offers an **ergonomic posture** standing or sitting work. Soldering, gluing, drilling, sawing, grinding, filing, milling, cutting, much more.

Individual adjustment of the **working angle** the workpiece can be held as required in the respective application.

With a **simple lever movement** the ball is locked or released.

The **mobility of the ball** can be set more tightly or loosely using the adjusting screw on the lower seat of the ball.

**Long product life** is guaranteed by the bullet-free cast aluminium, the high-quality powder coating and the refined steel parts. 100% Made in Germany.

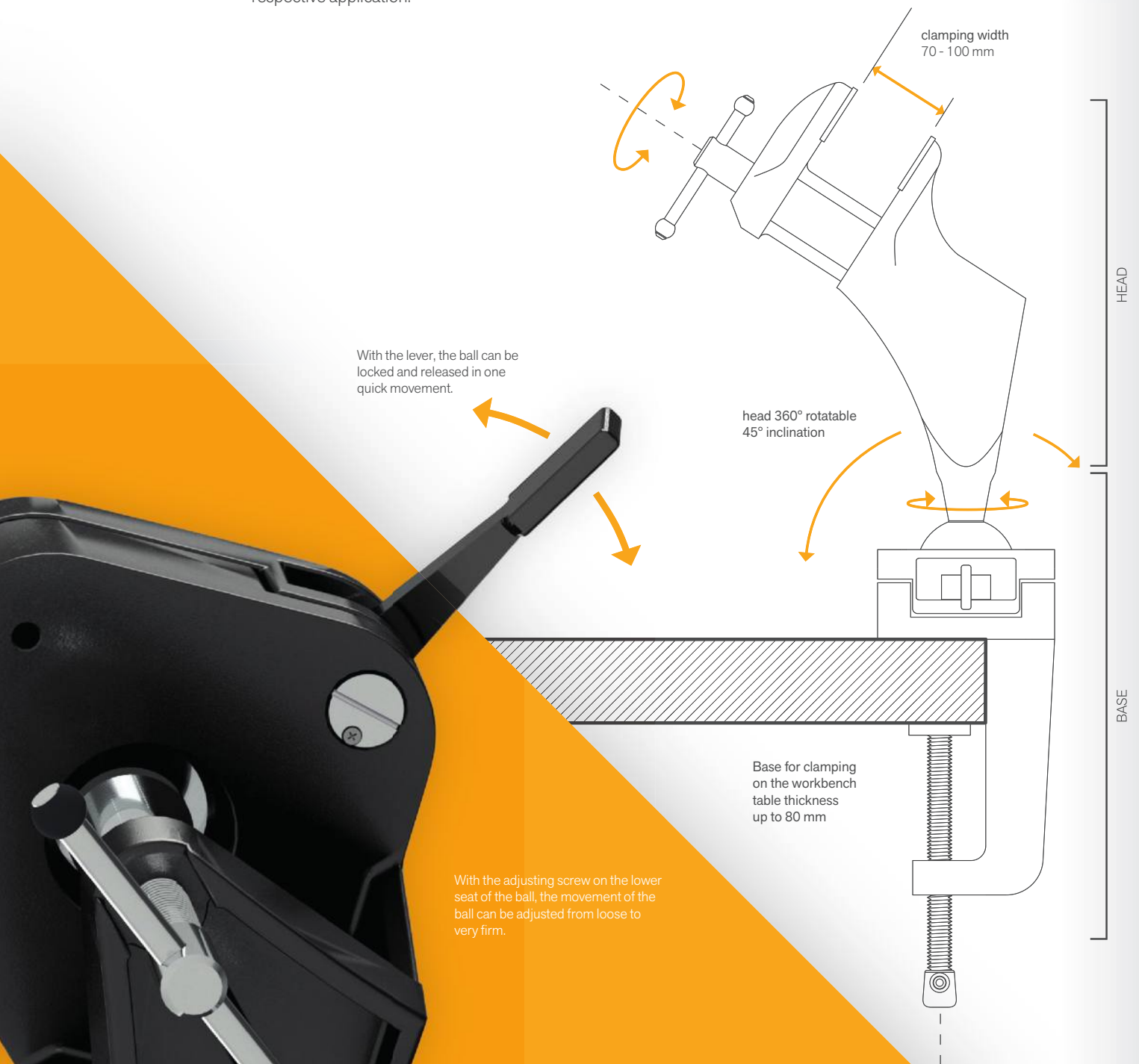

## AROUND THE BALL

### MANUFACTURE AND MATERIAL

The ball and connecting parts are made of free-cutting steel with a high-gloss chrome plating. The high-precision manufacture of the ball guarantees absolute roundness in order to ensure permanent ease of movement. The powder-coated parts are made of an aluminum alloy with high strength values. Our quality management carries out constant controls during the manufacturing process. During disassembly, every vice and ball joint holder is subject to a quality and function control.

The individual parts are made in Germany from Remscheid, eco-friendly and sustainably produced. When procuring raw materials and accessories, we work with selected suppliers who adhere to environmental compliance and ethical principles.

The traditional brand BERNSTEIN stands for durable products for professionals, which many customers have enjoyed for decades.

### CLAMPING FORCE AND TORQUE

The size of the steel ball determines the holding force

#### Ø 40 mm

Maximum torque in the ball socket	approx. 24 Nm
Holding force at height of threaded pin	approx. 45 kg (441 N)

#### Ø 60 mm

Maximum torque in the ball socket	approx. 100 Nm
Holding force at height of threaded pin	approx. 140 kg (1372 N)

By degreasing the ball, you increase the maximum holding or clamping force.

For safety-relevant parts, please note that we cannot give a guarantee of the holding forces without knowing your specific application. The ball may behave differently under different physical conditions than it does in our test laboratory in an optimal test environment.

### THREADED CONNECTION

The threaded pin on the ball has an M12 thread with a 1.5 mm pitch (special thread).

**We offer matching threaded connection adapters 1/4 inch or metric threads from M6 to M12. With internal or external thread, straight or 45° bent length from 50 to 100 mm. Other threaded connections are available on request.**

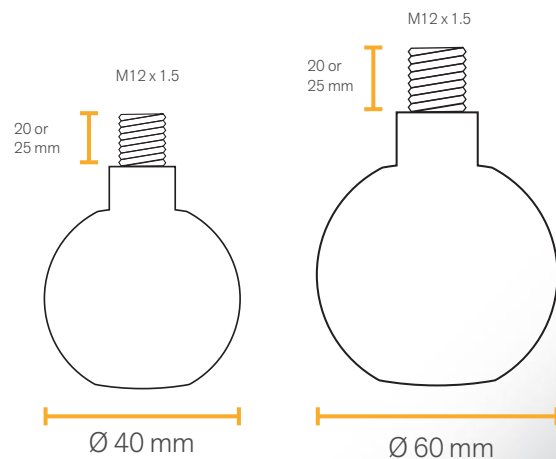



## BALL JOINT VICE MODELS

The BERNSTEIN ball joint vice has a continuously adjustable joint head that can be **rotated 360° and inclined  $\pm 45^\circ$** . The upper part of the vice can thus be tilted in any direction and allows work in front of or above the table. With a simple lever movement, the vice head is loosened in the ball socket, individually aligned and clamped again. Despite stepless locking, the ball clamp offers an **extremely strong hold**.

The ESD versions have a dissipative powder coating and an earthing connection push button (10 mm) on the back.

The article numbers in the table are explained in detail on the following pages.

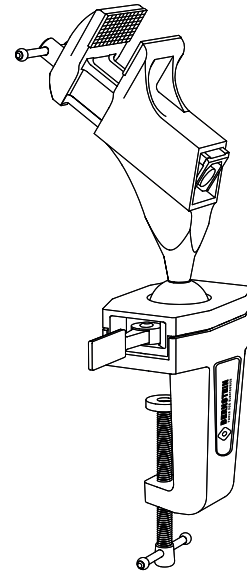

### ► Vice for clamping

Art-No.	Ball/torque	Clamp.force	Jaw width/material	Weight	Colour	Special feature
9-205	Ø 40 mm/ approx 24 Nm	1470 N	<b>50 mm</b> / plastic	1450 g	grey metallic	
9-205-ESD	Ø 40 mm/ approx 24 Nm	1470 N	<b>50 mm</b> / plastic	1450 g	ESD black	dissipative, with earthing connection
<b>NEW</b> 9-205-K	Ø 40 mm/ approx 24 Nm	1470 N	<b>50 mm</b> / plastic	1450 g	grey metallic	with Velcro (hook ripening together)
9-290	Ø 60 mm/ approx 100 Nm	12,000 N	<b>100 mm</b> / steel	5500 g	grey metallic	the professional with pins and spirit level

### ► Vice for screwing on

Art-No.	Ball/torque	Clamp.force	Jaw width/material	Weight	Colour	Special feature
9-215	Ø 40 mm/ approx 24 Nm	1470 N	<b>50 mm</b> / plastic	1310 g	grey metallic	
9-215-ESD	Ø 40 mm/ approx 24 Nm	1470 N	<b>50 mm</b> / plastic	1310 g	ESD black	dissipative, with earthing connection
9-292	Ø 60 mm/ approx 100 Nm	12,000 N	<b>100 mm</b> / steel	4720 g	grey metallic	the professional with pins and spirit level

### ► Vice with magnets

Art-No.	Ball/torque	Clamp.force	Jaw width/material	Weight	Colour	Special feature
9-287	Ø 40 mm/ approx 24 Nm	1470 N	<b>50 mm</b> / plastic	1310 g	grey metallic	4 high-performance magnets
<b>NEW</b> 9-297	Ø 60 mm/ approx 100 Nm	12,000 N	<b>100 mm</b> / steel	4720 g	grey metallic	the professional with pins and spirit level and 4 high-performance magnets

## BALL JOINT HOLDER MODELS

The BERNSTEIN ball joint brackets enable precise and secure positioning in all directions, e.g. of sensors, measuring instruments, monitors and surveillance cameras, **inclination angle  $\pm 45^\circ$** . The thread pin has an M12 x 1.5 mm thread (special thread), the scope of delivery includes a sschnorr washer, lock nut and lock nut for the thread. **We offer suitable threaded connection adapters from M6 to M12 or 1/4 inch.** With internal or external thread, straight or 45° bent, from 50 to 100 mm. Other threaded connections are available on request.

The ESD versions have a dissipative powder coating and an earthing connection push button (10 mm) on the back.

The item numbers in the table are explained in detail on the following pages.

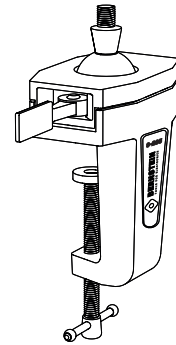

### ► Ball Joint Holder for clamping

Art-No.	Ball/holding force	Thread length	Support surface	Clamping range	Colour	Dissipative
9-251	Ø 40 mm / approx 45 kg	20 mm	Ø 20 mm	max. 80 mm	grey metallic	
9-251-ESD	Ø 40 mm / approx 45 kg	20 mm	Ø 20 mm	max. 80 mm	ESD black	10 <sup>7</sup> - 10 <sup>8</sup> Ohm
9-251-SW	Ø 40 mm / approx 45 kg	20 mm	Ø 20 mm	max. 80 mm	black matt	
9-291	Ø 60 mm / approx 140 kg	20 mm	Ø 20 mm	max. 80 mm	grey metallic	

### ► Ball Joint Holder for screwing on

Art-No.	Ball/holding force	Thread length	Support surface	Boreholes	Colour	Dissipative
9-261	Ø 40 mm / approx 45 kg	20 mm	Ø 20 mm	4 x Ø 9 mm	grey metallic	
9-261-ESD	Ø 40 mm / approx 45 kg	20 mm	Ø 20 mm	4 x Ø 9 mm	ESD black	10 <sup>7</sup> - 10 <sup>8</sup> Ohm
9-261-SW	Ø 40 mm / approx 45 kg	20 mm	Ø 20 mm	4 x Ø 9 mm	grey metallic	
9-262	Ø 40 mm / approx 45 kg	25 mm	Ø 36 mm	4 x Ø 9 mm	grey metallic	
9-262-SW	Ø 40 mm / approx 45 kg	25 mm	Ø 36 mm	4 x Ø 9 mm	black matt	
9-281	Ø 40 mm / approx 45 kg	20 mm	Ø 20 mm	4 x Ø 6.5 mm	grey metallic	
9-281-ESD	Ø 40 mm / approx 45 kg	20 mm	Ø 20 mm	4 x Ø 6.5 mm	ESD black	10 <sup>7</sup> - 10 <sup>8</sup> Ohm
9-281-SW	Ø 40 mm / approx 45 kg	20 mm	Ø 20 mm	4 x Ø 6.5 mm	black matt	
9-293	Ø 60 mm / approx 140 kg	20 mm	Ø 20 mm	4 x Ø 9 mm	grey metallic	
9-294	Ø 60 mm / approx 140 kg	25 mm	Ø 36 mm	4 x Ø 9 mm	grey metallic	

NEW

NEW

### ► Ball Joint Holder with magnets

Art-No.	Ball/holding force	Thread length	Support surface	Colour	Magnete
9-284-SW	Ø 40 mm / approx 45 kg	20 mm	Ø 20 mm	black matt	4 magnets with protective cap, adhesive force without cap: horizontally 32 kg, vertically 15 kg
9-296	Ø 60 mm / approx 140 kg	20 mm	Ø 20 mm	grey metallic	

NEW

## BALL JOINT VICE - JAWS 50 MM FOR CLAMPING

► Product family 9-205



For workbenches or tabletops with a maximum table thickness of 80 mm. The small vice with ball joint can be quickly and easily connect to any table tops thanks to its smooth-running table clamp. A little pressure of the lever is enough and that the clamped workpiece can be fixed steplessly and in any practical working position. He had stable 50 mm ribbed plastic jaws (waffle pattern).



Clamping pressure: 1470 N  
 Clamping width: 70 mm  
 Clamping depth: 38 mm  
 Jaw width: 50 mm



Position as shown  
 approx 310 x 170 x 75 mm  
 (dimensions for orientation)



Weight 1450 g



## GLUE AND VELCRO

We offer replacement jaws for permanent gluing 9-205 or with exchangeable Velcro connection 9-205-K. In addition to smooth and ribbed plastic jaws, we offer cork, leather and felt jaws for optimum surface protection of the workpiece.

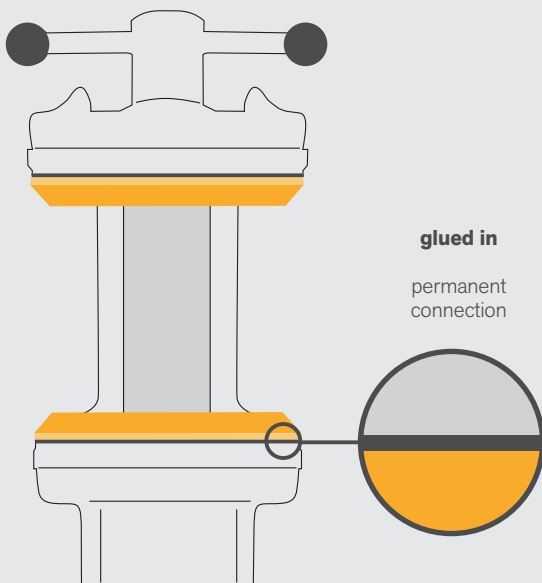

9-205

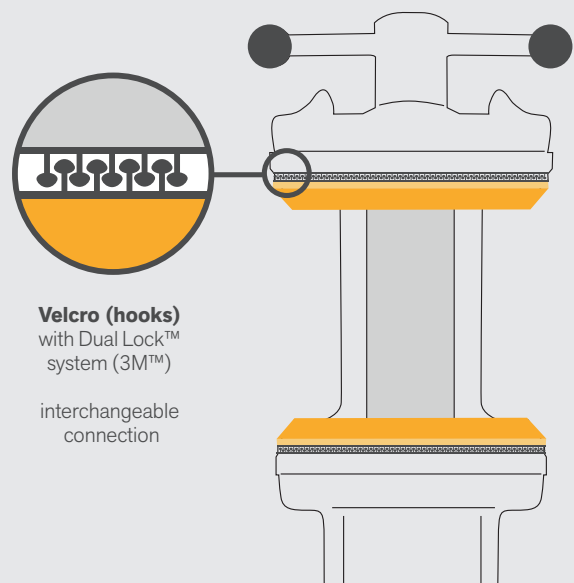

9-205-K



## VARIANTS

In electronics, PCBs (especially small circuit boards) are clamped into the conductive plastic jaws with a waffle pattern for soldering sensitive components. This **SPECIALIST** is EPA suitable (for electrostatically protected areas, ESD workplace, ESD protection zone) the foot section can be connected to the grounding point on the back with a 10 mm push button.



9-205



9-205-K



9-205-ESD

Art-No.	9-205	9-205-K	9-205-ESD
Colour variation and coating	grey metallic	grey metallic	black, dissipative
Protective jaws glued in	✓	-	✓
Velcro fastened protective jaws (Dual Lock™)	-	✓	-
Dissipative	-	-	10 <sup>7</sup> - 10 <sup>8</sup> Ohm

Application specialty

BASIC



ALLROUNDER



**SPECIALIST** with earth connector button



## SETS

The **BASIC** and **ALLROUNDER** are used in model making and precision mechanics. The high-quality covering protects sensitive parts from scratches or damage.



9-205-SET1



9-205-K-SET1



9-205-ESD-SET1

Art-No.	9-205-SET1	9-205-K-SET1	9-205-ESD-SET1
Content	<p>9-205 Ball Joint Vice</p> <p><b>Glue jaws:</b>                      99-900-K50-FILZ (FELT)                      9-900-K50-KORK (CORK)                      9-900-K50-LEDER (LEATHER)                      9-900-K50-KST (plastic ribbed)                      9-900-K50-KSTG (plastic ribbed)                      2-123 Lever tool</p>	<p>9-205-K Ball Joint Vice</p> <p><b>Velcro jaws:</b>                      99-900-K50-FILZ (FELT)                      9-900-K50-KORK (CORK)                      9-900-K50-LEDER (LEATHER)                      9-900-K50-KST (plastic ribbed)                      9-900-K50-KSTG (plastic ribbed)</p>	<p>9-205 ESD Ball Joint Vice</p> <p><b>ESD Accessories:</b>                      9-359-2 ESD Earth bonding plug                      9-343-1 ESD Grounding cable</p>

Application specialty

BASIC

ALLROUNDER

**SPECIALIST** with earth connector button

# BALL JOINT VICE - JAWS 50 MM FOR SCREWING

► Product family 9-215



Suitable for all workbenches and work tables, space dimensions 150 x 106 mm. The vice can be connected to any table tops with four bore holes (Ø 9 mm). A drilling drawing can be downloaded from the website. A small pressure of the lever is sufficient and the clamped workpiece can be fixed steplessly and in any convenient working position.

Clamping pressure: 1470 N  
 Clamping width: 70 mm  
 Clamping depth: 38 mm  
 Jaw width: 50 mm



Position as shown approx 220 x 180 x 115 mm (dimensions for orientation)



Weight 1310 g



## VARIANTS AND SETS



Art-No.	9-215	9-215-ESD	9-215-ESD-SET1
Colour variation and coating	grey metallic metallic	black, dissipative	black, dissipative
Jaws glued on	✓	✓	✓
Velcro jaws (Hook Dual Lock™)	-	-	-
Dissipative	-	10 <sup>7</sup> - 10 <sup>8</sup> Ohm	10 <sup>7</sup> - 10 <sup>8</sup> Ohm
Spare parts	-	-	<b>ESD Accessories:</b> 9-359-2 ESD Earth bonding plug 9-343-1 ESD Grounding cable
Application specialty	BASIC	SPECIALIST with earth connector button	SPECIALIST with earth connector button



## PROTECTIVE JAWS VELCRO (HOOKS)

### ► Quick change protective jaws 50 mm

firm, stable, precise and pinpoint connection  
different versions, scope of delivery 2 pieces (one pair)

	Art-No.	Material
NEW	9-900-K50-KORK	cork oak
NEW	9-900-K50-FILZ	felt lint-free
NEW	9-900-K50-LEDER	genuine leather hard-wearing
NEW	9-900-K50-KST	plastic ribbed (waffle pattern)
NEW	9-900-K50-KSTG	plastic smooth

### ► completely: 9-900-K50-SET (5 pair)

including replacement Velcro pads 10 pieces  
(Art: KLETT-K050x25)

NEW

### ► Quick change protective jaws 50 mm

firm, stable, precise and pinpoint connection  
different versions, scope of delivery 2 pieces (one pair)

	Art-No.	Material
NEW	9-900-K50-KSTP	plastic prisms
NEW	9-900-K50-ALP	alu prisms
NEW	9-900-K50-ALG	alu with rubber, abrasion resistant

## GLUING

### ► Protective jaws 50 mm

with a smooth plastic surface to stick on yourself  
various designs, scope of delivery 2 pieces (one pair)

	Art-No.	Material
NEW	9-900-E50-KORK	cork oak
NEW	9-900-E50-FILZ	felt lint-free
NEW	9-900-E50-LEDER	genuine leather hard-wearing
	9-900-E50	plastic ribbed (waffle pattern)
	9-900-E50-ESD	plastic smooth

### ► completely: 9-900-E50-SET (5 pair)

including lever tool (Art: 2-123 ESD)

NEW



#### FLEXIBLE

By simply pressing together - small mushroom heads interlocked - a very firm but removable connection is created. The snap fastener can be crossed, staggered or overlapped. It provides a permanent fastening that will not loosen even with sustained shaking. Dual Lock™ technology (3M™) Velcro instructions see YouTube video BERNSTEIN vice jaws.



9-900-K50-SET

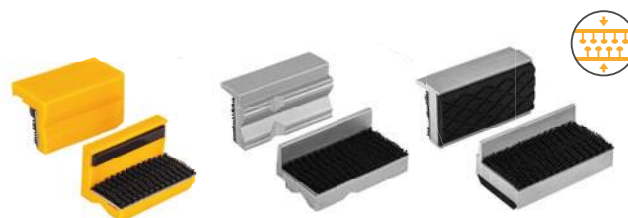

#### DURABLE

For continuous use, we recommend replacement jaws for gluing in. The replacement jaws, once fitted, provide a comfortable, safe and durable solution.



9-900-E50-SET

## BALL JOINT VICE - JAWS 50 MM WITH MAGNETS

### ▶ Ball Joint Vice 9-287



With 4 high-performance magnets (including protective caps) for fixing to steel surfaces. Holding force 32 kg horizontal, 15 kg vertical (magnets without caps). The magnets are firmly connected to the base by screws. A small lever pressure is sufficient and the clamped workpiece can be fixed steplessly and in any practical working position.



Clamping pressure: 1470 N  
 Clamping width: 70 mm  
 Clamping depth: 38 mm  
 Jaw width: 50 mm



Position as shown  
 approx 240 x 170 x 75 mm  
 (dimensions for orientation)



Weight 1310 g



## BALL JOINT VICE - JAWS 100 MM FOR CLAMPING

### ▶ Ball Joint Vice 9-290



2020 awarded with the  
**EISEN-AWARD**

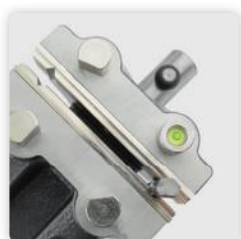

With a jaw width of 100 mm, the ball joint vice 4.0 is the largest ball joint vice on the market. It convinces with its unique selling points, the **dowel pins**, its **changeable jaws**, its **center eye** (spirit lever) and the very high ball clamping force. For workbenches or tabletops with a maximum table thickness of 80 mm.



Clamping pressure: 12000 N  
 Clamping width: 100 mm  
 Clamping depth: 50 mm  
 Jaw width: 100 mm



Position as shown  
 approx 400 x 220 x 200 mm  
 (dimensions for orientation)



Weight 5500 g



### ▶ 9-290-SET1

**consisting of:**

- 9-290 Ball joint vice SPANNFIX 4.0 for clamping
- 9-900-SET-100 SET protective jaws 100 mm



**4 Steel dowel pins removeable**  
allowed clamping of  
round - oval - shapeless or  
completely amorphous parts

**Center eye (spirit level)**  
for perpendicular work

**Changeable jaws 100 mm**  
with prisms or flat side

**Ruler** for accurate  
reading of the backend  
distance approx 100 mm

45°

45°

**Ball joint** for positioning  
of the clamping head in  
any direction

±45° inclinable  
360° rotatable

360°

Following versions are available:

- ◀ 9-290 Ball Joint Vice SPANNFIX 4.0  
for clamping on
- ▼ 9-291 Ball joint holder SPANNFIX 4.0  
Base clamping on, **for heavy parts**  
(Threaded pin M12 x 1.5 mm)

corners and edges

See the movie





## FOR SCREWING ON OR MAGNETIC - JAWS 100 MM

► Product family 9-292 and 9-297



The vice can be screwed to the workbench through 4 through holes (152 x 151 mm space) or fixed to steel surfaces with 4 magnets. The 4 heavy-duty magnets with protective caps have a holding force of 32 kg horizontally and 15 kg vertically (magnets without caps). The magnets are firmly connected to the housing by screws. A tapping drawing can be downloaded from the website.



Clamping pressure: 12000 N  
 Clamping width: 100 mm  
 Clamping depth: 50 mm  
 Jaw width: 100 mm



Position as shown approx 290 x 160 x 190 mm (dimensions for orientation)



Weight 4720 g

## VARIANTS



9-292



9-297

Art-No.	9-292	9-297
Colour variation and coating	grey metallic	grey metallic
Bore holes	✓	-
High performance magnets	-	✓
Application specialty	for screwing on	Magnetic base for steel surfaces

## SPARE PARTS DOWEL PINS



9-900-S1000



9-900-S1002



9-900-S1003



9-900-S1004

Art-No.	9-900-S1000	9-900-S1002	9-900-S1003	9-900-S1004
Material	steel	plastic	steel	plastic
With integrated spirit level	✓	-	-	-
Weight	100 g	18 g	172 g	32 g
Mounting	Ø 8 mm	Ø 8 mm	Ø 8 mm	Ø 8 mm
Height	approx 15 mm	approx 15 mm	approx 30 mm	approx 30 mm

► 9-900-0773-1

### Changeable steel jaws 100 mm

Can be used on both sides, smooth surface and profile side for pipe clamping or round material; with stepped edge (groove) for square material or thick sheets. Dimensions 100 x 30 x 6 mm, weight 83 g

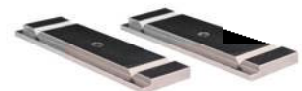

## PROTECTIVE JAWS

in various designs, with magnetic strips or magnetic dots suitable for clamping scratch and impact sensitive parts, scope of delivery 2 pieces (one pair)



		100 mm	125 mm	150 mm
NEW	Cork (yellow prismatic plastic jaws with abrasion-resistant, soft cork oak coating)	9-900-S4100	9-900-S4125	9-900-S4150
NEW	Leather (yellow prismatic plastic jaws with hard-wearing genuine leather covering)	9-900-S5100	9-900-S5125	9-900-S5150
NEW	Felt (yellow prismatic plastic jaws with robust, lint-free felt fleece fibre covering)	9-900-S6100	9-900-S6125	9-900-S6150
	Plastic (yellow prismatic plastic jaws, smooth on one side, robust hard plastic)	9-900-S7100	9-900-S7125	9-900-S7150
	Rubber (aluminium jaws with profiled rubber coating)	9-900-S8100	9-900-S8125	9-900-S8150
	Aluminium prisms (aluminium jaws with prisms and angular clamping grooves)	9-900-S9100	9-900-S9125	9-900-S9150

### Protective jaws set 6 pcs

NEW

Packed in a plastic bag that can be hung on the wall or rolled up to save space. Bag dimensions: approx. 430 x 390 mm

#### Content

- Pocket, 6 pockets 80x130 mm
- Plastic protective jaws cork (pair)
- Plastic protective jaws leather (pair)
- Plastic protective jaws felt (pair)
- Plastic protective jaws (pair)
- Aluminum protective jaws rubber (pair)
- Aluminum protective jaws prisms (pair)



100 mm	125 mm	150 mm
9-900-SET-100	9-900-SET-125	9-900-SET-150

## SPARE PARTS ADHESIVE STRIPS

For all types of vice protective jaws or replacement jaws to stick on, as protection for sensitive parts that have to be fixed, clamped and processed.

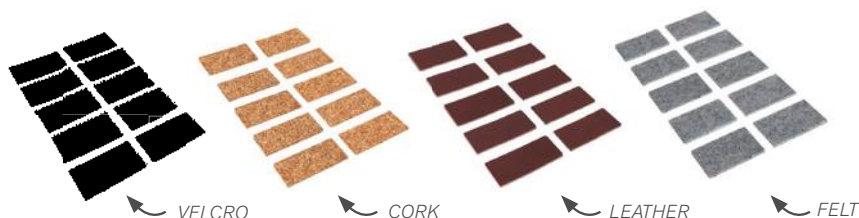

		50 mm	100 mm	125 mm	150 mm
NEW	Velcro self-adhesive (VE10)	KLETT-050x25x3	-	-	-
NEW	Cork self-adhesive (VE10)	KORK-050x25x3	KORK-100x25x3	KORK-125x25x3	KORK-150x25x3
NEW	Leather self-adhesive (VE10)	LEDER-050x25x3	LEDER-100x25x3	LEDER-125x25x3	LEDER-150x25x3
NEW	Felt self-adhesive (VE10)	FILZ-050x25x3	FILZ-100x25x3	FILZ-125x25x3	FILZ-150x25x3

# BALL JOINT HOLDER FOR CLAMPING

► Product family 9-251



For workbenches or tabletops with a maximum table thickness of 80 mm. The holder can be quickly and easily connect to any workbench or tabletop thanks to its smooth-running table clamp. A little pressure of the lever is enough and that the clamped workpiece can be fixed steplessly and in any practical working position.

Ball size: Ø 40 mm  
 Holding force: approx 45 kg (441N)  
 Clamping range: approx 80 mm



Position as shown approx 220 x 170 x 75 mm (dimensions for orientation)



Weight 940 g



## VARIANTS

Included in delivery: schnorr washer, lock nut and lock nut for the thread.



Art-No.	9-251	9-251-SW	9-251-ESD
Colour variation and coating	grey metallic	black matt	black, dissipative
Thread pin	M12 x 1.5 mm	M12 x 1.5 mm	M12 x 1.5 mm
Thread length	20 mm	20 mm	20 mm
Dissipative	-	-	10 <sup>7</sup> - 10 <sup>8</sup> Ohm
Application specialty	BASIC	BASIC	SPECIALIST with earth connector button

A quick clamping to optimally align cameras, monitors, sensors or measuring instruments. Used in woodworking as carving plates, carving balls or various clamping and holding tool. Wide variety of clamping and holding devices are screwed on for instrument and model making. Suitable adapters and extensions of all types can be screwed on via the thread on the ball. An optimal hold to repair e-scooters, e-bikes and bicycles free-floating. Used for years in universities, research centers and laboratories have appreciated the many possible applications.



## BALL JOINT HOLDER FOR SCREWING

### ► Product family 9-261 and 9-262



Suitable for all workbenches and tables. Place dimensions 150 x 106 mm. The holder can be screwed on with four through holes (Ø 9 mm). A drilling drawing can be downloaded from the website. A small lever pressure is sufficient to fix the ball steplessly and in any practical working position.

Ball size: Ø 40 mm  
Holding force: approx 45 kg (441N)  
Bore holes: Ø 9 mm



Position as shown  
90 x 180 x 110 mm  
(dimensions for orientation)



Weight 850 g

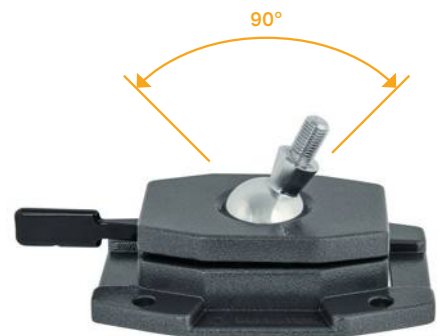

## VARIANTS

Included in delivery: schnorr washer, lock nut and lock nut for the thread.



Art-No.	9-261	9-261-SW	9-261-ESD	9-262	9-262-SW
Colour variation and coating	grey metallic	black matt	black, dissipative	grey metallic	black matt
Thread pin	M12 x 1.5 mm	M12 x 1.5 mm	M12 x 1.5 mm	M12 x 1.5 mm	M12 x 1.5 mm
Thread length	20 mm	20 mm	20 mm	25 mm	25 mm
Support surface	Ø 20 mm	Ø 20 mm	Ø 20 mm	Ø 36 mm	Ø 36 mm
Dissipative	-	-	10 <sup>7</sup> - 10 <sup>8</sup> Ohm	-	-
Application specialty	BASIC	BASIC	SPECIALIST with earth connector button	EXTRA with large pin	EXTRA with large pin



# BALL JOINT HOLDER FOR SCREWING ON OR MAGNETIC

► Product family 9-281 and 9-284-SW



This slim holder is the lightweight among the BERNSTEIN holders. At 110 x 72 mm, it can be screwed onto any tabletop with 4 through holes (Ø 6.5 mm) to save space, or fixed to steel surfaces with 4 magnets. A drilling drawing can be downloaded from the website. The 4 heavy-duty magnets with protective caps have a holding force of 32 kg horizontally and 15 kg vertically (magnets without caps). The magnets are firmly connected to the base by screws.



Ball size: Ø 40 mm  
 Holding force: approx 45 kg (441N)

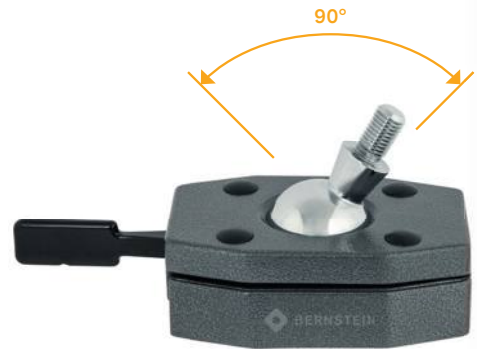

Position as shown  
 80 x 170 x 75 mm  
 (dimensions for orientation)



Weight 650 g

## VARIANTS

Included in delivery: schnorr washer, lock nut and lock nut for the thread.



Art-No.	9-281	9-281-SW	9-281-ESD	9-284	9-284-SW
Colour variation and coating	grey metallic	black matt	black, dissipative	grey metallic	black matt
Thread pin	M12 x 1.5 mm	M12 x 1.5 mm	M12 x 1.5 mm	M12 x 1.5 mm	M12 x 1.5 mm
Thread length	20 mm	20 mm	20 mm	20 mm	20 mm
Dissipative	-	-	10 <sup>7</sup> - 10 <sup>9</sup> Ohm	-	-
High performance magnets	-	-	-	✓	✓
Application specialty	BASIC	BASIC	SPECIALIST with earth connector button	Magnetic base for steel surfaces	Magnetic base for steel surfaces





## BALL JOINT HOLDER FOR HEAVY PARTS

Included in delivery: schnorr washer, lock nut and lock nut for the thread.

### ► Product family 9-291



For workbenches or tabletops with a maximum table thickness of 80 mm. The holder can be quickly and easily connect to any workbench or tabletop thanks to its smooth-running table clamp. A little pressure of the lever is enough and that the clamped workpiece can be fixed steplessly and in any practical working position.

Ball size: Ø 60 mm  
 Holding force: approx 45 kg (441N)  
 Clamping range: approx 80 mm



Position as shown  
 240 x 220 x 200 mm  
 (dimensions for orientation)



Weight 3000 g



### ► Product family 9-293/9-294/9-296



The holder can be screwed to the workbench through 4 through holes (space dimensions 152 x 151 mm), or it can be fixed to steel surfaces with 4 magnets. The 4 high-performance magnets with protective caps have a holding force of 32 kg horizontally and 15 kg vertically (magnets without caps). The magnets are firmly connected to the housing with screws. A drilling drawing can be downloaded from the website.

Ball size: Ø 60 mm  
 Holding force: approx 140 kg (1372N)



Position as shown  
 150 x 230 x 150 mm  
 (dimensions for orientation)



Weight 1850 g

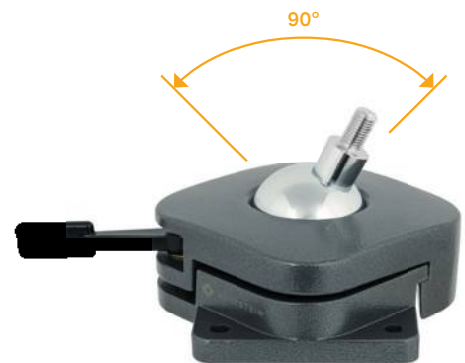

Art-No.	9-293	9-294	9-296
Colour variation and coating	grey metallic	black matt	black, dissipative
Thread pin	M12 x 1.5 mm	M12 x 1.5 mm	M12 x 1.5 mm
Thread length	Ø 20 mm	Ø 25 mm	Ø 20 mm
Application specialty	BASIC BIG	EXTRA with large pin	Magnetic base for steel surfaces



## BALL JOINT HOLDER SINGLE PARTS VARIO



All these accessories can be connected to the holders (base parts) via the M12 screw connection.

### Vice Head

Jaw width 50 mm, clamping pressure 1470 N  
clamping width 70 mm, clamping depth 38 mm  
Glued-in ESD conductive plastic jaws corrugated (waffle iron pattern)  
Dimensions for orientation 180 x 70 x 50 mm, weight 560 g



9-252

9-252 ESD

- ▶ **9-252** Colour dark gray metallic, surface structure
- ▶ **9-252 ESD** Colour black ESD dissipative  $10^7 - 10^8$  Ohm, EPA suitable

### ▶ 9-253-ESD PCB / Circuit Board Holder

two black ESD holders with suspension for sensitive circuit boards  
adjustable span up to 270 mm, with internal groove for a tight fit of the PCB  
Height of the support rods 70 mm, steel parts nickel-plated  
Dimensions for orientation 310 x 120 x 30 mm, weight 280 g

**stable assembly frame rotatable, PCB holder for SMD / THT  
fits on quick turn device 9-257 or angle adapter 9-255  
mostly used with 9-256 cover plate**



### ▶ 9-256 Cover plate ESD soft foam for THT equipment

is pushed from the right or left onto 9-253, so that the components to be soldered  
are held in the right place by the foam, so that after the circuit board holder has been  
turned all parts and components remain in their place  
Soft foam size 240 x 130 mm, thickness 20 mm  
ESD plastic, ESD foam, chrome-plated steel parts  
Overall dimensions for orientation 280 x 130 x 20 mm, weight 260 g

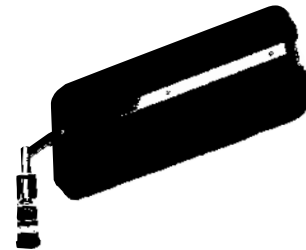

### ▶ 9-257-ESD Quick turn device for 9-253

enables the circuit board holder with the circuit board to be rotated by 180 ° at  
lightning speed without loosening an adjusting screw, stops automatically due to  
the rotation limiter, Color black ESD dissipative 107 - 108 Ohm, EPA suitable  
Orientation dimensions approx. 280 x 130 x 20 mm, weight 270 g



### ▶ 9-255-ESD Angle adapter turning circle extension

to expand the turning circle of the joint ball in the ball joint holder  
with easy-to-use adjusting screw for quick tightening and loosening  
Color black ESD dissipative 107 - 108 Ohm, EPA suitable  
Orientation dimensions approx. 100 x 55 mm, weight 95 g



### Universal machining plate to screw on

3 elongated holes 62 x 6 mm for fastening individual devices  
Slots for common standard screws up to M12  
for setting up stops, tuners, line transformers, prototypes and much more  
is also often used in woodworking  
Orientation dimensions Ø100 x 14 mm, weight 95 g

- ▶ **9-254** Colour dark gray metallic, surface structure
- ▶ **9-254-ESD** Colour black ESD dissipative  $10^7 - 10^8$  Ohm, EPA suitable



9-254

9-254-ESD

## ESD BALL JOINT HOLDER

Included in delivery: schnorr washer, lock nut and lock nut for the thread.



These ball joint holders have a dissipative surface with a leakage resistance between  $10^7 - 10^8$  Ohm Ohm. EPA suitable (for electrostatically protected areas, ESD workplace, ESD protection zone) for working on and with sensitive parts and components. The base sections can be connected to the grounding point on the back with a 10 mm push button.



Art-No.	9-251-ESD-SET1	9-261-ESD-SET1
Ball Joint Holder	9-251-ESD	9-261-ESD
9-343-1 ESD grounding cable 1 MOhm, 1.8 m	✓	✓
9-359-2 ESD Earthing plug 2 x 1 MOhm, screw connection M5 for 4 mm eyelet	✓	✓

## ESD BALL JOINT HOLDER VARIO

With the SPANNFIX VARIO, PCBs / circuit boards up to a length of 270 mm can be clamped. Thanks to the infinitely adjustable ball, the PCB can be positioned and held securely in all directions. Quick turning of the PCBs is possible thanks to the adapter. Very useful as a third hand when soldering or assembling, sensible clamping and holding device with quick release mechanism.

Thanks to the practical **cover plate\*** all inserted components are held in place when turning the PCB and can be soldered conveniently from the other side.



Art-No.	9-240-ESD	9-270-ESD	9-250-ESD
Ball Joint Holder	9-251-ESD	9-251-ESD	9-251-ESD
9-343-1 ESD grounding cable 1 MOhm, 1.8 m	✓	✓	✓
9-359-2 ESD Earthing plug 2 x 1 MOhm	-	-	-
9-253-ESD PCB Holder	✓	✓	✓
9-255-ESD Angular Adapter	✓	-	-
9-257-ESD Rapid turning device	-	✓	✓
9-256-ESD Cover Plate*	-	✓	-
9-252-ESD Vice head - jaws 50 mm	-	-	✓
9-254-ESD Universal screw-on plate	-	-	✓

# TERMS OF SALE AND DELIVERY

## GENERAL

The nature and scope of delivery are specified in the order confirmation. The following delivery terms shall apply to all deliveries to be carried out by us. Purchasing conditions of the customer do not oblige us, even if we do not expressly contradict this. Verbal or by intercom agreements made require our written confirmation. Obvious mistakes in offers, order confirmations, etc. are expressly reserved and can be considered at any time. We are entitled to process any data relating to the business relationship or in connection with the same concerning buyers, whether the buyer itself or third parties, within the framework of the Federal Data Protection Act.

## OFFER

Our offers are permissive, an order is deemed to be granted if confirmed by us in writing. PRICES, DELIVERY BASIS AND PACKAGING Unless otherwise agreed, the prices in Euros, ex works, are exclusive packaging. In the case of special packaging regulations of the customer, the additional costs involved are invoiced. Packaging is not accepted.

## DELIVERY

The delivery takes place at the expense and risk of the buyer without regard to who bears the freight costs. We reserve the right to place orders in partial deliveries. For custom-made products, excess or short deliveries of up to 10% are permitted.

## DELIVERY TIME

The delivery time begins upon receipt of all information required for the execution of the order. We endeavor to comply with the delivery time specified in the order confirmation. No claims of any kind can be asserted from a delayed delivery.

## COMPLAINTS

Complaints can only be accepted within 8 days after receiving of the goods.

The shape and colour of the tool may differ from the item shown in the catalogue.

## GUARANTEE

For all BERNSTEIN tools, which are unusable due to proven material or manufacturing defects, we deliver within one year after deliver a replacement. This free replacement service is excluded if the tools have become unusable due to natural wear or improper handling.

## DISCLAIMER

We do not assume any guarantee for the suitability of our products for the intended purpose of the customer. For damages caused by unsuitable or improper use, commissioning by the customer or third parties, and for the natural wear and tear we assume no guarantee. Any claims for damages, irrespective of the legal basis, as well as, in particular, the liability by tort (product liability) are excluded to the extent permitted by law.

## PAYMENT

Our invoices are payable 30 days net, unless otherwise agreed in the order confirmation.

## RESERVATION OF TITLE

We reserve the title to all goods delivered by us until the buyer has paid all claims arising from the business relationship. The buyer is entitled to resell the reserved goods in ordinary business transactions. In the case of resale, the buyer has to reserve the ownership of the sold goods on the same terms as his customer. The purchaser hereby assigns to us the purchase price claim against the buyer from the resale.

## FULFILLMENT AND JURISDICTION

Place of performance and jurisdiction for delivery and payment is Remscheid. In any case, only German law shall apply, with the exclusion of any foreign law.

## ONLINE DISPUTE RESOLUTION

The European Commission provides a platform for online dispute resolutions (ODR) which can be accessed at

<https://ec.europa.eu/consumers/odr/> .

In order to settle dispute arising from a contractual relationship with a consumer or from whether such a contractual relationship exists at all, we will participate in dispute settlement proceedings before a consumer dispute resolution body. Consumers can contact their national European Consumer Centre in this regard. The respective contact details of the individual ECCs can be found at

<https://www.evz.de/en/alternative-dispute-resolution/adr-in-eu-rope/>.



A little story about  
the word amber (BERNSTEIN)

The greek word for amber is „elektron“: the root of today's term electronics. Even the greeks discovered the special feature of amber: by rubbing the natural amber can be electrostatically charged. The charged stone can attract dust particles.

Today you can use this property to check the authenticity of an amber. If it is real, it can be tested through charge rubbing on a cotton cloth.

You can also wear it as jewellery:  
it should protect from evil magic and give joy of life.

Just like our high-quality BERNSTEIN ESD Tools - them protect against electrostatics and give joy with the daily work.

(Autor Max Walter Hartmut Blombach)

Где купить:  
ООО "КОМПАНИЯ ОПТУЛС"  
г.Москва, ул.Иловайская, д.3, стр.2  
Tel.: +7 (495) 646-00-96  
E-Mail: [sale@opttools.ru](mailto:sale@opttools.ru)  
Internet: [www.opttools.ru](http://www.opttools.ru)

**BERNSTEIN**

**Werkzeugfabrik  
Steinrücke GmbH**  
Industriehof Trecknase 1  
42897 Remscheid

Tel. + 49 (0) 2191 - 9650 - 0  
Fax + 49 (0) 2191 - 9650 - 30

[sales@bernstein-tools.de](mailto:sales@bernstein-tools.de)  
[www.bernstein-tools.de](http://www.bernstein-tools.de)