



TRADITION+INNOVATION



Made in the USA



○ **Confined Space Ventilation** ○

○ **Heaters** ○

○ **Air Conditioners** ○

○ **Work Tents & Shelters** ○

○ **Manhole Tools** ○

○ **Fall Arrest, Rescue & Retrieval** ○

○ **Gas Monitors** ○

*Started with a dream, a vision...*

*Continuing the tradition of excellence...*



**50 years of excellence and invention**

Brad Pelsue, CEO

It is hard to believe that it was 50 years ago that my dad took me down to the basement and told me of his plans to sell out of his partnership and begin his own business.

Then he proceeded to tell me that he had this great idea called a “Manhole Shield”.

You can imagine my reaction as a high school kid. “Dad has flipped out”.....”I’m never going to college”.

But that “Manhole Shield”, a Mobile Manhole Support Trailer, and a few other clever ideas got us on our way.

We patented the first quick-set up tent series, and followed it up with a long line of innovations for worker

safety and productivity.

In 2001 we acquired Uni-Hoist with it’s Davit System and patented Carbon Fiber Uni-Lite Tower.

Later we designed and patented the “LifeGuard” Manhole Retrieval system.

Last year we introduced a line of standby power products for specialty applications.

Keep watching. We will keep creating more solutions for today’s workers to keep them safer and help them be more productive than ever.

*Brad*

Check out Brad’s Blog



**Ventilators & Heaters 1**

<u>Ventilators</u>	2-5
<u>Heating and Cooling</u>	6-7
<u>Ventilation Accessories</u>	8-11
<u>Hazardous Location Basics</u>	16

**Manhole Tools 13**

<u>Shields &amp; Guards</u>	14-15
<u>Manhole Planks</u>	16
<u>Safety Work Lights</u>	17
<u>Submersible Pumps</u>	18
<u>Filter Socks</u>	18
<u>Duct Rodders</u>	19

**Portable Generators 21**

<u>5.5 KW</u>	22
<u>10 KW</u>	23

**Gas Monitors 26**

<u>Gas Monitors</u>	27
<u>Gas Monitor Accessories</u>	29-30

**Tents & Shelters 31**

<u>Ground Tents &amp; Shelters</u>	32-33
<u>Special Tents &amp; Shelters</u>	34-36

**Rescue & Retrieval 37**

<u>Davit Arms</u>	38
<u>Davit Accessories</u>	39-43
<u>Lifeguard</u>	44-45
<u>Tripod</u>	46
<u>Pole Hoist</u>	47
<u>Hoists</u>	48
<u>Winches</u>	49
<u>Hoist/Winch Brackets</u>	49
<u>SRL'S / SRL Brackets</u>	50

**Fall Arrest**

<u>UniLite Tower / TFAT</u>	52-53
<u>UniLite Bases</u>	54
<u>Harness</u>	55

**Commitment to Quality:**

Our goal is the pursuit of never-ending improvement in product quality and business systems.

Methods to be employed in attaining this goal will include new products quality planning, employee training, and utilization of employee involvement groups to solve problems.

In an increasingly competitive marketplace, ensuring customer satisfaction is one of the differentiators that sets you apart from the pack and yields a competitive advantage.

Therefore, we will support total customer satisfaction by implementing the ISO 9001 Quality System and providing the necessary atmosphere and training to nurture this concept throughout our organization.

We will make every business decision as though the quality of the part or service provided was destined for our own or our family's use. We will always think Quality First.

Every T.A. Pelsue Company employee is expected to commit to this philosophy in the performance of his or her daily tasks.

**Warranty:**

All Pelsue products are warranted against defects in materials and workmanship in accordance with their individual warranty statement. Warranty does not cover: normal wear & tear, modifications, improper storage, corrosion, or user neglect. Equally excluded from the warranty are damage due to accidents, negligence and uses for which the product was not designed.

**Order Entry:**

All orders accepted between the hours of  
7:00 am - 5:00 pm (MST) Monday - Friday  
Please call toll free 1-800-525-8460 (ext. 222)  
phone (303) 936-7432  
fax (303) 934-5581  
or email: sales@pelsue.com

**Order Cancellation:**

Cancellation charges will apply to all-custom and/or specially manufactured items.



<b>Propane Usage Chart</b>						
<b>Model</b>	<b>Heat Setting</b>	<b>psi Input</b>	<b>lbs/hr</b>	<b>20 lb. tank</b>	<b>40 lb. tank</b>	<b>BTU</b>
1557	Low	10	1/4	80 hrs.	160 hrs.	8,000
	High	10	1/2	40 hrs.	80 hrs.	16,000
1590	Normal	35	1 1/2	13 hrs.	26 hrs.	45,000
1690D	Normal	35	2 1/4	9 hrs.	18 hrs.	70,000

*\*Note: Results are based on in-house testing. Consumer results may vary.*

## **Many Uses of Confined Space Safety Equipment**

- Sewer Systems
- Storage Tanks
- Permit Spaces
- Ship Hulls
- Attics
- Rental Spaces
- Vaults
- Silos

(as defined by OSHA Standard 29 CFR 1910.146)

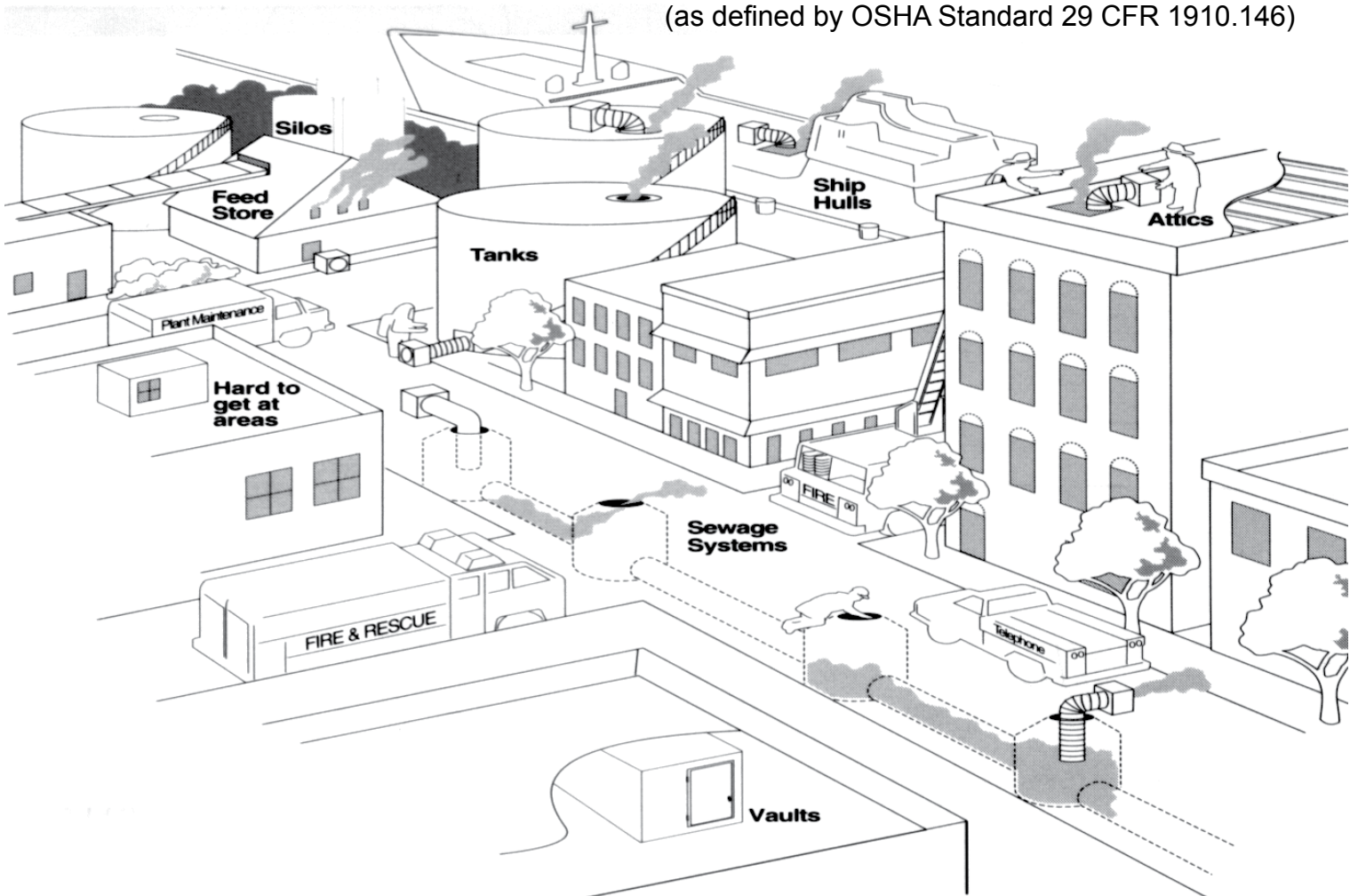

# ***Ventilators & Heaters***





Model:	1325P	1400P	Recommended Accessories
Power:	Electric - 1/3 HP, 120 VAC, 3 Amps	Electric - 1/4 HP 12 VDC, 15 Amps	AirPac 15/25
Certifications:	CSA, CEESI	CEESI	
Dimensions:	18"L x 14"W x 15"H	18"L x 14" W x 15"H	
Weight:	17 lbs.	17 lbs.	
Free Air (certified):	921 cfm	814 cfm	
w/ one 90° bend:	575 cfm	478 cfm	
w/ two 90° bends:	546 cfm	479 cfm	
Housing:	High Density Polyethylene	High Density Polyethylene	
Static Pressure:	1.87" W.C.	1.2" W.C.	
Air flow certified by CEESI with a 8" x 15' collapsible duct.			



Model:	1325D	1400D	Recommended Accessories
Power:	Electric - 1/3 HP, 120 VAC, 3 Amps	Electric - 1/4 HP 12 VDC, 15 Amps	3025A 2015HRT 2025HRT
Certifications:	CSA, CEESI	CEESI	
Dimensions:	14.5"L x 13"W x 14.5"H	14.5"L x 13"W x 14.5"H	
Weight:	19.5 lbs.	16.5 lbs.	
Free Air (certified):	1075 cfm	922 cfm	
w/ one 90° bend:	668 cfm	541 cfm	
w/ two 90° bends:	585 cfm	518 cfm	
Housing:	Formed Steel	Formed Steel	
Static Pressure:	2.09" W.C.	1.46" W.C.	
Air flow certified by CEESI with a 8" x 15' collapsible duct.			



Model:	1375D & 1385D	1475D & 1485D
Power:	Electric - 1/3 HP, 120 VAC, 3 Amps	Electric - 1/4 HP, 12 VDC, 15 Amps
Certifications:	CSA, CEESI,	CEESI
Dimensions:	37"L x 13"W x 14.5"H	37"L x 13"W x 14.5"H
Weight:	40 lbs.	40 lbs.
Certified Air Flow:	(15' hose) / (25' hose)	(15' hose) / (25' hose)
w/ one 90° bend:	668 cfm / 588 cfm	541 cfm / 492 cfm
w/ two 90° bends:	585 cfm / 553 cfm	518 cfm / 490 cfm
Static Pressure:	2.09" W.C.	1.46" W.C.
Air flow certified by CEESI with a 8" x 15' & 25' collapsible duct.		



Model:	1375P & 1385P	1475P & 1485P
Power:	Electric - 1/3 HP, 120 VAC, 3 Amps	Electric - 1/4 HP, 12 VDC, 15 Amps
Certifications:	CSA, CEESI,	CEESI
Dimensions:	37"L x 13"W x 14.5"H	37"L x 13"W x 14.5"H
Weight:	36 lbs.	36 lbs.
Certified Air Flow:	(15' hose) / (25' hose)	(15' hose) / (25' hose)
w/ one 90° bend:	575 cfm / 541 cfm	478 cfm / 439 cfm
w/ two 90° bends:	546 cfm / 544 cfm	479 cfm / 432 cfm
Static Pressure:	1.87" W.C.	1.20" W.C.
Air flow certified by CEESI with a 8" x 15' & 25' collapsible duct.		

## ATTENTION

See pages 10-11 for available ducting for our various Axial Ventilators.

**Model:** Super 12  
 Power: Electric - 1/2 HP TEAO  
 115 VAC, 8/4 Amps  
 RPM: 3450  
 Dimensions: 13"D x 15"W x 15.5"H  
 Weight: 40 lbs.  
 Shroud CFM: 2750 cfm  
 Venturi CFM: 3700 cfm



**Model:** Super 12 EX  
 Power: Electric - 1/2 HP TEAO  
 115 VAC, 8/4 Amps  
 RPM: 3450  
 Dimensions: 13"D x 15"W x 15.5"H  
 Weight: 40 lbs.  
 Shroud CFM: 2750 cfm  
 Venturi CFM: 3700 cfm

**Model:** Super 16  
 Power: Electric - 1/3 HP TEAO  
 115/230 VAC, 5.8/2.9 Amps  
 RPM: 1725  
 Dimensions: 13"D x 18.75"W x 19.25"H  
 Weight: 44 lbs.  
 Shroud CFM: 3200 cfm  
 Venturi CFM: 5200 cfm



**Model:** Super 16 EX  
 Power: Electric - 1/3 HP HAZLOC  
 115/230 VAC, 5.8/2.9 Amps  
 RPM: 1725  
 Dimensions: 16"D x 18.75"W x 19.25"H  
 Weight: 47 lbs.  
 Shroud CFM: 3200 cfm  
 Venturi CFM: 5200 cfm

**Model:** Super 24  
 Power: Electric - 1-1/2 HP  
 115/230 VAC, 20 Amps  
 RPM: 1725  
 Dimensions: 18.75"D x 28"W x 28.5"H  
 Weight: 110 lbs.  
 Shroud CFM: 8600 cfm  
 Venturi CFM: 10,800 cfm



**Model:** Super 24 EX  
 Power: Electric - 1-1/2 HP  
 115/230 VAC, 20 Amps  
 RPM: 1725  
 Dimensions: 18.75"D x 28"W x 28.5"H  
 Weight: 115 lbs.  
 Shroud CFM: 8600 cfm  
 Venturi CFM: 10,800 cfm

- **“EX” Designates Explosion Proof**
- **“HF” Designates High Flow**
- **Available in European Voltage**

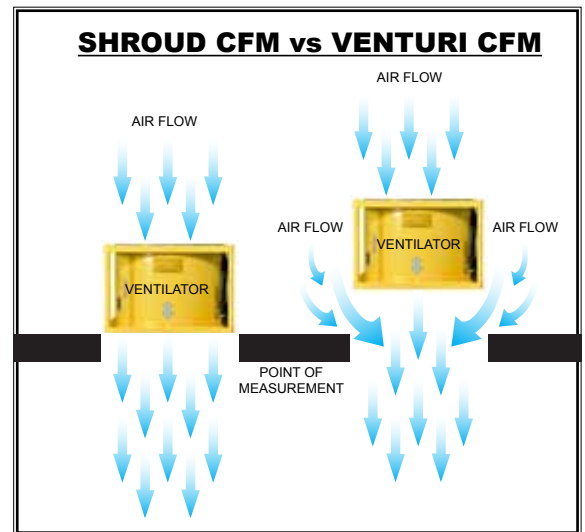

## ATTENTION

**See page 11, “Super Axial Ducts” for available ducting for all Super Axial Ventilators.**

### ELECTRIC POWERED



Spark Resistant



Model	1000	Recommended Accessories
Power:	Electric - 1/3 HP 1725 RPM, 60 Hz 120 VAC, 6.2 Amps	2015HRT 3015P
Certifications:	CSA, CEESI	
Dimensions:	15.25"L x 14.63"W x 15"H	
Weight:	35 lbs.	
Free Air (certified):	1068 cfm	
w/ one 90° bend:	924 cfm	
w/ two 90° bends:	807 cfm	
Housing:	Formed Steel	
Static Pressure:	2.27" W.C.	



Model	1240 (2-speed ventilator)																																		
	<table border="1"> <thead> <tr> <th>Low</th> <th>High</th> </tr> </thead> <tbody> <tr> <td>Power:</td> <td>Electric - 1 HP</td> </tr> <tr> <td></td> <td>1725 RPM, 60 Hz</td> </tr> <tr> <td></td> <td>120V AC, 12 Amps</td> </tr> <tr> <td>Certifications:</td> <td>CSA, CEESI</td> </tr> <tr> <td>Dimensions:</td> <td>18.5"L x 18.5"W x 17.5"H</td> </tr> <tr> <td>Weight:</td> <td>54 lbs.</td> </tr> <tr> <td>Free Air (certified):</td> <td>790 cfm</td> </tr> <tr> <td>w/ one 90° bend:</td> <td>526 cfm</td> </tr> <tr> <td>w/ two 90° bends:</td> <td>506 cfm</td> </tr> <tr> <td>Housing:</td> <td>Formed Steel</td> </tr> <tr> <td>Static Pressure:</td> <td>0.82" W.C.</td> </tr> <tr> <td></td> <td>1193 cfm</td> </tr> <tr> <td></td> <td>810 cfm</td> </tr> <tr> <td></td> <td>805 cfm</td> </tr> <tr> <td></td> <td>Formed Steel</td> </tr> <tr> <td></td> <td>1.93" W.C.</td> </tr> </tbody> </table>	Low	High	Power:	Electric - 1 HP		1725 RPM, 60 Hz		120V AC, 12 Amps	Certifications:	CSA, CEESI	Dimensions:	18.5"L x 18.5"W x 17.5"H	Weight:	54 lbs.	Free Air (certified):	790 cfm	w/ one 90° bend:	526 cfm	w/ two 90° bends:	506 cfm	Housing:	Formed Steel	Static Pressure:	0.82" W.C.		1193 cfm		810 cfm		805 cfm		Formed Steel		1.93" W.C.
Low	High																																		
Power:	Electric - 1 HP																																		
	1725 RPM, 60 Hz																																		
	120V AC, 12 Amps																																		
Certifications:	CSA, CEESI																																		
Dimensions:	18.5"L x 18.5"W x 17.5"H																																		
Weight:	54 lbs.																																		
Free Air (certified):	790 cfm																																		
w/ one 90° bend:	526 cfm																																		
w/ two 90° bends:	506 cfm																																		
Housing:	Formed Steel																																		
Static Pressure:	0.82" W.C.																																		
	1193 cfm																																		
	810 cfm																																		
	805 cfm																																		
	Formed Steel																																		
	1.93" W.C.																																		

\*All models have the ability to extract air with a built in suction adaptor



## ***GASOLINE POWERED***

<b>Model</b>	<b>1450</b>	<b>1453</b>
	(Briggs & Stratton)	(Honda)
Power:	Gasoline - 3.5 HP 3600 RPM	Gasoline - 4 HP 3600 RPM
Certifications:	CEESI	CEESI
Dimensions:	18.5"L x 15.25"W x 16"H	18.5"L x 15.25"W x 16"H
Weight:	55 lbs.	55 lbs.
Free Air (certified):	1526 cfm	1526 cfm
w/ one 90° bend:	1360 cfm	1360 cfm
w/ two 90° bends:	1255 cfm	1255 cfm
Housing:	Formed Steel	Formed Steel
Static Pressure:	5.71" W.C.	5.71" W.C.



- Certified up to 200' hose (900 cfm)
- Models available in diesel or compressed air, consult factory for details

\*All air flows certified by **CEESI** using a 8" x 15' collapsible duct.

## ***EXPLOSION PROOF***

<b>Model</b>	<b>1000E</b>
Power: Single Speed	Electric - 1/3 HP 1725 RPM, 60 Hz 120V AC, 6.2 Amps
Certifications:	CEESI
Dimensions:	15"L x 21"W x 15"H
Weight:	45 lbs.
Free Air (certified):	1068 cfm
w/ one 90° bend:	924 cfm
w/ two 90° bends:	807 cfm



Plug is not provided with this product  
(Please review "Hazardous Location Basics" on page 12)

\*All models have the ability to extract air with a built in suction adaptor

# Heating

## MANHOLE / HEATERS / BLOWERS

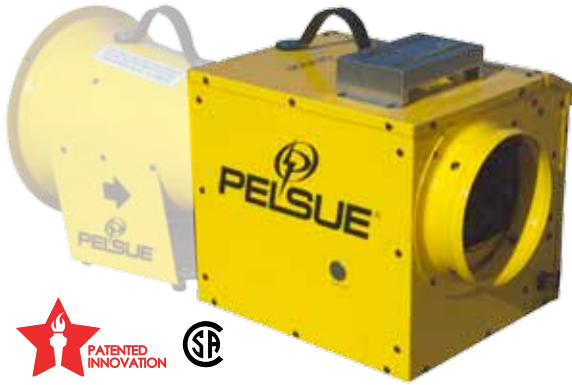

Model	1690D
Power:	120 VAC, 1 Amp
Certifications:	CSA, CEESI
Dimensions:	18.5"L x 13.5"W x 15.25"H
Weight:	30 lbs.
Certified Air Flow:	(coupled w/1325D)
Free Air:	639 cfm
w/ one 90° bend:	532 cfm
w/ two 90° bends:	498 cfm
BTUs	70,000
Propane Usage:	2.25 lbs./hr.

Recommended Accessories
2015HRT
3025A
1590F

\*Available in European Voltage (50Hz)



**All-In-One** Heater & Blower in one single unit



Model	1590
Power:	120 VAC, 4 Amps
Certifications:	CSA, CEESI
Dimensions:	27"L x 14.5"W x 14"H
Weight:	47 lbs.
Free Air (certified):	424 cfm
w/ one 90° bend:	380 cfm
w/ two 90° bends:	366 cfm
BTUs	45,000
Propane Usage:	1.5 lbs./hr.

Recommended Accessories
2015HRT
3025A
1590F

\*Available in European Voltage (50Hz)

**Model 1690D**, when coupled with the 1325D Axial Ventilator, provides fresh warm air for all your confined space needs. This unit is propane fired and electrically powered. Requires the model 1325D Ventilator to operate. A Remote Thermostat Control (Model 1620) is also available.

**Model 1590**, one-piece, Axial Propane Heater/Blower, provides fresh warm air. It is extremely efficient requiring only 45,000 BTU's of input to get a 125° heat rise. Certified for ventilating confined spaces with or without heated fresh air via air ducts. This model is available in both North American and European voltages.

## TENT HEATERS



**\*Infrared Heater\***

Model	1557
Power:	N/A
Certifications:	CSA
Dimensions:	13"L x 9.5"W x 20"H
Weight:	11 lbs.
BTU's:	8,000 -16,000
Propane Usage - low:	0.25 lbs./hr. (low setting)
Propane Usage - high:	0.50 lbs./hr. (high setting)
Included:	10' hose

Recommended Accessories
1590-FB, 1st stage regulator

The Model 1557 is a radiant style, portable, infrared construction heater. It is adjustable from 8,000 to 16,000 BTU's. This patented design provides clean, efficient heat for Pelsue work tents or any other ventilated space. Safety features include thermal sensor and tip over protection. No electrical power is required.

**No Electric Power Needed**





## AC4T Portable Air Conditioner

For use in emergency response shelters for Fire, Police, Hazmat crew in bioterror and mass casualty incidents. Delivers adequate ventilation for Manholes and Confined Spaces where cool air is needed for a sustainable work environment.



Trailer Mounted Units Available



<b>Model</b>	<b>AC4T</b>
Power:	240V AC, 60Hz, 25 AMP
Dimensions:	62"H x 30.5"W x 41.5"D
Weight:	460lbs
Air Flow	2140 cfm
w/ one 90° bend:	1269 cfm
w/ two 90° bends:	1228 cfm
Air Temp. Difference:	20°-30° F
Cooling Capacity:	48,000 BTU

### **Recommended Accessories**

2120-N Hose



# Heating and Cooling Accessories

Prevent  
LPG  
freeze up



## LPG Bottle Warmer

**Model 9651** Bottle Warmer, safely prevents propane bottles from freezing! It is a silicon rubber belt with interlaced heating elements. Built in safeties including a set operating temperature, to prevent over pressurization This model is equipped with a protective UL recognized thermostat & is CSA Approved. Includes a 12' type HPN heater cord set. Folds for easy storage. For use on either 20 lb.. or 40 lb.. bottles. 375 Watts.



## Filter Regulator for Heaters

**Model 1590-F** Filter/Regulator/Gauge, is a compact unit that fits into the LP gas line behind the tank valve to filter out impurities and regulate the bottle pressure to a safe working pressure. The POL Excess Flow Valve will shut down fuel flow to down stream equipment in the event of a regulator fire or ruptured hose. Hose lengths are available from 6' (1.82 m) to 25' (7.62 m).



## Remote Thermostat

**Model 1625** For use w/1690D Heater. Allows heater to cycle on & off at user-adjusted temperatures while maintaining continuous, uninterrupted ventilation.

# Ventilation Accessories

## Cable Drying Windbag-Model 7000

The 7000 Series is a cable drying “windbag” used with all Pelsue heaters and blowers to dry wet cables fast! Full length zipper openings make installation of the Windbag easy and allow quick cable inspection at any time. Strategically placed vents provide even drying of all areas of the splice. The permanently installed web straps and buckles at all ends of the Windbag ensures a snug closure around the cable. Expansion sections are available for large diameter cable, or for joining Windbags end to end. The Windbag’s flame resistant fabric meets CPAI-84 standard.



Item #	Description
<b>Model 7000</b>	Cable Drying Windbag with steel hose-to-hose connector (item # 2100, pg. 10)
<b>Model 7100</b>	Expands the diameter of model 7000 by zipping to it, allowing it to wrap around larger cable bundles.
<b>Model 7300</b>	Same as model 7000 with the addition of zippers at each end allowing the ability to join two together end to end.
<b>Model 7400</b>	Expands the diameter of model 7300 by zipping to it, allowing it to wrap around larger cable bundles, while maintaining the ability to join two together end to end.

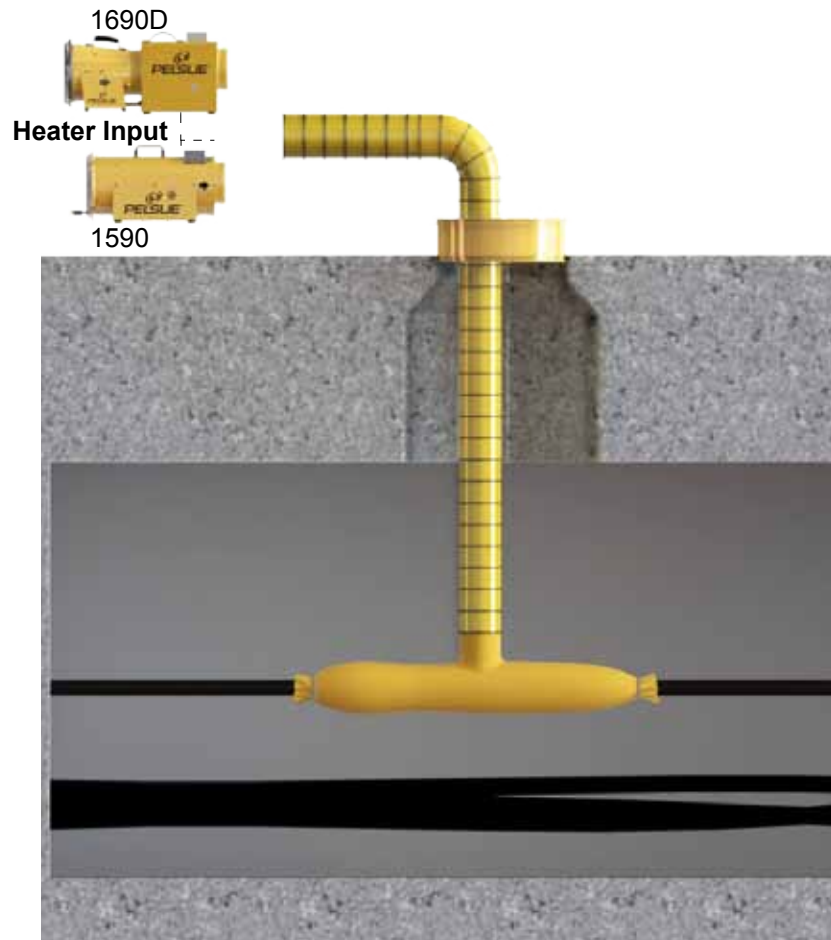



## “AirPac” Series Hose & Canister

The AIRPAC series is a molded polyethylene canister and hose combination, which attaches to the 1325P & 1400P ventilators. The AIRPAC15 includes a 15 ft hose. The AIRPAC25 includes a 25 ft hose. Add the letter “S” to the end of the model number to include the “Spacemaker” hose.

## Ventilator Hoses

Three styles of high quality 8” dia. ventilation hose: Hoses have a tension buckle & strap at one end. Made of Polyester with neoprene coating (HRT) Heat Reaction (No Heat)

### Model #      Description

<b>8” Hoses</b>	<b>Glued</b>
<b>2015HRT</b>	Standard Wt., 15’ L
<b>2025HRT</b>	Standard Wt., 25’ L

<b>8” Hoses</b>	<b>Sewn</b>	<b>Recommended Accessories</b>
<b>2015HD</b>	Heavy Duty Wt., 15’ L	
<b>2025HD</b>	Heavy Duty Wt., 25’ L	
<b>2006-N</b>	Insulated, 6’ L	
<b>2015-N</b>	Insulated, 15’ L	3035A
<b>2025-N</b>	Insulated, 25’ L	3135A

<b>12” Hoses</b>	<b>Sewn</b>	<b>Recommended Accessories</b>
<b>2120-N</b>	Insulated, 20’ L	3135A

## Conductive Ventilator Hose

They are supplied with cuff and attachment hardware and lug for grounding.

<b>Model #</b>	<b>Diameter</b>	<b>Length</b>
<b>2015EX</b>	8”	15’
<b>2025EX</b>	8”	25’
<b>2050EX</b>	8”	50’



## Hose to Hose Connector

Our Hose to Hose Adapters, are easily installed to securely combine lengths of 8” or 12” diameter ventilator hoses.

<b>Model #</b>	<b>Description</b>	<b>Diameter</b>	<b>Length</b>
<b>2100</b>	Steel	8”	8”
<b>2112</b>	Steel	12”	12”



# Ventilation Accessories

## Suction Adaptor

**Model 3003P** Suction adaptor attaches to the intake side of the 1325 & 1400 series ventilators, so that you may attach an 8" diameter hose to provide suction.

Used for smoke/dust/fume removal only



## Hose Storage

**Model 3015P** - Constructed of a durable, weather resistant, high-impact polyethylene plastic, and will hold 2015EX & HRT model hoses.



## "Pel Can" Hose Storage

Steel construction, and coated with a weather resistant, safety yellow powder coat finish.

Model	Size	Holds
<b>3025A</b>	12" X 36"	15' & 20' HRT & 2015HD, & 2015N
<b>3035A</b>	12" X 47"	2025HD (Will also hold 2 - 25' HRT hoses)
<b>3135A</b>	16" X 47"	2120N Hose



## Super Axial Spiral Ducts

Super Axial ducts are high quality hoses made with heavy duty wear strips and two-ply construction. Ideal for moving large quantities of air into hard to reach places. Available with an adaptor as shown (AD). Extension pieces also available without adaptor (RC2). Each duct comes complete with it's own storage bag.

Model	Diameter	Length
<b>12X20AD</b>	12"	20'
<b>16X20AD</b>	16"	20'
<b>24X20AD</b>	24"	20'
<b>12X20RC2</b>	12"	20'
<b>16X20RC2</b>	16"	20'
<b>24X20RC2</b>	24"	20'

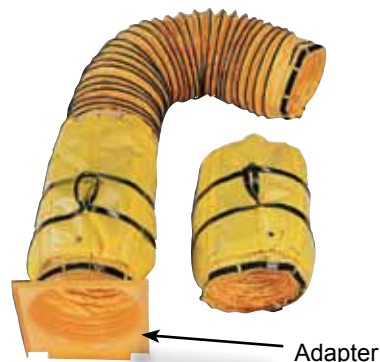

## "SpaceMaker" Series Ventilator Hoses

Our SpaceMaker hose allows unrestricted, continuous ventilation during entry and egress of a confined space. There are no accessory parts. Stores in a regular hose canister. Hoses are 8" (20 cm) in diameter and are available in 15' (4.57 m) (model SpaceMaker15) or 25' (7.62 m) (model SpaceMaker25) lengths. Note: not for use with heated air above 250°.



# Hazardous Location Basics

## Hazardous Location

An area where the possibility of explosion and fire is created by the presence of flammable gases, vapors, dusts, fibers, or flyings.

### Class I (NEC-500-5)

Those areas in which flammable gases or vapors may be present in the air in sufficient quantities to be explosive or ignitable.

### Class II (NEC-500-6)

Those areas made hazardous by the presence of combustible dust.

### Class III (NEC-500-7)

Those areas in which there are easily ignitable fibers or flyings present, due to type of material being handled, stored, or processed.

### Division 1 (NEC-800-5, 6, 7)

Division One in the normal situation, the hazard would be expected to be present in everyday production operations or during frequent repair and maintenance activity.

### Division 2 (NEC-500-5, 6, 7)

Division One in the abnormal situation, material is expected to be confined within closed containers or closed systems and will be present only through accidental rupture, breakage or unusual faulty operation.

### Groups (NEC-500-3)

The gases and vapors of Class I locations are broken into four groups by the code A, B, C, and D. These materials are grouped according to the ignition temperature of the substance, its explosion pressure, and other flammable characteristics.

### Class II-Dust locations-groups E, F, and G.

These groups are classified according to the ignition temperature and the conductivity of the hazardous substance.

### Seals (NEC-501-5 & 502-5)

Special fittings that are required either to prevent the passage of hot gases in the case of an explosion in a Class I area or the passage of combustible dust, fibers, or flyings in a Class II or III area.

## Articles 500 - 503 (1987 NEC)

Explains in detail the requirements for the installation of wiring or electrical equipment in hazardous locations. These articles along with other applicable regulations; local governing inspection authorities, insurance representatives, and qualified engineering/technical assistance should be your guides to the installation of wiring or electrical equipment in any hazardous or potentially hazardous location.

### Typical Class I Locations:

- Petroleum refineries, and gasoline storage and dispensing area.
- Industrial firms that use flammable liquids in dip tanks for parts cleaning or other operations.
- Petrochemical companies that manufacture from gas and oil.
- Dry-cleaning plants where vapors from cleaning fluids can be present.
- Companies that have spraying areas where they coat products with paint or plastics.
- Aircraft hangers and fuel servicing areas.
- Utility gas plants, and operations involving storage and handling of liquefied petroleum gas or natural gas.

### Typical Class II Locations:

- Grain Elevators, flour and feed mills.
- Plants that manufacture, use or store magnesium or aluminum powders.
- Plants that have chemical or metallurgical processes...producers of plastics, medicines, and fireworks, etc.
- Producers of starch or candies.
- Spice-grinding plants, sugar plants, and cocoa plants.
- Coal preparation plants and other carbon-handling or processing areas.

### Typical Class III Locations:

- Textile mills, cotton gins, cottonseed mills, and flax processing plants.
- Any plant that shapes, pulverizes, or cuts wood and creates sawdust or flyings.

### Note:

Fibers and flyings are not likely to be suspended in the air, but can collect around machinery or on lighting fixtures and where heat, sparks, or hot metal can ignite them.

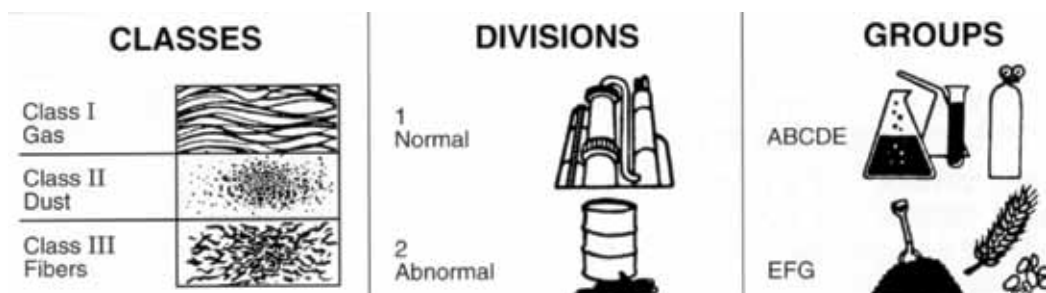



# **Manhole Tools**



# Manhole Tools

## Aluminum Manhole Shields

43% lighter than steel! Lightweight 6061-T6 Aluminum. All models are reversible to fit both standard 27" & 30" manholes and are available in 8" or 12" heights. No clamps or sealing compounds needed - a water-tight seal is formed by inflating

the tube to 5-10 lbs of air or nitrogen. All sizes are stackable to maintain a dry opening in flooding conditions. Custom sizes are available upon request.



Model 2730-8A

Model #	Description	Weight
<b>2730-8A</b>	(27" or 30" dia.) 8" High	17 lbs
<b>2730-12A</b>	(27" or 30" dia.) 12" High	20 lbs
<b>3336-12A</b>	(33" or 36" dia.) 12" High	24 lbs
<b>2750</b>	Inner Tube Replacement	2 lbs

\*Custom sizes available



Model 2730-12A



Shields are stackable for increased height

## Manhole Guards

For rescue and retrieval, view the LifeGuard systems on pages 44 & 45

These lightweight, rugged steel or aluminum safety fences provide a rigid and highly visible traffic barrier around open manholes. They help eliminate wind hazards when used with

a manhole weather tent. Model 4000AL clamps securely to the Pelsue manhole shield. Model 4000A is available with locking arms.



Model 4000AL



Model 4000A

Model #	Description (HxWxD)	Weight	Material
<b>4000A</b>	42" x 32-1/4" x 32-1/4"	39 lbs.	Steel
<b>4000AL</b>	42" x 31-3/8" x 32-3/8"	22 lbs.	Aluminum

## Pel Protector - for Manhole Shield



**Model 2760**, is a lightweight, molded fiberglass protector for manhole shields. It protects workers from falling objects and debris, without obstructing ventilation or emergency escapes. Works on either 27" (68.5 cm) or 30" (76 cm) sides of standard manhole shields. Lightweight and easily removable. Constructed with very strong fiberglass, can hold the weight of an average man, yet only weighs 9-1/2 lbs. (4.3 kg).



## Manhole Lid Lifters

**Model 2775** weighs only 12.5 lbs.(5.6 kg) and has a special handle to allow for a better grip. It is also designed to remove ice or dirt by using the built-in scraper.

This model features a heat treated hook that can lift manhole covers which are equipped with a hole. The hook locks in the handle when not in use.

**Model 2775C** is identical to model 2775 but features a chain and hook.



**Model 2775**



**Model 2775C**

# Manhole Tools



## Scaffold Planks

## 500lb. Load Rating

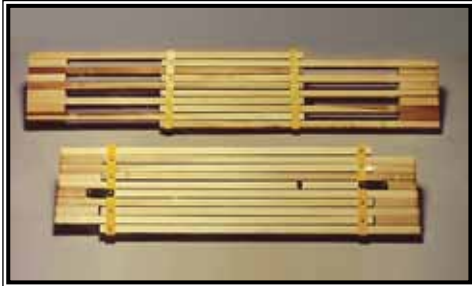

Manhole scaffold planks are constructed from strong hardwood with heavy-duty, steel hardware and bolt through construction. Safety latches are included on expandable units at both ends to prevent accidental opening.

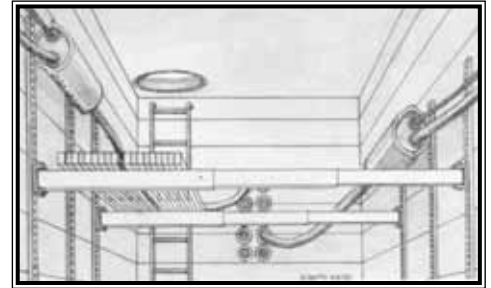

Model	Description	Weight	Load Rating	Recommended Accessories
9504P	Clear grain hardwood, expandable from 4' - 6'	21 lbs.	500 lbs.	125743-001 Securing Straps
9506P	Clear grain hardwood, expandable from 6' - 9.5'	31 lbs.	500 lbs.	

## Scaffold Plank Supports

Pelsue's model 309 Telecom & 310 Power Utility manhole plank supports are expandable from 42" (1.06 m) to 108" (2.74 m). They are aluminum and weight 13 lbs. (5.9 kg). They are rated at 500 lbs. (227 kg) each support.

- Telescoping support members are designed for lightweight easy handling
- Featuring lightweight, non-corrosive 6061-T6 Aluminum construction
- Positive locking end hangers clamp into existing cable racks
- End hangers are coated with zinc plating to prevent corrosion

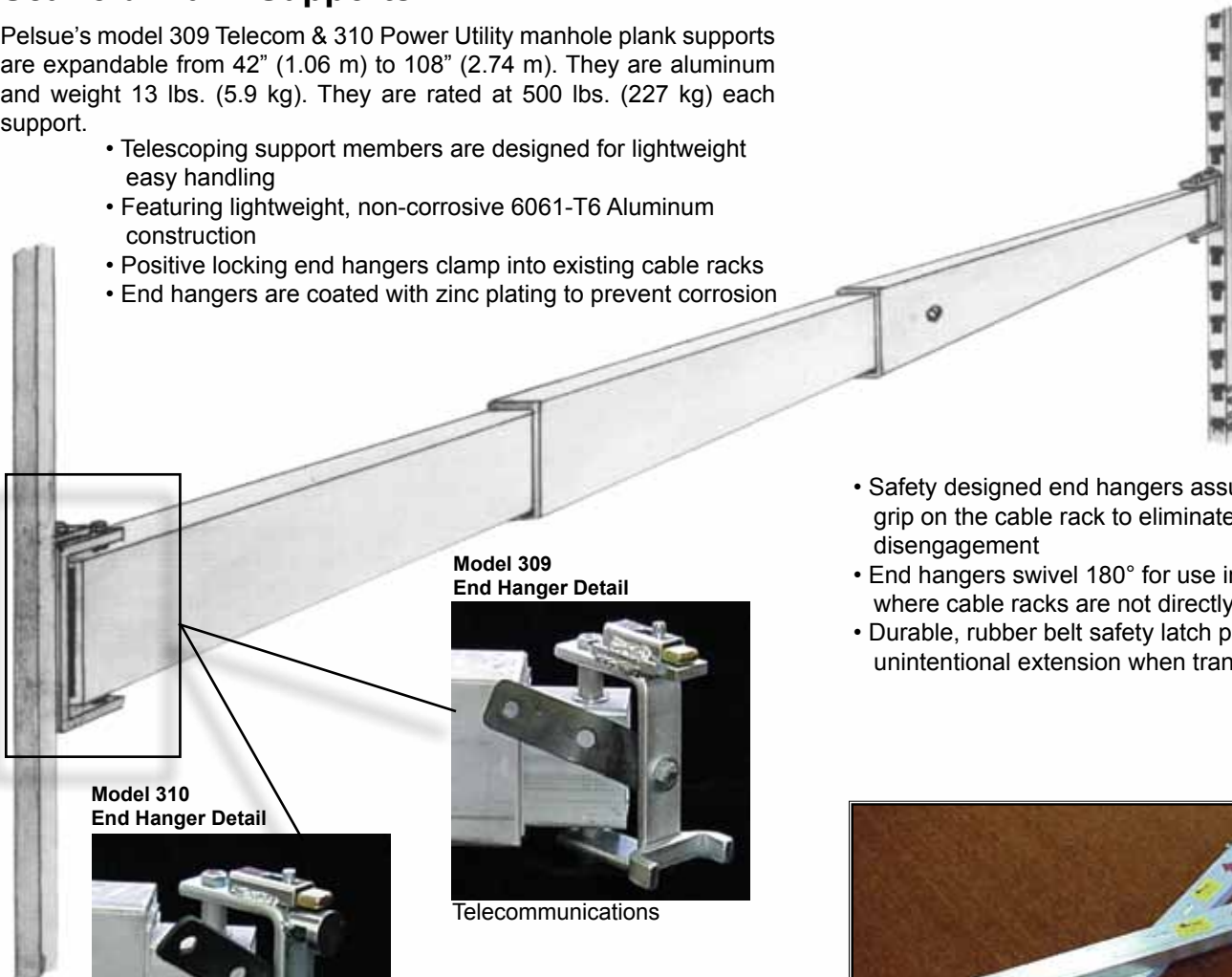

Model 309  
End Hanger Detail



Telecommunications

Model 310  
End Hanger Detail



Electric Utility

- Safety designed end hangers assures a firm grip on the cable rack to eliminate accidental disengagement
- End hangers swivel 180° for use in locations where cable racks are not directly opposite
- Durable, rubber belt safety latch prevents unintentional extension when transporting

Made in USA, 500 lb. rated each  
Meets OSHA Standards



# Manhole Tools

Pel-Brite work lights are rugged and shock protected against dropping or falling, and are precision engineered from non-breakable, noncombustible materials. Designed for dependable service under extreme conditions. Cool to the touch, easy on the eyes, and color corrected. Available in 120 volt AC or 12 volt DC. Standard lamps are 8, 15, 20, 30, and 40 watt and come with either 25 or 50 foot cords.

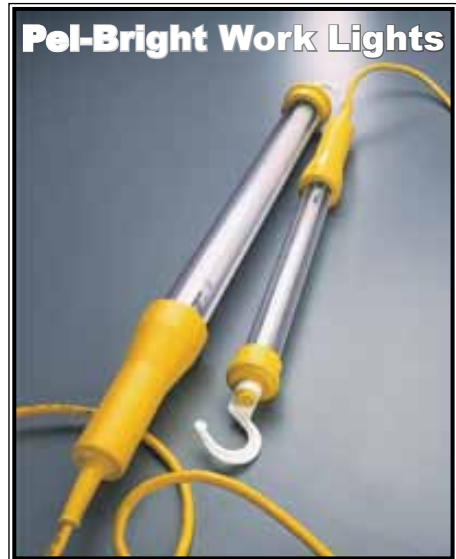

Model	120 Volt AC Description	Weight
<b>8-1525</b>	15 Watt, 26.5" L, 25' cord	5 lbs
<b>8-1550</b>	15 Watt, 26.5" L, 50' cord	6 lbs
<b>8-2025</b>	20 Watt, 32" L, 25' cord	7 lbs
<b>8-2050</b>	20 Watt, 32" L, 50' cord	8 lbs
<b>8-3025</b>	30 Watt, 45" L, 25' cord	9 lbs
<b>8-3050</b>	30 Watt, 45" L, 50' cord	10 lbs
<b>8-4025</b>	40 Watt, 56" L, 25' cord	11 lbs
<b>8-4050</b>	40 Watt, 56" L, 50' cord	12 lbs

\* Water resistant seal - can NOT be submerged in water

## HAZARDOUS LOCATION

### Intrinsically Safe Design features:

- No exposed metal
- No charge contacts; uses induction charging
- Waterproof; lantern is buoyant
- 10 Hours run time
- One-handed release from charging base
- Vertical or horizontal use with rotating and pivoting head to easily position towards work area.
- Trigger-activated front LED lens and rear signal lights

### Specifications:

#### Lamp:

- Luxeon® Rebel ES LEDs: 405 Lumens
- Medium Spot/Flood Pattern
- 340° Rotating head with 70° pivoting angle
- Six Rear Blue Signaling Lights have five light patterns:
- On, Off, Flash, Rotating, SOS (rear and front)



Model	Description	Dimensions	Weight
<b>8-6VEX</b>	PelBrite Lantern	12.25" L x 5.5" Outer Dia.	6.5 lbs. (9 lbs. with charging station)



Model	120 Volt AC Description	Weight
<b>26W25EX</b>	26 Watt, 25' cord	11 lbs
<b>26W50EX</b>	26 Watt, 50' cord	15 lbs

### Hazardous Locations Lights

Pel-Brite work lights are rugged and shock protected against dropping or falling, and are precision engineered from non-breakable, noncombustible materials. Designed for dependable service under extreme conditions. Cool to the touch, easy on the eyes, and color corrected.

This safety light is designed for hazardous locations. Cord, ballast and lamp are FM and CSA approved for:

- Class I, DIV 1 & 2, Groups C & D,
- Class II, DIV 1 & 2 Groups E, F, & G,
- Class III, DIV 1 & 2

as defined by the Article 500 of the National Electrical Code. Pel Bright Work Lights are water tight to meet N.E.M.A. 4 Standard.



# Manhole Tools

## SUBMERSIBLE PUMPS

ALL Submersible pumps come ready to use, equipped with coupler, rope, & power-cord



### Ready Series (FLYGT)

Model:	Ready-4	Ready-8
Discharge	2.0"	2.0"
Rated Output	0.6 HP	1.15 HP
Full Load Amps	5.5 A	9.8 A
Volts	115 V	115 V
Pump Dimensions	7-5/16" W x 16-3/8" H	7-5/16" W x 17-3/4" H
Weight	20 lbs.	25 lbs.
Maximum Capacity	60 GPM	90 GPM



### PF2000 Series (Power-Flo)

Model:	PF20111	PF27112
Discharge	2.0"	3.0"
Rated Output	2 HP	2.75 HP
Locked Rotor Amps	92.4A	52.6A
Full Load Amps	23.3A	12.5A
Voltage/Phase	115 V, Single Phase	230 V, Single Phase
Pump Dimensions	7.4" W x 18" H	7.3" W x 18" H
Weight	49.5 lbs.	49.5 lbs.
Max. Head	73 ft.	50 ft.
Maximum Capacity	175 GPM	300 GPM



### PM Series (Multiquip)

Model:	PM-4010	PM-4020
Discharge	2.0"	2.0"
Rated Output	1/2 HP	1.0 HP
Starting Amps	41 A	63 A
Running Amps	8 A	12.5 A
Voltage/Phase	115V, Single Phase	115 V, Single Phase
Pump Dimensions	6.7" W x 18.4" H	6.7" W x 20" H
Weight	38 lbs.	55 lbs.
Max. Head	42 ft.	55 ft.
Maximum Capacity	85 GPM	95 GPM

## CENTRIFUGAL PUMPS

ALL Centrifugal pumps come equipped with couplers, needs to be wired for power & permanently mounted to a solid structure



PF10CCE-1

### PF3CCE Series (Power-Flo)

Model: (Self-priming)	PF10CCE-1	PF3CCE-1
Discharge	2.0"	1.5"
Rated Output	5 HP	1.5 HP
Locked Rotor Amps	24 A	13 A
Full Load Amps	23 A	6.5 A
Voltage/Phase	208-230 V, Single Phase	115/230 V, Single Phase
Pump Dimensions	20.5" W x 12" H	18.58" W x 11" H
Weight	165 lbs.	91 lbs.
Max. Head	124ft.	82 ft.
Maximum Capacity	195 GPM	90 GPM



PF3CCE-1

## FILTER SOCKS



Model	Description	Hose Size/Coupler
<b>B085F2</b>	Bucket	8" dia. x 5' long, 2" female coupler quick connect
<b>B088F2</b>	Bucket	8" dia. x 8' long, 2" female coupler quick connect
<b>T085F2</b>	Poly Tube	8" dia. x 5' long, 2" female coupler quick connect
<b>T088F2</b>	Poly Tube	8" dia. x 8' long, 2" female coupler quick connect
<b>T168F2</b>	Poly Tube	16" dia. x 8' long, 2" female coupler quick connect

## HOSES



PVC hose

Model	Description	Hose Size/Coupler	Weight
<b>103171-002</b>	PVC hose	1.5" x 25 ft, male/female couplers	8 lbs. (3.62 kg)
<b>103172-002</b>	PVC hose	2.0" x 25 ft, male/female couplers	10 lbs. (4.53 kg)
<b>103174-002</b>	PVC hose	3.0" x 25 ft, male/female couplers	14 lbs. (6.35 kg)
<b>103176-002</b>	Mill hose	1.5" x 25 ft, male/female couplers	11 lbs. (4.98 kg)
<b>103177-002</b>	Mill hose	2.0" x 25 ft, male/female couplers	13 lbs. (5.89 kg)
<b>103179-002</b>	Mill hose	3.0" x 25 ft, male/female couplers	18 lbs. (8.16 kg)

## Mini Rodder

Developed for 1" or 2" (2.5 or 5 cm) conduit and up to 400 feet (122 m). The Mini rodder combines lightweight and portability along with high rod strength. Pulling strength is rated at 2200 lbs (998 kg) while 12" to 18" (30 to 45 cm) radius bends are easily negotiated. Especially effective for placement of wire or cable in interior building conduit. This counter wound rod from Germany is capable of tight bend radii without breaking. See story on pg. 24\*

Complete unit includes: 1/4" (.63 cm) diameter rod from 100' to 400' (30.5 m to 122m) lengths, Vertical stand and spool with spool brakes to avoid "spring out" effect, and threaded end fittings to accept all accessories.

<b>Model #</b>	<b>Length</b>	<b>Weight</b>
<b>46100</b>	100 ft (30.5 m)	16 lb. (7.3 kg)
<b>46200</b>	200 ft (61 m)	19 lb. (8.6 kg)
<b>46300</b>	300 ft (91.5 m)	22 lb. (10 kg)
<b>46400</b>	400 ft (122 m)	25 lb. (11.3 kg)



Developed for 2" or 3" (5 or 7.6 cm) conduit and up to 1000 feet (305 m). The Midi rodder combines mid range lengths with high flexibility. Pulling strength is rated at 2800 lbs (1270 kg) while 18" to 24" (45 to 61 cm) radius bends are easily negotiated. Especially effective in pulling electric cable, winch rope, and midrange lengths of telecommunications cabling. This is an imported rod from Germany and is capable of tight bend radii without breaking. See story on pg. 24\*

Complete Unit Includes: 3/8" (.95 mm) diameter rod from 200' to 1000' (61m to 305m), Vertical/Horizontal stand & spool with wheeled frame & spool brakes to avoid "spring out" effect, threaded end fittings to accept all accessories, units come marked in feet (add an additional "M" to part number for marking in meters).

<b>Model #</b>	<b>Length</b>	<b>Weight</b>
<b>48200M</b>	200 ft (60 m)	70 lb. (31.7 kg)
<b>48400M</b>	400 ft (120 m)	85 lb. (38.6 kg)
<b>48600M</b>	600 ft (183 m)	100 lb. (45.3 kg)
<b>48800M</b>	800 ft (244 m)	120 lb. (54.4 kg)
<b>481000M</b>	1000 ft (305 m)	135 lb. (61.2 kg)

## Midi Rodder



Developed for 3" (7.6 cm) or larger conduit and up to 1200 feet (366 m). The Maxi rodder combines long range lengths with high superior strength. Pulling strength is rated at 3300 lbs (1496 kg) while 24" to 30" (61 cm to 76 cm) radius bends are easily negotiated. Especially effective in pulling heavy electrical and telecommunications cable in long runs. This is a domestic rod not containing the same fiber ratio as other sizes.

Complete Unit Includes: 7/16" (1.1 cm) diameter rod from 400' to 1200' (120 m to 365 m), Vertical/Horizontal stand & spool with wheeled frame & spool brakes to avoid "spring out" effect, threaded end fittings to accept all accessories, units come marked in feet (add an additional "M" to part number for meters).

<b>Model #</b>	<b>Length</b>	<b>Weight</b>
<b>49400M</b>	400 ft (122 m)	102 lb. (46.2 kg)
<b>49600M</b>	600 ft (183 m)	120 lb. (54.4 kg)
<b>49800M</b>	800 ft (244 m)	138 lb. (62.6 kg)
<b>491000M</b>	1000 ft (305 m)	157 lb. (71.2 kg)
<b>491200M</b>	1200 ft (366 m)	170 lb. (77.1 kg)

## Maxi Rodder



# Manhole Tool Accessories

## DUCT RODDER ACCESSORIES



### End Repair Kit

Designed to repair damage at the end of the rod.

Includes: instructions, adhesive, sand paper, and both the swivel as well as the solid rod end.

### In-Line Repair Kit

Designed to repair damage in-line on the rod.

Includes: instructions, adhesive, sand paper, and both the swivel as well as the solid rod end.

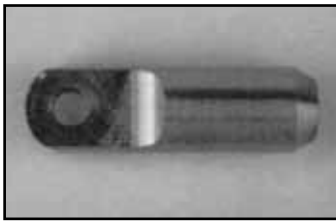

### Pulling Eye

Eye is used to tie off winch line, mule tape, or electrical conductors. Also utilized when shackle is required.

### Roller Guide

Prevents end hang ups. Guides the rod over bumps, offsets, and around corners.

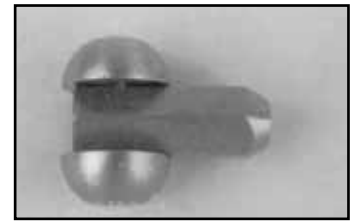

### Shackle

Combines with pulling eye, for use when the winch line has a closed loop eye. Also used to connect to another rod with a shackle.

### End-Fitting Swivel

Utilized on leading end of the rod, the swivel end fitting allows line veing pulled in, to twist and unwind.

### End-Fitting Solid

Utilized on rod attached to spool. Provides greater side loading capacity when rod is being reeled off.

### Union Coupling

For joining two rodding unit together outside the duct. Requires each rodder to be equipped with a swivel.

### Basket Combination

For joining two rods together inside the duct. Minimum duct diameter requirement 4in.

### Ordering Information

	Mini	Midi	Maxi
End Repair Kit	46001	48001	49001
In-Line Repair Kit	46002	48002	49002
Pulling Eye	46003	49003	49003
End Fitting Swivel	46004	48004	49004
End Fitting Solid	46004A	48004A	49004A
Union Coupling	46005	49005	49005
Roller Guide	46006	49006	49006
Shackle	46007	49007	49007
Basket Combination	N/A	N/A	49008

## THE FIBER GLASS ROD INNOVATION

**\*The unique fiberglass profile** - The glass fiber rod is the basic element of our **Mini & Midi** fiber optic cable pulling systems. The excellent quality and versatility of this stems from its unique technological design. The combination of extreme flexibility and high shear strength makes the fiberglass rod like a flexible pole. Its particular production technology and special construction make possible the combination of these two basically contrary features which are essential for this application. The higher the fiberglass content of the rod, the higher is its stability under shear stress. Our **Mini & Midi** fiberglass rods therefore contain a particularly large proportion of high quality glass fiber, at 80%. All fibers are embedded together in elastic polyester resin and cross wrapped to form a compact bound core. This forms a wavy, highly resinous outer layer, which takes up the surface tension produced when the rod is bent. This makes a very small radius of curvature possible so that tight bends are easily passed through. The adhesion of the coating layer and the attached rod end is optimized by the waviness of the surface. The smooth plastic outer coating made of polypropylene slides easily and therefore reduces the friction resistance to a minimum. It is also highly heat resistant and resilient. The high elasticity of our **Mini & Midi** fiberglass rods makes it possible to construct unbeatably small, compact and handy products.

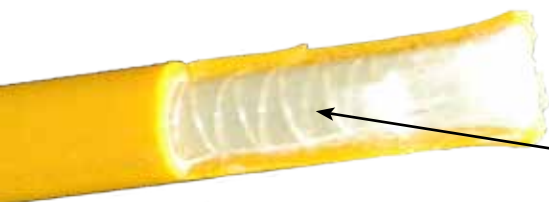

Counter winding





# ***Portable Generators***

# PORTABLE GENERATOR

## 5.5 KW



<b>Model</b>	<b>Description</b>
<b>PG55D</b>	5.5 KW Portable Generator

### Power Specifications:

Continuous	5.0 KW
Standby	5.5 KW
Voltage	120 / 240VAC
Frequency	60Hz
Phase	Single
Starting System:	Electric, Recoil

### Fuel Specifications:

Fuel Tank Capacity	12 Gallons (Diesel)
Run Time @ half load	34 hours
Run Time @ full load	29 hours

### Engine Specifications:

Manufacturer	Kohler
Model	KD420
Displacement	442cc / 27 cu in
RPM	3600
Cylinders	Single
Cooling System	Air

### Noise Emission:

Noise pressure level @ 7m 79dBA

### Receptacles:

NEMA 5-20R, 125VAC GFCI Duplex  
NEMA L14-30R, 125-250VAC Twist lock

### Features:

- EPA/Carb Tier 4 Compliant Diesel Engine
- Self Priming Engine, fuel pump delivers fuel without secondary priming operations even if the fuel tank runs dry
- Engine Low Oil Protection, Engine shut down when low oil pressure detected
- Electronic Manual Override, Allows for recoil start without battery
- Single Point Lifting Eye
- Fully enclosed & lockable control panel
- Audible & visual indicators when generator is not running
- Circuit breaker protection for receptacles
- Hour meter
- Sealed lead acid 12VDC battery
- In-line battery quick disconnect
- Folding handles on each end
- Flat-free tires

### Recommend Accessories:

- Security Safety Chain
- Lock Box
- Cords (configured for your needs)

# PORTABLE GENERATOR

## 10 KW



<b>Model</b>	<b>Description</b>
<b>PG100D</b>	10 KW Portable Generator

### Power Specifications:

Continuous	10 KW
Voltage	120 / 240V
Frequency	60 Hz
Phase	Single
Starting System	12V Electric

### Fuel Specifications:

Fuel Tank Capacity	12 Gallons (Diesel)
Run Time @ Full Load	17 hours

### Engine Specifications:

Manufacturer	Kohler
Model	KDW702
Displacement	686cc / 42 cu in
RPM	3600
Cylinders	2
Cooling System	Liquid

### Noise Emission:

Noise pressure level @ 7m 76dBA

### Receptacles:

NEMA 5-20R, 125VAC GFCI Duplex  
NEMA L14-30R, 125-250VAC Twist lock

### Features:

- EPA/CARB Tier 4 Compliant Diesel Engine
- Indirect Fuel Injection
- Engine Low Oil Protection
  - Engine shut down when low oil pressure detected
- High Coolant Temp Protection
  - Engine shut down when high coolant temperature detected
- Full Pressure Lubrication
- Full Flow Oil Filter
- Shrouding Protection
- Insulated Windings
  - Excellent moisture and chemical protection
- Self Adjusting
- Self Energizing
- Maintenance Free
- Single point lift eye
- Folding wheel barrow style handles

### Recommend Accessories: (see reverse side)

- Security Safety Chain
- Lock Box
- Cords (configured for your needs)

# ***Gas Monitors***



# Gas Monitors

**Some models of detectors can be tuned to detect/measure 8 different explosive gases:**

- Methane
- Butane
- Octane
- Propane
- Pentane
- Hydrogen
- Methanol
- Ethane (H25 - no. 1 explosive)

## Gas Alert MaxXT II

GasAlertMax XT II is the smart, simple, economical way to compliance. Workers feel safe and incidents are minimized so everyone will be able to do more. That means savings realized from business continuity and productivity. Gas Alert Max XT II reliably monitors up to four hazards and combines straightforward one-button operation with our robust, motorized pump for intelligent, remote sampling, ideal for confined spaces.

**Model: XT-XWHM-Y-NA**

## Gas Alert MAX XT Kit

<u>Model</u>	<u>Description</u>
<b>XT-XWHM-Y-NA-CS</b>	GasAlertMax XT II confined space kit <i>includes:</i> GasAlertMax XT II detector (%LEL, O2, H2S, CO), IR connectivity kit, 0.5 LPM regulator, Sampling probe, Calibration gas (2.5% CH4, 18% O2, 25 ppm H2S, 100 ppm CO)



## Gas Alert Quattro

Rugged and reliable, the GasAlertQuattro four-gas detector combines a comprehensive range of features with simple one-button operation. With flexible power options, the GasAlertQuattro is always ready. The graphic LCD displays easy to identify icons that indicate operational information, such as bump test and calibration status for simplified on-site auditing. IntelliFlash provides continuous visual confirmation of detector operation and compliance.

**Alkaline Model: QT-XWHM-A-Y-NA**

**Rechargeable: QT-XWHM-R-Y-NA**

## Gas Alert Quattro Kit

<u>Model</u>	<u>Description</u>
<b>QT-XWHM-R-Y-NAC</b>	GasAlertQuattro confined space kit <i>includes:</i> GasAlertQuattro detector (%LEL, O2, H2S, CO) - rechargeable version, Manual aspirator kit, IR connectivity kit, Calibration cap with 1 ft. / 0.3 m hose, 0.5 LPM regulator, Sampling probe, Calibration gas (2.5% CH4, 18% O2, 25 ppm H2S, 100 ppm CO), Rechargeable battery pack



## Gas Alert MicroClipX3

The slim and compact GasAlertMicroClip X3 provides affordable protection from atmospheric hazards. This multi-gas detector provides continuous visual confirmation of detector operation and compliance with the IntelliFlash™ feature and the simple one-button operation offers ultimate ease of use and significantly reduces time spent training.

**Model: MCX3-XWHM-Y-NA**

**Recommended accessory: MC-AS01 Aspirator Pump**



# Gas Monitor Accessories



**GA-BXT**  
**Concussion-Proof Boot**  
 The external rubber boot keeps detectors cleaner and provides an additional level of protection in extreme conditions. The boot fits securely onto the detector and is equipped with a rugged stainless steel, alligator-style clip.



**GA-HXT**  
**Carrying Holster**  
 Securely attach the Gas Alert Max XTII and tubing to your belt with this durable carrying holster.



**GA-BQT**  
**Concussion-Proof Boot**  
 The heavy duty concussion-proof boot slips easily and securely onto the detector for additional protection in extreme conditions. Equipped with a rugged stainless steel alligator clip, the external rubber boot also keeps the detector clean.



**QT-HQT**  
**Carrying Holster**  
 Ergonomic and comfortable to wear, the carrying holster securely attaches the Gas Alert Quattro to your belt or close to your breathing zone. The 360° swivel clip ensures that mobility is never hampered.



**MC-AS01**  
**Manual Aspirator Pump**  
 For remote sampling, complete with probe, hose, aspirator pump and adapter cap.



**QA-AS01**  
**Manual Aspirator Pump Kit**  
 The manual aspirator pump kit with 1 ft./0.3 m probe is a cost-effective solution for remote sampling without a pumped instrument.



**REG-0.5**  
**Regulator for Calibration Gas**  
 For Gas Alert, Quatro and Micro Clip XT



**ACMAX002**  
**Calibration Gas**  
 For PelChek, 34 liters

<u>Components</u>	<u>Concentration</u>
Hydrogen Sulfide	25ppm
Carbon Monoxide	100ppm
Methane	2.50% (50% L.E.L.)
Oxygen	18.0%
Nitrogen	Balance

# Gas Monitor Accessories



**GA-VPA-1**  
**Vehicle Power Adaptor**

Charge your detector easily anywhere you go with the vehicle power adaptor (CLA) cigarette lighter adaptor. Only 12V suitable. Simply attach the detector or battery through the charging and IR communications port and wait for the battery icon on the LCD to show that the battery is fully charged or the LED on the battery to turn green.



**GA-PA-1-MC5**  
**Multi-Unit Power Adaptor**

Simultaneously charge five detectors or batteries with the multi-unit power adaptor. Simply attach the detector or battery through the charging and IR communications port and wait for the battery icon on the LCD to show that the battery is fully charged or the LED on the battery to turn green.



**GA-PA-1-NA**  
**Power Adaptor**

Ensure your detector is charged and ready for use with the power adaptor. Simply attach the detector through the charging and IR communications port and wait for the battery icon on the LCD to show the battery is fully charged. Ships with detector.

---

## Gas Alert Monitor Accessories

<b>GA-SPAK</b>	Quatro sampler pack	
<b>GA-PROB-FIL-K1</b>	Quatro filter and gasket replacements for sample probe GA-PROB1-1	
<b>QT-SCREW-K1</b>	Quatro replacement screw kit	single kit
<b>M0931K</b>	MaxXT quick connect fitting spares for hoses	kit of 2
<b>M5-AF-K2</b>	MaxXT auxiliary filter for MaxXT pump	kit of 5
<b>XT-RF-H5</b>	MaxXT hydrophobic pump filter replacement	kit of 5
<b>GA-PFMAX</b>	MaxXT particulate pump filter replacement	kit of 5
<b>XT-BAT-K1</b>	MaxXT replacement battery	single kit
<b>XT-RPUMP-K1</b>	MaxXT replacement pump	single kit



# One-piece instant shelters set up as easy as 1 - 2 - 3!



**Sets up in less than 10 seconds!**



# Tents



# Ground Tents

## Pelsue Ground Tent Specifications:

**Fabric:** 250 Denier Polyester, Urethane Coated, Waterproof, Mildew Resistant, UV Protected, Flame Retardant to CPAI-84

**Frame:** Cast Aluminum Hubs, Pultruded Fiberglass Rods

**Construction:** All - Joining Seams Double Stitched, Exposed Roof Seams Sealed, Non-Metallic Snaps & Rings

**General Info:** 1 year manufacturer warranty, Repair Kits Available - add "RK" to end of tent part number, Carry case & tent stakes and seam sealer included

### A - Series dual zipper roll up door



<b>Model</b>	<b>Nominal Size</b>	<b>Weight</b>	<b>Folded Dimensions</b>
<b>6504A</b>	4' W x 4' L x 6' H	18 lbs	6" x 6" x 46"
<b>6506A</b>	6' W x 6' L x 6' H	20 lbs	6" x 6" x 56"
<b>6508A</b>	8' W x 8' L x 6' H	31 lbs	7" x 7" x 66"
<b>6510A</b>	10' W x 10' L x 6' H	34 lbs	8" x 8" x 76"
<b>6514A</b>	14' W x 14' L x 6' H	162 lbs	10" x 10" x 124"

Includes:

- two screen windows with roll up flaps
- three tie down cords through the hub
- ground flaps
- heavy duty frame
- wide open front
- dual zipper roll up door
- interior and exterior roof line loops for tie down
- carrying case
- three tent stakes

### D - Series interconnecting door flap



<b>Model</b>	<b>Nominal Size</b>	<b>Weight</b>	<b>Folded Dimensions</b>
<b>6506D</b>	6' W x 6' L x 6' H	21 lbs	6" x 6" x 56"
<b>6508D</b>	8' W x 8' L x 6' H	32 lbs	7" x 7" x 66"
<b>6510D</b>	10' W x 10' L x 6' H	36 lbs	8" x 8" x 81"
<b>6510C</b>	10' W x 10' L x 9' H	51 lbs	8" x 8" x 88"
<b>6512D</b>	12' W x 12' L x 6' H	94 lbs	10" x 10" x 100"

*\*6510C is an Extra Tall, 10' high Model*

Includes:

- two screen windows with roll up flaps
- three tie down cords through the hub
- ground flaps
- heavy duty frame
- wide open front
- snap and D-rings with interconnecting flaps (to connect 2 tents together)
- ventilation hose entry sleeve
- interior and exterior roof line loops for tie down
- carry case and three tent stakes.
- provides two side entrances



Side view connected

# Ground Tents

## Ground Tent

DRAD tents incorporate the standard features found in the Pelsue "D" series ground tents, along with a 30" wide roll-up rear door for personnel entry and exit. It is ideal for working up against any type of cabinet. The tent also doubles as a stand alone ground tent for construction or splicing.

Model	Nominal Size	Weight	Folded Dimensions
6508DRAD	8' x 8' x 6' H	32 lbs	7" x 7" x 66"
6510DRAD	10' x 10' x 6.5' H	36 lbs	8" x 8" x 81"



Door flap closed



## "DRAD" Ground Tent

D Series tent w/rear access door



## "High-5" Ground Tent

D Series tent w/extra height



## High-5 Ground Tent

65068A Tent measures 6' X 6' X 8' high. Ideal for use over industrial tripod or davit retrieval hoists. May be used to cover pad or pole mounted cabinets or anywhere that additional height is required. Rear Access 1/2 moon style zipper door included. Door style velcro slit and 8" diameter heater/ventilator hose sleeve.

Model	Nominal Size	Weight	Folded Dimensions
65068A	6' x 6' x 8' H	27 lbs	7" x 7" x 66"
65079A	7' x 7' x 9' H	27 lbs	7" x 7" x 66"
65089A	8' x 8' x 9' H	27 lbs	7" x 7" x 66"

Back of tent shown



## Ground Tent w/Cable Slot

D Series tent w/cable slot access door

## Ground Tent with Cable Slot

DCS Model ground tents feature a vertical slit in the rear wall, from the hub to the ground. Slit is closed over by means of a "Velcro" style closure and a hook & ring assembly. Used to allow entry of cable or pipe when doing fusion or splicing in the tent. Includes vent sleeve.

Model	Nominal Size	Weight	Folded Dimensions
6506DCS	6' x 6' x 6' H	21 lbs	6" x 6" x 36"
6508DCS	8' x 8' x 6' H	32 lbs	7" x 7" x 66"



# Tents



## Fiber Optic Splicing Tents

This Pelsue Innovation features a heavier poly-cotton breathable fabric and solar fly sunshade. The walls are solid white and constructed of acrylic for "breathability" and increased light. Cable slots w/"velcro" style closures allow easy access to cable while doors are shut. May be used with Pelsue heaters (**Model 1590, 1690D**). Options include a fiber optic splicing table, part number 107022-001 and "Velcro-in" floors.

- 6508LG** Fiber optic splice tent with solar fly, no floor.
- 6508LGF** Fiber optic splice tent with solar fly and standard floor.
- 6508LGH** Fiber optic splice tent with solar fly and heavy duty floor.

<b>Model</b>	<b>Nominal Size</b>	<b>Weight</b>	<b>Folded Dimensions</b>
<b>6508LG</b>	8' x 8' x 6' H	38 lbs	12" x 12" x 70"
<b>6508LGF</b>	8' x 8' x 6' H	41 lbs	12" x 12" x 70"
<b>6508LGH</b>	8' x 8' x 6' H	47 lbs	12" x 12" x 70"



## Emergency Use Tents

Pelsue Emergency Response tents feature highly visible lime green fabric & a reflective stripe. Perfect for Fire & Police Departments, Ambulance Crews, Bio-Terror Incidents, Hazmat Decontamination, Mass Casualty Incidents, Rehab Situations, Command Post, Patient Isolation, Emergency Response, & Fire/Rescue Operations. Anywhere, anytime instant shelter is needed, these tents can be set up in seconds. Custom color, size, and logos available!

- 6508DES** Ground tent, lime green & white w/reflective stripe
- 6510DES** Ground tent, lime green & white w/reflective stripe

<b>Model</b>	<b>Nominal Size</b>	<b>Weight</b>	<b>Folded Dimensions</b>
<b>6508DES</b>	8' x 8' x 6.5' H	32 lbs	7" x 7" x 66"
<b>6510DES</b>	10' x 10' x 6.5' H	36 lbs	8" x 8" x 81"



1690D & 1325D heater blower combo heating tent

**Shelter Heating, A/C Kits** also available. Propane heater, ventilator, 15' ventilator hose, plastic hose canister, & LPG hose. Air Conditioners in 24,000 (240 VAC) or 48,000 (240 VAC) models. (goto Heating & Ventilation, page 5)

## Custom Colors and Branding Available



Your Logo Here



The 5-in-1 specialty tent is a single tent which, when used with the appropriate hardware, can perform multiple functions. The tent may be attached to a manhole guard, pole, ladder, strand, or bucket truck. Door style features snap & D-ring closures. Includes strand mounting hardware (P/N 63350). Available in two models:

Model	Nominal Size	Weight	Folded Dimensions	Recommended Accessories
<b>6332S</b>	4' x 4' x 3' H	6 lbs	6" x 6" x 35"	
<b>6334A</b>	4' x 4' x 8' H	11 lbs	6" x 6" x 35"	
<b>6334AN</b>	5' x 5' x 8' H	18 lbs	6" x 6" x 46"	

Note: when ordering hardware for this model, add "AN" to the end of hardware part number (for example: guard hwr = 63390AN).

## Multi Tent



Model 6334A



**Strand Hardware**  
Model # 63350



**Guard Hardware**  
Model # 63390



**Ladder/Pole Hardware**  
Model # 63380



**Bucket Hardware**  
Model # 63360

## Trench Tents



Model	Nominal Size	Weight	Folded Dimensions
<b>6408A</b>	8' x 16' x 6.6' H	43 lbs	8" x 8" x 75"
<b>6413A</b>	13' x 24' x 8.25' H	109 lbs	12" x 16" x 100"
<b>6416A</b>	16' x 30' x 10.25' H	185 lbs	12" x 16" x 129"

Available in three standard sizes, these tents offer protection from the elements during trenching or boring operations. One piece construction allows for easy set up and dismantle. Openings on both ends for easy access. One-piece structure features no interior obstructions. This tent may be used as a modular set-up by adding as many units (end-to-end) as required.



# Tents

## Hot Weather Work Shelters



### Model 6506S

Using time proven Pelsue tent technology, the work shelter offers on site shade for work crews. The tent is easy to set up and has a rugged construction. Multiple sizes and colors available.

Model	Nominal Size	Weight	Folded Dimensions
<b>6506S</b>	6' W x 6' L x 6' H	21 lbs	8" x 8" x 57"
<b>6508S</b>	8' W x 8' L x 6' H	33 lbs	8" x 8" x 68"
<b>6510S</b>	10' W x 10' L x 6' H	43 lbs	8" x 8" x 84"



### Model 6506SRS

The same as Model 6506S with a high visibility reflective strip sewn at the top of each side panel.

Model	Nominal Size	Weight	Folded Dimensions
<b>6506SRS</b>	6' W x 6' L x 6' H	21 lbs	8" x 8" x 57"
<b>6508SRS</b>	8' W x 8' L x 6' H	33 lbs	8" x 8" x 68"
<b>6510SRS</b>	10' W x 10' L x 6' H	43 lbs	8" x 8" x 84"



### Model 6506HVS

The same as Model 6506S with a high visibility fabric on lower half of roll-up panels and a high visibility mesh.

Model	Nominal Size	Weight	Folded Dimensions
<b>6506HVS</b>	6' W x 6' L x 6' H	21 lbs	8" x 8" x 57"
<b>6508HVS</b>	8' W x 8' L x 6' H	33 lbs	8" x 8" x 68"
<b>6510HVS</b>	10' W x 10' L x 6' H	43 lbs	8" x 8" x 84"



## Fiber to the Home Tent



### 6705 FTTH Installer's Shelter

#### Protect ONTs while installing Fiber at the Home Model 6705



The Pelsue quick fold design allows this tent to be erected and ready for work in seconds. Heavy duty fabrics, waterproof coating, sealed seams, fiberglass rods, reinforced rod-end pockets and metal hubs provide years of service in the field. The tent's snug fit on the work surface side, and low-profile access door keep wind, dust, rain and snow out.

Model	Nominal Size	Weight	Folded Dimensions
<b>6705</b>	6' W x 6' L x 7' H	17 lbs	7" x 7" x 65"

## Work Umbrella (as shown with 122508-E01)



### Model 6772

Pelsue's 72" diameter yellow work umbrella was designed for an even quicker setup and breakdown for when the need arises. This umbrella is a universal style work umbrella with sturdy PVC fabric (yellow) and a wooden mast.

#### Umbrella Suction Mount for Model 6772

Model	Dimensions	Comments
<b>125508-E01</b>	4" W x 14" L	w/Adjustable elbow
<b>125508-001</b>	4" W x 14" L	Suction mount only

**Optional flat surface mount available:**  
The surface mount includes two suction cups with 75 lbs of holding strength each.



# ***Rescue & Retrieval***





# Rescue & Retrieval

## Davit Arm Retrieval System

Our component based davit assembly can be mated with several styles of bases and many styles of sleeves. The mast consists of an aluminum offset tube, fabricated elbow section, and aluminum center post with winch mounting bracket. Elbow units are reversible and provide cost effective, versatile means of achieving multiple

offset reaches. Assemblies are offered as adjustable offset units capable of either an 12"/18", 18"/24", 30"/36", or 42"/48" offset reach. All davits are man rated to **350 lbs.** and offer a universal bracket for attachment of alternate lifting systems and/or 900 lbs. MAF fall arrest devices. Assembly provides locations for up to two devices mounting plates. One standard Pelsue winch mounting plate is provided with the assembly.

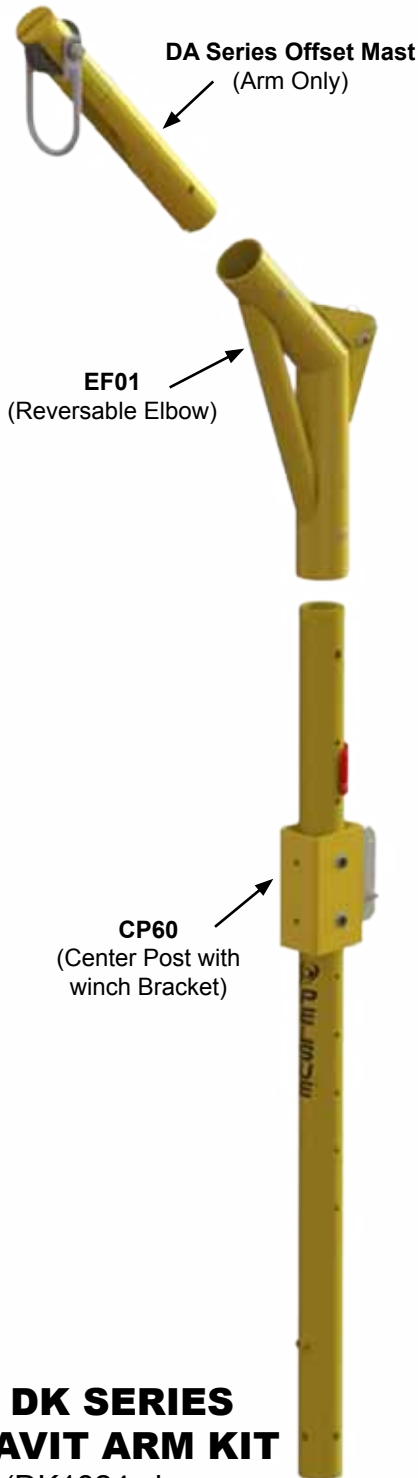

**DK SERIES  
DAVIT ARM KIT**  
(DK1824 shown)

Model	Description	Kits
<b>DK1218</b>	12"/18" Offset Mast, Rev. Elbow, & Center Post	
<b>DK1824</b>	18"/24" Offset Mast, Rev. Elbow, & Center Post	
<b>DK3036</b>	30"/36" Offset Mast, Rev. Elbow, & Center Post	
<b>DK4248</b>	42"/48" Offset Mast, Rev. Elbow, & Center Post	
<b>RK-EB1</b>	Davit Arm (DK1824) & Adjustable Base (EB56), Max offset 24"	
<b>RK-EB2</b>	Davit Arm (DK1824) & Adjustable Base (EB66), Max offset 24"	

Model	Description	Individual Parts
<b>CP60</b>	60" Center Post w/winch bracket (26 lbs)	
<b>EF01</b>	Fabricated Elbow - reversible (10 lbs)	
<b>DA18</b>	12"/18" Offset Mast - arm only (5 lbs)	
<b>DA24</b>	18"/24" Offset Mast - arm only (7 lbs)	
<b>DA36</b>	30"/36" Offset Mast - arm only (10 lbs)	
<b>DA48</b>	42"/48" Offset Mast - arm only (12 lbs)	
<b>EB56</b>	Base - expandable from 36" to 56" ID (100 lbs), Max offset 24"	
<b>EB66</b>	Base - expandable from 46" to 66" (115 lbs), Max offset 24"	
<b>BGDK</b>	Davit Carry Case	



**BGDK**



**RK-EB1**  
Davit Retrieval System

## Expandable Davit Base

The Pelsue Model EB56 and EB66 are lightweight and portable base assemblies designed for use with the Pelsue Davit System. The base can be placed and assembled around an underfoot manway or similar point of entry. Includes 4 corner jacks for leveling on uneven ground. It will accept a Pelsue Davit System with a 3" round centerpost.

<u>Model</u>	<u>Description</u>
--------------	--------------------

<b>EB56</b>	Base - expandable from 36" to 56" ID (100 lbs), Max offset 24"
<b>EB66</b>	Base - expandable from 46" to 66" (115 lbs), Max offset 24"



## Folding Davit Base

The Pelsue Model DBF-43A is a lightweight, compact portable base assembly designed for use with the Pelsue Davit System. It can be folded and transported in its folded configuration, allowing for easy movement and placement. The base can be unfolded and assembled around an underfoot manway or similar point of entry. Includes 4 corner jacks for leveling on uneven ground. It will accept a Pelsue Davit System with a 3" round centerpost. Max Davit offset 12" to 18"

<u>Model</u>	<u>Description</u>
--------------	--------------------

<b>DBF-43A</b>	Folding Davit Base
----------------	--------------------



# Rescue & Retrieval

## Elevated Platform Davit Base

The Pelsue Model **501184-001** is an elevated base assembly designed for use with the Pelsue Davit System. The Elevated platform was also designed to around elevated manholes, max Davit offset 24"

Model	Description
<b>501184-001</b>	Elevated Davit Platform

Can remove outrigger legs & standing platform for lower applications

DAVIT ARM &  
PH Series  
Man-Rated Hoist  
(sold seperately)



**VHS-A1**  
Vehicle Hitch Mount

## Vehicle Hitch Mount Base

VHS-A1 Vehicle hitch mount connects with 2" square vehicle receivers. Includes aluminum "T-Bar" stabilizer leg. Designed for maximum 24" offset davit system. Modular system offers many accessories to adapt hitch mount to your needs. Sleeve includes ABS liner and PVC slip plate.

RK-HS1 Kit includes vehicle hitch mount VHS-A1 and davit system DK1824. Davit assembly includes standard Pelsue winch mount bracket. Winch not included.

## Counterweight Cart

The CWC1 is a davit retrieval system base utilizing a counterbalance technique. The unit features a steel cart, with heavy duty casters. Excellent for entry into glass lined reactors and open pits.

Cart can be used with either a 2', 4', or 6' extension and a DK1824 offset mast. Maximum offset varies with length of extension used.

Masts and offset davit arms not included. Minimum counterweight must be used to achieve stability. Contact Pelsue for details.

**Note:** Weights not included.  
All parts can be stored on the cart  
for easy transport.

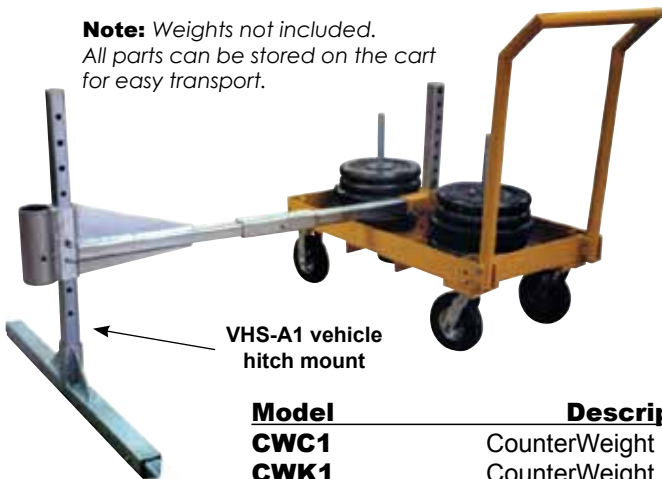

VHS-A1 vehicle  
hitch mount

Model	Description
<b>CWC1</b>	CounterWeight Cart only no accessories
<b>CWK1</b>	CounterWeight Cart w/out rigging equip.



CWK1

## Forklift Basket

<u>Model</u>	<u>Nominal Dimensions</u>
<b>FLB-50</b>	50" W x 45" L x 64" H

The Forklift Basket is intended to be used as a safe place for an attendant performing retrieval operations at heights. By attaching a DK1824 davit system w/winch, the operator can be lifted by a forklift and lift or lower workers into position. Unit includes complete basket w/side rails, floor mounted davit sleeve, operator tie-off anchor, & forklift security chain.

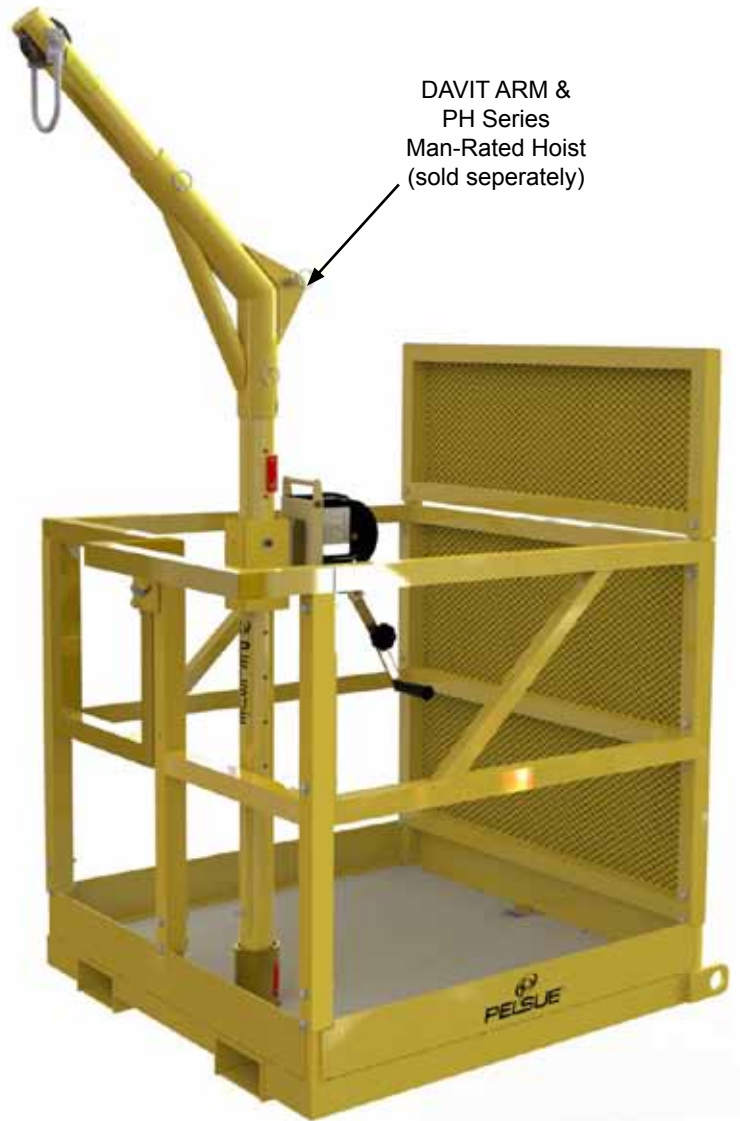

### **General Specifications:**

Sleeve included w/capability of 30" max offset arm for retrieval/fall arrest anchorage.

5000 lb.. Proof loaded attendant anchorage point.

Man Rated Load Capacity (x2).....350 lbs. Attendant & Entrant

### **WARNING!**

900 lb.. maximum arrest force fall arrest device must be used when system is employed as part of a complete fall arrest system.

### **Materials & Construction:**

General Construction	6061-T6 Aluminum
Weight	150 lbs.

# Rescue & Retrieval

## Permanent Mount Sleeves

- Available in electroless nickel plated steel, zinc plated, galvanized or stainless steel
- Allows masts to pivot 360°
- Drain holes eliminate water buildup
- Friction bearing is replaceable
- ABS liners with PVC slip plates
- Accepts up to 48" offset masts
- Sleeve is always on site
- Inside sleeve diameter 3.0680"
- Liners and sleeves are replaceable

### Cylinder Core

The cylinder core mount is drilled into existing concrete or poured into fresh concrete and must be secured to the concrete with grout or epoxy compatible with plant conditions. Please contact Pelsue for specific installation requirements.



Cut away view

Model	Weight
<b>DSP-C2</b> (plated)	24 LBS
<b>DSS-C2</b> (stainless)	24 LBS

### Floor Mounted

The floor mount is anchored by bolts, or it welds to a variety of surfaces such as floors, truck beds, catwalks, etc. Contact Pelsue for specific installation requirements.



Model	Weight
<b>DSP-F1</b> (plated)	24 LBS
<b>DSS-F1</b> (stainless)	24 LBS

### Center Floor Mounted

The center floor mount is anchored by bolts, or it welds to a variety of surfaces such as floors, truck beds, catwalks, etc. Please contact Pelsue for specific installation requirements.



Model	Weight
<b>DSP-F2</b> (plated)	24 LBS
<b>DSS-F2</b> (stainless)	24 LBS

### Sleeve Caps

Used to seal sleeves when not in use. Available in zinc plated steel, stainless steel or ABS plastic. Has a rubber seal that expands into sleeve



Model	Weight
<b>DSC-S2</b> (plated)	1 LBS
<b>DSC-S1</b> (stainless)	1 LBS
<b>DSC-P1</b> (ABS Plastic)	.24 LBS

### Flush Floor Mounted

The existing concrete flush floor mount is drilled and bolted in concrete or welded or bolted in steel. Great for high traffic areas where trip hazards are a concern. Please contact Pelsue for specific installation requirements.



Model	Weight
<b>DSP-F3</b> (plated)	23 LBS
<b>DSS-F3</b> (stainless)	23 LBS

### Flush Floor Mounted

Placed in fresh concrete, this sleeve mounts flush with the floor and is great for high traffic areas where trip hazards are a concern. Please contact Pelsue for specific installation requirements.



Model	Weight
<b>DSP-C1</b> (plated)	21 LBS
<b>DSS-C1</b> (stainless)	21 LBS

# Rescue & Retrieval

## Corner Mounted

Outside 90° angle. The corner mount is anchored by bolts to reinforced truck bumpers, walls, etc. Please contact Pelsue for specific installation requirements. Zinc plated steel.



**Model** **Weight**  
**DSP-A2** (plated) 26 LBS

## Corner Mounted

Inside 90° angle. The corner mount is anchored by bolts to reinforced truck bumpers, walls, etc. Please contact Pelsue for specific installation requirements. Zinc plated steel.



**Model** **Weight**  
**DSP-A1** (plated) 26 LBS

## Wall Mounted

The wall mount is anchored by bolts or welds to truck bumpers, tank walls, sides of catwalks, meter pits, clarifiers, etc. Please contact Pelsue for specific installation requirements.



**Model** **Weight**  
**DSP-W1** (plated) 22 LBS  
**DSS-W1** (stainless) 22 LBS

## Portable Wall Mount

The DSR-S03 portable wall mount is made of zinc plated carbon steel. Clamping via eight bolts, the wall mount straddles walls of tanks, caissons, shorings, etc. up to 3" thick.



**Model** **Weight**  
**DSR-S03** (plated) 58 LBS

## Clamping Portable Wall Mount

For clamping onto a wall ranging from 3" to 8" thick walls.



**Model** **Weight**  
**DSR-A08** (yellow powder coated) 35 LBS

## Adjustable Wall Mount

The adjustable wall mount can clamp to any wall ranging from 1" to 23-1/4" thick.



**Model** **Weight**  
**DSR-ADJ** (yellow powder coated) 55 LBS

# Rescue & Retrieval

## LifeGuard LG5A Manhole Safety System



Model	Description
LG5A	Fall Arrest/Retrieval Manhole Guard System

### Features:

- Portable Manhole Guard, Fall Protection and Retrieval in One System
- Two Piece Unit for Easy Set-Up
- Dual Anchor Points
- Leveling Feet Included
- 5000 lb.. overhead Proof Load
- Certified Fall Arrest Anchorage
- Use with Man Rated Winch, SRL, 3-way or a Combination of Devices

### General Specifications:

- Man Rated Capacity: 350 lbs.\*
- Overhead Proof Load: 5000 lbs.
- System meets OSHA safety standards when used by a competent individual

### Materials:

- Upper Assembly: Structural Grade Aluminum & Steel
- Guard Assembly: Structural Grade Aluminum
- Winch Mount: 5052-H32 Aluminum
- Hardware: Grade 5 Steel

### Weight & Dimensions:

- Upper Assembly: 42 lbs.
- Guard Assembly: 33 lbs.
- Dimensions: 42" W x 42" L x 75" H

### LG5A System Includes:

- 1 ea. Upper Assembly
- 1 ea. Guard Assembly
- Set of 4 ea. Leveling Feet
- Set of 4 ea. Rubber Feet (shipped loose)
- 1 ea. winch bracket & mounting plate for use with standard retrieval winch.
- 1 ea. Pulley assembly with auto-lock carabiner
- Set of flexible draw latches to anchor the assembly to the guard assembly

### Suggested winches:

- PH07C
- PH07R

### Suggested accessories:

- LGL-B, Secondary winch bracket
- PA01, Secondary winch pulley



\*PH Series Hoist sold separately

Locking System

### 3-IN-1

- Barricade (OSHA requires open manholes must be barricaded)
- 5000 lb. lifting point



### \*\*"Man Rated"

This is an umbrella term by which we mean:

- The device or system is tested to meet the appropriate OSHA Safety Standards for confined space rescue and retrieval or fall arrest for personnel.
- The device or system is intended to be used for confined space rescue and retrieval or fall arrest by a worker who is trained as a "competent person" and/or "qualified" per OSHA Safety Standards.

## LifeGuard LG5X Manhole Safety System

<b>Model</b>	<b>Description</b>
LG5X	Fall Arrest/Retrieval Manhole Guard System

### Features:

- Portable Manhole Guard, Fall Protection and Retrieval in One System
- Two Piece Unit for Easy Set-Up
- Dual Anchor Points
- Leveling Feet Included
- 5000 lb.. overhead Proof Load
- Certified Fall Arrest Anchorage
- Use with Man Rated Winch, SRL, 3-way or a Combination of Devices

### General Specifications:

- Man Rated Capacity: 350 lbs.\*
- Overhead Proof Load: 5000 lbs.
- System meets OSHA standards when used by a competent individual

### Materials:

- Upper Assembly: Structural Grade Alum. & Steel
- Guard Assembly: Structural Grade Aluminum
- Winch Mount: 5052-H32 Aluminum
- Hardware: Grade 5 Steel

### Dimensions:

- 48" W x 48" L x 84" H

### LG5A System Includes:

- 1 ea. Upper Assembly
- 1 ea. Guard Assembly
- Set of 4 ea. Leveling Feet
- Set of 4 ea. Rubber Feet (shipped loose)
- 1 ea. winch bracket & mounting plate for use with standard retrieval winch.
- 1 ea. Pulley assembly with auto-lock carabiner
- Set of flexible draw latches to anchor the assembly to the guard assembly

### Suggested winches:

- PH07C
- PH07R

### Suggested accessories:

- LGL-B, Secondary winch bracket
- PA01, Secondary winch pulley



Locking System



# Rescue & Retrieval

## Pelsue Rescue Tripod

The Pelsue Rescue Tripod is designed for industrial rescue applications. Telescoping anodized-aluminum legs allow for height adjustments in 5" increments per leg. The legs also adjust to any angle to meet the most demanding situations! Cast-aluminum head has three heavy duty rigging anchor points plus built-in, man rated, cable ready pulley. Our rescue tripod adjusts to 11'-6" allowing for full retrieval of a litter basket in vertical rescues. Tripod also features locking legs.

### Model Description

- |             |  |
|-------------|--|
| <b>P054</b> | Pelsue Rescue Tripod - With Built In Cable Pulley - 6' to 11'-6"   |
| <b>RT07</b> | Pelsue Rescue Tripod - With Built In Cable Pulley - 4' to 7' (max) |

### Features:

- Minimum height: 6' Model P054, 4' Model RT07
- Maximum height: 11'6" Model P054, 7' Model RT07
- Weight: 62 lbs. Model P054, 57 lbs Model RT07
- Three rigging anchor points proof rated to 5000 lbs. at fully extended height
- Built-in cable ready pulley
- No load supporting welds
- Adjustable telescoping legs - 5" increments
- Feet convert to soft ground anchors and are predrilled for anchor bolts or stakes
- Base chain included to maintain stability

### Suggested Accessories:

- PHT Series hoists
- P057, carrying case (for RT07)
- P058, carrying case (for P054)
- PA01, pulley assembly (ANSI Z359 Carabiner, 5/8" 6000 lb pulley)  
(For use with secondary winch)



P058 Carrying Case



Legs lock into position with locking pins

## 2-IN-1 FEET



Pointed tip to dig into soft surfaces when tilted up

Skid resistant pad when laid flat



# Rescue & Retrieval

## Pole Hoist

Get rescue/retrieval capabilities by attaching the pole hoist to a tower tie off ring. Works just like a fishing pole! It is available in expandable 4' to 7' or 6' to 10' models. Comes complete with winch bracket (winch sold separately). Optional adjustable aluminum T-Bar leg is available for extra stability.

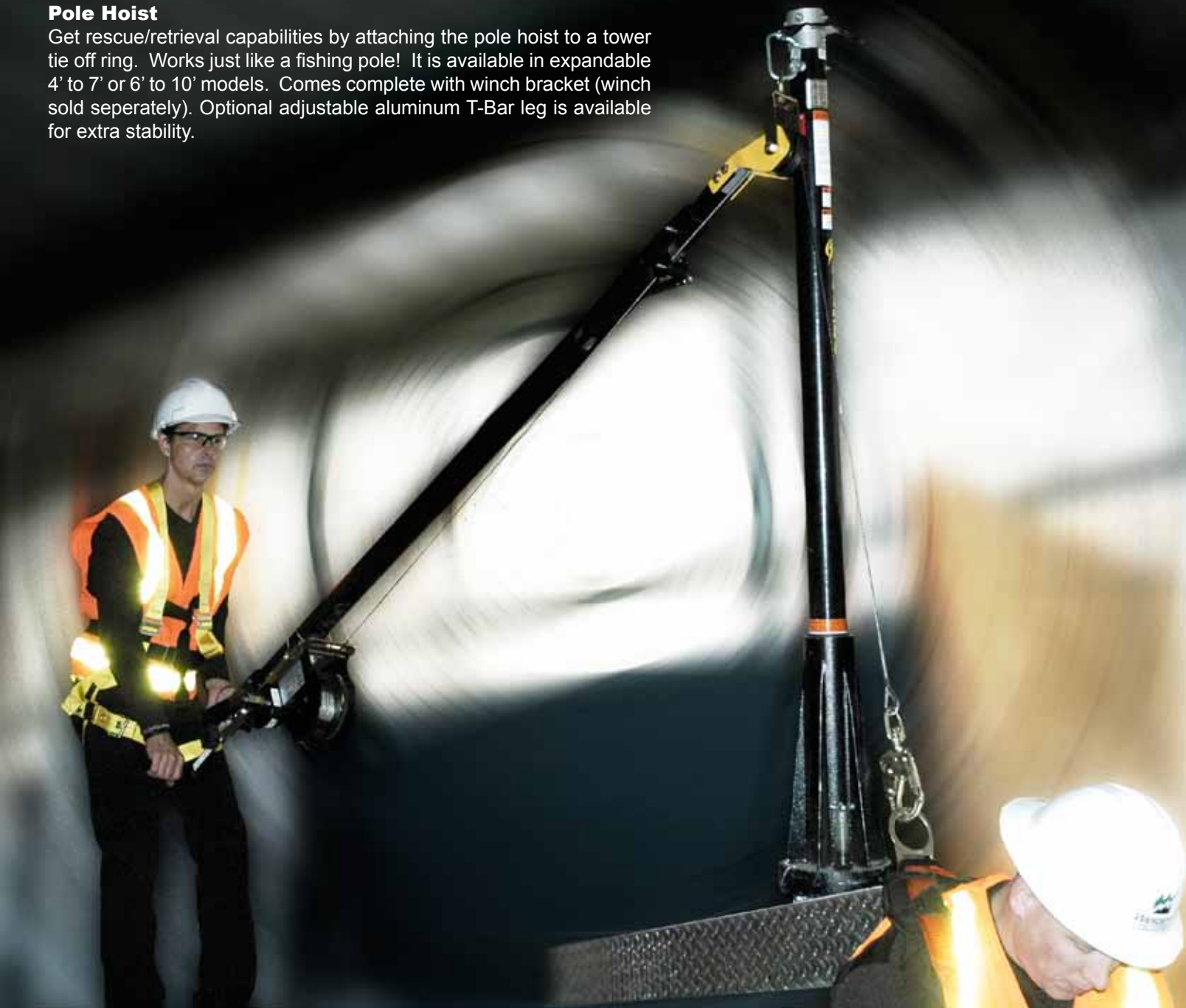

Model	Description
PHF305	Pole Hoist - Fixed head, 3' to 5' adjustable length, aluminum
PHF507	Pole Hoist - Fixed head, 5' to 7' adjustable fixed-head pole Hoist
PHF610	Pole Hoist - Fixed head, 6' to 10' adjustable fixed-head pole Hoist
PHFTBL	"T"-bar support leg - powder coated aluminum, adjustable length

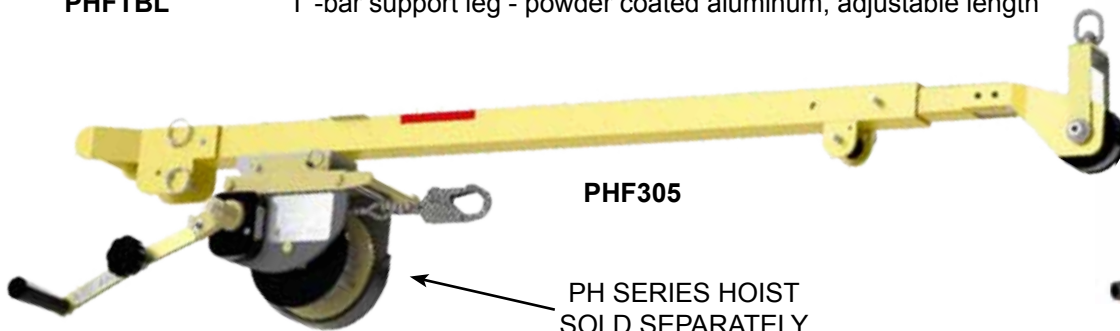

PHF305

PH SERIES HOIST  
SOLD SEPARATELY



PHFTBL

# Rescue & Retrieval

## PH Series Man Rated Hoists

Pelsue PH Series Hoists are designed and tested as personnel hoists for a single user Mechanical Retrieval/Lifting Devices as defined in OSHA Safety Standards for attaching a person that is entering or exiting from a confined space.

Pelsue PH Series Hoists are built with an internal braking system to prevent the accidental pay out of line, as well as a backup locking pawl system to prevent “free-wheeling” of the hoist. In the case that the primary brake ever becomes disabled the Pelsue personnel hoist has a built in secondary “overspeed” brake for redundancy. Hoist line extension (pay out) should occur ONLY when the handle is turned counterclockwise AND a force of AT LEAST 10 lbs.(4.5 kg.) is applied to the line.

The hoist frame attaches to a quick release bracket which can then be mated to the various Pelsue structures and components.



PH Series Hoist  
&  
BGWS Carrying Case

## Standard Quick Connect Brackets

Model	Description	Weight
<b>PH05C</b>	50' SS Cable	24 Lbs
<b>PH07C</b>	70' SS Cable	25 Lbs
<b>PH10C</b>	100' SS Cable	30 Lbs
<b>PH15C</b>	150' SS Cable	32 Lbs
<b>PH20C</b>	200' SS Cable	39 Lbs
<b>PH30C</b>	300' SS Cable	43 Lbs
<b>PH05R</b>	50' Synth. Rope	20 Lbs
<b>PH07R</b>	70' Synth. Rope	21 Lbs
<b>PH10R</b>	100' Synth. Rope	26 Lbs
<b>PH15R</b>	150' Synth. Rope	29 Lbs

## Tripod Brackets (For use on tripods only)

Model	Description	Weight
<b>PHT07C</b>	70' SS Cable	25 Lbs
<b>PHT10C</b>	100' SS Cable	30 Lbs
<b>PHT15C</b>	150' SS Cable	32 Lbs
<b>PHT20C</b>	200' SS Cable	39 Lbs
<b>PHT30C</b>	300' SS Cable	43 Lbs
<b>PHT07R</b>	70' Synth. Rope	21 Lbs
<b>PHT10R</b>	100' Synth. Rope	26 Lbs
<b>PHT15R</b>	150' Synth. Rope	29 Lbs

### Features:

- Man rated to 310 lbs.
- Secondary “overspeed” brake
- 5.5:1 gear ratio single speed drive
- Retrieval rate of 23' per minute
- Continuous braking drive prevents free wheeling
- Double pawls on friction brake provide back up safety
- Low wear, high temperature brake pads require minimal maintenance
- Anti-friction drive bearings assure trouble free life in continuous use
- Three permanent wraps of cable on the drum to

- assure low cable attachment loads
- Tensioner pad prevent loosening of cable lays
- Slip clutch drive prevents back winding of cable drum
- Zinc plated and anodized aluminum components reduces corrosion in harsh environments
- Mounting means provided for quick attachment
- Available with stainless steel cable or synthetic rope
- Removable drive handle with speeder knob
- Gear teeth cover
- Soft-sided carry case included

# Rescue & Retrieval



PWW SERIES WINCH



PWQR SERIES WINCH

## Winches

The Pelsue **PWQR** Series winch is designed to be a rescue/retrieval device. The **PWQR** Series winch shares many of the same qualities and capabilities as a standard **PW** Series winch but is unique in the fact that the lifting rope is not permanently fixed to the winch drum.

The Pelsue **PWW** Series work winch is designed to be an equipment hoisting and lowering device.

Model	Description
<b>PWQR-S45</b>	Winch, quick release rope w/ rope
<b>PWQRR-S45</b>	Winch, quick release rope, reverse w/ rope
<b>PWW07C</b>	Work winch

(Note: Use MA-PTI bracket if using with tripod.)

## Hoist/Winch Brackets

The MB Series brackets are required to mount the PH/PW series devices to either the Davit Retrieval System or Tripods. A variety of brackets and adapters are available to configure other manufacturer's winches or SRL's to Pelsue Retrieval equipment.

Model	Description
<b>PNUH-P700</b>	Surety/Honey Well Miller® Tripod Bracket & MSE tripod

Model	Description
<b>MB-PF1</b>	Quick-connect hoist bracket for Pelsue Davit Systems - flat
<b>MB-PC1</b>	Quick-connect hoist bracket for UniHoist Davit Systems - curved
<b>MB-TL1</b>	Quick-connect hoist bracket for Pelsue Rescue-P054 & RT07 tripod models
<b>MA-PT1</b>	Channel only for P054 Tripod (mounts to back plate on hoist)
<b>MB-SF1</b>	Honey Well Miller® SRL or Surety R Series SRL Adapter with a flat back (to Honey Well Miller® tripod 9054E - To mount to hoist box only)
<b>MB-SC1</b>	Honey Well Miller® SRL or Surety R Series SRL adapter with a curved back
<b>MB-CF1</b>	Selstrom RTC® hoist/SRL Adapter with a flat back
<b>MB-CC1</b>	Selstrom RTC® hoist/SRL Adapter with a curved back
<b>MB-RF1</b>	MSA ROSE® hoist/SRL Adapter with a flat back
<b>MB-RC1</b>	MSA ROSE® hoist/SRL Adapter with a curved back
<b>PSRL-BK</b>	Bracket to attach PSRL03100 series 3-way to Pelsue MB-PF1
<b>MB-FSB</b>	Bracket to attach QR to 3-way
<b>MB-FST</b>	Tripod bracket to 3-way

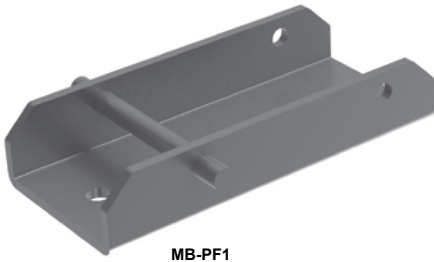

MB-PF1



MA-PT1

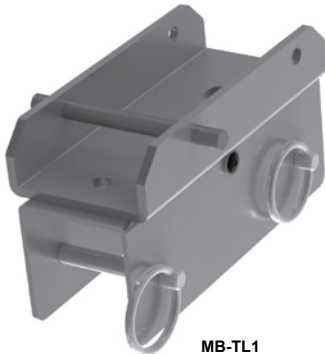

MB-TL1



MB-FSB

MB-FST

# Rescue & Retrieval

## Self Retracting Lifelines & 3-Way Units

Three-way recovery units & Self Retracting Lifelines are designed for use by construction workers, utility personnel, & maintenance repair employees needing on-the-job fall protection. The stopping distance for all models is less than 2'. These units are also used in confined spaces such as manholes, tanks, vaults, and other confined areas, where fall-arrest and retrieval rescue are extremely important.

As a general rule, OSHA requires the use of fall protection for anyone working six or more feet above the base level of any work area (OSHA 1926.501).

When entering a confined space by ladder or other fixed structure, or while being lowered mechanically by a man-rated winch, a worker must be attached to an independent lifeline for adequate fall protection.

Self Retracting Lifelines will only arrest a fall, they do not provide retrieval capabilities. The three-way recovery unit can be used for fall protection as well as retrieval if an emergency should occur. Can be mounted to the Davit Retrieval System or Tripod.

*Under no circumstances shall the three-way be used for routine raising and lowering (use a man-rated PH series hoist for raising and lowering).*

### Features:

- Arrest Distance within 2 feet
- Stress indicator to warn user that unit has arrested a fall
- 3/16" galvanized steel cable, stainless steel cable, Technora rope, or Webbing
- Cable Length: 25-65 ft. Webbing Length: 20-30 ft.
- Internal components made of bronze, stainless steel and aluminum
- Cast Aluminum housing protected with zinc plating
- Working Load: 310 lbs.

Self-retracting lifelines require a carabiner for attachment to anchorage.

**Designed to meet OSHA and EN standards.**

Model	Description
<b>PSRL1125-SS</b>	Retractable Lifeline (25') Stainless Steel Cable
<b>PSRL1125-TR</b>	Retractable Lifeline (25') Technora Rope w/lanyard
<b>PSRL1150-SS</b>	Retractable Lifeline (50') Stainless Steel Cable
<b>PSRL1150-TR</b>	Retractable Lifeline (50') Technora Rope

Model	Description
<b>PSRL1350-SSB</b>	3-way SRL/Retrieval/Decender with 3/16" x 50' Stainless Steel Cable
<b>PSRL1350-TRB</b>	3-way SRL/Retrieval/Decender with 1/4" x 50' Technora Rope
<b>PSRL1350-SST</b>	3-way SRL/Retrieval/Decender with 3/16" x 50' Stainless Steel Cable
<b>PSRL1350-TRB</b>	3-way SRL/Retrieval/Decender with 1/4" x 50' Technora Rope

\*The "B" designator indicates with standard quick connect bracket

\*The "T" designator indicates tripod bracket

Model	Description
<b>PSRL03100-SS</b>	Three-Way Recovery/Retractable Lifeline with 3/16" x 100" Stainless Steel Cable

\*Use PSRL-BK to attach to davit kit

Model	Description
<b>BGWS</b>	Carring case, fits all SRL's



3 WAY NEEDS TO BE RECERTIFIED EVERY 3 YRS UNLESS DROPPED THEN IT MUST BE REPLACED IMMEDIATELY



# **Fall Arrest**

# Fall Arrest

## UNI-LITE FALL ARREST TOWER



The Uni-Lite fall arrest tower is intended to provide an elevated fall arrest anchorage for up to three persons. The system is composed of a composite tube and cast aluminum base.

The upper insert features a 360° swivel tie off for attachment of up to three person fall arrest systems, when used in conjunction with a 900 lb.. MAF (Maximum Arrest Force) fall arrest device.

The composite tower is inserted into a cast aluminum vase that can be pinned in place to any one of the various base plates. It may be used with a number of different weld-on or bolt-on mounting bases (see below). May also be used with the adjustable anchor clamp.

This portable anchorage system can be used on top of transformers and other areas where walking/working surface hazards may be present.

Certified as a 3-person fall arrest anchorage as per OSHA Standard Guidelines.

Model	Description
FT-C70	Uni-Lite Fall Arrest Tower, 3 anchor points, carbon fiber

### Suggested Accessories

TFAT-14C	Telescopic tower, 10' to 14' for use with 500573-BD1
TFAT-11A	Telescopic tower, 6'-3" to 10'-10" single anchor
122870-001	Padded Carry Case For UniLite Tower & Base



FT-C70

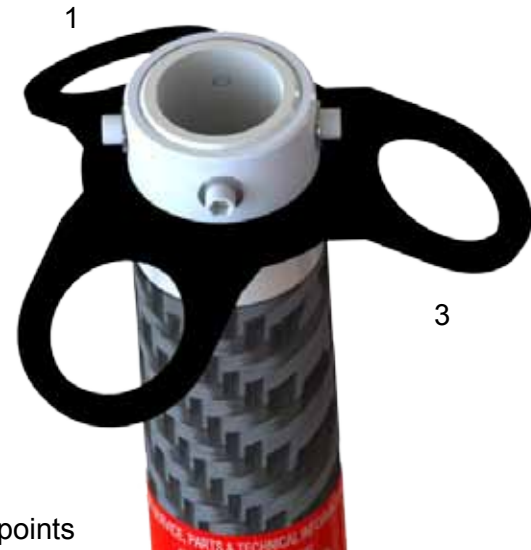

3 anchorage points

## TFAT TELESCOPIC FALL ARREST TOWER

The Pelsue TFAT-14C and TFAT-11A Telescopic Fall Arrest Tower is constructed of structural aluminum and incorporates several steel and engineered plastic components. The tower is designed as an accessory component to the Pelsue model FT-C70 UniLite Fall Arrest Tower. The model FT-C70 possesses a composite upper section (#500573-BD1) which can be inserted into its standard base (#500019-001) to create a 70" high anchor point or can be inserted into the TFAT-14C to create up to a 14' high anchor point. The TFAT-14C can only be used in conjunction with part #500573-BD1 composite fall arrest tower and is not rated for usage on its own, or with any other upper insert.

The base plates shown provide multiple attachment options for the various fall arrest towers. Once the base plate is attached, the tower simply pins in place for use. If you don't see a unit that works for your application, let us know and we'll be glad to engineer something for your needs.

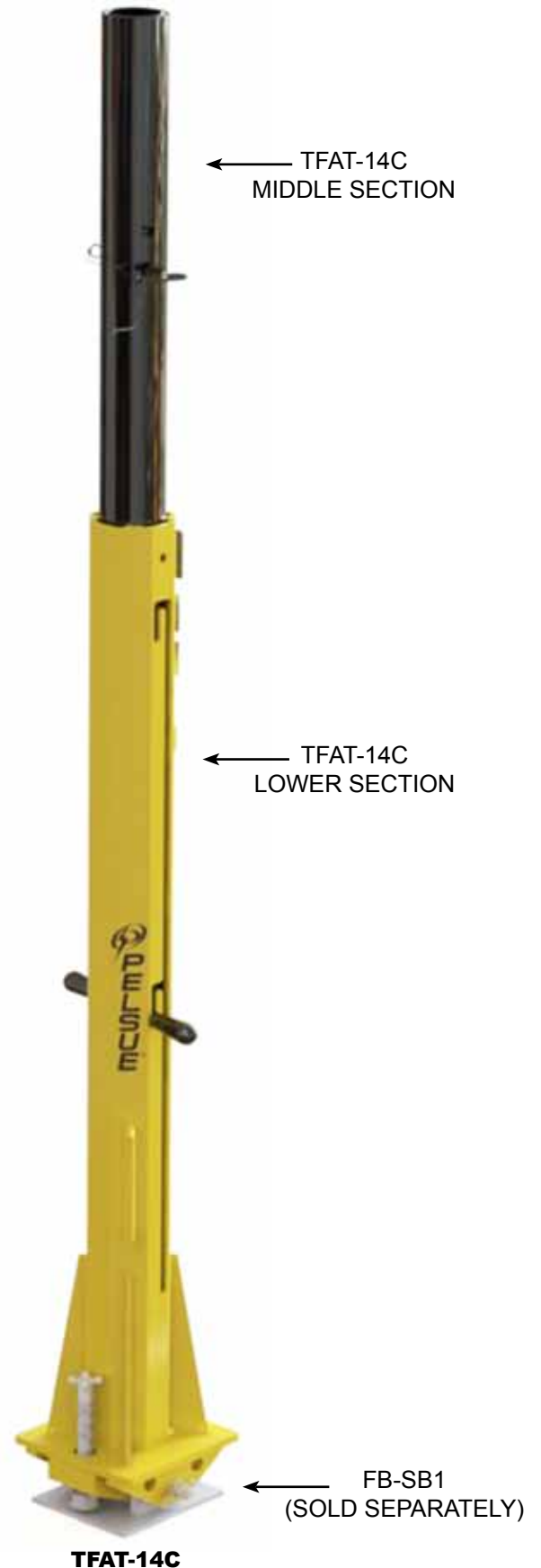



# Fall Arrest

## Fall Arrest Tower Base Plates

Model	Description
FB-SW1	Weld on Base Plate (shown)
FB-SB1	Bolt on Base Plate (shown)
FB-SW3	Weld on Base Plate with tie-off (shown)
FB-SB3	Bolt on Base Plate with tie-off (shown)
FB-BT1	Bolt on Base Plate Adapter
FB-VA1	Round Base Plate
FB-RB1	Round Base Plate for stud weld
BC-14S	Anchor Clamp Base - Adjustable, 4"-14" (shown)
SB-SM1	Anchor Clamp 4 Arm Adjustable Base, 19" (shown)
SB-SM2	Anchor Clamp 4 Arm Adjustable Base, 12" (shown)
BC-08A	Anchor Clamp Base - Adjustable Angle Beam Clamp, 3.5"-8"
AC-28R	Anchor Clamp - Fall Arrest Tower Base, 16"-28"
AC-28RX	Anchor Clamp - Fall Arrest Tower Base, 16"-28", Hex Drive
AC-34R	Anchor Clamp - Fall Arrest Tower Base, 19"-34"
AC-34RX	Anchor Clamp - Fall Arrest Tower Base, 19"-34", Hex Drive

Uni-Lite Fall Arrest Tower with AC-34RX in application



FB-SW1



FB-SB1



FB-SW3



FB-SB3



AC-34RX



BC-14S

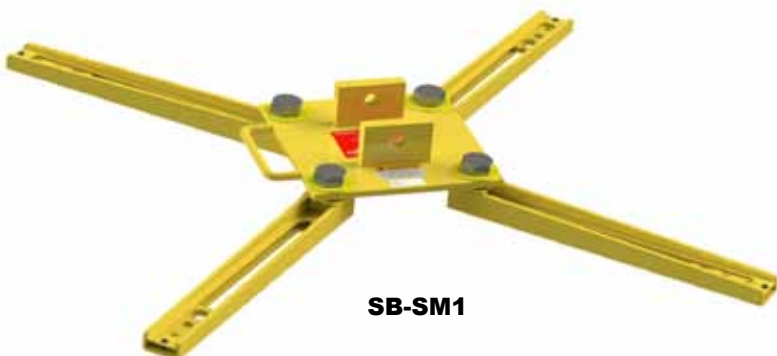

SB-SM1



BC-08A

## HARNESSES



### Pelsue Harnesses

Perfect for maintenance and construction workers. Pelsue harnesses feature adjustable shoulder, leg, and full waist straps, a sliding D-ring in the center of the back, all in a light weight, high strength synthetic webbing construction.



<b>Model</b>	<b>Description</b>
<b>PWX1800S</b>	Utility Full Body Harness, Small, Class III
<b>PWX1800M</b>	Utility Full Body Harness, Medium, Class III
<b>PWX1800L</b>	Utility Full Body Harness, Large, Class III
<b>PWX1800X</b>	Utility Full Body Harness, Extra Large, Class III
<b>PWX1705</b>	Utility Full Body Harness, Adjustable (Med. to Large), Class III

Englewood Factory  
Englewood, Colorado



Lamar Factory  
Lamar, Colorado





---

**PELSUE®** is proud to be associated with the following organizations:

---



**CSA**

Canadian Standards Association  
Headquarters in Montreal Canada  
Labs in Numerous Canadian Cities



**ISO**

The source of ISO 9001 and more than 13,000 International Standards for business, government and society. Based in Geneva, Switzerland



**CE**

French Prase Conformance Europeene, meaning European Conformance.



**ORI**

Orion Registrar Inc.



**C.E.E.S.I.**

Colorado Engineering & Experiment Station Inc.  
Headquarters & Lab in Nunn. CO.



**For all sales and inquiries please contact:**

**T.A. Pelsue Company  
2500 S. Tejon Street  
Englewood CO, 80110  
Toll Free: 1.800.525.8460  
Fax: 303.934.5581  
sales@pelsue.com  
www.pelsue.com**

**or**

**Your Local Sales Representative**

**Ваш поставщик:**

**ООО "КОМПАНИЯ ОПТУЛС"**

Москва, ул.Иловайская, д.3

Телефон: +7 (495) 646-00-96

Эл. почта: sale@opttools.ru

<https://www.opttools.ru>

**American Made  
Since 1963**