

# FTTx

# Communication Fiber Optics

Providing Fiber Optic Solutions For Over 35 Years



**FIBER OPTIC ENCLOSURES**

See Pages 64-79



**SPLICE-ON CONNECTORS**

Starting At Page 49



**ZEUS FTTx SOLUTION**

See Pages 80-87



**FIBER OPTIC TEST EQUIPMENT**

See Pages 20-48

**PURCHASE ONLINE**  
[WWW.FIBERINSTRUMENTSALES.COM](http://WWW.FIBERINSTRUMENTSALES.COM)  
FOR OUR FULL LINE OF PRODUCT OFFERINGS

Sales Representatives Are Waiting For Your Call!  
**Fiber Instrument Sales, Inc.**  
**1-800-5000-FIS(347)**

# PRESIDENT'S MESSAGE

## We know the world is full of choices. Thank you for choosing us!

It is fortunate that we service the ever increasing bandwidth requirement of today's world. We are grateful we have the support of both private enterprise and government.

The fiber optic companies, who now play a major role, have proven over the past decades the ability to provide timely performance and value. Thank you for including Fiber Instrument Sales in that group.

A notable market trend this year was the increased demand for fiber optic cable and fusion splicer equipment. Our experienced purchasing team committed to larger inventories. In doing so they prevented supply chain disruptions for our customers.

Proudly, we grew by 20% in 2021. Our company's sales now exceed \$120 million. We are also known as an industry leader in training. Our free two hour training video now exceeds 650,000 YouTube views for the year; the most viewed fiber optic training video in the industry.

We are breaking ground for a facility that will house newly purchased equipment such as extruders and metal punching equipment that will help us keep up with increased demand.

Please know that it is your support and dedication that energizes the people at Fiber Instrument Sales. Let us all prosper with the opportunity afforded our industry.

With appreciation,  
Frank Giotto  
President

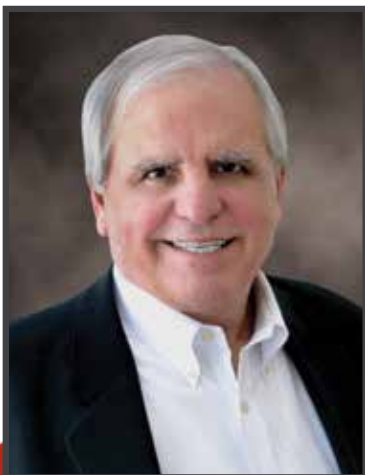

*Frank Giotto*

Frank Giotto  
President and CEO

## Investing In Our Customers

Throughout its 35 year history, FIS has reinvested much of its revenue back into the company. We created new programs and expanded our capabilities to fulfill a wide range of customer needs.

**Fiber Optic Manufacturing** - FIS manufactured products include fiber optic cable, interconnect boxes, connectors and custom cable assemblies. To our knowledge, FIS is the largest cable assembly house in the U.S.

**Full-Service Manufacturing** - FIS now offers plastics injection molding, CNC machining and metal bending/fabrication. We employ over 425 dedicated employees and our products are "Proudly Made in the USA."

**FIS University** - FIS has one of the longest running fiber optic training programs in the industry. We have trained over 25,000 technicians.

**Innovative Tech Support** - FIS Sales and Technical Staff are highly trained and eager to serve you. Our video conference room is the newest addition to our Tech Support Team.

**Product Availability** - FIS maintains a \$20 million product inventory, including network test and installation equipment from the world's leading manufacturers.

**Network Solutions** - FIS, The Solutionists, has the experience, size and resources to provide the solutions you need. Customers call it Safety of the Buy.

# FIBER INSTRUMENT SALES SALES TEAM · SERVICE · SUPPORT

## SALES TEAM



**Kirk Donley**  
Sr. Vice President  
Ext. 2104  
kdonley@fissales.com



**John Bruno**  
Vice President of  
Technical Services  
Ext. 2157  
jbruno@fissales.com



**Cindy Marino**  
Vice President of  
Government Sales  
Ext. 2140  
cmarino@fissales.com



**Steve Casaletta**  
Corporate Sales Director,  
PLM Fusion Splicing  
Products  
Ext. 2166  
scasaletta@fissales.com



**Trevor Francis**  
International Sales  
Manager / Strategic  
Accounts  
Ext. 2125  
tfrancis@fissales.com



**Anthony Russo**  
FTTx Sales Manager,  
PLM Fiber FTTX  
Products  
Ext. 2173  
arusso@fissales.com



**Steve Ermacor**  
PLM Fiber Optic  
Interconnects /  
Strategic Accounts  
Ext. 2123  
sermacor@fissales.com



**Robert Licari**  
Product Line Manager  
Test Equipment  
FIS University Instructor  
Ext. 2192  
rlcari@fissales.com



**Jim Fasano**  
FTTx Program  
Development  
Ext. 2143  
jfasano@fissales.com



**Ric Lamb**  
Product Line Manager  
Fiber Fence  
Ext. 2151  
rlamb@fissales.com

\* PLM - Product Line Manager

## INTERNATIONAL



**Kayla Angelhow**  
Intl. Sales Associate  
Ext. 2111  
kangelhow@fissales.com



**Casner Chapoteau**  
Intl. Sales Associate  
Ext. 2116  
cchapoteau@fissales.com

## SALES MANAGER



**Jeff Baker**  
Sales Manager  
Ext. 2141  
jbaker@fissales.com

## INTERNET SALES



**John Russo**  
Sales Associate /  
Internet Sales  
Ext. 2161  
jrusso@fissales.com



**Don Shantal**  
Sales Support /  
Internet Sales  
Ext. 2170  
dshantal@fissales.com

## RENTALS & CALIBRATIONS



**Jesse Simonds**  
Calibration Services  
Ext. 2114  
jsimonds@fissales.com



**Seth Colangelo**  
Rental Services  
Ext. 2168  
scolangelo@fissales.com

## Region 1 & Region 2 Sales Team



**Sue Muraca**  
Corporate Accounts  
Manager/Region 1&2  
Ext. 2160  
smuraca@fissales.com



**Sally Fenton**  
Corporate Accounts  
Manager/Region 1&2  
Ext. 2181  
sfenton@fissales.com



**Trista Piccione**  
Sr. Account Exec /  
Product Specialist  
Cable Assemblies  
Ext. 2189  
tpiccione@fissales.com



**Jennifer Stinger**  
Sr. Sales Associate  
Ext. 2185  
jstinger@fissales.com



**John DeMetro**  
Corporate Accounts  
Manager/Region 1&2  
Ext. 2131  
jdemetro@fissales.com



**Adam Norsen**  
Sales Associate  
Ext. 2139  
anorsen@fissales.com



**Calvin Lang Jr.**  
Sales Associate  
Ext. 2146  
clang@fissales.com



**Megan Harvey**  
Sales Associate  
Ext. 2113  
mharvey@fissales.com

## Region 3 & Region 4 Sales Team



**Ruth Mittiga**  
Sr. Account Executive  
Ext. 2128  
rmittiga@fissales.com



**Alicia Aldi**  
Account Executive  
Ext. 2149  
aaldi@fissales.com



**Phil Kamp**  
Sr. Sales Associate  
Ext. 2154  
pkamp@fissales.com



**Brandon Schmidt**  
Sales Associate  
Ext. 2145  
bschmidt@fissales.com



**Amber Corigliano**  
Sales Associate  
Ext. 2103  
acorigliano@fissales.com



**Mary Sokolowski**  
Sales Associate  
Ext. 2164  
marys@fissales.com



**Nicolas Alexander**  
Sales Associate  
Ext. 2132  
nalexander@fissales.com



**Seth Colangelo**  
Sales Associate  
Ext. 2168  
scolangelo@fissales.com

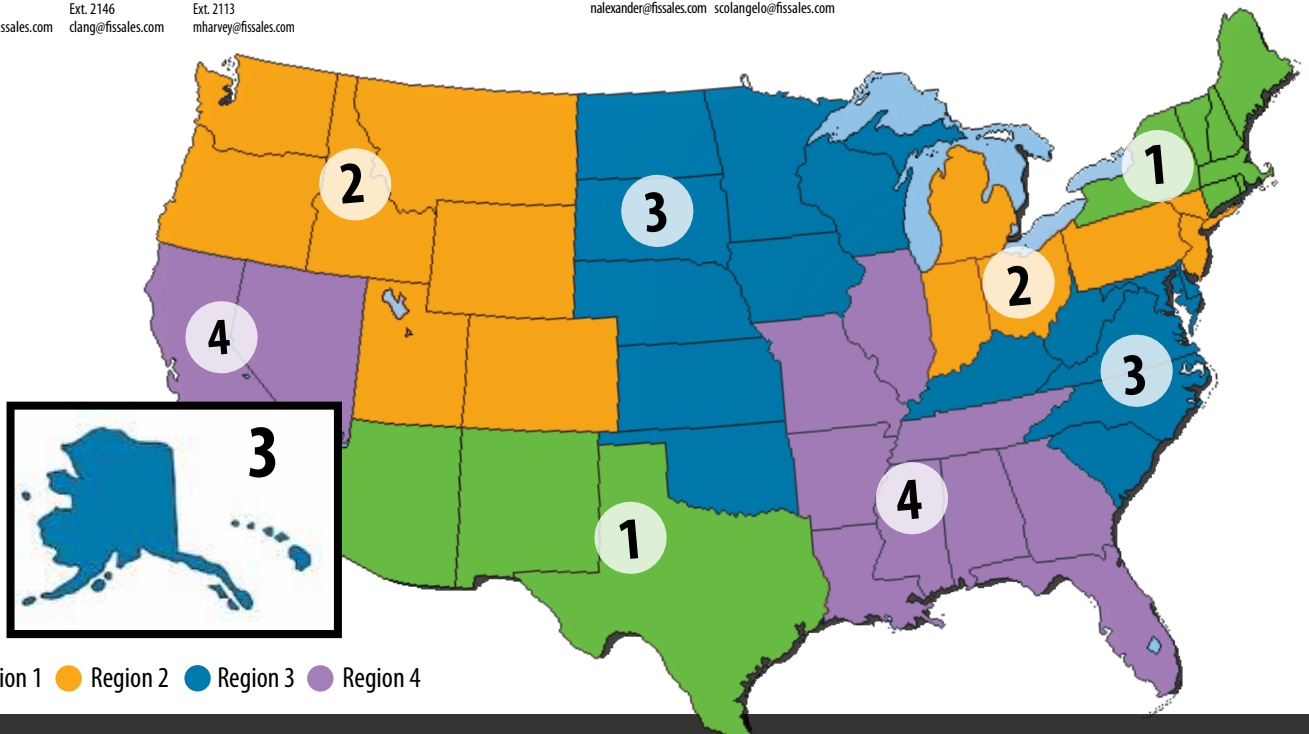



## Custom Manufactured Fiber Optic Products with Fiber Instrument Sales

*Fiber Instrument Sales is a leading manufacturer of fiber optic products and accessories. Rack and wall mount interconnects, custom cable assemblies, connectors, and test equipment. We also offer custom fiber optic cable, plastic injection molding, CNC machining and metal bending/fabrication. FIS is a trusted American manufacturer who stands behind their product and who provides excellent technical support through their highly trained sales associates and product line managers. FIS products are 100% made in the USA at our facilities located in central upstate New York.*



**CALL FOR CUSTOM QUOTES!  
1-800-5000-FIS(347)**

### INTERESTED IN SAVING MONEY?

#### LET FIS SAVE YOU MONEY BY REPAIRING DAMAGED ASSEMBLIES, PULSE BOXES AND SPLITTERS.

Fiber Instrument Sales is now offering repair services for Fiber Optic Assemblies, Pulse Boxes, and Splitters. At FIS we know that providing options for our customers to save time and money is critical for business growth. By utilizing our repair service your used products can often be repaired for a fraction of the cost of new.

Our service begins with an evaluation of every product to determine if a repair can be accomplished. We will communicate the suggested repair information and begin work with your approval. Documentation and Testing will be provided for all repairs.

*Note: Not every product is repairable, in the case of a product that cannot be repaired the Evaluation fee will be billed accordingly.*



**Call and speak with a Sales Representative Today  
1-800-5000-FIS(347)**

# 2022-2023 NEW PRODUCTS

## FIS Server/Network Cabinets

pg. 78



## FIS OTDRS

pgs. 20-21



## FIS Mini MPO Visual Fault Locator

pg. 47



• Shown with optional  
Optical Polarity Verifier

## FIS Fiber Inspection Probe

pg. 44



## FIS Patch & Splice Cassette Kits

pg. 68



## FIS Compact Wallmounts

pg. 69



## FIS OTDR Fiber Optic Launch & Receive Kit

pg. 37



## FIS Mini Armored Cable

pg. 101



## AFL FlowScout™ PON Optical Power Meter

pg. 42



## Sumitomo Q502S Active Clad Alignment Fusion Splicer

pg. 57



## Viavi T-Berd 4000v2 Bi-Fiber Complete (loss test set)

pg. 43



## MDC 2-Fiber Cable Assemblies & Enclosures

pg. 11



# Continuing to be Your **Fiber-Optic Information Source**

## Website

[www.fiberinstrumentsales.com](http://www.fiberinstrumentsales.com)

In addition to online shopping, the FIS website offers a wealth of information to make your job easier and more productive. Spec sheets, white papers, training videos, and Communicator Newsletter – all are accessible online.



**Shop 24/7  
Online**



## Live Tech Help

Our sales people and tech support are available by phone as well as online, via our website. You can even access our President and CEO, Frank Giotto. Just click on the link, "Ask the President."



## Tutorial Videos

Fusion splicing, fiber termination and network testing are just a few of the informative FIS videos available to you. Videos can be accessed through the FIS Website. Clear and concise, FIS tutorial videos are the next best thing to receiving classroom training.



## We have a Connection!

With our Video Conference Room FIS is able to provide training and technical support to our customers with ease. This support includes several different types of equipment such as fusion splicers, OTDRs, connector termination kits, and optical loss test sets and much more. **Let us know if you're interested in setting up a video conference call**



## You will love our Configurator

Today's network installations sometimes require customized solutions and here at FIS we are ready to put together a solution that will make your job easier. Do you need to connect a piece of equipment that is further away from the enclosure than a standard length patch cable? Let us build you a custom length patch cable! Our standard turnaround time is 2 to 4 business days. Let's make your custom solution together!



## Communicator Newsletter

This quarterly publication is a great tool for helping you make informed purchase decisions. For example, various issues of Communicator have provided guidance in selecting the right fusion splicer, OTDR, splice closure and more. Refer to these Communicator "buying guides" when making important purchase decisions. All issues are available in the Communicator Archives on the FIS website.



# TABLE OF CONTENTS

## Assemblies

Singlemode, ClearCurve®	7
Multimode 10 Gig OM3 / OM4	8
Multimode OM2 / OM1	9
Custom Assemblies	10
MTP Cable Assemblies	12
Mode Conditioning	14
Specialty Optical Assemblies	14
Coupler/Splitter Modules	15
Broadcast/Military	16

## Test Equipment

OTDRs	20
Wireless Test Equipment	30
Testing Accessories	36
Pulse / Test Boxes	37
Fiber Optic Identifiers	38
Power Meter & Light Sources	40
Fiber Inspection	44
Fault Locators	46
MPO Testing	48

## Splicing

Fusion Splicers	50
Splice-On Connectors	50
Cleavers	60
Mechanical Splices	62
Splice Protection Sleeves	63

## Enclosures (Indoor)

Rack Mount Enclosures	64
Wall Mount Enclosures	66
Adapter Panels	70
Pigtails / Snap Packs	71
Splice Trays	76
Racks	78
Custom Enclosures	79
Cable Management	79

## ZEUS FTTx Solution

80

## Enclosures (Outdoor)

NIDs	82
Outdoor Drop Cable Enclosures	83
Outdoor Splice Closures	85
Couplers/Splitters	86
CWDM/DWDM	87
Snowshoes	92
ADSS Hardware	93

## Cable

250µm / 900µm / Large Core	95
Simplex / Duplex	96
Distribution	98
Indoor/Outdoor	99
Outdoor	100
Aluminum Interlocking Armor	100
Drop Cable	101
Furcation Tube	102
Breakout / Fanout Kits	103

## Consumables

Wipes	104
Cleaning Solutions	105
Dry Cleaners	109
Swabs	110
Cleaning Kits	111

## Tools

Tool Kits	112
Stripping & Tools	116
Hand Tools	117
Slitting Tools	118
MidAccess Tools	119
Scribes & Crimpers	120
Hand Tools	121
Cable Pulling	123
Tie Wraps & Accessories	124
Marking and Labeling	125
Tents	127
Innerduct	128
Pulling Eye	128

## Connectivity

Splice-On Connectors	50
Quick Termination	130
Standard Connectors	132
Small Form Factor Connectors	135
Boots & Accessories	136
Epoxy	138
Connector Ovens	139
Polishing	140
Adapters	146
Attenuators	149

## FIBER FENCE Security

151

## Drilled Ferrules

152

## Copper

Category 5e, 6 / Cable	154
Copper Testing	155
Wall Plates / Jacks	156
Patch Panels	156

## Network Equipment

SFPs	157
Media Converters & Switches	160
Hardened Environment Switches	162
Video TX & RX	163

## FIS University

Training Classes	164
Training Material	165

## Services

Equipment Rentals	166
Calibration	167
Financing	167



**3mm ST-ST UPC SIMPLEX**

PART #	LENGTH	PRICE
S98U8US1FISCU	1 Meter	\$5.00
S98U8US2FISCU	2 Meters	5.15
S98U8US3FISCU	3 Meters	5.35
S98U8US5FISCU	5 Meters	5.65
S98U8US10FISCU	10 Meters	6.45



**3mm ST-SC UPC SIMPLEX**

PART #	LENGTH	PRICE
S98UYUS1FISCU	1 Meter	\$5.00
S98UYUS2FISCU	2 Meters	5.15
S98UYUS3FISCU	3 Meters	5.35
S98UYUS5FISCU	5 Meters	5.65
S98UYUS10FISCU	10 Meters	6.45



**3mm SC-SC UPC SIMPLEX**

PART #	LENGTH	PRICE
S9YUYUS1FISCU	1 Meter	\$5.00
S9YUYUS2FISCU	2 Meters	5.15
S9YUYUS3FISCU	3 Meters	5.35
S9YUYUS5FISCU	5 Meters	5.65
S9YUYUS10FISCU	10 Meters	6.45



**1.6mm LC-LC UPC SIMPLEX**

PART #	LENGTH	PRICE
Y9LULUS1FISCU	1 Meter	\$5.70
Y9LULUS2FISCU	2 Meters	5.85
Y9LULUS3FISCU	3 Meters	6.00
Y9LULUS5FISCU	5 Meters	6.35
Y9LULUS10FISCU	10 Meters	7.15



**1.6mm LC-SC UPC SIMPLEX**

PART #	LENGTH	PRICE
Y9LUYUS1FISCU	1 Meter	\$5.35
Y9LUYUS2FISCU	2 Meters	5.50
Y9LUYUS3FISCU	3 Meters	5.70
Y9LUYUS5FISCU	5 Meters	6.00
Y9LUYUS10FISCU	10 Meters	6.80



**3mm FC-FC UPC SIMPLEX**

PART #	LENGTH	PRICE
S97U7US1FISCU	1 Meter	\$5.00
S97U7US2FISCU	2 Meters	5.15
S97U7US3FISCU	3 Meters	5.35
S97U7US5FISCU	5 Meters	5.65
S97U7US10FISCU	10 Meters	6.45

### CORNING® SMF-28® ULTRA FIBER SM PATCH CABLES



**1.6mm LC-SC UPC DUPLEX**

PART #	LENGTH	PRICE
X9LUYUS1FISCU	1 Meter	\$10.70
X9LUYUS2FISCU	2 Meters	11.00
X9LUYUS3FISCU	3 Meters	11.35
X9LUYUS5FISCU	5 Meters	11.95
X9LUYUS10FISCU	10 Meters	13.55



**1.6mm LC-LC UPC DUPLEX**

PART #	LENGTH	PRICE
X9LULUS1FISCU	1 Meter	\$11.35
X9LULUS2FISCU	2 Meters	11.70
X9LULUS3FISCU	3 Meters	12.00
X9LULUS5FISCU	5 Meters	12.65
X9LULUS10FISCU	10 Meters	14.25



**3mm SC-SC UPC DUPLEX**

PART #	LENGTH	PRICE
D9YUYUS1FISCU	1 Meter	\$10.00
D9YUYUS2FISCU	2 Meters	10.30
D9YUYUS3FISCU	3 Meters	10.65
D9YUYUS5FISCU	5 Meters	11.40
D9YUYUS10FISCU	10 Meters	12.85



**3mm ST-ST UPC DUPLEX**

PART #	LENGTH	PRICE
D98U8US1FISCU	1 Meter	\$10.00
D98U8US2FISCU	2 Meters	10.30
D98U8US3FISCU	3 Meters	10.65
D98U8US5FISCU	5 Meters	11.40
D98U8US10FISCU	10 Meters	12.85



**3mm ST-SC UPC DUPLEX**

PART #	LENGTH	PRICE
D98UYUS1FISCU	1 Meter	\$10.00
D98UYUS2FISCU	2 Meters	10.30
D98UYUS3FISCU	3 Meters	10.65
D98UYUS5FISCU	5 Meters	11.40
D98UYUS10FISCU	10 Meters	12.85



**3mm FC-FC UPC DUPLEX**

PART #	LENGTH	PRICE
D97U7US1FISCU	1 Meter	\$10.00
D97U7US2FISCU	2 Meters	10.30
D97U7US3FISCU	3 Meters	10.65
D97U7US5FISCU	5 Meters	11.40
D97U7US10FISCU	10 Meters	12.85





**1.6mm LC-LC APC SIMPLEX**

PART #	LENGTH	PRICE
Y9LALAS1FISCU	1 Meter	\$6.20
Y9LALAS2FISCU	2 Meters	6.35
Y9LALAS3FISCU	3 Meters	6.50
Y9LALAS5FISCU	5 Meters	6.80
Y9LALAS10FISCU	10 Meters	7.60



**3mm SC-SC APC SIMPLEX**

PART #	LENGTH	PRICE
S9YAYAS1FISCU	1 Meter	\$5.60
S9YAYAS2FISCU	2 Meters	5.70
S9YAYAS3FISCU	3 Meters	5.90
S9YAYAS5FISCU	5 Meters	6.20
S9YAYAS10FISCU	10 Meters	7.00



**3mm FC-FC APC SIMPLEX**

PART #	LENGTH	PRICE
S97A7AS1FISCU	1 Meter	\$5.60
S97A7AS2FISCU	2 Meters	5.70
S97A7AS3FISCU	3 Meters	5.90
S97A7AS5FISCU	5 Meters	6.20
S97A7AS10FISCU	10 Meters	7.00



**1.6mm LC-LC APC DUPLEX**

PART #	LENGTH	PRICE
X9LALAS1FISCU	1 Meter	\$12.35
X9LALAS2FISCU	2 Meters	12.65
X9LALAS3FISCU	3 Meters	13.00
X9LALAS5FISCU	5 Meters	13.60
X9LALAS10FISCU	10 Meters	15.20



**3mm SC-SC APC DUPLEX**

PART #	LENGTH	PRICE
D9YAYAS1FISCU	1 Meter	\$11.10
D9YAYAS2FISCU	2 Meters	11.40
D9YAYAS3FISCU	3 Meters	11.75
D9YAYAS5FISCU	5 Meters	12.35
D9YAYAS10FISCU	10 Meters	13.95



**3mm FC-SC APC DUPLEX**

PART #	LENGTH	PRICE
D97AYAS1FISCU	1 Meter	\$11.10
D97AYAS2FISCU	2 Meters	11.40
D97AYAS3FISCU	3 Meters	11.75
D97AYAS5FISCU	5 Meters	12.35
D97AYAS10FISCU	10 Meters	13.95

**CORNING® SMF-28® ULTRA FIBER SM PATCH CABLES**



**1.6mm SC/APC - LC/UPC SIMPLEX**

PART #	LENGTH	PRICE
Y9YALUS1FISCU	1 Meter	\$5.65
Y9YALUS2FISCU	2 Meters	5.80
Y9YALUS3FISCU	3 Meters	5.95
Y9YALUS5FISCU	5 Meters	6.25
Y9YALUS10FISCU	10 Meters	7.05



**1.6mm LC-SC APC SIMPLEX**

PART #	LENGTH	PRICE
Y9YALAS1FISCU	1 Meter	\$5.90
Y9YALAS2FISCU	2 Meters	6.00
Y9YALAS3FISCU	3 Meters	6.20
Y9YALAS5FISCU	5 Meters	6.50
Y9YALAS10FISCU	10 Meters	7.30



**3mm FC-SC APC SIMPLEX**

PART #	LENGTH	PRICE
S9YA7AS1FISCU	1 Meter	\$5.60
S9YA7AS2FISCU	2 Meters	5.70
S9YA7AS3FISCU	3 Meters	5.90
S9YA7AS5FISCU	5 Meters	6.20
S9YA7AS10FISCU	10 Meters	6.70



**1.6mm LC/APC - SC/UPC DUPLEX**

PART #	LENGTH	PRICE
X9LAYUS1FISCU	1 Meter	\$11.15
X9LAYUS2FISCU	2 Meters	11.45
X9LAYUS3FISCU	3 Meters	11.80
X9LAYUS5FISCU	5 Meters	12.45
X9LAYUS10FISCU	10 Meters	14.00



**1.6mm LC-LC UPC UNI-BOOT DUPLEX**

PART #	LENGTH	PRICE
X9LULUS1FISCUNI	1 Meter	\$16.90
X9LULUS2FISCUNI	2 Meters	17.20
X9LULUS3FISCUNI	3 Meters	17.50
X9LULUS5FISCUNI	5 Meters	18.15
X9LULUS10FISCUNI	10 Meters	19.75



**1.6mm LC-LC APC UNI-BOOT DUPLEX**

PART #	LENGTH	PRICE
X9LALAS1FISCUNI	1 Meter	\$18.10
X9LALAS2FISCUNI	2 Meters	18.45
X9LALAS3FISCUNI	3 Meters	18.75
X9LALAS5FISCUNI	5 Meters	19.40
X9LALAS10FISCUNI	10 Meters	21.00



### 1.6mm SC-SC PC SIMPLEX - 50µm OM3

PART #	LENGTH	PRICE
Y8YYM1FISC	1 Meter	\$4.80
Y8YYM2FISC	2 Meters	5.25
Y8YYM3FISC	3 Meters	5.70
Y8YYM5FISC	5 Meters	6.60
Y8YYM10FISC	10 Meters	8.85



### 1.6mm LC-LC PC SIMPLEX - 50µm OM3

PART #	LENGTH	PRICE
Y8LLM1FISC	1 Meter	\$5.45
Y8LLM2FISC	2 Meters	5.90
Y8LLM3FISC	3 Meters	6.35
Y8LLM5FISC	5 Meters	7.25
Y8LLM10FISC	10 Meters	9.45



### 1.6mm ST-ST PC SIMPLEX - 50µm OM3

PART #	LENGTH	PRICE
Y888M1FISC	1 Meter	\$4.80
Y888M2FISC	2 Meters	5.25
Y888M3FISC	3 Meters	5.70
Y888M5FISC	5 Meters	6.60
Y888M10FISC	10 Meters	8.85



### 1.6mm LC-SC PC SIMPLEX - 50µm OM3

PART #	LENGTH	PRICE
Y8LYM1FISC	1 Meter	\$5.15
Y8LYM2FISC	2 Meters	5.60
Y8LYM3FISC	3 Meters	6.00
Y8LYM5FISC	5 Meters	6.90
Y8LYM10FISC	10 Meters	9.15



### 1.6mm SC-ST PC SIMPLEX - 50µm OM3

PART #	LENGTH	PRICE
Y8Y8M1FISC	1 Meter	\$4.80
Y8Y8M2FISC	2 Meters	5.25
Y8Y8M3FISC	3 Meters	5.70
Y8Y8M5FISC	5 Meters	6.60
Y8Y8M10FISC	10 Meters	8.85



### 1.6mm LC-ST PC SIMPLEX - 50µm OM3

PART #	LENGTH	PRICE
Y8L8M1FISC	1 Meter	\$5.15
Y8L8M2FISC	2 Meters	5.60
Y8L8M3FISC	3 Meters	6.00
Y8L8M5FISC	5 Meters	6.90
Y8L8M10FISC	10 Meters	9.15



### 1.6mm ST-ST PC DUPLEX - 50µm OM3

PART #	LENGTH	PRICE
X888M1FISC	1 Meter	\$9.60
X888M2FISC	2 Meters	10.50
X888M3FISC	3 Meters	11.40
X888M5FISC	5 Meters	13.20
X888M10FISC	10 Meters	17.70



### 1.6mm SC-ST PC DUPLEX - 50µm OM3

PART #	LENGTH	PRICE
X8Y8M1FISC	1 Meter	\$9.60
X8Y8M2FISC	2 Meters	10.50
X8Y8M3FISC	3 Meters	11.40
X8Y8M5FISC	5 Meters	13.20
X8Y8M10FISC	10 Meters	17.70



### 1.6mm LC-ST PC DUPLEX - 50µm OM3

PART #	LENGTH	PRICE
X8L8M1FISC	1 Meter	\$10.25
X8L8M2FISC	2 Meters	11.15
X8L8M3FISC	3 Meters	12.00
X8L8M5FISC	5 Meters	13.80
X8L8M10FISC	10 Meters	18.30



### 1.6mm SC-SC PC DUPLEX - 50µm OM3

PART #	LENGTH	PRICE
X8YYM1FISC	1 Meter	\$9.60
X8YYM2FISC	2 Meters	10.50
X8YYM3FISC	3 Meters	11.40
X8YYM5FISC	5 Meters	13.20
X8YYM10FISC	10 Meters	17.70



### 1.6mm LC-LC PC DUPLEX - 50µm OM3

PART #	LENGTH	PRICE
X8LLM1FISC	1 Meter	\$10.85
X8LLM2FISC	2 Meters	11.75
X8LLM3FISC	3 Meters	12.65
X8LLM5FISC	5 Meters	14.45
X8LLM10FISC	10 Meters	18.90



### 1.6mm LC-SC PC DUPLEX - 50µm OM3

PART #	LENGTH	PRICE
X8LYM1FISC	1 Meter	\$10.25
X8LYM2FISC	2 Meters	11.15
X8LYM3FISC	3 Meters	12.00
X8LYM5FISC	5 Meters	13.80
X8LYM10FISC	10 Meters	18.30

### 1.6mm SC-SC PC DUPLEX - 50µm OM4

PART #	LENGTH	PRICE
X10YYM1FISC	1 Meter	\$10.05
X10YYM2FISC	2 Meters	11.35
X10YYM3FISC	3 Meters	12.70
X10YYM5FISC	5 Meters	15.35
X10YYM10FISC	10 Meters	22.00

### 1.6mm LC-LC PC DUPLEX - 50µm OM4

PART #	LENGTH	PRICE
X10LLM1FISC	1 Meter	\$11.30
X10LLM2FISC	2 Meters	12.60
X10LLM3FISC	3 Meters	13.95
X10LLM5FISC	5 Meters	16.60
X10LLM10FISC	10 Meters	23.25

### 1.6mm LC-SC PC DUPLEX - 50µm OM4

PART #	LENGTH	PRICE
X10LYM1FISC	1 Meter	\$10.70
X10LYM2FISC	2 Meter	12.00
X10LYM3FISC	3 Meter	13.35
X10LYM5FISC	5 Meter	16.00
X10LYM10FISC	10 Meter	22.65

**3MM ST-ST SIMPLEX - 50µm OM2**

PART #	LENGTH	PRICE
S188M1FISC	1 Meter	\$4.70
S188M2FISC	2 Meters	5.00
S188M3FISC	3 Meters	5.35
S188M5FISC	5 Meters	6.05
S188M10FISC	10 Meters	7.70

**3MM ST-ST SIMPLEX - 62.5µm OM1**

S288M1FISC	1 Meter	\$4.70
S288M2FISC	2 Meters	5.00
S288M3FISC	3 Meters	5.35
S288M5FISC	5 Meters	6.05
S288M10FISC	10 Meters	7.70



**3MM SC-SC SIMPLEX - 50µm OM2**

PART #	LENGTH	PRICE
S1YYM1FISC	1 Meter	\$4.70
S1YYM2FISC	2 Meters	5.00
S1YYM3FISC	3 Meters	5.35
S1YYM5FISC	5 Meters	6.05
S1YYM10FISC	10 Meters	7.70

**3MM SC-SC SIMPLEX - 62.5µm OM1**

S2YYM1FISC	1 Meter	\$4.70
S2YYM2FISC	2 Meters	5.00
S2YYM3FISC	3 Meters	5.35
S2YYM5FISC	5 Meters	6.05
S2YYM10FISC	10 Meters	7.70



**1.6MM LC-LC SIMPLEX - 50µm OM2**

PART #	LENGTH	PRICE
Y1LLM1FISC	1 Meter	\$5.35
Y1LLM2FISC	2 Meters	5.65
Y1LLM3FISC	3 Meters	6.00
Y1LLM5FISC	5 Meters	6.70
Y1LLM10FISC	10 Meters	8.35

**1.6MM LC-LC SIMPLEX - 62.5µm OM1**

Y2LLM1FISC	1 Meter	\$5.35
Y2LLM2FISC	2 Meters	5.65
Y2LLM3FISC	3 Meters	6.00
Y2LLM5FISC	5 Meters	6.70
Y2LLM10FISC	10 Meters	8.35



**3MM ST-ST DUPLEX - 50µm OM2**

PART #	LENGTH	PRICE
D188M1FISC	1 Meter	\$9.35
D188M2FISC	2 Meters	10.05
D188M3FISC	3 Meters	10.70
D188M5FISC	5 Meters	12.05
D188M10FISC	10 Meters	15.35

**3MM ST-ST DUPLEX - 62.5µm OM1**

D288M1FISC	1 Meter	\$9.35
D288M2FISC	2 Meters	10.05
D288M3FISC	3 Meters	10.70
D288M5FISC	5 Meters	12.05
D288M10FISC	10 Meters	15.35

**3MM SC-SC DUPLEX - 50µm OM2**

PART #	LENGTH	PRICE
D1YYM1FISC	1 Meter	\$9.35
D1YYM2FISC	2 Meters	10.05
D1YYM3FISC	3 Meters	10.70
D1YYM5FISC	5 Meters	12.05
D1YYM10FISC	10 Meters	15.35

**3MM SC-SC DUPLEX - 62.5µm OM1**

D2YYM1FISC	1 Meter	\$9.35
D2YYM2FISC	2 Meters	10.05
D2YYM3FISC	3 Meters	10.70
D2YYM5FISC	5 Meters	12.05
D2YYM10FISC	10 Meters	15.35

**1.6MM LC-LC DUPLEX - 50µm OM2**

PART #	LENGTH	PRICE
X1LLM1FISC	1 Meter	\$10.60
X1LLM2FISC	2 Meters	11.30
X1LLM3FISC	3 Meters	11.95
X1LLM5FISC	5 Meters	13.30
X1LLM10FISC	10 Meters	16.60

**1.6MM LC-LC DUPLEX - 62.5µm OM1**

X2LLM1FISC	1 Meter	\$10.60
X2LLM2FISC	2 Meters	11.30
X2LLM3FISC	3 Meters	11.95
X2LLM5FISC	5 Meters	13.30
X2LLM10FISC	10 Meters	16.60

**CUSTOM LENGTHS AVAILABLE**

**QUANTITY PRICING IN STOCK**

**HYBRID PATCH CABLE**



**3MM ST-SC SIMPLEX - 62.5µm OM1**

PART #	LENGTH	PRICE
S28YM1FISC	1 Meter	\$4.70
S28YM2FISC	2 Meters	5.00
S28YM3FISC	3 Meters	5.35
S28YM5FISC	5 Meters	6.05
S28YM10FISC	10 Meters	7.70

**1.6MM ST-LC SIMPLEX - 62.5µm OM1**

PART #	LENGTH	PRICE
Y28LM1FISC	1 Meter	\$5.00
Y28LM2FISC	2 Meters	5.35
Y28LM3FISC	3 Meters	5.70
Y28LM5FISC	5 Meters	6.35
Y28LM10FISC	10 Meters	8.00

**1.6MM SC-LC SIMPLEX - 62.5µm OM1**

PART #	LENGTH	PRICE
Y2YLM1FISC	1 Meter	\$5.00
Y2YLM2FISC	2 Meters	5.35
Y2YLM3FISC	3 Meters	5.70
Y2YLM5FISC	5 Meters	6.35
Y2YLM10FISC	10 Meters	8.00

**3MM ST-SC DUPLEX - 50µm OM2**

PART #	LENGTH	PRICE
D18YM1FISC	1 Meter	\$9.35
D18YM2FISC	2 Meters	10.05
D18YM3FISC	3 Meters	10.70
D18YM5FISC	5 Meters	12.05
D18YM10FISC	10 Meters	15.35

**1.6MM ST-LC DUPLEX - 50µm OM2**

PART #	LENGTH	PRICE
X18LM1FISC	1 Meter	\$10.00
X18LM2FISC	2 Meters	10.70
X18LM3FISC	3 Meters	11.35
X18LM5FISC	5 Meters	12.70
X18LM10FISC	10 Meters	16.00

**1.6MM SC-LC DUPLEX - 50µm OM2**

PART #	LENGTH	PRICE
X1YLM1FISC	1 Meter	\$10.00
X1YLM2FISC	2 Meters	10.70
X1YLM3FISC	3 Meters	11.35
X1YLM5FISC	5 Meters	12.70
X1YLM10FISC	10 Meters	16.00

**3MM ST-SC DUPLEX - 62.5µm OM1**

D28YM1FISC	1 Meter	\$9.35
D28YM2FISC	2 Meters	10.05
D28YM3FISC	3 Meters	10.70
D28YM5FISC	5 Meters	12.05
D28YM10FISC	10 Meters	15.35

**1.6MM ST-LC DUPLEX - 62.5µm OM1**

X28LM1FISC	1 Meter	\$10.00
X28LM2FISC	2 Meters	10.70
X28LM3FISC	3 Meters	11.35
X28LM5FISC	5 Meters	12.70
X28LM10FISC	10 Meters	16.00

**1.6MM SC-LC DUPLEX - 62.5µm OM1**

X2YLM1FISC	1 Meter	\$10.00
X2YLM2FISC	2 Meters	10.70
X2YLM3FISC	3 Meters	11.35
X2YLM5FISC	5 Meters	12.70
X2YLM10FISC	10 Meters	16.00

# WHY IS FIS A LEADING SUPPLIER OF CUSTOM FIBER OPTIC ASSEMBLIES...

## 1. FLEXIBILITY

- Wide Selection of components from leading manufacturers
- Ability to build to Engineering specifications or drawings
- From a quantity of 1 or 1,000's FIS can deliver

## 2. FAST DELIVERY / HIGH QUALITY

- Cables are ready to ship nationwide and internationally in as little as 2-4 days
- 100% inspection and tested to industry standards
- ISO 9001-2015 Certified
- Over 30 years of cable assembly experience

## 3. ADDITIONAL SERVICES

- Termination of Customer Supplied Materials
- Creation of engineer drawings of assemblies
- Custom packaging, labeling
- Experienced engineering team to help design an assembly for any application

## SPECIFICATIONS

### LENGTH

#### SIMPLEX/DUPLEX

TOTAL LENGTH = -0/+3" (> 5 MTRS), -0/+10% (< 5 MTRS)

### TESTING

#### INSERTION LOSS

MULTIMODE = ≤ 0.4 dB (TYPICAL)

SINGLEMODE = ≤ 0.3 dB (TYPICAL)

## STANDARD CONFIGURATIONS

Standard configurations (typical lead-time 2-4 days) – Convert your next project to “plug n’ go” by having your cable assemblies pre-terminated by FIS. Our expert technicians prepare assemblies from a 1-fiber patch cable to 144-fiber assemblies, while offering a wide array of components for you to create the perfect assembly for your application.

## CUSTOM CONFIGURATIONS

Custom configurations (typical lead-time 3-5 days) – FIS has the ability to manufacture a variety of custom configurations. Our custom abilities include but are not limited to labeling, packaging, testing requirements, and building to customer supplied specifications and drawings.

#### MULTIFIBER

TOTAL LENGTH = -0/+3" (> 5 MTRS), -0/+10% (< 5 MTRS)

BREAKOUT = 1 MTR (-0/+3")

MAXIMUM CONNECTOR TO CONNECTOR STAGGER = 1.5"

#### RETURN LOSS

PC = ≤ -25dB

UPC = ≤ -55dB

APC = ≤ -60dB

## CUSTOM FIBER OPTIC CABLE USE THIS CHART TO BUILD THE CABLE YOU

CABLE TYPE	FIBER TYPE	CONNECTOR SIDE A / SIDE B		MODE
		7A	8U	
S	3	7A	8U	S
E = 250um Bare Fiber N = 900um Buffered Fiber Z = 1.2mm Simplex Y = 1.6mm Simplex F = 1.8mm Simplex T = 2.0mm Simplex S = 3.0mm Simplex X = 1.6mm Duplex H = 1.8mm Duplex V = 2.0mm Duplex D = 3.0mm Duplex PM = Polarization Maintaining LZ = LSZH Cable B = Breakout BA = Breakout Cable w/ Interlocking armor MD = MicroDistribution HD = High Density MicroDistribution C = Distribution R = Ribbon RF = Ribbon Fan Out RA = Ribbon Interlocking Armor Cable TB = Tactical/Broadcast Cable FD = Flat Drop Cable ENC = Epoxy Node Cable IG = Indoor/Outdoor 250um I = Indoor/Outdoor 900um L = Loose Tube LA = Loose Tube Armored AER = Aerial DB = Dry Block Cable Specialty DA = Outdoor Gel Free Armored Cable A = Armored Cable	1=50/125µm - OM2 2=62.5/125µm - OM1 3=8-9/125µm - OS2 4=Other 5=100/140µm 6=200/230µm 7=960/1000µm (plastic) 8=50µm 10Gig - OM3 (Bend Insensitive) 9=Singlemode (Ultra-Bend Insensitive) 10=50µm 10Gig - OM4 (Bend Insensitive) 12= 50µm 10Gig - OM5 (Bend Insensitive)	1=SMA905 2=SMA906 4=FC/Stainless Alloy 5=ST/Stainless Alloy 7=FC/PC 7A=FC/APC 7U=FC/UPC 8=ST/PC 8A=ST/APC 8U=ST/UPC Y=SC/PC YA=SC/APC YU=SC/UPC D=SC Duplex w/ Clips L=LC/PC LA=LC/APC LU=LC/UPC C=LC Duplex w/ Clips CU=LC Duplex w/Uniboot	F=Ferrule Only 9A=PM-FC/APC 9U=PM-FC/UPC P=Pigtail AA=High Performance FC/APC (decreases ORL) BA=High Performance SC/APC (decreases ORL) EA=E2000/APC EU=E2000/UPC MJ=MTRJ (no pins) MP=MTRJ (w/pins) MDC = MDC MA = MDC/APC SLA = Short Boot LC/APC SLU = Short Boot LC/UPC SYA = Short Boot SC/APC SYU = Short Boot SC/UPC	S= Singlemode M= Multimode H= Hybrid P= Polarization Maintaining Fiber (Slow Axis) F= Polarization Maintaining Fiber (Fast Axis)

See Pages 12 & 13 For MTP Assemblies

Note: Choose two connector styles from the chart one for Connector Side A and one for Connector Side B.



## DID YOU KNOW...

- **PLENUM (OFNP)** – refers to a specific fire code rating of cables that are resistant to fire and do not emit toxic fumes or smoke when burned. Plenum-rated cables are primarily used in pathways for either heated, cooled or return airflows.
- **RISER (OFNR)** – is constructed of PVC and may emit toxic fumes when burned and is to be run in non-plenum areas. Plenum cable can always replace riser cable, but riser cable cannot replace plenum cable in plenum spaces.

# CONFIGURATION ILLUSTRATION



**CLIPPED DUPLEX PATCH CABLE**  
Standard Polarity A to B / B to A



**SIMPLEX PATCH CABLE**

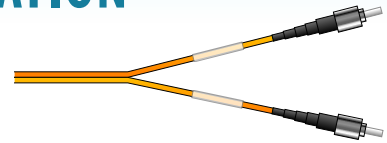

**UNCLIPPED DUPLEX PATCH CABLE**

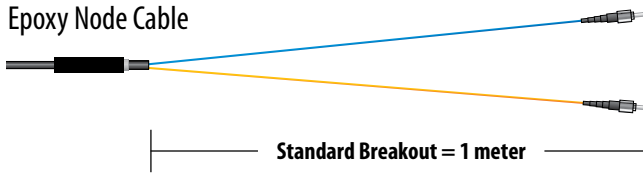

**NODE CABLE ASSEMBLY**

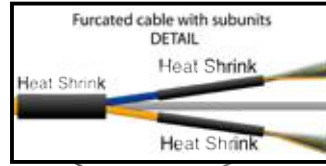

**DISTRIBUTION - INDOOR/OUTDOOR ASSEMBLY**  
2-144 Fiber (ex. 6 Fiber Assembly)

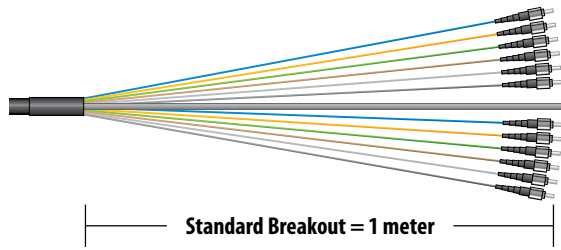

**LOOSE TUBE CABLE ASSEMBLY**



## ASSEMBLY CONFIGURATOR: NEED TO YOUR EXACT SPECIFICATIONS.

LENGTH (IN METERS)
X

CABLE RATING
RI
NP= No Preference RI= OFNR (Riser) PL= OFNP (Plenum) LZ= LSZH (Low Smoke) UV= Polyethylene/Outdoor

FIBER COUNT (Multi Fiber Only)
04
02=2Fiber 04=4 Fiber 06=6 Fiber 12=12 Fiber 24=24 Fiber 48=48 Fiber 72=72 Fiber 96=96 Fiber 144=144 Fiber *Specify Fiber Count not listed

BREAKOUT BUILD-UP (Multi Fiber Only)
Z3
Z9=900µm Z6=1.6mm Z1=1.8mm Z2=2.0mm Z3=3.0mm

SPOOLING OPTIONS
HC
HC=Hand Coil SP = Spool

PULLING EYE INSTALLED
PE
PE= Outside End Only PBE= Both Ends

All Duplex Clipped custom assemblies are A to B polarity. A to A polarity is available upon request!

**Part # Example:**  
**S-3-7A-8U-S-3-RI-HC-PE**

Translates to: Simplex 9/125 FC/APC - ST/UPC singlemode, 3meter, riser patch cable, hand coiled, with pulling eye

### ELIMENT™ MDC USCONEC™ NEW HIGH DENSITY, 2 FIBER CONNECTORS

US Conec's ELIMENT™ MDC connector is a Very Small Form Factor (VSFF) duplex optical connector designed for termination of Multi-mode and Single-mode fiber cables up to 2.0mm in diameter. The MDC connector is manufactured with proven 1.25mm ferrule technology used in industry standard LC optical connectors, meeting IEC 61753-1 Grade B insertion loss requirements. Contains (2) 1.25 mm ceramic ferrules (ferrules same as LC).

PART #	DESCRIPTION	PRICE
22082	9/125 SM UPC MDC 2 fiber connector, Blue, requires 1.6-2.0mm Round Cable	\$4.80
22083	9/125 SM APC MDC 2 fiber connector, Green, requires 1.6-2.0mm Round Cable	5.55
22084	OM3 50/125 MDC 2 fiber connector, Aqua, requires 1.6-2.0mm Round Cable	4.80
22236	OM4 50/125 MDC 2 fiber connector, Magenta, requires 1.6-2.0mm Round Cable	4.90
22237	OM5 50/125 MDC 2 fiber connector, Lime Green, requires 1.6-2.0mm Round Cable	4.80
21866	USConec 2 port SM MDC/MDC adapter, Blue. 4 dust plugs	7.75
21867	USConec 2 port SM APC MDC/MDC adapter, Green. 4 dust plugs	7.75
21868	USConec 2 port MM OM3 MDC/MDC adapter, Aqua. 4 dust plugs	7.75
21870	USConec 2 port MM OM4 MDC/MDC adapter, Magenta. 4 dust plugs	7.75
21869	USConec 2 port MM OM5 MDC/MDC adapter, Lime Green. 4 dust plugs	7.00
22524	USConec 4 port SM MDC/MDC adapter, Blue. 4 dust plugs	7.00
22525	USConec 4 port SM APC MDC/MDC adapter, Green. 4 dust plugs	7.00
22526	USConec 4 port MM OM3 MDC/MDC adapter, Aqua. 4 dust plugs	7.00
22527	USConec 4 port MM OM4 MDC/MDC adapter, Magenta. 4 dust plugs	7.00
22528	USConec 4 port MM OM5 MDC/MDC adapter, Lime Green. 4 dust plugs	7.00



22082

### FEATURES

- Two 1.25mm ferrules in one connector housing
- Push-pull boot for connector insertion and extraction
- Simple polarity reversal with no exposed fibers
- Meets IEC 61753-1 Grade B insertion loss requirements
- Telcordia GR-326 and TIA-568 compliant
- Designed for cables up to 2.0mm OD
- MM, SM and SM APC available
- 3x fiber cabling density over LC

# MPO/MTP PRE-TERMINATED SYSTEMS

The FIS MPO/MTP Module is a pre-terminated, pre-tested, rack mount module system allowing for a simple installation of MPO/MTP backbone cables with a transition to standard LC or SC connections. The FIS modules are designed to fit into enclosures with LGX slot configurations. Using a pre-terminated cable assembly in conjunction with modules within a rack allows for easier installation and simpler cable management. Contact your FIS sales representative today for further details or use the configurators below to construct the proper combination to meet any requirement. All stock cassettes are built using elite ferrules.

## BUILD YOUR OWN CUSTOM MPO/MTP MODULE / CASSETTE

Use this chart to build a MPO/MTP module to your exact specifications.

MODULE STYLE	MPO/MTP GENDER	FRONT CONNECTOR	FIBER TYPE	FIBER COUNT	MTP CASSETTE POLARITY
F1-MTP	M	LU	OS2	12	A
F1-MTP = MPO/MTP Cassette, LGX, Black	M = Male F = Female	Y = SC/PC YU = SC/UPC YA = SC/APC L = LC/PC LU = LC/UPC LA = LC/APC	OM1 = 62.5µm OM1, MM OM2 = 50µm OM2, MM OM3 = 50µm OM3, MM OM4 = 50µm OM4, MM OM5 = 50µm OM5, MM OS2 = 9µm OS2, SM	8 = 8 Fiber 12 = 12 Fiber 16 = 16 Fiber 24 = 24 Fiber 32 = 32 Fiber	A = Type A (Default) AF = Type A Flipped B = Type B C = Type C D = 24 Fiber Type A E = 24 Fiber Type B U = Other (User Defined)



Call Your Sales Representative for Additional Configurations

## CUSTOM MPO/MTP TRUNK CABLE ASSEMBLY CONFIGURATOR:

Use this chart to build your MPO/MTP custom cable assembly

CABLE STYLE	FIBER	CONNECTOR SIDE A (MTP STYLE ONLY)/SIDE B	MODE	LENGTH (IN METERS)	MPO/MTP FERRULE QUALITY	CABLE FIBER COUNT	POLARITY	BUILD UP BREAKOUT	JACKET	P/E
M	8	MF12   LU	M	1	S	12	A	X	PL	X
MD = Micro Distribution HD = High Density Micro Distribution R = Ribbon	1 = 50µm MM - OM2 2 = 62.5µm MM - OM1 3 = 9µm SM - OS2 8 = 50µm 10Gig-OM3 * 9 = 9µm SM - ULTRA * 10 = 50µm 10Gig - OM4 * 12 = 50µm 10Gig - OM5  * Bend Insensitive	YU = SC/UPC YA = SC/APC LU = LC/UPC LA = LC/APC 8U = ST/UPC 7U = FC/UPC 7A = FC/APC MT8 = MTP 8 Ferrule Male MT12 = MTP 12 Ferrule Male MT16 = MTP 16 Ferrule Male MT24 = MTP 24 Ferrule Male MT32 = MTP 32 Ferrule Male MF48 = MTP 48 Ferrule Male MF72 = MTP 72 Ferrule Male MF8 = MTP 8 Ferrule Female MF12 = MTP 12 Ferrule Female MF16 = MTP 16 Ferrule Female MF24 = MTP 24 Ferrule Female MF32 = MTP 32 Ferrule Female MF48 = MTP 48 Ferrule Female MF72 = MTP 72 Ferrule Female	S = Singlemode M = Multimode		S = Standard * E = Elite * P = MTP Pro *	12 = 12-fiber 24 = 24 fiber 32 = 32 fiber 36 = 36 fiber 48 = 48 fiber 72 = 72 fiber 144 = 144 fiber	A = Type A B = Type B C = Type C D = 24 Fiber Type A E = 24 Fiber Type B U = Other (User Defined)	Z9 = 900 Z2 = 2mm Z3 = 3mm X = None	R = Riser PL = Plenum	PE = Pulling Eye PBE = Pulling Eyes Both Ends

### STANDARD FERRULES VS. ELITE FERRULES SPECIFICATIONS

	STANDARD FERRULES		ELITE FERRULES	
	Standard Singlemode MT Ferrule	Standard Multimode MT Ferrule	MM MT Elite® Multimode MT Ferrule	SM MT Elite® Singlemode MT Ferrule
Insertion Loss	0.25dB Typical (All Fibers) 0.75dB Maximum (Single Fiber) <sup>1</sup>	0.20dB Typical (All Fibers) 0.60dB Maximum (Single Fiber) <sup>2,3</sup>	0.1dB Typical (All Fibers) 0.35dB Maximum (Single Fiber) <sup>2,3</sup>	0.10dB Typical (All Fibers) 0.35dB Maximum (Single Fiber) <sup>1</sup>
Optical Return Loss	>60dB (8° Angle Polish)	>20dB	>20dB	>60dB (8° Angle Polish)

\* Note: Choose two connector styles from the chart above one for Connector Side A and one for Connector Side B. Side A must be of a MTP style connector only.

### 24 FIBER MPO/MTP STRAIGHT POLARITY

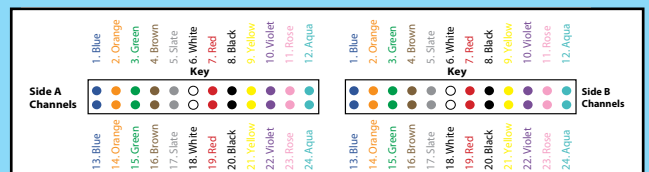
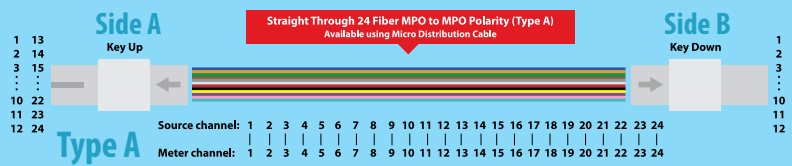

### 24 FIBER MPO/MTP TYPE - B REVERSED POLARITY

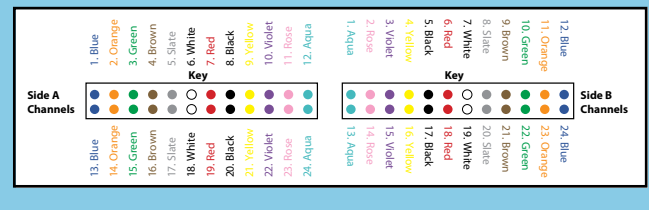
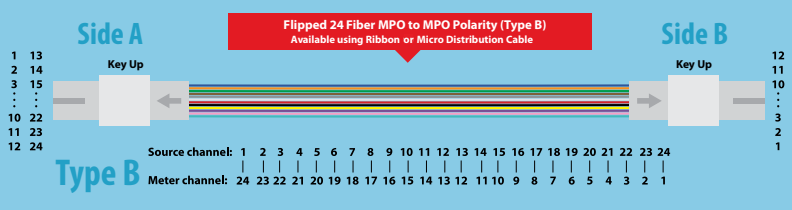

# CUSTOM 12 FIBER MPO/MTP TO MPO/MTP TRUNK CABLE DIAGRAMS

Use these diagrams to help build the cable you need to your exact specifications.

## Type A

**Straight Through 12 Fiber MPO to MPO Polarity (Type A)**  
Available using Ribbon or Micro Distribution Cable



**MD9MF12MF12SxxE12AXPL** – Quantity 1 **Trunk Cable** (MPO/MTP Plenum Trunk cable Method A using Micro-Distribution Singlemode, 12 Fiber cable with MTP/Female Elite – MTP/Female Elite connectors, “xx” = length)

**F1MTP120S2MT12ELUA** - Quantity 2 **Cassettes** (one cassette for Side A and one for Side B 12 Fiber Type A Singlemode Cassette with 1 rear MPO/MTP -male elite port, 6 front LC duplex ports)

**X9CCSxxPLHC** – Quantity 6 **Patch Cables** (Duplex A - B Plenum 1.6mm Singlemode Patch cord LC Duplex – LC Duplex, “xx” = length of hand coiled)

**X9CCSxxPLHC** – Quantity 6 **Patch Cables** (Duplex A – A\* Plenum 1.6mm Singlemode patch cord LC Duplex – LC Duplex plenum “xx” = length hand coiled) \*Must specify A – A polarity

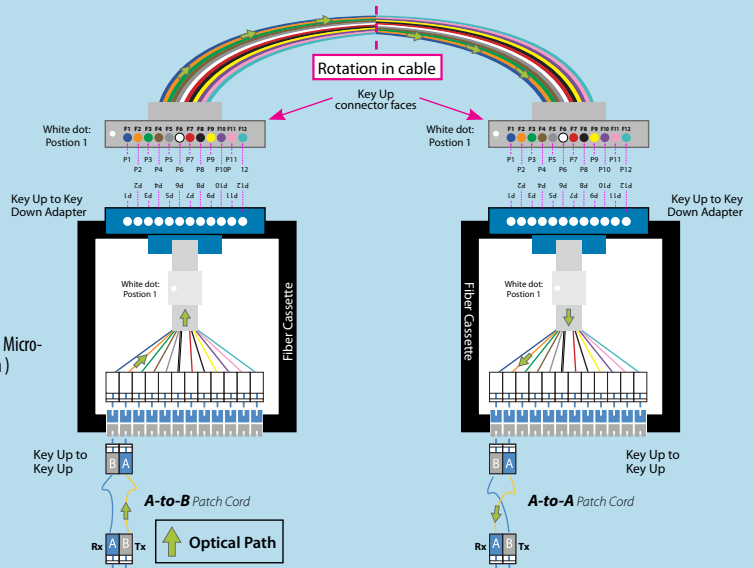

12 FIBER TYPE A MPO/MTP POLARITY

## Type B

**Reversed 12 Fiber MPO to MPO Polarity (Type B)**  
Available using Ribbon or Micro Distribution Cable



**MD8MF12MF12MxxE12BXPL** – Quantity 1 **Trunk Cable** (MPO/MTP Plenum Trunk cable Method B using Micro-Distribution Multimode OM3, 12 Fiber cable with MTP/Female Elite – MTP/Female Elite connectors, “xx” = length)

**F1MTP120M3MT12ELUB** - Quantity 2 **Cassettes** (one cassette for Side A and one for Side B 12 Fiber Type B Multimode OM3 Cassette with 1 rear MPO/MTP -male elite port, 6 front LC duplex ports)

**X8CCMxxPLHC** – Quantity 12 **Patch Cables** (Duplex A - B Plenum 1.6mm Multimode OM3 Patch cord LC Duplex – LC Duplex, “xx” = length of hand coiled)

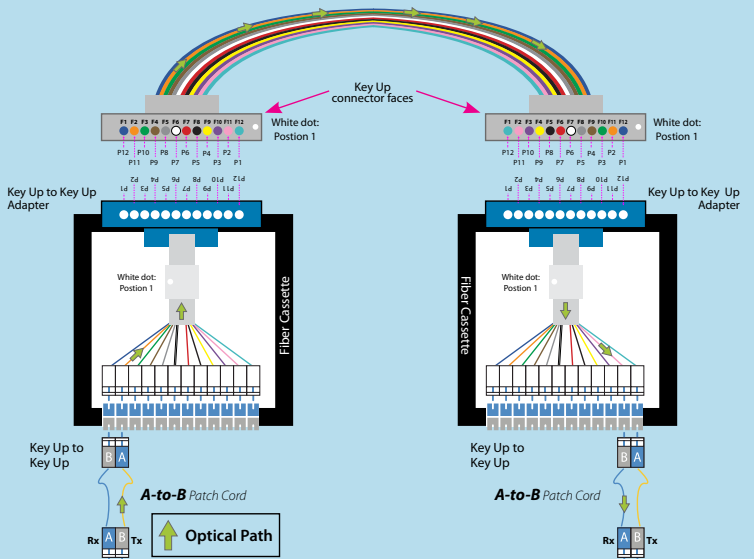

12 FIBER TYPE B MPO/MTP POLARITY

## Type C

**Flipped Pairs 12 Fiber MPO to MPO Polarity (Type C)**  
Available using Micro Distribution Cable

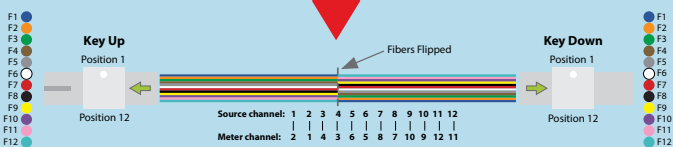

**MD8MF12MF12MxxE12CXPL** – Quantity 1 **Trunk Cable** (MPO/MTP Plenum Trunk cable Method C using Micro-Distribution Multimode OM3, 12 Fiber cable with MTP/Female Elite – MTP/Female Elite connectors, “xx” = length)

**F1MTP120M3MT12ELUC** - Quantity 2 **Cassettes** (one cassette for Side A and one for Side B 12 Fiber Type C Multimode OM3 Cassette with 1 rear MPO/MTP -male elite port, 6 front LC duplex ports)

**X8CCMxxPLHC** – Quantity 12 **Patch Cables** (Duplex A - B Plenum 1.6mm Multimode OM3 Patch cord LC Duplex – LC Duplex, “xx” = length of hand coiled)

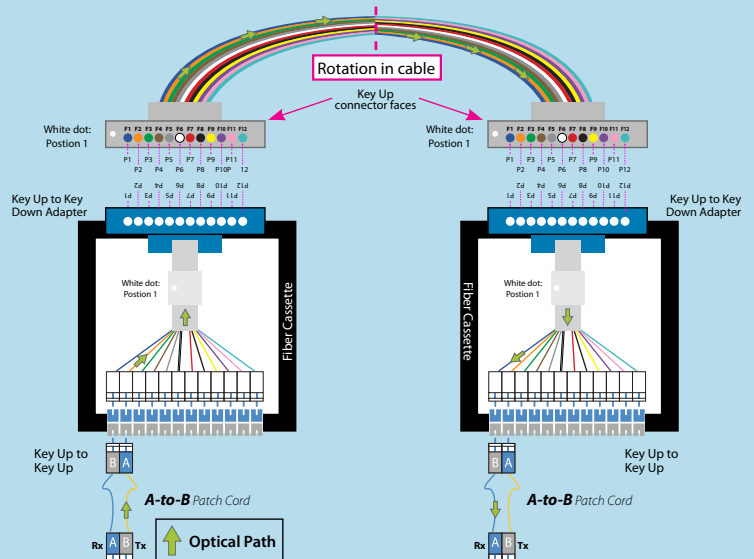

12 FIBER TYPE C MPO/MTP POLARITY



S-4-9U-9U-S-1-FIS

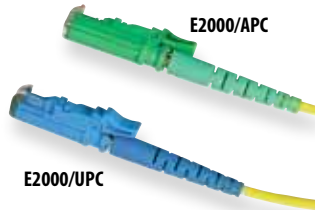

E2000/APC

E2000/UPC



F1-MCP-1-2-SC-SC



NC-3-BA-P-S-15-FIS-6



F1-2071



F1-3071

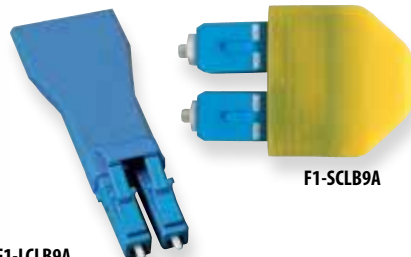

F1-SCLB9A

F1-LCLB9A

## POLARIZATION MAINTAINING PATCH CABLE

For polarization-sensitive applications, FIS offers PM patch cables with UPC or APC connector finishes. Available in 900µm and 3mm jacketed versions. Important specifications need to be discussed with FIS Sales Associate upon ordering, such as: Alignment (slow or fast axis) Fiber Specifications, Cable Jacket (900µm buffer or 3.0mm), whether or not the purchased PM assemblies will be used for splicing. Contact FIS for additional specifications and pricing on PM jumpers of various lengths. **Specify Fibercore Limited PM fiber or Corning PM Fiber.**

PART #	DESCRIPTION	PRICE
S-4-9A-9A-S-1-FIS	Simplex FC/APC - FC/APC, Slow Axis, 3.0mm Jacketed, Blue, 1 Meter	\$95.00
S-4-9U-9U-S-1-FIS	Simplex FC/UPC - FC/UPC, Slow Axis, 3.0mm Jacketed, Blue, 1 Meter	95.00
S-4-9U-9A-S-1-FIS	Simplex FC/UPC - FC/APC, Slow Axis, 3.0mm Jacketed, Blue, 1 Meter	95.00

## E2000 PATCH CABLE AND MATING SLEEVES

FIS offers Singlemode E2000 2.8mm cable assemblies. The E2000 comes with an integrated shutter system to protect the user from high-power laser emissions, and protects the connector from contamination.

**Call for other configurations and lengths.**

PART #	MFG	DESCRIPTION	PRICE
S-3-EU-EU-S-1-FISC	FIS	Simplex 9/125 E2000/UPC to E2000/UPC 1 Meter	\$26.95
S-3-EU-EU-S-3-FISC	FIS	Simplex 9/125 E2000/UPC to E2000/UPC 3 Meter	27.65
S-3-EU-EU-S-5-FISC	FIS	Simplex 9/125 E2000/UPC to E2000/UPC 5 Meter	28.35
S-3-EA-EA-S-1-FISC	FIS	Simplex 9/125 E2000/APC to E2000/APC 1 Meter	27.95
S-3-EA-EA-S-3-FISC	FIS	Simplex 9/125 E2000/APC to E2000/APC 3 Meter	28.65
F1-E2000	FIS	E2000 to E2000 Singlemode Adapter Ceramic Sleeve	12.00
F1-E2000APC	FIS	E2000/APC to E2000/APC Singlemode Adapter Ceramic Sleeve	15.00

## MODE CONDITIONING PATCH CABLE

Mode Conditioning Patch Cable is used in conjunction with laser transmitters or VCSEL's for 1 Gb transmissions over FDDI fiber in fiber optic links to improve the transition bandwidth by the reduction of modal dispersion. These cords can be assembled in various configurations to meet your specific needs. Contact your FIS sales representative for pricing and delivery. Improve the performance of your network today.

### LC-SC MCP MULTIMODE 62.5/125µm

PART #	LENGTH	PRICE
F1-MCP-1-2-LC-SC	1 Meter	\$68.00
F1-MCP-3-2-LC-SC	3 Meters	70.00
F1-MCP-5-2-LC-SC	5 Meters	73.00
F1-MCP-10-2-LC-SC	10 Meters	78.00

### LC-ST MCP MULTIMODE 62.5/125µm

PART #	LENGTH	PRICE
F1-MCP-1-2-LC-ST	1 Meter	\$68.00
F1-MCP-3-2-LC-ST	3 Meters	70.00
F1-MCP-5-2-LC-ST	5 Meters	73.00
F1-MCP-10-2-LC-ST	10 Meters	78.00

## FIS COMPACT NODE CABLES (SERVICE CABLES)

Fiber Instrument Sales' Compact Node is an epoxy based optical node cable assembly. Designed for HFC applications and with the flexibility to fit aerial, pedestal and vault applications. Available in various custom configurations up to 12 fibers.

PART #	DESCRIPTION	PRICE
NC-3-BA-P-S-15-FIS-2	Node Cable 2 Fiber Loosetube Cable SM SC/APC - Pigtail, 15 Meters	\$125.00
NC-3-BA-P-S-15-FIS-4	Node Cable 4 Fiber Loosetube Cable SM SC/APC - Pigtail, 15 Meters	156.00
NC-3-BA-P-S-15-FIS-6	Node Cable 6 Fiber Loosetube Cable SM SC/APC - Pigtail, 15 Meters	190.00
NC-3-BU-P-S-15-FIS-2	Node Cable 2 Fiber Loosetube Cable SM SC/UPC - Pigtail, 15 Meters	119.00
NC-3-BU-P-S-15-FIS-4	Node Cable 4 Fiber Loosetube Cable SM SC/UPC - Pigtail, 15 Meters	150.00
NC-3-BU-P-S-15-FIS-6	Node Cable 6 Fiber Loosetube Cable SM SC/UPC - Pigtail, 15 Meters	184.00

## FIS FIBER OPTIC TERMINATOR CONNECTORS

Low Reflection Terminators are designed for use in unused ports and to reduce back reflection into fiber optic systems. Each connector is environmentally sealed for protection. Back Reflection APC = -65dB UPC = -55dB

PART #	DESCRIPTION	PRICE
F1-0071	FIS ST/UPC Terminator Connector	\$6.95
F1-2071	FIS FC/UPC Terminator Connector	6.95
F1-3071	FIS SC/UPC Terminator Connector	6.95
F1-2072	FIS FC/APC Terminator Connector	7.95
F1-3072	FIS SC/APC Terminator Connector	7.95
F1-4071	FIS LC/UPC Terminator Connector	6.95
F1-4072	FIS LC/APC Terminator Connector	7.95

## FIS LOOPBACK MODULES

Loopbacks are designed for testing, engineering and the burn-in stage of boards or other equipment. They provide system test engineers a simple but effective way of testing the transmission capability and receiver sensitivity of network equipment.

PART #	DESCRIPTION	PRICE
F1-SCLB9A	SC Loopback SM 9/125µm Fiber	\$13.95
F1-SCLB62A	SC Loopback MM 62.5/125µm Fiber	13.95
F1-LCLB9A	LC Loopback SM 9/125µm Fiber	13.95
F1-LCLB62A	LC Loopback MM 62.5/125µm Fiber	13.95
F1-LCLB50A	LC Loopback MM 50/125µm Fiber	13.95



# WAVELENGTH DIVISION MULTIPLEXERS

Wavelength Division Multiplexing is a technology utilized in fiber optics that allows multiple laser sources to broadcast through a single fiber. A WDM enables a single fiber to broadcast Bi-Directionally and increase bandwidth by a factor of the number of light sources utilized. There are sub categories of WDM that refer to the number of allowable lasers (channels) used, each source is spaced equally by a defined separation of wavelength.

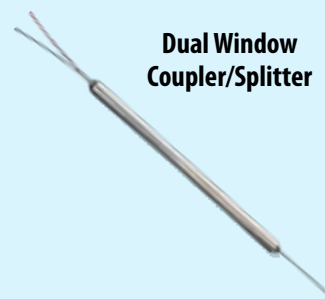
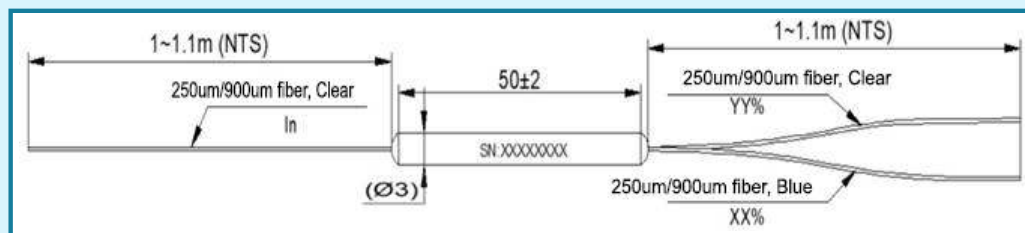

Dual Window Coupler/Splitter

## SINGLEMODE DUAL WINDOW COUPLERS/SPLITTERS

PART #	DESCRIPTION	PRICE
<b>250µm</b>		
Z1SDW13550122UC	1x2 (1310/1550nm) 50/50 Ratio	\$24.95
Z1SDW13510122UC	1x2 (1310/1550nm) 10/90 Ratio	24.95
Z1SDW13520122UC	1x2 (1310/1550nm) 20/80 Ratio	24.95
Z1SDW13530122UC	1x2 (1310/1550nm) 30/70 Ratio	24.95
Z1SDW13540122UC	1x2 (1310/1550nm) 40/60 Ratio	24.95
Z1SDW13550222UC	2x2 (1310/1550nm) 50/50 Ratio	24.95
<b>900µm</b>		
Z1SDW13550129UC	1x2 (1310/1550nm) 50/50 Ratio	\$24.95
Z1SDW13510129UC	1x2 (1310/1550nm) 10/90 Ratio	24.95
Z1SDW13520129UC	1x2 (1310/1550nm) 20/80 Ratio	24.95
Z1SDW13530129UC	1x2 (1310/1550nm) 30/70 Ratio	24.95
Z1SDW13540129UC	1x2 (1310/1550nm) 40/60 Ratio	24.95
Z1SDW13550229UC	2x2 (1310/1550nm) 50/50 Ratio	24.95

## MULTIMODE COUPLERS/SPLITTERS (800-1600nm)

PART #	DESCRIPTION	PRICE
<b>250µm</b>		
Z1MMC28550122C	1x2 62.5/125µm Coupler 50/50 Ratio 250µm Fiber	\$63.95
Z1MMC38550122C	1x2 50/125µm Coupler 50/50 Ratio 250µm Fiber	63.95
<b>900µm</b>		
Z1MMC28550129C	1x2 62.5/125µm Coupler 50/50 Ratio 900µm Fiber	\$63.95
Z1MMC38550129C	1x2 50/125µm Coupler 50/50 Ratio 900µm Fiber	63.95

## WAVELENGTH DIVISION MULTIPLEXERS

A Wave Division Multiplexer (WDM) is a coupler that enables you to channel a signal to multiple devices operating at different wavelengths.

PART #	DESCRIPTION	PRICE
<b>250µm</b>		
Z1WDM13550122UC	1x2 5m Dual Window (1310/1550nm) WDM 250µm Fiber	\$19.95
<b>900µm</b>		
Z1WDM13500129UC	1x2 5m Dual Window (1310/1550nm) WDM 900µm Fiber	\$21.95

## RUGGEDIZED 2mm/3mm JACKETED COUPLERS/SPLITTERS

Install these ruggedized splitters into outdoor or indoor enclosures. The 2mm or 3mm furcated fiber legs offer extra protection when technicians are working in compact areas. The splitter/couplers are housed in a small plastic case; furcated fiber legs are attached with or without connectors installed. **Custom size jacketing/split ratios/connector styles available.**

PART #	DESCRIPTION	PRICE
RSC-3-S-2-50-YA-YA-2	Ruggedized Splitter, SM, 1 x 2, 50/50 split, SC/APC-SC/APC, 2mm jacketing	\$76.95
RSC-3-S-2-45-YA-YA-2	Ruggedized Splitter, SM, 1 x 2, 55/45 split, SC/APC-SC/APC, 2mm jacketing	76.95
RSC-3-S-2-40-YA-YA-2	Ruggedized Splitter, SM, 1 x 2, 60/40 split, SC/APC-SC/APC, 2mm jacketing	76.95
RSC-3-S-2-30-YA-YA-2	Ruggedized Splitter, SM, 1 x 2, 70/30 split, SC/APC-SC/APC, 2mm jacketing	76.95
RSC-3-S-2-05-YA-YA-2	Ruggedized Splitter, SM, 1 x 2, 90/5 split, SC/APC-SC/APC, 2mm jacketing	76.95
RSC-1-S-2-50-Y-Y-3	Ruggedized Splitter, 50µm, 1 x 2, 50/50 split, SC/PC-SC/PC, 3mm jacketing	80.00
RSC-1-S-2-40-Y-Y-3	Ruggedized Splitter, 50µm, 1 x 2, 60/40 split, SC/PC-SC/PC, 3mm jacketing	80.00



RSC-1-S-2-50-Y-Y-3

## PACKAGED NETWORK COUPLER AND TREE COUPLER

Housed and connectorized with your specified connector are 1X2 or 1X4 Multimode or Singlemode splitters. Also available in same packaging is Singlemode 1310/1550nm Wave Division Multiplexer (WDM). Specify core/clad size, connector style, and split ratio. (Highest port count available is 1X4.) **Other Configurations Available - Call FIS Representative.**

PART #	DESCRIPTION	PRICE
PNC-3-S-2-50-YU-YU	Packaged Network Coupler Box, Singlemode, 50/50 split, 1x2 SC/UPC Adapters	\$135.00
PNC-3-S-2-10-YU-YU	Packaged Network Coupler Box, Singlemode, 90/10 split, 1x2, SC/UPC Adapters	135.00
PNC-3-S-4-EV-YU-YU	Packaged Network Coupler Box, Singlemode, Even split, 1x4, SC/UPC Adapters	239.00



PNC-3-S-4-50-7U-7U



FIS Blue provides specialized assemblies to the Military and Broadcast Industries. Count on them for custom broadcast or military grade tactical fiber optic cable assemblies with up to 24 fibers, in cables that are crush-resistant, resilient and with a thick layer of aramid strength members. The Kevlar within the cable is strong enough to withstand the weight of a truck, making these assemblies ideal for temporary field production, sporting events, and military operations. Call us today for more information and detailed specifications. Our cable assemblies can be terminated with a variety of specialized connectors such as Expanded Beam, TFOCA II® or SMPTE Connectors. These specialized connectors can also be paired with standard connectors (SC, LC, FC, ST, etc.).

Please Call For Additional Pricing.



**SMPTE 311M CABLE ASSEMBLIES**

These rugged stainless steel SMPTE connectors ensure a very long product life. Cable assemblies utilize two Singlemode fiber contacts, two power contacts and two signal contacts. Cable assemblies are available with multiple configurations including panel mount receptacles and plugs.

- Quick Push-Pull Self Latching System
- Stainless Steel for Harsh Environments
- Complies with SMPTE Signal Requirements
- Popular HDTV Connection on Cameras and Panels

PART #	DESCRIPTION	PRICE
BC-3-FUW-PUW-S-100-FISB-2	LEMO SMPTE Assembly PUW (receptacle) to FUW (plug) 100 feet	\$1,045.00

\*For other lengths add or subtract cable @ \$1.15 per foot

**QSEAL 2 & 4 CHANNEL CONNECTOR**

The Qseal 2 and 4 Channel Connector is intermateable with Neutrik's opticalCON\* DUO and QUAD connectors. With its metal LC Style insert, and IP67 rating, the Qseal is a more rugged alternative.

Key features include a field installable system, which allows the customer and end user to build, maintain and troubleshoot their own assemblies. The shutter free design allows for easy inspect and cleaning.

- Intermateable with Neutrik opticalCON\* DUO and QUAD Connector
- No shutters: easy to inspect and clean
- Ruggedized all metal connector design
- Aluminum body with durable black anodize finish
- Resistant to vibration, shock, environmental effects and debris
- Low optical insertion loss
- Singlemode and Multimode operation
- Field installable
- Environmentally sealed to IP67, dust sealed and water immersion to 1 meter
- Alternate materials and finishes available (for example stainless steel)

\*opticalCon DUO and QUAD is a registered trademark of Neutrik

PART #	DESCRIPTION	PRICE
T-3-QP-QP-S-1-FISB-2	Qseal 2-channel Plug to Plug Singlemode 1 Foot Length	\$811.00
T-3-QP-QP-S-1-FISB-4	Qseal 4-channel Plug to Plug Singlemode 1 Foot Length	883.75

\* add \$0.48 per foot additional length utilizing FIS Blue 2-Fiber Tactical cable / \* add \$0.52 per foot additional length utilizing FIS Blue 4-Fiber Tactical cable

**DELPHI 4 AND 12 CHANNEL HERMAPHRODITIC CABLE ASSEMBLIES**

Delphi's 4 and 12 Channel Hermaphroditic Connectors are both Single and Multimode compatible in the same connector. They are designed to withstand crush, impact, cable twist, bending movement, water and mud immersion, as well as many other harsh environments. They will link to identical connectors without regard to connector gender.

PART #	DESCRIPTION	PRICE
T-3-DP-DP-S-1-FISB-4	Delphi 4-channel Plug to Plug Singlemode 1 Foot Length	\$854.80
T-3-DP-DP-S-1-FISB-12	Delphi 12-channel Plug to Plug Singlemode 1 Foot Length	2,920.85

\* add \$0.52 per foot additional length cables utilizing FIS Blue 4-Fiber Tactical cable / \* add \$0.87 per foot additional length cables utilizing FIS Blue 12-Fiber Tactical cable

**QPC EXPANDED BEAM CABLE ASSEMBLIES**

Our Expanded Beam connectors are designed to the MIL83526/20 Mil-Spec. They are available in 2 and 4 channels, multimode or singlemode. There is also a Mini Expanded Beam version that is available in 2 and 4 channels, multimode or singlemode. All connectors utilize a hermaphroditic interconnection with advanced expanded beam technology. The expanded beam connectors are a very rugged design.

PART #	DESCRIPTION	PRICE
T-3-EP-EP-S-1-FISB-2	Expanded Beam Plug to Plug 2-channel Singlemode 1 Foot Length	\$1,316.80
T-3-EP-EP-S-1-FISB-4	Expanded Beam Plug to Plug 4-channel Singlemode 1 Foot Length	1,527.75

\* add \$0.48 per foot additional length cables utilizing FIS Blue 2-Fiber Tactical cable / \* add \$0.52 per foot additional length cables utilizing FIS Blue 4-Fiber Tactical cable

**FISCHER 4 CHANNEL RUGGED CABLE ASSEMBLIES**

Fischer Fiber Optic push-pull connector solutions are purpose built to withstand the elements of rugged and harsh environments, providing virtually faultless performance. Extreme Environmental Robustness: IP68 ingress protection when mated or with caps and IP67 sealing even unmated. Connectors and assemblies are available in 2 and 4 channels, Singlemode and Multimode.

PART #	DESCRIPTION	PRICE
T-3-FP-FP-S-100-FISB-4	Fischer 4-channel Plug to Plug Singlemode 100 Feet	Call For Pricing
T-3-FB-8U-S-2-FISB-4	Fischer 4-channel Jam-Nut Receptacle to ST Singlemode 2 Feet	Call For Pricing

**TFOCA-II Cable Assemblies**

Amphenol Fiber Systems International TFOCA II® connectors are designed to withstand repeated handling and mating cycles typically required for rapid fiber optic cable deployment and retrieval in a tactical environment. TFOCA II is the replacement for US Army and US Marine Corps legacy systems with TFOCA (AT&T).

PART #	DESCRIPTION	PRICE
T-3-T2P-T2P-S-100-FISB-4	TFOCA-II Plug to Plug Singlemode 4-channel 100 feet	Call For Pricing
T-3-T2P-T2P-S-100-FISB-12	TFOCA-II Plug to Plug Singlemode 12-channel 100 feet	Call For Pricing

\* add \$0.52 per foot additional length cables utilizing FIS Blue 4-Fiber Tactical cable / \* add \$0.87 per foot additional length cables utilizing FIS Blue 12-Fiber Tactical cable



**FIS BLUE TACTICAL FIBER OPTIC CABLE**

FIS Blue Broadcast/Tactical Cable consists of a polyurethane outer jacket with your choice of 2, 4, 6, 12 or 24 900µm Hytrel tight buffered fibers surrounded by aramid yarn and an aramid ripcord. Polyurethane jacket makes the cable highly flexible and rugged, so it can also be used in direct burial applications. Tactical fiber optic cables are designed for harsh outdoor environments where maximum performance and reliability is essential.

PART #	FIBER COUNT	DESCRIPTION	PRICE
FB-SMTACCABLE2	2	2-fiber Singlemode Tactical Cable	\$1.61 /Mtr.
FB-SMTACCABLE4	4	4-fiber Singlemode Tactical Cable	1.73 /Mtr.
FB-SMTACCABLE6	6	6-fiber Singlemode Tactical Cable	1.81 /Mtr.
FB-SMTACCABLE12	12	12-fiber Singlemode Tactical Cable	2.86 /Mtr.
FB-OM4TACCABLE2	2	2-fiber 50µm OM4 Tactical Cable	\$2.29 /Mtr.
FB-OM4TACCABLE4	4	4-fiber 50µm OM4 Tactical Cable	3.21 /Mtr.
FB-OM4TACCABLE6	6	6-fiber 50µm OM4 Tactical Cable	4.40 /Mtr.
FB-OM4TACCABLE12	12	12-fiber 50µm OM4 Tactical Cable	8.83 /Mtr.
FB-MMTACCABLE4	4	4-fiber 62.5µm OM1 Tactical Cable	\$2.37 /Mtr.
FB-MMTACCABLE12	12	12-fiber 62.5µm OM1 Tactical Cable	6.27 /Mtr.



**SHIPBOARD CABLE**

Shipboard cable is qualified MIL-PRF-85045 cable. The cable consists of a low smoke zero halogen (LSZH) jacketing materials and tight buffered fibers. The tight buffered fibers are inside of 2mm color-coded sub-units, which means this is a break-out style cable. Shipboard cable is watertight and flexible. Cable is sold as bulk cable or as a completed cable assembly.

PART #	FIBER COUNT	DESCRIPTION	PRICE
M85045/16-02	1	1-fiber Singlemode Shipboard Cable	Call For Pricing
M85045/18-02P	4	4-fiber Singlemode Shipboard Cable	Call For Pricing
M85045/17-02P	8	8-fiber Singlemode Shipboard Cable	Call For Pricing
M85045/16-01	1	1-fiber 62.5µm OM1 Shipboard Cable	Call For Pricing
M85045/18-01P	4	4-fiber 62.5µm OM1 Shipboard Cable	Call For Pricing
M85045/17-01P	8	8-fiber 62.5µm OM1 Shipboard Cable	Call For Pricing



**MICRO ARMORED TAC CABLE**

Super strong steel armored micro cable.

- Flexible
- High Tensile Strength
- Special Compact Design
- High Crush Resistant Outer Jacket

PART #	FIBER COUNT	DESCRIPTION	PRICE
SOLID2.2-1-FRHF	1	1-fiber Singlemode, 2.2mm OD	\$3.81/Mtr.
FLEX4.1-4-FRHF	4	4-fiber Singlemode, 4.1mm OD	2.30/Mtr.
FLEX5.6-12-FR	12	6-fiber Singlemode, 5.6mm OD	3.64/Mtr.
SOLID2.2-1-FRHF-OM3	1	1-fiber 50µm OM3, 2.2mm OD	\$3.84/Mtr.
FLEX4.1-4-FRHF-OM3	4	4-fiber 50µm OM3, 4.1mm OD	2.99/Mtr.
FLEX5.6-12-FR-OM3	12	6-fiber 50µm OM3, 5.6mm OD	6.17/Mtr.

\*Higher fiber counts available upon request

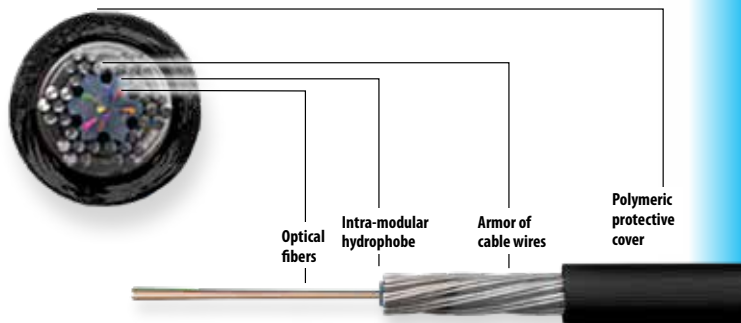

**HAVE SOMETHING THAT NEEDS FIXING? LET FIS BLUE DIAGNOSE AND REPAIR.**

Our repair service is perfect if you want to save time and money. Some tactical cable assemblies cost thousands of dollars, so it's smart to know your options. You can ship your SMPTE or tactical cable assembly to us and we can repair it for a fraction of what it might cost you to replace it.

Our service includes evaluation, repair, and testing to make sure your cable assembly is going to do the job right for you.



# M29504 FIBER OPTIC TERMINI

FIS Blue offers a full line of fiber optic termini In-Stock. The termini are designed for an assorted list of military and harsh environment connectors, including but not limited to: MIL-DTL-38999 Series III, M28876, and Delphi Hermaphroditic Connectors.

**Quantity Pricing Available**



CONNECTOR WITH SOCKET



CONNECTOR WITH PINS

## M29504/04 and /05 Termini, STYLE 1



### SOCKETS

Mil-Spec STYLE 1	Ferrule ID	Fiber Type	Price (ea.)
M29504/05-4237	125.5µm	9/125µm	Call For Pricing
M29504/05-4238	126.0µm	9/125µm	Call For Pricing
M29504/05-4239	126.0µm	50 & 62.5/125µm	Call For Pricing
M29504/05-4046	127.0µm	50 & 62.5/125µm	Call For Pricing
M29504/05-4049	142.0µm	100/140µm	Call For Pricing
M29504/05-4243	236.0µm	200/233µm	Call For Pricing

### PINS

Mil-Spec STYLE 1	Ferrule ID	Fiber Type	Price (ea.)
M29504/04-4208	125.5µm	9/125µm	Call For Pricing
M29504/04-4209	126.0µm	9/125µm	Call For Pricing
M29504/04-4210	126.0µm	50 & 62.5/125µm	Call For Pricing
M29504/04-4040	127.0µm	50 & 62.5/125µm	Call For Pricing
M29504/04-4043	142.0µm	100/140µm	Call For Pricing
M29504/04-4214	236.0µm	200/233µm	Call For Pricing

[ ARINC 801, SMPTE and other termini available upon request ]

## M29504/04 and /05 Termini, STYLE 2



### SOCKETS

Mil-Spec STYLE 2	Ferrule ID	Fiber Type	Price (ea.)
M29504/05-4248	126.0µm	9/125µm	\$31.38
M29504/05-4249	126.0µm	50 & 62.5/125µm	31.38
M29504/05-4250	127.0µm	50 & 62.5/125µm	31.38

### PINS

Mil-Spec STYLE 2	Ferrule ID	Fiber Type	Price (ea.)
M29504/04-4219	126.0µm	9/125µm	\$18.92
M29504/04-4220	126.0µm	50 & 62.5/125µm	18.92
M29504/04-4221	127.0µm	50 & 62.5/125µm	18.92



## M29504/14 and /15 Termini

### SOCKETS

PART #	Ferrule ID	Fiber Type	Price (ea.)
M29504/15-4180	125.0µm	9/125µm	Call For Pricing
M29504/15-4181	126.0µm	9/125µm	\$25.00
M29504/15-4171	126.0µm	50 & 62.5/125µm	25.00
M29504/15-4172	127.0µm	50 & 62.5/125µm	Call For Pricing
M29504/15-4175	142.0µm	100/140µm	Call For Pricing

### PINS

PART #	Ferrule ID	Fiber Type	Price (ea.)
M29504/14-4140	125.0µm	9/125µm	Call For Pricing
M29504/14-4141	126.0µm	9/125µm	\$25.00
M29504/14-4131	126.0µm	50 & 62.5/125µm	25.00
M29504/14-4132	127.0µm	50 & 62.5/125µm	Call For Pricing
M29504/14-4135	142.0µm	100/140µm	Call For Pricing

### DUMMY

M29504/03-4038	\$8.00
----------------	--------

**Connectors Are Also Available For Purchase. Please Call For Pricing.**

## M28876 CABLE ASSEMBLIES, 4 TO 31-CHANNEL

For rugged fiber optic military applications that require higher fiber counts, the M28876 is a good solution. The M28876 connectors come in a variety of fiber counts from 4 to 31 and vary in shell size from 13 - 23. There are a diverse amount of connector styles. These are offered in plug, jam-nut receptacle and flange mount receptacle. In addition, each of these have different options for the strain relief/backshell: none, straight, 90° and 45°.

In addition to connectors, FIS Blue is also a world-wide leader in M28876 cable assembly production. FIS Blue custom builds all types of M28876 and Navy assemblies to meet any need. All cable assemblies are 100% tested and are shipped with documented test results. In addition, full interferometer results are available upon request.

**MQJ Assemblies Available**



## NuGen SMPTE TEST SET

FIS Blue's Ruggedized SMPTE Test Set is designed for harsh work conditions where handheld units are not appropriate. The SMPTE Test Set utilizes a remote loopback unit for single ended testing of both optical fibers as well as power for the built-in copper conductor tests. The set checks all 4 copper conductors for continuity and shorts as well as verifying the integrity of the grounding shield in the cable with simple pass/fail audible and visual indicators. The main control unit houses the optical fiber power meter readout, copper conductor test indicators, and the SMPTE fixed plug connector. The Remote Unit contains the SMPTE fixed socket connector.

**FIS BLUE** INC.

**SMPTE Ready Testing!**



F1-ST501NG

### FEATURES

- Single Test Checks Both Fibers for Loss and all 4 Copper Conductors for Continuity, Short Circuits and Ground Braid Integrity
- Simple Audible and Visual Pass/Fail Indicators for Copper Tests
- Designed for Harsh Environments in Ruggedized Housing
- Rechargeable NiMH Batteries
- Tests 1310nm Wavelength
- Integrated VFL
- New polarity and short testing for copper lines
- Most complete SMPTE Test Set in the industry
- Made In USA

PART #	DESCRIPTION	PRICE
FB-ST501NG	SMPTE Test Set	\$2,995.00

## BROADCAST AND TACTICAL CABLE REELS

Specially designed steel cable reels to transport or store your broadcast fiber optic cable assemblies. Stack them on your truck or in your warehouse or roll them wherever you like. Please ask about getting your next custom cable assembly on a reel.

PART #	DIMENSIONS	PRICE
YHP009C	480(L) x 450(W) x 535(H) mm (18.9 x 17.7 x 21.1in)	\$392.00
YHP009A	720(L) x 450(W) x 535(H) mm (29.5 x 17.7 x 21.1in)	715.00
GT310RM	Schill GT-310 Cable Reel With RM Cable Flange Support	215.00
GT380RM	Schill GT-380 Cable Reel With RM Cable Flange Support	436.00
HT485RM	Schill HT-485 Cable Reel With RM Cable Flange Support	596.00
OXREEL-SM	Telecast Stackable Small OX Reel, 6" Hub	1,186.00
OXREEL-MD	Telecast Stackable Medium OX Reel, 6" Hub	820.00



YHP009B

OXREEL-XL

GT310RM

## SMPTE EXTRACTION TOOLS

For inserting and removing contact sleeves for SMPTE connectors. Choose from LEMO or Canare branded tool.

PART #	DESCRIPTION	PRICE
DCSF2035PN	LEMO Extraction Tool	\$37.00
ASPT-1	Canare Extraction Tool	15.75



DCSF2035PN

ASPT-1

## BASIC SMPTE, DELPHI AND MILITARY CLEANING KITS

FIS Blue's Basic SMPTE and Military Tool and Cleaning Kits include all the items needed to properly clean and maintain SMPTE, TFOCA, Delphi, and Expanded Beam connectors, plus the standard ST/FC/SC/LC type connectors. In addition there are some basic tools for maintaining and working with the connectors.

**Basic Kits Includes:** CLC 12" Tool Bag with Top-side Plastic Parts Tray, Kim Wipes Box, Sticklers Fiber Optic Splice & Connector Cleaner, FIS Connector Cleaner Universal Blue Housing with 20-ft, Optic Prep Tissue Pack Box (50pk), CleanStixx, 10ea: 2.5mm, 2.0/1.6mm, 1.25mm, lenses & ferrule tips, Black Electrical Tape, Sharpie Permanent Black Marker, Miller KS-1 Kevlar Shear, Greenlee Folding Utility Knife, Needle Nose Pliers, Greenlee 6-1 Screwdriver, 12-ft Locking Fractional Tape measure, 59-Piece Variety Pack Screwdriver Set, Blue SK68 3W LED 120 Lumen LED Torch Flashlight, Nylon 7" Cable Tie Wraps - 100-pk, FIS ST SM/MM Simplex Zirconia Adapter, IS SC Female-ST Female SM/MM Simplex Adapter, FIS FC Female-ST Female SM/MM Simplex Adapter, ST Adapter Dust Cap (red), Universal Clear Dust Cap 1.25mm, Universal Clear Dust Cap 2.5mm, IDEAL Crimper & Strip Tool, IDEAL 20-Pack Terminal Wire Connectors, and LEMO Alignment Tool.

PART #	DESCRIPTION	PRICE
FB-BASMPTE-KIT	Basic SMPTE Cleaning and Tool Kit	\$405.00
FB-BAMIL-KIT	Basic Military Cleaning and Tool Kit	304.00
FB-BASMPTE-KIT-CTY	Basic SMPTE (LEMO/Canare, SMPTE 304M) Kit with Continuity Tester	1,135.00
FB-BAMIL-KIT-TFCTY	Basic Military (TFOCA-II - M29504/16) Kit with Continuity Tester	1,170.00
FB-BAMIL-KIT-DLCTY	Basic Military (Delphi, M29504/14 /15) Kit with Continuity Tester	1,170.00
FB-BAMIL-KIT-EBSMCTY	Basic Military (Expanded Beam, SM) Kit with Continuity Tester	1,735.00
FB-BAMIL-KIT-EB5OCTY	Basic Military (Expanded Beam, 50um) Kit with Continuity Tester	1,525.00
FB-BAMIL-KIT-EB62CTY	Basic Military (Expanded Beam, 62.5um) Kit with Continuity Tester	1,525.00



**Non-Hazardous Ships Air!**

FB-BASMPTE-KIT-CTY

# TEST EQUIPMENT



## FIS MINI OTDR

This new FIS Single Mode OTDR (1310/1550nm) is the perfect handheld testing device for a range of fiber optic applications. With an OTDR dynamic range of 26dB it can test and measure up to 90km (approx. 55 miles) of fiber at 1550nm. It also has an on-board Visual Fault Locator, Power Meter, Light Source; having the capability of an all-in one optical loss test set (OLTS). The mini-OTDR stores files in the very commonly used .SOR format and comes with reporting software that will print large batches of OTDR scans into professional, easy to read PDF reports. What's also easy to read is our user friendly graphical mapping software or called "gMAP". This software takes the OTDR scan and breaks it down into an easy to read set of icons; displaying the specific type of event being detected (splice, mated connector, bend, etc.) and the important details of all events on the fiber (distance, dB loss, reflection, etc.). This alternative OTDR scan allows even the most inexperienced user to easily interpret the information needed to identify, troubleshoot and verify the important characteristics of a fiber optic cable installation.

### FEATURES

- Wavelength: Single mode:1310/1550nm
- Measuring range: Min 100m – Max 90km
- Onboard Features: Power Meter, Light Source, VFL, OTDR, Graphical Event Map Display, Fiber Inspection (Optional), and Network Cable Test
- Keyboard input, edit save file name and line number
- The 4.3-inch TFT touch screen, 800 x 480 pixels, display screen is optimized for outdoor sunlight.
- Handheld ( 6.9" x 4.1" x 1.8")



PART #	DESCRIPTION	PRICE
FC1315A26D	FIS Mini-OTDR (1310/1550nm) with PM, LS, VFL, and gMAP software	\$1,695.00
FCVMP	USB Video Inspection Probe for Mini-OTDR (APC & UPC tips included)	895.00
FC1315VMP	FIS Mini-OTDR with Video Inspection Probe Kit	2,295.00



## FIRECAT OTDR



**FIRECAT-1310**

Each Unit Includes: 110v AC adapter, Certification Software, Data Transfer Cable, SC Interchangeable Adapter, Soft Carry Case, and Instruction Manual.

When purchasing unit for 220v application, 220v adapter must be purchased separately.

PART #	DESCRIPTION	PRICE
FIRECAT-8513	Dual Wavelength – Multimode 850/1300	2,100.00
FIRECAT-1315	Dual Wavelength – Singlemode 1310/1550	2,100.00
FIRECAT-QUAD	Quad Wavelength – MM/SM 850/1300/1310/1550	3,200.00

**NOTE: ADD "R" TO THE END OF THE PART NUMBER FOR RUGGEDIZED VERSION | ADD ADDITIONAL \$100.00 TO PRICE** (Example: FIRECAT – 850 – R = Single wavelength – Multimode 850 – Ruggedized)

**NOTE: Call and speak with a Sales Representative for single wavelength product offerings**

The FIS Firecat OTDR provides an industry leading value with its low cost and easy functionality. This unit is perfect for both inexperienced and experienced technicians alike with its simple on screen 'soft key menus'. By providing the essentials for fiber optic troubleshooting, this OTDR is the perfect tool for basic link troubleshooting and is affordable enough for every truck, office or tool kit.

### FEATURES:

- Dynamic Range - 23dB
- Easy Operation with 'Soft Key Menus'
- Small, Lightweight and Rugged
- Interchangeable Adapters
- Easy to Read Event Table
- USB Data Transfer
- Backlight Keypad and Screen for Easy Use in Dim Lighting Conditions
- Available in a Ruggedized Version for harsh conditions



### ACCESSORIES

PART #	DESCRIPTION	PRICE
FIRECAT-AC110	AC Adapter 110v	\$35.00
FIRECAT-AC220	AC Adapter 220v	35.00
F1-OVXHRDCASE	Hard Carry Case	125.00
FIRECAT-USB	USB Flash Drive with Software	19.95
FIRECAT-CABLE	Data Transfer Cable	6.95
F1-FIRECAT-ST	ST Adapter	10.00
F1-FIRECAT-FC	FC Adapter	10.00
F1-FIRECAT-SC	SC Adapter	10.00

# THUNDERBOLT OTDR

Fiber Optic Test Equipment



Starting at  
**\$3,595**



**FEATURES:**

- Singlemode or Quad (SM/MM) Versions Available
- 36dB Dynamic Range
- Trace Overlay for Macro Bend Detection
- 9 Pulse Widths
- Gigabit Analyzer
- 8 Gigs of Storage
- 6.5" Color LCD Screen
- Available with SC, ST, or FC test port
- Unit Dimensions: 16.5"(L) x 7.5"(H) x 4"(W)

## 1 UNIT – 7 CRITICAL FIBER OPTIC TESTS

The perfect certification solution for contractors and enterprise technicians

This easy to use fiber optic test unit will exceed your expectations. Fiber Instrument Sales takes pride to be able to provide you a test equipment value that is unsurpassed.

**FEATURES INCLUDE:**

1. Fully operational OTDR with functions that enable complete trace analysis and automatically displays the event table that simplifies the operator's data collection.
2. **Power Meter** input providing a reading showing dBm power and dB loss with zero/reference capability.
3. **Visual Fault Locator** that is most commonly used to visibly identify continuity, bends or breaks in the cable.
4. **NEW Enhanced Reporting Software** capability to provide Pass/Fail certification reports.
5. **Endface Inspection Probe (Optional)** USB inspection probe plugs right into the unit.

6.



**Link Checker** with a quick and easy push of a button a technician reads a display of critical measurements including fiber link length and attenuation. Get results in 5 seconds. Tests at 1550nm - *This feature is only available for Singlemode testing.*

7.



**Gigabit Analyzer** identify the fiber type and plug in. The unit measures length, dB loss, back reflection and compares to the fiber manufacturer's standards to determine if bandwidth requirements pass. Does not generate or evaluate an actual signal.

PART #	DESCRIPTION	PRICE
TB1315E	SM (1310/1550) OTDR with Gigabit Analyzer, and Link Checker	\$3,595.00
TBQUADE	SM/MM (850/1300/1310/1550) OTDR with Gigabit Analyzer, and Link Checker	5,395.00
TB1315	SM (1310/1550) OTDR with PM, VFL, Gigabit Analyzer, and Link Checker	3,995.00
TBQUAD	SM/MM (850/1300/1310/1550) OTDR with PM, VFL, Gigabit Analyzer, and Link Checker	5,895.00
F1D11000	FIS digital USB endface inspection probe kit (tips included)	875.00

**THUNDERBOLT TEST KITS**

These special FIS made test kits allow the user to perform OTDR scans as well as take accurate dB loss readings for end-to-end link verification. The kit includes the standard version of our ThunderBolt OTDR, a power meter & light source kit with reference cords, a mini-VFL, and a special cleaning kit.

PART #	DESCRIPTION	PRICE
TB1315KIT	FIS ThunderBolt (1310/1550nm) SM OTDR, PM/LS kit with file storage, mini-VFL, and cleaning kit	\$4,495.00
TBQUADKIT	FIS ThunderBolt (850/1300/1310/1550nm) SM/MM OTDR, PM/LS kit with file storage, mini-VFL, and cleaning kit	6,395.00

\* If OTDR launch reels are desired, call FIS to talk about which type is needed.



**NEW**



**THE MAXTESTER OTDR SERIES**

The MAX-700B/C Series is the first tablet-inspired OTDR line that is handy, lightweight and rugged enough for any outside plant environment. With a 7-inch, outdoor-enhanced touchscreen—the most efficient handheld display in the industry—it delivers an unprecedented user experience. Its intuitive Windows-like GUI ensures a fast learning curve. Plus, its new and improved OTDR 2 environment offers icon-based functions, instant boot-up, automatic macrobend finders as well as improved auto and real-time modes.



**ALSO AVAILABLE WITH IOLM**

**FEATURES**

- Handy, lightweight, powerful, tablet-inspired design
- 7-inch, outdoor-enhanced touchscreen - Biggest in the handheld industry
- 12-hour battery life
- Dead zones: EDZ 0.5 mtr, ADZ 2.5 mtr (Max-730)
- Dynamic range: 30/28dB - 39/38 dB
- Rugged design built for outside plant
- iOLM-ready: intelligent and dynamic application that turns complex OTDR trace analysis into a one-touch task

**MAX-715B OTDR**

Optimized for the P2P testing and troubleshooting of FTx architectures, and ideal for testing short fibers (e.g., inside a CO, FTx drop cable or FTTA/DAS installations) (30 dB).

PART #	DESCRIPTION	PRICE
TK-MAX-715B-M1-XX	MAX-715B, Last Mile SM OTDR 1310/1550nm, 30/28 dB (9/125µm)	\$5,265.00
TK-MAX-715B-M2-XX	MAX-715B, Last Mile SM OTDR Port 1: 1310/1550nm, 30/28 dB (9/125µm) Port 2: Filtered 1625nm, 28 dB (9/125µm)	7,645.00
TK-MAX-715B-M3-XX	MAX-715B, Last Mile SM OTDR 1310/1550/ 1625nm, 30/28/28 dB (9/125µm)	7,535.00
PM2X-XX	Power Meter ONLY (GeX detector) With FOA-XX: Connector Adapter	820.00
VPM2X-XX	VFL + Power Meter - Visual Fault Locator (650nm) With 2.5mm Universal Adapter - Power Meter (GeX detector) With FOA-XX: Connector Adapter	1,085.00
RF	Built-in Wi-Fi and Bluetooth Capability	275.00

**MAX-720C OTDR**

Efficient testing of closely spaced events, such as patchords and patch panels in COs, and optimized for the P2P testing of any access network (36 dB).

PART #	DESCRIPTION	PRICE
MAX-720C-SM1-XX	MAX-720C, Access SM OTDR 1310/1550 nm, 36/35 dB (9/125 µm)	\$5,470.00
MAX-720C-SM2-XX	MAX-720C, SM OTDR Port 1: 1310/1550 nm, 36/35 dB (9/125 µm) Port 2: Filtered 1625 nm, 35 dB (9/125 µm) for live fiber testing	7,990.00
PM2X-XX	Power Meter ONLY (GeX detector) With FOA-XX: Connector Adapter	820.00
VPM2X-XX	VFL + Power Meter - Visual Fault Locator (650nm) With 2.5mm Universal Adapter - Power Meter (GeX detector) With FOA-XX: Connector Adapter	1,085.00
RF	Built-in Wi-Fi and Bluetooth Capability	275.00

**MAX-730C OTDR**

Fully featured, entry-level, dedicated OTDR with tablet-inspired design, suitable for P2P access network and metro link testing. Optimized to test through optical splitters, for seamless end-to-end FTTH characterization and troubleshooting. Filtered 1625nm port for live fiber testing available.

PART #	DESCRIPTION	PRICE
MAX-730C-SM1-XX	MAX-730C, FTx/PON SM OTDR 1310/1550 nm, 39/38 dB (9/125 µm)	\$7,660.00
MAX-730C-SM2-XX	MAX-730C, FTx/PON SM OTDR Port 1 : 1310/1550 nm, 39/38 dB (9/125 µm) Port 2 : Filtered 1625 nm, 39 dB (9/125 µm)	9,850.00
MAX-730C-SM3-XX	MAX-730C, FTx/PON SM OTDR 1310/1550/1625 nm, 39/38/39 dB (9/125 µm)	9,745.00
PM2X-XX	Power Meter ONLY (GeX detector) With FOA-XX: Connector Adapter	820.00
VPM2X-XX	VFL + Power Meter - Visual Fault Locator (650nm) With 2.5mm Universal Adapter - Power Meter (GeX detector) With FOA-XX: Connector Adapter	1,085.00
RF	Built-in Wi-Fi and Bluetooth Capability	275.00

Models	MAX-715B	MAX-720C	MAX-730C
<b>Configurations</b>	1310/1550 nm 1310/1550 nm and 1625 live*	1310/1550 nm and 1625 live	1310/1550 nm 1310/1550 nm and 1625 live*
<b>Dynamic range at 1310/1550/1625</b>	30/28/28 dB	36/35/35 dB	39/38/38 dB
<b>ADZ/EDZ</b>	1m / 4 m	SM 0.7m/3m	0.5m/2.5m
<b>PON</b>	N/A	Up to 1x32	Up to 1 x 128

\* SEE PAGES 23, 29, 44, 45 FOR VIDEO INSPECTION PRICES

**EXFO OPTICAL WAVE EXPERT - DWDM TESTING SOLUTION**

An all-in-one DWDM Channel Checker and OTDR in a solid state compact form. The rugged MaxTester platform provides the most efficient and practical form factor for field use.

**FEATURES**

- Integrated DWDM channel checker and OTDR on a single port (patent-pending)
- Intelligent channel power level measurements
- Compact and portable form factor
- iOLM-ready: one-touch multiple acquisitions, with clear MUX/DEMUX characterization
- C-BAND ITU-T G.692 DWDM grid channels (12-62)
- Bar graph and table view on wide touchscreen display
- In-channel and testing of active networks
- Intuitive graphical user interface (GUI) and workflow

PART #	DESCRIPTION	PRICE
MAX-740C-DWOCC-iO-iADV-EA-EUI-91-VPM2x-FOA-54B-RF	iOLM advanced, OTDR, VFL, Power Meter, Wifi, Bluetooth	\$25,660.00
MAX-740C-DWOCC-OTDR-EA-EUI-91-VPM2x-FOA-54B-RF	OTDR, VFL, Power Meter, Wifi, Bluetooth	23,255.00
MAX-740C-DWOCC-iOLM-00-EA-EUI-91-VPM2x-FOA-54B-RF	iOLM, OTDR, VFL, Power Meter, Wifi, Bluetooth	23,258.00
MAX-740C-DWOCC-OTDR-EA-EUI-91-00-RF	OTDR, Wifi, Bluetooth	22,170.00

PLEASE CALL YOUR FIS SALES REPRESENTATIVE FOR OTHER AVAILABLE CONFIGURATIONS



EXFO OPTICAL WAVE EXPERT





**FIP-500 FIBER INSPECTION SCOPE**

Fastest inspection in the industry for both single-fiber and multi-fiber connectors, with the most reliable results. Self-contained, fully automated tool for zero-button testing all day without the need to recharge batteries or off load results.

**KEY FEATURES AND BENEFITS**

- Best-in-class optical performance for accurate and repeatable results
- Zero-button inspection: 100% automated from insertion to data saving (auto-detect, auto-brightness, auto-focus, auto-center, auto-capture, auto-analysis, auto-save and auto-reset)
- Automated threshold adjustment with SmartTips
- Fastest inspection in the industry (within 10 seconds for MPO-12 from connection to analyzed and saved result)
- Wide array of adapter tips for single-fiber and multi-fiber connectors (e.g., LC, SC, ST, OptiTap®, OptiTip®, MPO)
- Smartphone-grade 2.4-inch color touchscreen
- Quick-connect design: quarter-turn click for switching between any tips
- Long-lasting battery
- Stores test results locally - 1800 (MPO-12) or 10 000 (single-fiber)
- On-board connector endface analysis (as per IEC standards)
- PDF reporting via mobile devices



FIP-500

**APPLICATIONS**

- Central offices, exchanges and headends
- Data centers
- Wireless (e.g., 5G, FTTA, DAA, small cells)
- Fiber-to-the-home (FTTH)

**Build Your Own FIP-500**

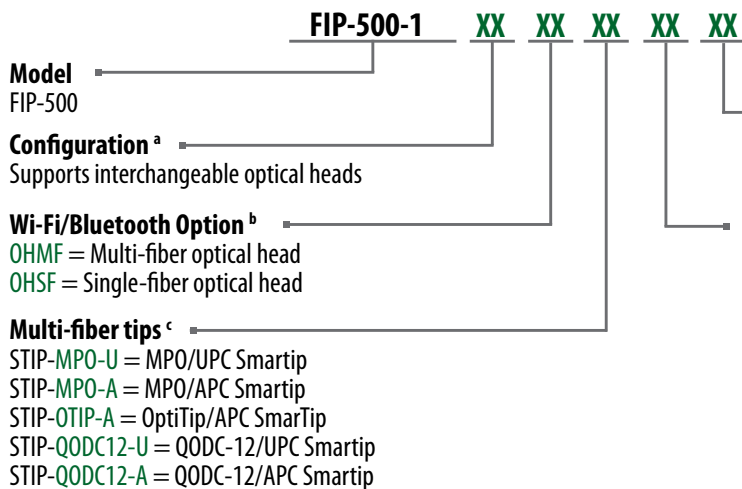

**Single-fiber tips (bulkhead)<sup>d</sup>**  
STIP-SC-A = SmartTip for SC/APC bulkhead connector  
STIP-OTAP-A = SmartTip for OptiTap bulkhead connector

**Single-fiber tips (cord)<sup>c</sup>**  
STIP-U2.5-U = SmartTip for universal 2.5-mm/UPC patchcord  
STIP-U2.5-A = SmartTip for universal 2.5-mm/APC patchcord  
Example: FIP-500-1-OHMF-OHSF-STIP-MPO-U-STIP-MPO-A-STIP-U2.5-A-STIP-U2.5-UP-U2.5-U

- a. More than one optical head or SmartTip can be ordered together with the FIP-500.
- b. Both optical heads can be purchased together.
- c. Multi-fiber optical head required.
- d. Single-fiber optical head required.

PART #	DESCRIPTION	PRICE
FIP500KIT1	MPO UPC inspection: Includes FIP-500-1 with interchangeable multi-fiber optical head (OHMF), MPO/UPC Smartip (STIP-MPO-U), soft carrying case	\$5,240.00
FIP500KIT2	MPO APC inspection: Includes FIP-500-1 with interchangeable multi-fiber optical head (OHMF), MPO/APC Smartip (STIP-MPO-A), soft carrying case	5,240.00
FIP500KIT3	MPO UPC & APC inspection: Includes FIP-500-1 with interchangeable multi-fiber optical head (OHMF), MPO/UPC Smartip (STIP-MPO-U), MPO/APC Smartip (STIP-MPO-A), soft carrying case	5,490.00

**iOLM-What Is It and How Does It Work?**

The iOLM is an innovative OTDR-based application that uses multipulse acquisitions and advanced algorithms to deliver detailed information on every element on the link.

- Offers one-touch, automatic analysis and clear link view display
- Minimizes training and avoids misconfiguration thanks to automatic parameter settings and clear go/no-go results
- Turns complex OTDR information into simple and accurate analysis with Link-Aware technology, minimizing truck rolls
- Identify each event on the network and obtain a straightforward fiber link status with the Optical Link View
- Provides prompt diagnosis to fix network issues quickly and efficiently
- Generates OTDR trace files (.sor)

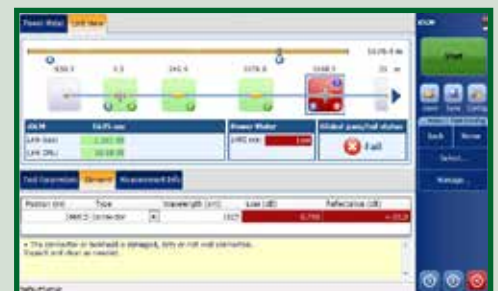



# EXPERTISE REACHING OUT

## EXFO FTB-1v2 SINGLE- OR DUAL-CARRIER OTDR PLATFORM

The FTB-1 version 2 is a light-weight compact test platform allowing field technicians to carry out dedicated optical test applications simply and efficiently, thanks to its ultra-powerful processing and highly intuitive interface. Loaded with utilities, it provides all the tools required to maximize field testing. Now available for single- or dual-carrier configurations to slot FTBx test modules, the built-in intelligence of the FTB-1 V2 empowers frontline technicians to take field-testing efficiency to the next level.

### FEATURES

- 8-inch color multi-touch widescreen
- Ethernet port (10/100/1000 Base-T)
- Headset/Microphone port
- MicroSD card slot for extended storage space
- Optional plug-and-play power meter and VFL
- Remote access to your unit (via VNC or Remote Desktop)

### iOLM Software Option

- 00 = iOLM Standard
- iADV = iOLM Advanced (\$765)
- iLOOP = iOLM loopback mode (\$1,090)
- iCERT = iOLM tier-2 certification (\$435)

### Digital Inspection Probe

- FP410B-XX = Inspection Probe 200x/400x, Manual Focus, No Auto Analysis (\$1,440)
- FP420B-XX = Inspection Probe 200x/400x, Manual Focus, Auto Center, Auto Analysis (\$2,195)
- FP425B = Wireless Inspection Probe 200x/400x, Auto Center, Auto Analysis (\$3,155)
- FP430B-XX = Inspection Probe 200x/400x, Auto Focus, Auto Center, Auto Analysis (\$2,670)
- FP435B = Wireless Inspection Probe 200x/400x, Auto Focus, Auto Center, Auto Analysis (\$3,630)

XX- APC or UPC must be specified

### OTDR Adapters XX - (Place EA Before the Adapter for APC Polish or EI for UPC Polish) - Included in Module Price

- XX-EUI-89 = FC Adapter
- EUI-98 = LC adapter
- XX-EUI-91 = SC Adapter

### OTDR Module(s)

- FTBx-720C-SM1-XX = SM 1310/1550nm, 36/35dB (\$5,615)
- FTBx-730C-SM1-XX = SM 1310/1550nm, 39/38dB (\$7,140)
- FTBx-720C-Q1-QUAD-XX = MM/SM 850/1300/1310/1550nm, 27/29/36/35dB (\$10,375)
- FTBx-720C-SM2-XX = Port 1: 1310/1550, 36/35dB | Port 2: Filtered 1625nm, 34dB  
\* for live fiber testing (\$10,480)
- FTBx-730C-SM2-XX = Port 1: 1310/1550, 39/38dB | Port 2: Filtered 1625nm, 34dB  
\* for live fiber testing with in-line power meter (\$12,185)

Replace XX with: **OTDR** = Enables OTDR application only; **iOLM** = Enables iOLM application only; **OI** = Enables OTDR and iOLM applications

## Build Your Own FTB-1 v2

TK-1700 - XX - XX - XX - XX - XX - XX - XX - XX - XX

### Model

TK-1v2-700C Mainframe - (SC=\$2,345 or DC=\$2,555 with module)  
(Specify Single or Dual Carrier Version (SC or DC))

### Display

S1 = TFT Active Screen (Standard)  
S2 = Outdoor Enhanced Screen (\$320)

### Memory

64G = 64 GB internal memory (flash)

### Wi-Fi/Bluetooth Option

RF = With RF Capability - Wi-Fi and Bluetooth (\$250)

### Power Meter

00 = Without power meter(PM)/VFL  
VPM2X = VFL platform, PM; GeX detector (\$990)  
VPM2X-CWDM = VFL platform; PM; GeX detector; CWDM wavelengths calibrated from 1270 nm to 1610 nm (\$1,425)

### Connector Adapter - Included

FOA-22 = FC/PC, FC/SPC, FC/UPC, FC/APC  
FOA-98 = LC: LC/PC, LC/SPC, LC/UPC, LC/APC  
FOA-54 = SC: SC/PC, SC/SPC, SC/UPC, SC/APC

## CONTACT FIS FOR CUSTOM CONFIGURATION PRICING AND/OR TO ARRANGE A DEMONSTRATION.

### EXFO ACCESSORIES FOR OTDR/SOURCE & POWER METER ADAPTERS



PART #	DESCRIPTION	PRICE
FOA-32	ST Adapter for Power Meter	\$90.00
FOA-54B	SC Adapter for Power Meter	90.00
FOA-22	FC Adapter for Power Meter	90.00
FOA-98	LC Adapter for Power Meter	190.00
FOA-U12	Universal 1.25mm Adapter for Power Meter	200.00
FOA-U25	Universal 2.5mm Adapter for Power Meter	200.00
EUI-89	FC Source Adapter	130.00
EUI-90	ST Source Adapter Compatible with UPC Connector Interface ONLY	130.00
EUI-91	SC Source Adapter	130.00



**EXFO OPTICAL EXPLORER (OX1) - VERIFY & TROUBLESHOOT FIBER LINKS**

Optical Explorer goes beyond basic testing as compared to power meters and fault locators. It offers a brand new testing approach powered by multiple pending patents. Optical Explorer determines overall link quality and tracks potential faults. Unlike traditional instruments in their toolbox, Optical Explorer won't leave field technicians blind to faults. Each technician gets more autonomy to solve issues, enabling a leaner troubleshooting process that doesn't require several technicians with various skills.

**FEATURES**

- Displays fiber link (length, loss, ORL and power) in under 3 seconds, through single-ended testing
- On-the-spot detection and location of common causes of failures using EXFO's patent-pending Fault Explorer
- Intelligent device:
  - › No settings required
  - › Built-in expertise to interpret link quality with patent-pending EXFO Advisor (5-star ranking system)
  - › Diagnostics with suggested corrective actions
- PDF report generation through smart app
- Save on cost of ownership: lifetime calibration, no factory returns thanks to our patent-pending Click-Out optical connector
- Rechargeable battery for over 10 hours of use on a single charge
- Built-in light source and power checker (dual-band available)
- 3 year warranty



**Optical Explorer includes**

- Light source / Power Checker
- Flash Advisor/Fault Explorer
- EXFO Advisor 5-star rating
- Power, length, loss and ORL at push of a button<sup>b</sup>
- Contextual wavelength auto-selector<sup>c</sup>
- Diagnostics
- Demarcation function



**PRO version also includes**

- Click-Out optical connector
- Link Mapper
- Connectivity to splitter detection
- DNT detection<sup>d</sup>

PART #	DESCRIPTION	PRICE
OX1I88	EXFO Optical Explorer USB-A to USB-C Cable w/Soft Carry Case, 1310/1550nm	\$2,690.00
OX1PROI88	EXFO Optical Explorer PRO w/USB-A to USB-C Cable & USB AC Adapter, 1310/1550nm	3,290.00
OX1PROM88	EXFO OX1 PRO model Optical Explorer SC/APC (1650 Live)	4,590.00
OX1PROMPPM88	EXFO OX1 PRO model Optical Explorer SC/APC (1650 Live) with dual band 1490/1577nm power checker	5,470.00
OX1PROMI88	Last Mile Installation & Maintenance Optical Explorer - PRO version, SC/APC, 1310/1550/1650 nm (live)	5,990.00
OX1M88	Last Mile Maintenance Optical Explorer 1650 nm (live)	3,990.00
GP-3152	SC/APC Click-Out™ Optical Connector For OX1-PRO models	370.00
GP-3153	SC/UPC Click-Out™ Optical Connector For OX1-PRO models	370.00

PLEASE CALL YOUR FIS SALES REPRESENTATIVE FOR OTHER AVAILABLE CONFIGURATIONS AND LAUNCH CABLES

**EXFO OPTICAL EXPLORER (OX1) ACCESSORIES**

**EXFO GP-3186 GLOVE**

Store an OX1, a TCB in the back pocket, a cleaner and a VFL 140 on side pocket. Hold from the side hand-strap or the neck strap . Protect the OX1 display.

**GP-3172 KICK-STAND AND VFL HOLDER**

Carry a VFL 140 on the OX1 unit. Stabilize the OX1. Add a hand-strap. Add an o-ring to hang it from a hook.

PART #	DESCRIPTION	PRICE
GP-3186	Hands-free glove	\$59.00
GP-3172	3-in-1 accessory combining kickstand, hand-strap and VFL holder (compatible with FLS-140)	44.00
GP-3150	New/spare battery for OX1	320.00





WDM OTDRs

T-BERD MTS 4000 V2

# VIAVI - WDM OTDRs T-BERD - 4000 V2 PACKAGES OPTICAL TEST PLATFORM

MODULAR TEST PLATFORM DESIGNED FOR THE INSTALLATION, TURN-UP AND MAINTENANCE OF FIBER OPTIC NETWORKS

## FEATURES

- Dual-modular handheld platform
- Large 9-inch high visibility touchscreen with permanent function keys
- Essential tools integrated and supported in the platform (visual fault locator, optical power meter, optical microscope and talkset)
- Flexible connectivity; Ethernet, WiFi, Bluetooth
- Smart Access Anywhere (SAA) for remote control & field tech support
- StrataSync enabled — centralized cloud based asset, configuration, test data and workflow management

The VIAVI T-BERD®/MTS-4000 V2 is the optical test platform engineers, technicians, installers and contractors can rely on, providing:

- An easy-to-use solution with intuitive icon-based graphical user interface (GUI) and multi-touch screen requiring minimal training
- A compact platform with field-replaceable modules covering multiple optical test functions (OTDRs, optical power & loss testing, Optical Spectrum Analyzer (OSA), etc. . . ) that enable complete optical network qualification.
- Optimum workflow and operation within the platform or through the cloud with VIAVI StrataSync and SmartAccess Anywhere

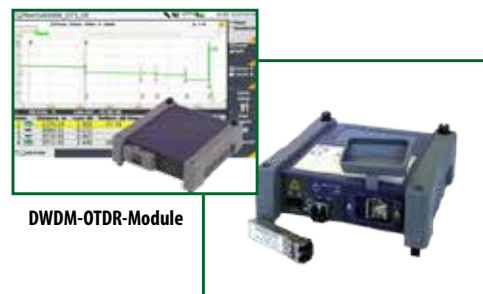

DWDM-OTDR-Module

OCC-4056C Module with SFP

### VIAVI T-BERD 4000 XWDM PACKAGES AND MODULES (Includes Platform and Module)

PART #	DESCRIPTION	PRICE
TB4K-DOTDR-AP0	T-BERD 4000v2 DWDM OTDR kit with DWDMC OTDR, Cable-SLM, PM, VFL, WiFi and SAA-L2	\$15,965.00
TB4K-DOTDR-AP2	T-BERD 4000v2 DWDM and CWDM OTDR kit with DWDMC OTDR, CWDM10U OTDR, Cable-SLM, PM, VFL, WiFi and SAA-L2	22,660.00
TB4-DWDM-P2	T-BERD 4000v2 DWDM OTDR and DWDM OCC-4056C with Optical Channel Checker, DWDMC OTDR, Cable-SLM, PM, VFL, WiFi and SAA-L2	25,750.00
E41CWDM10L-APC	10 Wavelengths CWDM OTDR from 1271 to 1451nm - APC (Modules Only)	11,124.00
E41CWDM10U-APC	10 Wavelengths CWDM OTDR from 1431 to 1611nm - APC (Modules Only)	11,124.00
E41DWDMC-APC	Tunable DWDM APC OTDR Module - C-Band (Modules Only)	21,630.00
2331/12	OCC-4056C APC; DWDM Analyzer With SFP Bay (Modules Only)	6,943.00

### VIAVI T-BERD 4000 OTDR PACKAGES (Includes Platform and Module)

PART #	DESCRIPTION	PRICE
TB4-OTDRMPO-P1	MPO OTDR Kit TB4K - WiFi - PM - Smart Link Mapper Software - 1310/1550 MA2 -APC- MPO Adapter	\$13,699.00
TB4-OTDRMPO-P2	MPO OTDR Kit TB4K - WiFi - PM - Smart Link Mapper Software - 1310/1550/1625 MA2 -APC- MPO Adapter	15,141.00
TB4-QUAD	T-BERD 4000v2 850/1300/1310/1550nm QUAD Module OTDR (26/24/37/35dB Dynamic Range) with PM, LS, VFL, WiFi/Bluetooth and SAA-L2	11,110.03
TB4-B2L	T-BERD 4000v2 1310/1550nm B Module OTDR (42/40dB Dynamic Range) with PM, LS, VFL, WiFi/Bluetooth and SAA-L2	10,886.53
TB4-B3LF65	T-BERD 4000v2 1310/1550/Filtred 1650nm B Module OTDR (42/40/40dB Dynamic Range) with PM, LS, VFL, WiFi/Bluetooth and SAA-L2	14,223.73

### VIAVI T-BERD 4000 BI-DIRECTIONAL OLTS/OTDR PACKAGES AND SW LICENSES

PART #	DESCRIPTION	PRICE
TB4-FCOMP2-FF	T-BERD 4000v2 1310/1550nm B FiberComplete - IL/ORL and Fault Finder (priced as single unit, but operates in a pair)	\$5,900.00
TB4-FCOMP2-B	T-BERD 4000v2 1310/1550nm B FiberComplete - IL/ORL and OTDR (42/40dB Dynamic Range) with PM, LS, VFL, WiFi/Bluetooth and SAA-L2 (priced as single unit, but operates in a pair) *Lower dynamic range (cost) versions available	10,990.00
TB4-OTDR2LMPOS	T-BERD 4000v2 1310/1550 B Module OTDR (42/40dB Dynamic Range) and MPO Switch Module, with PM, LS, VFL, WiFi/Bluetooth and SAA-L2	17,015.03
TB4-OTDR3LF65MPOS	T-BERD 4000v2 1310/1550/Filtred 1650 B Module OTDR (42/40/40dB Dynamic Range) and MPO Switch Module, with PM, LS, VFL, WiFi/Bluetooth and SAA-L2	20,352.23
TB4-FCOMP2MPOS	T-BERD 4000v2 1310/1550/1650 B FCOMP Module BI-DIR IL/ORL/OTDR (42/40/40dB Dynamic Range) and MPO Switch Module, with PM, LS, VFL, WiFi/Bluetooth and SAA-L2	21,711.83
E410TDRPM	Power Meter Option for OTDR Modules	279.00
EOTDR-TO-FCOMP-UPG	Add FiberComplete To 4100 B OTDR Modules -If Module PM (E410TDRPM) is Calibrated	1,050.00
EFCOFF2OTDR-UPG	Add OTDR To FiberComplete Fault Finder Modules	6,633.00
MPO12MODKIT-SM	Singlemode MPO Switch Kit with 1x12 Module Switch and Launch Cables	5,356.00
ETRUEBIDIR-FCOMP-PRO-UPG	Truebidir Upg. Sw License - On-Board Real Time Bidirectional Event Analysis	1,500.00

# VIAMI T-BERD - 2000 PACKAGES & MODULES OPTICAL TEST MAINFRAME

HANDS-FREE TEST SET FOR THE INSTALLATION, TURN-UP AND MAINTENANCE OF FIBER OPTIC NETWORKS.

VIAMI T-BERD 2000 mainframe is a handheld single modular unit which can accept a wide variety of modules for virtually any testing application. Whether it be standard or PON OTDR, Bi-directional Insertion Loss Testing, WDM OTDR or Optical Spectrum Analyzer.



T-BERD MTS 2000

### VIAMI T-BERD 2000 FTTX/PON OTDR PACKAGES (Includes Mainframe and Module)

PART #	DESCRIPTION	PRICE
TB2-OTDR-2WLA	T-BERD 2000 Short Range 1310/1550nm OTDR with LS, and PM (33/35dB)	\$4,326.00
TB2-OTDR-TK3	T-BERD 2000 FTTA/FTTH Contractor OTDR Test Kit (1310/1550/1650nm, 35/33/30dB)	8,085.00
TB2-QUAD-TK2	T-BERD 2000 QUAD FTTA/Enterprise OTDR Test Kit (26/24/37/35dB)	8,755.00
TB2-FCOMP2B	T-BERD 2000 package 1310/1550nm FiberComplete w Metro Access OTDR (37/35dB)	9,500.00

### VIAMI T-BERD 2000 WDM PACKAGES (Includes Mainframe and Module)

PART #	DESCRIPTION	PRICE
TB2-CWDM-P1	T-BERD 2000 with 1431-1611nm CWDM OTDR	9,476.00
TB2-DWDMOCC-P1	T-BERD 2000 DWDM Channel Checker Package (OSA)	8,240.00

### SMARTOTDR™ HANDHELD OTDR FIBER TESTER

Affordable, easy-to-use handheld testing for technicians at any level. The lightweight and compact SmartOTDR solution performs all essential fiber tests for metro and access networks with:

#### OTDR measurements

- Fiber inspection with automated end-face analysis
- Optical loss testing (optical light source and optical power meter)
- Visual fault location

#### Key Benefits

- Simplifies OTDR analysis with Smart Link Mapper (SLM) option
- Automates testing with objective, pass/fail results

With a tailored interface for different skill levels, it speeds and optimizes field testing for any technician.

#### KEY FEATURES

- Single-/dual-/tri-wavelength versions with 1310, 1550, and in-service 1625nm wavelengths
- Integrated CW light source
- PON optimized to test through a 1x128 splitter
- 3G/4G connectivity via USB, Bluetooth/ WiFi
- 3-year warranty
- All-day battery life

PART #	DESCRIPTION	PRICE
FSTOTDR-PRO-I-APC	SmartOTDR Fiber Installation Tester PRO Kit 1310/1550nm (37/35dB Dynamic Range) with PM, LS, VFL and WiFi/Bluetooth - APC	\$5,135.00
FSTOTDR-PRO-IM-APC	SmartOTDR Fiber Install/Maint. Tester PRO Kit 1310/1550/F1650nm (37/35/32dB Dynamic Range) with PM, LS, VFL and WiFi/Bluetooth - APC	7,270.00
FSTOTDR-PREMIUM-I-APC	SmartOTDR Fiber Installation Tester PREMIUM Kit 1310/1550nm (40/40dB Dynamic Range) with PM, LS, VFL, WiFi/Bluetooth and FTTH-SLM BASE - APC	7,380.00
FSTOTDR-PREMIUM-IM-APC	SmartOTDR Fiber Install/Maint. Tester PREMIUM Kit 1310/1550/F1650nm (40/40/41dB Dynamic Range) with PM, LS, VFL, WiFi/Bluetooth and FTTH-SLM BASE - APC	10,075.00
FOPT-PRO-M-APC	Fiber Meter @1650nm with Dual-band Selective Power Meter (1490/1550nm or 1490/1577nm), VFL, WiFi/Bluetooth and OptiTrak App SW. Carrying case, glove and 20m launch cable included	4,437.00



FSTOTDR-PRO-IM-APC



**SMARTCLASS™ FIBER OLTS - 85P (INSPECTION AND TEST)**

The Viavi OLTS-85/85P handhelds are the industry's fastest and easiest solutions for Tier 1 fiber certification. These latest additions to our popular SmartClass Fiber family let technicians measure length, measure optical loss (two fibers, two wavelengths), check polarity, inspect fiber end faces and generate certification reports.



2326/35

**FEATURES**

- Complete Tier 1 fiber testing to TIA/ISO/IEC standards
- Dedicated MM, SM and Quad versions
- Fiber end-face inspection with automated pass/fail analysis on both local and remote devices
- Integrated saving of both local and remote results on the local device
- Encircled Flux Compliant
- Instant on from sleep mode
- Onboard storage for all test results.
- Easily-generated fiber certification reports
- 3.5" color touch screen
- Exports results via USB or directly to PC via FiberChekPRO™ reporting software
- All-day battery life

PART #	DESCRIPTION	PRICE
2326/35	OLTS-85P Tier-1 Quad Optical Loss Kit with Patch Cord Microscope *	\$13,545.00
2325/35	OLTS-85 Tier-1 Quad Optical Loss Kit *	11,325.00
2325/34	OLTS-85 Tier-1 MM Optical Loss Kit *	7,310.00
2325/31	OLTS-85 Tier-1 SM Optical Loss Kit *	9,160.00
2325/11	OLTS-85 Tier-1 Loss Test Set SM **	4,510.00
2325/15	OLTS-85 Tier-1 Loss Test Set Quad **	6,100.00
2326/15	OLTS-85P Tier-1 Loss Test Set Quad SC mounted **	6,735.00

\* Kits (include local and remote test sets, carry case, and test reference cords)

\*\* Individual Test Sets (include local test set, battery, and charger)



OCC-56C Channel Checker

**VIAYI CHANNEL CHECKERS AND OSA MODULES**

PART #	DESCRIPTION	PRICE
2277/44	OCC-56C, DWDM Optical Channel Checker, C-Band; APC, SC mounted FC enclosed	\$6,090.00
2277/43	OCC-55 Smart Optical Channel Checker CWDM APC SC mounted FC enclosed	4,830.00
2277/40	OCC-55 Optical Channel Checker CWDM PC SC mounted FC enclosed	6,965.70
2301/12	COSA-4055 APC CWDM OSA Module with SFP Bay - SC optical adapter mounted FC enclosed	5,200.00
2331/12	OCC-4056C APC, DWDM Analyzer with SFP Bay	6,741.00



E4136MA3-APC

**VIAYI T-BERD 2000/4000 MAINFRAME PON/WDM MODULES (Modules Only)**

PART #	DESCRIPTION	PRICE
E4136MA3-APC	METRO-ACCESS/PON 1310/1550/1625nm with APC Adapter, OTDR Module (43/41/41dB)	\$9,754.00
E4126LA-APC	1310/1550 nm OTDR Module with APC Adapter (35/33dB)	3,373.00
E4146QUAD	Multimode/Singlemode 850/1300/1310/1550nm OTDR with UPC Adapter	6,880.00
E41CWDM10L-APC	10 Wavelengths CWDM OTDR from 1271 to 1451nm (Lower Wavelengths)	11,124.00
E4146QUAD-PM-APC	MULTIMODE/SINGLEMODE 850/1300/1310/1550nm QUAD Module OTDR (26/24/37/35dB Dynamic Range) with LS AND PM - SM APC/MM PC	6,970.00
E4126B-APC	4100 MODULE B OTDR - 1310/1550nm B Module OTDR (42/40dB Dynamic Range) - APC	6,746.00
E4138FB65-APC	4100 MODULE B OTDR - 1310/1550/Filtred 1650nm B Module OTDR (42/40/40dB Dynamic Range) - APC	10,084.00
E4126C-APC	4100 MODULE C OTDR - 1310/1550nm C Module OTDR (46/45dB Dynamic Range) - APC	9,528.00
E4138FC65-APC	4100 MODULE C OTDR - 1310/1550/Filtred 1650nm B Module OTDR (46/45/43dB Dynamic Range) - APC	13,390.00

**T-BERD 2000/4000 ADAPTERS AND ACCESSORIES**

PART #	DESCRIPTION	PRICE
2256/90.05	Connector Cleaning Sticks 2.5mm 5 Pieces	\$9.35
2014/00.09	FC Type NTT.D3	111.00
2014/00.21	Adapter 21: ST Type	98.00
2014/00.24	Adapter 24: SC-PC SC-APC	111.00
2014/00.28	Adapter 28: UPP for LC MU D 1.25mm	98.00
2014/00.29	Adapter 29: LC F-3000 -PC -APC	111.00
2014/00.31	UPP for DIN FC SC ST and MST D 2.5mm	106.00
2150/00.32	Universal Optical Adapter: ST-Type	174.30
2150/00.50	Universal Optical Adapter: DIN 47256-Type	174.30
2150/00.51	Universal Optical Adapter: FC-PC FC-APC -Type	174.30
2150/00.58	Universal Optical Adapter: SC-PC APC-Type	174.30
2237/90.04	Universal Battery Charger AA/AAA-Accu NiCd/NiMH	123.00
2255/90.10	FI-10 11 Adapter for 2.00mm Connector Types	118.65
2302/90.01	SNT-505 Universal AC Power Adapter Micro USB Connector	\$40.00



2150/00.58

2150/00.32



2150/00.51



## OLP-82/82P SERIES INTEGRATED FIBER INSPECTION AND TESTING

The OLP-82 and OLP-82P (with integrated patch cord microscope) combine fiber inspection and optical power measurement (OPM) into one convenient solution. As part of the SmartClass Fiber family from VIavi Solutions, these handheld test tools feature a 3.5" color touch screen that allows users to inspect fiber end-faces with automated pass/fail analysis and with either a P5000i probe microscope (connected via USB) or the integrated patch cord microscope (OLP-82P) and also measure optical power at multiple calibrated wavelengths from 780 to 1625nm.

PART #	DESCRIPTION	PRICE
FIT-82P01-PRO	Fiber Optic Inspection and Test Kit 200/400x FBP Probe	\$2,700.00



FIT-82P01-PRO

## P5000I FIBER MICROSCOPE

Automated Fiber Inspection & Analysis Probe provides PASS/FAIL capability to PC, laptops, mobile devices and Viavi test solutions. The P5000i makes it fast and easy to certify that every connection in your network is clear and optimized. This intelligent fiber microscope removes the guesswork from fiber inspection and provides reliable and objective PASS/FAIL analysis of the fibers that connect customers to your network and to the best user experience possible.

PART #	DESCRIPTION	PRICE
FBP-SD101	Inspection Kit Digital FBP-P5000i, FiberChekPro Software, FBPT Tips SC, LC, U25M, U12M, carrying case	\$1,600.00
FIT-SD103	Digital Inspection and Test Kit Includes FBP-P5000i Digital Probe Microscope, inspection tips (SC, LC, Univ. 2.5 male, Univ. 1.25 male), MP-60 USB Optical Power Meter with Universal 2.5mm	1,955.00
SW-FCM-A1	Activation key for P5000i Android device compatibility	270.00



FBP-SD101

## FIBERCHEK PROBE MICROSCOPE

The FiberChek probe builds on Viavi's industry leading expertise in fiber inspection to deliver a single "all-in-one" handheld solution that every fiber technician can rely on for all of today's fiber inspection needs in a fully autonomous, handheld device. With built-in capabilities for image viewing, auto-focus, Pass/Fail analysis, storing/recalling results, the FiberChek probe completely automates inspection workflow to ensure fast and accurate performance. Whether used as on its own or connected (WiFi, Bluetooth, USB) to other devices, the FiberChek probe is the essential fiber tool for every technician.

PART #	DESCRIPTION	PRICE
FIT-FC-KIT1	Kit FiberChek Autofocus WiFi Microscope Case	\$3,400.00
FIT-FC-KIT2	Kit FiberChek Autofocus WiFi Microscope Tips for LC/PC and SC/PC Case	3,500.00
FIT-FC-KIT3	Kit FiberChek Autofocus WiFi Microscope Tips for LC/PC SC/PC and SC/APC Case	3,605.00



FIT-FC

## MINI VISUAL FAULT LOCATOR

Whether installing or troubleshooting, the Visual Fault Locator (VFL) is an essential tool that quickly and easily locates problem areas in fiber cables. By pinpointing the exact location of fiber damage, technicians can diagnose, troubleshoot, and fix the problem efficiently. The VFL is also used for conducting continuity tests and performing fiber identification.

PART #	DESCRIPTION	PRICE
FFL-050	Visual Fault Locator Mini 2.5mm (Pocket Sized)	\$175.00



FFL-050

## VIavi PROBE ADAPTER TIPS

Adapter tips for FBP and FIT microscopes.

PART #	DESCRIPTION	PRICE
FBPT-LC-L	Tip LC Bulkhead Long-Reach for FBP	\$344.00
FBPT-MTP-L	Tip MTP Bulkhead Long-Reach for FBP	792.00
FBPT-FC-APC	Tip FC-APC Bulkhead for FBP	175.00
FBPT-SC	Tip SC Bulkhead for FBP (A)	58.00
FBPT-SC-APC	Tip SC-APC Bulkhead for FBP (B)	115.00
FBPT-U12M	Tip Univ. 1.25mm Patch Cord for FBP	81.00
FBPT-U25M	Tip Univ. 2.5mm Patch Cord for FBP	81.00
FBPT-U25MA	Tip Univ. 2.5mm Patch Cord APC Polish for FBP	92.00
FBPT-FC	Tip FC Bulkhead for FBP	81.00
FBPT-LC-APC	Tip LC/APC Bulkhead for FBP	520.00
FBPT-MTPA-L	Tip MTP-APC Bulkhead Long Reach for FBP	1,147.00
FBPT-LC	Tip LC Bulkhead for FBP	81.00
FBPT-U12MA-SF	Tip Univ. 1.25mm Patch Cord APC Polish Slip FIT for FBP	126.00
FBPT-ST	Tip ST Bulkhead for FBP	81.00

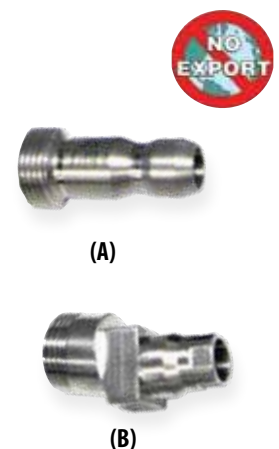

(A)

(B)



Fiber Visualizer software now standard on all MT9090A OTDRs to simplify operation and generate reports directly from the unit.

## ANRITSU MT9090A WITH MU909014X/15X OTDR MODULE

The Network Master™ MT9090A OTDR may be small but don't let its size fool you. It features 2cm resolution, 1m dead zones and up to 38dB dynamic range. Two or three wavelength versions for both installation (1310/1550nm) and maintenance (filtered 1650 nm or 1625nm) are available to cover all your FTTx, RRRH, DAS and general fiber testing needs. All MT9090A kits include mainframe, OTDR module with Fiber Visualizer software, battery, charger, soft case, rubber boot and connector adapter.

MT9090A OTDR with Fiber Visualizer Summary

PART #	DESCRIPTION	PRICE
Z1489A	1310/1550nm (37/36dB) OTDR, VFL, Protector, Power Meter -5 to -50dB	\$6,332.00
Z1490A	1310/1550nm (32/31dB) OTDR, VFL, Protector, Power Meter -5 to -50dB	5,923.00
Z1490B	1310/1550+1650nm (38/37/35dB) OTDR, PON PM/LS with Protector	8,191.00
Z1490C	1310/1550+1650nm (32/31/32dB) OTDR, PON PM/LS with Protector	7,819.00

### MT9090 ACCESSORIES

PART #	DESCRIPTION	PRICE
J0617B	Anritsu Replacement FC Adapter	\$102.00
J0618D	Anritsu Replacement ST Adapter	102.00
J0619B	Anritsu Replacement SC Adapter	102.00
J1534A	Anritsu SC/UPC-LC/UPC Adapter	128.00
G0306B	Connector Inspection 400x Microscope, USB, 7 tips	1,607.00
B0600B	Hard Case for MT9090	321.00
G0203A	Replacement AC Adapter/Charger	91.00
G0202A	Replacement NiMH Battery Pack	61.00

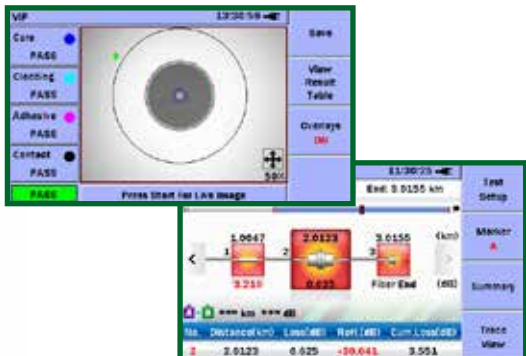

S361E / S362E / S361E / S362E

Touch Screen

## ANRITSU SITE MASTER™ S331E/S332E/S361E/S362E

The Site Master compact cable and antenna analyzer series is the leading 2-port solution that provides coverage from 2 MHz to 4/6 GHz. This portable and rugged solution has a variety of configuration options that make it the preferred solution by wireless operators and contractors, DAS installers, public safety network installers and maintenance professionals. Because of the Site Master series multi-functional capabilities and options, it eliminates the need for you to carry and learn multiple instruments. Each Unit Includes: Soft carrying case, AC/DC power supply, automotive power adapter 12V/60W, USB 2.0 A/Mini B cable, Li-Ion rechargeable battery, screen protector, stylus.

PART #	DESCRIPTION	PRICE
S331E	Site Master, 2 MHz to 4GHz Cable & Antenna Analyzer	\$7,750.00
S332E	Site Master, 2 MHz to 4GHz Cable & Antenna Analyzer, 9kHz to 4GHz Spectrum Analyzer	12,770.00
S361E	Site Master, 2 MHz to 6GHz Cable & Antenna Analyzer	9,145.00
S362E	Site Master, 2 MHz to 6 GHz Cable & Antenna Analyzer, 9 kHz to 6 GHz Spectrum Analyzer	17,165.00

## ANRITSU PIM MASTER™ - MW82119B

PIM Master™ B-series is a 40-Watt, battery-operated PIM analyzer featuring Site Master™ line sweep capability. Includes a large display and intuitive user interface that is optimized for field conditions. PIM Master's portability enables both PIM and line sweep testing at the "top-of-the-tower," helping operators to achieve maximum RF performance from their LTE Remote Radio Head (RRH) installations. **Each Unit Includes:** Soft carrying case, shoulder strap, AC/DC power supply, automotive power adapter 12V/60W, low PIM adapter (7/16 DIN(m) to 7/16 DIN(f), DC to 3 GHz, 50 Ω), Ethernet cable, USB A-Mini B cable, Li-Ion rechargeable battery, screen protector, stylus.

PART #	DESCRIPTION	PRICE
MW82119B	PIM Master base unit (must be ordered with 1 frequency option)	\$900.00
MW82119B-0700	Option 700, LTE 700 MHz frequency	20,785.00
MW82119B-0701	Option 701, APT 700 MHz frequency	20,785.00
MW82119B-0800	Option 800, LTE 800 MHz frequency	20,785.00
MW82119B-0850	Option 850, Cellular 850 MHz frequency	20,785.00
MW82119B-0900	Option 900, E-GSM 900 MHz frequency	20,785.00

CALL YOUR FIS SALES REPRESENTATIVE FOR MORE AVAILABLE OPTIONS!  
1-800-500-FIS(347)





# FIS IS THE NATION'S LARGEST ANRITSU OTDR STOCKING DISTRIBUTOR

## ANRITSU ACCESS MASTER™ MT9085 SERIES



### OTDR FEATURES

- 8-inch TFT 16:9 wide touch screen display for use indoors and outdoors
- Longer battery operation time: Up to 12 hours
- Wider operating temperature range: -10 to 50°C
- Quickly change between trace and Fiber Visualizer summary
- Wi-Fi/Bluetooth connectivity
- Rotary knob and new short-cut function keys simplify and minimize operations and time to complete a test
- Fiber Visualizer software to simplify PASS/FAIL analysis and PDF reports directly from the OTDR



MT9085 SERIES

The ACCESS Master MT9085x is a handheld complete Fiber Optic Cable tester for performing all optical pulse tests, optical loss/power measurements and optical fiber end-face inspections. Ideal for FTTx, PON, Metro WDM. The MT9085 now features an 8-inch TFT 16:9 wide touch screen display for use indoors and outdoors while providing a rotary knob and new short-cut function keys that simplify and minimize operations and time to complete a test.



Traditional OTDR graph

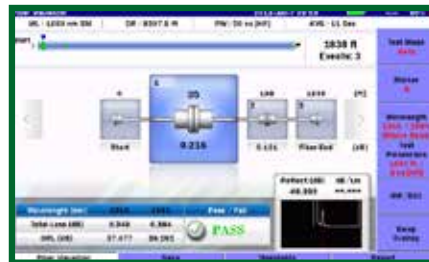

Fiber Visualizer Summary



IEC 61300-3-35 Connector Inspection

**Each Unit Includes:** 8 inch wide Touchscreen Display, Protector Option, Softcase & Connector. Deluxe kits also include PM/LS, and VFL. Specify the adapter when ordering.



### MT9085A

PART #	DESCRIPTION	PRICE
MT9085A-053SM-BSC	Single Mode 1310/1550nm 39/37.5dB Basic Kit	\$7,841.00
MT9085A-063QM-BSC	Quad SM/MM 850/1300/1310/1550nm 29/28/39/37.5dB Basic Kit	12,031.00
MT9085A-053SM-DLX	Single Mode 1310/1550nm 39/37.5dB Deluxe Kit	9,151.00
MT9085A-063QM-DLX	Quad SM/MM 850/1300/1310/1550nm 29/28/39/37.5dB Deluxe Kit	13,341.00

### MT9085B

MT9085B-053SM-BSC	Single Mode 1310/1550nm 42/41dB Basic Kit	\$8,888.00
MT9085B-063QM-BSC	Quad SM/MM 850/1300/1310/1550nm 29/28/42/41dB Basic Kit	13,079.00
MT9085B-053SM-DLX	Single Mode 1310/1550nm 42/41dB Deluxe Kit	10,198.00
MT9085B-063QM-DLX	Quad SM/MM 850/1300/1310/1550nm 29/28/42/41dB Deluxe Kit	14,389.00

### MT9085C

MT9085C-053SM-BSC	Single Mode 1310/1550nm 46/46dB Basic Kit	\$11,507.00
MT9085C-053SM-DLX	Single Mode 1310/1550nm 46/46dB Deluxe Kit	12,817.00

PART #	DESCRIPTION	PRICE
G0382A	Auto focus 400x Video Inspection Probe with tips	\$3,366.00
G0310A	Spare LiION battery for MT1000A	357.00
J0617B	Replacement FC Adapter for MT1000 and MT9085	102.00
J0618D	Replacement ST Adapter for MT1000 and MT9085	102.00
J0619B	Replacement SC Adapter for MT1000 and MT9085	102.00

## AVAILABLE AUTO FOCUS PROBE

G0382A



### FEATURES

The G0382A comes with the following standard accessories.

- Soft Bag
- Seven Connector Tips
  - 1.25mm PC Male
  - 2.5mm PC Male
  - 2.5mm APC Male
  - 1.25mm PC Female(LC)
  - 2.5mm PC Female(FC)
  - 2.5mm PC Female(SC)
  - 2.5mm APC Female(SC)
- Quick Reference Guide



## AFL SINGLEMODE FLEXSCAN® FS200 OTDRS

Pocket-sized, performance-packed, user friendly FlexScan FS200 OTDRs enable both novice and expert technicians to quickly and reliably troubleshoot optical networks or fully characterize newly installed or repaired networks. Using FlexScan's innovative SmartAuto mode, multiple OTDR scans quickly and accurately detect, locate, identify and measure network components and faults. After applying industry-standard or user-set pass/fail criteria, the characterized network is displayed using FLEXSCAN's intuitive, icon-based LinkMap® view.

FLEXSCAN automates test setup, shortens test time and simplifies results interpretation, improving efficiency and reducing the cost of testing. Acquired results may be stored internally or externally. Internally stored results are easily accessed via USB, Bluetooth or WiFi.

With optional connector inspection, integrated source, power meter and VFL, FLEXSCAN offers an all-in one solution, ensuring technicians have everything they need to locate and resolve optical network issues. Uploaded results may be viewed and reports may be generated using the included Windows-compatible TRM® 3.0 Test Results Manager software.

### NEW FEATURES

- Fast! Flexpress mode completes dual-wavelength tests in <5 seconds – 10 x faster than conventional OTDRs! For multi-fiber testing, Flexpress mode automatically controls 12-fiber MPO Switch to further reduce multi-fiber test time.
- FlexScan FS200 now has built in MPO Switch control: MPO Kit: Includes selected FlexScan and accessories, MFS-12-SM Single-mode Multi-Fiber Switch, USB cable and 30mtr fiber to connect FlexScan to Switch, plus 30mtr MPO Launch Cable to connect Switch to MPO-terminated multi-fiber network

### FS200-100 KITS (1310/1550 NM OTDR, OLS, OPM, VFL)

PART #	DESCRIPTION	PRICE
FS200-100-BAS-P1-W1	Basic Kit; TRM 3.0 Basic and carry case (1310/1550nm OTDR, OLS, OPM, VFL) (32/30dB)	4,495.00
FS200-100-PLUS-P1-W1	Plus Kit; Adds 150 m fiber ring and One-Click cleaner	4,695.00
FS200-100-PRO-P1-W1	PRO Kit; Adds FOCIS Flex, 150 m fiber ring and One-Click cleaner	6,425.00
FS200-100-BIPM-P1-W1	Complete Kit; Adds OFI-BIPM, FOCIS Flex, 150 m fiber ring and One-Click cleaner	8,295.00

### FS200-300 KITS (1310/1550 OTDR, OLS/OPM, VFL) / FS200-304 KITS (1310/1550/1650 NM PON OTDR, OLS/OPM, VFL)

FS200-300/304 Kits are available with a variety of options. All kits include carry case, USB cable and TRM 3.0 Test Results Management software (Basic or Advanced, depending on kit). Kits can also include Fiber Rings, OLS/OPM, OFI-BI/BIPM, FOCIS Flex connector inspection probe and tips.

Please contact your FIS Sales Associate for kit part numbers and pricing.

PART #	DESCRIPTION	PRICE
FS200-300-BAS-P1-W1	FS200-300 Basic Kit, 1310/1550 OTDR, OLS/OPM, VFL, BT/WiFi, TRM 3.0 Basic (37/36dB)	\$5,395.00
FS200-300-PLUS-P1-W1	Adds 150 m SMF fiber ring, One-click cleaner and TRM 3.0 Advanced to BASIC Kit	5,595.00
FS200-300-PRO-P1-W1	Adds FOCIS Flex and two adapter tips to PLUS Kit	7,525.00
FS200-300-BIPM-P1-W1	Adds OFI-BIPM to PRO Kit	9,195.00
FS200-300-MPO-P1-W1	Basic Kit plus MPO Switch, 150 m SMF fiber ring, 30 m 12-fiber MPO fiber ring, 2.5 mm and MPO One-click cleaners and TRM 3.0 Advanced	10,995.00
FS200-304-BAS-P1-W1	FS300-304 Basic Kit, 1310/1550/1650 PON OTDR, OLS/OPM, VFL, BT/WiFi, TRM 3.0 Basic (37/36/37dB)	7,195.00
FS200-304-PLUS-P1-W1	Adds 150 m SMF fiber ring, One-click cleaner and TRM 3.0 Advanced to BASIC Kit	7,395.00
FS200-304-PRO-P1-W1	Adds FOCIS Flex and two adapter tips to PLUS Kit	9,325.00
FS200-304-BIPM-P1-W1	Adds OFI-BIPM to PRO Kit	10,995.00
FS200-304-MPO-P1-W1	Basic Kit plus MPO Switch, 150 m SMF fiber ring, 30 m 12-fiber MPO fiber ring, 2.5 mm and MPO One-click cleaners and TRM 3.0 Advanced	12,795.00

### ACCESSORIES FOR FLEXSCAN OTDRS

PART #	DESCRIPTION	PRICE
2900-50-0002MR	FC adapter, OTDR/OLS port	\$60.00
2900-50-0003MR	SC adapter, OTDR/OLS port	60.00
2900-50-0004MR	ST adapter, OTDR/OLS port	60.00
2900-50-0006MR	LC adapter, OTDR/OLS port	94.00
2900-52-0001MR	FC adapter, OPM port	56.00
2900-52-0002MR	SC adapter, OPM port	56.00
2900-52-0003MR	ST adapter, OPM port	56.00
2900-52-0004MR	LC adapter, OPM port	67.00
2900-52-0005MR	2.5 mm adapter, OPM port	56.00
2900-52-0006MR	1.25 mm adapter, OPM port	56.00
2900-53-0001MR	2.5 mm adapter, VFL port	56.00
2900-53-0002MR	1.25 mm adapter, VFL port	56.00
8800-00-0072PR	Dust cap for UCI outputs	5.00



## FLEXSCAN® FS300 QUAD OTDRS WITH SMARTAUTO® & LINKMAP®

**Performance-packed:** With SmartAuto multi-pulse acquisition, 37 dB dynamic range and best-in-class dead zones, FlexScan Quad OTDRs test multimode and single-mode networks – including FTTH PONs and POLANs up to 1:64 split ratio – while still detecting and measuring events <2 meters apart.

**User-friendly:** FlexScan OTDRs enable both expert and novice technicians to quickly, reliably and accurately detect, locate, identify and measure optical network components and faults. After applying industry-standard or user-set pass/fail criteria, the network is displayed using FlexScan's intuitive, icon-based LinkMap view. Results may be printed to PDF and stored internally or externally. FlexScan automates test setup, shortens test time and simplifies results interpretation, improving test efficiency and cost.

**Pocket-sized:** FlexScan OTDRs truly fit in your pocket, yet still deliver all-day battery operation plus a large, bright, indoor/outdoor, 5-inch 800x480 touchscreen display. With large touch controls, you'll never need a stylus.

**All-in-one test capability:** With optional connector inspection, integrated optical light source, power meter and VFL, FlexScan provides an all-in one solution, ensuring technicians have everything they need to locate and resolve optical network issues. Uploaded results may be viewed and professional reports may be generated using the included Windows-compatible TRM® 3.0 Test Results Manager software.

**Available in Convenient, Cost-saving Installation and Troubleshooting Kits:** Bundle FlexScan with choice of launch cable, FOCIS Flex connector inspection probe and tips, and/or AFL's universal optical fiber identifier (OFI).



FS300

### FEATURES

- Test MMF and SMF, point-to-point and PON
- SmartAuto detects closely spaced events without sacrificing range
- LinkMap icons clearly identify event type & pass/fail status
- Print-to-PDF plus internal & external data storage
- Best-in-class 20 m PON dead zone
- Integrated Source, Power Meter, Visual Fault Locator
- Bluetooth & Wi-Fi communications
- Tether-free connector inspection with FOCIS Flex/Duel
- Rugged, lightweight, handheld for field use

### APPLICATIONS

- OTDR and Insertion Loss test & reporting
- Fast, accurate P2P & PON verification & troubleshooting
- Locate faults exceeding industry or user pass/fail thresholds
- Visually pinpoint location of macro-bends or breaks

### FS300 KITS (850/1300 MM; 1310/1550 SM OTDR, WIFI, BLUETOOTH)

PART #	DESCRIPTION	PRICE
FS300-325-BAS-P0-W1	Basic kit with soft case, TRM 3.0 Basic, USB cable (37/36dB)	\$7,695.00
FS300-325-PLUS-P0-W1	PLUS kit adds 150 m SMF & MMF fiber rings, One-Click cleaner, TRM 3.0 Advanced	8,130.00
FS300-325-PRO-P0-W1	PRO kit adds FOCIS Flex, 2 adapter tips, 150 m SMF & MMF fiber rings, One-Click cleaner, TRM 3.0 Advanced	10,060.00

### FS300 KITS (850/1300 MM; 1310/1550 SM OTDR, OLS/OPM, WIFI, BLUETOOTH)

FS300-325-BAS-P1-W1	Basic kit with soft case, TRM 3.0 Basic, USB cable (29/29dB - 37/36dB)	\$8,195.00
FS300-325-PLUS-P1-W1	PLUS kit adds 150 m SMF & MMF fiber rings, One-Click cleaner, TRM 3.0 Advanced	8,630.00
FS300-325-PRO-P1-W1	PRO kit adds FOCIS Flex, 2 adapter tips, 150 m SMF & MMF fiber rings, One-Click cleaner, TRM 3.0 Advanced	10,560.00
FS300-325-BIPM-P1-W1	BIPM Complete kit adds OFI-BIPM fiber identifier with power meter, FOCIS Flex, 2 adapter tips, 150 m SMF & MMF fiber rings, One-Click cleaner, TRM 3.0 Advanced	12,230.00

### FLEXSCAN® TS100 FTTH PON TROUBLESHOOTER

AFL's FlexScan TS100 Optical Troubleshooter is an easy-to-use, all-in-one tool for detecting, identifying, locating, and resolving single-mode optical network issues. The TS100 has auto-configured settings to quickly measure received power, link length, loss, and ORL with the push of a button. The results are displayed using color-coded LinkMap® icons for easy analysis. The FlexScan TS100 automates testing, shortens test time, interprets results, and recommends corrective actions, improving efficiency of frontline technicians and reducing costs.

PART #	DESCRIPTION	PRICE
TS100-60-BAS-P1	Basic Kit Includes: TS100, soft case, TRM 3.0 Basic, USB cable a 1650 nm PON, Test to Splitter, Power Meter and WIFI Enabled	\$3,995.00
TS100-60-PLUS-P1	Plus Kit Includes: BAS kit plus 150 m Fiber Ring, One-Click Cleaner, TRM 3.0 Advanced, Test to Splitter, Power Meter and WIFI Enabled	4,195.00
TS100-60-PRO-P1	Pro Kit Includes: PLUS kit plus FOCIS Flex with 2 adapter tips, Test to Splitter, Power Meter and WIFI Enabled	6,135.00
TS100-70-BAS-P1	Basic Kit Includes: TS100, soft case, TRM 3.0 Basic, USB cable a 1650 nm Extended PON, Test through Splitter, Power Meter and WIFI Enabled	4,495.00
TS100-70-PLUS-P1	Plus Kit Includes: BAS kit plus 150 m Fiber Ring, One-Click Cleaner, TRM 3.0 Advanced, Test through Splitter, Power Meter and WIFI Enabled	4,695.00
TS100-70-PRO-P1	Pro Kit Includes: PLUS kit plus FOCIS Flex with 2 adapter tips, Test through Splitter, Power Meter and WIFI Enabled	6,635.00

\*Additional options available are: "P2"- Dual-wavelength Power Meter for GPON / Video / XG/XGS/10GEPON



TS100 FTTH PON Troubleshooter



TS100 PLUS KIT

TS100 PRO KIT



OFP2-100-M



DSX2-8000



MFTK1200



## OPTIFIBER® PRO SERIES OTDR

Fluke Networks' OptiFiber® Pro Series OTDRs make novices and experts faster. Automated trace analysis and setup supports applications including data centers, PON and outside plant. Advanced features include Manual Expert mode, pinch and zoom for in-depth trace analysis and SmartLoop for bi-directional testing. Supports Versiv copper and fiber loss certification modules.

### FEATURES

- Effectively test data center fiber with the least set-up and trace time
- Reduce network downtime by quickly and precisely identifying faults on singlemode or multimode fiber
- Accelerate fiber certification with trace times as short as two seconds in Quick Test mode

PART #	DESCRIPTION	PRICE
OFP2-100-M	OptiFiber Pro Multimode OTDR kit (850/1300nm) (28/30dB)	\$8,893.00
OFP2-100-MI	OptiFiber Pro Multimode OTDR kit with inspection kit	12,003.00
OFP2-100-Q	OptiFiber Pro Quad OTDR kit (850/1300/1310/1550nm) (28/30/32/30dB)	13,703.00
OFP2-100-S	OptiFiber Pro Singlemode OTDR kit (1310/1550nm)(32/30dB)	10,271.00
OFP2-200-SI	OptiFiber HDR OTDR w/Inspection Kit & Wi-Fi (1310/1550nm)(42/41dB)	13,289.00
OFP-SM	OptiFiber Pro Singlemode OTDR Module (1310/1550nm)(32/30dB)	7,995.00
OFP-Q-ADD	OptiFiber Pro Quad Add On Kit (1310/1550nm)(32/30dB)	11,858.00

## CERTIFIBER® PRO OLTS

The CertiFiber® Pro Optical Loss Test Set (OLTS) helps cabling professionals accomplish more than ever. It's all about accurate, error-free certification, making jobs easier to manage and certifying fiber optic cabling to industry standards, faster. CertiFiber Pro OLTS complies with all applicable cabling standards, which call out the new Encircled Flux launch condition requirements for optical sources.

### FEATURES

- Versiv enables users to accomplish more than ever with a cable tester, accelerating every step of the testing process
- Taptive user interface puts advanced data analysis, easy set-up and operation at the fingertips of technicians

PART #	DESCRIPTION	PRICE
CFP2-100-M	CertiFiber Pro Multimode OLTS V2, w/WIFI	9,038.00
CFP2-100-Q	CertiFiber Pro Quad OLTS V2, w/WIFI	14,241.00
CFP2-100-S	CertiFiber Pro Singlemode OLTS V2, w/WIFI	10,684.00
CFP2-100-QI	CertiFiber Pro Quad OLTS V2, w/Double Ended Inspection & WIFI	18,334.00
CFP-MM-ADD	CertiFiber Pro MM Modules Add On Kit	6,074.00
CFP-SM-ADD	CertiFiber Pro SM Modules Add On Kit	7,715.00
CFP-Q-ADD	CertiFiber Pro Quad Add On Kit	11,277.00

## DSX CABLE ANALYZER

The DSX CableAnalyzer Series from Fluke Networks is the testing platform for today - and tomorrow. This revolutionary new future-proof platform significantly reduces total time to certify by improving every aspect of the testing process. The AC Wiremap feature validates twisted-pair cabling for Power over Ethernet services in accordance with TIA/EIA standards, even if a midspan power supply is used.

### FEATURES

- Unmatched speed for Cat 5e, 6, 6a, 8, Class Fa, I/II and all current standards.
- Enables testing and certification of twisted pair cabling for up to 40 Gigabit Ethernet deployments

PART #	DESCRIPTION	PRICE
DSX2-8000	A complete copper certification kit for cabling contractors testing Cat 8 and below channel and permanent links	\$15,542.00
DSX2-8000MI	2GHZ DSX Cable Analyzer V2, w/ Wi-Fi	20,615.00
DSX2-8000-PRO	2GHZ DSX Multimode OLTS INSPC V2, w/ Wi-Fi	63,802.00
DSX2-8000QI	2GHZ DSX QUAD OLTS INSPC V2, w/ Wi-Fi	25,822.00
DSX2-8000QOI	2GHZ DSX QUAD OTDR OLTS INSPC V2, w/ Wi-Fi	37,679.00
DSX2-5000	1 GHZ DSX Cable Analyzer V2, w/WIFI	12,864.00
DSX2-ADD-R	1 GHZ DSX-5000 Cable Analyzer Modules Add On Kit w/V2 Remote	11,970.00

## MULTIFIBER™ PRO OPTICAL POWER METER AND TEST KITS (MPO)

Introducing the MultiFiber™ Pro Optical Power Meter and Fiber Test Kits. MultiFiber Pro is the only fiber tester that tests MPO fiber trunks without the use of fan-out cords, eliminates the complexity of polarity issues and makes cassette testing in the field much easier.

### FEATURES

- Automatic scanning and testing of all fibers in MPO connectors
- Ensures correct end-to-end connectivity of MPO connectors with built-in polarity verification
- On-board MPO connector so no fan-out cords are required when testing fiber trunks
- Easy to interpret test results with a simple user interface that displays all 12 fibers

PART #	DESCRIPTION	PRICE
MFTK1200	MPO Testing Base Kit includes: MultiFiber Pro Power Meter, 850 Light Source, Test Cords, MPO adapters and carrying case	\$13,235.00
MFTK-MM850-SM1310	MULTIFIBER Pro Kit with 850/1310 nm PMLS	23,638.00
MFTK-SM1310-SM1550	MULTIFIBER Pro Kit with 1310/1550 nm PMLS	27,522.00



TREND Networks specializes in user-friendly solutions which help technicians across the globe to install and test networks, data cable, Ethernet, CCTV installations, PROFINET, PoE and more.

The all new LanTEK IV-S is a flagship mainframe certification system that utilizes application specific modules based on the user's requirements. For extra versatility in fiber optic testing the FiberTEK IV modules can be used with the LanTEK IV-S mainframes giving the user an all encompassing fiber and copper certification system.

**TREND NETWORKS LANTEK IV-S AND FIBERTEK IV (CABLE CERTIFIER)**

The LanTEK IV-S is a new Cable Certification System that brings a new standard to the industry, making the job faster, easier and more profitable. The FiberTEK IV is the optical equivalent to the LanTEK IV-S and can be used in the same mainframe. The FiberTEK IV performs fast and simple Tier 1 certification of high bandwidth single-mode and multimode fiber optic cabling including support for encircled flux testing.

PART #	DESCRIPTION	PRICE
LT4-500S	LanTEK IV-S 500MHz Cable Certifier with 1YR Sapphire Care Plan. TIA Category 6A/ ISO Class EA	\$11,130.00
LT4-3000S	LanTEK IV-S 3000MHz Cable Certifier with 1YR Sapphire Care Plan. TIA Category 8/ ISO Class I/II	\$12,530.00
LT4-500FS	LanTEK IV-S 500MHz with 1YR Sapphire Care Plan and FiberTEK IV-MM LED & SM Kit. Two multimode and two single-mode FiberTEK IV modules	\$20,830.00
LT4-3000FS	LanTEK IV-S 3000MHz with 1YR Sapphire Care Plan and FiberTEK IV-MM LED & SM Kit. Two multimode and two single-mode FiberTEK IV modules	\$21,830.00
LT4-500FOS	LanTEK IV-S 500MHz with 1YR Sapphire Care Plan and FiberTEK IV-MM LED & SM Laser Kit. Two multimode FiberTEK IV modules and two single-mode FiberTEK IV modules. FiberMASTER Quad OTDR, Video Inspection Probe and 1YR Fiber Sapphire Care Plan.	\$26,500.00
LT4-3000FOS	LanTEK IV-S 3000MHz with 1YR Sapphire Care Plan and FiberTEK IV-MM LED & SM Laser Kit. Two multimode FiberTEK IV modules and two single-mode FiberTEK IV modules. FiberMASTER Quad OTDR, Video Inspection Probe and 1YR Fiber Sapphire Care Plan.	\$27,500.00



LanTek IV-S and FiberTek IV



SignalTek 10G

**TREND NETWORKS SIGNALTEK 10G (ETHERNET TESTER)**

The new SignalTEK 10G measures the maximum bandwidth of the network cabling up to 10 Gigabits per second. By simulating actual network traffic users can test, troubleshoot and document network and data cable performance per IEEE Multi Gig and 10Gig standards.

PART #	DESCRIPTION	PRICE
R157002	SignalTEK 10G NT – with Network Testing	\$4,720.00
R157003	SignalTEK 10G PRO – with Fiber and Network Testing	\$6,500.00



NaviTEK NT

**TREND NETWORKS NAVITEK NT (NETWORK TESTER)**

The NaviTEK NT is a network tester for troubleshooting and maintenance of active and passive copper and fiber networks. Incorporating an improved graphical interface NaviTEK NT allows network technicians to pinpoint and solve network connectivity issues faster than ever before. Subsequently, tests can be saved as pdf reports and shared with colleagues and clients using the free TREND AnyWare™ app.

PART #	DESCRIPTION	PRICE
R151006	NAVITEK NT PRO – with Fiber and Network Testing	\$1,570.00



**TREND NETWORKS FIBERMASTER SERIES (FIBER CERTIFIER)**

The FiberMASTER OTDRs feature both high dynamic range and small dead zones providing the precision required for installation and troubleshooting alike. The software simplifies certification of cabling to meet TIA/ISO/IEC/IEEE requirements with simple pass/fail results. Additionally custom test parameters are easily set to accommodate any application.

PART #	DESCRIPTION	PRICE
R240-QIP	FiberMASTER Quad OTDR (850/1300/1310/1550)	\$4,490.00
R240-VIP	FiberMASTER Video Inspection Probe	\$1,095.00
R240-PMLS	FiberMASTER Multimode/Single-Mode Power Meter & Quad Light Source Kit	\$3,370.00
FMQ-OTDR-KIT	FiberMASTER Quad OTDR, Video Probe, Accessories and 1 YR Sapphire Care Plan	\$7,180.00



FiberMASTER Series

**TREND NETWORKS SECURITEST IP (COAX TESTER)**

SecuriTEST IP is an installation and troubleshooting tester for digital/IP, HD coax and analog CCTV camera systems. With a single tester that can power, configure and document, SecuriTEST IP increases productivity from start to finish. Supply power to cameras via PoE/PoE+ (Power over Ethernet) or standard 12V DC power using its internal Li-Ion battery, eliminating the need for external power adapters and injectors.

PART #	DESCRIPTION	PRICE
R171000	SecuriTEST IP Digital/Analog/HD Coax CCTV Tester	\$760.00



SecuriTEST IP

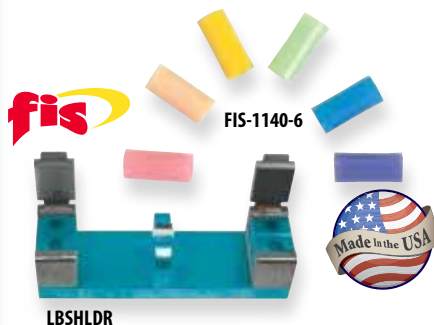

## ELASTOMERIC LAB SPLICE

The improved FIS Elastomeric Lab Splice is ideal for making temporary fiber connections and can be reused hundreds of times. To use the splice for instrument testing, simply insert a cleaved pigtail from OTDR or Power Meter and the cleaved unconnectorized fiber to be tested. Excellent for both Multimode and Singlemode fiber, the splice accepts fiber cladding diameters of 125µm to 140µm. The Lab Splices are supplied in blister packs of 6 (containing one of each color: pink, peach, yellow, green, blue and purple) or 12 (containing 2 of each color.)

PART #	DESCRIPTION	PRICE
FIS-1140-6	Pack of 6	\$9.95
FIS-1140-12	Pack of 12	16.95
LBSHLDR	Lab Splice Holder	200.00

FIBERCONNECT1-USC



## ANRITSU OTDR BARE FIBER PIGTAIL KIT

Save time by testing optical fibers without connectorizing. Easy-to-use, only a single drop of index matching oil is required. Strip, clean and cleave the fiber then insert into the unit until the end face meets the permanently mounted fiber. Specs: Choice of ST, SC or FC style connectors, Insertion Loss 0.6dB, Typical # of insertions: 2000.

**Kit Includes:** FiberConnect, Manual, Index Matching Oil, Maintenance Kit, Cleaning Brush, Magnetic Stand, Carry Case and Spare Pigtail.

PART #	DESCRIPTION	PRICE
FIBERCONNECT1-USC	FiberConnect Kit with SC/UPC pigtail	\$1,600.00
FIBERCONNECT1-UST	FiberConnect Kit with ST/UPC pigtail	1,600.00
FIBERCONNECT1-UFC	FiberConnect Kit with FC/UPC pigtail	1,600.00

**\*Excellent For Pre-Installation Reel Testing**



## DIVOT BARE FIBER TESTING DEVICE

The Divot™ is a faster system that uses index matching gel in disposable cartridges to allow for low loss connections and is much more forgiving of the quality of the cleaved fiber end. Each cartridge typically yields 500 insertions - 2 cartridges are included with the kit. Replacement cartridges can be purchased in packs of 3 or 12.

PART #	DESCRIPTION	PRICE
DVT-SMB3	Divot™ Bare Fiber Testing Device - SC 9µm Singlemode, 62.5µm and 50µm Multimode	\$395.00
DVT-RC3	Divot™ Replacement OCC Cartridge 3 pk	65.00
DVT-RC12	Divot™ Replacement OCC Cartridge 12 pk	250.00

F1-MM6250



## FIS MULTIMODE MANDRELS

The use of mandrels in multimode insertion loss testing helps to ensure the proper launch condition into the fiber under test. By wrapping the fiber around the correct size mandrel, high order modes are stripped out and low order modes are spread out to achieve the desired launch conditions for testing. Each includes the mandrel and clip for holding the cable firmly in place during testing. Accepts jacket diameters from 1.6mm to 3.0mm and for use with both OM1, OM2 cable. When testing Corning ClearCurve fiber it requires a smaller 4mm radius mandrel which is available.

PART #	DESCRIPTION	PRICE
F1-MM6250	62.5/125µm and 50/125µm Mandrel Kit	\$29.00
F1-CCM04	4mm ClearCurve Mandrel (1.6 -2.0mm jacket recommended)	29.00

F1-CCM04



F1-85UNIV



## FIS UNIVERSAL TESTING SLEEVE

Designed specifically for testing applications, the FIS Universal Testing Sleeve reduces labor time while testing fiber optic patch cables with standard for 2.5mm ferrules. Adapters for ST or FC reference cord are available.

PART #	DESCRIPTION	PRICE
F1-81UNIV	FIS ST to 2.5mm Universal Test Adapter	\$25.00
F1-85UNIV	FIS FC to 2.5mm Universal Test Adapter	25.00

F1-81UNIV

## FIS GOLD TIPPED PIGTAIL

Plating gold onto a ferrule end creates a high back reflection characteristic at 1310nm and 1550nm when it is connected to a 1 meter length of singlemode fiber. The opposite end is connectorized with your choice of ST, FC, or SC style connector. APC SC and FC are also available.

PART #	DESCRIPTION	PRICE
F1-1080-ST	1 Meter ST/UPC Pigtail with Gold Tipped Ferrule	\$50.00
F1-1080-FC	1 Meter FC/UPC Pigtail with Gold Tipped Ferrule	50.00
F1-1080-SC	1 Meter SC/UPC Pigtail with Gold Tipped Ferrule	50.00
F1-1080-SCAPC	1 Meter SC/APC Pigtail with Gold Tipped Ferrule	55.00
F1-1080-FCAPC	1 Meter FC/APC Pigtail with Gold Tipped Ferrule	55.00

F1-1080-ST

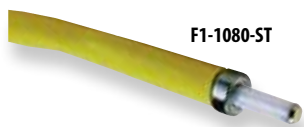

## BUILD YOUR CUSTOM FIBER LAUNCH/PULSE OR TEST BOX

Use this chart to build the launch box you need to your exact specifications.



BOX PURPOSE	STYLE	FIBER TYPE (CORE/CLAD)	FIBER LENGTH (IN METERS)	INTERFACE	CONNECTORS SIDE A - SIDE B
PS	7	3	2000	P	YU-YA
PS= Fiber Launch Box TB= Test Box Test box includes 1 or more events, must specify distance between events	1= #1 4= #4 7= #7 9=#9 10=#10	1= 50/125µm - OM2 2= 62.5/125µm - OM1 3= 9/125µm - OS2 4= Other 8= BI 10G 50/125µm - OM3 9= ClearCurve® SM ZBL 10= BI 10G 50/125µm - OM4 12= 50µm10Gig - OMS		(except box 1) P= Pigtailed - 1mtr R= Ruggedized Pigtailed - 1mtr	7U= FC/UPC 7A= FC/APC 8 = ST/PC LU= LC/UPC LA= LC/APC MU= MU/UPC YU= SC/UPC YA= SC/APC O= Other MT= MTP w/pins

### Part # Example: PS-7-3-2000-P-YU/YA

Translates to: Fiber Launch Box (Style 7) in a 8" x 6" x 4" box with 2000 meters of Singlemode 9/125µm fiber with (1) SC/UPC, (1) SC/APC Pigtail Interface and Connector SC/UPC-SC/APC



**STYLE #1**  
Dimensions: 5" Diameter  
Fiber Capacity: 150 mtrs  
(Pulse suppresser only)



**STYLE #9-Launch Pod**  
Dimensions: 5.5" x 4" x 2.5"  
Fiber Capacity: 250 mtr  
(Pulse suppresser only)



**STYLE #10-Launch Pod Plus**  
Dimensions: 6" x 4.5" x 2.5"  
Fiber Capacity: 750 mtr  
(Pulse suppresser only)



**STYLE #7**  
Dimensions: 8" x 6" x 4"  
Fiber Capacity: 2200 mtr  
Test Box: 1 Event - 750 mtr, 2 Events - 600 mtr, 3 Events - 400 mtr



**STYLE #4**  
Dimensions: 14.2" x 11.4" x 6.5"  
Fiber Capacity: 5,000 mtrs  
Test Box:  
1 Event - 5,000 mtrs,  
2 Events - 4,500 mtrs,  
3 Events - 4,000 mtrs

### FIS LAUNCH BOX PART NUMBER/PRICE EXAMPLES

PART #	DESCRIPTION	PRICE
PS-1-3-100-P-YU-YU	Launch Disc, Style #1, 100mtr Singlemode, SMF28 Ultra, 1.5mtr Pigtailed, SC/UPC Connectors Both Ends	\$120.00
PS-1-2-100-P-8U-YU	Launch Disc, Style #1, 100mtr Multimode OM1, Infinicor300, 1.5mtr Pigtailed, ST/UPC - SC/UPC	148.00
PS-10-3-750-R-YU-YU	Launch Box, Style #10, 750mtr Singlemode, SMF28 Ultra, 1mtr Ruggedized Leads, SC/UPC - SC/UPC	225.00
PS-10-3-500-R-YU-YU	Launch Box, Style #10, 500mtr Singlemode, SMF28 Ultra, 1.5mtr Pigtailed, SC/UPC - SC/UPC	195.00
PS-9-3-150-R-YU-YU	Launch Box, Style #9, 150mtr Singlemode, SMF28 Ultra, 1mtr Ruggedized Leads, SC/UPC - SC/UPC	165.00
PS-9-8-100-R-YU-YU	Launch Box, Style #9, 100mtr Multimode OM3 ClearCurve, 1mtr Ruggedized Leads, SC/UPC - SC/UPC	160.00

For Test Box\*When ordering Test Boxes, please specify type and location of up to 3 events. Each additional event cost \$30.00. Call for Pricing of Test Box.

### FIS OTDR FIBER OPTIC LAUNCH & RECEIVE KIT

This convenient test kit stores the essentials for technician who is testing fiber for troubleshooting or certification purposes. Recognizing fiber optic connectors are classified as consumables rated with approximately 500 matings, utilizing fiber launch cables extends the life of the OTDR test port avoiding downtime and additional expense of repair. Swap out fiber lengths, connector types or replace the fiber launch cartridge all together from its temporary position secured with a heavy duty Velcro strap. **Kit Includes:** 2.5mm connector endface cleaner, 1.25mm connector endface cleaner, cleaning solvent pen, cleaning reference card, fiber launch cartridge with armored pigtailed, compact nylon soft case (9" x 5" x 1.75") with carabiner clip.

PART #	DESCRIPTION	PRICE
LK59100PYALU	FIS OTDR Fiber Launch Kit includes 100 meter SM Fiber SC/APC-LC/UPC	\$295.00
LK59100PYULU	FIS OTDR Fiber Launch Kit includes 100 meter SM Fiber SC/UPC-LC/UPC	295.00
LK59100YAYA	FIS OTDR Fiber Launch Kit includes 100 meter SM Fiber SC/APC-SC/APC	225.00
LK59100YUYU	FIS OTDR Fiber Launch Kit includes 100 meter SM Fiber SC/UPC-SC/UPC	225.00
LK5950PYALU	FIS OTDR Fiber Launch Kit includes 50 meter SM Fiber SC/APC-LC/UPC	295.00
LK5950PYULU	FIS OTDR Fiber Launch Kit includes 50 meter SM Fiber SC/UPC-LC/UPC	295.00
LK5950YUYU	FIS OTDR Fiber Launch Kit includes 50 meter SM Fiber SC/UPC-SC/UPC	225.00

\*Other Connector Styles, Fiber Types, Fiber Lengths And Accessories Available In Test Kits - Contact FIS Sales Representative For Designated Part Number And Pricing

### FIS MPO 100 METER LAUNCH BOX

Made with ribbon fiber - This allows you to OTDR test MPO cables. Plug MPO cable into provided MPO adapter port. Use standard launch reel from OTDR to plug into one of the twelve provided standard connector adapters.

PART #	DESCRIPTION	PRICE
PS48100BMT/LC	Launch Box Style #4, 100m, Multimode OM3, MPO Male to LC/UPC	\$675.00
PS48100BMT/SC	Launch Box Style #4, 100m, Multimode OM3, MPO Male to SC/UPC	675.00
PS49100BMT/SC	Launch Box Style #4, 100m, Singlemode, SMF28 Ultra, MPO Male to SC/UPC	675.00
PS49100BMT/SCA	Launch Box Style #4, 100m, Singlemode, SMF28 Ultra, MPO Male to SC/APC	725.00
PS49100BMT/LC	Launch Box Style #4, 100m, Singlemode, SMF28 Ultra, MPO Male to LC/UPC	675.00
PS49100BMT/LCA	Launch Box Style #4, 100m, Singlemode, SMF28 Ultra, MPO Male to LC/APC	725.00



LK59100YUYU



PS48100BMT/LC

## DID YOU KNOW... FIBER IDENTIFIERS



A Fiber Identifier allows you to see if a fiber is active without having to disconnect it from the network. They accomplish this by clamping onto a fiber mid-span and inducing a small macro bend. The Fiber Identifier can detect the small amount of light leaking through the macro bend to determine activity. Most units can also determine the direction of the traffic over the fiber link. Fiber Identifiers can also detect and identify specific modulated frequencies.

Fiber Identifiers are typically designed to work with 250µm coated, 900µm buffer, 2mm jacket and 3mm jacketed fibers. Ribbon Fiber versions are also available. Several higher end models are also capable of measuring the strength of the optical signal traveling down the fiber and displaying it on the unit.

## TYPICAL APPLICATION

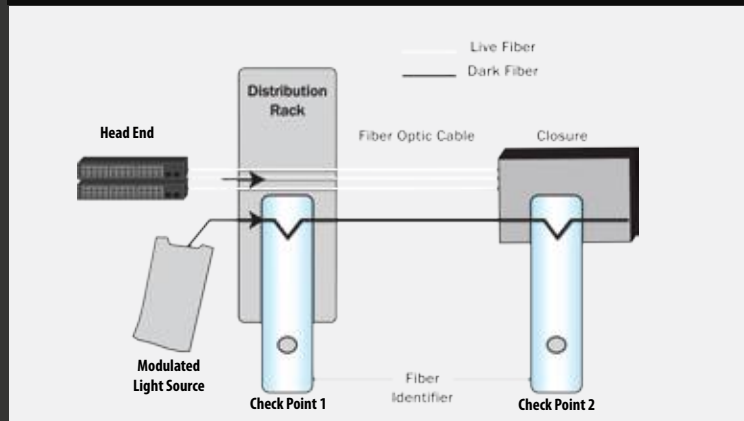

### EXFO LIVE FIBER IDENTIFIER AND TONE GENERATOR

The EXFO Fiber Finder can identify traffic, direction and tone detection on both active and dark fibers. With less than 1dB of induced loss, a live fiber can quickly be located and the power measured while minimizing network access time and the possibility for errors. The TG-300 is a non-intrusive, non-disruptive tone generator. Because of the low 0.2dB typical loss, they can be used on live fibers. The Fiber Finder and Toner work on all wavelengths and fiber types. One headpiece works on 900µm, 1.6mm and 3mm jackets and tones of 270Hz, 1kHz and 2kHz. The TK-FF kit includes both the Fiber Finder and Toner along with a case, AC adapter and 4 AA batteries per unit.

PART #	DESCRIPTION	PRICE
LFD-300B	Live Fiber Identifier	\$3,380.00
TG-300B	EXFO Fiber Tone Generator	4,060.00
TK-FF	Fiber Identifier Kit – LFD-300 plus TG-300	6,765.00



### VIAMI FI-60 LIVE FIBER IDENTIFIER

Live Fiber Identifier easily identifies the optical signal without having to disconnect the fiber or disrupt network traffic. Also converts to an Optical Power Meter (OPM).

The Viavi FI-60 LFI enables users to easily detect the optical signal without disconnecting fiber or disrupting network traffic. The FI-60 LFI also includes the unique Viavi SafeChek™ system, which ensures safe and repeatable engagement with most fiber types without the hassle of changing out costly dies. The FI-60 also converts to an Optical Power Meter (OPM), providing twice the value for your investment and reducing the number of tools carried on the job.

#### FEATURES

- Avoid network downtime and damage with repeatable SafeChek™ easy-pull trigger system.
- Get the job done faster with a single LFI head that is compatible with multiple cable diameters (250µm to 3mm jacketed fibers).
- Have twice the tool at half the price! The FI-60 LFI easily converts to a full-function OPM that stores, recalls, and exports results to a PC via USB.

**Each Unit Includes:** Live Fiber Identifier with removable LFI attachment, 2.5 mm and 1.25mm OPM connector interfaces; USB cable; software; carrying case.

PART #	DESCRIPTION	PRICE
FI-60	Live Fiber Identifier with removable LFI attachment, 2.5 mm and 1.25mm OPM connector interfaces, USB cable, software, carrying case	\$905.00



### FITEL FIBER IDENTIFIER

When you are doing maintenance on a network that can't be shut down for testing, reach for the Fitel Fiber Identifier. This device places a macro bend in the fiber that enables you to identify transmission direction, fiber path and relative core power on live optical fibers. A universal fiber optic adapter head accepts coated, ribbon or jacketed fiber optic cables. LED display and audible tone indicator.

**Each Unit Includes:** Battery, Strap and Manual

PART #	DESCRIPTION	PRICE
F1-IDH	Fitel Lightfinder ID-H Fiber Identifier with Universal Head	\$1,320.00



## WILCOM FIBER IDENTIFIER

Wilcom's Optical Fiber Identifiers are rugged metal units with the best sensitivity detection on the market today. They operate by inducing a macrobend on the fiber, and can be used for singlemode and multimode applications. Certain Wilcom models allow Relative Core Power measurements to be displayed. The unit can also detect the presence of 2kHz, 1kHz or 270Hz modulated tones. The optical head accepts a 3mm, 250µm /Ribbon or 900µm fibers.

**Each Unit Includes:** 9V Alkaline Battery, Carry Case and Interchangeable Heads for 3mm, 900µm, 250µm Fibers.

PART #	DESCRIPTION	PRICE
F6121A	Fiber Identifier	\$1,280.00
F6222	Fiber Identifier with Core Power and Digital Display	1,600.00
F6222C	CATV Fiber Identifier	1,590.00
F6121R	Ribbon Fiber Identifier	1,862.00
044-197731	3mm Adapter Head	65.00
044-1996501	2mm Adapter Head	65.00
044-20715011	1.6mm Adapter Head	65.00



## AFL OFI-BIPME OPTICAL FIBER IDENTIFIERS

AFL's OFI-BIPME optical fiber identifier is an easy-to-use tool that determines if a fiber is live, the transmission direction, and the relative core power on standard and bend-insensitive single-mode and multimode fibers. Its positive stop plunger mechanism provides the right pressure to ensure proper detection while keeping loss to a minimum. The design ensures traffic will not be interrupted and fibers will not be damaged.

The OFI-BIPME fiber identifier eliminates the need to access the optical fiber at a connection or splice point eliminating the possibility of interrupting service to a valued customer. It provides an integrated optical power meter for verification of power levels during installation or troubleshooting activities. The universal head of this OFI eliminates the need to change adapter heads for jacketed, coated or ribbon fibers, making them extremely easy to use in the field. The touchscreen features provide simple to follow setup and clear to read results. The OFI-BIPME Optical Fiber Identifier is warranted against defective material and workmanship for a period of one year from the date of delivery to the end user.

### FEATURES

- World class signal detection sensitivity
- Trigger lock, positive stop for optimum detection
- Integrated optical power meter option
- 2.4" color touchscreen with backlight

### APPLICATIONS

- Maintenance of fiber optic networks
- Troubleshooting network issues
- Identification of live fibers or trace fibers
- Power level verification

**Each Unit Includes:** 9V Alkaline Battery, Carry Case and Fiber Identifier.

PART #	DESCRIPTION	PRICE
OFI-BIPME	BI Optical Fiber Identifier with integrated Optical Power Meter. The kit includes one 2.5 mm Universal Power Meter Port Adapter, BIPM-00-25.	\$1,795.00



## OPTIONAL OFI-BIPME ADAPTERS (ORDERED SEPARATELY)

PART #	DESCRIPTION	PRICE
BIPME-00-25	OFI-BIPME 2.5 mm Universal Power Meter Port Adapter	\$165.00
BIPME-00-SC	OFI-BIPME SC Power Meter Port Adapter	165.00
BIPME-00-FC	OFI-BIPME FC Power Meter Port Adapter	165.00
BIPME-00-ST	OFI-BIPME ST Power Meter Port Adapter	165.00
BIPME-00-LC	OFI-BIPME LC Power Meter Port Adapter	165.00

## AFL OPTICAL FIBER IDENTIFIER

The AFL OFI 200D Optical Fiber Identifier is a low-cost, high-tech approach to non-invasive fiber optic signal detection. Using a low-insertion loss, macrobend-detection technique, it discriminates signals without disrupting service or overstressing fiber. By simply clamping an Optical Fiber Identifier onto a gently bent fiber, the unit will indicate if there is [No Signal], [Tone], or [Traffic] and identify signal direction. This is all done with no head swapping or adjustments for different types of fiber, 250µm, 900µm, 3mm jacketed cable and ribbon fiber.

PART #	DESCRIPTION	PRICE
OFI200D	Optical Fiber Identifier	\$950.00
OFI400	Optical Fiber Identifier for use with 250µm, 900µm, Ribbon, 2mm and 3mm Jacketed Optical Fibers	1,195.00



## FLUKE FIBERLERT™ LIVE FIBER DETECTOR

Quickly check fiber activity, polarity, and connectivity. No setup or interpretation required –just place in front of the fiber end face or port and a light and tone indicate an active fiber. This pocket-sized tool tests single-mode, multimode UPC and APC patch cords and ports using a "non-contact"/ non-contaminating detector.

### FEATURES

- Detects optical power in single-mode and multimode fiber wavelengths (near infrared range 850 to 1625 nm)
- No setup or interpretation needed –light and sound indicate presence of optical signal
- "Non-contact" detector reduce sthe risk of contamination and damage; suitable for ports and patch cords, SM, MM, UPC and APC connections
- LightBeat™ flashes to indicate operation and battery status; powers off after five minutes to preserve battery (2xAAA, included)

PART #	DESCRIPTION	PRICE
FIBERLERT-125	FiberLert, 850 NM TO 1625 NM LIVE FIBER DETECTOR (INCLUDED 2 AAA Alkaline batteries)	\$130.00





RUGGEDIZED LIGHT SOURCE



RUGGEDIZED POWER METER



## FIS RUGGEDIZED POWER METER AND LIGHT SOURCE

FIS Ruggedized Loss Test sets are designed to withstand outdoor field environments where traditional handheld units are not appropriate. Units are available for both multimode and singlemode applications and run on re-chargeable NiCd batteries. Please specify ST or FC adapter style when ordering any FIS Ruggedized Test Equipment. The Power Meter has an easy to read LCD display and germanium detector incorporating three wavelength (850nm, 1300nm, 1550nm) measurement capability. The Light Source is a dual wavelength source with a continuous wave or 2KHz modulation. The 850nm and 1300nm light source is for multimode applications. The 1310nm and 1550nm Light Source is for singlemode applications.

PART #	DESCRIPTION	PRICE
9086-0000	Ruggedized Light Source 850/1300nm with ST Adapter	\$575.00
9087-0000	Ruggedized Light Source 1310/1550nm with FC Adapter	895.00
9088-0000	Ruggedized Light Source 1490/1550nm with FC Adapter	1,250.00
F1-813RG	Ruggedized PM (0.01 Res) 850/1300nm LED Light Source (ST Interface)	1,250.00
F1-1315RG	Ruggedized PM (0.01 Res) 1310/1550nm Laser Light Source (FC Interface)	1,495.00
9080-0000	Ruggedized Power Meter with 2.5mm and 1.25mm Universal Adapter	600.00

## FIS POWER METER AND LIGHT SOURCE KIT

Purchase our hand held series power meter and light source kit. They come in either Singlemode, Multimode or Quad versions. Included are a carrying case, reference cords, mating sleeves needed for testing SC, ST and LC terminated cables, operating manuals and batteries. The Power Meters are supplied with universal 2.5mm and 1.25mm adapter caps. Other interchangeable adapters are available for purchase separately.

PART #	DESCRIPTION	PRICE
F1-813LR	Hand Held PM (0.01dB Resolution) 850/1300nm Dual LED LS (ST Interface)	\$725.00
F1-1315LR	Hand Held PM (0.01dB Resolution) 1310/1550nm Dual Laser LS (FC Interface)	850.00
F1-1835LR	Hand Held PM (0.01 Res), 850/1300nm and 1310/1550nm Light Sources (FC/SM, ST/MM Interface)	1,175.00
F1-1835LRVFL	Hand Held PM (0.01 Res), 850/1300nm and 1310/1550nm Light Sources and VFL	1,275.00
F1-1345LR	Hand Held PM (0.01 Res) 1310nm, 1490nm, 1550nm Laser Light Source (FC Interface)	1,375.00
F1-LRDLXCASE	Hard Case for 3 units (empty)	130.00

Custom Kit Configurations Always Available! Please Call Today!



Reference Cords & Mating Sleeves Now Included

F1-1315LR



## FIS POWER METER

A power meter is the essential tool for measuring optical power within a fiber optic link. The FIS Power Meter is a solid performer, with 0.01dB resolution. Standard FIS units test from +5dBm to -65dBm, and FIS CATV units test from +23dBm to -45dBm.

**Each Unit Includes:** Operating Manual, 9V Battery, 2.5mm and 1.25mm Adapters, and Carry Case.

Available AC Adapter

PART #	DESCRIPTION	PRICE
F1-8513HR	Hand Held Power Meter with 0.01dB Resolution	\$350.00
F1-8513HRCATV	CATV Hand Held Power Meter with 0.01dB Resolution	375.00
F1-8513HR-4	Power Meter with 1310/1490/1550nm with 0.01dB Resolution	375.00
F1-8513HRCATV-4	CATV 0.01dB Resolution Power Meter with 1310/1490/1550nm	425.00
F1-8513UM	2.5mm Universal Adapter (ST, FC, SC) (Polymer)	\$39.00
F1-8513SC	SC Adapter	49.00
F1-8513ST	ST Adapter	49.00
F1-8513FC	FC Adapter	49.00
F1-8513LCMUM	1.25mm Universal Adapter (Polymer)	39.00
F1-9103U	Universal 110/220v AC Power Supply Adapter	30.00

F1-8513HR



New Interchangeable Source Adapters



9050-0000



## FIS LIGHT SOURCE

The FIS Light Source is the perfect match for the FIS Power Meter. Singlemode units are equipped with lasers having a typical output power of -1.0dBm. Multimode units have LEDs with a minimum output of -17dBm.

**Each Unit Includes:** Operating Manual, 9V Battery and Carry Case.

PART #	DESCRIPTION	PRICE
9052-0000	Dual 850/1300nm LED Light Source with ST Adapter	\$375.00
9055-0000	Dual 1310/1550nm Laser Source with FC Adapter	375.00
9056-0000	Dual 1490/1550nm Laser Light Source with FC Adapter	575.00
9058-0000	Dual 1300nm LED/1310nm Laser Source (ST and FC)	375.00
9056-1625	Dual 1490/1625 Laser Source	975.00
F1-9103U	Universal 110/220v AC Power Supply Adapter	30.00
1136-0000	SC Interchangeable adapter for FIS light source	49.00
1137-0000	FC Interchangeable adapter for FIS light source	49.00
1138-0000	ST Interchangeable adapter for FIS light source	49.00

## FIS E-SERIES POWER METER AND LIGHT SOURCE KIT

The new FIS E-Series Power Meter and Light Sources are also available in kits. These kits come in either Singlemode, Multimode or Quad versions with carrying case and mating sleeves needed for testing SC, ST and LC terminated cables. Reference cords include (2) of each: SC/SC, SC/LC and SC/ST. Multimode and Quad Kits include OM1 and OM3 reference cords with 62.5µm and 50µm mandrels.

PART #	DESCRIPTION	PRICE
F1-8513KIT	Multimode Kit (Power Meter with 0.01dB Resolution and Multimode Light Source, Dual 850/1300nm)	\$550.00
F1-1315KIT	Singlemode Kit (Power Meter with 0.01dB Resolution and Singlemode Light Source, Dual 1310/1550nm)	550.00
F1-ESQUADKIT	SM/MM Kit (Power Meter, MM Light Source 850/1300nm/ SM Light Source 1310nm/1550nm)	750.00
F1-8513KITDS	Multimode Kit (Data Save Power Meter with 0.01dB Resolution and Multimode Light Source, Dual 850/1300nm)	595.00
F1-1315KITDS	Singlemode Kit (Data Save Power Meter with 0.01dB Resolution and Singlemode Light Source, Dual 1310/1550nm)	595.00
F1-ESQUADKITDS	SM/MM Kit (Data Save Power Meter, MM Light Source 850/1300nm/ SM Light Source 1310nm/1550nm)	795.00

## FIS E-SERIES FAMILY OF PRODUCTS

The FIS E-Series Family of Products provide an industry leading value for handheld test gear. With a new design for ease of use, LED backlight and referencing, technicians will have no problem testing and trouble shooting fiber optic links. Data Save version includes PC reporting software.

### FEATURES

- Light Sources (minimum output -7dBm)
- Continuous Wave (CW), 270Hz, 1kHz, or 2kHz Modulation
- Auto Shut Off and Low Battery Indicator
- Calibrated Wavelengths for Power Meter (850nm, 1300nm, 1310nm, 1490nm, 1550nm and 1625nm)
- Standard Range -70dBm to +6dBm Power Range
- CATV Range -45dBm to +23dBm)
- 60-Hour Typical Battery Life for Light Source
- 200-Hour Typical Battery Life for Power Meter
- Absolute Power Reference Display

**Each Unit Includes:** Operating Manual, (3) AA Batteries, interchangeable SC, FC, ST adapters; LC adapter for PM only and Carry Case.

PART #	DESCRIPTION	PRICE
F1-8513PM	Power Meter with 0.01dB Resolution	\$185.00
F1-8513PMVF	Power Meter with VFL and 0.01dB Resolution	295.00
F1-8513PMDATA	Power Meter with Data Storage (1,000 Files) and 0.01dB Resolution	295.00
F1-8513PMCATV	CATV Power Meter with 0.01dB Resolution	185.00

PART #	DESCRIPTION	PRICE
F1-8513LS	Multimode Light Source, Dual 850/1300nm	\$295.00
F1-1315LS	Singlemode Light Source, Dual 1310/1550nm	295.00
F1-QUADLS	FIS SM/MM Source, 850/1300/1310/1550	495.00

PART #	DESCRIPTION	PRICE
F1-FR15A	FIS Fiber Ranger (Fault Finder/Distance Verifier) - APC with VFL	\$795.00
F1-FR15U	FIS Fiber Ranger (Fault Finder/Distance Verifier) - UPC with VFL	795.00

PART #	DESCRIPTION	PRICE
F11314LSU	E-Series Triwave Source 1310/1490/1550 (UPC)	\$525.00
F11314LSA	E-Series Triwave Source 1310/1490/1550 (APC)	525.00
F11316LSU	E-Series Triwave Source 1310/1550/1625 (UPC)	695.00
F11316LSA	E-Series Triwave Source 1310/1550/1625 (APC)	695.00

## FIS FIBER OPTIC TALK SET

The FIS Fiber Optic Talk Set units are designed for transmitting voice in both directions on a single fiber using two different wavelengths. Works with SM or MM fiber. Units include adjustments for power and sensitivity. The Talk Set comes standard with SC and FC interchangeable adapter ports. These sets have a dynamic range up to 45dB. Finally, each Talk Set comes equipped with a stereo headset with boom microphone, providing comfort for long-term use and high performance.

**Talk Set includes:** (2) Units, (2) Headphones with Microphone, (6) AA Batteries

PART #	DESCRIPTION	PRICE
F1-9062TKS	FIS Singlemode/Multimode Talk Set (pair) w/ FC and SC Adapters	\$1,095.00 (pair)



**TEST SET KIT**  
F11315KIT  
\*Carrying Case not pictured



F1-FR15A

F1-8513PMDATA



F1-9062TKS



**EXFO MAXTESTER 945 TELCO OPTICAL LOSS TEST SET(OLTS)**

The first tablet-inspired multifunction optical loss test set (OLTS) measuring insertion loss (IL), optical return loss (ORL) and fiber length at two wavelengths in 5 seconds via fully automated bidirectional FasTest™ analysis. Two units (or modules) must be used in conjunction with each other on opposite ends of the cable under test.

**Each Unit Includes:** AC Charger, Rechargeable lithium-polymer, Case and Shoulder Strap.

PART #	DESCRIPTION	PRICE
MAX-945-SM1-XX	OLTS, IL, Length & ORL Measurement, SM 1310/1550nm, InGaAs detector, connector to be specified (Single Unit)	\$6,175.00
MAX-945-SM1-RF-VFL-XX	OLTS, IL, Length & ORL Measurement, SM 1310/1550nm, InGaAs detector, Wi-Fi/Bluetooth, VFL, connector to be specified (Single Unit)	6,895.00
MAX-945-SM3-XX	OLTS, IL, Length & ORL Measurement, SM 1310/1550/1625nm, InGaAs detector, connector to be specified (Single Unit)	8,080.00
MAX-945-SM3-RF-VFL-XX	OLTS, IL, Length & ORL Measurement, SM 1310/1550/1625nm, InGaAs detector, Wi-Fi/Bluetooth, VFL, connector to be specified (Single Unit)	8,800.00
MAX-945-SM4-XX	OLTS, IL, Length & ORL Measurement, SM 1310/1490/1550nm, InGaAs detector, connector to be specified (Single Unit)	7,565.00
MAX-945-SM4-RF-VFL-XX	OLTS, IL, Length & ORL Measurement, SM 1310/1490/1550nm, InGaAs detector, Wi-Fi/Bluetooth, VFL, connector to be specified (Single Unit)	8,285.00
MAX-945-iCERT-Q1-QUAD-XX	OLTS, IL, Length Measurement, ORL on SM port, Simplex cable test (on SM port) and Duplex cable test, Tier-1 Certification per international standards, EF compliant 50/125µm, Port 1 MM 850/1300nm, Port2 SM 1310/1550nm, InGaAs detector, connector to be specified (Single Unit)	8,040.00
MAX-945-iCERT-Q1-QUAD-RF-VFL-XX	OLTS, IL, Length Measurement, ORL on SM port, Simplex cable test (on SM port) and Duplex cable test, Tier-1 Certification per international standards, EF compliant 50/125µm, Port 1 MM 850/1300nm, Port2 SM 1310/1550nm, InGaAs detector, Wi-Fi/Bluetooth, VFL, connector to be specified (Single Unit)	8,760.00

Call For Configurator Connector Options (VFL or Video Probe). Can also be purchased as single units, but always must operate in pairs. XX - indicate adapter style upon purchase.

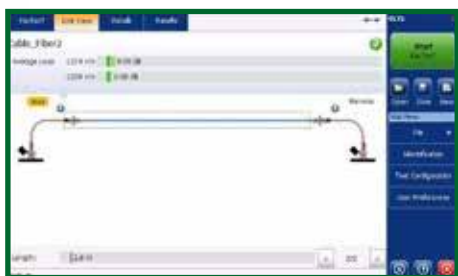

**EXFO OPTICAL POWER EXPERT**

State-of-the-art power meter with Bluetooth connectivity, a wide touchscreen and best-in-class optical performance in a pocket-sized form factor. Turns on instantly for use on the go and available in two configurations: PX1 and PX1-PRO. The PX1 includes 11 calibrated wavelengths. The PX1-PRO has an integrated visual fault locator, auto-wavelength recognition and switching, has 45 calibrated wavelengths and comes in a soft pouch. Both the PX1 and PX1-PRO are available with either standard InGaAs detector (10 to -70 dBm) or high-power InGaAs detector (26 to -50 dBm).

**FEATURES**

- Connect to smart app via Bluetooth: data reporting from the field, cloud storage, workflow management
- User-friendly: Compact, color touchscreen and intuitive interface
- Robust and rugged: IP54 design for dust and water protection
- Time-saving features: no offset nulling, lightning-fast boot-up
- Data storage
- Error-free, automated wavelength recognition and switching (on PRO)
- 3-year warranty and calibration interval
- Visual fault locator (on PRO)

PART #	DESCRIPTION	PRICE
PX1-S-XX	InGaAs detector, 11 Calibrated Wavelengths	\$705.00
PX1-H-XX	High-power InGaAs detector, 11 Calibrated Wavelengths	765.00
PX1-PRO-S-XX	InGaAs detector, VFL, 45 Calibrated Wavelengths organized in wavelength bundles, Auto wavelength recognition & switching, Soft pouch carry case	985.00
PX1-PRO-H-XX	High-power InGaAs detector, VFL, 45 Calibrated Wavelengths organized in wavelength bundles, Auto wavelength recognition & switching, Soft pouch carry case	1,035.00
FOAS-32	ST connector adapter for PX1 and PX1 Pro	50.00
FOAS-54	SC connector adapter for PX1 and PX1 Pro	50.00
FOAS-98	LC connector adapter for PX1 and PX1 Pro	50.00

Universal connector adapters and FC connector adapter also available. XX - indicate adapter style upon purchase.



EXFO OPTICAL POWER EXPERT



TPPM-XG

**AFL FLOWSCOUT™ PON OPTICAL POWER METER**

AFL's FlowScout PON Power Meter identifies, measures, and qualifies both downstream and upstream signal levels in FTtx PON networks. It is perfect for technicians responsible for activating and maintaining networks carrying a mix of GPON/EPON, video, and next gen PON (XG/XGS-PON, 10GEPON) wavelengths. Unlike competing through-mode PON Power Meters, AFL's FlowScout requires no setup. Technicians simply plug in the fiber under test to see results displayed in seconds on the large color touchscreen. Storage and reporting options are included to verify and document results from the field. FlowScout's rugged design makes it perfect for outside plant environments where it can be dropped, get dirty or even wet. And because it is so easy to use, FlowScout requires little, if any, training.

**FEATURES**

- Detect multiple wavelengths automatically - NO setup required!
- Detects GPON, XGS-PON, and Video signals all at once
- Rugged and water resistant, IP54 rating
- Field-swappable connector adapters
- Large color touchscreen display daylight viewable
- Rechargeable Li-Polymer battery

PART #	DESCRIPTION	PRICE
TPPM-XG-0900PR	FlowScout PON optical power meter XGPON/XGSPON	\$2,495.00
6000-00-0036PR	USB-A to USB-C Charge and Data Transfer Cable	25.00
4050-00-0034MR	AC Adapter	10.00
4050-00-0034NAMR	US power plug for AC charger	8.00
4050-00-0034EUMR	EU Power Plug for AC charger	8.00

## VIAVI T-BERD 4000V2 BI-FIBER COMPLETE (LOSS TEST SET)

FiberComplete™ is the first solution to fully automate all the fundamental fiber-qualification tests, such as bidirectional insertion loss (IL), optical return loss (ORL), and optical time domain reflectometry (OTDR), with one module from one optical port.

You can now equip each technician with a single piece of equipment that fulfills all of the traditional fiber testing requirements. The VIAVI 4100-Series FiberComplete module for the T-BERD/MTS-2000 V2, 4000 V2 and OneAdvisor 800 platforms offers the most complete fiber-testing solution for quick and easy use in characterizing point-to-point or point-to-multipoint passive-optical networks (PON).

### FEATURES

- 4.5 s measurement time for bi-directional IL/ORL and length at two wavelengths
- Full setup and data exchange between near end and far end units for fewer mistakes and retests
- Smart Link Mapper (SLM) icon-based map view of the fiber link
- Real-time continuity check and automatic product pairing (single strand and ribbon/MPO cables)
- Manage fiber and cable results
- Step-by-step wizard lets you reference initial IL/ORL tests
- Smart Access Anywhere (SAA) for remote control and field tech support
- StrataSync enabled for centralized cloud based asset, configuration, test data and workflow management

PART #	DESCRIPTION	PRICE
TB4FCOMP2B	Viavi T-BERD 4000v2 1310/1550nm Bi-Fiber Complete IL/ORL & OTDR (need to work in pair)	\$5,718.75

## AFL SMLP5-5 SM/MM LOSS TEST KIT

An essential tool for certifying Singlemode and Multimode fiber networks to industry standards. Included TRM™ PC Reporting Software is a powerful tool for analyzing test results, applying industry standards, and generation of comprehensive certification reports using supplied industry accepted templates.

AFL SMLP5-5 test kit is ideally suited for testing Singlemode and/or Multimode fiber optic networks and cables. The OPM5-2D and OLS4 offer long battery life from common AA alkaline batteries with external AC adapter available as an option. The SMLP5-5 test kit is fully N.I.S.T. traceable.

**Includes:** (1) OLS4 Optical Light Source, (1) OPM5-2D Optical Power Meter, AA Batteries, Protective Rubber Boots, Adapter Cap, USB Cable, Windows® Compatible Software User's Guide, 50µm And 62.5µm Mandrels, and Carry Case.

PART #	DESCRIPTION	PRICE
SMLP550909PR	AFL Quad Optical Loss Test Kit with FC Adapters	\$2,695.00
SMLP550902PR	AFL Quad Optical Loss Test Kit with LC Adapters	2,695.00
SMLP550907PR	AFL Quad Optical Loss Test Kit with SC Adapters	2,695.00
SMLP550908PR	AFL Quad Optical Loss Test Kit with ST Adapters	2,695.00

## EXFO PON POWER METER

The PPM-350D power meter is the first PON-aware™ power meter to automatically detect and test next-gen and legacy PON technologies: GPON, EPON, 10G-EPON, XG(S)-PON, NG-PON2 and RF overlay. Pass/Fail indicators for easy assessment of power values. The most easy-to-use instrument of its kind: simply connect the fiber and read the results.

**Includes:** Quick Reference Guide, USB Cable, Software, User Guide on CD, Wrist Strap, and Protective Cover for Optical Ports.

PART #	DESCRIPTION	PRICE
PPM-350D-SR-EA-EUI-91	PPM-350D Next-Gen PON Power Meter, SC/APC Connector Interface	\$2,705.00
PPM-350D-DR-VFL-EA-EUI-91	PPM-350D Next-Gen PON Power Meter, with VFL, SC/APC Connector Interface	4,590.00
PPM-350C - PPM-352C-XX	PON Power Meter, 2 Ports, Extended range - BPON, EPON, GPON   FTTX mode: 1310/1490/1550 nm	1,745.00
PPM-350C-VFL - PPM-350C-VFL-XX	PON Power Meter, 2 Ports, Extended range - BPON, EPON, GPON   FTTX mode: 1310/1490/1550 nm, Visual Fault Locator	2,115.00

## EXFO FIBERBASIX 50 SERIES POWER METER OR LIGHT SOURCE

The EPM-50 Power Meter allows power measurements up to 26 dBm with battery life of over 300 hours. It comes with a specific high power configuration for CATV and Telco markets. The ELS-50 Light Source offers the power stability and reliability necessary to perform loss measurement in Telco, CATV and FTTH applications using dual and triple wavelengths. Additional kits available.

**Each Unit Includes:** Soft pouch, PMA-22 FC connector adapter, LSA-89 FC connector adapter, quick reference sticker in five languages, Certificate of Calibration, Certificate of Compliance, and three AA batteries.

PART #	DESCRIPTION	PRICE
ELS5012CRBLSA89	Dual MM 850/1300nm Light Source with Rubber Boot, FC Adapter	\$690.00
ELS5023BLRBLSA89	Dual SM 1310/1550nm Light Source with Rubber Boot, FC Adapter	1,225.00
EPM53RBPMA22	Power Meter with InGaAs Detector, Rubber Boot, FC Adapter	415.00
EPM53RBPMA22	Power Meter with High Power In GaAs Detector, FC adapter	455.00
PMA-22	FC Connector adapter for EPM-50 Power Meter	28.00
PMA-32	ST Connector adapter for EPM-50 Power Meter	28.00
PMA-54	SC Connector adapter for EPM-50 Power Meter	28.00



EXFO PON POWER METER



Power Meter Light Source

FIBERBASIX 50 SERIES



F17500VIS



## FIS FIBER INSPECTION PROBE

Full Featured Probe; With Built-In Display

This Fiber Inspection Probe, our newest offering at FIS, is loaded with features at a comparably low cost. The ergonomic hand held design can be used in a completely vertical/horizontal fashion or it can fold inward to about a 45 degree angle allowing it to be used in a number of positions within an enclosure or patch panel.

With the push of one button the probe will lock onto the connector end face image, automatically center and focus it and then analyze it against the industry I.E.C. end face inspection criteria to display a PASS or FAIL. The probe has a WiFi USB adapter that can be used to transfer saved data wirelessly to a laptop or computer. USB hardwire connection also is available.

### FEATURES

- Auto-Focus, Auto-Centering, with Pass/Fail Analysis
- Unit comes included with 2.5mm & 1.25mm UPC patch cord tips and UPC SC & LC bulkhead tips
- APC and MPO tips available upon request
- Convenient LED flashlight on-board

PART #	DESCRIPTION	PRICE
F17500VIS	FIS Fiber Inspection Probe	\$2,249.00
F17500MPO	MPO/MTP Inspection Scope Tip MM UPC for F17500VIS	1,285.00
F17500SCA	FIS Bulkhead Inspection Tip SC/APC for F17500VIS	52.00
F17500UA25	FIS 2.5 APC Universal Tip for F17500VIS	52.00

\*Additional probe tips available call for more information

NEW  
UPGRADED  
MODEL



F1-VM400LCD



monitor sizes may vary



## FIS VIDEO MICROSCOPE

The FIS Video Microscope is a natural choice for fast-paced production environments, where ease of use and fast, accurate inspections are a necessity. The microscope offers a high-resolution look at the end face of most standard connectors, with a choice of either 200x or 400x magnifications. The optics and internal components are designed to be rugged and reliable, with no user-serviceable parts.

**Each Package comes with:** (1) Video Microscope, (1) 10" LCD monitor (monitor sizes may vary), (1) 6' Video Cable, (1) 2.5mm Universal Adapter only

PART #	DESCRIPTION	PRICE
F1-VM200LCD	200x Video System (110v)	\$695.00
F1-VM400LCD	400x Video System (110v)	695.00
F1-VM200PLCD	200x Video System (220v)	795.00
F1-VM400PLCD	400x Video System (220v)	795.00
F1-VM200USB	200x, USB (No LCD Monitor included)	680.00
F1-VM400USB	400x, USB (No LCD Monitor included)	680.00



F1-VSF25

## FIS UNIVERSAL 100x MICROSCOPE

The FIS Universal Microscope is provided with a 2.5mm universal faceplate. Insert the ferrule into the microscope and inspect the end face with ease. This complete 100x microscope is perfect for multimode connectors and is easy to use.

PART #	DESCRIPTION	PRICE
F1-VSF25	LED Fiber Inspection Scope with Universal 2.5mm UPC/APC Adapter for SC/ST/FC	\$70.00
F1-VSF125	LED Fiber Inspection Scope with Universal 1.25mm UPC/APC Adapter for LC/MU	75.00

## FIS 200x MINI FIBER MICROSCOPE

Utilize this compact scope to inspect connector ferrule end faces for dirt, debris or oils that may interfere with signal transmission. Scope has both Oblique and Coaxial white LED lighting.

**Includes:** Microscope, (3) 1.5v LR44 Button Batteries, 2.5mm adapter, 1.25mm adapter

PART #	DESCRIPTION	PRICE
F1-MS200U	Compact 200x Microscope	\$115.00

**AFL FOCUS FLEX FIBER OPTIC CONNECTOR INSPECTION SYSTEM**

FOCIS Flex is an ultra-compact Fiber Optic Connector Inspection System Scope utilizing the latest liquid lens technology for fast auto-focus, centering and PASS/FAIL analysis. Results can be stored locally or easily shared via USB, Wi-Fi and Bluetooth®.

PART #	DESCRIPTION	PRICE
FOCIS-FLX-P4XN	FOCIS FLEX, Bluetooth Wi-Fi Enable, No Tips	\$2,095.00
FOCIS-FLX-P4XU	FOCIS FLEX, Bluetooth Wi-Fi Enable, UPC Tips	\$2,195.00
FOCIS-FLX-P4XA	FOCIS FLEX, Bluetooth Wi-Fi Enable, Angled Tips	\$2,295.00
FOCIS-FLX-P4XUA	FOCIS FLEX, Bluetooth Wi-Fi Enable, UPC and Angled Tips	\$2,195.00
FOCIS-FLX-NW-P4XN	FOCIS FLEX, without Bluetooth Wi-Fi, No Tips	\$2,095.00
FOCIS-FLX-NW-P4XU	FOCIS FLEX, without Bluetooth Wi-Fi, UPC Tips	\$2,195.00
FOCIS-FLX-NW-P4XA	FOCIS FLEX, without Bluetooth Wi-Fi, Angled Tips	\$2,295.00



FOCIS DUEL

FOCIS FLEX

**AFL FOCUS DUEL FIBER OPTIC CONNECTOR INSPECTION SYSTEM**

FOCIS Duel is an ultra-compact dual-port inspection scope for fiber optic connectors that uses liquid lens technology for fast auto-focus, centering and PASS/FAIL analysis on two ports. This enables users to inspect both connectors in a mated connection; allowing inspection of one connector's tip (male) and the other's through the mating sleeve (female) without having to change adapter tips. The FOCIS Duel can perform IEC, IPC, AT&T and user defined end-face cleanliness analysis and stores 10,000 images and reports locally. The AFL FOCIS App (iOS and Android) provides a comprehensive and user-friendly feature set as well as connectivity with AFL's cloud-based aeRos® workflow automation platform.

Each FOCIS Duel Kit includes: FOCIS Duel probe with wrist strap and dust cap, AC charger with country-specific plug, USB cable, reference guide, and soft carry case with strap.

PART #	DESCRIPTION	PRICE
FOCIS-DUEL-A	FOCIS Duel Kit, with 2 user-selected APC tips and One-Click®	\$2,895.00
FOCIS-DUEL-N	FOCIS Duel Kit, with No tips or One-Click	2,695.00
FOCIS-DUEL-U	FOCIS Duel Kit, with 2 user-selected UPC tips and One-Click	2,795.00
FOCIS-DUEL-UA	FOCIS Duel Kit, with 2 user-selected UPC and 2 user-selected APC tips and One-Click	2,995.00

**EXFO FIBER INSPECTION PROBES (FIP-410B/420B/425B/435B) AND TIPS**

An intelligent and automated inspection tool. The 420B features automatic fiber image-centering function to reduce test time. The Probe has on-board connector end face analysis via ConnectorMax2. Includes a Pass/Fail indicator for immediate diagnosis of connector cleanliness. The FIP-430B is 100% automated and the first of its kind. The probe will auto detect, auto center, auto focus, analyze and report findings of connector end face.

PART #	DESCRIPTION	PRICE
FIP-410B-XX	USB Digital Video Inspection Probe with Triple Magnification, APC or UPC Connector & Adapter Tips (probe only)	\$1,420.00
FIP-420B-XX	USB Digital Video Inspection Probe with Automated Pass/Fail analysis, Auto Centering and Triple Magnification, APC or UPC Connector & Adapter Tips (probe only)	2,185.00
FIP-430B-XX	USB Digital Video Inspection Probe with Auto Focus, Auto Capture, Auto Detect, Automated Pass/Fail analysis, Auto Centering and Triple Magnification, APC or UPC Connector & Adapter Tips (probe only)	2,845.00
FIP-435B-XX	Wireless Digital Video Inspection Probe, Automated Focus, Automated Pass/Fail Analysis, Triple Magnification and Auto Centering, APC or UPC Connector & Adapter Tips	3,280.00
FIPT-400-ST	ST bulkhead adapter (UPC Only)	90.00
FIPT-400-U12M	Universal patch cable tip 1.25mm ferrules	90.00
FIPT-400-U25M	Universal patch cable tip 2.5mm ferrules	90.00
FIPT-400-U25MA	Universal patch cable tip 2.5mm APC ferrules	135.00
FIPT-400-U12MA	Universal patch cable tip 1.25mm APC ferrules	135.00
FIPT-400-FC-SC	FC and SC tip for bulkhead adapter (UPC)	90.00
FIPT-400-FC-APC	FC/APC tip for bulkhead adapter	155.00
FIPT-400-SC-APC	SC/APC tip for bulkhead adapter	155.00
FIPT-400-LC-SQ	LC tip for bulkhead adapter	90.00
FIPT-400-LC-APC	LC/APC tip for bulkhead adapter	135.00



**FIS 200x AND 400x MICROSCOPE**

These low cost, high quality microscopes are available in 200x or 400x magnification, and utilize white LED light to provide coaxial illumination of connector end faces. Three AAA batteries provide more than 40 hours of use before battery replacement is required. Provided with a universal 1.25mm and a 2.5mm adapter, with other connector styles available. Dimensions: 8.76"L x 2.16"H

PART #	DESCRIPTION	PRICE
F1-VS200U	200x Microscope with 1.25mm and 2.5mm Universal Adapter	\$115.00
F1-VS400U	400x Microscope with 1.25mm and 2.5mm Universal Adapter	115.00



F1-MS200U



F1-VS400U

**FIS VIDEO MICROSCOPE ACCESSORIES ONLY (VM SERIES)**

Adapters are for use with the FIS Video Microscope VM Series only.

PART #	DESCRIPTION	PRICE
F1-VS12U	Universal 1.25mm Adapter	\$60.00
F1-VS25	Universal 2.5mm Adapter	60.00
F1-VSAPC25	Universal 2.5mm APC Adapter	60.00
F1-VSLC	LC Simplex Adapter	60.00
F1-VSSMA	SMA Adapter (VM Series scopes only)	60.00



F1-9000



F1-9000VFL

## FIS POCKET FAULT LOCATORS

The FIS Fiber Optic Pocket Fault Locators are designed to be rugged, compact and lightweight. These units are 7.1" in length and weigh approximately 4.5oz. With a 30-hour battery life in continuous mode and 40 hours in modulated mode, the bright 650nm (red) laser which has a range of up to 5Km ensures fast and easy location of fault points within fiber optic patchcords, patch panels and enclosures. They can also be used to identify fibers in multi-fiber cables, and it is designed for both singlemode and multimode fiber optic applications. These units are shipped with two "AA" batteries and a belt holster.

PART #	DESCRIPTION	PRICE
F1-9000	Pocket Fault Locator with 2.5 Universal Adapter (SM and MM), Rugged Aluminum Housing, 40hr Battery Life, 650nm, 5km, 7.1"x0.86", Blue	\$109.00
F1-9000125	Pocket Fault Locator with 2.5 & 1.25 Universal Adapters (SM and MM), Rugged Aluminum Housing, 40hr Battery Life, 650nm, 5km, 7.1"x0.86", Blue	125.00
F1-9000VFL	Pocket Fault Locator with 2.5 Universal Adapter (SM and MM), Standard Aluminum Housing, 40hr Battery Life, 650nm, 5km, 7.1"x0.6", Black	75.00

## VFL 1.25 MM ADAPTER (LC)

This adapter allows you to convert the 2.5mm adapter on your VFL into a 1.25mm ferrule typically for LC style connectors.

PART #	DESCRIPTION	PRICE
F1-90125	1.25mm Adapter (Compatible with PFLs using Universal 2.5mm Adapters)	\$30.00



Fault Locators are a special class of light sources that emit a high intensity visible Red Laser into a patch cable or cable. This light can be used to both check the continuity of a fiber and identify the fiber's far end, or it can be used to visually identify the location of a fiber break. Most Fault Locators come optimized for singlemode fiber use; however they work equally as well with multimode fiber.

Manufacturer	Part Number	Type	Operating Wavelength	Distance	Fiber Type	Battery Life/ Type	Optical Interface	Dimension	Special Feature	Price
	FFL-050	Pocket	650nm	7km   5km	SM/MM	30hrs (2AA)	2.5mm Universal	4.5" x 1.4" x 0.8"	Ruggedized Housing	\$175.00
	FLS-241-UNIV	Pocket	635nm	5km	SM/MM	50hrs(2AAA)	2.5mm Universal	6.875" x 1"	Weather Proof	\$435.00
	VISIFAULT	Pocket	650nm	4km   3km	SM/MM	80hrs(2AA)	2.5mm Universal	6.2" x 2.0" x 1.3"	Long Battery Life	\$445.00
	F6230A	Pocket	650nm	8km	SM/MM	N/A(1AA)	2.5mm Universal	6.2" x 0.63" x 2.36"	Low Battery Indicator	\$169.95
	VF1-4010900PR	Pocket	650nm	10km	SM/MM	30hrs(1AA)	2.5mm Universal	3.1" x 2.0" x 0.9"	Small Key Chain Size	\$149.00
	VFF5	Pocket	650nm	5km   5km	SM/MM	80hrs (2AA)	2.5mm Universal	8.7" x 1.25"	Rugged Aluminum Housing	\$298.00



### FIS DUAL SOURCE VISUAL FAULT LOCATOR

Fiber Instrument Sales introduces its Dual Source Visual Fault Locator specially made for duplex LC connectors. Because LC connectors are commonly clipped together this product eliminates the common mistake that is made of crossing Tx and Rx patchcords to active equipment. This unit allows the user to toggle between the "A" and "B" sources to ensure that everything is properly connected.

**Each Unit Includes:** Carrying pouch, 9V Battery, User Manual, One Year Warranty

#### FEATURES

- Dual visual fault locator (650nm) for duplex LC cables
- 9 volt battery included
- Up to 5Km Range
- Easy to identify the fault's location
- Easy verification of duplex cable polarity
- Quick identification of continuity of installation
- Low battery indicator light
- "A" and "B" source indicator lights
- Ergonomically friendly handheld soft case
- Plug and Play LC mating sleeve allows for secure connection
- Can activate single or both sources simultaneously, one modulates while one is constant

PART #	DESCRIPTION	PRICE
F1DXVFL	FIS Dual Source Visual Fault Locator, LC Duplex, SM/MM, 3"(w) x 4.25"(h)	\$295.00
F1DXVFLMDC	FIS Dual Source Visual Fault Locator, MDC Duplex Interface, SM/MM, 3"(w) x 4.25"(h)	295.00



F1-DXVFL

### FIS Mini MPO Visual Fault Locator

The new FIS Mini MPO Visual Fault Locator is able to test all channels utilizing two sources with source "A" lighting up channels 1 thru 6 and source "B" lighting up channels 7 thru 12. As with most MPO networks, continuity and polarity verification can prove challenging and time consuming. Traditional methods involve expensive breakout cables and single fiber visual fault locators, checking only one channel at a time. The new Mini MPO Visual Fault Locator made by FIS, allows the user to quickly ensure the proper continuity of all channels of the MPO cable with visible light. Its handheld design, coupled with its straight forward easy to use keypad interface will determine if all channels are properly installed.

#### FEATURES

- Mini MPO visual fault locator for MPO/PC Connectors
- Dual Source Visual Fault Locator; Source A Ch 1-6, Source B Ch 7-12
- 9 volt battery included
- Can activate single or both sources simultaneously, one modulates while one is constant
- Plug and Play MPO mating sleeve allows for secure connection
- Can verify MPO/MTP cable assemblies up to 300 meters (singlemode and multimode)
- Easy to identify continuity
- Quick identification of continuity after installation
- Low battery indicator light
- "A" and "B" source indicator lights
- Small handheld design
- Accepts Female MPO/PC Connectors Only

PART #	DESCRIPTION	PRICE
F1MPOVFLHH	FIS MINI MPO Visual Verifier	\$495.00
F10PV	FIS MPO/MTP VFL Optical Polarity Verifier	150.00
F1MPOVFLSMKIT	Singlemode Conversion Kit	275.00



F1MPOVFLHH

F10PV

### FIS HIGH POWERED VISUAL FAULT LOCATOR

This enhanced FIS Visual Fault Locator is now made with a higher power 650nm red, visible laser (up to 4.5mW) to now be used as a longer range VFL than our traditional offering 1 mW version. This unit, because of its higher power (up to 5 mW) can detect bends and verify continuity on up to 10km or more of fiber! An essential tool for troubleshooting any standard fiber optic system. Internal optics are used to optimize the unit's performance for either single mode or multimode fiber applications. Our higher powered VFL is made in the United States with pride!

**Each Unit Includes:** Manual, (1) 9v Batteries, and Carry Case.

PART #	DESCRIPTION	PRICE
OF-1000-UF	High Powered Visual Fault Locator with 2.5mm Universal Adapter (MM and SM)	\$295.00
OF-1000U-LC	High Powered Visual Fault Locator with LC Adapter (MM and SM)	295.00
OF-1000U-FCA	High Powered Visual Fault Locator with FC/APC Adapter (SM)	295.00
OF-1000U-SCA	High Powered Visual Fault Locator with SC/APC Adapter (SM)	295.00



OF-1000-UF

### FIS CONTINUITY TESTER

A Continuity Tester enables you to easily verify light throughput as the LED transmits red light down the fiber, providing visual identification at the fiber's far end. Operates with two "AA" size batteries (provided).

**Recommended for Multimode Use Only. Each Unit Includes:** Tester and (2) AA Batteries.

PART #	DESCRIPTION	PRICE
F1-5000U	Fiber Continuity Tester 2.5mm Universal (ST, FC and SC)	\$29.95
F1-5000	Fiber Continuity Tester (ST)	29.95
F1-5000SMA	Fiber Continuity Tester (SMA)	39.95
F1-5000FC	Fiber Continuity Tester (FC)	29.95
F1-5000SC	Fiber Continuity Tester (SC)	29.95
F1-5000LC	Fiber Continuity Tester (LC)	29.95



F1-5000 SC

## FIS MPO VISUAL FAULT LOCATOR WITH POLARITY VERIFIER

This rugged, weather and shock resistant MPO VFL for Multimode or Singlemode cable assemblies is a great troubleshooting tool that is needed to establish or confirm polarity, continuity, and macrobends within an MPO optical system. If no breakout cassette is present, the polarity verifier unit (F1-OPV), when used on the far end of a MPO/MTP cable can provide the user a quick, safe and easy determination of continuity and polarity of the fibers within the MPO cable assembly. This new one of a kind product is a must for any pre- and post-installation technician!

### FEATURES

- Three different laser output sequences: Auto, Manual, 5G Polarity
- Auto shut off option (10 minutes being idle)
- Rugged, lightweight design
- Water Resistant
- Self-closing shutter on MPO adapter
- Long battery life, up to 10 hours on full charge
- Outdoor enhanced screen
- Backlight option, great for dim lighted areas
- 650nm visible light (minimum output power of -1dBm)
- Includes Optical Polarity Verifier and two OM3 MPO patchcords.
- **Optional Singlemode Conversion Kit.** Conversion Kit includes (4) hybrid APC to UPC MPO jumpers & (2) mating sleeves.



F1-MPOVFL

F1-OPV

PART #	DESCRIPTION	PRICE
F1-MPOVFL	FIS MPO VFL with Optical Polarity Verifier and OM3 Patchcords	\$1,995.00
F1-MPOVFLSMKIT	SM Conversion Kit with APC to UPC MPO Jumpers w/ mating sleeves	275.00
F1-OPV	MPO VFL Optical Polarity Verifier	150.00

Now Includes  
US Conec MTP®  
PRO Field Tool  
(see page 133)



## FIS MPO TEST SET

This 12 Fiber MPO/MTP Test Set will provide the technician with link attenuation readings over all 12 fibers of the MPO/MTP ferrule in 10 seconds. MPO/MTP connectors are growing in popularity so the ability to measure efficiently, quickly and accurately the correct location of each fiber and its attenuation can assist technicians with certification. The test set will recognize A, B or C polarity wiring configurations used in the industry. Includes (2) MPO to MTP® PRO reference cables, and reporting software. \*MPO/MTP to LC Breakout cable available upon request

### FEATURES

- Singlemode or Multimode
  - 12 Position Light Source and Power Meter
  - Pass/Fail Reporting
  - dBm/dB check criteria
  - Select A, B, C or 5G\* Polarity
  - USB Data Transfer
  - Two Reference Cords with MTP® PRO Connectors
- \*5G polarity setting scans channels 1-4 and 9-12 only



F1-1310MPO



Ruggedized Version

PART #	DESCRIPTION	PRICE
F1-850MPO	FIS MPO 12 Fiber Test Set (MM Power Meter with 850nm Source)	\$5,995.00
F1-1310MPO	FIS MPO 12 Fiber Test Set (SM Power Meter with 1310nm Source)	5,995.00
F1-1550MPO	FIS MPO 12 Fiber Test Set (SM Power Meter with 1550nm Source)	5,995.00
F1-850MPOR	FIS Ruggedized MPO 12 Fiber Test Set (MM Power Meter with 850nm Source)	6,095.00
F1-1310MPOR	FIS Ruggedized MPO 12 Fiber Test Set (SM Power Meter with 1310nm Source)	6,095.00
F1-1550MPOR	FIS Ruggedized MPO 12 Fiber Test Set (SM Power Meter with 1550nm Source)	6,095.00

\* Call for pricing on individual Power Meter and/or Light Source units.

## FIS MPO ENCIRCLED FLUX REFERENCE CORD

Ever increasing network speeds and tighter loss budgets make qualifying multimode fiber links a formidable challenge. Part of the challenge can stem from test instruments. In some scenarios different test instruments can produce different measurement results on the same network due to variations in launch conditions between test sources. Encircled Flux (EF) standards, TIA-526-14-B and IEC 61280-4-1 Ed. 2.0, define a method of controlling multimode launch conditions for optical test sources. More consistent test source launch conditions equate to more accurate and repeatable measurements. This is the goal driving the migration to encircled flux standards.



F1EFRC-OM3

PART #	DESCRIPTION	PRICE
F1EFRC-OM3	OM3 Encircled Flux Reference Cord, 2mtr	\$299.95

## BECOME CERTIFIED ON OUR SPLICE-ON CONNECTOR TODAY!

FOR MORE INFORMATION SEE PAGES 164 & 165



FIS' patented SOC holder design is available in stock for most industry-leading Fusion Splicers. This gives the installer the luxury of installing a Cheetah or Armordillo SOC with the tools they already have. Each SOC holder will allow you to splice SC, LC, ST and FC connectors, with 1.6mm, 2.0mm, and 3.0mm cordage holders available for your more rugged installations. See the table below to find your fusion splicer combination. (Please note that use of Armordillo as well as ST/FC Cheetahs will require the FIS Universal SOC oven)



### Visit us on our website to view the instructional videos on the Cheetah and Armordillo SOC's

## FIS CHEETAH & ARMORDILLO SOC COMPATIBILITY CHART

Manufacturer	Splicer Model	SOC Compatibility	SOC Holder Part Number	Cordage Holder Part Number	Cleaver Compatibility
FIS	F1CA6	900µm and 3.0mm	F1SOCSLACA6	All Versions	LYNX CT50/CT08 S326A FC6/FC8
	F1AC5	900µm and 3.0mm	F1SOCSLAAC5	All Versions	CT50 CT08
AFL/Fujikura	41S	900µm and 3.0mm	F1SOCSLAA	All Versions	S326A
	62S				
	70S				
	90S				
Furukawa/ Fitel	S123	900µm and 3.0mm	F1SOCSLAF F1SOCSLAF F1SOCSLAF2 F1SOCSLAF2	All Versions	FC6RSC FC8R
	S153				
	S179				
	NINJA				
Sumitomo	Q102CA	900µm and 3.0mm	F1SOCSLAS	All Versions	FC6RSC FC8R
	Q502S				
	T56				
	T400				

Call a FIS Sales Representative for questions on Fusion Splicers not listed.

### CHEETAH AND ARMORDILLO SOC HOLDERS

PART #	DESCRIPTION	PRICE
F1SOCSLACA6	FIS SOC Holder for FIS CA6 Splicer	\$100.00
F1SOCSLAA	FIS SOC Holder for the AFL Splicers	100.00
F1SOCSLAAC5	FIS SOC Holder for FIS AC5 Splicer	100.00
F1SOCSLAF2	FIS SOC Holder for the OFS Fitel Splicers (NINJA and S179)	100.00
F1SOCSLAS	FIS SOC Holder for the Sumitomo Splicers	100.00
F1LCDLXCLIP	LC duplex clip for FIS Splice on Connectors (Cheetah and Armordillo) Set of 5 clips	6.40
F1LCDLXCLIPLOCK	Lockable LC duplex clip for FIS Splice on Connectors (Cheetah and Armordillo) Set of 5 clips and locks	12.80
F1LCDLXTOOL	Lock removal tool for lockable LC duplex clip for FIS Splice on Connectors (Cheetah and Armordillo)	2.99

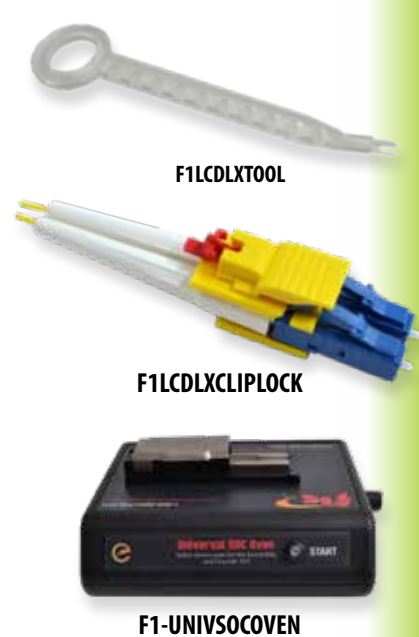

### 3/2mm ARMORDILLO SOC™ CORDAGE HOLDERS

PART #	DESCRIPTION	PRICE
F1-UNIVSOOVEN	Cheetah and Armordillo Splice-On Connector Sleeve Oven	\$495.00
F1-SOC30CRIMPTOOL	FIS Crimp Tool (Die and Handle) for the 3.0/2.0mm SOC	120.45
F1SOC30CA6SLAHLDR	FIS 3mm SLA Cordage Holder for FIS CA6	100.00
F1SOC30AC5SLAHLDR	FIS 3mm SLA Cordage Holder for FIS AC5	100.00
F1SOC30AFLSLAHLDR	FIS 3mm SLA Cordage Holder for AFL	100.00
F1SLA30SHLDR	FIS 3mm SLA Cordage Holder for Sumitomo	100.00
F1SLA30FTL2HLDR	FIS 3mm SOC Cordage Holder for Fitel Splicers	100.00
F1-SOC30FISHLDRCA616SLA	FIS 1.6mm SOC Cordage Holder for FIS CA6 Splicer	100.00
F1-SOC30FTLHLDR16SLA	FIS 1.6mm SOC Cordage Holder for Fitel Splicers	100.00
F1-SOC30AFLHLDR16SLA	FIS 1.6mm SOC Cordage Holder for AFL Splicers	100.00
F1-SOC30SHLDR16SLA	FIS 1.6mm SOC Cordage Holder for Sumitomo Splicers	100.00



**FIS CA6 CORE ALIGNMENT SPLICER**

Featuring a brand-new 5" touch screen and user interface, FIS' CA6 Core Alignment Fusion Splicer is the latest enhancement to its fusion splicer offering. The FIS CA6 is compact, lightweight, and faster than ever with a 6 second splice time in SM Quick Mode and 15 second heat shrink time. Fully compatible with FIS Cheetah and Armordillo Splice On Connectors. The CA6's Core Alignment technology will consistently deliver low loss splices (0.02dB SM and 0.01dB MM). Core alignment splicers deliver low loss splices meeting long haul fiber installation requirements.

**FEATURES**

- Fast Splice Time – 6 Seconds in Singlemode Quick Mode
- 5" High Resolution Touch Screen
- 300 Splice and Heat Cycles per Battery
- Perfect for use with Splice-On Connectors

**FIS Splice-On Connector Compatible**

**FREE FIS CA6 Fusion Splicer with Purchase of 2,500 Connectors in any combination!!**

Limited time offer

Quantity Pricing Available

PART #	DESCRIPTION	PRICE
F1-CA6	CA6 Core Alignment Fusion Splicer kit w/ FC-6RS cleaver, Cheetah SOC Holder, Spare Electrodes, Sheath Clamps	\$7,495.00
F1-CA6NC	FIS CA6 Core Alignment Fusion Splicer Kit w/ Cheetah SOC holder, spare electrodes, Sheath clamp, without cleaver	6,400.00

**CA6 ACCESSORIES**

PART #	DESCRIPTION	PRICE
FHS-025	250um Removable Fiber Holders (Pair)	\$300.00
FHS-09	900um Removable Fiber Holders (Pair)	300.00
ER-10	CA6 Electrodes	100.00
BU-16	CA6 Li-ion Battery	367.00

**Cheetah Splice-On Connector**

**TERMINATIONS IN LESS THAN 3 MINUTES**  
Visit us on our website to view the instructional videos on the Cheetah and Armordillo SOC's

SEE PAGE 49 FOR LC CLIPPING & LOCKING OPTIONS



F1-LCUPC-SOC

**FIS CHEETAH SOC™**

The FIS Cheetah SOC™ is the quickest pre-polished factory terminated pigtail to prepare, splice and install. The Cheetah SOC™ 27mm splice protection sleeve is encapsulated and protected by the strain relief boot eliminating the need for splice trays, chips and extra cabinets. When used with the required universal holder the SOC can be used with a variety of fusion splicers.

**Each 900µm Cheetah SOC™ Includes:** Connector, Cleave Protector, 900µm Boot, and Fusion Splice Sleeve.

PART #	DESCRIPTION	10pk PRICE	100pk PRICE
F1-LCAPC-SOC-X	LC/APC Singlemode, Green 900µm Boot	\$82.00	\$820.00
F1-LCUPC-SOC-X	LC/UPC Singlemode, White 900µm Boot	71.50	715.00
F1-LC62-SOC-X	LC/PC 62.5µm Multimode (OM1), Beige 900µm Boot	61.50	615.00
F1-LCOM3-SOC-X	LC/PC 50µm Multimode (OM3), Aqua 900µm Boot	61.50	615.00
F1-LCOM4-SOC-M-X	LC/PC 50µm Multimode (OM4), Magenta 900µm Boot (Magenta Housing)	71.50	715.00
F1-LCOM4-SOCAQ-X	LC/PC 50µm Multimode (OM4), Aqua 900µm Boot (Aqua Housing)	71.50	715.00
F1-SCAPC-SOC-X	SC/APC Singlemode, Green 900µm Boot	82.00	820.00
F1-SCUPC-SOC-X	SC/UPC Singlemode, White 900µm Boot	71.50	715.00
F1-SC62-SOC-X	SC/PC 62.5µm Multimode (OM1), Beige 900µm Boot	61.50	615.00
F1-SCOM3-SOC-X	SC/PC 50µm Multimode (OM3), Aqua 900µm Boot	61.50	615.00
F1-SCOM4-SOC-X	SC/PC 50µm Multimode (OM4), Magenta 900µm Boot	71.50	715.00
F1-STUPC-SOC-X	ST/UPC Singlemode, White 900µm Boot	71.50	715.00
F1-ST62-SOC-X	ST/PC 62.5µm Multimode (OM1), Beige 900µm Boot	61.50	615.00
F1-STOM3-SOC-X	ST/PC 50µm Multimode (OM3), Aqua 900µm Boot	61.50	615.00
F1-FCAPC-SOC-X	FC/APC Singlemode, Green 900µm Boot	82.00	820.00
F1-FCUPC-SOC-X	FC/UPC Singlemode, White 900µm Boot	71.50	715.00
F1-FC62-SOC-X	FC/PC 62.5µm Multimode (OM1), Beige 900µm Boot	61.50	615.00
F1-FCOM3-SOC-X	FC/PC 50µm Multimode (OM3), Aqua 900µm Boot	61.50	615.00

\*When ordering SOC's are available in 10pks and 100pks. Replace 'X' w/ "-10" for 10 pack or "-100" for 100 pack

**FIS AC5 SOC Handheld Fusion Splicer KIT**

FIS AC-5 Active Clad Fusion Splicer kit is an affordable, and effective kit solution for doing fiber to fiber splicing as well as for FIS' line of Cheetah and Armordillo Splice on Connectors. With industry leading splice time of 6 seconds per splice, the F1SOCAC5900 kit comes with our 900um SOC holder. In the full kit (F1SOCAC5), it includes a 3.0mm cordage holder, crimp tool for the 3.0mm Armordillo solution, and our FIS external SOC oven. A solution for all of your splicing needs, the FIS AC5 Termination Kit will exceed your expectations, and more importantly, stay under your budget.

**FEATURES**

- Active V-Groove Alignment
- 5" Touch Screen Monitor
- Long-life battery (200 splices/shrinks per charge)
- Fully ruggedized for shock resistance
- Optimized kit for SOC and fiber to fiber applications

PART #	DESCRIPTION	PRICE
F1-SOCAC5900	FIS AC5 Fusion Splicer with Precision Cleaver, no stand alone SOC heat oven included for 900um SOC termination kit.	\$3,195.00
F1-SOCAC5	AC5 Splice-On Connector Termination Kit (Fusion Splicer, Cleaver, Universal SOC Oven, 900um SOC Holder, 3mm Cordage Holder, and Crimp Tool)	3,395.00

**3mm / 2mm / 1.6mm FIS ARMORDILLO™ SOC**

Using a factory-terminated and pre-polished connector, the Armordillo Splice-On Connector (SOC) provides a connection that meets or exceeds industry standards for loss and back reflection. The Splice-On Connector is provided with a factory-cleaved 900um fiber stub to ensure ease of use and optimal performance.

The unique 3mm and 2mm boot allows the entire splice to be concealed and protected. The addition of an extended brass crimp ring provides extra protection to the splice and utilizes the Kevlar for maximized pull strength. The Armordillo is designed to work with FIS, Fitel, AFL and Sumitomo splicers and cleavers (cordage fiber holders required). The Universal SOC Oven can shrink the inner tube in 45 seconds. Comes with custom piece of furcation for use on 1.6mm OD cable on standard boot.

- Splice-On solution for 3mm, 2mm and 1.6mm applications
- Splice protection encapsulated and protected by the extended brass crimp ring and strain relief boot
- Same ease of use as the 900um SOC

Each Armordillo SOC Includes: Extended furcation kit for use on 1.6mm OD cable, Connector, Cleave Protector, 3mm and 2mm Boot, Extended Brass Crimp Ring, and Protection Sleeve

PART #	DESCRIPTION	10pk PRICE	100pk PRICE
F1-LCAPC-SOC-A-X	LC/APC Singlemode, Green 3.0/2.0mm Boot	\$100.00	\$1,000.00
F1-LCUPC-SOC-A-X	LC/UPC Singlemode, White 3.0/2.0mm Boot	90.00	900.00
F1-LC62-SOC-A-X	LC/PC 62.5µm Multimode (OM1), Beige 3.0/2.0mm Boot	80.00	800.00
F1-LCOM3-SOC-A-X	LC/PC 50µm Multimode (OM3), Aqua 3.0/2.0mm Boot	80.00	800.00
F1-LCOM4M-SOC-A-X	LC/PC 50µm Multimode (OM4), Magenta 3.0/2.0mm Boot (Magenta Housing)	90.00	900.00
F1-LCOM4A-SOC-A-X	LC/PC 50µm Multimode (OM4), Aqua 3.0/2.0mm Boot (Aqua Housing)	90.00	900.00
F1-SCAPC-SOC-A-X	SC/APC Singlemode, Green 3.0/2.0mm Boot	100.00	1,000.00
F1-SCUPC-SOC-A-X	SC/UPC Singlemode, White 3.0/2.0mm Boot	90.00	900.00
F1-SC62-SOC-A-X	SC/PC 62.5µm Multimode (OM1), Beige 3.0/2.0mm Boot	80.00	800.00
F1-SCOM3-SOC-A-X	SC/PC 50µm Multimode (OM3), Aqua 3.0/2.0mm Boot	80.00	800.00
F1-SCOM4M-SOC-A-X	SC/PC 50µm Multimode (OM4), Magenta 3.0/2.0mm Boot (Magenta Housing)	90.00	900.00
F1-STUPC-SOC-A-X	ST/UPC Singlemode, White 3.0/2.0mm Boot	100.00	1,000.00
F1-ST62-SOC-A-X	ST/PC 62.5µm Multimode (OM1), Beige 3.0/2.0mm Boot	80.00	800.00
F1-STOM3-SOC-A-X	ST/PC 50µm Multimode (OM3), Aqua 3.0/2.0mm Boot	80.00	800.00
F1-FCAPC-SOC-A-X	FC/APC Singlemode, Green 3.0/2.0mm Boot	100.00	1,000.00
F1-FCUPC-SOC-A-X	FC/UPC Singlemode, White 3.0/2.0mm Boot	90.00	900.00
F1-FC62-SOC-A-X	FC/PC 62.5µm Multimode (OM1), Beige 3.0/2.0mm Boot	80.00	800.00
F1-FCOM3-SOC-A-X	FC/PC 50µm Multimode (OM3), Aqua 3.0/2.0mm Boot	80.00	800.00

\*When ordering replace the "X" to specify 10= 10packs, 100= 100packs.



**FREE**  
FIS AC5 Splicer Kit  
with Purchase of  
1,250 SOC  
Connectors



**FREE FIS AC5 SOC Splicer Kit with Purchase of 1,250 SOC Connectors**

Limited time offer



FIS Armordillo SOC™





**90S+**  
Fusion Splicer

**FEATURES**

- Cleaver tracking and upkeep with wireless communication
- Automated wind protector, sheath clamps and splice operation
- Fiber type identification
- Loose and tight buffer with same sheath clamp
- Lithium-ion battery with 300 splices/shrinks per charge
- 5 mm cleave length for small package needs
- Multi-function transit case with integrated workstation

**AFL 90S+ SPLICER**

The 90S+ is the latest core alignment splicer from Fujikura. It's designed to give you high quality splices and to stay in the field. The 90S+ kit solves problems seen in the field today, from splicing poor quality legacy fiber to automated equipment maintenance and upkeep. The 90S+ can be utilized in any field splicing application seen today: bend-insensitive fibers in drop cables, long-haul terrestrial and submarine LEAF fibers, loose buffer fiber, splice on connectors, and the list goes on. The speed and accuracy of the 90S+ even make it suitable for certain production and specialty environments, where high output, tight packaging, and low loss requirements are needed. Regardless your use-case, the 90S+ is designed to keep you going with an extended battery life from 200 to 300 splice and heat cycles, and by alleviating the need for traditional operation tasks such as; frequent arc calibrations, cleaver blade rotations, cleaver usage tracking, and manual splicing operations with its multiple automated and ease-of-use features. A multi-purpose sheath clamp, redesigned work tray, cooling tray, and optional cable clamp make the 90S+ kit more versatile than any of its predecessors in adapting to varying work conditions and environments.

**90S+ Fusion Splicer Kit includes:** 90S+ Fusion Splicer, CT50 Cleaver, ADC-20 AC Adapter, ACC-14 AC Cord, BTR-15 Battery, ELCT2-16B Spare Electrodes (pair), Sheath Clamps, SP-03 Fiber Holder Set Plates, USB-01 Cable, Alcohol Dispenser, Splicer Carrying Strap, Quick Reference Guide, Work Tray J-Plate, SS03 Single Fiber Stripper and CC39 Transit Case with Carrying Strap

PART #	DESCRIPTION	PRICE
S017521	90S+ Fusion Splicer Kit with Bluetooth	\$10,400.00
S017519	90S+ Fusion Splicer (machine only)	9,698.00
S017520	90S+ Fusion Splicer (machine only) without Bluetooth	9,698.00

**Call Your FIS Sales Representative For More Information**

**AFL 41S+ SPLICER**

The Fujikura 41S+ is a fully ruggedized, two camera, active cladding alignment fusion splicer. Enabled by Warm Splice Imaging (WSI), the 41S+ can determine the alignment of the fiber cores by observing the splice during the heating process. This delivers splice loss estimates with a greater level of accuracy than those based on cladding only alignment. Active Blade Management (ABM) via Bluetooth® connection with the CT50 Fiber Cleaver tracks usage and enables automated blade rotation as needed, mitigating fiber reburns. The new Active Fusion Control (AFC) technology further reduces reburns by improving splice losses for fibers with poor cleave angles. With the combination of ABM and AFC, the Fujikura 41S+ contains a robust set of splicing features that will reduce the likelihood of poor splice installations or repairs. A 6-second splice time and 25-second shrink time offers unmatched speed and productivity, while an easy-to-use touchscreen monitor provides simple and intuitive menu navigation. Interchangeable sheath clamps or fiber holders provide versatility for user preference, and compatibility with splice-on connectors. The extended-life battery is rated for up to 200 splice and heat cycles. Long-life electrodes provide 5,000 splices and help minimize downtime for replacement and stabilization. The large 5" monitor provides a crystal-clear image, even in the brightest sunlight. Software updates are accomplished via the internet allowing users to quickly update their software as new splice programs become available. Backed by the best service team in the industry, the Fujikura 41S+ is the ideal splicer to use when portability, ruggedness, and reliability are needed for splicing applications.

**41S+ Fusion Splicer Kit with Cleaver includes:** Fujikura 41S+ Fusion Splicer, CT50 Cleaver, S31A Sheath clamps (installed), FH-70-250 Fiber Holders (pair), FH-70-900 Fiber Holders (pair), SP-01 Set Plates, ADC-19A AC Adapter, BTR-11A Battery Pack (installed), ACC-09 Power Cord, ELCT2-16B Spare Electrodes (pair), Screwdriver, Operation Manual on CD, Quick Reference Guide, SS-03 Single Fiber Stripper and CC-36 Transit Case

PART #	DESCRIPTION	PRICE
S017090	AFL Fujikura 41S+ Fusion Splicer Kit (Splicer Only)	\$3,295.00
S017091	AFL Fujikura 41S+ Fusion Splicer Kit w/CT50	3,995.00



**41S+**  
Fusion Splicer

**AFL / FIS Splice-On Connector Compatible**

**FEATURES**

- Warm Splice Imaging (WSI) loss estimation technology
- Improved real-time arc control for fibers with poor cleave angles
- Bluetooth enabled cleaver management
- Two camera, active cladding alignment
- 5" touchscreen monitor
- Fully ruggedized for shock, moisture and dust resistance
- Extended-life electrodes, 5,000 splices, exchangeable without tools
- Perfect for use with Splice-On Connectors

**WSI = Warm Splice Image WHAT IS IT?**

The hot fiber glows during the arc. The core glows more brightly than the cladding due to core dopants. Low resolution optical system can "see" the core (without focus motors). Therefore, loss estimation can be based on core observation. This enables more accurate loss estimation



**AFL 90R MASS FUSION SPLICER (RIBBON)**

The Fujikura 90R is the mass fusion splicer workhorse of the splicing world. As data demand continues to rise, the solution to handle the increased traffic is to increase fiber counts. As a result, fiber counts being utilized in enterprise data centers, campus, and metro networks have grown enough to make single fiber splicing too costly and timely. High density cabling made possible by SWR and others like it are spurring ribbon splicing activity in places that have traditionally used loose fiber. The 90R is the answer to these changes in splicing demand. With automated splice start, tube heater, wind protector, cleave tracking, and blade rotations for up to two cleavers at a time, this splicer frees up a lot of operator time for other fiber preparation steps. New to the 90R, you can keep your splicer in the field longer with field replaceable V-grooves. When V-grooves can no longer be cleaned after extended use, or are accidentally damaged, you can resume splicing in minutes by installing the spare set included with your 90R kit.

**90R Includes:** 90R Fusion Splicer, BTR-15 Battery, CT50 Cleave Kit, RS03 Stripper Kit, SS03 Single Fiber Stripper, ADC-20 AC Adapter, ACC-14 AC Cord, ELCT2-16B Spare Electrodes (pair) with spare V-Grooves (VG12-01), FH-70-12 Fiber Holder, USB Cable, Alcohol Dispenser, Screwdriver, Splicer Carrying Strap, Quick Reference Guide, Video Instruction Manual and CC-39 Transit Case with Carrying Strap



**90R Fusion Splicer**

PART #	DESCRIPTION	PRICE
S017511	90R Fusion Splicer Kit with Bluetooth (with cleaver & thermal stripper)	\$15,225.00
S017510	90R Fusion Splicer without Bluetooth (with cleaver & thermal stripper)	15,600.00
S017540	AFL Fujikura 90R Fusion Splice w/out Bluetooth(Machine Only)	13,555.00

**FEATURES**

- Cleave tracking and upkeep with wireless communication
- Automated wind protector, tube heater and splice operation
- User replaceable v-grooves
- Single to 12 fiber splicing in one machine
- 200 µm and 250 µm SpiderWeb Ribbon® universal fiber holders
- Multi-function transit case with integrated workstation

# AFL SINGLE AND RIBBON FIBER HOLDER SELECTION GUIDE



**Single Fiber**

COATING DIAMETER OR CABLE TYPE	FIBER HOLDER	
	MODEL	IMAGE
160 µm Coating	FH-70-160	
200 µm and 250 µm Coating	FH-70-250	
500 µm Coating	FH-70-500	
Tight Buffer 900 µm Coating	FH-70-900	
Loose Buffer 900 µm with 250 µm Coating*	FH-60-LT900	
2 mm Cable with Tight Buffer 900 µm Coating	FH-FC-20	
3 mm Cable with Tight Buffer 900 µm Coating	FH-FC-30	
Flat Drop Cable with 250 µm Coating	FH-60-DC250	

**Ribbon Fiber**

APPLICABLE RIBBON(S)	FIBER HOLDER		V-GROOVE TYPE	
	MODEL	IMAGE	MODEL	IMAGE
250 µm all types*				
Fujikura 200 µm SpiderWeb Ribbon®	FH-70-2, 4, 6, 8, 10 and 12			
Sterilite 200 µm TruRibbon™				
OFS 200 µm Rollable Ribbon			VG12-01 (250 µm Pitch)	
Prismian 200 µm FlexRibbon™	FH-70-12PC			
200 µm Ribbonized (any OEM)*				
Sumitomo 200 µm Freeform Ribbon™	FH-R200-3x4			
Corning 200 µm RocketRibbon™			VG12-01-200 (200 µm Pitch)	
200 µm all types* Except: Fujikura SpiderWeb Ribbon and Sterilite TruRibbon	FH-70-12-200			



AFL Fiber Holders  
S017111



AFL ELCT2-16B  
Replacement Electrodes  
S017103

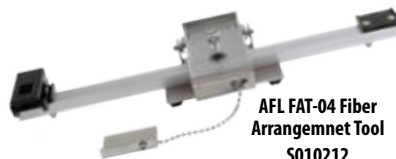

AFL FAT-04 Fiber  
Arrangement Tool  
S010212



FST-12 Fiber Separation Tool  
S014012



AFL Portable Tripod  
Workstation  
S014773



AFL V-Groove Cleaning Kit  
S014397

**AFL SPLICER ACCESSORIES**

PART #	DESCRIPTION	PRICE
S017103	AFL ELCT2-16B Replacement Electrodes 31S/41S/90S/R (pair)	\$83.25
S013532	AFL Electrodes for 17S/18S/19S/50S/R/60S/R/70S/R (pair)	83.25
S017111	AFL FH-70-250 Fiber Holder(Pair)	273.00
S017113	FH-70-900 (900 μm jacketed fiber)	273.00
S017095	FH-70-160 (160 μm coated fiber)	273.00
S015181	FH-60-LT900 (Loose buffer 900 μm fiber)	273.00
S015275	FH-60-LT900 (each)	420.00
S014397	AFL Splicer V-Groove Cleaning Kit	142.00
S017528	DCC-21 Power Cord (connects AC Adapter to power source via alligator clips)	105.00
S017527	DCC-20 Power Cord (connects AC Adapter to cigarette lighter socket)	105.00
S014773	Portable Tripod Workstation	562.00
S010532	ASW-02 Splicing Workstation	1,150.00
S017522	JP-10 J-Plate (Cooling tray attaches to splicer)	315.00
S014012	FST-12 Fiber Separation Tool	1,239.00
S010212	FAT-04 Fiber Arrangement Tool	505.00
S017119	AFL FH-70-12 Fiber Holder SWR (Pair)	273.00
S017513	ADC-20 AC Adapter	210.00
S014536	ACC-14 AC Power Cord	21.00
S017512	BTR-15 Battery	346.50
S014696	FH-FC-20 (900 μm within 2.0 mm sheathing) (each)	276.00
S014695	FH-FC-30 (900 μm within 3.0 mm sheathing) (pair)	276.00
S014697	FH-FC-900 (900 μm cable) (each)	73.00
S014705	CLAMP-FC-2000 (pair)	16.80
S014704	CLAMP-FC-3000 (pair)	9.00
S015915	AFL FP-60 Protection Sleeve (60mm)	30.00
S015916	AFL FP-40 Protection Sleeve (40mm)	30.00
S017010	AD-50 Adapter Plate	52.50
S015862	AFL S70D Sheath Clamp (Loose tube)	147.00
S016853	AFL S21B Sheath Clamp (Loose tube)	147.00
S012996	One Year Extended Warranty (splicer specific)	Please call for pricing
S013000	Two Year Extended Warranty (splicer specific)	Please call for pricing

STAY COMPLIANT WITH INDUSTRY STANDARDS BY TAKING ADVANTAGE OF OUR FULL SERVICE CALIBRATION LAB.



All Verifications come with the following Service Features

- NIST traceable calibration
- Verification of conformance with the manufacturer's specification
- Ensure correct operation and performance
- All calibration and/or verification services include a NIST traceable calibration certificate

FOR MORE INFORMATION SEE PAGE 167



Visit us on our website at [www.fiberinstrumentsales.com/calibration/](http://www.fiberinstrumentsales.com/calibration/)



# AFL 3mm and 2mm FUSEConnect® Versions Available

## AFL FUSEConnect® 900µm / 2.0mm / 3.0mm

FUSEConnect® utilizes a fusion splicer to terminate a connector in the field, addressing return loss concerns present in analog optical networks. This advanced process yields true APC performance of >65dB return loss in an SC/APC configuration. Designed to work with an industry standard 10mm cleave length and splicers utilizing a fiber holder system, FuseConnect is compatible not only with Fujikura's fusion splicers, but also with most other industry available, fiber holder-based fusion splicing platforms. MPO Splice-On Connectors Available.



PART #	DESCRIPTION	PRICE - 6pack
FUSE-SC9SMU-6	AFL FuseConnect SC UPC SM 900um Blue (6pk)	\$80.75
FUSE-SC9SMA-6	AFL FuseConnect SC APC SM 900um Green (6pk)	82.00
FUSE-SC9M62-6	AFL FuseConnect SC PC MM 62.5um 900um Beige (6pk)	79.65
FUSE-SC9M50L-6	AFL FuseConnect SC MM 50um 10GIG OM3 900um Aqua (6pk)	79.65
FUSE-LC9SMU-6	AFL FuseConnect LC UPC SM 900um Blue (6pk)	85.75
FUSE-LC9SMA-6	AFL FuseConnect LC APC SM 900um Green (6pk)	80.00
FUSE-LC9M62-6	AFL FuseConnect LC PC MM 62.5um 900um Beige (6pk)	84.75
FUSE-LC9M50L-6	AFL FuseConnect LC MM 50um 10GIG OM3 900um Aqua (6pk)	84.75
FUSE-ST9SMU-6	AFL FuseConnect ST UPC SM 900um Blue (6pk)	83.00
FUSE-ST9M62-6	AFL FuseConnect ST PC MM 62.5um 900um Beige (6pk)	81.50
FUSE-ST9M50L-6	AFL FuseConnect ST MM 50um 10GIG OM3 900um Aqua (6pk)	81.50
FUSE-SC3SMA-6	SM, SC/APC, 3mm boot, Green	91.25
FUSE-SC3SMU-6	SM, SC/UPC, 3mm boot, Blue	89.95
FUSE-SC3M62-6	MM, 62.5µm, SC, 3mm boot, Beige	88.25
FUSE-SC3M50L-6	MM, 50µm, 10GIG, SC, 3mm boot, Aqua	88.85
FUSE-LC2SMA-6	SM, LC/APC, 2mm boot, Green	99.35
FUSE-LC2SMU-6	SM, LC/UPC, 2mm boot, Blue	94.95
FUSE-LC2M62-6	MM, 62.5µm, LC, 2mm boot, Beige	94.25
FUSE-LC2M50L-6	MM, 50µm, 10GIG, LC, 2mm boot, Aqua	94.25
FUSEMPO-SSMA-3-M-6	Singlemode (OS1), MPO Male (pins) for 3.0mm round boot	656.25
FUSEMPO-SSMA-3-F-6	Singlemode (OS1) MPO Female (No Pins) for 3.0mm round boot	620.00
FUSEMPO-SOM4-3-M-6	Multimode 50 µm 10Gig (OM3/4) MPO, Male (pins) for 3.0mm round boot	800.00
FUSEMPO-SOM4-3-F-6	Multimode 50 µm 10Gig (OM3/4) MPO, Female (no pins) for 3.0mm round boot	722.20
FUSEMPO-TL-KT	FUSEConnect MPO Tool Kit	524.60
FUSE-TL-KT	FuseConnect Toolkit	1,221.00



NOTE: Use AFL Splicers with Fiber Holders for FUSEConnect® and Installation kit is recommended for best performance

## SUMITOMO 3mm and 2mm LYNX2-PLUS Versions Available

## SUMITOMO LYNX2-PLUS

Sumitomo Electric Lightwave continues its tradition of innovation and customer focused, market driven product advancements with the release of the Lynx2-PLUS. Maintaining all of the quality standards of the Lynx2, the Lynx2-PLUS incorporates an enhanced installation procedure and smaller overall completed connector design. Compatible with all SC, LC, FC and ST style fiber optic connectors, Lynx2- PLUS offers revolutionary Real-Time, On-Site flexibility for quick MACs, repairs, and restorations for minimal downtime, while eliminating crimping tools, gels, splice trays, and the inventory of varying length pre-terminated jumpers — providing the industry's most cost effective, reliable, and advanced choice in fiber termination.

PART #	DESCRIPTION	PRICE
LYNX2-LCUPCSM-250900	LYNX2 Splice-On Connector, LCUPC SMF 250um & 900um	\$10.88
LYNX2-LCPCMS10G-250900	LYNX2 Splice-On Connector, LCPC MMF-50um 10GIG, 250um & 900um	11.25
LYNX2-LCAPCSM-250900	LYNX2 Splice-On Connector, LCAPC SMF 250um & 900um	11.86
LYNX2-SCUPCSM-250900	LYNX2 Splice-On Connector, SCUPC SMF 250um & 900um	10.75
LYNX2-SCAPCSM-250900	LYNX2 Splice-On Connector, SCAPC SMF 250um & 900um	12.46
LYNX2-SCPCMS10G-250900	LYNX2 Splice-On Connector, SCPC MMF-50um 10GIG, 250um & 900um	10.75
LYNX2-SCPCM6-250900	LYNX2 Splice-On Connector, SCPC MMF-62.5um, 250um & 900um	10.75
LYNX2-STUPCSM-250900	LYNX2 Splice-On Connector, STUPC SMF 250um & 900um	12.44
LYNX2-STPCMS10G-250900	LYNX2 Splice-On Connector, STPC MMF-50um 10GIG, 250um & 900um	12.44
LYNX2-STPCM6-250900	LYNX2 Splice-On Connector, STPC MMF-62.5um, 250um & 900um	12.44
LYNX2-SOCTK-400	LYNX2 SOC Installation Kit with Connectorizer	2,176.00
LYNX2-TKU-MPO-RCATK	Tool Kit for terminating Lynx2 MPO Round Cord Connectors	1,579.00
FA-03	Fiber Arrangement Tool for Lynx2 MPO	795.00
FAC-24	Consumables for Fiber Arrangement Tool	22.50
FAC-24-003-A	Adhesive for Fiber Arrangement Tool (Included in FAC-24)	9.50
LYNX2-MPO12F-MM03-RBN	LYNX2 MPO 12ct. Female, MMF OM3, Ribbon	66.50
LYNX2-MPO12F-MM03-RC3.0	LYNX2 MPO 12ct. Female, MMF OM3, Round Cord 3.0	73.00
LYNX2-MPO12F-SMSL-RBN	LYNX2 MPO 12ct. Female, SMF Standard Loss, Ribbon	67.50
LYNX2-MPO12F-SMSL-RC3.0	LYNX2 MPO 12ct. Female, SMF Standard Loss, Round Cord 3.0	73.00
LYNX2-MPO12M-MM03-RBC	LYNX2 MPO 12ct. Male, MMF OM3, Oval Jacket	79.47
LYNX2-MPO12M-MM03-RBN	LYNX2 MPO 12ct. Male, MMF OM3, Ribbon	77.26
LYNX2-MPO12M-SMSL-RBN	LYNX2 MPO 12ct. Male, SMF Standard Loss, Ribbon	71.00
LYNX2-MPO12M-SMSL-RC3.0	LYNX2 MPO 12ct. Male, SMF Standard Loss, Round Cord 3.0	77.26



## MPO Splice-On Connectors Available.



Sumitomo / FIS Splice-On Connector Compatible



TYPEQ102CA+

## SUMITOMO TYPE Q102-CA+ QUANTUM FUSION SPLICER KIT

The Quantum Type-Q102-CA+™ is Sumitomo Electric Lightwave's next generation of the industry leading Quantum core alignment fusion splicers, redesigned from the ground up to redefine the industry standard in optical fiber core alignment fusion technology. Maintaining all of the qualities and industry first features of the Quantum Type-Q101-CA, the TYPE-Q102-CA+ continues to raise the bar in performance by still being the fastest splicer with blazing fast 5 second splice and 9 second sleeve heating times. These new speeds, coupled with the splicer's patent protected dual independent ovens, makes it the fastest in the industry by far. The built-in dual heater system, with its unprecedented speed, improves splicing efficiency by over 80% for perfectly streamlined, consecutive, and cost effective splices.

### FEATURES

- Patented NanoTune™ technology offers an enhanced splicing experience
- Extended battery life capable of 320 splice/burn cycles
- High Speed Dual Independent Heaters
- Compatible with FIS Splice-On Connectors

PART #	DESCRIPTION	PRICE
TYPE-Q102-CAP-KIT-6RSC	<b>TYPE Q102-CA+ Quantum Fusion Splicer Kit includes</b> Precision Cleaver w/ Auto Rotating Blade (FC-6RS-C), Fiber Stripper (JR-M03), One Pack of Fiber Protection Sleeves, Shipping Case, one set of Spare Electrodes (ER-10), AC Interface/Battery Charger with Power Cord, Battery Unit (BU-102)	\$11,089.00
TYPE-Q102-CAP-KIT-6RSCFH	<b>TYPE Q102-CA+ Quantum Fusion Splicer Kit includes</b> 250um, 900um and Loose Buffer Fiber Holders, Precision Cleaver w/ Auto Rotating Blade (FC-6RS-C), Fiber Stripper (JR-M03), One Pack of Fiber Protection Sleeves, Shipping Case, one set of Spare Electrodes (ER-10), AC Interface/Battery Charger with Power Cord, Battery Unit (BU-102)	11,583.00
TYPE-Q102-CAP-KIT-8R	<b>TYPE Q102-CA+ Quantum Fusion Splicer Kit includes</b> Precision Cleaver w/ Auto Rotating Blade (FC-8R), Fiber Stripper (JR-M03), One Pack of Fiber Protection Sleeves, Shipping Case, one set of Spare Electrodes (ER-10), AC Interface/Battery Charger with Power Cord, Battery Unit (BU-102)	11,089.00
TYPE-Q102-CAP-KIT-8RFH	<b>TYPE Q102-CA+ Quantum Fusion Splicer Kit includes</b> 250um, 900um and Loose Buffer Fiber Holders, Precision Cleaver w/ Auto Rotating Blade (FC-8R), Fiber Stripper (JR-M03), One Pack of Fiber Protection Sleeves, Shipping Case, one set of Spare Electrodes (ER-10), AC Interface/Battery Charger with Power Cord, Battery Unit (BU-102)	11,562.00

## SUMITOMO TYPE Q102M12 QUANTUM COMPACT MASS FUSION SPLICER KIT

Sumitomo Electric Lightwave announces its newest addition to the industry-leading Quantum® Fusion Splicer portfolio. Sumitomo Electric's new Type-Q102-M12 is accompanied with new features and benefits capable of deploying next generation hyperscale networks.

Consistent and quality low-loss splicing, the compatibility with Lynx Custom-Fit® 2 Splice-On Connectors, and Sumitomo Electric's patented dual independent ovens make this fusion splicer a preferred choice for extensive and diverse optical fiber networks. The new ribbon fiber splicer is capable of handling 250um and 200um ecosystems and is accompanied by SEL's 24/7 fusion splicer technical support and a three-year warranty

### FEATURES

- Dual independent ovens for increased productivity
- Reduce your work time. Splicing: 11s Heating: 35s
- Active Auto Clamping Alignment System, or ACAS optimizes splice loss 0.05dB
- Touch optimized user interface and high resolution display



Q102M12

PART #	DESCRIPTION	PRICE
TYPE-Q102-M12-KIT-6RM1	<b>TYPE Q102-M12 Quantum Compact Mass Fusion Splicer Kit with Dual Built-in Heat Shrink Ovens, includes:</b> Mass Fiber Cleaver (FC-6RM- C), Heated Fiber Stripper (JR-6+), Splice Protection Sleeves (FPS-6 type), pair of 12-Fiber Holders(FHM-12), pair of 250um single fiber holders (FHS-025)	\$14,969.50
TYPE-Q102-M12-KIT-8RM1	<b>TYPE Q102-M12 Quantum Compact Mass Fusion Splicer Kit with Dual Built-in Heat Shrink Ovens, includes:</b> Mass Fiber Cleaver (FC-8R), Heated Fiber Stripper (JR-6+), Splice Protection Sleeves (FPS-6 type), pair of 12-Fiber Holders (FHM-12), pair of 250um single fiber holders (FHS-025)	15,159.55

Sumitomo's NanoTune™ enhances your splice experience by reducing your time spent working and reduces splicing loss overall, by using the World's first AI splicing technology.



**SUMITOMO Q502S ACTIVE CLAD ALIGNMENT FUSION SPLICER**

With new features and new technologies, the Q502S fusion splicer offers improved performance, reliability, and user experience. The Q502S series maintains Sumitomo Electric’s industry-leading features, including a world-class\*2 light and compact frame, quick splicing, and environmental durability.

**FEATURES**

- **NanoTune™** : The Q502S is powered by NanoTune™ AI technology, which greatly improves splicing efficiency and accuracy regardless of operational condition and user skill.
- **Hot Core Analyzing** : The Q502S provides accurate estimated loss by analyzing the fiber image through high-quality microscopes during splicing.
- **Detection of MMF and SMF fiber types** : As a world first, the Q502S introduces a fiber type detection function – allowing the Q502S to distinguish between MMF and SMF fiber types and ensure use of the correct splice program



QH201E-VS

PART #	DESCRIPTION	PRICE
TYPE-Q502S-KIT-2H	<b>TYPE-Q502S Quantum Fusion Splicer Kit includes</b> Fiber Cleaver (FC-6S), 250um and 900um Fiber Holders, Fiber Stripper (JR-M03), One Pack of Fiber Protection Sleeves, Hard Shipping Case, one set of Spare Electrodes (ER-17), AC Interface/Battery Charger with Power Cord, Battery Unit (BU-17), Cleaning Kit (FUS-CLN-KIT)	\$3,579.00
TYPE-Q502S-KIT-8RH	<b>TYPE-Q502S Quantum Fusion Splicer Kit includes</b> 250um and 900um Fiber Holders, Precision Cleaver w/ Auto Rotating Blade (FC-8R), Fiber Stripper (JR-M03), One Pack of Fiber Protection Sleeves, Hard Shipping Case, set of Spare Electrodes (ER-17), AC Interface/Battery Charger with Power Cord, Battery Unit (BU-17), Cleaning Kit (FUS-CLN-KIT)	\$3,946.00

**SUMITOMO TYPE 56 FUSION SPLICE KIT W/ AUTO PRECISION CLEAVER**

PART #	DESCRIPTION	PRICE
TYPE56CAKIT6RSC	<b>TYPE-56 Fusion Splicer Kit includes:</b> FC-6-RS-C Auto Rotating Cleaver, Fiber Stripper (JR-M03), One Pack of Fiber Protection Sleeves, Shipping Case, one set of Spare Electrodes (ER-10), AC Interface/Battery Charger with Power Cord, Battery Unit (BU-101)	\$7,265.00
TYPE56CAKIT8R	<b>TYPE-56 Fusion Splicer Kit includes:</b> FC-8R Auto Rotating Cleaver, Fiber Stripper (JR-M03), One Pack of Fiber Protection Sleeves, Shipping Case, one set of Spare Electrodes (ER-10), AC Interface/Battery Charger with Power Cord, Battery Unit (BU-101)	7,265.00



TYPE-56

**SUMITOMO TYPE-400S ACTIVE CLAD-ALIGN FUSION SPLICER KIT**

**FEATURES**

- Carry out your mission as fast as possible
- All the FTx fiber splices in one machine
- Simple operation by brand-new user interface

PART #	DESCRIPTION	PRICE
TYPE-400S-ACA-KIT-6RSFH	<b>TYPE-400S Active Clad-Align Splicer Kit includes:</b> Fiber Cleaver with Auto-rotating Blade (FC-6RS-C), Jacket Remover (JR-M03), Fiber Protection Sleeves, Battery Unit, Power Cord & AC Adapter, Shipping Case & Cleaning Kit, PLUS 250um, 900um and Loose Buffer Fiber Holders	\$3,206.00
TYPE-400S-ACA-KIT-8RFH	<b>TYPE-400S Active Clad-Align Splicer Kit includes:</b> Fiber Cleaver with Auto-rotating Blade (FC-8R), Jacket Remover (JR-M03), Fiber Protection Sleeves, Battery Unit, Power Cord & AC Adapter, Shipping Case & Cleaning Kit, PLUS 250um, 900um and Loose Buffer Fiber Holders	3,426.00



TYPE-400S

**SUMITOMO ACCESSORIES**

PART #	DESCRIPTION	PRICE
ER-17	Sumitomo Replacement Electrodes for Q502 fusion splicer	\$100.00
ER10	Sumitomo Electrodes for Sumitomo Splicer (pair)	100.00
ER11	Sumitomo Electrode for QH201e Splicer (pair)	100.00
FHS09	Sumitomo Fiber Holders for 900um Single Fiber (Pair)	300.00
FHS025	Sumitomo Fiber Holder for 250um Single Fiber (Pair)	300.00
FHS025LB5L	Sumitomo Fiber Holder for 900um LT Fiber. Left side	250.00

**Compatible with Sumitomo & FIS Splice-On Connectors**

**FITEL**

FITEL / FIS  
Splice-On  
Connector  
Compatible



S179A  
Fusion Splicer

**FITEL S179A SPLICER**

The powerful FITEL S179 Hand-Held, Core Alignment Fusion Splicer delivers fast and reliable optical fiber splicing even under harsh environmental conditions. Offering a wide range of capabilities, this fusion splicing machine opens the door to an entirely new range of applications.

**FEATURES**

- Fast and consistent fiber splicing for exceptional performance
- NEW design features enhance ease of use, maintenance, speed and shock resistance
- Large capacity, internal battery charging system allows 200 splicing cycles (splicing/heating) in one charge
- Wide splicing chamber for easy fiber loading
- Lower profile, lighter weight design enhances portability
- Powerful, high-propulsion motor (8N) for stable splicing
- Perfect for use with Splice-On Connectors

**S179 Extended Kit Includes:** (S179A-EX-900 ) S179A Main Body, 250µm and 900µm Fiber Holders, AC Adapter for S179A, Spare Electrodes, Hard Carrying Case, Cleaning Brush, Electrode Cleaning Disc, Fiber Stripper, Two Batteries, Cleaning Fluid, Fiber Wipes and User Manual.

PART #	DESCRIPTION	PRICE
S179A-EX-10	Extended Kit with 10mm Clamps	\$9,300.00
S179A-EX-900	Extended Kit with 250µm and 900µm Fiber Holders	9,480.00
F1-SOCSLAF2	Cheetah Splice-On Connector Holder	100.00

**FITEL**



S124M12  
Fusion Splicer

**FITEL S124M12**

OFS/Fitel S124 Mass Ribbon splicer is the newest addition to the Fitel splicer offering. With the contractor in mind, additional lighting, larger splicer platform, and 1.96 Newton motor strength to move even the heaviest of cables. Fitel offers removable holders which allows the splicing of 1-12 fibers with ease, with the options of both 250um and 200um pitch V-grooves

**FEATURES**

- High speed operation of 15 seconds fusion splicing and 17 seconds heat reinforcement
- Fiber Curl Removal Function
- Easy exchange of different diameter fiber and different pitch V grooves
- Easy operation with touch panel and GUI mounting
- Easy maintenance with removable V-groove
- Wireless communication function using Wi-Fi

**S124M12 Standard Kit Includes:** S124M12 Main Body (including battery, Hard Carrying Case, Spare Electrodes, AC Adapter, AC Cord, Electrode Sharpener, Cleaning Brush, User Manual, S712A-12e - 12 Fiber Holder and Thermal Ribbon Stripper.

PART #	DESCRIPTION	PRICE
S124M12KIT	S124M12 Standard Kit	\$13,780.00
S712S-250	Fiber holder (0.25mm coating fiber) 1 pair	300.00
S712S-900	Fiber holder (0.90mm coating fiber) 1 pair	300.00
S712A-002	Fiber holder (2 fiber ribbon) 1 pair	450.00
S712A-004e	Fiber holder (4 fiber ribbon) 1 pair	450.00
S712A-006	Fiber holder (6 fiber ribbon) 1 pair	600.00
S712A-008e	Fiber holder (8 fiber ribbon) 1 pair	450.00
S712A-12e	Fiber holder (12 fiber ribbon) 1 pair	450.00

**fis**

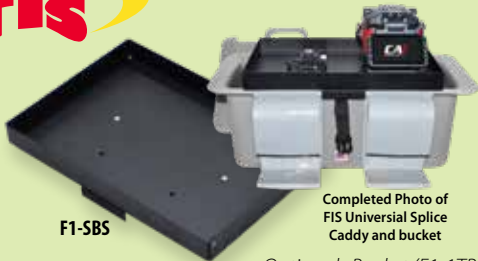

F1-SBS

Completed Photo of  
FIS Universal Splice  
Caddy and bucket

Optional : Bucket (F1-1TBSC)

**FIS UNIVERSAL SPLICE CADDY**

The FIS Universal Splice Caddy is designed to securely fasten any fusion splicer and cleaver for aerial splice jobs. The Universal Splice Caddy easily attaches to FIS' Tool Bucket(F1-1TBSC) which provides technicians with a stable workstation for easy cable transition to both the cleaver and splicer. **Compatible with the FIS, FITEL, AFL and Sumitomo fusion splicers and cleavers.** **Kit Contents:** (1) FIS Universal Splice Caddy (F1-SBS), (2) Plugs included to cover open screw holes, (2) 16mm L Thumb Screw, (1) 8mm L Thumb Screw, (1) Accessory tray (For fiber optic cleaning solution and tools)

PART #	DESCRIPTION	PRICE
F1-SBS	Aerial Fusion Splicer Workstation (Fits up to 3" Bucket Lip)	\$79.00
F1-1TBSC	Workstation Bucket	160.00

**FIS BUCKET BUDDY**

Technicians are faced with the challenge of securing the splicer or test equipment in a manner that facilitates a safe and easy fiber optic splice. The Bucket Buddy is unique in that its shape allows it to easily slide over the "lip" of the bucket on basically any aerial bucket truck. It will remain in place, attached securely to the bucket itself, to provide technicians a workstation attached to the bucket where they can perform fiber splices, tests, or terminate drops.



F1-AERIALBB

PART #	DESCRIPTION	PRICE
F1-AERIALBB	Aerial Fusion Splicer Workstation (Fits up to 3" Bucket Lip)	\$535.00

**FITEL NINJA SPLICER**

The FITEL NINJA NJ001 Hand-Held Single Fiber Fusion Splicer is applicable for all METRO, LAN and FTx fibers including ultra bend-insensitive fibers. With its low-profile, compact, ruggedized body, the NJ001 offers reliable splicing under severe environmental conditions. The large battery capacity makes it possible to perform 100 cycles of splicing and heating. Combining portability, power flexibility and field ruggedness, the NJ001 delivers fast and consistent splicing with outstanding mobility and maximum ease of use.

**FEATURES**

- 3 LED Lamps
- Ruggedized design
- Internal battery charging
- Easy maintenance
- PC interface software
- Auto-start function
- 100 cycles (Splicing and Heating)
- Powerful, high-propulsion motor (8N) for stable splicing
- Perfect for use with Splice-On Connectors

**NJ001 Standard Kit Includes:** NJ001 Main Body including battery, Hard Carrying Case, Spare Electrodes, AC Adapter, AC Cord, Electrode Sharpener, Cleaning Brush, User Manual, Cheetah SOC Holder and Quick Reference Guide (the packaged quick reference guide depends on the holder type)

PART #	DESCRIPTION	PRICE
NJ001-3-EX-10-V1	Extended Kit with 10mm Clamps	\$3,120.00
NJ001-3-EX-900-V1	Extended Kit with 250µm and 900µm Fiber Holders	3,360.00
F1-SOCSLAF2	Cheetah Splice-On Connector Holder	100.00

**FITEL EZ!FUSE**

OFS's new Splice On Connector termination system allows for easy termination and flexibility in the field. This new "splice-on" connector (SOC) eliminates the need for field polishing and significantly improves the quality of the termination and installation time required. The connector is easily assembled by using a process that requires minimal skill or training. These connectors are optimal for use in FTx applications. Both UPC and APC polish are available for single-mode fiber. EZ!Fuse Splice On Connector is compatible with the Fitel Fusion Splicer models Ninja, S179 and S178.

**2mm/3mm (only available in 10-packs)**

PART #	DESCRIPTION	PRICE
FSOC-SC09-SM-U	SC/UPC SM SOC 900um (10 pack)	94.00 / 10pk.
FSOC-SC23-SM-U	SC/UPC SM SOC 2.0mm/3.0mm (10 pack)	108.00 / 10pk.
FSOC-SC09-SM-A	SC/APC SM SOC 900um (10 pack)	94.00 / 10pk.
FSOC-SC23-SM-A	SC/APC SM SOC 2.0mm/3.0mm (10 pack)	108.00 / 10pk.
FSOC-SC09-M3-P	SC/PC OM3 MM SOC 900um (10 pack)	94.00 / 10pk.
FSOC-SC23-M3-P	SC/PC OM3 MM SOC 2.0mm/3.0mm (10 pack)	108.00 / 10pk.
FSOC-SC09-M1-P	SC/PC OM1 MM SOC 900um (10 pack)	94.00 / 10pk.
FSOC-SC23-M1-P	SC/PC OM1 MM SOC 2.0mm/3.0mm (10 pack)	108.00 / 10pk.
FSOC-LC09-SM-U	LC/UPC SM SOC 900um (10 pack)	102.00 / 10pk.
FSOC-LC20-SM-U	LC/UPC SM SOC 2.0mm (10 pack)	105.60 / 10pk.
FSOC-LC09-SM-A	LC/APC SM SOC 900um (10 pack)	102.00 / 10pk.
FSOC-LC20-SM-A	LC/APC SM SOC 2.0mm (10 pack)	116.65 / 10pk.
FSOC-LC09-M3-P	LC/PC OM3 MM SOC 900um (10 pack)	102.00 / 10pk.
FSOC-LC20-M3-P	LC/PC OM3 MM SOC 2.0mm (10 pack)	116.65 / 10pk.
FSOC-LC09-M1-P	LC/PC OM1 MM SOC 900um (10 pack)	116.65 / 10pk.
FSOC-LC20-M1-P	LC/PC OM1 MM SOC 2.0mm (10 pack)	116.65 / 10pk.

**FITEL**



**NJ001 Fusion Splicer**

**FITEL / FIS Splice-On Connector Compatible**

**FEATURES**

- Simple, Fast, and Consistent Field Termination
- Applicable for Interconnection Needing High Reliability
- Complies with Telcordia GR-326-CORE



**U-TECK**

**Fiber Optic Splicing Workstation**

The U-TECK Fiber Optic Splicing Workstation was designed for, and dedicated to, today's professional fiber splicer.

The NEW Workstation offers twice the work space area compared to standard use tables, yet is light-weight and easy to store! The table top even has a molded recess area to keep items from falling. Also molded into the outside frame of the table are several recess areas that can be used to securely hold alcohol, wipes and fiber splicing sleeves.

**U-TECK WORKSTATION**

PART #	DESCRIPTION	PRICE
F1-55701	Workstation w/ cable management bracket (includes floor stand and two stand-off props with adjustable webbing )	\$450.00
F1-55706	Workstation w/ cable management bracket and floor stand only	220.00

**U-TECK WORKSTATION ACCESSORIES**

PART #	DESCRIPTION	PRICE
F1-55715	Aerial Strand Cables	\$90.00
F1-55615	LED Light and Magnifier	97.50
F1-55710	Mesh Bag	58.95
F1-55725	Splice Tray Holder	72.95
F1-55720	Tablet Holder	128.00
F1-55730	Cable Management Bracket	10.75
F1-55711	Wall Stand-offs	215.00



AERIAL STRAND CABLES



LED LIGHT AND MAGNIFIER



MESH BAG



SPLICE TRAY HOLDER



TABLET HOLDER



CABLE MANAGEMENT BRACKET



WALL STAND OFFS



F1-LYNX



F1-LYNX2000



F1-LYNX3000



## FIS LYNX™ PRECISION CLEAVER

The LYNX provides clean, accurate cleaves required for fusion splicing. LYNX is also ideal for preparing fiber for quick-term style connectors such as Bobtails, UNICAMS and other pre-polished connectors. LYNX features a cleave angle of 90 degrees +/- 0.5 degrees. Its 16-position blade provides approximately 48,000 cleaves. LYNX cleaves single fibers (250-900µm). The LYNX Precision Cleaver can be used alone or mounted to an optional work tray that includes a goose neck LED (F1LYNXBASE).

PART #	DESCRIPTION	PRICE
F1-LYNX	LYNX Precision Cleaver - 3 Step Precision Cleaver	\$595.00
F1-LYNX2000	LYNX One-Step Deluxe Lynx Cleaver	750.00
F1-LYNX3000	LYNX One-Step Premium cleaver with Auto-Rotating blade	920.00
F1-LYNXBLADE	LYNX Replacement Blade	95.00
F1LYNXBASE	LYNX Cleaver Work Tray With Gooseneck LED Light	69.95

## AFL CLEAVERS

The CT-50 Cleaver sets the standard for portability, reliability and ease of use. Available for either single fiber or ribbon splicing (up to 12 fiber ribbons) applications. The rugged, yet scaled-down design of the CT-08 cleaver offers cleave quality approaching that of the more expensive high precision cleavers but at a more economical price. The 16-position blade in each cleaver offers long life and performs cleaving in one single step. Each cleaver comes installed with a fixed adapter AD-50 adapter plate to hold your 250um and 900um fiber, with an additional AD-10-M24 fixed adapter plate needed for ribbon fiber (CT-50 only).



CT-08

PART #	DESCRIPTION	PRICE
S017030	CT-50 Cleaver, Single & up to 12 Fiber Ribbon	\$1,090.00
S017004	CT-08 Cleaver, Single Fiber	610.00
S017013	Replacement Blade for CT-08 Cleaver	83.25
S017076	Replacement Blade for CT-50 Cleaver	105.00
S017010	AD-50 Adapter Plate for both CT-08 and CT-50 (Single Fiber)	52.50
S017335	AD-10-M24 Fiber Plate for CT50 (Ribbon Fiber Cleaving)	84.00

## FITEL PRECISION CLEAVER

The Fitel S326A precision cleaver solves the dilemma of stray fibers with a unique disposal system incorporated into the design. The automatic cleave function provides constant cleaving pressure and improves cleave quality. The cutting blade locks into place after scoring, preventing double scoring. Also can be used to cleave ribbon fiber.



S326A

PART #	DESCRIPTION	PRICE
S326A	S326A Cleaver, Single & up to 12 Fiber Ribbon	\$680.00
S326X24	Replacement Blade	130.00
S712CSGC9R	Cordage Holder for 3mm	375.00

## SUMITOMO PRECISION CLEAVERS

With the introduction of the FC-6R, you now can have the ultimate precision tool for your single and mass/multiple fiber cleaving with a rotating blade. As part of the FC-6 family of precision fiber cleavers, it is a simple operation for the user to remove or install the single fiber adapter and alternate between mass and single fiber cleaving. The FC-8R is Sumitomo Electric Lightwave's newest 1-Step optical fiber cleaver with automatic blade rotation and a digital cleave counter. It is the ideal tool for use in fusion splicing, field termination, or any application that requires precision in a confined space. It has a simple cleaving operation that can be performed in the palm of the hand, allowing the user to take the cleaver to fiber in limited slack or cramped applications. A built-in extra large fiber scrap collector handles scrap fibers resulting from the cleaving process.



FC-8R

PART #	DESCRIPTION	PRICE
FC6RSC	Sumitomo Precision Optical Fiber Cleaver for single fiber cleaving with auto rotating/adjusting cleaver blade & fiber catcher	\$1,195.00
FC6RMC	Sumitomo Precision Optical Fiber Cleaver for single & mass fiber cleaving w/auto rotating/adjusting cleaver blade & fiber catcher	1,350.00
FC8R	Sumitomo Precision Optical Fiber Cleaver for single & mass fiber cleaving w/auto rotating/adjusting cleaver blade & fiber catcher	1,350.00
FCP7RBL	Sumitomo Replacement Blade for FC8R/7R/6R Auto-Rotating Models	195.00
FCPBL	Sumitomo Replacement Blade for FC6S/FCP Style Cleavers	155.00

**FIELD CLEAVERS**

This field or "beaver" cleaver is suitable for use with quick-term connectors and optimal for mechanical splicing. Each cleaver provides a guide for variable cleave lengths from 5-20mm. The blades will perform over 6,000 cleaves before replacement is necessary. The score and snap function is easy to use and preferred by many installers. **Note: No Export Available for F1-0010 and CL008.**

PART #	DESCRIPTION	PRICE
F1-6000	FIS Cleaver	\$139.00
F1-0010	FITEL Cleaver	198.00
S315X02	Replacement Leaf Spring <b>Suitable for both cleavers</b>	61.85
F1-60CBL	FIS Replacement Blade (Carbide) <b>Suitable for both cleavers</b>	35.00
F1-60DBL	FIS Replacement Blade (Diamond)	60.00
CL008	FITEL Replacement Blade (Carbide) <b>Suitable for both cleavers</b>	60.00



**AFL THERMAL STRIPPERS**

The RS01, RS02, RS03 and RS03-80 Thermal Strippers provide superior stripping performance for both single and multi-fiber stripping. The fast heating time of 3 seconds speeds productivity. The ergonomic design, combined with the low level of force needed for stripping, makes the RS series comfortable and easy to use for high fiber count applications. The strippers are also capable of stripping 200 µm coated fibers and ribbons. An audible beep and illuminated LED signal indicate that the proper heating temperature has been reached. A temperature selection switch permits easy field optimization for different fibers or operating conditions. These strippers accept all Fujikura field and factory style fiber holders. Bluetooth® capabilities on the RS02 and RS03 models provide a convenient way to program the stripper for user preferences via an Android or iOS smartphone app. The RS03 model includes a powerful Lithium-Ion battery that delivers enough power for 600 stripping cycles. The RS03-80 is offered for stripping 80 µm cladding fiber applications.

PART #	DESCRIPTION	PRICE
S016815	RS01 Thermal Stripper, Strips 200um to 400um coatings	\$647.50
S016816	RS02 Thermal Stripper, Strips 200um to 400um coatings, Bluetooth Capable (no extra charge)	647.50
S016817	RS03 Thermal Stripper, Strips 200um to 400um coatings, Bluetooth Capable, Rechargeable Lithium-Ion Battery	1,750.00
S016820	ADC-09A AC Adapter for RS Series strippers	92.50
S014390	ACC-09 Power Cord	18.00
S016832	BTR-12 Battery	111.00



**FIS FIBER OPTIC THERMAL STRIPPER**

The FIS family of fiber optic thermal strippers provide exceptional value and they are easy to use. Controlled heat is applied to the coated fibers to soften the acrylate coating, making it easier to strip the optical fibers. 40um – 1000um single fiber.

PART #	DESCRIPTION	PRICE
TSAB-40	Thermal Stripper Adjustable Blade	\$2,627.50
TSFB-125	Thermal Stripper Fixed Blade	2,415.00
TSPE-125	Platform, Ericsson	196.00
TSPF-125	Platform, FITEL	196.00

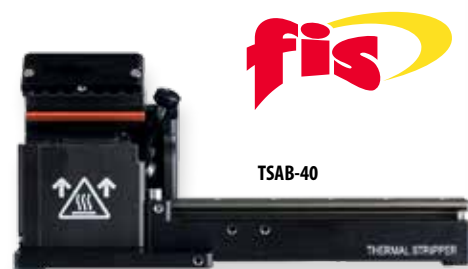

**FITEL HOT JACKET RIBBON STRIPPER**

The Fitel Hot Ribbon Stripper applies controlled heat to fibers/ribbons during stripping to reduce stripping force required and prevent fiber damage. Heats up in 13 sec. Includes Batteries, AC/DC Adapter. Fiber Holders not included. 250um to 900um.

PART #	DESCRIPTION	PRICE
S218-R-PLUS	Fitel Hot Ribbon Stripper (fiber holders not included)(250um flat and Rollable Ribbon fiber)	\$1,500.00
S218X-03	Single Fiber Adapter (For Use without Holders)	195.00
S712A12E	OFS Fitel 12-Rollable Ribbon Fiber Holders for S123M12	450.00



**SUMITOMO GLUELESS FIBER ARRANGMENT TOOL**

Sumitomo Electric Lightwave's compact OFA-01 quickly and effortlessly arranges single fibers into ribbons for mass fiber splicing, all without the use of adhesives, drastically reducing ribbon preparation time by eliminating adhesive curing time. The OFA-01 fiber arrangement tool offers the versatility of utilizing 250um or 200um fibers and is compatible with Sumitomo Electric's elite Ribbon Fiber Fusion Splicers.

PART #	DESCRIPTION	PRICE
OFA-01	Sumitomo Glueless Fiber Arrangement Tool	\$485.00

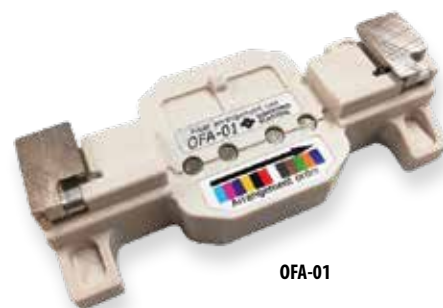

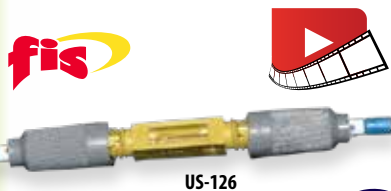

## FIS ULTRASPLICE

The ULTRASplice® is a high performance, easy to install reusable mechanical splice. It accepts fiber buffer sizes from 250µm-900µm. The average loss is .2dB with a fiber retention of over 2 lbs. Cleave, insert the fibers and secure by twisting a locking nut. US-126 is IBM #33G8228. Meets and exceeds Telcordia specifications.

PART #	DESCRIPTION	PRICE
US-126	Singlemode / Multimode Universal ULTRASplice®	\$7.95



## FIS LOCK JAW

With a self-gripping clamshell design this unique splice allows users to achieve a superior pull strength of 1.5 lbs by simply using super glue. Its design allows use in several splice trays, accepts 125µm clad Singlemode or Multimode with a typical loss of .2dB. Also available in the FIS Mechanical Splice Kit.

PART #	DESCRIPTION	PRICE
F1-MC125	Splice for 125µm Clad Fiber, SM or MM	\$2.95
F1-MC125SK	Splice Kit - (6) splices, cleaver, adhesive, cleaner and strip tool (See page 62)	149.00

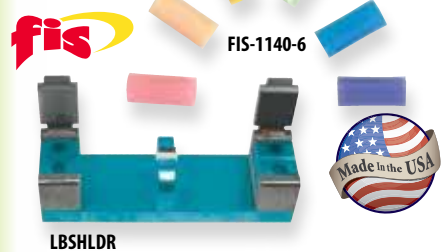

## ELASTOMERIC LAB SPLICE

The improved FIS Elastomeric Lab Splice is ideal for making temporary fiber connections and can be reused hundreds of times. To use the splice for instrument testing, simply insert a cleaved pigtail from OTDR or Power Meter and the cleaved unconnectorized fiber to be tested. Excellent for both Multimode and Singlemode fiber, the splice accepts fiber cladding diameters of 125µm to 140µm. The Lab Splices are supplied in blister packs of 6 (containing one of each color: pink, peach, yellow, green, blue and purple) or 12 (containing 2 of each color.)

PART #	DESCRIPTION	PRICE
FIS-1140-6	Pack of 6	\$11.25
FIS-1140-12	Pack of 12	16.95
LBSHLDR	Holder	200.00

CORNING



## CORNING FIBRLOK II

The Fiblok has an insertion loss <.2dB with a fiber retention of >7.75 lbs. Known for low reflection characteristics of -35dB. Using V groove technology, it requires no epoxy. Uses Fiblok assembly tool 2501. Splice completed in 30 seconds after preparing fiber ends. Thermal stability of -40°C to 80°C. Now Fibloks fit 250-900µm buffer sizes. **Note: 2539 does not require 2501 tool for assembly.**

PART #	DESCRIPTION	PRICE
2529	FIBRLOK II (250µm or 900µm)	\$8.50
2501	Assembly Tool (For use with 2529)	71.25
2539	Splice and Holder with Built-in Actuator Tool (250µm or 900µm)	13.25

CORNING



## CAMSPlice

This easy to install one size fits all mechanical splice features "Cam" locking mechanism, which requires no adhesive. The CamSplice incorporates a unique alignment method that self centers fibers, providing accurate alignment. Splice losses of less than 0.5dB are consistently achievable. Fits 250/250µm, 250/900µm and 900/900µm.

PART #	DESCRIPTION	PRICE
95-000-04	Camsplice	\$22.95
2104040-01	Assembly Fixture	280.00



## MECHANICAL SPLICE PROTECTION HOUSING

Available from FIS is a metallic protection sleeve that slips over mechanical splices for rugged protection. Install the tube and supplied shrink tubes onto the cable before installation and apply a heat source to fix housing into position. Accepts 95-000-04, US126, 2529, F1-MC125 splices offered above.

PART #	DESCRIPTION	PRICE
F1-1002M	Protection Housing	\$4.35

## FIS Introductory Fiber Optic Splice Kit

This kit provides the ability to perform emergency repairs on communication fiber. Kit instructions provide step by step practice exercises and actual final protected splices required for field repair. All contents may be purchased separately.

PART #	DESCRIPTION	PRICE
F1FOSK	Introductory Fiber Optic Splice Kit	\$149.00

### Kit Contents

- (1) Visual Fault Locator
- (6) Mechanical Splices
- (1) Quick Curing Adhesive
- (1) Soft Case
- (1) Fiber Cleaver
- (2) Splice Protection Kit
- (6) Alcohol Wipes
- (1) Cable Strippers
- (25') Simplex Cable
- (1) Instructions







**ULTRASLEEVE® PROTECTION SLEEVE**

Simply load the fused fiber and close the sleeve. No heat shrink curing, crimping or gluing. Ultrasleeve® features an acrylic foam tape, which seals the sleeve and protects from damage. The Ultrasleeve® splice protector can be closed by hand and is installed after the splice is completed.

PART #	DESCRIPTION	PRICE
F1-FS60	60mm Splice Protection Sleeve	\$2.95

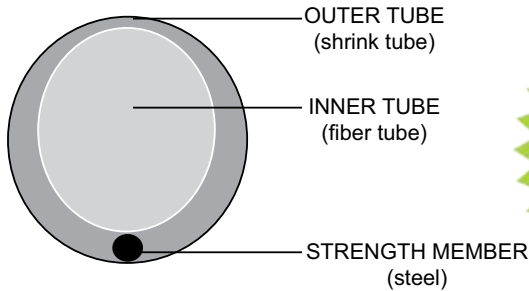

**FUSION SPLICE PROTECTION SLEEVES**

**STANDARD SLEEVE – (3.0mm AFTER SHRINK)**

This sleeve design represents the industry's most reliable, highest quality sleeve at an economical price. Standard lengths include 60mm and 40mm. Sleeves come standard with a clear outer tube for viewing the color of the fiber itself.

PART #	DESCRIPTION	1-9	10+
F1-1002C-50	60mm, 50 pk (Clear)	\$10.50	\$9.45
F1-100240C-50	40mm, 50 pk (Clear)	10.50	9.45
F1-1002RC-50	60mm, 50 pk (Red)	10.50	9.45

**SLIM SLEEVE – (2.5mm AFTER SHRINK)**

These clear protection sleeves use reduced diameter components for a smaller finished product. The smaller diameter allows users to fit more splices into existing splice trays.

PART #	DESCRIPTION	1-9	10+
F1-S25C-50	60mm, 50 pk (Clear)	\$10.50	\$9.45
F1-S2540C-50	40mm, 50 pk (Clear)	10.50	9.45

**TAPERED SLEEVE – (3.0mm AFTER SHRINK)**

This sleeve offers tapered ends designed to keep the metal strength member in proper position while in use. Available in 60mm and 40mm lengths.

PART #	DESCRIPTION	1-9	10+
F1-1002T-50	60mm, 50 pk (Clear)	\$10.50	\$9.45
F1-100240T-50	40mm, 50 pk (Clear)	10.50	9.45

**MICRO SLEEVE (1.5mm After Shrink) & MINI SLEEVE (2.0mm After Shrink)**

Designed to fit in smaller areas for splice storage are the Mini and Micro Protection Sleeves. Micro Sleeves will only accommodate 250µm coated fibers. Mini Sleeves will accommodate 900µm or 250µm coated fibers.

PART #	DESCRIPTION	1-9	10+
MCRO140CFD-50	Micro 40mm, 50 pk (Clear)	\$10.50	\$9.45
MCRO125CFD-50	Micro 25mm, 50 pk (Clear)	10.50	9.45
MINI140CDS-50	Mini 40mm, 50 pk (Clear)	\$10.50	\$9.45
MINI125CDS-50	Mini 25mm, 50 pk (Clear)	10.50	9.45

**RIBBON SPLICE PROTECTION SLEEVE**

FIS now offers a high quality ribbon splice sleeve that the contractor needs. With Durable Ceramic Reinforcement Rods with Rounded and Polished Edges and Full Length Strength Member for Total Fiber Support, the FIS F110011CPSR-25 meet and exceed Telcordia Standard TA-NWT-001380 and is RoHS compliant

PART #	DESCRIPTION	1-9	10+
F11011CPSR-25	FIS 25 pack Ribbon fusion splice sleeves 40mm with a glass ceramic strength member.	\$30.00	\$26.00

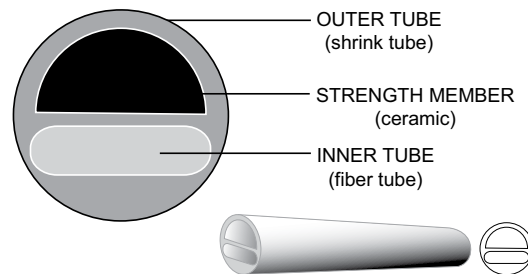

**DIELECTRIC SPLICE PROTECTION SLEEVE – (3.0mm After Shrink)**

Our Dielectric sleeves are manufactured with a non-metallic strength member for the ultimate in corrosion and electrical resistance.

PART #	DESCRIPTION	1-9	10+
F1-DE60-50	60mm, Clear	\$14.50	\$13.00
F1-DE40-50	40mm, Clear	14.50	13.00



**SPLICE SLEEVE SPATULA**

The splice sleeve spatula is the perfect tool to aid in removing stubborn splice sleeves from splice protection chips. This tool provides adequate leverage and a wide flat surface to gently loosen any splice protection sleeve, without damage.

PART #	DESCRIPTION	PRICING
10033301	FIS Splice Sleeve Spatula	\$8.95



The FIS Rack Mount Enclosures are designed for low or high density patching applications. These sturdy 14 gauge rack enclosures are available in 1, 2, 4, and 8RU versions. The FIS Enclosures accommodate 19" or 23" racks. Purchase 6, 8, 12 or 24 port adapter panels. Standard color is Black, simply attach suffix to Rack Mount Enclosures for Off-White (-BW), ex. F1RM1RU3X-BW. All adapter plates are sold separately. Ask us to quote your rack mount loaded with adapter plates, splice trays, pigtails and patch cords.



### FIS Rack Mount Fiber Optic Swing-Out Patch Panels



F1-RMS01RU2X



F1-RMS02RU4X

Closed

#### 1RU SWING-OUT PATCH PANEL - ACCOMMODATES (2) ADAPTER PLATES

The 1RU FIS Swing Out Patch Panel accommodates (2) LGX adapter plates, modules or cassettes. The swing-out design offers easy access to the patch and splice bay. Multiple cable retention brackets and tie down spots allow for convenient cable management. These units can be flush mounted or mounted with 3.5" protrusion from the rack with no additional accessories. Rack mount installs into a standard 19" rack with included mounting hardware. Adapter plates and 23" mounting brackets are sold separately.

PART #	DESCRIPTION	(HxWxD)	PRICE
F1-RMS01RU2X	1RU Swing Out Enclosure, 2 Plates, Black, Unloaded	1.75" x 17" x 11.5"	\$94.00
F1-RMS01RU2X-BW	1RU Swing Out Enclosure, 2 Plates, OffWhite, Unloaded	1.75" x 17" x 11.5"	94.00

#### 2RU SWING-OUT PATCH PANEL - ACCOMMODATES (4) ADAPTER PLATES

The 2RU FIS Swing Out Patch Panel accommodates (4) LGX adapter plates, modules or cassettes. The swing-out design offers easy access to the patch and splice bay. Multiple cable retention brackets and tie down spots allow for convenient cable management. These units can be flush mounted or mounted with 3.5" protrusion from the rack with no additional accessories. Rack mount installs into a standard 19" rack with included mounting hardware. Adapter plates and 23" mounting brackets are sold separately.

PART #	DESCRIPTION	(HxWxD)	PRICE
F1-RMS02RU4X	2RU Swing Out Enclosure, 4 Plates, Black, Unloaded	3.5" x 17" x 11.5"	\$110.00
F1-RMS02RU4X-BW	2RU Swing Out Enclosure, 4 Plates, OffWhite, Unloaded	3.5" x 17" x 11.5"	110.00

### FIS Rack Mount Fiber Optic Flush Mount Patch Panel Frame



F1-FM1RU3X

Loaded  
(Panels & Cassettes sold separately)

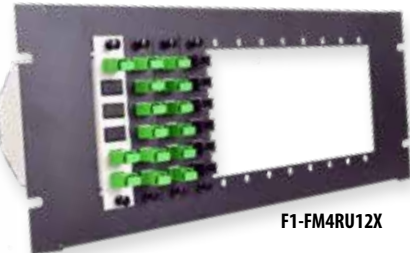

F1-FM4RU12X

#### 1RU FLUSH MOUNT PATCH PANEL FRAME - ACCOMMODATES (3) ADAPTER PLATES

The 1RU FIS Flush Mount Patch Panel Frame accommodates (3) LGX adapter plates, modules or cassettes. The flush mount design attaches flat against the rack to save space in compact applications. Patch panel frame installs into a standard 19" rack with included mounting hardware. Adapter plates sold separately.

PART #	DESCRIPTION	(HxW)	PRICE
F1-FM1RU3X	1RU Flush Mount Frame, 3 Plates, 19", Black, Unloaded	1.75" x 19"	\$20.00

#### 4RU FLUSH MOUNT PATCH PANEL FRAME - ACCOMMODATES (12) ADAPTER PLATES

The 4RU FIS Flush Mount Patch Panel Frame accommodates (12) LGX adapter plates, modules or cassettes. The flush mount design attaches flat against the rack to save space in compact applications. Patch panel frame installs into a standard 19" rack with included mounting hardware. Adapter plates sold separately.

PART #	DESCRIPTION	(HxW)	PRICE
F1-FM4RU12X	4RU Flush Mount Frame, 12 Plates, 19", Black, Unloaded	7" x 19"	\$39.95

### FIS Rack Mount Fiber Optic Patch and Splice Panel Frame



F1-RMSP4RU4X



F1-RMSP8RU12X

#### 4RU PATCH AND SPLICE PANEL - ACCOMMODATES (4) ADAPTER PLATES

The 4RU FIS Patch and Splice Panel accommodates (4) LGX adapter plates, modules or cassettes. The 2 sliding trays on the top and bottom of the enclosure allow for easy access to both patch and splice bays. Multiple cable retention brackets, splice tray mounts and tie down spots allow for convenient cable management. Rack mount installs into a standard 19" rack with included mounting hardware. Adapter plates, splice trays and 23" mounting brackets are sold separately.

PART #	DESCRIPTION	(HxWxD)	PRICE
F1-RMSP4RU4X	4RU Patch and Splice Enclosure, 4 Plates, Black, Unloaded	7.125" x 17" x 14"	\$240.00
F1-RMSP4RU4X-BW	4RU Patch and Splice Enclosure, 4 Plates, OffWhite, Unloaded	7.125" x 17" x 14"	240.00

#### 8RU PATCH AND SPLICE PANEL - ACCOMMODATES (12) ADAPTER PLATES

The 8RU FIS Patch and Splice Panel accommodates (12) LGX adapter plates, modules or cassettes. The 2 sliding trays on the top and bottom of the enclosure allow for easy access to both patch and splice bays. Multiple cable retention brackets, splice tray mounts and tie down spots allow for convenient cable management. Rack mount installs into a standard 19" rack with included mounting hardware. Adapter plates, splice trays and 23" mounting brackets are sold separately.

PART #	DESCRIPTION	(HxWxD)	PRICE
F1-RMSP8RU12X	8RU Patch and Splice Enclosure, 12 Plates, Black, Unloaded	14" x 17" x 14"	\$252.00

**1RU RACK MOUNT - ACCOMMODATES (3) ADAPTER PLATES**

The 1RU FIS Rack Mount Enclosure accommodates (3) LGX adapter plates, modules or cassettes. Slide out trays and removable front and back doors allow easy access to the patch bay. Multiple cable retention brackets and tie down spots allow for convenient cable management. Spring loaded stop latches keep the tray securely in place when retracted. Rack mount installs into a standard 19" rack. Adapter plates, 23" mounting brackets and 19" flush mounting brackets are sold separately.

PART #	DESCRIPTION	(HxWxD)	PRICE
F1-RM1RU3X	1RU Rack Mount, 3 Plates, Solid Front/Rear Doors, Black, Unloaded	1.75" x 17" x 14"	\$134.00
F1-RM1RU3X-BW	1RU Rack Mount, 3 Plates, Solid Front/Rear Doors, Off White, Unloaded	1.75" x 17" x 14"	134.00



**F1-RM1RU3X**  
(3) Six packs = 18 Port  
(3) Twelve packs = 36 Port

**2RU RACK MOUNT - ACCOMMODATES (4) ADAPTER PLATES**

The 2RU FIS Rack Mount Enclosure, accommodates (4) LGX adapter plates, modules or cassettes. Slide out trays and removable front and back doors allow easy access to the patch bay. Multiple cable retention brackets and tie down spots allow for convenient cable management. A smoked Lexan front door is available to provide visibility into the enclosure. Rack mount installs into a standard 19" rack. Adapter plates, 23" mounting brackets and 19" flush mounting brackets are sold separately.

PART #	DESCRIPTION	(HxWxD)	PRICE
F1-RM2RU4X	2RU Rack Mount, 4 Plates, Solid Front/Rear Doors, Black, Unloaded	3.5" x 17" x 14"	\$158.00
F1-RM2RU4XL	2RU Rack Mount, 4 Plates, Lexan Front and Solid Rear Door, Black, Unloaded	3.5" x 17" x 14"	163.00
F1-RM2RU4X-BW	2RU Rack Mount, 4 Plates, Solid Front/Rear Doors, Off White, Unloaded	3.5" x 17" x 14"	158.00
F1-RM2RU4XL-BW	2RU Rack Mount, 4 Plates, Lexan Front and Solid Rear Door, Off White, Unloaded	3.5" x 17" x 14"	163.00



**F1-RM2RU4X**  
(4) Six packs = 24 Port  
(4) Twelve packs = 48 Port

**2RU RACK MOUNT - ACCOMMODATES (6) ADAPTER PLATES**

The 2RU FIS Rack Mount Enclosure, accommodates (6) LGX adapter plates, modules or cassettes. Slide out trays and removable front and back doors allow easy access to the patch bay. Multiple cable retention brackets and tie down spots allow for convenient cable management. A smoked Lexan front door is available to provide visibility into the enclosure. Rack mount installs into a standard 19" rack. Adapter plates, 23" mounting brackets and 19" flush mounting brackets are sold separately.

PART #	DESCRIPTION	(HxWxD)	PRICE
F1-RM2RU6X	2RU Rack Mount, 6 Plates, Solid Front/Rear Doors, Black, Unloaded	3.5" x 17" x 14"	\$163.00
F1-RM2RU6XL	2RU Rack Mount, 6 Plates, Lexan Front and Solid Rear Door, Black, Unloaded	3.5" x 17" x 14"	168.00
F1-RM2RU6X-BW	2RU Rack Mount, 6 Plates, Solid Front/Rear Doors, Off White, Unloaded	3.5" x 17" x 14"	163.00
F1-RM2RU6XL-BW	2RU Rack Mount, 6 Plates, Lexan Front and Solid Rear Door, Off White, Unloaded	3.5" x 17" x 14"	168.00



**F1-RM2RU6X**  
(6) Six Packs = 36 port  
(6) Twelve packs = 72 port

**4RU RACK MOUNT - ACCOMMODATES (12) ADAPTER PLATES**

The 4RU FIS Rack Mount Enclosure accommodates (12) LGX adapter plates, modules or cassettes. Slide out trays and removable front and back doors allow easy access to the patch bay. Multiple cable retention brackets and tie down spots allow for convenient cable management. A smoked Lexan front door is available to provide visibility into the enclosure. Rack mount installs into a standard 19" rack. Adapter plates and 23" mounting brackets are sold separately.

PART #	DESCRIPTION	(HxWxD)	PRICE
F1-RM4RU12X	4RU Rack Mount, 12 Plates, Solid Front/Rear Doors, Black, Unloaded	7.125" x 17" x 14"	\$196.00
F1-RM4RU12XL	4RU Rack Mount, 12 Plates, Lexan Front and Solid Rear Door, Black, Unloaded	7.125" x 17" x 14"	200.00
F1-RM4RU12X-BW	4RU Rack Mount, 12 Plates, Solid Front/Rear Doors, Off White, Unloaded	7.125" x 17" x 14"	196.00
F1-RM4RU12XL-BW	4RU Rack Mount, 12 Plates, Lexan Front and Solid Rear Door, Off White, Unloaded	7.125" x 17" x 14"	200.00



**F1-RM4RU12X**  
(12) Six Packs = 72 port  
(12) Twelve packs = 144 port

**8RU RACK MOUNT - ACCOMMODATES (24) ADAPTER PLATES**

The 8RU FIS Rack Mount Enclosure accommodates (24) LGX adapter plates, modules or cassettes. Slide out trays and removable front and back doors allow easy access to the patch bay. Multiple cable retention brackets and tie down spots allow for convenient cable management. A smoked Lexan front door is available to provide visibility into the enclosure. Rack mount installs into a standard 19" rack. Adapter plates and 23" mounting brackets are sold separately.

PART #	DESCRIPTION	(HxWxD)	PRICE
F1-RM8RU24X	8RU Rack Mount, 24 Plates, Solid Front/Rear Doors, Black, Unloaded	14" x 17" x 14"	\$294.00
F1-RM8RU24XL	8RU Rack Mount, 24 Plates, Lexan Front and Solid Rear Door, Black, Unloaded	14" x 17" x 14"	298.00
F1-RM8RU24X-BW	8RU Rack Mount, 24 Plates, Solid Front/Rear Doors, Off White, Unloaded	14" x 17" x 14"	294.00
F1-RM8RU24XL-BW	8RU Rack Mount, 24 Plates, Lexan Front and Solid Rear Door, Off White, Unloaded	14" x 17" x 14"	298.00



**F1-RM8RU24X**  
(24) Six packs = 144 Port  
(24) Twelve packs = 288 Port

**1RU CABLE MANAGEMENT ENCLOSURE**

The FIS 1RU Slack Cable Management Enclosure provides a secure, dedicated space for fiber optic cable slack storage. The slide out tray and removable doors provide easy access when managing fiber. Comfortably route and store up to 25 meters of 3.0mm simplex fiber around the semi-circular slack management rings.

PART #	DESCRIPTION	(HxWxD)	PRICE
F1-RM1RUSCM	1RU Slack Cable Management Enclosure, Black	1.75" x 17" x 14"	\$133.00



**F1-RM1RUSCM**



## FIS Wall Mount Fiber Optic Enclosures

### FIS MINI WALL MOUNT ENCLOSURE

The FIS Mini Wall Mount has capacity for (1) or (2) LGX style adapter plates, depending on the size of the enclosure chosen. Ideal for patching smaller quantities of fibers in a compact form factor. Fiber enters and exits from the bottom of the closure, and a cable spool and tie down stance provide fiber management options. A single door is removable and lockable with a padlock (not included).

PART #	DESCRIPTION	(HxWxD)	PRICE
F1-MW1X	1 Plate Mini (Unloaded) Black	9.18" x 6.38" x 2.625"	\$58.00
F1-MW1X-BW	1 Plate Mini (Unloaded) Off White	9.18" x 6.38" x 2.625"	58.00
F1-MW2X	2 Plate Mini (Unloaded) Black	9.18" x 6.38" x 2.625"	70.00
F1-MW2X-BW	2 Plate Mini (Unloaded) Off White	9.18" x 6.38" x 2.625"	70.00



F1-MW2X

### FIS ECONOMY WALL MOUNT ENCLOSURES

The FIS Economy Wall Mount has capacity for (2) or (4) LGX style adapter plates depending on the size of the enclosure chosen. It features a cable spool, bridge stances and a mounting stud and nut to secure splice trays. The lockable inner door (lock/key included) provides safe storage of incoming cable while allowing the technician to manipulate outgoing fiber patches. The outer door is removable and lockable with a padlock (sold separately). Accommodates QTY (2) splice trays approximately 7"L x 4"W (Ex. F1-SPL12). Ask an FIS sales associate about pre-loading the enclosure with fiber pigtails, splice trays and adapter plates.

PART #	DESCRIPTION	(HxWxD)	PRICE
F1-EW2X	2 Plate Economy (Unloaded) Black	10.33" x 12.12" x 3.81"	\$126.00
F1-EW2X-BW	2 Plate Economy (Unloaded) Off White	10.33" x 12.12" x 3.81"	126.00
F1-EW4X	4 Plate Economy (Unloaded) Black	12.24" x 12.12" x 3.81"	130.00
F1-EW4X-BW	4 Plate Economy (Unloaded) Off White	12.24" x 12.12" x 3.81"	130.00



### FIS DELUXE WALL MOUNT ENCLOSURES

The FIS Deluxe Wall Mount has capacity for (2), (4), (8), or (12) LGX style adapter plates depending on the size of the enclosure chosen. It features a larger splicing bay and more cable spooling brackets than the Economy version. Bridge stances and a splice tray mounting stud and nut are also included for easy installation of splice trays. The two front doors are removable to give unrestricted access during installation, and each door is also lockable with a padlock (sold separately) to provide security when in use. Accommodates QTY (2) splice trays approximately 7"L x 4"W (Ex. F1-SPL12) or 11.72"L x 4"W (Ex. F1-SPL24). Ask an FIS sales associate about pre-loading the enclosure with fiber pigtails, splice trays and adapter plates.

PART #	DESCRIPTION	(HxWxD)	PRICE
F1-DW2X	2 Plate Deluxe (Unloaded) Black	13.16" x 14.44" x 3.06"	\$124.00
F1-DW2X-BW	2 Plate Deluxe (Unloaded) Off White	13.16" x 14.44" x 3.06"	124.00
F1-DW4X	4 Plate Deluxe (Unloaded) Black	13.16" x 14.44" x 3.06"	129.00
F1-DW4X-BW	4 Plate Deluxe (Unloaded) Off White	13.16" x 14.44" x 3.06"	129.00
F1-DW8X	8 Plate Deluxe (Unloaded) Black	13.16" x 14.51" x 5.60"	152.00
F1-DW8X-BW	8 Plate Deluxe (Unloaded) Off White	13.16" x 14.51" x 5.60"	152.00
F1-DW12X	12 Plate Deluxe (Unloaded) Black	14.51" x 19.38" x 5.60"	182.00
F1-DW12X-BW	12 Plate Deluxe (Unloaded) Off White	14.51" x 19.38" x 5.60"	182.00
F1-DW12XEXT	12 Plate Deluxe Extended (Unloaded) Black	14.51" x 25.63" x 5.60"	187.00



### FIS PATCH AND SPLICE WALL MOUNT ENCLOSURE

The FIS Patch and Splice Wall Mount enclosure is lightweight and easy to install. There is capacity for (2), (4), or (8) LGX style adapter plates depending on the size of the enclosure chosen. This unit features a lockable (lock/key included) compact housing that allows both splicing and connecting of fiber optic cables. FF-WM012 accommodates QTY (1) splice tray approximately 7"L x 4"W (Ex. F1-SPL12). FF-WM024 accommodates QTY (2) splice trays approximately 7"L x 4"W (Ex. F1-SPL12). FF-WM048 accommodates QTY (4) splice trays approximately 7"L x 4"W (Ex. F1-SPL12) or 11.72"L x 4"W (Ex. F1-SPL24).

PART #	DESCRIPTION	(HxWxD)	PRICE
FF-WM012	2 Plate Patch and Splice (Unloaded) Off White	6" x 12" x 4.5"	\$169.00
FF-WM012-BLK	2 Plate Patch and Splice (Unloaded) Black	6" x 14" x 4.5"	169.00
FF-WM024	4 Plate Patch and Splice (Unloaded) Off White	11" x 14" x 4.5"	195.00
FF-WM024-BLK	4 Plate Patch and Splice (Unloaded) Black	11" x 12" x 4.5"	170.00
FF-WM048	8 Plate Patch and Splice (Unloaded) Off White	16" x 20" x 6.5"	248.00
FF-WM048-BLK	8 Plate Patch and Splice (Unloaded) Black	16" x 20" x 6.5"	248.00



FF-WM012BLK

### FIS WALL MOUNT SPLICE ENCLOSURE

The FIS Wall Mount Splice Enclosure provides a secure splice bay for up to (12) splice trays. Cable entry and exit holes are now located on the tops and sides of the unit, and are protected by 1.25" dust-proof grommets. Both doors are removable for easy access and lockable for added security. Cable management rings are moveable within the unit and cable tie-downs are located throughout the unit. Constructed from lightweight, sturdy 16 gauge steel for easy installation. Recommended splice tray is 11.72"L x 4"W (Ex. F1-SPL24). Splice trays not included.

PART #	DESCRIPTION	DIMENSIONS (HxWxD)	PRICE
F1-SW12T	FIS Wall Mount Splice Enclosure, 12 Trays, Top/Side Entry	17.25" x 21.25" x 4.68"	\$398.00



F1-SW12T

# PRE-LOADED FIBER OPTIC ENCLOSURES



The FIS Pre-Loaded Fiber Optic Enclosures are designed to be a Plug and Play solution. These are offered in both Rack Mount and Wall Mount style enclosures. They come loaded with your choice of SC/LC adapter panels and splice trays, or adapter panels, splice trays and pigtails. Available in both singlemode and multimode (50um 10gig). All enclosures include splice trays unless requested without. *\*Other Configurations available upon request.*

## Part Number Configurator

ENCLOSURE		CONNECTOR TYPE	TOTAL PORTS	PIGTAIL	SPLICE TRAYS
F1RM1RU3X		SCU	36	SP	NT
F1RM1RU3X	F1DW2X	SCU = SC/UPC	12	SP = PIGTAILS	NT = NO TRAYS
F1RM2RU4X	F1DW4X	SCA = SC/APC	24		
F1RM2RU6X	F1DW8X	SCOM3 = SC/PC	36		
F1RM4RU12X	F1DW12X	LCU = LC/UPC	48		
F1RMS01RU2X		LCA = LC/APC	72		
F1RMS02RU4X		LCOM3 = LC/PC	96		
			144		

**Part # Example:**  
**F1RM1RU3X-SCU-36-SP**  
 FIS 1RU Rack Mount w/ 3 SC/UPC Plates, Pigtails & Trays, Black (36 Fibers)



## FIS Preloaded Rack Mount Enclosures

### FIS 1RU RACK MOUNTS

PART #	DESCRIPTION	PRICE
F1RM1RU3XSCUPC36SP	FIS 1RU Rack Mount w/3 SC/UPC Plates, Pigtails & Trays, Black (36 Fibers)	\$360.00
F1RM1RU3XSCAPC36SP	FIS 1RU Rack Mount w/3 SC/APC Plates, Pigtails & Trays, Black (36 Fibers)	335.00
F1RM1RU3XSCOM336SP	FIS 1RU Rack Mount w/3 SC/PC OM3 Plates, Pigtails & Trays, Black (36 Fibers)	330.00
F1RM1RU3XLCUPC36SP	FIS 1RU Rack Mount w/3 LC/UPC Plates, Pigtails & Trays, Black (36 Fibers)	400.00
F1RM1RU3XLCAPC36SP	FIS 1RU Rack Mount w/3 LC/APC Plates, Pigtails & Trays, Black (36 Fibers)	370.00
F1RM1RU3XLCOM336SP	FIS 1RU Rack Mount w/3 LC/PC OM3 Plates, Pigtails & Trays, Black (36 Fibers)	380.00



F1-RM1RU3XLCUPC36

### FIS 2RU RACK MOUNTS

PART #	DESCRIPTION	PRICE
F1RM2RU6XSCUPC72SP	FIS 2RU Rack Mount w/6 SC/UPC Plates, Pigtails & Trays, Black (72 Fibers)	\$480.00
F1RM2RU6XSCAPC72SP	FIS 2RU Rack Mount w/6 SC/APC Plates, Pigtails & Trays, Black (72 Fibers)	500.00
F1RM2RU6XSCOM372SP	FIS 2RU Rack Mount w/6 SC/PC OM3 Plates, Pigtails & Trays, Black (72 Fibers)	470.00
F1RM2RU6XLCUPC72SP	FIS 2RU Rack Mount w/6 LC/UPC Plates, Pigtails & Trays, Black (72 Fibers)	600.00
F1RM2RU6XLCAPC72SP	FIS 2RU Rack Mount w/6 LC/APC Plates, Pigtails & Trays, Black (72 Fibers)	555.00
F1RM2RU6XLCOM372SP	FIS 2RU Rack Mount w/6 LC/PC OM3 Plates, Pigtails & Trays, Black (72 Fibers)	490.00



F1-RM2RU6XLCUPC72SP

### FIS 4RU RACK MOUNTS

PART #	DESCRIPTION	PRICE
F1RM4RU12XSCUPC144SP	FIS 4RU Rack Mount w/12 SC/UPC Plates, Pigtails & Trays, Black (144 Fibers)	\$790.00
F1RM4RU12XSCAPC144SP	FIS 4RU Rack Mount w/12 SC/APC Plates, Pigtails & Trays, Black (144 Fibers)	820.00
F1RM4RU12XSCOM3144SP	FIS 4RU Rack Mount w/12 SC/PC OM3 Plates, Pigtails & Trays, Black (144 Fibers)	800.00
F1RM4RU12XLCUPC144SP	FIS 4RU Rack Mount w/12 LC/UPC Plates, Pigtails & Trays, Black (144 Fibers)	1,080.00
F1RM4RU12XLCAPC144SP	FIS 4RU Rack Mount w/12 LC/APC Plates, Pigtails & Trays, Black (144 Fibers)	970.00
F1RM4RU12XLCOM3144SP	FIS 4RU Rack Mount w/12 LC/PC OM3 Plates, Pigtails & Trays, Black (144 Fibers)	1,025.00



BACK VIEW  
 F1-RM4RU12XSCAPC144SP

### FIS 1RU SWING OUT RACK MOUNT

PART #	DESCRIPTION	PRICE
F1RMS01RU2XSCUPC24SP	FIS 1RU Swing Out Rack Mount w/2 SC/UPC Plates, Pigtails & Tray Black (24 Fibers)	\$235.00
F1RMS01RU2XSCAPC24SP	FIS 1RU Swing Out Rack Mount w/2 SC/APC Plates, Pigtails & Tray Black (24 Fibers)	235.00
F1RMS01RU2XSCOM324SP	FIS 1RU Swing Out Rack Mount w/2 SC/PC OM3 Plates, Pigtails & Tray Black (24 Fibers)	220.00
F1RMS01RU2XLCUPC24SP	FIS 1RU Swing Out Rack Mount w/2 LC/UPC Plates, Pigtails & Tray Black (24 Fibers)	265.00
F1RMS01RU2XLCOM324SP	FIS 1RU Swing Out Rack Mount w/2 LC/PC OM3 Plates, Pigtails & Tray Black (24 Fibers)	255.00



F1RMS01RU2XLCAPC24

*\*Other Configurations available upon request.*



F1-DW2XSCAPC24SP



F1-DW4XLCOM348SP



F1-DW8XSCUPC96SP

F1-PSCKLUPC12



F1-PSCKLUPC24



F1-MTPMLCOM324

## FIS Preloaded Wall Mount Enclosures

### FIS 2 PANEL DELUXE WALL MOUNTS

PART #	DESCRIPTION	PRICE
F1DW2XSCUPC24SP	FIS 2 Panel Deluxe Wall Mount w/2 SC/UPC Plates, Pigtailed & Tray, Black (24 Fibers)	\$280.00
F1DW2XSCAPC24SP	FIS 2 Panel Deluxe Wall Mount w/2 SC/APC Plates, Pigtailed & Tray, Black (24 Fibers)	270.00
F1DW2XSCOM324SP	FIS 2 Panel Deluxe Wall Mount w/2 SC/PC OM3 Plates, Pigtailed & Tray, Black (24 Fibers)	260.00
F1DW2XLCUPC24SP	FIS 2 Panel Deluxe Wall Mount w/2 LC/UPC Plates, Pigtailed & Tray, Black (24 Fibers)	310.00
F1DW2XLCOM324SP	FIS 2 Panel Deluxe Wall Mount w/2 LC/PC OM3 Plates, Pigtailed & Tray, Black (24 Fibers)	300.00

\*Other Configurations available upon request.

### FIS 4 PANEL DELUXE WALL MOUNTS

PART #	DESCRIPTION	PRICE
F1DW4XSCUPC48SP	FIS 4 Panel Deluxe Wall Mount w/4 SC/UPC Plates, Pigtailed & Tray, Black (48 Fibers)	\$385.00
F1DW4XSCAPC48SP	FIS 4 Panel Deluxe Wall Mount w/4 SC/APC Plates, Pigtailed & Tray, Black (48 Fibers)	360.00
F1DW4XSCOM348SP	FIS 4 Panel Deluxe Wall Mount w/4 SC/PC OM3 Plates, Pigtailed & Tray, Black (48 Fibers)	350.00
F1DW4XLCUPC48SP	FIS 4 Panel Deluxe Wall Mount w/4 LC/UPC Plates, Pigtailed & Tray, Black (48 Fibers)	440.00
F1DW4XLCOM348SP	FIS 4 Panel Deluxe Wall Mount w/4 LC/PC OM3 Plates, Pigtailed & Tray, Black (48 Fibers)	420.00

\*Other Configurations available upon request.

### FIS 8 PANEL DELUXE WALL MOUNTS

PART #	DESCRIPTION	PRICE
F1DW8XSCUPC96SP	FIS 8 Panel Deluxe Wall Mount w/8 SC/UPC Plates, Pigtailed & Tray, Black (96 Fibers)	\$645.00
F1DW8XSCAPC96SP	FIS 8 Panel Deluxe Wall Mount w/8 SC/APC Plates, Pigtailed & Tray, Black (96 Fibers)	580.00
F1DW8XSCOM396SP	FIS 8 Panel Deluxe Wall Mount w/8 SC/PC OM3 Plates, Pigtailed & Tray, Black (96 Fibers)	565.00
F1DW8XLCUPC96SP	FIS 8 Panel Deluxe Wall Mount w/8 LC/UPC Plates, Pigtailed & Tray, Black (96 Fibers)	750.00
F1DW8XLCOM396SP	FIS 8 Panel Deluxe Wall Mount w/8 LC/PC OM3 Plates, Pigtailed & Tray, Black (96 Fibers)	645.00

\*Other Configurations available upon request.

### FIS PATCH & SPLICE CASSETTE KITS

The new FIS Patch & Splice Cassette kit is an all encompassing unit, with the full removable splice tray and adapter panel making splicing and cable management a breeze. With an LGX footprint, these cassettes can be installed in most fiber optic rack and wall mount enclosures. Each kit includes an adapter panel, pigtailed, and splice trays. 12ct and 24ct (LC) configurations available for both single mode and multimode applications, and can be used with both single fiber and mass fusion offerings.

PART #	DESCRIPTION	PRICE
F1PSCKLUPC12	FIS Patch & Splice Cassette Kit, Singlemode, LC/UPC, 12 Fiber	\$130.00
F1PSCKLAPC12	FIS Patch & Splice Cassette Kit, Singlemode, LC/APC, 12 Fiber	130.00
F1PSCKLCOM312	FIS Patch & Splice Cassette Kit, Multimode OM3, LC/PC, 12 Fiber	130.00
F1PSCKSCUPC12	FIS Patch & Splice Cassette Kit, Singlemode, SC/UPC, 12 Fiber	260.00
F1PSCKSCAPC12	FIS Patch & Splice Cassette Kit, Singlemode, SC/APC, 12 Fiber	260.00
F1PSCKSCOM312	FIS Patch & Splice Cassette Kit, Multimode OM3, SC/PC, 12 Fiber	260.00
F1PSCKLUPC24	FIS Patch & Splice Cassette Kit, Singlemode, LC/UPC, 24 Fiber	130.00
F1PSCKLAPC24	FIS Patch & Splice Cassette Kit, Singlemode, LC/APC, 24 Fiber	130.00
F1PSCKLCOM324	FIS Patch & Splice Cassette Kit, Multimode OM3, LC/PC, 24 Fiber	130.00
F1PSCKLUPC12R	FIS Patch & Splice Cassette Kit, Singlemode, LC/UPC, 12 Fiber, Ribbon Pigtailed	145.00
F1PSCKLAPC12R	FIS Patch & Splice Cassette Kit, Singlemode, LC/APC, 12 Fiber, Ribbon Pigtailed	145.00
F1PSCKLCOM312R	FIS Patch & Splice Cassette Kit, Multimode OM3, LC/PC, 12 Fiber, Ribbon Pigtailed	145.00
F1PSCKSCUPC12R	FIS Patch & Splice Cassette Kit, Singlemode, SC/UPC, 12 Fiber, Ribbon Pigtailed	275.00
F1PSCKSCAPC12R	FIS Patch & Splice Cassette Kit, Singlemode, SC/APC, 12 Fiber, Ribbon Pigtailed	275.00
F1PSCKSCOM312R	FIS Patch & Splice Cassette Kit, Multimode OM3, SC/PC, 12 Fiber, Ribbon Pigtailed	275.00
F1PSCKLUPC24R	FIS Patch & Splice Cassette Kit, Singlemode, LC/UPC, 24 Fiber, Ribbon Pigtailed	145.00
F1PSCKLAPC24R	FIS Patch & Splice Cassette Kit, Singlemode, LC/APC, 24 Fiber, Ribbon Pigtailed	145.00
F1PSCKLCOM324R	FIS Patch & Splice Cassette Kit, Multimode OM3, LC/PC, 24 Fiber, Ribbon Pigtailed	145.00

### FIS MPO/MTP CASSETTES

The FIS MPO/MTP Module is a pre-terminated, pre-tested, rack mount module system allowing for a simple installation of MPO/MTP backbone cables with a transition to standard LC or SC connections. The FIS modules are designed to fit into enclosures with LGX slot configurations.

PART #	DESCRIPTION	PRICE
F1MTPMLCOS212	12 fiber SM OS2, 1 rear MTP/male port, 6 front LC duplex ports Type A	\$190.00
F1MTPMLCOM312	12 fiber MM OM3, 1 rear MTP/male port, 6 front LC duplex ports Type A	150.00
F1MTPMLCOM312B	12 fiber MM OM3, 1 rear MTP/male port, 6 front LC duplex ports Type B	150.00
F1MTPMSCOS212	12 fiber SM OS2, 1 rear MTP/male port, 6 front SC duplex ports Type A	190.00
F1MTPMSCAPCOS212	12 fiber SM OS2, 1 rear MTP/male port, 6 front SC/APC duplex ports Type A	190.00
F1MTPMSCOM312	12 fiber MM OM3, 1 rear MTP/male port, 6 front SC duplex ports Type A	150.00
F1MTPMSCOM312B	12 fiber MM OM3, 1 rear MTP/male port, 6 front SC duplex ports Type B	150.00
F1MTPMLCOS224	24 fiber SM OS2, 2 rear MTP/male port, 6 front LC quad ports Type A	350.00
F1MTPMLCOM324	24 fiber MM OM3, 2 rear MTP/male port, 6 front LC quad ports Type A	270.00

\*All cassettes are also available with MTP Female ports

# FIS ADDITIONAL INNERCONNECT PRODUCTS



## FIS COMPACT WALL MOUNT

The FIS Compact Wall Mount has capacity for (1) or (2) LGX style adapter plates or MPO/MTP cassettes depending on the size of enclosure. The compact form factor along with an included Din Rail mount allows the enclosure to be mounted virtually anywhere. Equipped with a fully removable door makes either splicing pigtails or patching pre-terminated cables simple. 40mm splice sleeves (F1100240C-50) are recommended for use in these enclosures.

PART #	DESCRIPTION	DIMENSIONS (HxWxD)	PRICE
F1CW1X	1 Plate Compact Wall Mount Enclosure Black	5.5" x 7.5" x 1.35"	\$57.95
F1CW2X	2 Plate Compact Wall Mount Enclosure Black	5.5" x 7.5" x 2.57"	67.95



## FIS INTELLIGENT TRAFFIC SYSTEMS (ITS) CABINET ENCLOSURES

The FIS Intelligent Traffic Systems (ITS) Cabinet enclosures come in 2, 4, & 6RU footprints. These flush mount, rack mountable enclosures are specifically geared for Traffic Signal, ITS (Intelligent Traffic Systems) roadside cabinets, or Computer Room enclosed type cabinets, where the 19" equipment mounting rail, is too close to the door for any protrusion.

Key features include the left side cable manager and rear exit, a fully removable lid and a fixed adapter plate and tray which allows storage space for excess cable. These features make a perfect solution for installing a pre-terminated outside plant trunk cable. Enclosures are available in black upon request. It accommodates FIS extended adapter plates.\*

It's recommended to have enclosures loaded with pre-terminated trunk cables at FIS prior to shipping. Ask your sales representative for more information.

\* Extended footprint is 6.12"(L) x 1.37"(W)

PART #	DESCRIPTION	DIMENSIONS (HxWxD)	PRICE
F119IN2RUFMWE	19" Flush Mount 2RU Rack Mount, Extended Footprint, 48/96 (LC) fibers, Off White	3.5" x 18.20" x 10.82"	\$245.00
F119IN4RUFMWE	19" Flush Mount 4RU Rack Mount, Extended Footprint, 96/192 (LC) fibers, Off White	7" x 18.20" x 10.82"	295.00
F119IN6RUFMWE	19" Flush Mount 6RU Rack Mount, Extended Footprint, 144/288 (LC) fibers, Off White	10.5" x 18.20" x 10.82"	400.00
F1SC6DSULE	SC/UPC SM 6 Fiber Extended Adapter Plate- Off White	6.12" x 1.37" (L x H)	30.00
F1SC6DSULE	SC/UPC SM 12 Fiber Extended Adapter Plate- Off White	6.12" x 1.37" (L x H)	30.00
F1LC6DSULE	LC/UPC SM 12 Fiber Extended Adapter Plate- Off White	6.12" x 1.37" (L x H)	30.00
F1LC12DSULE	LC/UPC SM 24 Fiber Extended Adapter Plate- Off White	6.12" x 1.37" (L x H)	50.00
F1ST6LSULE	ST/UPC SM 6 Fiber Extended Adapter Plate- Off White	6.12" x 1.37" (L x H)	30.00
F1ST12ULE	ST/UPC SM 12 Fiber Extended Adapter Plate- Off White	6.12" x 1.37" (L x H)	40.00
F1BLANKUE	Blank Plate with No Holes (Unloaded)	6.12" x 1.37" (L x H)	10.00

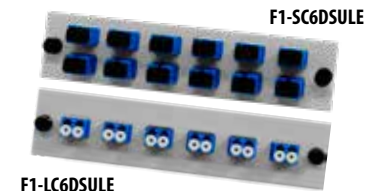

## FIS WIRELESS PEDESTAL ENCLOSURE

Designed to provide front entrance cabinet users access to the rear of fiber interconnect connectors with use of swing out panel. Includes a splice tray riser and two 24 fiber fusion splice trays. The attached side cable manager can accommodate cables or allow rear exit to the back of the cabinet where often chimneys are installed for routing cables from different bays. Interconnect utilizes standard LGX footprint adapter panels. Optional front lacing bar can dress cables to cable manager and secure them from being snagged or pinched in cabinet door. [LGX Panels see page 70](#)

PART #	DESCRIPTION	DIMENSIONS (HxWxD)	PRICE
F1RMRX2RU4X	FIS Flush mount 2RU Swing Out Enclosure, Left Side Cable Manager and Rear Exit Cable Return	3.5" x 18.20" x 10.42"	\$125.00
F1RMRX2RU4XLB	Lacing Bar Accessory for F1RMRX2RU4X	11.50" x 1.25" (L x D)	15.00

## FIS SUBSTATION WALL MOUNT

The FIS substation Wall Mount is a rugged 16 gauge cold rolled steel enclosure that can hold up to (4) LGX adapter plates. This enclosure is designed for wind/solar farm and utility substations where space is at a premium. Some key features include the solid front door and exposed adapter plate master panel. Two cable entries along with the flat front door allows these enclosures to be "stacked".

PART #	DESCRIPTION	DIMENSIONS (HxWxD)	PRICE
F1SDW4X	FIS 4 Panel Single Front Door Wall Mount Black	11.81"H x 9.05" x 3.62"	\$85.00

## FIS INSIDE PLANT (ISP) SLACK BOX

The ISP Slack Box is designed to easily store and protect bulk excess fiber cable. This wall mountable enclosure is 14.64" (W) x 3.31" (D) x 14.15" (H) and can hold up to 70mtr of 7.5mm cable. Two cable entries on the top and bottom of the closure along with four half circle cable management rings allows you to store cable with ease.

PART #	DESCRIPTION	DIMENSIONS (HxWxD)	PRICE
F1ISPSLACK	FIS Indoor Cable Slack Box, holds up to 70mtr of 7.5mm Cable	14.15" x 14.46" x 3.31"	\$135.00

## FIS L-SHAPED BRACKET

This L-Shaped Bracket is designed to be mounted almost anywhere in existing enclosures where small count fibers are needed. It can hold up to (2) LGX style adapter plates.

PART #	DESCRIPTION	DIMENSIONS (HxWxD)	PRICE
F1AB2X	Adapter Plate Bracket, Holds (2) LGX Adapter Plates-Black	3" x 5.25" x 1"	\$11.50



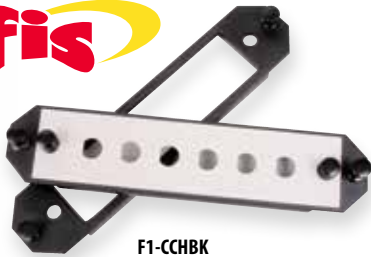

F1-CCHBK

## FIS UNIVERSAL MOUNTING BRACKET FOR CORNING WCH AND CCH BOXES

FIS offers a Universal Mounting Bracket that allows installers to use LGX style adapter plates in Corning CCH and PCH series closures. When original manufacturers' plates are not available, technicians can install this universal mounting bracket and utilize an LGX adapter plate.

PART #	DESCRIPTION	PRICE
F1-CCHBK	Universal Mounting Bracket for Corning PCH and CCH Boxes (LGX Adapter Plate Not Included)	\$3.99

## FIS LGX ADAPTER PLATES

All FIS Adapter Plates are LGX compatible. An LGX adapter plate measures 5.1" long by 1.13" high with an on center post width of 4.64".

### SC PLATE AND ADAPTERS

OFF WHITE PART #	BLACK PART #	DESCRIPTION	PRICE
F1-SC6U	F1-SC6IUBK	SC 6 Pack, Unloaded	\$2.75
F1-DSC6U	F1-DSC6IUBK	SC Duplex 6 Pack, Unloaded	2.75
F1-SC3DSUL	F1SC3DBKSUL	SC Duplex 3 Pack, Loaded, Singlemode, Blue Adapters, 6 Fibers	12.50
F1-SC3DAPCSUL	F1SC3DBKAPCSUL	SC Duplex 3 Pack, Loaded, Singlemode, Green Adapters, 6 Fibers	12.50
F1-SC3DAQMUL	F1SC3DBKAQMUL	SC Duplex 3 Pack, Loaded, Multimode, Aqua Adapters, 6 Fibers	12.50
F1-SC6MUL	F1-SC6IBKMUL	SC 6 Pack, Loaded, Multimode, Beige Adapters	15.50
F1-SC6SUL	F1-SC6IBKSUL	SC 6 Pack, Loaded, Singlemode, Blue Adapters	15.50
F1-SC6APCUL	F1-SC6IBKAPCUL	SC 6 Pack, Loaded, Singlemode, APC, Green Adapters	15.50
F1SC8APCUL	F1SC8BKAPCUL	SC 8 Pack, Loaded, Singlemode, APC, Green Adapters	16.50
F1-SC6DMUL	F1-SC6DBKMUL	SC Duplex 6 Pack, Loaded, Multimode, Beige Adapters, 12 Fibers	17.50
F1-SC6DAQUL	F1-SC6DAQBKUL	SC Duplex 6 Pack, Loaded, Multimode, OM3, Aqua Adapters, 12 Fibers	17.50
F1-SC6DSUL	F1-SC6DBKSUL	SC Duplex 6 Pack, Loaded, Singlemode, Blue Adapters, 12 Fibers	17.50
F1-SC6DAPCUL	F1-SC6DBKAPCUL	SC Duplex 6 Pack, Loaded, Singlemode, APC, Green Adapters, 12 Fibers	17.50

### LC PLATE AND ADAPTERS

OFF WHITE PART #	BLACK PART #	DESCRIPTION	PRICE
F1-LC3DSUL	F1LC3DBKSUL	LC Duplex 3 Pack, Loaded, Singlemode, Blue Adapters, 6 Fibers	\$12.50
F1-LC3DAPCSUL	F1LC3DBKAPCSUL	LC Duplex 3 Pack, Loaded, Singlemode, Green Adapters, 6 Fibers	12.50
F1-LC3DAQMUL	F1LC3DAQBKUL	LC Duplex 3 Pack, Loaded, Multimode, Aqua Adapters, 6 Fibers	12.50
F1-LC6DSUL	F1-LC6DBKSUL	LC Duplex 6 Pack, Loaded, Singlemode, Blue Adapters, 12 Fibers, Square Adapter	17.50
F1-LC6DAPCUL	F1-LC6DBKAPCSUL	LC Duplex 6 Pack, Loaded, Singlemode, APC, Green Adapters, 12 Fibers	17.50
F1-LC6DMUL	F1-LC6DBKMUL	LC Duplex 6 Pack, Loaded, Multimode, Beige Adapters, 12 Fibers, Square Adapter	17.50
F1-LC6DAQUL	F1-LC6DBKAQUL	LC Duplex 6 Pack, Loaded, Multimode, OM3, Aqua Adapters, 12 Fibers	17.50
F1-LC3QSUL	F1LC3QBKSUL	LC Quad 3 Pack, Loaded, Singlemode, Blue Adapters, 12 Fibers	27.25
F1-LC3QAPCSUL	F1LC3QBKAPCSUL	LC Quad 3 Pack, Loaded, Singlemode, Green Adapters 12 Fibers	27.25
F1-LC3QAQMUL	F1LC3QBKAQMUL	LC Quad 3 Pack, Loaded, Multimode, OM3 Aqua Adapters, 12 Fibers	27.25
F1-LC24DSUL	F1LC24DBKSUL	LC Duplex 12 Pack, Loaded, Singlemode, Blue Adapters, 24 Fibers	31.50
F1-LC24DAPCSUL	F1LC24DBKAPCSUL	LC Duplex 12 Pack, Loaded, Singlemode, Green Adapters, 24 Fibers	31.50
F1LC24DAQMUL	F1LC24DAQBKUL	LC Duplex 12 Pack, Loaded, Multimode, Aqua Adapters, 24 Fibers	31.50
F1-LC24SUL	F1-LC24BLKSUL	LC Quad 6 Pack, Loaded, Singlemode, Blue Adapters, 24 Fibers	45.00
F1-LC24MUL	F1-LC24BLKMUL	LC Quad 6 Pack, Loaded, Multimode, Beige Adapters, 24 Fibers	45.00
F1-LC24DAQMUL	F1-LC24AQBKUL	LC Quad 6 Pack, Loaded, Multimode, OM3, Aqua Adapters, 24 Fibers	45.00

### ST PLATE AND ADAPTERS

OFF WHITE PART #	BLACK PART #	DESCRIPTION	PRICE
F1-ST6U	F1-ST6UBK	ST 6 Pack, Unloaded	\$2.75
F1-ST6LSUL	F1-ST6BKSUL	ST 6 Pack, Loaded, Singlemode	15.50
F1-ST6LMUL	F1-ST6BKMUL	ST 6 Pack, Loaded, Multimode	15.50
F1-ST8U	F1-ST8UBK	ST 8 Pack, Unloaded	2.75
F1-ST8LSUL	F1-ST8BKSUL	ST 8 Pack, Loaded, Singlemode	17.25
F1-ST8LMUL	F1-ST8BKMUL	ST 8 Pack, Loaded, Multimode	17.25
F1-ST12UL	F1-ST12UBK	ST 12 Pack, Loaded, Singlemode	20.00
F1ST12MUL	F1ST12MULBK	ST 12 Pack, Loaded, Multimode	20.00

### FC PLATE AND ADAPTERS

OFF WHITE PART #	BLACK PART #	DESCRIPTION	PRICE
F1-FC6U	F1-FC6UBK	FC 6 Pack, Unloaded	\$2.75
F1-FC6MUL	F1-FC6BKMUL	FC 6 Pack, Loaded, Multimode	24.00
F1-FC6SUL	F1-FC6BKSUL	FC 6 Pack, Loaded, Singlemode	24.00
F1-FC6APCUL	F1-FC6BKAPCUL	FC 6 Pack, Loaded, Singlemode, APC	24.00

### OTHER STYLE PLATE AND ADAPTERS

OFF WHITE PART #	BLACK PART #	DESCRIPTION	PRICE
F1-BLANKU	F1-BLANKUBK	Blank Plate with No Holes (Unloaded)	\$3.50
F1-MTP6MUL	F1-MTP6BKMUL	MTP 6 Pack Plate Loaded with Adapters	50.00
F1SC6APCUL45	F1SC6APCBKUL45	SC 6 Pack (APC Singlemode – Loaded) Green Adapters, Ports Angled 45°	22.00
F1LC6DAQUL45	F1LC6DAQBKUL45	LC Duplex 6 Pack (10 Gig) 12 Fibers Aqua Adapters, Ports Angled 45°	27.00



F1-SC3DBKSUL



F1-SC6DBKAPCUL



F1-LC3DAQBKUL



F1-LC24BLKSUL



F1-LC24DBKAPCSUL



F1-ST8BKSUL



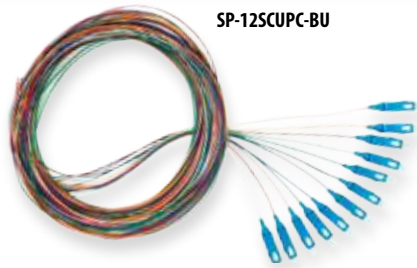

SP-12SCUPC-BU

**Quantity Pricing Available!**

**Multimode Pigtails Available**



DS-P12LCUPC-BU

**LC/APC Pigtails Now Available**

**900UM FIBER PIGTAILS - 6 AND 12 FIBER PACKS**

These 900µm Tight Buffer pigtails are designed for high fiber count splicing applications and are color coded to TIA-598-A industry standards for ease of use. Pigtails are available in Singlemode or Multimode, 6-packs or 12-packs, and your choice of connectors. All pigtails feature low insertion loss, low back reflection and are made with Corning® fiber. Standard length of 3 meters.

**6 FIBER PIGTAILS (COLOR CODED)**

PART #	DESCRIPTION	PRICE
SP-6SCUPC-BU	6 Fiber SC/UPC 900µm Style Pigtail, SM, Blue Boots	\$16.38
SP-6SCAPC-GR	6 Fiber SC/APC 900µm Style Pigtail, SM, Green Boots	16.72
SP-6SCMM-BG	6 Fiber SC/PC 900µm Style Pigtail, MM 62.5µm, Beige Boots	13.81
SP-6SCMM50-BLK	6 Fiber SC/PC 900µm Style Pigtail, MM 50µm, Black Boots	14.50
SP-6SCMM50G-AQ	6 Fiber SC/PC 900µm Style Pigtail, OM3 MM 50µm, Aqua Boots	13.97
SP-6LCUPC-BU	6 Fiber LC/UPC 900µm Style Pigtail, SM, Blue Boots	17.25
SP-6LCMM-BG	6 Fiber LC/PC 900µm Style Pigtail, MM 62.5µm, Beige Boots	15.53
SP-6LCMM50G-AQ	6 Fiber LC/PC 900µm Style Pigtail, OM3 MM 50µm, Aqua Boots	15.53
SP-6STUPC-BU	6 Fiber ST/UPC 900µm Style Pigtail, SM, Blue Boots	15.34
SP-6STMM-BG	6 Fiber ST/PC 900µm Style Pigtail, MM 62.5µm, Beige Boots	13.81
SP-6STMM50-BLK	6 Fiber ST/PC 900µm Style Pigtail, MM 50µm, Black Boots	21.45

**12 FIBER PIGTAILS (COLOR CODED)**

PART #	DESCRIPTION	PRICE
SP-12SCUPC-BU	12 Fiber SC/UPC 900µm Style Pigtail, SM, Blue Boots	\$30.70
SP-12SCAPC-GR	12 Fiber SC/APC 900µm Style Pigtail, SM, Green Boots	33.47
SP-12SCMM-BG	12 Fiber SC/PC 900µm Style Pigtail, MM 62.5µm, Beige Boots	27.59
SP-12SCMM50-BLK	12 Fiber SC/PC 900µm Style Pigtail, MM 50µm, Black Boots	21.45
SP-12SCMM50G-AQ	12 Fiber SC/PC 900µm Style Pigtail, OM3 MM 50µm, Aqua Boots	27.94
SP-12LCUPC-BU	12 Fiber LC/UPC 900µm Style Pigtail, SM, Blue Boots	34.50
SP-12LCMM-BG	12 Fiber LC/PC 900µm Style Pigtail, MM 62.5µm, Beige Boots	31.06
SP-12LCMM50-BLK	12 Fiber LC/PC 900µm Style Pigtail, MM 50µm, Black Boots	23.70
SP-12LCMM50G-AQ	12 Fiber LC/PC 900µm Style Pigtail, OM3 MM 50µm, Aqua Boots	31.06
SP-12STUPC-BU	12 Fiber ST/UPC 900µm Style Pigtail, SM, Blue Boots	30.72
SP-12STMM-BG	12 Fiber ST/PC 900µm Style Pigtail, MM 62.5µm, Beige Boots	31.94
SP-12STMM50-BLK	12 Fiber ST/PC 900µm Style Pigtail, MM 50µm, Black Boots	21.80

**DISTRIBUTION FIBER PIGTAILS - 6 AND 12 FIBERS**

These Distribution fiber pigtails feature a durable outer jacket ensuring strength and protection during installations. The distribution fiber fans out into 900µm tight buffered fibers, color coded to TIA-598-A industry standards. These pigtails are available in Singlemode or Multimode, 6-packs or 12-packs, and your choice of connectors. All pigtails feature low insertion loss, low back reflection and are made with Corning® fiber. Standard length of 3 meters: 1 meter 900µm 'fan out' and 2 meter distribution 'tail'.

**6 FIBER PIGTAILS (COLOR CODED)**

PART #	DESCRIPTION	PRICE
DS-P6SCUPC-BU	6 Fiber SC/UPC Distribution Style Pigtail, SM, Blue Boots	\$14.95
DS-P6SCAPC-GR	6 Fiber SC/APC Distribution Style Pigtail, SM, Green Boots	15.95
DS-P6LCUPC-BU	6 Fiber LC/UPC Distribution Style Pigtail, SM, Blue Boots	16.30
DS-P6LCAPC-GR	6 Fiber LC/APC Distribution Style Pigtail, SM, Green Boots	17.50
DS-P6SCMM50G-AQ	6 Fiber SC/UPC Distribution Style Pigtail, MM, 50µm, OM3 Aqua Boots	16.25
DS-P6LCMM50G-AQ	6 Fiber LC/UPC Distribution Style Pigtail, MM, 50µm, OM3 Aqua Boots	24.90

**12 FIBER PIGTAILS (COLOR CODED)**

PART #	DESCRIPTION	PRICE
DS-P12SCUPC-BU	12 Fiber SC/UPC Distribution Style Pigtail, SM, Blue Boots	\$21.80
DS-P12SCAPC-GR	12 Fiber SC/APC Distribution Style Pigtail, SM, Green Boots	23.80
DS-P12LCUPC-BU	12 Fiber LC/UPC Distribution Style Pigtail, SM, Blue Boots	24.30
DS-P12LCAPC-GR	12 Fiber LC/APC Distribution Style Pigtail, SM, Green Boots	26.00
DS-P12SCMM50G-AQ	12 Fiber SC/UPC Distribution Style Pigtail, MM, 50µm, OM3 Aqua Boots	21.80
DS-P12LCMM50G-AQ	12 Fiber LC/UPC Distribution Style Pigtail, MM, 50µm, OM3 Aqua Boots	27.20

**RIBBON FAN-OUT PACKS**

These Ribbon fiber pigtails fan out into 900µm tight buffered fibers, color coded to TIA-598-A industry standards. Applications include terminating ribbon fiber to patch panels and enclosures, as well as V-Groove and array applications. All fan out kits feature low insertion loss, low back reflection and are made with Corning® fiber. Standard length of 3 meters: 1 meter 900µm 'fan out' and 2 meter ribbon 'tail'.

PART #	DESCRIPTION	PRICE
RF-3-BU-P-S-3-FIS-12	SM, SC/UPC - Pigtail, 3 Meters 36" Fan-out, 2 Meter Tail, 12 Fiber	\$65.00
RF-3-BA-P-S-3-FIS-12	SM, SC/APC - Pigtail, 3 Meters 36" Fan-out, 2 Meter Tail, 12 Fiber	75.00
RF-3-AU-P-S-3-FIS-12	SM, FC/UPC - Pigtail, 3 Meters 36" Fan-out, 2 Meter Tail, 12 Fiber	65.00
RF-3-AA-P-S-3-FIS-12	SM, FC/APC - Pigtail, 3 Meters 36" Fan-out, 2 Meter Tail, 12 Fiber	75.00

**FIS SNAP PACKS™**

These pre-terminated "Snap Pack" adapter panels provide convenience to technicians splicing into fiber distribution frames. Adapter panels are LGX compatible and can be ordered in a black or off white color. Available in 6 or 12 fiber bundles and color coded to TIA-598-A industry standards, these fiber bundles provide cable management from patch panels to splice bays. **Custom lengths and various connector styles are available, contact your FIS sales associate for more information.**

PART # (Off White)	PART # (Black)	DESCRIPTION	PRICE
F1-SC6LS-SPN	F1-SC6LS-SPN-BLK	(6) Adapters, SC/UPC, 6 Fiber Pigtail, Singlemode, 3 Meters	\$60.00
F1-DSC6LS-SPN	F1-DSC6LS-SPN-BLK	(6) Duplex Adapters, SC/UPC, 12 Fiber Pigtail, Singlemode, 3 Meters	120.00
F1-SC6APC-SPN	F1-SC6APC-SPN-BLK	(6) Adapters, SC/APC, 6 Fiber Pigtail, Singlemode 3 Meters	65.00
F1-DSC6IAPC-SPN	F1-DSC6IAPC-SPN-BLK	(6) Duplex Adapters, SC/APC, 12 Fiber Pigtails, Singlemode, 3 Meters	130.00
F1-SC6LM-SPN	F1-SC6LM-SPN-BLK	(6) Adapters, SC/PC, 6 Fiber Pigtails, 62.5/125µm, 3 Meters	50.00
F1-DSC6LM-SPN	F1-DSC6LM-SPN-BLK	(6) Duplex Adapters, SC/PC, 12 Fiber Pigtail, 62.5/125µm OM1, 3 Meters	80.00
F1-DSC6LM50-SPN	F1-DSC6LM50-SPN-BLK	(6) Duplex Adapters, SC/PC, 12 Fiber Pigtails, 50/125µm, 3 Meters	50.00
F1-DSC6LM50G-SPN	F1-DSC6LM50G-SPN-BLK	(6) Duplex Adapters, SC/PC, 12 Fiber Pigtails, 50/125µm OM3 10G, 3 Meters	50.00
F1-LC6DL-SPN	F1-LC6DL-SPN-BLK	(6) Duplex Adapters, LC/UPC, 12 Fiber Pigtail, Singlemode, 3 Meters	120.00
F1-LC6DLM-SPN	F1-LC6DLM-SPN-BLK	(6) Duplex Adapters, LC/PC, 12 Fiber Pigtails, 62.5/125µm, 3 Meters	80.00
F1-LC6DLM50-SPN	F1-LC6DLM50-SPN-BLK	(6) Duplex Adapters, LC/PC, 12 Fiber Pigtails, 50/125µm OM2, 3 Meters	80.00
F1-LC6DLM50G-SPN	F1-LC6DLM50G-SPN-BLK	(6) Duplex Adapters, LC/PC, 12 Fiber Pigtails, OM3 10G, 3 Meters	80.00
F1-LC6QDAPC-SPN	F1-LC6QDAPC-SPN-BLK	(6) Quad Adapters, LC/APC, 24 Fiber Pigtails, Singlemode, 3 Meters	195.00
F1-ST6LS-SPN	F1-ST6LS-SPN-BLK	(6) Adapters, ST, 6 Fiber Pigtail, Singlemode, 3 Meters	60.00
F1-ST6LM-SPN	F1-ST6LM-SPN-BLK	(6) Adapters, ST, 6 Fiber Pigtail, 62.5/125µm OM1, 3 Meters	50.00



RF-3-BU-P-S-3-FIS-12



F1-SC6LS-SPN



**SUMITOMO PRECISIONFLEX™ SLIDING PATCH PANEL**

Sumitomo Electric Lightwave's 4th Level® sliding patch panels are specifically designed for the flexibility to house high density cassettes or LGX cassettes/ interconnect panels by choosing either high density or LGX faceplates. A wide range of cable management options provide a variety of solutions and versatility for your particular application. The ideal choice for data center, storage area network (SAN), local area network (LAN), and central office/ headend applications, 4th Level™ panels facilitate easy installation, fiber access and maintenance for years of worry free service. Mounting brackets allow for forward and backward adjustment within a standard 19" relay rack or cabinet. These panels also feature a rugged construction with a user friendly design for no hassle installations.



PART #	DESCRIPTION	(HxWxD)	PRICE
FT01L03	Precisionflex™ 1RU Patch Panel; Holds 3 Fox™ Cassettes or 3 LGX Adapter Panels. Capacity = 72LC/36SC Adapters	17" x 14.75" x 1.75"	\$205.35
FT02L06	Precisionflex™ 2RU Patch Panel; Holds 6 Fox™ Cassettes or 6 LGX Adapter Panels. Capacity = 144LC/72SC Adapters	17" x 14.75" x 3.5"	245.55
FT03L09	Precisionflex™ 3RU Patch Panel; Holds 9 Fox™ Cassettes or 9 LGX Adapter Panels. Capacity = 216LC/108SC Adapters	17" x 14.75" x 5"	273.25
FT04L12	Precisionflex™ 4RU Patch Panel; Holds 12 Fox™ Cassettes or 12 LGX Adapter Panels. Vertically. Capacity = 288LC/144SC Adapters	17" x 14.75" x 7"	280.25

\* LGX Plates See Page 14 - Call or visit [www.fiberinstrumentsales.com](http://www.fiberinstrumentsales.com) for Sumitomo LGX or Fox Cassettes.



**AFL WALL MOUNT ENCLOSURES**

AFL's wall mount interconnect enclosures provide a convenient convergence point for interconnecting and/ or splicing in wall mount applications. Provisioned for LGX compatible adapter plates or optical modules, the enclosure features a well-engineered solution for fiber and cable management on both the ingress and egress openings of the enclosure.



PART #	DESCRIPTION	(HxWxD)	PRICE
WME-02	AFL Wall Mount Enclosure, Holds up to (2) LGX Adapter Plates	12.0" x 14.0" x 2.5"	\$95.00
WME-04	AFL Wall Mount Enclosure, Holds up to (4) LGX Adapter Plates	12.0" x 14.0" x 3.63"	135.00

**AFL FIBER TERMINATION PATCH PANELS**

AFL's fiber termination panels are designed for use as a rack mount interconnect panel and feature universal 19/23" EIA/TIA rack compatibility. They are LGX compatible with industry standard adapter plates and cassettes.



PART #	DESCRIPTION	(HxWxD)	PRICE
FM001038-BE	AFL Patch Panel, 1RU, Holds up to (3) LGX Adapter Plates	1.75" x 17" x 13.51"	\$129.00
FM001029-BE	AFL Patch Panel, 2RU, Holds up to (6) LGX Adapter Plates	3.5" x 17" x 13.51"	177.00
C211372-BE	AFL Patch Panel, 4RU, Holds up to (12) LGX Adapter Plates	7" x 17" x 11"	279.00

**AFL LGX ADAPTER PLATES**

AFL adapter plates are compatible with LGX industry standard platforms allowing for easy upgrades within existing panels. Adapter plates come preloaded with mating sleeves and are available in 6, 12 and 24 port configurations.

PART #	DESCRIPTION	PRICE
FM003104	LGX Adapter Plate, Simplex ST, MM, 6 Fiber	\$26.95
FM003126	LGX Adapter Plate, Duplex ST, SM, 12 Fiber	48.25
FM003096	LGX Adapter Plate, Simplex SC, MM, 6 Fiber	33.25
FM003100	LGX Adapter Plate, Simplex SC, SM, 6 Fiber	33.25
FM003293	LGX Adapter Plate, Duplex SC, MM, 12 Fiber	49.50
FM003297	LGX Adapter Plate, Duplex SC, SM, 12 Fiber	51.50
FM003295	LGX Adapter Plate, Duplex SC, MM (OM3 and OM4), 12 Fiber	51.50
FM003420	LGX Adapter Plate, Simplex FC, SM/MM, 6 Fiber	35.00
FM003110	LGX Adapter Plate, Duplex LC, MM, 12 Fiber	56.95
FM003465	LGX Adapter Plate, Duplex LC, SM, 12 Fiber	56.95
FM003208	LGX Adapter Plate, Quad LC, SM, 24 Fiber	105.00
FM003206	LGX Adapter Plate, Quad LC, MM (OM3 and OM4), 24 Fiber	110.00



Fiber solutions for Fanout, Splice, Patch, Conversion and Tap applications

For more information, contact your FIS Sales Representative.



[AFLglobal.com/ASCEND](http://AFLglobal.com/ASCEND)

CORNING

CORNING offers enterprise network complete tip-to-tip fiber optic product solutions. CORNING hardware products include CCH housing panels, CCH & PCH rack mounts, WSH wall mounts and splice trays.

### CORNING CABLE SYSTEMS WALL MOUNT ENCLOSURES

These metal cabinet units are suitable for loose tube and tight-buffered fiber optic cables. Enclose your fiber optic connections and, for extra protection, locking kits are available for purchase. Accepts CCH cassettes and panels only. Does not accept any splice trays or holders including the CORNING M67 splice tray series. **\*Adapter Panels and Cassettes not included.**

PART #	DESCRIPTION	(HxWxD)	PRICE
SPH-01P	6 Fiber Wall Mount (1) CCH Adapter Panel	6.3" x 5.5" x 2.0"	\$66.25
WCH-02P	12 Fiber Wall Mount, Up to (2) CCH Adapter Panels	9.25" x 13.25" x 3.25"	97.25
WCH-04P	24 Fiber Wall Mount, Up to (4) CCH Adapter Panels	13.5" x 16" x 4"	168.00
WCH-06P	48 Fiber Wall Mount, Up to (6) CCH Adapter Panels	13.5" x 16" x 4"	233.50
WCH-CLSSC12P	144 Fiber Wall Mount, Up to (12) CCH Adapter Panels	13.5" x 22.5" x 5"	358.00
CCHCS	Unloaded CCH Splicing Cassette accepts one CCH panel and up to 24 single-fiber or six ribbon heat-shrink splice protectors		139.00



WCH-02P



WSH-16SPT

### CORNING CABLE SYSTEMS WALL MOUNT SPLICE HOUSINGS

The Corning Cable Systems WSH is designed to store fibers being spliced within the unit. The front door doubles as a work surface that can support the weight of a fusion splicer. Multiple cable entry/exit ports are provided on each side in addition to top and bottom. Grounding kits are available for purchase separately.

PART #	DESCRIPTION	(HxWxD)	PRICE
WSH-11SPTF	Wall Mount Splice Housing, Up to 11 Trays (Type 4S, 4R or 4A)	13.5" x 22.5" x 5.2"	\$310.00
WSH-16SPT	Wall Mount Splice Housing, Up to 16 Trays (Type 2S, 2R or 2M)	13.5" x 22.5" x 5.2"	305.00

### CORNING CABLE SYSTEMS CONNECTOR HOUSING

Closet connector housings (CCHs) provide interconnect or cross-connect capabilities between outside plant, riser or distribution cables and opto-electronics. The 1U, 2U and 4U options feature a slide-out tray and see-through, removable top covers. The housings accept CCH connector panels, cassettes and modules. **\*Adapter Panels and Cassettes not included**

PART #	DESCRIPTION	(HxWxD)	PRICE
CCH01U	Corning CCH Closet Connector Housing accepts 2 CCH panels	1.75" x 19" x 17"	\$238.00
CCH02U	Corning CCH Closet Connector Housing accepts 4 CCH panels	3.5" x 19" x 17"	285.00
CCH04U	Corning CCH Closet Connector Housing accepts 12 CCH panels	7" x 19" x 17"	375.00



CCH01U

### CORNING CABLE SYSTEMS PRETIUM™ CONNECTOR HOUSING

Corning PCH housings are four inches deeper than standard CCH housings for installing splice tray holding option. PCH-04 series contains an integral hinged jumper manager on the front of the housing. The PCH-01U housing has a removable top that slides forward with simple release providing access to interior components. Accepts CCH cassettes and panels. **\*Adapter Panels and Cassettes not included.**

PART #	DESCRIPTION	(HxWxD)	PRICE
PCH-01U	12 Fiber, 1U - accepts (2) CCH panels	1.75" x 17" x 16"	\$350.00
PCH-02U	24 Fiber 2U - accepts (4) CCH panels	3.5" x 17" x 16.5"	450.00
PCH-04U	72 Fiber, 4U - accepts (12) CCH panels	7" x 17" x 16"	550.00
PC1-SPLC-04R	Splice Tray Bracket for PCH-01U, accepts (4) type 2S trays or (2) type 4R trays. (See Below)		42.95
PC2-SPLC-65R	Splice Tray Bracket for PCH-02U, accepts (6) 2R/2S or (3) 4R/4S trays. (See Below)		44.50
PC4-SPLC-12SR	Splice Tray Bracket for PCH-04U, accepts (12) type 2S or (7) type 4S trays. (See Below)		164.00



PCH-04U

### CORNING CABLE SYSTEMS ADAPTER PANELS FOR CCH, WCH AND EDC SERIES

The Closet Connector Housing (CCH) panels are available in a variety of adapter styles for use with CORNING enclosures. Manufactured from steel, they are designed to be robust. Choose from the selection below or ask an FIS representative for other configurations.

PART #	DESCRIPTION	PRICE
CCH-CP12-15T	Twelve ST MM, Ceramic Insert	\$75.00
CCH-CP12-19T	Twelve ST SM, Ceramic Insert	85.00
CCH-CP12-91	Six Duplex SC MM, Metal Insert	73.25
CCH-CP12-59	Six Duplex SC SM, Ceramic Insert	97.50
CCH-CP12-E7	Six Duplex SC, 10 Gig - Aqua	95.00
CCH-CP12-A9	Six Duplex LC SM, UPC, Ceramic Insert	113.00
CCH-CP24-A9	Twelve Duplex LC SM, UPC, Ceramic Insert	205.00
CCH-CP12-E4	Six Duplex LC, 10 Gig - Aqua	95.95
CCH-CP24-E4	Twelve Duplex LC, 10 Gig - Aqua	170.00

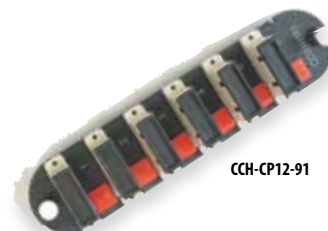

CCH-CP12-91

### CORNING CABLE SYSTEMS SPLICE TRAYS

Designed for use with Corning interconnection hardware and splice closures, these splice trays are an integral part of a complete splicing system. The trays are engineered for use with indoor or outdoor splice hardware with both loose tube and tight-buffered optical cables.

PART #	DESCRIPTION	PRICE
M67-081	Splice Tray, Type 2S, Twelve Heat Shrink Sleeves	\$41.95
M67-110	Splice Tray, Type 4R, Twelve Heat Shrink or 6 Ribbon Shrink, For CORNING Wall Mounts	39.95
M67-112	Splice Tray, Type 2S, Twenty Four Heat Shrink Sleeves	45.95
M67-087	Splice Tray, Type 4S, Twelve Mechanical Campsplice Splices	42.95
M67-076	Splice Tray, Type 4S, Twelve Fusion Splices, For CORNING Rack Mountable Housings	49.50
M67-048	Splice Tray, Type 2S, Twelve Fusion Splices, For CORNING Splice Closures	45.00
SCFST077	Corning Universal Splice Tray	35.95



M67-048

.2"(H) x 13.25"(W) x 3.9(D)



## MOLEX COMPACT WALL MOUNT

This low profile wall mount enclosure is constructed of white rugged plastic and provides internal fiber management options. It accepts up to eight fusion or mechanical splices. The included accessory kit contains mounting screws, an identification label and two cable ties.

PART #	DESCRIPTION	(HxWxD)	PRICE
WFR-00010-02	6 Port, ST, SM/MM, White, Loaded	7.25" x 5" x 1.5"	\$41.95
WFR-00030-02	6 Port, Simplex SC, Duplex LC, White, Unloaded	7.25" x 5" x 1.5"	30.00
WFR-00028-02	8 Ports, Duplex SC, MM, White, Loaded	7.25" x 5" x 1.5"	59.95
WFR-00029-02	8 Ports, Duplex SC, SM, White, Loaded	7.25" x 5" x 1.5"	88.95



## FIS COMPACT WALL BOX

Utilize this compact wall mount box for fusion splice sleeve storage or direct connector termination. Simply place two small cable ties through the back of the box, slide the cable (max 5mm OD) into the box and secure. Next use the small cable management spool to store some slack prior to splicing or termination. There are two knock-out slots on each side of the box for (2) SC simplex or LC duplex adapters. There are also two knock-out slots on each side of the box for (1) SC duplex or LC quad adapter. Adapters without flanges are required. Built in splice sleeve holders accommodate up to two 40mm heat shrink splice sleeves.

PART #	DESCRIPTION	(HxWxD)	PRICE
F1-CWB02	FIS Compact Wall Box, White	4" x 3.25" x 1"	\$15.00



## FIS SPLICE ENCLOSURE

The FIS splice enclosure utilizes a 12 position molded splice chip to secure splices. It is wall mountable and recommended for installation within controlled environments. Cable entry grommets secure incoming and outgoing cable with an outer diameter between 7mm and 12mm. Internal fiber management guides provide the ability to coil excess fiber.

PART #	DESCRIPTION	(HxWxD)	PRICE
F1-4868-FSS	Fusion Splice Enclosure (up to 7mm cable diameter)	6.75" x 4.75" x 2.125"	\$52.25
F1-4868-MSS	Mechanical Splice Enclosure (up to 7mm cable diameter)	6.75" x 4.75" x 2.125"	52.25
F1-4868-FLL	Fusion Splice Enclosure (7mm to 12mm cable diameter)	6.75" x 4.75" x 2.125"	52.25
F1-4868-MLL	Mechanical Splice Enclosure (up to 7mm cable diameter)	6.75" x 4.75" x 2.125"	52.25

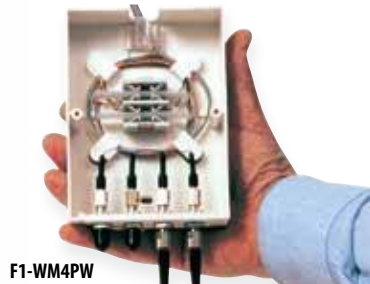

## FIS 4 PORT WALL MOUNT

The FIS 4 Port Wall Mount box is a compact design ideal for data center applications. It can be wall mounted or placed in a floor box, and will house up to 4 fibers, inline adapters and pigtails. Cables are easily terminated or spliced together. This wall mount box also has options for incoming fiber to be presented via mini-trunking grommets. Adapters and splice chip sold separately.

PART #	DESCRIPTION	(HxWxD)	PRICE
F1-WM4PW	4 Port, Holds (4) ST/FC Adapters, Unloaded	6.5" x 5" x 1.5"	\$13.75
F1-WM4S	8 or 16 Port, Holds (4) Duplex SC or (4) Quad LC Adapters, Unloaded	6.5" x 5" x 1.5"	16.95



## PLP COYOTE WALL MOUNT MULTI-PURPOSE CLOSURE (MPC)

A versatile high performance demarcation closure for indoor or outdoor applications. With its unique interior grid pattern the MPC allows for custom configuration and mounting of a wide array of components. NEMA 4 rated and supplied with knockouts for up to 8 entry points. Contact an FIS sales representative for custom configurations. Bulkhead kit is compatible with PLP adapter plates (not LGX compatible).

PART #	DESCRIPTION	(HxWxD)	PRICE
COYMPC-000	COYOTE Standard MPC (Empty)	16" x 14" x 4"	\$104.55
COYMPC-D000	COYOTE Deep MPC (Empty)	16" x 14" x 8"	154.40
80808618	Stepped Grommet Kit, Bag of 4 (.07" - 1.0")		15.60
80808916	Empty Bulkhead Kit for Standard or Deep MPC, Accepts 2 Adapter Modules		11.50
80808960	Empty Bulkhead Kit for Deep MPC ONLY - Accepts 4 Adapter Modules		18.00
8003814	Splice Platform for Single Fusion splices		12.60

## CORNING

Also Suitable for Outdoor Use!



## CCS ENVIRONMENTAL DISTRIBUTION CENTER (EDC)

Corning Cable Systems EDC product family continues to set the standard for the future of interconnect hardware. These units are designed for the protection of fiber optic connections and splices in indoor or outdoor environments; the EDC is ideal for industrial, marine, security, or traffic control applications. The EDC series accepts CCH panels and splice trays. Does not accept CCH cassettes. No entry holes provided on EDC series cabinets. NEMA 4X Rated. Also Available in Stainless Steel.

PART #	DESCRIPTION	(HxWxD)	PRICE
EDC-02PNH	Accepts 2 CCH Adapter Panels	12.5" x 10.5" x 6.25"	\$426.50
EDC-06PNH	Accepts 6 CCH Adapter Panels	16.5" x 14.5" x 8.3"	532.00
EDC-12PNH	Accepts 12 CCH Adapter Panels	18.6" x 16.6" x 10.3"	621.75
EDC-2N4-KIT	Two NEMA 4 Rated Conduit Fittings for Two-Inch Conduit		95.00
EDC-2EC-KIT	Two Non-Rated Conduit Fittings for Two-Inch Conduit		29.95
EDC-2WT-KIT	Two Watertight Compression Fittings (not intended to mate with conduit)		45.00
HDWR-GRND-KIT	Hardware Grounding Kit: Includes Two Ground Wires, Sheath Ground Clip and Bus		39.95

## 1 RU MODULAR TEST ACCESS POINT (TAP) PANEL

This 1RU modular chassis can be loaded with up to (3) Mini TAP modules, providing monitoring access for (18) access points. Each Mini TAP module has (6) monitor ports. The monitor ports are located in the rear of the unit and are protected by a removable shield. Each monitor port is pre-loaded with terminators, preventing high back reflections on SFPs and test equipment. It uses passive fiber optic couplers that are non-band specific, and the panel can be used for either High Band or Low Band connections.

PART #	DESCRIPTION (19" or 23" Rack)	(HxWxD)	PRICE
1RUCM18CPRI	1RU Modular TAP Panel, Loaded with (3) Modules	1.7" x 17" x 13.5"	\$1,965.00
CPRI6RRHSPM	TAP Module, (6) Access Points Links, Use with 4RUCM or 1RUCM		670.00



1RUCM18CPRI

## 2 RU TEST ACCESS POINT (TAP) PANEL WITH CABLE MANAGEMENT

The 2RU TAP interface drawer features integrated cable management to route incoming standard or HybriFlex cables within the enclosure. This panel provides test access for up to (6) active TAP Links. It uses passive fiber optic couplers that are non-band specific, and the panel can be used for either High Band or Low Band connections. All necessary mounting hardware, including 19" and 23" brackets are included.

PART #	DESCRIPTION	(HxWxD)	PRICE
2RUCMCPRI03	2RU Cable Mgmt Drawer w/Integrated TAP Module	3.469" x 17" x 14.68"	\$1,059.00



2RUCMCPRI03

## 4 RU 19" HIGH DENSITY TEST ACCESS POINT (TAP) PANEL

This 19" Wide 4RU High Density TAP interface panel has capacity for up to (12) Mini TAP interface modules. This enclosure provides test access for up to (72) active links when loaded with (12) Mini TAP interface modules. Once loaded with modules, fibers from the Tx/BBH and Rx/RRH are routed into the front of the unit and monitoring access is located in the back of the chassis. Cable management rings and tie downs are integrated to organize incoming fibers within the front of the chassis.

PART #	DESCRIPTION	(HxWxD)	PRICE
CPRI4RU19	4RU High Density TAP Access Chassis, 19", Unloaded, Up to (12) Modules	6.92" x 19" x 16.83"	\$405.00
CPRI6RRHSPM	TAP Module, (6) Access Points Links, Use with 4RUCM or 1RUCM		670.00

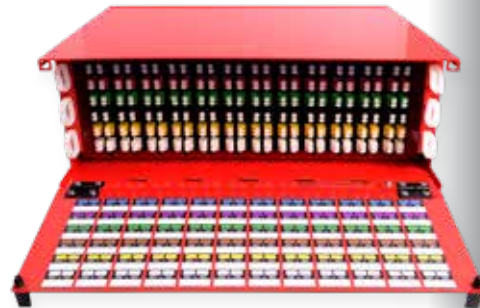

CPRI4RU19

## TAP ACCESS MODULE

Network modules are available in preloaded enclosures or sold separately.

PART #	DESCRIPTION	PRICE
CPRI6RRHSPM	TAP Module, (6) Access Points Links, Use with 4RUCM or 1RUCM	\$670.00

## FIS FIBER OPTIC CROSS-CONNECT ENCLOSURE

This polycarbonate enclosure is a great alternative to steel enclosures with features such as partial molded hinges and poured in polyurethane gasket for the best sealing from weather elements. Optional mounting features include ears for wall mounting or bands for pole mounting. Two entrance glands on bottom of enclosure accept (1) trunk cable and up to (5) 5.5-6mm round drop cables for FTTH or Remote Radio Head (RRH) applications. Side latch features hole for pad lock to secure enclosure.

Enclosure supports cross connecting of up to 48 fibers with LC duplex adapters or 24 fibers with simplex SC style adapters. The adapters are mounted on an angle to provide better cable management, avoiding tight bend radius. The front panel tips forward to allow technician access to cable management rings and bridge stances to secure cable slack and dress appropriately feeding adapter panel. This unique feature allows for cleaning or video inspection of connectors inside adapters prior to mating with other connectors. Supports LCAPC, LCUPC, SCAPC and SCUPC adapters and accepts factory terminated connectors with the use of larger liquid tight cable compression glands.

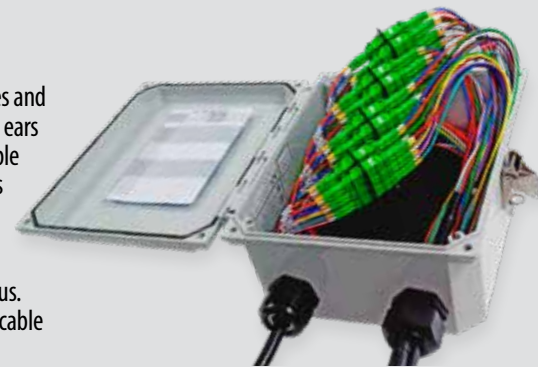

F1CF48LCAPC

PART #	DESCRIPTION	(HxWxD)	PRICE
F1CF24SCUPC	24 Fiber Cross Connect Enclosure with installed SCUPC adapters, 2 entry/exit glands	10" x 8" x 4"	\$215.00
F1CF24SCAPC	24 Fiber Cross Connect Enclosure with installed SCAPC adapters, 2 entry/exit glands	10" x 8" x 4"	230.00
F1CF24LCUPC	24 Fiber Cross Connect Enclosure with installed LCUPC adapters, 2 entry/exit glands	10" x 8" x 4"	225.00
F1CF24LCAPC	24 Fiber Cross Connect Enclosure with installed LCAPC adapters, 2 entry/exit glands	10" x 8" x 4"	230.00
F1CF48LCUPC	48 Fiber Cross Connect Enclosure with installed LCUPC adapters, 2 entry/exit glands	10" x 8" x 4"	250.00
F1CF48LCAPC	48 Fiber Cross Connect Enclosure with installed LCAPC adapters, 2 entry/exit glands	10" x 8" x 4"	265.00

- Polycarbonate, NEMA 4X Rated, UL Listed Enclosure
- Dimensions: 10" x 8" x 4"
- Trunk Cable Entrance Grommet optimized for 0.48" cable outer diameter
- Drop Cable Entrance Grommet optimized for up to (5) 5.5-6.0mm round cables
- Lockable with pad lock
- Supports up to 48 fibers
- Withstands harsh environment with poured gasket



F1-6707BLKF

F1-SPL12



F1-SPL192



F1-6808

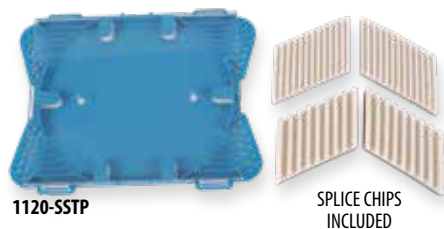

1120-SSTP

SPLICE CHIPS INCLUDED

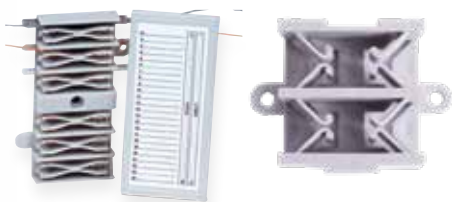

F1-8731

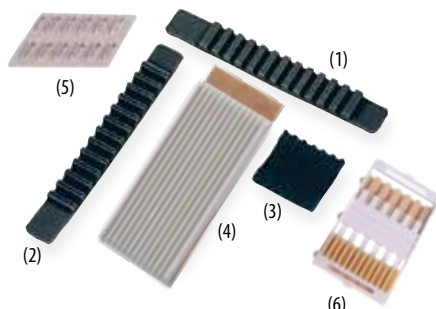

**FIS ALUMINUM SPLICE TRAYS**

The FIS aluminum splice trays are compact, lightweight, and available with a variety of splice holding chips and cover options. All trays are pre-configured for standard heat shrink fusion splices unless otherwise stated. Any stocked splice holder chip can be pre-loaded into this splice tray. See splice holding chip options below. Each splice tray features a mounting hole to fasten the tray down using a mounting stud and nut. Self adhesive Velcro dots are included with F1-SPL12, F1-SPL24 and F1-6707 to secure the tray in place.

PART #	DESCRIPTION	PRICE
F1-SPL12	Aluminum Splice Tray, 12 Position, Fusion Splice Chip, Rigid (6.5"L x 4.68"W x .42"H)	\$17.95
F1-SPL24	Aluminum Splice Tray, 24 Position, Fusion Splice Chip, Rigid (11.72"L x 3.99"W x .41"H)	18.95
F1-SPL24-8.5	Aluminum Splice Tray, 24 Position, Fusion Splice Chip, Rigid (8.5"L x 5"W x .42"H)	18.95
F1-SPL192	Aluminum Splice Tray, 16 Position, Mass Fusion/Ribbon Splice Chip, Rigid (11.72"L x 3.99"W x .42"H)	18.95
F1-8735C	Aluminum Splice Tray, 12 Position, Clear Plastic Cover, Fusion Splice Chip, Rigid (7.13"L x 4.13"W x .38"H)	14.75
F1-8729G	Aluminum Splice Tray, 12 Position, Clear Plastic Cover, Fusion Splice Chip, Rigid (11.75"L x 4"W x .38"H)	18.00
F1-6707BLKF	Aluminum Splice Tray, 12 Position, Fusion Splice Chip, Soft (7.5"L x 4"W x .63"H)	14.95
F1-6707BLKM	Aluminum Splice Tray, 12 Position, Mechanical Splice Chip, Soft (7.5"L x 4"W x .63"H)	14.95
F1-6707BLKR	Aluminum Splice Tray, 12 Position, Bare Fiber Splice Chip, Rigid (7.5"L x 4"W x .63"H)	16.95
F1-6707BLKH	Aluminum Splice Tray, 6 Position, Fusion Splice Chip, Rigid (7.5"L x 4"W x .63"H)	14.95

**FIS PLASTIC SPLICE TRAYS**

The FIS Splice Tray is injection molded using UL94 fire retardant material. The tray is designed to fit in most splice closures and can accommodate 12 fusion, mechanical, or bare fiber splices. Any stocked splice holder chip can be pre-loaded into this splice tray. See splice holding chip options below. Features include: Fiber routing molded into the tray, fiber tie down holes, snap or slide together construction, designation label, self adhesive Velcro dots to secure the tray in place, and nylon cable tie wraps.

PART #	DESCRIPTION	DIMENSIONS (LxWxH)	PRICE
F1-6808	Plastic Splice Tray, 12 Position, Fusion Splice Chip, Rigid	7.1" x 4.25" x .48"	\$11.95
F1-6808M	Plastic Splice Tray, 12 Position, Mechanical Splice Chip, Soft	7.1" x 4.25" x .48"	11.95
F1-6808BA	Plastic Splice Tray, 12 Position, Bare Fiber Fusion Splice Chip, Rigid	7.1" x 4.25" x .48"	15.95

**STARFIGHTER SPLICE TRAYS**

Starfighter Splice Trays are designed for use with the Multilink Starfighter series of closures. Each splice tray can accommodate single fusion, bare fusion and ribbon fusion protection sleeves as well as mechanical splices. Starfighter splice trays are durable to protect and hold your splice with confidence.

PART #	DESCRIPTION	DIMENSIONS (LxWxH)	PRICE
1120-SSTA	Aluminum Splice Tray, 12 Position, For 1120-F Closure	6.5" x 4.75" x 0.5"	\$23.95
1120-SSTP	Plastic Splice Tray, 12 Position, For 1120-F Closure	5.13" x 6.5" x 0.5"	20.25
2000-SSTA	Aluminum Splice Tray, 24 Position, For 2000-F Closure	4" x 11.75" x 0.5"	41.75
3000-SSTA	Aluminum Splice Tray, 24 Position, For 3000F Closure	6" x 7.75" x 0.5"	41.75
3030-SSTP	Plastic Splice Tray, 24 Position, For 3000-F Closure	5.75" x 8.25" x 0.5"	25.00
4048-SSTP	Plastic Splice Tray, 24 Position, For 4000-D Closure	9.75" x 4.5" x 0.5"	21.50

**FIS SPLICE BRIDGES**

The FIS splice support bridge is available in two basic designs. The 4 way splice bridge will accept 4 fusion or mechanical splices. It is compatible with the FIS 4 Port Wall Mount (P/N F1-WM4PW and F1-WM4S). The 24 way splice bridge will accept up to 12 mechanical or 24 fusion splices. It is supplied with a protective lid that includes a designation label. Both splice bridges have adhesive backings.

PART #	DESCRIPTION	DIMENSIONS (LxWxH)	PRICE
F1-8730	Plastic Splice Bridge, 4 Way, Accepts 4 Fusion or Mechanical Splices, Adhesive Backing	1.25" x 1.75" x .68"	\$2.95
F1-8731	Plastic Splice Bridge, 24 Way, Accepts 12 Mechanical or 24 Fusion Splices, Adhesive Backing	3.85" x 2.53" x .63"	4.25

**FIS FUSION AND MECHANICAL SPLICE HOLDING CHIPS**

FIS offers several styles of splice holding chips to secure splice sleeves. For chips with non-adhesive backing, use double sided tape or epoxy to adhere to mounting surfaces. Upon request FIS will install any stock splice chip in your FIS splice tray.

PART #	DESCRIPTION	PRICE
F1-6707FCM	Fusion Splice Chip, 12 Position, Soft, Non-Adhesive Backing (1)	65¢
F1-6707MCM	Mechanical Splice Chip, 12 Position, Soft, Non-Adhesive Backing (2)	65¢
USC-HS	Heat Shrink Splice Chip, 6 Position, Rigid, For Standard/Slim Sleeves, Adhesive Backing (3)	\$1.75
F1-105612	Bare Fiber Fusion Splice Chip, 12 Position, Rigid, Adhesive Backing, 12/pack (4)	73.25
FSH-LDR	Fusion Splice Chip, 12 Position, Plastic, Adhesive Backing (5)	2.95
275897-000	Raychem/Tyco Splice Chip, 12 Position, Plastic, For Use In FOSC Trays (6)	2.25

**19" FLUSH MOUNT ADAPTER BRACKETS**

The 19" Flush Mount Adapter Brackets are designed to reposition your enclosure from a standard position to a flush mounted depth on all FIS rack mount enclosures. When installed, these brackets move the enclosure 3.5" back in the rack, so the front of the enclosure sits flush against the rack opening. Compatible with FIS rack mount enclosures. Sold in pairs.

PART #	DESCRIPTION	PRICE
1RURACKADP19FLUSH	1RU 19" Flush Mount Rack Adapter, Black	\$14.95
1RURACKADP19FLUSHBW	1RU 19" Flush Mount Rack Adapter, Off White	14.95
2RURACKADP19FLUSH	2RU 19" Flush Mount Rack Adapter, Black	19.95
2RURACKADP19FLUSHBW	2RU 19" Flush Mount Rack Adapter, Off White	19.95
4RURACKADP19FLUSH	4RU 19" Flush Mount Rack Adapter, Black	24.95
4RURACKADP19FLUSHBW	4RU 19" Flush Mount Rack Adapter, Off White	24.95

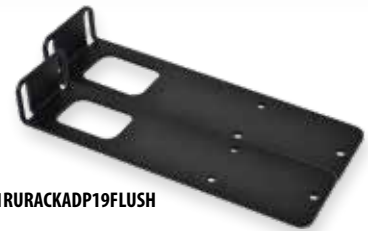

1RURACKADP19FLUSH



1RURACKADP23

**23" MOUNTING BRACKETS**

This bracket enables you to fit your 19" rack mount into a 23" wide rack. Compatible with FIS rack mount enclosures, select the appropriate size for the enclosure. Two 4RU sets are required for the 8RU rack mount enclosure. Sold in pairs.

PART #	DESCRIPTION	PRICE
1RURACKADP23	1RU 23" Rack Adapter, Black	\$14.95
1RURACKADP23BW	1RU 23" Rack Adapter, Off White	14.95
2RURACKADP23	2RU 23" Rack Adapter Black	19.95
2RURACKADP23BW	2RU 23" Rack Adapter, Off White	19.95
2RURACKADP23FLUSH	2RU 23" Flush Mount Rack Adapter, Black	19.95
2RURACKADP23FLUSHBW	2RU 23" Flush Mount Rack Adapter, Off White	19.95
4RURACKADP23	4RU 23" Rack Adapter Black	24.95
4RURACKADP23BW	4RU 23" Rack Adapter, Off White	24.95



F1-MCMB

F1PCM100

**CABLE MANAGEMENT SPOOLS**

These Cable Management Spools come in a pair of two and are compatible with FIS rack and wall mount enclosures. Ideal for storing slack cable and managing incoming and outgoing fibers.

PART #	DESCRIPTION	PRICE
F1MCMB	Metal Cable Management Spool, .75" Height	\$16.25
F1PCM100	Plastic Cable Manager Spool, 1" Height	10.00
F1PCM084	Plastic Cable Manager Spool, 0.84" Height	10.00



F113187

**CABLE RETENTION RINGS**

Use these Cable Retention Rings to manage incoming and outgoing fibers on the front of FIS rack mount enclosures.

PART #	DESCRIPTION	PRICE
F113187	Cable Retention Rings, White, 10 Pack, 1RU & 2RU, .75" Inside	\$3.95
F113189	Cable Retention Rings, White, 10 Pack, 4RU & 8RU, 1.0" Inside	3.95

**ALUMINUM INTERLOCKING ARMOR (AIA) GROUNDING KIT**

This grounding and bonding kit provides a grounding point for aluminum interlocking armor cable. It uses a 6 AWG insulated, high-flex grounding wire at 18" long. The included grounding clamps attach to both ends of a cable with an outside diameter ranging from 11.5mm to 16.0mm.

PART #	DESCRIPTION	PRICE
F1-GRBOKIT	FIS Aluminum Interlocking Armor Grounding and Bonding Kit	\$19.95



F1-GRBOKIT



**DID YOU KNOW...**

**What to Consider When Choosing an Interconnect Box**

When talking about interconnect boxes (also known as enclosures), there are a variety of options that can be used. Often, a common question asked by customers is which box would be best for their application. This is a loaded question that requires some questions and answers to see what will work best for the situation that they have in front of them.

There are a number of factors that will have to be addressed to come to a point where we can help to make a recommendation. Where is the interconnect going to be located, along with how many fibers are you going to be putting in the enclosure and if it will need to house fusion splices. Is there a 2 post rack existing or will you have to put that in as well? Does your job have a spec that you need to follow? Specs are written by engineers and sometimes they call out specific manufacturers that can be used for a job. Other specs are open to different manufacturers as long as it covers what is needed for the job or project.



F1-SR47RUTAP



F1FR45RU2PTAP



SFR Series

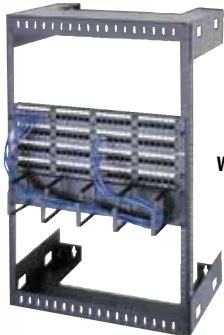

WM Series



WW3019-07-02

**FIS SERVER/NETWORK CABINETS**

These Server cabinets are designed to accommodate data center requirements for network switches and other applications like audio/video components. Features vented doors, adjustable mounting rails with silk screened numbers, optional casters and top exhaust fans for optimal temperature control. These cabinets are offered in both 47RU and 45RU construction with removable side panels for pairing cabinets.

PART #	DESCRIPTION	OVERALL DIMENSIONS (HxDxW)	PRICE
F1SR47RUTAP	Server Cabinet, 4 Post, 47RU Height, Steel Construction, Black	87" x 47" x 31.5"	\$1,799.00
F1SR42RUTAP	Server Cabinet, 4 Post, 42RU Height, Steel Construction, Black	80" x 46" x 23.5"	1,520.00
F1SRCHF	Casters Hardware and Adjuster foot kit for F1SR42RUTAP		80.00
F1NC47RU4PTAP	Network Cabinet, 47RU Height, Steel Construction	87" x 23.62" x 31.5"	800.00
F1RTF1000	Top Mount Cooling Fans, 4 High Output Fans w/ 6ft power Cord for Server Cabinet		115.00
F1RTF600	Top Mount Cooling Fans, 2 High Output Fans w/ 6ft power Cord for Network Cabinet		99.00

**19" ALUMINUM OPEN FRAME RACK**

These 2-Post Floor Mount Racks offer space saving convenience for mounting data and telecommunications equipment. Racks are numbered with rack units and tapped for #12-24 mounting screws. Additional units are available in 3ft and 4ft. heights. Call your FIS sales representative for details on shipping and racks not listed below.

PART #	DESCRIPTION	OVERALL DIMENSIONS (HxWxD)	PRICE
F1FR45RU2PTAP	2 Post Open Floor Rack, 45RU, 19" Rack Mounting, Steel	83.71" x 23.23"	\$149.00
F1FR45RU4PTAP	4 Post Open Floor Rack, 45RU, 19" Rack Mounting, Steel	83.71" x 23.62" x 29.53"	\$195.00
F1FR45RU4PSH	4 Post Open Floor Rack, 45RU, 19" Rack Mounting, Steel	83.71" x 23.62" x 29.53"	\$195.00

**SWING FRAME RACK**

This 19" Wall Mount Swing Frame Rack features an open-back wall mount design ideal for mounting over existing equipment and physical obstacles (conduit, telephone equipment, etc.). Use for mounting patch panels, hubs and switches in a secure room or closet. Rugged steel construction with 100lb weight capacity. Ships ready to assemble.

PART #	DESCRIPTION	OVERALL DIMENSIONS (HxWxD)	PRICE
SFR-12-18	12RU x18"D, Wall Mount, Swing Frame Rack	21" x 19" x 16"	\$183.00
SFR-12-24	12RU x24"D, Wall Mount, Swing Frame Rack	21" x 19" x 18"	235.00
SFR-20-18	20RU x18"D, Wall Mount, Swing Frame Rack	35" x 19" x 16"	235.00
SFR-20-24	20RU x24"D, Wall Mount, Swing Frame Rack	35" x 19" x 18"	300.00
SFR-25-18	25RU x18"D, Wall Mount, Swing Frame Rack	43.75" x 19" x 16"	300.00
SFR-25-24	25RU x24"D, Wall Mount, Swing Frame Rack	43.75" x 19" x 18"	348.75

\* Note: the SFR series does not include the patch panels, shelf, cables, or UPS shown in the pictures

**WALL-MOUNT RELAY RACKS**

This 19" Wall Mount Rack is self-squaring and allows for virtually any data or telecommunications component to be installed. Ideal for wall mounting fiber-optic equipment, its fixed design prevents kinking or breaking of glass fibers. Rugged steel construction; includes rack screws. Ships ready to assemble.

PART #	DESCRIPTION	OVERALL DIMENSIONS (HxWxD)	PRICE
WM-8-12	8RU x 12"D, Wall Mount, Rack	14" x 19" x 12"	\$135.00
WM-15-12	15RU x 12"D, Wall Mount, Rack	26.25" x 19" x 12"	155.00
WM-30-12	30RU x 12"D, Wall Mount, Rack	52.5" x 19" x 12"	235.00
WM-8-18	8RU x 18"D, Wall Mount, Rack	14" x 19" x 18"	155.00
WM-15-18	15RU x 18"D, Wall Mount, Rack	26.25" x 19" x 18"	168.00
WM-30-18	30RU x 18"D, Wall Mount, Rack	52.5" x 19" x 18"	185.00

**WALL MOUNT ENCLOSURES**

Wall Mount Enclosures offer a locking front door that is reversible for left or right side opening. Its swing out feature allows easy access to the back of equipment with a key lock to prevent tampering. Enclosures have vented fixed side panels for better air flow and pre-installed 110VAC 80CFM cooling fans to keep equipment running cool. It also includes adjustable cage nut rails and cage nuts with standard #12-24 mounting screws. Rails are marked with RU space index. Enclosure ships fully assembled. Additional enclosures are available with 20RU and 28RU heights. Call your FIS sales representative for details on shipping and enclosures not listed below.

PART #	DESCRIPTION	OVERALL DIMENSIONS (HxWxD)	PRICE
WM-3019-07-02	7RU Swing Out Wall Mount Enclosure, Black	15" x 20.5" x 23.5"	\$428.90
WM-3019-09-02	9RU Swing Out Wall Mount Enclosure, Black	18.5" x 20.5" x 23.5"	460.50
WM-3019-11-02	11RU Swing Out Wall Mount Enclosure, Black	22" x 20.5" x 23.5"	492.15
WM-3019-14-02	14RU Swing Out Wall Mount Enclosure, Black	27" x 20.5" x 23.5"	544.75
WM-3019-16-02	16RU Swing Out Wall Mount Enclosure, Black	30.5" x 20.5" x 23.5"	583.35



**SUPPORT SHELF FOR FIBER RACK MOUNT EQUIPMENT**

Economical support cantilever shelf designed for 19" two post free standing racks can reduce fatigue on mounting brackets when heavy, active equipment can only be fastened flush to the front of the rack. This support shelf has a fixed 2" (50mm) support cross bar at 18.5" to 21" and an additional adjustable support cross bar at 12" - 17" for heavier shorter equipment. Shelf mounts to rear of rack rails and straddles opening width so enclosures and equipment can be mounted below active gear to maximize rack space. Made of strong, lightweight aluminum, powder coated color black, recommended to support equipment up to 40lbs.

PART #	DESCRIPTION	PRICE
F1RMS5XB	Support Shelf for Rack Mount Equipment/Enclosure, (19" free standing rack)	\$75.00



**COOL AIRFLOW PASSIVE ENCLOSURE**

This 2RU Cool Airflow Enclosure has a Styrofoam pad affixed on top to dissipate the heat from active switches that may be located above enclosure. The 26"-31" telescopic enclosure moves cool air from cold aisle of a data center to opposite side of rack where switches that have air intakes for cooling may unfortunately be opposite the cold aisle. Based on mounting the 30 degree exhaust deflects the cool air above or below the enclosure into the air intake path of the active switches to aid in cooling. Four 3 inch high flow fans push the cold air through the enclosure out the rear exhaust duct to cool switches. AC/DC power supply included.

PART #	DESCRIPTION	PRICE
F143000391NF	Passive Air Flow Duct with High Air Flow (336CFM)	\$350.00



**VERTICAL CABLE MANAGEMENT**

These Vertical Cable Managers are designed for use with Floor Enclosures. We also offers a version supporting 2-post open frame racks. Constructed of a steel mounting plate with dual-sided finger duct, these managers have a cable capacity between 100 and 140 cables depending on the selected version.

PART #	DESCRIPTION	PRICE
VF-04-100	Vertical Dual Sided Finger Duct Style Cable Manager, Floor Enclosure Style, Black, opening 1.6"W x 4"H x 48"L	\$49.65
VF-07-100	Vertical Dual Sided Finger Duct Style Cable Manager, Floor Enclosure Style, Black, opening 1.6"W x 4"H x 72"L	75.90
VF-07-140	Vertical Dual Sided Finger Duct Style Cable Manager, Floor Enclosure Style Black, opening 2.2"W x 6.4"H x 72"L	199.50
VR-07-140	Vertical Dual Sided Finger Duct Style Cable Manager, 2 Post Rack Style Black, opening 2.2"W x 6.4"H x 72"L	119.50



**HORIZONTAL CABLE MANAGEMENT**

These Horizontal Duct Cable Managers are designed for use with any standard size open frame racks, wall enclosures and floor enclosures. They have a single-sided finger-duct design with a removable cover lid.

PART #	DESCRIPTION	PRICE
HF19-01-040	Horizontal Single Sided Finger Duct Style Cable Manager, Black, 1.75"H x 19"W x 2"D	\$20.00
HF19-02-200	Horizontal Single Sided Finger Duct Style Cable Manager, Black, 3.5"H x 19"W x 3.2"D	33.45
HF19-02-200D	Horizontal Dual Sided Finger Duct Style Cable Manager, Black, 3.5"H x 19"W x 6.4"D	50.55



**COOPER B LINE CABLE HOOKS AND CABLE TO BEAM FASTENERS**

Cable hooks or J-hooks are an excellent solution for supporting cables of all types. Cable to Beam fasteners rotate 360 degrees to allow cable to run in any direction and they do accept cable ties. The exclusive Qwik-Latch cable retainers provide secure containment of cables.

PART #	DESCRIPTION	PRICE
BCH21	1-5/16" Cable Hook or J-Hook, Box of 50	\$296.00
BCH32-50	2" Cable Hook or J-Hook, Box of 50	357.00
BCH64	4" Cable Hook or J-Hook, Box of 25	339.50
BCH21C2	1 5/16" Cable to Beam Fastener, Box of 50	569.16
BCH32-C2-50	2" Cable to Beam Fastener, Box of 50	615.80

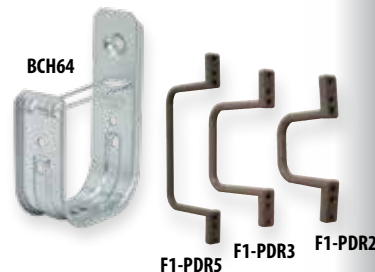

**DATA CABLE ACCESSORIES**

Utilize plastic distribution rings or "D" rings, to attach to a backboard, ceiling or a wall to support voice and data cables. The plastic rings feature rounded edges that will prevent damage to the wire and cable in addition to allowing for easier "pull." Available in 2", 3" or 5" sizes.

PART #	DESCRIPTION	PRICE
F1-PDR2	Plastic Distribution Ring (2")	\$1.50
F1-PDR3	Plastic Distribution Ring (3")	1.95
F1-PDR5	Plastic Distribution Ring (5")	2.25
VD00034	Vertical D-Ring Cable Manager for open frame racks, Depth 3.25" - 10 per pack	44.45
VD00070	Vertical D-Ring Cable Manager for open frame racks, Depth 5.7" - 10 per pack	50.95



**Custom Interconnect Solutions**

FIS' extensive resources facilitate a fast concept-to-product development cycle. FIS will design, manufacture and customize products to meet the needs of your large or special projects.

Any enclosure, either stock or custom built, can be loaded with fiber, connectors, and cable management solutions. CWDM modules, high count fiber couplers, and MTP assemblies are all configurable and can easily be pre-installed within the enclosure.

Feature your unique brand on FIS enclosures by taking advantage of customized silk screened logos, vivid laser etched designs, and a variety of powder coat colors.

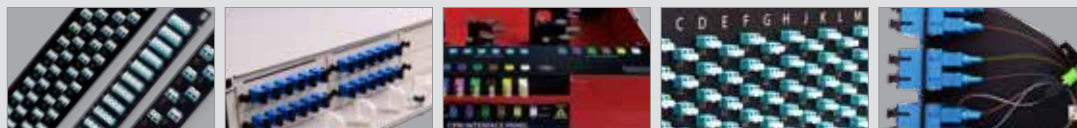

CONTACT YOUR FIS SALES REPRESENTATIVE FOR CUSTOM ORDERS

- Individual Logos  
*Laser Etching, Silk Screening, High Tack Stickers*
- Unique Colors  
*Electrostatic Powder Coating Available in Any Color*
- Construction Materials  
*Aluminum or Steel*
- Pre-Loaded Ports  
*LGX Adapter Panels, Pigtails, Snap Packs, Cassettes*



# ZEUS FIBER MANAGEMENT CENTER

Environmentally sealed front door, Padlock style security latches and wind stop

Four cable entry ports with liquid tight sealing grommets and internal strain relief brackets

Pad Mount Skirt features Front and Rear removable panels

Built-in cable management brackets

24.71"(h) x 27"(w) x 14"(d)

36"(h) x 27"(w) x 14"(d)

36"(h) x 27"(w) x 30"(d)  
(Dual Doors)

All modules built with individual swing-out panels to allow for easy rear access.

**NEW**

## Zeus Mini Fiber Management Center

Pole, Pad, or Wall Mounted - up to 144 SC/APC ports - Half the size

MOUNT TYPE	FIBER (INPUT)	STYLE	CONNECTOR	FEEDER LENGTH (ft)	FEEDER CABLE TYPE	NUMBER OF PORTS	DISTRIBUTION CABLE TYPE	DISTRIBUTION CABLE LENGTH	CONNECTOR	NUMBER OF DISTRIBUTION CABLES
Z	A	I	3	100	LTD	144	LTD	100	3	2
A = Pad	XC=Cross Connect	O = No Feeder (With Trays)	2 = SC UPC	O=No Feeder	O = No Feeder	144	O = No Distribution	O = No Distribution	2 = SC UPC	O = No Distribution
B = Pole	24	I = Connectorized (No Trays)	3 = SC APC	50	R = Ribbon	288	R = Ribbon	50	3 = SC APC	1
C = Wall	48		4 = LC UPC	100	LTD = Loose Tube	432	LTD = Loose Tube	100	4 = LC UPC	2
D = Mini Pole	72		5 = LC APC	150	LTA = Loose Tube Armor	576	LTA = Loose Tube Armor	150	5 = LC APC	3
E = Mini Pad	96			200		1,152		200		4
G = XL Pad										5
										6

### Part # Example: ZA-24-I-3-100-LTD-288-LTD-100-3-2

Translates to: Zeus Fiber Management Center - Pad Mount 24 Fiber Input SC/APC - 100FT Feeder - (2) 144 Distribution SC/APC 100' Distribution - Fully Loaded - Accommodates (12) LGX Splitter Modules **Price: \$4,200**

## ZEUS Fiber Management Center Accommodates up to 12 LGX Splitter Modules.

(Also in LC Connector Configurations)

### SPLITTER MODULES, LGX FOOTPRINT

PART #	DESCRIPTION	DIMENSIONS (HxWxL)	PRICE
Z104LGXSCA2-XX	1x4 LGX Module w/ 2 Meter SC/APC leads	1.14" x 3.98" x 6.14"	\$125.00
Z108LGXSCA2-XX	1x8 LGX Module w/ 2 Meter SC/APC leads	1.14" x 3.98" x 6.14"	187.50
Z116LGXSCA2-XX	1x16 LGX Module w/ 2 Meter SC/APC leads	1.14" x 3.98" x 6.14"	250.00
Z132LGXSCA2-XX	1x32 LGX Module w/ 2 Meter SC/APC leads	1.14" x 3.98" x 6.14"	375.00

Pin Distance is 4.65"

Place an "HD" where the "XX" is on the end of the part number to purchase the High Density LGX Splitter Module version for XL Cabinet ONLY



**FIS FLAT DROP CABLE SPOOL BULK PRICING**

FIS offers the flat Stranded Single Tube drop cable for Fiber To The Home applications. This durable design incorporates two dielectric rigid rods for optimal tensile strength and crush protection.

PART #	SPOOL LENGTH / SIZE	FIBER COUNT	DESCRIPTION	PRICE
Z1-25001T18	2,500FT / 18 in	1	1 Fiber SM SMF28Ultra Flat Drop Toneable PE Black 18" (763 meters)	\$438.00 ea
Z1-50001T30	5,000FT / 30 in	1	1 Fiber SM SMF28Ultra Flat Drop Toneable PE Black 30" (1,525 meters)	820.00 ea
Z1-100001T30	10,000FT / 30 in	1	1 Fiber SM SMF28Ultra Flat Drop Toneable PE Black 30" (3,049 meters)	1,628.00 ea
Z1-25002D18	2,500 ft / 18 in	2	SM SMF28 Ultra Dry Flat Drop Cable PE Black (763 meters)	400.00 ea
Z1-50002D30	5,000 ft / 30 in	2	SM SMF28 Ultra Dry Flat Drop Cable PE Black (1,525 meters)	750.00 ea
Z1-100002D30	10,000 ft / 30 in	2	SM SMF28 Ultra Dry Flat Drop Cable PE Black (3,049 meters)	1,486.00 ea
Z1-25002G18	2,500 ft / 18 in	2	SM SMF28 Ultra Gel Flat Drop Cable PE Black (763 meters)	372.00 ea
Z1-50002G30	5,000 ft / 30 in	2	SM SMF28 Ultra Gel Flat Drop Cable PE Black (1,525 meters)	693.00 ea
Z1-100002G30	10,000 ft / 30 in	2	SM SMF28 Ultra Gel Flat Drop Cable PE Black (3,049 meters)	1,372.00 ea
Z1-25002T18	2,500 ft / 18 in	2	SM SMF28 Ultra Gel Flat Drop Toneable (24 AWG) Cable (763 meters)	397.00 ea
Z1-50002T30	5,000 ft / 30 in	2	SM SMF28 Ultra Gel Flat Drop Toneable (24 AWG) Cable (1,525 meters)	743.00 ea
Z1-100002T30	10,000 ft / 30 in	2	SM SMF28 Ultra Gel Flat Drop Toneable (24 AWG) Cable (3,049 meters)	1,473.00 ea
Z1-25002900D18	2,500 ft / 18 in	2	900um Buffer SM SMF28 Ultra Dry Flat Drop PE Black (763 meters)	479.00 ea
Z1-50002900D30	5,000 ft / 30 in	2	900um Buffer SM SMF28 Ultra Dry Flat Drop PE Black (1,525 meters)	907.00 ea
Z1-100002900D30	10,000 ft / 30 in	2	900um Buffer SM SMF28 Ultra Dry Flat Drop PE Black (3,049 meters)	1,868.00 ea
Z1-25002900T18	2,500 ft / 18 in	2	900um SM SMF28 Ultra Dry Flat Drop Toneable 24 AWG (763 meters)	411.00 ea
Z1-50002900T30	5,000 ft / 30 in	2	900um SM SMF28 Ultra Dry Flat Drop Toneable 24 AWG (1,525 meters)	771.00 ea
Z1-100002900T30	10,000 ft / 30 in	2	900um SM SMF28 Ultra Dry Flat Drop Toneable 24 AWG (3,049 meters)	1,528.00 ea
Z1-25006D18	2,500 ft / 18 in	6	SM SMF28 Ultra Dry Flat Drop Cable PE Black (763 meters)	505.00 ea
Z1-50006D30	5,000 ft / 30 in	6	SM SMF28 Ultra Dry Flat Drop Cable PE Black (1,525 meters)	947.00 ea
Z1-100006D30	10,000 ft / 30 in	6	SM SMF28 Ultra Dry Flat Drop Cable PE Black (3,049 meters)	1,903.00 ea
Z1-250012D18	2,500 ft / 18 in	12	SM SMF28 Ultra Dry Flat Drop Cable PE Black (763 meters)	660.00 ea
Z1-500012D30	5,000 ft / 30 in	12	SM SMF28 Ultra Dry Flat Drop Cable PE Black (1,525 meters)	1,268.00 ea
Z1-1000012D30	10,000 ft / 30 in	12	SM SMF28 Ultra Dry Flat Drop Cable PE Black (3,049 meters)	2,522.00 ea
Z1-250012T18	2,500 ft / 18 in	12	SM Drop Cable Dry Toneable (24 AWG) PE Black (763 meters)	646.00 ea
Z1-500012T30	5,000 ft / 30 in	12	SM Drop Cable Dry Toneable (24 AWG) PE Black (1,525 meters)	1,240.00 ea
Z1-1000012T30	10,000 ft / 30 in	12	SM Drop Cable Dry Toneable (24 AWG) PE Black (3,049 meters)	2,466.00 ea



Z125002D18



Z100002900T30

**PATHFINDER**



**CUSTOM DROP CABLE ASSEMBLIES**

CABLE TYPE	FIBER COUNT	CONNECTOR A	CONNECTOR B	LENGTH (FT)	BREAKOUT LENGTH	BREAKOUT BUILD UP	PULLING EYE INSTALLED	SPOOL
ZDCT	1	HIP	YA	150	B10	Z4	-	-
ZDCT = Drop Cable Toneable	1	HIP = FIS ZTAP Connector	P = Pigtail	25	B06 = 6 in	Z9 = 900µm	PE = Outside End Only	SP = Spool
ZDCN = Drop Cable Non-Toneable	2	OPT = Corning OptiTap Connector	HIP = FIS ZTAP Connector	50	B10 = 10 in	Z1 = 1.6mm	PBE = Both Ends	HS = Hand Spool
ZDCT9 = 900um Univ. Flat Drop Toneable	4	YA = SC/APC	OPT = Corning OptiTap Connector	100	B12 = 12 in	Z2 = 2mm	MPE = Mini Pulling Eye (Pathfinder)	
ZDCN9 = 900um Univ. Flat Drop Non-Toneable	6	YU = SC/UPC	YA = SC/APC	150	B24 = 24 in	Z3 = 3mm		
ZMDUL = Indoor/Outdoor 3mm LBL®	12	LA = LC/APC	YU = SC/UPC	200		Z4 = 4.8mm		
ZMDUZ = Indoor/Outdoor 3mm ZBL®		LU = LC/UPC	LA = LC/APC	250				
ZMDU48 = Indoor/Outdoor 4.8mm ZBL			LU = LC/UPC	300				
ZMDUA = Armored Indoor/Outdoor 3mm				400				
				500				
				600				
				700				
				750				
				1,000				



**Part # Example:**

**ZDCT-1-HIP-YA-150-B10-Z4**

Translates to: Zeus Toneable Flat Drop Cable - (1) ZTAP Connector - SC/APC10" Breakout Length on 4.8mm Tubing - 150ft

**FIS FLAT DROP CABLE ASSEMBLIES**

PART #	DESCRIPTION	PRICE
ZDCT-1-HIP-P-100	2 Fiber Toneable Flat Drop Cable - (1)ZTAP Connector - Pigtail - 100 ft	\$38.95
ZDCT-1-HIP-P-150	2 Fiber Toneable Flat Drop Cable - (1)ZTAP Connector - Pigtail - 150 ft	46.95
ZDCT-1-HIP-P-200	2 Fiber Toneable Flat Drop Cable - (1)ZTAP Connector - Pigtail - 200 ft	54.95
ZDCT-1-HIP-P-250	2 Fiber Toneable Flat Drop Cable - (1)ZTAP Connector - Pigtail - 250 ft	63.95
ZDCT-1-HIP-P-300	2 Fiber Toneable Flat Drop Cable - (1)ZTAP Connector - Pigtail - 300 ft	71.95
ZDCT-1-HIP-P-350	2 Fiber Toneable Flat Drop Cable - (1)ZTAP Connector - Pigtail - 350 ft	79.95
ZDCT-1-HIP-P-400	2 Fiber Toneable Flat Drop Cable - (1)ZTAP Connector - Pigtail - 400 ft	87.95
ZDCT-1-HIP-P-500	2 Fiber Toneable Flat Drop Cable - (1)ZTAP Connector - Pigtail - 500 ft	103.95
ZDCN-1-HIP-P-100	2 Fiber Non Toneable Flat Drop Cable - (1)ZTAP Connector - Pigtail - 100 ft	34.95
ZDCN-1-HIP-P-150	2 Fiber Non Toneable Flat Drop Cable - (1)ZTAP Connector - Pigtail - 150 ft	41.95
ZDCN-1-HIP-P-200	2 Fiber Non Toneable Flat Drop Cable - (1)ZTAP Connector - Pigtail - 200 ft	48.95
ZDCN-1-HIP-P-250	2 Fiber Non Toneable Flat Drop Cable - (1)ZTAP Connector - Pigtail - 250 ft	56.95
ZDCN-1-HIP-P-300	2 Fiber Non Toneable Flat Drop Cable - (1)ZTAP Connector - Pigtail - 300 ft	63.95
ZDCN-1-HIP-P-350	2 Fiber Non Toneable Flat Drop Cable - (1)ZTAP Connector - Pigtail - 350 ft	70.95
ZDCN-1-HIP-P-400	2 Fiber Non Toneable Flat Drop Cable - (1)ZTAP Connector - Pigtail - 400 ft	78.95
ZDCN-1-HIP-P-500	2 Fiber Non Toneable Flat Drop Cable - (1)ZTAP Connector - Pigtail - 500 ft	93.95

CORNING OPTITAP® Compatible



ZMDUL-1-YA-P-100-HS

FULLAXS

## ENCLOSURES



Inquire with Sales about pre loaded enclosures for quicker installation.

Z1602FTTX

Z176SFSTTX

Z1NG10FTTX

## FIS NETWORK INTERFACE DEVICES (NID)

## FTTX FIBER OPTIC INTERCONNECT ENCLOSURES

PART #	DESCRIPTION	(HxWxD)	PRICE
Z1602FTTX	Fiber Enclosure for FTtx, no adapters installed, accommodates (6) SC simplex or (6) duplex LC adapters with included bracket, and 12 fusion splice sleeves. Features ground post, hex security screw and allows for 3 meters of cable slack. Rubber grommet cable entrances on bottom.	8.42" x 7.92" x 2.5"	\$26.95
Z176SFSTTX	Fiber Enclosure for FTtx, no adapters installed, accommodates up to (2) SC simplex or (2) duplex LC adapters, and/or (1) "H" connector receptacle such as OptiTap/OptiTip. Features (1) splice chip for up to 12 fusion splice sleeves, ground post, hex security screw and slack routing spool for storage. Rubber grommet entrances on bottom of enclosure.	10" x 8.42" x 2.96"	35.00
Z1NG10FTTX	Fiber Enclosure for FTtx, no adapters installed, accommodates (12) SC simplex or (12) duplex LC adapters, features ground post, hex security screw and inside tabs for slack storage. Rubber grommets for cable entrances on bottom.	11.91" x 8.31" x 3.35"	46.75

See SC and LC adapters for enclosures located on pages 146 and 147



## FIS FIBER OPTIC NID TERMINATION BOX

FIS Wall Mount Fiber Optic NID Terminal Box is designed to provide protection for fiber optic connectors and splices in indoor or outdoor environments (IP65 Rated). The enclosure has a built in, swing-out mini splice tray plus a bulkhead panel with SC cutout ports. 2 or 3 Cable access ports with built in weather-tight grommets allow for easy cable installation.

Adapters not included.

PART #	DESCRIPTION	(HxWxD)	PRICE
F1-62DW-2	FIS NID Termination Box (For 2 Simplex SC or 2 Duplex LC Connections) 2 Entry Ports	8.2" x 6" x 2"	\$39.95
F1-62DW-3	FIS NID Termination Box (For 6 Duplex SC or 6 LC Quad Connections) 3 Entry Ports	10.2" x 7" x 2"	49.95

See SC and LC adapters for enclosures located on pages 146 and 147

## IN-HOME FIBER INTERCONNECT WALL PLATE

- Junction box mounting platform
- Fiber slack storage spool with up to 5 feet of 3mm fiber slack storage
- Can be configured for fiber connection accessible from outside or protected inside the cover
- Snap on cover with security screw
- Vertical or horizontal distribution
- Angled or straight exit

PART #	DESCRIPTION	PRICE
ZEUS-13X5-85	Single gang fiber wall plate with two covers, fiber adapter and splice holder inside with fiber storage	\$13.95

## DID YOU KNOW...

## REPEATABILITY EXPECTATIONS TESTING CABLE ASSEMBLIES

When a manufacturer provides cable assemblies with documented test results it may be difficult to replicate the same performance results in the field. First, it's unlikely that both parties are utilizing the same optical testers, most power meters which provide insertion loss measurements have an uncertainty of 5%, in some instances this can be as much as 0.2dB. If comparing results within this threshold it could prove more useful to focus on overall loss budget of optical link rather than individual component. Second variable is often the reference cords, high grade reference cords are often not as accessible in the field, therefore standard grade cords are implemented and according to TIA-568 standard this could vary test results by 0.25dB per mated pair versus utilizing reference jumpers. Third item to consider is mating sleeve which should utilize Zirconia split sleeve for precision alignment. Lastly, is cleanliness and inspection of the connector end faces as it is a necessity to confirm both connectors are free from damage or debris prior to testing or repeatability will be impossible.



**FIS ORION SERIES 16 PORT ENCLOSURE**

The Orion Series 16 Port Enclosures is an outdoor enclosure designed for harsh environments in FTtx applications. Fiber splicing, splitting, and drop distribution can be completed inside this box offering solid protection and management for your network building.

Ask your FIS Sales Representative about pre-loading the enclosures with pigtails, adapters, and PLC Splitters.

PART #	DESCRIPTION	(HxWxD)	MOUNTING OPTIONS	PRICE
Z1-ORI16PT	Orion Series Enclosure. 16 SC Ports/32 LC Ports. 1 Splice Tray Included, No Adapters or Pigtails	11.5" x 8.5" x 3.25"	Pole/Wall	\$99.95
Z1-ORI16T	Orion Series Enclosure. 1 Splice Tray Included (no adapter ports). Up to 5 Splice Trays. Pole or Wall Mount.	11.5" x 8.5" x 3.25"	Pole/Wall	89.95
Z1-ORI16WM	Orion Series Enclosure 16 SC Ports/32 LC Ports Wall Mount Only Splice Tray Included No Adapters or Pigtails	11.5" x 8.5" x 3.25"	Wall	85.95



**FIS ORION SERIES 24 PORT ENCLOSURE**

The Orion Series 24 Port Enclosure is an outdoor enclosure made of a UV Resistant, anti-aging polycarbonate and designed for outdoor use. Fiber splicing, splitting, and drop distribution can be completed inside of this box offering solid protection and management for your FTtx Network.

Ask your Sales Representative about pre-loading enclosures with adapters, splitter packages, and various cable assemblies.

PART #	DESCRIPTION	(HxWxD)	MOUNTING OPTIONS	PRICE
Z1-ORI24P	Orion Series Enclosure 24 SC Ports/48 LC Ports, Splice Tray Included, No Adapters or Pigtails	13.5" x 8.75" x 3.75"	Pole	\$145.95
Z1-ORI24WM	Orion Series Enclosure 24 SC Ports/48 LC Ports, Splice Tray Included, No Adapters or Pigtails	12.5" x 9.5" x 3.95"	Pole/Wall	105.95



**FIS ORION SERIES 32 PORT ENCLOSURE**

The Orion Series 32 Port Enclosure is an IP65 Rated cabinet made with UV-resistant polycarbonate. Splice trays are included and mounted on the back wall behind the hinged adapter panels. All cable management accessories are included as well as grounding screw.

Contact your FIS Sales Representative about pre-loading the enclosures with pigtails, adapters, and PLC splitters.

PART #	DESCRIPTION	(HxWxD)	MOUNTING OPTIONS	PRICE
Z1-ORI48	Orion Series Enclosure 48 SC Ports/96 LC Ports w. Splicing and Cable Management, No Adapters or Pigtails	16.5" x 13.4" x 5.1"	Wall	\$195.00





# FIS MULTI-SERVICE TERMINALS (MST)



4-Port



8-Port



12-Port

The Zeus Multiport Service Terminal incorporates hardened connector (ZTAP) technology that is designed to defend against rugged outside plant environments. The robust and reliable interface comes pre-loaded in a 4 port, 8 port, or 12 port enclosure using FIS' ruggedized flat drop cable.

Contact your FIS Sales Representative about all of our pre-loaded options which includes cable assembly, number of drop ports, and PLC splitters.

PART #	DESCRIPTION	DIMENSIONS (H x W x D)	PRICE
Z1-MST-04-YA-P-100	Zeus MST Box 4 Port, with SC/APC - Pigtail, 100'	9" x 4.75" x 3.50"	\$116.00
Z1-MST-04-YA-P-250	Zeus MST Box 4 Port, with SC/APC - Pigtail, 250'	9" x 4.75" x 3.50"	135.00
Z1-MST-04-YA-P-500	Zeus MST Box 4 Port, with SC/APC - Pigtail, 500'	9" x 4.75" x 3.50"	167.00
Z1-MST-04-YA-P-1000	Zeus MST Box 4 Port, with SC/APC - Pigtail, 1000'	9" x 4.75" x 3.50"	235.00
Z1-MST-04-YA-P-2000	Zeus MST Box 4 Port, with SC/APC - Pigtail, 2000'	9" x 4.75" x 3.50"	364.00
Z1-MST-08-YA-P-100	Zeus MST Box 8 Port, with SC/APC - Pigtail, 100'	12" x 4.75" x 3.50"	184.00
Z1-MST-08-YA-P-250	Zeus MST Box 8 Port, with SC/APC - Pigtail, 250'	12" x 4.75" x 3.50"	211.00
Z1-MST-08-YA-P-500	Zeus MST Box 8 Port, with SC/APC - Pigtail, 500'	12" x 4.75" x 3.50"	258.00
Z1-MST-08-YA-P-1000	Zeus MST Box 8 Port, with SC/APC - Pigtail, 1000'	12" x 4.75" x 3.50"	341.00
Z1-MST-08-YA-P-2000	Zeus MST Box 8 Port, with SC/APC - Pigtail, 2000'	12" x 4.75" x 3.50"	515.00
Z1-MST-12-YA-P-100	Zeus MST Box 12 Port, with SC/APC - Pigtail, 100'	16" x 4.75" x 3.50"	300.00
Z1-MST-12-YA-P-250	Zeus MST Box 12 Port, with SC/APC - Pigtail, 250'	16" x 4.75" x 3.50"	335.00
Z1-MST-12-YA-P-500	Zeus MST Box 12 Port, with SC/APC - Pigtail, 500'	16" x 4.75" x 3.50"	382.00
Z1-MST-12-YA-P-1000	Zeus MST Box 12 Port, with SC/APC - Pigtail, 1000'	16" x 4.75" x 3.50"	485.00
Z1-MST-12-YA-P-2000	Zeus MST Box 12 Port, with SC/APC - Pigtail, 2000'	16" x 4.75" x 3.50"	698.00

All prices reflect a fully loaded terminal using Non-Tone flat drop cable.

Contact your sales representative to have any of these enclosures loaded with adapters and pigtails.



Z1-ODE08SCA



## FIS OSP DISTRIBUTION ENCLOSURE – 8 Port (Pole, Ped, Strand, Wall Mount)

The OSP Distribution 8 Port Enclosure is uniquely designed to accept a wide range of distribution and drop cables to accommodate any FTx application. This "plug-n-play" style enclosure is specifically designed to accept 8 pre-terminated drop cables and up to 60 core splices. The Enclosure includes (5) 12ct Splice Trays, 8 Drop Cable ports, 4 Feeder Ports (5mm-10mm) and all mounting hardware. Dimensions 13.5"(h) x 7.75"(w) x 5.0"(d). Contact your FIS Sales Representative to fill the enclosure with PLC Splitters and pigtails.

PART #	DESCRIPTION	PRICE
Z1-ODE08SCA	FIS OSP Distribution Enclosure – 8 Port, Includes 8 SC/APC adapters and 5 12ct splice trays.	\$197.00

\* LC/APC's Available



Z1-DTE16SCA

## FIS FIBER DROP TERMINATION ENCLOSURE (Strand Mount Only)

FIS Drop Termination Enclosure provides maximum protection at the fiber splice point and distribution of drop fibers. This "plug-n-play" style enclosure is specially designed to accommodate 16 pre-terminated fiber drop cables. The outer case is constructed of chemical resistant, anti aging material. Splice trays are able to accommodate PLC Splitters, and/or up to 24 individual splices. Maximum of (6) 24ct splice trays per enclosure. Dimensions 13.5"(h) x 8.75"(w) x 5.0"(d).

PART #	DESCRIPTION	PRICE
Z1-DTE16SCA	FIS DTE Aerial Strand Mount Only – 16 SC/APC Adapters. Includes (1) 24ct Splice tray	\$275.00
Z1-DTETRAY24	24ct Splice Tray for Drop Termination Enclosure	15.50

\* LC/APC's Available

## FIS FIBER OPTIC SPLICE CLOSURE

This FIS Outside Plant Direct Burial Closure offers the perfect choice for low fiber count distribution applications involving butt and inline installations. The compact size and rugged design allow the closure to be deployed in below grade, aerial and buried installations. Dimensions: 21" L x 8" W x 4" H Weight: 9lbs.

- 4 Entry Ports
- Accepts cables from 10mm - 22mm diameter
- Can be configured for butt or in-line applications
- Integrated splice trays included
- Permanent waterproof sealing requires no re-entry kit
- IP rating:66 (Equal to NEMA 4 and 4X)
- Direct Burial or Aerial applications

PART #	DESCRIPTION	PRICE
F1-OSPDBC24	FIS Fiber Optic Splice Closure - 24 Fiber	\$99.95
F1-OSPDBC48	FIS Fiber Optic Splice Closure - 48 Fiber	125.00
F1-OSPTRAY	Splice Tray 12 but expandable to 24 Fiber For F1-OSPDBC-XX Closures	9.95



F1-OSPDBC48



F1-OSPDBC24

## FIS FLEXIBLE CABLE SPLICE PROTECTOR

The FIS Flexible Cable Splice Protector is an ideal solution for protecting fiber optic splices in challenging field conditions. This rugged, easy-to-install splice protector accommodates up to 12 splices with mini or micro protection sleeves, protecting them from moisture, vibration, shock and other adverse environmental conditions.

- Use for singlemode or multimode fibers • Accommodates 25-60mm long splice sleeves
- 5" Minimum bend radius (Flexible center portion only) • Dimensions: 13.75" (L) x 1.35" (W)

PART #	DESCRIPTION	PRICE
F1-FLEXSPLC	FIS Flexible Cable Splice Protector	\$83.50



F1-FLEXSPLC

## FIS QUICK FUSION SPLICE RESTORATION KIT

Ideal for restoring service to customers quickly during service outages. One side of the fiber is pre-prepped into the splice case to speed up restoration of service. The kit includes 1000' of 48 Fiber Dry Loose Tube Cable with Corning Bend Insensitive SMF28 Ultra Fiber, Spooled onto a Re-deployable Reel on wheels, 75' of the cable is spooled onto the inside flange. Also includes 2 Commscope FOSC-450A Splice Enclosures with (2) 24 Fiber Splice Trays each. Dimensions are 31.5"h x 31.5"w x 16"d.

- Portable • Reusable • Available
- Prepped • Faster • Affordable

PART #	DESCRIPTION	PRICE
F1-QSRK	Quick Fusion Splice Restoration Kit - 48 Fiber	\$2,500.00
F1-QSRK96	Quick Fusion Splice Restoration Kit - 96 Fiber	2,957.00
F1-QSRK144	Quick Fusion Splice Restoration Kit - 144 Fiber	3,374.00



### DID YOU KNOW...

#### ADSS

ADSS stands for All Dielectric Self Supporting. All Dielectric means that the cable is constructed without metal components so it will not conduct electricity. Self Supporting means that the cable will be held in place by very specialized hardware which will spread the force required to secure the cable by the jacket over a distance. Since no metal components exist for support the entire cable is supported by the hardware and jacket. Common applications for ADSS cable include Cellular Backhaul Networks, Power Utility Grids and projects that have substantial grade change over long distances.

The design of ADSS cable and hardware is specific for each application. Very specific information about the installation is required when ordering cable and hardware. **Specifications regarding Cable Part Number, Loading, Span Length, Power Zone Voltage and Cable O.D. will be required in order to quote properly. Typically manufacturers will not provide quote without the proper information.**

#### OPGW

OPGW stands for Optical Ground Wire which is used in Power Utilities. Optical Ground Wire Cable is used as a means to provide protection against lightning strikes on high voltage power lines, along with sending information over fiber optics. OPGW cable consists of multiple strands of fiber optics and Icky Pic (used to repel water and buffer against temperature change) and are contained within a tube either stainless steel or plastic based. The tube containing the fibers is then wrapped in 1 or more layers of metal wires. The layers of metal will be a conductor to move any current from a lightning strike and as protection for the fiber as well. The fiber contained within the cable will be used to transfer data between locations within the grid. The ability to analyze data in real time will eventually increase the efficiency of our aging power grid infrastructure.

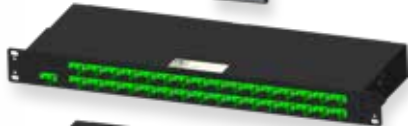

Z1PLM1321RLA



F1-PLC-08-SCU



Z1PLCM1160SP20A2LA1.5

**All configurations have the following specifications:**

- OSP cassette size (100mm x 80mm x 10mm)
- 2.0mm jacket
- 1.5m leads
- Common-Red jacket

**Other Connectors Available!**



Z1PLM1321L162SACA

**All configurations have the following specifications:**

- 1.6mm jacket
- 2m leads
- Common SC/APC Adapter

**Other Connectors Available!**

## OPTICAL SPLITTER LGX PACKAGE WITH CONNECTOR ADAPTERS

The FIS Optical Splitter in a LGX Package allows users to install in any LGX style Rack or Wall Mount Enclosure (see page 8). Each module can be packaged with any connector style adapter utilizing Single-Wide and Double-Wide dimensions.

PART #	DESCRIPTION	PRICE
Z1PLM141SLSA	1x4 LGX Optical Splitter, Single Wide, SC/APC Adapters	\$95.85
Z1PLM141SLLA	1x4 OSP Optical Splitter, Single Wide, LC/APC Adapters	95.85
Z1PLM181SLSA	1x8 OSP Optical Splitter, Single Wide, SC/APC Adapters	140.85
Z1PLM181SLLA	1x8 OSP Optical Splitter, Single Wide, LC/APC Adapters	140.85
Z1PLM1162SLSA	1x16 OSP Optical Splitter, Double Wide, SC/APC Adapters	162.85
Z1PLM1161SLLA	1x16 OSP Optical Splitter, Single Wide, LC/APC Adapters	162.85

**Other Connectors Available!**

## OPTICAL SPLITTER RACK MOUNT CONNECTOR ADAPTERS

PART #	DESCRIPTION	PRICE
Z1PLM1161RSA	1x16 PLC Optical Splitter, 19" 1RU Rackmount Package with SC/APC Connectors	\$368.89
Z1PLM1161RLA	1x16 PLC Optical Splitter, 19" 1RU Rackmount Package with LC/APC Connectors	368.89
Z1PLM1321RSA	1x32 PLC Optical Splitter, 19" 1RU Rackmount Package with SC/APC Connectors	440.85
Z1PLM1321RLA	1x32 PLC Optical Splitter, 19" 1RU Rackmount Package with LC/APC Connectors	440.85

## PLANAR LIGHTWAVE CIRCUIT SPLITTERS

Today's high-port-count applications for broadband system applications demand the best performance and the highest reliability under the most adverse of environments. Planar Lightwave Circuit Splitters deliver on all these requirements. FIS provides a variety of PLC's pre-terminated with SC/UPC, SC/APC or the connector of choice.

PART #	DESCRIPTION	PRICE
F1PLC04	1x4 PLC Unconnectorized	\$35.00
F1PLC08	1x8 PLC Unconnectorized	45.00
F1PLC16	1x16 PLC Unconnectorized	65.00
F1PLC32	1x32 PLC Unconnectorized	100.00
F1-PLC-04-SCA	1x4 PLC with Fan Out and SC/APC Connectors	48.00
F1-PLC-08-SCA	1x8 PLC with Fan Out and SC/APC Connectors	65.00
F1-PLC-16-SCA	1x16 PLC with Fan Out and SC/APC Connectors	90.00
F1-PLC-32-SCA	1x32 PLC with Fan Out and SC/APC Connectors	140.00

## OPTICAL SPLITTER OSP PACKAGE

The FIS Optical Splitter packaged in an OSP Cassette addresses environmental challenges with improved fiber protection which allows for quick installation in hardened environments and maximizes space in cabinets and enclosures.

PART #	DESCRIPTION	DIMENSIONS (LxWxH)	PRICE
Z1PLCM140SP20A2SA1.5	1x4 OSP Optical Splitter, SC/APC Connectors	3.94" x 3.15" x 0.4"	\$78.00
Z1PLCM140SP20A2LA1.5	1x4 OSP Optical Splitter, LC/APC Connectors	3.94" x 3.15" x 0.4"	78.00
Z1PLCM180SP20A2SA1.5	1x8 OSP Optical Splitter, SC/APC Connectors	3.94" x 3.15" x 0.4"	116.00
Z1PLCM180SP20A2LA1.5	1x8 OSP Optical Splitter, LC/APC Connectors	3.94" x 3.15" x 0.4"	116.00
Z1PLCM1160SP20A2SA1.5	1x16 OSP Optical Splitter, SC/APC Connectors	3.94" x 3.15" x 0.4"	138.00
Z1PLCM1160SP20A2LA1.5	1x16 OSP Optical Splitter, LC/APC Connectors	3.94" x 3.15" x 0.4"	138.00
Z1PLCM1320SP20A2SA1.5	1x32 OSP Optical Splitter, SC/APC Connectors	3.94" x 3.15" x 0.4"	150.00
Z1PLCM1320SP20A2LA1.5	1x32 OSP Optical Splitter, LC/APC Connectors	3.94" x 3.15" x 0.4"	150.00
Z1PLCM2160SP20A2SA1.5	2x16 OSP Optical Splitter, SC/APC Connectors	3.94" x 3.15" x 0.4"	190.00
Z1PLCM2160SP20A2LA1.5	2x16 OSP Optical Splitter, LC/APC Connectors	3.94" x 3.15" x 0.4"	190.00
Z1PLCM2320SP20A2SA1.5	2x32 OSP Optical Splitter, SC/APC Connectors	3.94" x 3.15" x 0.4"	256.00
Z1PLCM2320SP20A2LA1.5	2x32 OSP Optical Splitter, LC/APC Connectors	3.94" x 3.15" x 0.4"	256.00

## OPTICAL SPLITTER LGX PACKAGE

The FIS Optical Splitter in a LGX Package allows users to install in any LGX style Rack or Wall Mount Enclosure (see page 8). Each module is packaged with 2M long legs providing the user with a single-wide only module.

PART #	DESCRIPTION	DIMENSIONS (LxWxH)	PRICE
Z1PLM12HL162SACA	1x2 LGX Optical Splitter, SC/APC Connectors	6.14" x 3.98" x 1.14"	\$ 72.00
Z1PLM141L162LACA	1x2 LGX Optical Splitter, LC/APC Connectors	6.14" x 3.98" x 1.14"	72.00
Z1PLM141L162SACA	1x4 LGX Optical Splitter, SC/APC Connectors	6.14" x 3.98" x 1.14"	86.00
Z1PLM141L162LACA	1x4 LGX Optical Splitter, LC/APC Connectors	6.14" x 3.98" x 1.14"	86.00
Z1PLM181L162SACA	1x8 LGX Optical Splitter, SC/APC Connectors	6.14" x 3.98" x 1.14"	126.00
Z1PLM181L162LACA	1x8 LGX Optical Splitter, LC/APC Connectors	6.14" x 3.98" x 1.14"	126.00
Z1PLM1161L162SACA	1x16 LGX Optical Splitter, SC/APC Connectors	6.14" x 3.98" x 1.14"	146.00
Z1PLM1161L162LACA	1x16 LGX Optical Splitter, LC/APC Connectors	6.14" x 3.98" x 1.14"	146.00
Z1PLM1321L162SACA	1x32 LGX Optical Splitter, SC/APC Connectors	6.14" x 3.98" x 1.14"	172.00
Z1PLM1321L162LACA	1x32 LGX Optical Splitter, LC/APC Connectors	6.14" x 3.98" x 1.14"	172.00
Z1PLM1161L162SACAD	Dual 1x16 LGX Optical Splitter, SC/APC Connectors	6.14" x 3.98" x 1.14"	316.00
Z1PLM1161L162SLACAD	Dual 1x16 LGX Optical Splitter, LC/APC Connectors	6.14" x 3.98" x 1.14"	316.00
Z1PLM1321L162SACAD	Dual 1x32 LGX Optical Splitter, SC/APC Connectors	6.14" x 3.98" x 1.14"	372.00
Z1PLM1321L162SLACAD	Dual 1x32 LGX Optical Splitter, LC/APC Connectors	6.14" x 3.98" x 1.14"	372.00



**CWDM OSP PASSIVE MODULES**

Coarse Wavelength Division Multiplexing (CWDM) Passive Outside Plant (OSP) Modules are available in 2, 4, 8 and 16 channels. These passive modules utilize 20nm channel spacing from 1271 – 1611nm. The CWDM modules are sold unconnectorized with 1 meter 900um tight buffered fiber leads but FIS can install any connector that you choose. The OSP rating makes them rugged enough to work in the harshest of environments (-40~+85) in your NEMA rated enclosures. When ordering please note the starting wavelength (ex. 27 = 1271, 29 = 1291, 31 = 1311 etc.) as the two XX variables at the end of your part number. Applications include FFTH (Fiber to the Home), R&D test labs and anywhere the separation of fiber signals is required.

PART #	DESCRIPTION	PRICE
Z1CWM2XX91NC	2 channel CWDM, OSP cassette, 900um, 1m leads, No connectors. Start channel 1XX1	\$146.00
Z1CWM4XX91NC	4 channel CWDM, OSP cassette, 900um, 1m leads, No connectors. Start channel 1XX1	290.00
Z1CWM8XX91NC	8 channel CWDM, OSP cassette, 900um, 1m leads, No connectors. Start channel 1XX1	580.00
Z1CWM16XX91NC	16 channel CWDM, OSP cassette, 900um, 1m leads, No connectors. Start channel 1XX1	1,160.00

CWDM Channels (nm): [1271](#), [1291](#), [1311](#), [1331](#), [1351](#), [1371](#), [1431](#), [1451](#), [1471](#), [1491](#), [1511](#), [1531](#), [1551](#), [1571](#), [1591](#), [1611](#)  
 Note: "XX= 27" for starting channel 1271nm

**CWDM LGX PASSIVE MODULES**

Coarse Wavelength Division Multiplexing (CWDM) LGX (Light Guide Cross-connect) Modules are available in 2, 4, 8 and 16 channels. These passive modules utilize 20nm channel spacing from 1271 – 1611nm. The CWDM LGX modules are sold with LC/APC connectors (w/ adapters) and packaged inside of a cassette. The cassette is plug and play making installation quick and efficient. The LGX standard or foot print is widely used with rack and wall enclosure face plates. These modules are 1 RU (Rack Unit – 1.75 inches) and fit into a standard 19 inch enclosure. When ordering please note the starting wavelength (ex. 27 = 1271, 29 = 1291, 31 = 1311 etc.) as two XX variables at the end of your part number

PART #	DESCRIPTION	PRICE
Z1CWM2XX1LLA	2 channel CWDM, LGX, LC/APC connectors. Start channel 1XX1	\$160.00
Z1CWM4XX1LLA	4 channel CWDM, LGX, LC/APC connectors. Start channel 1XX1	300.00
Z1CWM8XX1LLA	8 channel CWDM, LGX, LC/APC connectors. Start channel 1XX1	600.00
Z1CWM16XX1LLA	16 channel CWDM, LGX, LC/APC connectors. Start channel 1XX1	1,220.00

CWDM Channels (nm): [1271](#), [1291](#), [1311](#), [1331](#), [1351](#), [1371](#), [1431](#), [1451](#), [1471](#), [1491](#), [1511](#), [1531](#), [1551](#), [1571](#), [1591](#), [1611](#)  
 Note: "XX= 27" for starting channel 1271nm

**DWDM OSP PASSIVE MODULES**

Dense Wavelength Division Multiplexing (DWDM) Passive Outside Plant (OSP) Modules are available in 2, 4, 8, 16, 20 and 40 channels. These passive modules utilize 100GHz or 200GHz channel spacing; this is represented in the part number by the variable Y (1=100GHz and 2=200GHz). These modules are available with ITU channels 20 – 60. The DWDM modules are sold unconnectorized with 1 meter 900um tight buffered leads but FIS can install any connector that you choose. The OSP rating makes them rugged enough to work in the harshest of environments (-40~+85) in your NEMA rated enclosures. When ordering please note the starting channel (ex. Channel 20 = 20, Channel 40 = 40 etc.) as the two XX variables at the end of your part number. Applications include FFTH (Fiber to the Home), R&D test labs and anywhere the separation of fiber signals is required.

PART #	DESCRIPTION	PRICE
Z1DWMY2CXX91NC	2 channel DWDM, OSP cassette, 900um, 1m leads, No connectors. 100G, Start channel CHXX	\$160.00
Z1DWMY4CXX91NC	4 channel DWDM, OSP cassette, 900um, 1m leads, No connectors. 100G, Start channel CHXX	316.00
Z1DWMY8CXX91NC	8 channel DWDM, OSP cassette, 900um, 1m leads, No connectors. 100G, Start channel CHXX	620.00
Z1DWMY16CXX91NC	16 channel DWDM, OSP cassette, 900um, 1m leads, No connectors. 100G, Start channel CHXX	1,252.00
Z1DWMY20CXX91NC	20 channel DWDM, OSP cassette, 900um, 1m leads, No connectors. 100G, Start channel CHXX	1,560.00
Z1DWMY40CXX91NC	40 channel DWDM, OSP cassette, 900um, 1m leads, No connectors. 100G, Start channel CHXX	3,120.00

ITU DWDM Channels: [20,21,22,23,24,25,26,27,28,29,30,31,32,33,34,35,36,37,38,39,40,41,42,43,44,45,46,47,48,49,50,51,52,53,54,55,56,57,58,59,60](#)

Note: "XX= 20" for starting channel 20 (1561.42nm)  
 Y=1 (100GHz spacing); 2 (200GHz spacing)

**DWDM LGX PASSIVE MODULES**

Dense Wavelength Division Multiplexing (DWDM) LGX (Light Guide Cross-connect) Modules are available in 2, 4, 8, 16, 20 and 40 channels. These passive modules utilize 100GHz or 200GHz channel spacing; this is represented in the part number by the variable Y (1=100GHz and 2=200GHz). These modules are available with ITU channels 20 – 60. The DWDM LGX modules are sold with LC/APC connectors (w/ adapters) and packaged inside of a cassette. The cassette is plug and play making installation quick and efficient. The LGX standard or foot print is widely used with rack and wall enclosure face plates. These modules are 1 RU (Rack Unit – 1.75 inches) and fit into a standard 19 inch enclosure. When ordering please note the starting channel (ex. Channel 20 = 20, Channel 40 = 40 etc.) as the two XX variables at the end of your part number.

PART #	DESCRIPTION	PRICE
Z1DWMY2CXX1LLA	2 channel DWDM, LGX, LC/APC connectors, 100G, Start channel CHXX	\$172.00
Z1DWMY4CXX1LLA	4 channel DWDM, LGX, LC/APC connectors, 100G, Start channel CHXX	326.00
Z1DWMY8CXX1LLA	8 channel DWDM, LGX, LC/APC connectors, 100G, Start channel CHXX	650.00
Z1DWMY16CXX1LLA	16 channel DWDM, LGX, LC/APC connectors, 100G, Start channel CHXX	1,300.00
Z1DWMY20CXX1RLA	20 channel DWDM, 1RU 19inch Rackmount enclosure, LC/APC connectors, 100G, Start channel CHXX	1,640.00
Z1DWMY40CXX1RLA	40 channel DWDM, 1RU 19inch Rackmount enclosure,, LC/APC connectors, 100G, Start channel CHXX	3,240.00

ITU DWDM Channels: [20,21,22,23,24,25,26,27,28,29,30,31,32,33,34,35,36,37,38,39,40,41,42,43,44,45,46,47,48,49,50,51,52,53,54,55,56,57,58,59,60](#)

Note: "XX= 20" for starting channel 20 (1561.42nm)  
 Y=1 (100GHz spacing); 2 (200GHz spacing)



**CWDM  
LGX Passive Modules**



**DWDM  
OSP and LGX Passive Modules**



**DID YOU KNOW...**

**Insertion Loss For  
Multi-Splitter /  
Couplers**

WDM technology allows for massive data thru-put over optical fiber. These technologies are often used to increase the capacity of legacy fiber optic systems.

**Insertion Loss For  
Multi-Splitter / Coupler**

Split Ratio (%)	Typical Insertion Loss (dB)
1x2	<4.0
1x4	<7.2
1x8	<10.6
1x16	<13.7
1x64	<16.6
2x2	<4.0
2x4	<7.6
2x8	<11.2
2x16	<14.4
2x32	<18.0

# COMMSCOPE® COMMSCOPE FOSC 450 FIBER OPTIC GEL CLOSURE

- Splice trays are hinged for direct access to any splice without disturbing other trays
- Can be used in aerial and burial conditions
- Gel seal automatically adjusts to cable size and shape without tools
- **Splice trays not included**

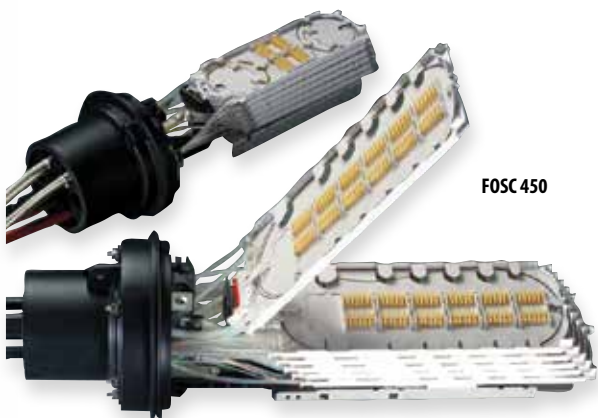

FOSC 450

Closure	A4	B6	D6
Dimensions (inch) (Including Clamp)	8.5"	10"	12"
Length	19"	21"	30"

Splice Capacity	A4	B6	D6
Number of Trays	4	6	8
Single Fiber	96	144	768
Ribbon (12F)	144	288	1152
Cable Ports	4 Ports	6 Ports	6 Ports

A4: 2 small ports, each for cables .3-.9 inch diameter., 2 large ports for cable .4-1.1 inch diameter  
 B6 - D6: 6 ports, each for cable .35-1.0 inch diameter



FOSC-ACC-D-72



FOSC-ACC-B-24



FOSC-ACC-A-24

PART #	DESCRIPTION	PRICE
FOSC450A42NT0A1V	COMMSCOPE "A" Closure, 4 round ports, holds up to 96 splices (8"W x 19"L) - Splice Trays Not Included	\$185.00
FOSC450B66NT0B3V	COMMSCOPE "B" Closure, 6 round ports, holds up to 144 splices (10"W x 24"L) - Splice Trays Not Included	325.00
FOSC450D66NT0D3V	COMMSCOPE "D" Closure, 6 round ports, holds up to 768 splices (11.5"W x 30"L) - Splice Trays Not Included	510.00

## COMMSCOPE ACCESSORIES & SPLICE TRAYS

Commscope splice trays are manufactured for specific style closures. Be sure to match the type of closure to correct splice tray. Trays range from 12 count to 72 count single fiber splices.

PART #	DESCRIPTION	PRICE	PART #	DESCRIPTION	PRICE
FOSC-ACC-A-12	Splice tray for "A" closure 12 Count (box of 2)	\$26.70	FOSC-ACC-D-72	Splice Tray for "D" Closure, 72 Count Capacity (box of 2)	\$71.50
FOSC-ACC-A-24	Splice Tray for "A" Closure 24 Count (box of 2)	39.50	FOSC-ACC-CABLESEAL1NT	Cable Sealing Kit for 1 round port cable	27.95
FOSC-ACC-B-12	Splice Tray for "B" Closure 12 Count (box of 2)	37.50	FOSC-ACCDBASKETTALL	Fiber Slack Storage Basket	47.25
FOSC-ACC-B-24	Splice Tray for "B" Closure 24 Count (box of 2)	45.00	SMOUV-112001	60mm Splice Sleeve (100pk)	29.95
FOSC-ACC-D-36	Splice Tray for "D" Closure 36 Count (box of 2)	56.00	SMOUV-112002	45mm Splice Sleeve (100pk)	29.95

PART #	DESCRIPTION	PRICE
FOSC-ACC-AERIALCLAMPS	(2) Hanger Brackets and Clamps, (2) Snaplock Clamps, (2) Lashing Straps for FOSC450 Closures	\$35.00
FOSC-ACC-WALLPOLEMOUNT	FOSC450 Closure Wall/Pole Mount Hardware	38.95
FOSC-ACC-LASHINGSTRAPS	(2) Metallic Lashing Straps, (2) Nylon Lashing Straps and (4) Cable Spacers for FOSC450 Closures	19.50



FOSC600D8BNT0D0V

## COMMSCOPE FOSC 600 SERIES FIBER OPTIC SPLICE CLOSURE

- 4 Multi-Out Ports (16 Cables)
- Butt or Inline Splice Closure With Gel Sealing Technology
- Compatible With Most Existing Cable Constructions (Loose Tube, Central Core)
- Splicing Capacity, Single Fusion, Maximum 864
- Splicing Capacity, Mass Fusion, Maximum 1,728

PART #	DESCRIPTION	PRICE
FOSC600D8BNT0D0V	Closure, Splicing Capacity, Single Fusion, maximum 864, for Loose Tube Cable (No Splice Tray Included)	\$170.00

# CORNING 2178 SERIES CLOSURES (SPLICE TRAYS NOT INCLUDED)



Corning Fiber Optic Splice Closure 2178 is engineered to meet common needs and field conditions, with different sizes to accommodate varying splice counts. 2178 Closures are made of a tough chemical-resistant material and have a gasket seal, making them ideal for a wide variety of applications. All 2178 closures are designed to be easy to install, easy to use and easy to re-enter.

- Full range of sizes - Fits your specific application
- No special tools required (standard torque wrench) - Easy installation and re-entry
- Constructed of a highly chemical-resistant material - Can be deployed in most applications: buried, underground and aerial
- Gasket seals - Reusable for easy re-entry

PART #	DESCRIPTION (SPLICE TRAYS NOT INCLUDED)	PRICE
2178-XSBEGOT	Compact Splice Case (14.5"L x 10"W x 4.6"H), up to 48 splices, butt splice only, use 2532 splice tray	\$153.00
2178-S	Small Splice Case (21.9"L x 8.5"W x 4.7"H), up to 96 splices, use 2522/2523 splice trays	240.00
2178-LS	Standard Splice Case (21.9"L x 8.5"W x 8"H), up to 192 splices, use 2522/2523/2524FT trays	300.00
2178-LL	Large Splice Case (21.9"L x 8.5"W x 11.3"H), up to 312 splices, use 2522/2523/2524FT trays	365.00



## CORNING FIBER OPTIC SPLICE TRAYS AND OSP ACCESSORIES FOR 2178 SERIES

PART #	DESCRIPTION	PRICE
2532	Splice tray for 2178XSB, stackable/entry-exit both ends, up to 24 single fusion splices	\$19.50
2524-FT	Fusion splice organizer tray, holds 24 single fusion splices (splice inserts included)	44.25
2522	Fiber splice organizer tray – small (holds 2 chips/24 fiber) (11.5"L x 4"W x .75"H)	25.50
2523	Fiber splice organizer tray – large (holds 4 chips/48 fiber) (15"L x 4"W x .75"H)	28.95
2521F	Single fusion splice inserts (2 pack) -Fit 2522,2523,2527 trays (12 splices per insert)	18.00
2181-LS	Cable addition kit for 2178LS/LL cases, allows for 3 additional trays/4 cable ports.	115.00
2183-HAB	Gasket for 2178LS series splice cases	50.30
2527	Fiber Splice Organizer Tray – 24 single fusion	31.25
4414	CORNING Cable Cleaning Kit	35.95
4460-DF0	CORNING Scotchlok Shield Bond Connector Assembly	5.25

## AFL OptiNID® 500 OPTICAL DEMARCATIION CLOSURE

The OptiNID (OPN) 500 is an optical demarcation closure designed for use in either indoor or outdoor environments. Smaller to suit FTTH demarcation applications and versatile to suit Category cable or coax connections, the closure is capable of housing up to six bulkhead adapters in one LGX® 118 compatible adapter plate.

- Weather-resistant thermoplastic alloy
- 1/2" or 3/4" NPT conduit fitting, compression cable fittings or grommeted entry ports

PART #	DESCRIPTION	PRICE
DM000614	1/2" NPT, Plug, Grommet, LGX 118 Black, 1 x SC/APC Adapter	\$45.25

See SC and LC adapters for enclosures located on pages 146 and 147



## AFL OptiNID® DUO OPTICAL NID

The latest entry in the AFL family of NID products. Can hold up to 4 SC simplex or LC duplex adapters and has built in splice sleeve holders for 18 single fiber or 6 ribbon fiber splices. Can install both quick termination and splice on connectors such as FUSECONNECT. The OPN Duo is available with two different base cable entry options, either a pair of U-shaped "drop-in" style grommets, or two half-inch ports allowing for a variety of different entry accessories. Dimensions: 9.6"H x 7"W x 2.7"D

PART #	DESCRIPTION	PRICE
OAA1X4XPXXU	Duo Optical NID (2) "U" cable drop in grommets, holds up to 4 SC/duplex LC adapters, no adapters included, with grounding and splice holder	\$39.95
OAA1X4XPXG	Duo Optical NID (2) round 1/2" rubber grommet holes, holds up to 4 SC/duplex LC adapters, no adapters included, with grounding and splice holder	39.95
AXTRAYMOD20	OptiNID Duo Splice Module, pack of 20	39.95

See SC and LC adapters for enclosures located on pages 146 and 147





## AFL APEX X-2 ENCLOSURES

New APEX X-2 enclosures are designed for above or below grade applications in butt configuration. X-2S is capable of 216ct single fusion or 432 ribbon splices. Cables sealed with unique wedge system, each cable opened by press-to-release lever and is individually sealed with tool-less mechanism.



**APEX-2S:** Dimensions: 20" x 12", Weight 22lbs(no trays), Splice Capacity 216 Single/432 Mass, Tray Capacity is 6, Single Port Cable OD 10-28mm, Multi-Drop Port Cable OD 5-9.9mm.

PART #	DESCRIPTION	PRICE
AX2SBX022X	AX-2S Enclosure with Basket, No Trays Installed, 2 Strain Relief Kits and 2 Ground Lugs	\$258.95
AXTRAY2S1	X-2S Splice Tray with One Splice Module 36 Single Splices or 144 Ribbon Fiber Splices	14.25
AXTRAY2S2	X-2S Splice Tray with Two Splice Modules 72 Single Splices or 576 Ribbon Fiber Splices	15.95
AXKITAERIAL1	X-2S Aerial Strand Mount Hanger Kit	35.95
XABR30	X-2S Pole/Wall Mount Hanger Kit	101.95

**APEX-2:** Dimensions: 25" x 12", Weight 25lbs(no trays), Splice Capacity 432 Single/864 Mass, Tray Capacity is 6, Single Port Cable OD 10-28mm, Multi-Drop Port Cable OD 5-9.9mm.

PART #	DESCRIPTION	PRICE
AX2BX022X	AX-2 Enclosure with Basket, No Trays Installed, 2 Strain Relief Kits and 2 Ground Lugs	\$296.35
AXTRAY22	X-2 Splice Tray with One Splice Module 18 Single Splices or 72 Ribbon Fiber Splices	18.95
AXTRAY24	X-2 Splice Tray with Two Splice Modules 36 Single Splices or 288 Ribbon Fiber Splices	22.95
AXKITAERIAL1	X-2 Aerial Strand Mount Hanger Kit	35.95
AXB30	X-2 Pole/Wall Mount Hanger Kit	101.95
FC001567	Silicone Spiral Wrap 5.5FT for routing fibers inside Enclosure	21.50
FC001759	Velcro for securing bundles in Slack Basket, 75 ft length	31.50



## AFL LG-500 AERIAL FIBER OPTIC CLOSURE

This aerial weather tight fiber optic splice closure is for small to medium counts up to 72 fiber (or 288 ribbon fiber). Splice trays are available for single, mass or mechanical splicing. **Splice Trays Not Included**

- Four individual, self-sizing grommeted cable ports
- Tongue-in-groove cover seal system
- Holds (3) single fiber trays, holds (2) mass fiber trays
- Accommodates cables sizes 0.77" - 0.3"
- Weight 6.4 lbs, Dimensions 24" x 8.25" x 4"

PART #	DESCRIPTION	PRICE
FC000026	LG-500 Aerial Compact Splice Closure with standard aerial hangers (no splice trays included)	\$132.75
911289-00-02	Universal splice tray (1) 24 fiber single fiber chip/(1) dual ribbon splices and VHB tape for mechanical splices	23.00



LG-500



## AFL LG-250 AND LG-350 SEALED FIBER OPTIC CLOSURE

This sealed dome closure is for medium count fiber splicing up to 96 fibers (288 ribbon) in a butt configuration. Can be utilized for aerial or underground applications where a sealed closure is required. Requires no tools for re-entry. **Splice Trays Not Included**

- Supports loose tube, central tube, dielectric and armored cable constructions
- 5 Cable ports and fully kitted with all parts to install five cables
- Holds (4) single fiber trays, (2) Ribbon fiber trays or (3) Mechanical splice trays
- Accommodates cables sizes 0.77" - 0.3"
- Weight: 11.5 lbs, Dimensions 19" x 8.75"

PART #	DESCRIPTION	PRICE
FC000002-PS	LG-250 Dome Closure with 5 cable kits for sealing and retention. (No splice trays, hanger brackets)	\$237.45
FC000009-PS	Dome Enclosure 288 Single or 864 Mass Fusion Capable 5 Cable Kits for Sealing & Retention	303.00
911289-00-02	Universal Splice Tray (1) 24 fiber single fiber chip/(1) dual ribbon splices and VHB tape for mechanical splices	23.00
FC000655	3-port flat drop grommet for standard size drops for LG 150/250	19.55
911676-00-02	LL-4896 Universal Splice Tray—Stores (96) single fusion splices or (24) mass fusion splices (288 F). Maximum of 5 trays in the LG-350	35.25
FC000726	LG-350 Single Grommet Kit (Min. 0.40" - Max. 1.00")—For use in LG-350/AC/SD on Express Port side	25.00
FC000337	LG-350 Dual Grommet Kit (Min. 0.26" - Max. 0.44")—For use in LG-350/AC/SD on Express Port side	29.95
FC000421	LG-350 Quad Grommet Kit (Min. 0.26" - Max. 0.38")—For use in LG-350/AC/SD on Express Port side	25.00
FC000727	LG-350 Single Grommet Kit (Min. 0.26" - Max. 0.80")—For use in LG-350/AC/SD on Drop Port side	23.00
FC000422	LG-350 Drop 4 Flat Drop Grommet Kit—For use with standard flat drop cable and round cable up to 0.25" O.D.	15.30

LG-250



## AFL FIBER STORAGE UNITS

AFL Fiber Storage Units (FSU) are used to conveniently and safely store an extra length of cable along the support strand for later use. Sold as pairs (kit contains 2 FSUs and 2 sets of hanger brackets). FSUs are constructed from dielectric polypropylene with UV inhibitor or aluminum with baked acrylic enamel finish. All basic hardware for attachment to the support strand is provided. Galvanized strand clamping devices accommodate 1/4" to 7/16" strand.

PART #	DESCRIPTION	PRICE
FA000004	FOSP-12-TMK Dielectric pair 12" with Horizontal Bracket	\$54.75
FA000002	FOSP-17-TMK Dielectric pair 17" with Horizontal Bracket	69.05



## COYOTE ONE DOME CLOSURE

(Splice Trays NOT Included)

PART #	DESCRIPTION	GROMMETS	PRICE
COY1-001	Coyote One Closure, 16" x 10" x 5.7", 3-section endplate, holds 2 Lite-Grip or 5 low profile short splice trays	8003663 8003676	\$184.50
COY1-002	Coyote One Closure with Universal Organizer for Ribbon or Buffer Fiber		184.50
80811036	6 Part Drop Cable Retention Bobbin Kit		6.15
80811037	4 Part Drop Cable Retention Bobbin Kit		6.15
8004032	ADSS Mount Bracket Offset Adjustable		31.70
EVOBKTPWM	Pole / Wall Mount Bracket		42.10
8003835	Handhole Mounting Bracket		24.80
80809958	24ct Fusion Splice Tray		26.20
LGSTR144	144ct Ribbon Mass Fusion Tray		22.05

INCLUDED COMPONENTS



Grommet Cable Entry for COYOTE Dome Closures

## LOW COUNT CLOSURES (Splice Trays NOT Included)

- LCC Closure (Splice Tray Included)
- Designed for Round or Flat Drop Cable
- Max Splice Capacity - 24 single fusion / 72 ribbon fibers
- In-Line or Butt application

- Compact Size: 17" x 7" x 2.5"
- Designed for direct buried, below grade, pole/wall mount or aerial applications

PART #	DESCRIPTION	INCLUDED SPLICE TRAYS/BLOCKS	INCLUDED GROMMETS	PRICE
COYLCCF-001	LCC for Single Fusion Splices	(3) single fiber LiteGrip Splice Blocks	(1) 7-hole, (1) 12-hole	\$52.45
COYLCCF-002	LCC for Single Fusion Splices with Strength member Bobbin Kit	(3) single fiber LiteGrip Splice Blocks	(1) 7-hole, (1) 12-hole	56.55
COYLCCF-004	LCC for Single Fusion Splices	(3) single fiber LiteGrip Splice Blocks	(2) 7-hole	52.55
COYLCCF-005	LCC for Single Fusion Splices	(3) single fiber LiteGrip Splice Blocks	(2) 2-hole	53.55
COYLCCF-006	LCC for Single Fusion Splices	(3) single fiber LiteGrip Splice Blocks	(2) 4-hole	53.55
8003832	Aerial Mounting Bracket for LCC			9.20

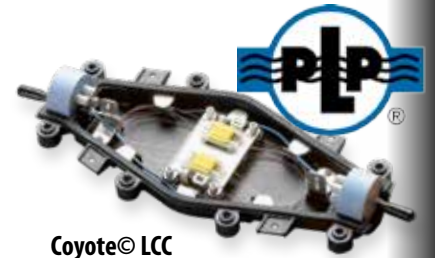

Coyote© LCC

## COYOTE DOME CLOSURES (Splice Trays NOT Included)

PART #	DESCRIPTION	INCLUDED GROMMETS	PRICE
8006877	Dome (6.5" x 22") 4-section endplate, holds 3 Lite-Grip or 6 low profile Long Splice Trays	8003701	\$345.60
8006944	Dome (6.5" x 17") 4-section endplate, holds 3 Lite-Grip or 6 low profile Short Splice Trays	8003701	215.85
80061055	Dome (9.5" x 28") 7-section endplate, holds 7 Lite-Grip or 13 low profile Long Splice Trays, with Buffer Tube Organizer	8003692 / 8003693	467.25
800013691	Dome (9.5" x 19") 7-section endplate, holds 6 Lite-Grip or 12 low profile Short Splice Trays	8003692 / 8003693	337.35
LGSTS16	Lite Grip Splice Tray Kit, Short Tray, includes 2 splice blocks to support up to 16 Single Fusion Splices		23.00
LGSTS40	Lite Grip Splice Tray Kit, Long Tray, includes 5 splice blocks to support up to 40 Single Fusion Splices		30.50
LGSTS72	Lite Grip Splice Tray Kit, Deep Profile, Long Tray, up to 80 Single Fusion Splices		34.50
8004035	Aerial hanger bracket for Dome Closure		29.95
8003663	2-entry grommet for .42-.60" port for Corning SST Cable		12.80
80807701	12ct Low Profile Short Tray with Splice Block		26.95
8001127	36ct Low Profile Long Tray with Splice Block		49.25
80805514	36ct Splice Tray		49.25
80809958	24ct Short Splice Tray		26.20
8003702	Pole/Wall Mount Bracket		35.25



LGSTS40



8006877

COYOTE Dome  
6.5" x 22"

## Grommets for New Breed of COYOTE Closures

PRICE	8003701	8003691	8003692	8003693	8003694	8003663	8003664	8003665	8003676	8003677	8003796
1-9 \$11.25 Each											
10+ \$10.50 Each											
Hole Range (in)	.42-.60 in. .60-.85 in	.42-.60 in.	.60-.85 in	.85-1.0 in	1.0-1.25 in.	.42-.60 in.	.30-.43 in.	.125-.25 in. and Flat Drop	.42-.60 in. .125-.25 in. and Flat Drop	.125-.25 in. and Flat Drop	.125-.25 in. Flat Drop Only



## IN-LINE RUNT CLOSURES & ACCESSORIES (Splice Trays NOT Included)

This family of closures offers a wide variety of applications from aerial to direct burial installations.

PART #	DESCRIPTION	PRICE
8006951	In-Line Runt Closure (10" x 3.5" x 17.5") holds 2 splice trays, up to 24 single fiber splices, includes (4) 2-Hole	\$153.00
80806033	Standard Splice Tray 12ct	26.95
80807701	Low Profile 12ct Splice Tray	23.25
8003490	Blue Felt Tape, Adhesive Back, (6) Strips for use with Splice Trays	5.90



## PLP SNOW SHOES – FIBERLIGN IN-SPAN STORAGE

Preformed Line Products' aerial cable attachment hardware solutions use innovative Cable Capture Tabs to efficiently manage cable slack making them simpler, easier and quicker to install with fewer cable ties. This saves time and money and makes adjustments for slack loop length easy. The unique CLAS system can be used with either ADSS or lashed applications and simply folds over the cable and straps in place without needing any mounting hardware. CLAS units include cable ties. Abrasion protection guides are standard with the CLAS system and optional for the other styles. Optional block style Uni-Group cable guides are also available for all styles. Please contact FIS for these options.

PART #	DESCRIPTION	PRICE
FIS-12A	12" ADSS Mount Snow Shoe (one pair)	\$55.00
FIS-12M	12" Strand Mount Snow Shoe (one pair)	55.00
FIS-16A	16" ADSS Mount Snow Shoe (one pair)	56.95
FIS-16M	16" Strand Mount Snow Shoe (one pair)	52.25
710012375A	20" CLAS Universal Snow Shoe System (one pair)	106.75



## FIBERLIGN DROP CABLE STORAGE BRACKETS

Stores slack cable in aerial, pole mount, vault and wall entrance installations. Stores flat drop cable and round drop cable up to 0.40" OD. 8" diameter size, All Dielectric, UV Resistant, Safe for Long Term Use. Stackable, Provides multi-level slack management.

PART #	DESCRIPTION	PRICE
FDC8	Fiberlign Drop Cable 8" Single Storage Bracket, Vault/Wall Service Entrance	\$20.15
FDC8M	Fiberlign Drop Cable 8" Single Storage Bracket, Aerial Lashed Messenger Systems	22.80
FDC8A	Fiberlign Drop Cable 8" Single Storage Bracket, Aerial ADSS Systems	26.65
FDC8P	Fiberlign Drop Cable 8" Single Storage Bracket, Wood Pole	26.10
7400029	Messenger Hanger Bracket	7.95
7400028	ADSS Hanger Bracket	7.95
7400030	FDC8 Stacking Kit with Spacers	7.95

## DID YOU KNOW... IP VS. NEMA RATING?



There are two classifications for the degree of protection that an outside enclosure provides from solid objects and liquids in order to operate the enclosed electrical or optical equipment. The IP rating system set forth by the IEC is the rating system most prevalently recognized in Europe. In the United States, the National Electrical Manufacturers Association developed the NEMA rating for classifying an enclosure's level of protection from those environmental elements. While these test are different, you can use charts for finding equivalent ratings, at right are popular equivalents that are frequently asked.

4	Intended for indoor or outdoor use primarily to provide a degree of protection against windblown dust and rain, splashing water, hose-directed water, and damage from external ice formation.	NEMA 4 meets or exceeds IP56
4X	Intended for indoor or outdoor use primarily to provide a degree of protection against corrosion, windblown dust and rain, splashing water, hose-directed water, and damage from ice formation.	NEMA 4X meets or exceeds IP56
6	Intended for indoor or outdoor use primarily to provide a degree of protection against hose-directed water, the entry of water during occasional temporary submersion at a limited depth, and damage from external ice formation.	NEMA 6 meets or exceeds IP67

See FIS website for full listing

**FIBER OPTIC DROP CABLE CLAMPS**

PART #	DESCRIPTION	PRICE
SI097210	Fiber Optic Dropwire Clamp(10pk)	\$21.95
SI09725BLEA10	Fiber Optic Drop Cable Clamp for Butterfly Style(10pk)	13.95



**To order the following components please have specific information regarding Application, Cable Construction/Part Number and Span/Loading details. Without this specific information FIS is not able to accurately quote any ADSS products. Please call for pricing.**

**FIBERLIGN LITE TENSION DEAD-ENDS**

The FIBERLIGN Lite Tension Dead-end is a dielectric dead-end designed to terminate short-span, low-tension ADSS fiber optic cables in low-voltage environments. The product effectively transfers the low axial load on the cable at the end of the dead-end legs to allow uniform radial compression near the dead-end loop. **This component must be ordered specifically based on cable Outside Diameter and span length. Part number will vary depending on cable O.D.**

**FIBERLIGN LITE SUPPORT (FLS)**

The FIBERLIGN Lite Support (FLS) system is designed to gently, but firmly, support All-Dielectric Self-Supporting (ADSS) cable. It is intended for tangent support installations on lines that feature relatively low voltages, very short spans and low mechanical loads. For most applications, the maximum line angle recommended is 20 degrees. **This component must be ordered specifically based on cable Outside Diameter and span length. Part number will vary depending on cable O.D.**

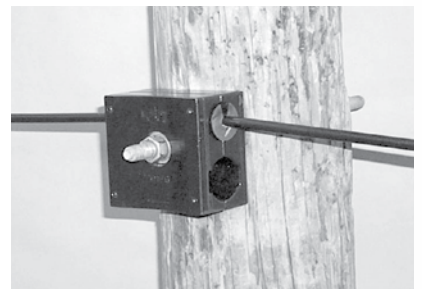
**FIBERLIGN DIELECTRIC SUPPORT (FDS)**

The FIBERLIGN Dielectric Support (FDS) system is designed to gently, but firmly, support All-Dielectric Self-Supporting (ADSS) cable. It is intended for tangent support installations on lines that feature relatively low voltages, short spans and modest mechanical loads. **This component must be ordered specifically based on cable Outside Diameter and span length. Part number will vary depending on cable O.D.**

**FIBERLIGN ALUMINUM SUPPORT (FAS)**

The FIBERLIGN Aluminum Support (FAS) is designed to gently, but firmly support All-Dielectric Self-Supporting (ADSS) cable. The FAS features the following: integrated bolt or band mount design, hinged keeper and base, single-bolt clamping, and stackability for multi-cable installations. For higher voltages (where track-resistant ADSS cables are required), longer spans and/or higher loads, use either the FIBERLIGN Aluminum Suspension with rods or the FIBERLIGN Dielectric Suspension. Maximum line angle typical is 20 degrees or less. **This component must be ordered specifically based on cable Outside Diameter and span length. Part number will vary depending on cable O.D.**

**FIBERLIGN ALUMINUM SUSPENSION (FASN)**

The FIBERLIGN Aluminum Suspension (FASN) is designed to gently, but firmly support All-Dielectric Self-Supporting (ADSS) cable. The FASN features the following: Short-to-Medium Span Option, Low-to-High Voltage Environment acceptance. **This component must be ordered specifically based on cable Outside Diameter and span length. Part number will vary depending on cable O.D.**

# CABLE

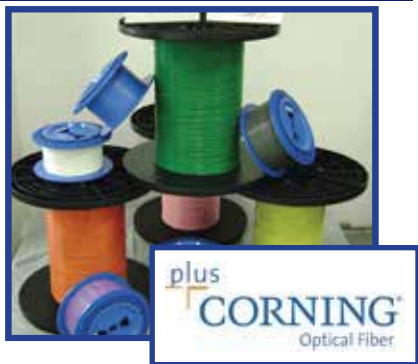

## RE-SPOOLING SERVICE

We cut and spool fiber or cable to your specified lengths



POF-KIT

Fiber Instrument Sales, Inc. (FIS) is able to provide UL approved and RoHS compliant custom manufactured fiber optic cable. These cables are available in a variety of standard configurations as well as custom built to your specifications. Standard fiber optic cable including simplex, duplex and multifiber styles are in stock for quick delivery. In addition, our extrusion machines are capable of manufacturing fiber optic cable with different jacket colors, coating diameters, fiber counts, tight buffer diameters, jacket materials and more. To request additional information regarding TLC cable, call your FIS sales representative today! Please note: Cable is printed with only core/clad, fiber length and UL markings.

### CABLE BUYING GUIDELINES

1. We strive to cut the cable that you order to the exact length that you request. This is not always possible, so following industry standard practice regarding cable, for shipping and billing purposes, we will not ship less than the amount that you order, but we may ship and bill up to 10% more than the length you specify when placing your order. (Allowable cable length for shipping and billing purposes is -0/+10%).
2. Cable cut/spool fees may apply on custom lengths. Please contact your FIS Sales Representative for pricing.
3. Cut charges do not apply when cable reels that are in stock are offered and accepted.
4. Minimum order quantities on non-stock cable will be required.
5. OS2 SM, OM3 MM, and OM4 MM Bare Ribbon Fiber is offered in stock spool lengths of 153 meters, 305 meters, 610m, 915m, 1,525m, and 2,000 meters. We have the ability to custom cut lengths up to, but not exceeding 100 meters. If you require a custom cut length greater than 100 meters, a \$25.00 cut fee and 2-3 week lead time will apply. The cut fee covers up to 4 cuts, an additional fee will apply to 5 or more custom cuts.

### THREE-PIECE SPOOL

The three-piece spool features plastic flanges bolted to a kraft barrel, creating a durable, dimensionally true and splinter-free reel. Flange diameter is 12", 14" or 18" while the barrel diameter is 8.25", making it perfect for bulk cable or long assemblies. Three fastening bolts used. Unassembled versions available reducing shipping cost and storage space.

PART #	DESCRIPTION	PRICE
F1-12SPOOL	Three Piece Spool - 1.75 Arbor Hole - 12"x 9" x 6"	\$11.95
F1-14SPOOL	Three Piece Spool - 1.75 Arbor Hole - 14"x 9" x 6"	13.95
F1-18SPOOL	Three Piece Spool - 1.75 Arbor Hole - 18"x 15.5" x 7.75"	15.95

### TLC PLASTIC FIBER OPTIC CABLE AND ACCESSORIES

TLC plastic optical fiber cables are designed for data transmission applications. The standard product is a 2.2mm jacket over 1.0mm step index PMMA plastic fiber. Standard colors are red and black, other colors are available upon request.

PART #	DESCRIPTION	DIA.	PRICE
P96TB01TRBL22	980/1000µm Core Simplex Plastic Fiber (Black)	2.2mm	\$1.40 /Mtr.
P96TD02TRBL44	980/1000µm Core Duplex Plastic Fiber (Black)	2.2/4.5mm	2.85 /Mtr.
POF-KIT	Plastic Fiber Optic Tool Kit		\$135.00
POF-HKN	Hot Knife for Cutting Plastic Fiber of all Diameters		28.95
F1-0065	ST Connector 1mm Stainless Alloy Ferrule for Plastic Fiber		3.75



## DID YOU KNOW... 10 GIG, CLEARCURVE® & BEYOND

What is OM1, OM2, OM3 and OM4 MULTIMODE CABLE?

Fiber-to-the-Home and Desk (FTTx) applications have resulted in the creation of several new grades of multimode fiber. The use of Gigabit and 10 Gig fibers can help future proof your network. Bend insensitive fibers, like Corning® ClearCurve can be bent down to very small diameters without affecting the optical signal. FTTx applications use Bend Insensitive fiber because of its ease and flexibility of installation.

TLC's Gigabit Cables are designed with ClearCurve optical fibers, engineered for laser-based local area network protocols such as Gigabit Ethernet. Thanks to Corning's latest innovation, the new SMF-28® Ultra optical fiber was the first in the market to combine the benefit of industry-leading attenuation and improved macrobend performance in one fiber. TLC will also customize materials and constructions to meet your individual requirements.

FIBER TYPE	STANDARD DESIGNATION	JACKET COLOR (typical)	MAXIMUM ATTENUATION (dB/km)			TRANSMISSION DISTANCE FOR (in meters)				MINIMAL MODAL BANDWIDTH (MHz/km)			
			850nm	953nm	1300nm	1 Gb/s	10 Gb/s	40 Gb/s	100 Gb/s	OVERFILLED LAUNCH (OFL) 850nm	OVERFILLED LAUNCH (OFL) 1300nm	OVERFILLED LAUNCH (EMB) 850nm	OVERFILLED LAUNCH (EMB) 953nm
62.5/125	OM1	Orange	2.9	-	0.6	275	33	-	-	200	300	-	-
50/125	OM2	Orange	2.3	-	0.6	550	150	-	-	700	500	950	-
50/125	OM3	Aqua	2.3	-	0.6	550	300	100	70	1500	500	2000	-
50/125	OM4	Aqua	2.3	-	0.6	550	550	150	100	3500	500	4700	-
50/125	OM5 (WB)	Lime Green	2.3	1.7	0.6	550	550	150	100	3500	500	4700	2470

Corning® ClearCurve® optical fiber

ClearCurve® fibers are fully compliant with ITU-T G.652.D and G.657 standards. These fibers are designed to meet a wide array of applications including both inside and outside plant installations. Network designers, operators, and installers choose ClearCurve fibers for their superior bending performance, backward compatibility with the G.652.D standard and their ability to minimize bend-loss throughout any installation. Use the chart, right, to aid in selecting the right ClearCurve fiber for your application.

Corning Product	Application	ITU-T	Radius	Corning Spec
ClearCurve® ZBL optical fiber or ClearCurve® LBL optical fibers	<ul style="list-style-type: none"> <li>• Virtually no bend-loss in most indoor applications</li> <li>• Very low loss in extreme (5mm) bend environments</li> <li>• Enables smaller components and flexible yet reliable networks</li> </ul>	Exceeds G.657. A3/B3	5mm	<0.10 dB/turn
			7.5mm	
SMF-28® Ultra Optical Fiber	<ul style="list-style-type: none"> <li>• Improved performance vs. standard singlemode fiber</li> <li>• Fully backward compatible with the installed base of legacy single-mode fibers.</li> <li>• Enables a broader range of cable design options and deployment flexibility</li> </ul>	Exceeds G.657.A1	10mm	<0.50 dB/turn





**CORNING® BARE FIBER (245µm)**

For high-data-rate, long haul terrestrial, regional and metropolitan ring networks or local access and premise applications. Corning® offers fibers that are designed for greater capacity and flexibility. **Respooling capabilities are available.** *Quantity discounts available for large quantities.*

PART #	DESCRIPTION (Spool Length -0/+10%)	50mtr	100mtr	500mtr	1000mtr	1000mtr+/- Spool
SMF-28e+®	Singlemode SMF-28e+ fiber OS2 G.652.D Compliant	\$20.00	\$30.00	\$50.00	\$90.00	8¢ mtr. + \$10.00
SMF-28® Ultra	Singlemode SMF-28 Ultra OS2 G.657.A1 Compliant	20.00	30.00	50.00	90.00	8¢ mtr. + \$10.00
SMFLF	Singlemode LEAF Non-Zero Dispersion-shifted fiber, G.655 Compliant	25.00	35.00	65.00	120.00	11¢ mtr. + \$10.00
ClearCurve® ZBL	Singlemode ZBL Enhanced Bend Insensitive, G657A2/B2 Compliant	30.00	40.00	85.00	160.00	15¢ mtr. + \$10.00
InfiniCor® 300	Infinicor 300 Multimode OM1 62.5/125µm	30.00	40.00	80.00	140.00	13¢ mtr. + \$10.00
ClearCurve® OM2	ClearCurve OM2 Multimode 50/125µm G.651.1 Compliant	30.00	40.00	80.00	140.00	13¢ mtr. + \$10.00
ClearCurve® OM3	ClearCurve OM3 Multimode 50/125µm G.651.1 Compliant	32.00	43.00	105.00	210.00	20¢ mtr. + \$10.00
ClearCurve® OM4	ClearCurve OM4 Multimode 50/125µm G.651.1 Compliant	35.00	45.00	165.00	310.00	30¢ mtr. + \$10.00

Attention Custom Lengths: The spools above can be shortened to specified length. Price = Cost of Fiber Spool (listed above) + Additional \$10 cutting to custom length.



**TLC 900µm TIGHT BUFFER SINGLEMODE AND MULTIMODE CABLE**

PART #	DESCRIPTION	PRICE
S09-TB01-CZNPW	White SM 9/125µm	18¢ /Mtr.
S09-TB01-CZNPB	Aqua SM 9/125µm	18¢ /Mtr.
S09-TB01-CZNPY	Yellow SM 9/125µm	18¢ /Mtr.
M62-TB01-C3NPW	White MM 62/125µm	23¢ /Mtr.
M62-TB01-C3NPO	Orange MM 62/125µm	23¢ /Mtr.
M50-TB01-C2NPO	Orange MM 50/125µm	35¢ /Mtr.
M50-TB01-CGNPA	Aqua ClearCurve® MM OM3	35¢ /Mtr.
M50-TB01-C4NPA	Aqua ClearCurve® MM OM4	50¢ /Mtr.

\* Minimum order quantity of 100 meters.

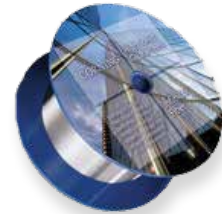

**TLC FLAT RIBBON BARE FIBER - OS2 / OM1 / OM2 / OM3 / OM4**

PART #	DESCRIPTION	PRICE
S09-RB12-CZ	12 Fiber Singlemode 9/125µm Bare 245µm - OS2	\$1.10 /Mtr.
M62-RB012-C	12 Fiber Multimode 62.5/125µm Bare 245µm - OM1	2.15 /Mtr.
M50-RB12-CG	12 Fiber Multimode 50/125µm ClearCurve® Bare 245µm - OM3	2.55 /Mtr.
M50-RB12-C4	12 Fiber Multimode 50/125µm ClearCurve® Bare 245µm - OM4	4.35 /Mtr.



**CORNING® SPECIALTY PM PHOTONIC FIBERS**

Corning® Specialty PM Photonic Fibers, designed with the best polarization maintaining properties in the world today, offer low attenuation and excellent birefringence for next generation network systems. The fibers are available in a wide range of standard operating wavelengths up to 1550nm, including 1400-1490nm optimized for Raman applications.

PART #	DESCRIPTION	PRICE
PM15-U25	Puremode™ PM 1550 with 250µm Dual Acrylate Coating (100KPSI)	\$8.75 /Mtr.
PM15-U40	Puremode™ PM 1550 with 400µm Dual Acrylate Coating (100KPSI)	8.75 /Mtr.
PM98-U25H	Puremode™ PM 980 with 250µm Dual Acrylate Coating (200KPSI)	8.75 /Mtr.



**FIBERCORE LTD. POLARIZATION MAINTAINING FIBER**

Fibercore's HB series polarization maintaining fiber (80 and 125 micron) with the characteristic "bow tie" stress applying parts gives you the very best in performance and handling.

PART #	DESCRIPTION	OPERATING WAVELENGTH	PRICE
HB1250P/001	Polyimide Coated PM Fiber (145µm coating) 6.6/125µm	1300nm	\$10.25 /Mtr.
HB1250T	PM Fiber for Telecom Applications (400µm coating) 9/125µm	1310nm	13.50 /Mtr.

**CORNING® SPECIALTY HI PHOTONIC FIBERS**

Corning® Specialty HI Photonic Fibers offer world class durability and reliability. When used as component pigtails, this fiber allows for efficient fiber coupling within photonic products.

PART #	MAXIMUM ATTENUATION	CUTOFF WAVELENGTH	MODE-FIELD DIA.	PRICE
HI980-6	≤ 2.5dB/km @ 980nm	930 ± 50nm	4.2µm @ 980nm	\$2.50 /Mtr.
HI1060-6-H	2.1dB/km @ 980nm 1.5dB/km @ 1060nm	920 ± 50nm	5.9 ± 0.5µm @ 980nm 6.2 ± 0.5µm @ 1060nm	3.50 /Mtr.

\* Minimum order quantity of 50 meters.



**FIBERCORE LTD. SPECIALTY SINGLEMODE FIBER**

Fibercore Ltd's Specialty Singlemode Optical Fibers (80 and 125 micron) have been proven to perform in a wide range of challenging applications for wavelengths from 450nm to 1500nm.

PART #	DESCRIPTION	OPERATING WAVELENGTH	PRICE
SM600	Singlemode Fiber 4.3/125µm (245µm coating)	633/688nm	\$2.95 /Mtr.
SM800	Singlemode Fiber 4.2/80µm (175µm coating)	830nm	3.50 /Mtr.

\* Minimum order quantity of 50 meters.



**TLC LARGE CORE FIBER CABLE**

PART #	DESCRIPTION	PRICE
M10-SX01-LNRG	100/140µm 3.0mm Simplex (MM) Green	\$2.65 /Mtr.
M20-SX01-LNRB	200/230µm 3.0mm Simplex (MM) Blue	1.35 /Mtr.
M10-DX02-LNRG	100/140µm 3.0mm Duplex (MM) Green	5.25 /Mtr.
M20-DX02-LNRB	200/230µm 3.0mm Duplex (MM) Blue	2.50 /Mtr.



# CABLE | SIMPLEX / DUPLEX - SINGLEMODE

FIS supplies the industry's broadest array of Fiber Optic Cable and Tubing for all Access and Premises Network Applications. These include Standard and Customized Simplex, Duplex, Tight Buffer, Distribution, Loose Tube Indoor/Outdoor and Ribbon Cable, as well as furcation tubing to fit various fanout applications.

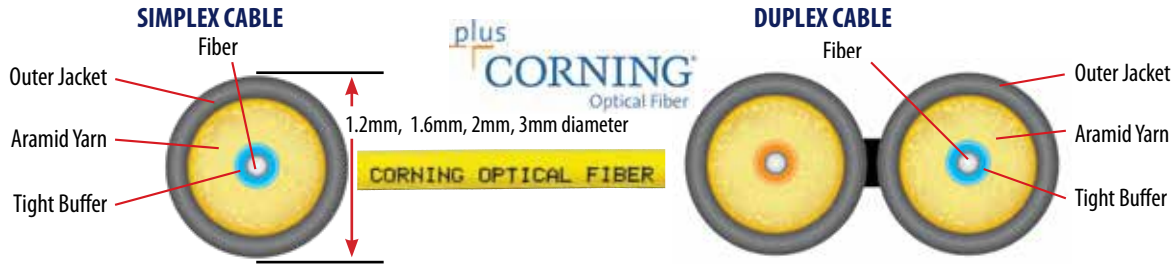

Corning's new SMF-28® Ultra optical fiber is the first in the market to combine the benefit of industry-leading attenuation and improved macrobend performance in one fiber. This premium single-mode fiber is designed for long-haul, metro, access, and fiber-to-the-home (FTTH) applications, and is fully backward compatible with the installed base of legacy single-mode fibers.

### Corning® SMF-28® Ultra Fiber

**Compatibility Matters.**

- MFD equivalence and 100% compatibility to G.652.D fiber allows for seamless integration into existing networks

**Bend Matters.**

The same improved bend performance of Corning® ClearCurve® XB fiber:

- 33% better bend than G.657. A1 standard
- Capacity robustness: NGPON, WDM PON

**Simplicity Matters.**

- One fiber everywhere to minimize inventory management complexity

**Loss Matters.**

The same industry leading low-loss of Corning® SMF-28e+® LL fiber:

- Capacity robustness: 100G, 400G, Next Gen PON
- Low-cost capacity: less equipment, longer reach
- Enhanced Fixed-Mobile broadband coverage
- Repair resilience

**Four huge benefits.  
One amazing fiber.  
Ultra has arrived.**

CORNING

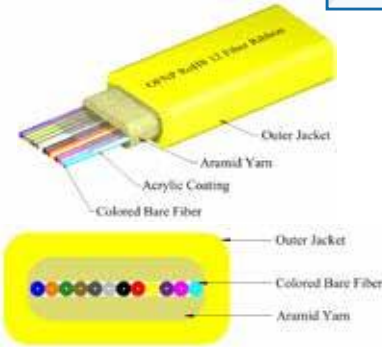

## TLC FLAT RIBBON CABLE PVC JACKETED - OS2 / OM1 / OM2 / OM3 / OM4

PART #	DESCRIPTION	PRICE
S09-RB12-CZNR	12 Fiber Singlemode 9/125µm Riser Jacket Yellow - OS2	\$1.15 /Mtr.
S09-RB12-CZNP	12 Fiber Singlemode 9/125µm Plenum Jacket Yellow - OS2	1.30 /Mtr.
M62-RB12-C3NPO	12 Fiber Multimode 62.5/125µm Plenum Jacket Orange - OM1	2.75 /Mtr.
M50-RB12-C2NPO	12 Fiber Multimode 50/125µm Plenum Jacket Orange - OM2	2.35 /Mtr.
M50-RB12-CGNRA	12 Fiber Multimode 50/125µm Corning® ClearCurve® OM3 Riser Jacket Aqua	3.25 /Mtr.
M50-RB12-CGNPA	12 Fiber Multimode 50/125µm Corning® ClearCurve® OM3 Plenum Jacket Aqua	3.50 /Mtr.
M50-RB12-C4NPA	12 Fiber Multimode 50/125µm Corning® ClearCurve® OM4 Plenum Jacket Aqua	4.65 /Mtr.

## 9/125µm - OS2 SINGLEMODE Corning® SMF-28® Ultra fiber

### SIMPLEX CABLE

PART #	DESCRIPTION	BUFFER SIZE	MFG	PRICE
<b>3.0mm</b>				
S09-SX01-CZNR	Riser Yellow	900µm	TLC	18¢ /Mtr.
S09-SX01-CZNR	Riser Red	900µm	TLC	18¢ /Mtr.
S09-SX01-CZNP	Plenum Yellow	900µm	TLC	25¢ /Mtr.
1E31-311-31	Riser Yellow	900µm	CCS	40¢ /Mtr.
<b>2.0mm</b>				
S09-SX01-CZNR20	Riser Yellow	900µm	TLC	18¢ /Mtr.
S09-SX01-CZNP20	Plenum Yellow	900µm	TLC	20¢ /Mtr.
S09-SX01-CZNRB20	Riser Blue	900µm	TLC	20¢ /Mtr.
<b>1.6mm</b>				
S09-SX01-CZNR16	Riser Yellow	650µm	TLC	18¢ /Mtr.
S09-SX01-CZNP16	Plenum Yellow	650µm	TLC	20¢ /Mtr.

### DUPLEX CABLE

PART #	DESCRIPTION	BUFFER SIZE	MFG	PRICE
<b>3.0mm</b>				
S09-DX02-CZNR	Riser Yellow	900µm	TLC	29¢ /Mtr.
S09-DX02-CZNR	Riser Red	900µm	TLC	29¢ /Mtr.
S09-DX02-CZNP	Plenum Yellow	900µm	TLC	38¢ /Mtr.
2E51-311-31	Riser Yellow	900µm	CCS	65¢ /Mtr.
<b>2.0mm</b>				
S09-DX02-CZNR20	Riser Yellow	900µm	TLC	28¢ /Mtr.
S09-DX02-CZNP20	Plenum Yellow	900µm	TLC	35¢ /Mtr.
S09-DX02-CZNRB20	Riser Blue	900µm	TLC	28¢ /Mtr.
<b>1.6mm</b>				
S09-DX02-CZNR16	Riser Yellow	650µm	TLC	28¢ /Mtr.
S09-DX02-CZNP16	Plenum Yellow	650µm	TLC	35¢ /Mtr.

## 9/125µm - SINGLEMODE ULTRA LOW BEND OPTIMIZED Corning® ClearCurve® ZBL fiber (5mm Radius) G657.B3

### SIMPLEX CABLE

PART #	DESCRIPTION	BUFFER SIZE	MFG	PRICE
<b>3.0mm</b>				
S09-SX01-CCNR	Riser Yellow	900µm	TLC	30¢ /Mtr.
<b>1.6mm</b>				
S09-SX01-CCNR16	Riser Yellow	650µm	TLC	30¢ /Mtr.

### DUPLEX CABLE

PART #	DESCRIPTION	BUFFER SIZE	MFG	PRICE
<b>3.0mm</b>				
S09-DX02-CCNR	Riser Yellow	900µm	TLC	65¢ /Mtr.
<b>1.6mm</b>				
S09-DX02-CCNR16	Riser Yellow	650µm	TLC	65¢ /Mtr.

## 62.5/125µm - OM1 MULTIMODE Corning® ClearCurve® OM1 fiber

### SIMPLEX CABLE

3.0mm PART #	DESCRIPTION	BUFFER SIZE	MFG	PRICE
M62-SX01-C3NR0	Riser Orange	900µm	TLC	28¢ /Mtr.
M62-SX01-C3NPO	Plenum Orange	900µm	TLC	35¢ /Mtr.
1K31-311-41	Riser Orange	900µm	CCS	70¢ /Mtr.
2.0mm				
M62-SX01-C3NR020	Riser Orange	900µm	TLC	25¢ /Mtr.
M62-SX01-C3NPO20	Plenum Orange	900µm	TLC	29¢ /Mtr.
1.6mm				
M62-SX01-C3NR016	Riser Orange	650µm	TLC	25¢ /Mtr.
M62-SX01-C3NPO16	Plenum Orange	650µm	TLC	29¢ /Mtr.

### DUPLEX CABLE

3.0mm PART #	DESCRIPTION	BUFFER SIZE	MFG	PRICE
M62-DX02-C3NR0	Riser Orange	900µm	TLC	55¢ /Mtr.
M62-DX02-C3NPO	Plenum Orange	900µm	TLC	65¢ /Mtr.
2K51-311-41	Riser Orange	900µm	CCS	\$1.10 /Mtr.
2.0mm				
M62-DX02-C3NR020	Riser Orange	900µm	TLC	45¢ /Mtr.
M62-DX02-C3NPO20	Plenum Orange	900µm	TLC	55¢ /Mtr.
1.6mm				
M62-DX02-C3NR016	Riser Orange	650µm	TLC	45¢ /Mtr.
M62-DX02-C3NPO16	Plenum Orange	650µm	TLC	55¢ /Mtr.

## 50/125µm - OM2 MULTIMODE Corning® ClearCurve® OM2 fiber

### SIMPLEX CABLE

3.0mm PART #	DESCRIPTION	BUFFER SIZE	MFG	PRICE
M50-SX01-C2NR0	Riser Orange	900µm	TLC	25¢ /Mtr.
M50-SX01-C2NPO	Plenum Orange	900µm	TLC	29¢ /Mtr.
2.0mm				
M50-SX01-C2NR020	Riser Orange	900µm	TLC	25¢ /Mtr.
M50-SX01-C2NPO20	Plenum Orange	900µm	TLC	29¢ /Mtr.
1.6mm				
M50-SX01-C2NR016	Riser Orange	650µm	TLC	25¢ /Mtr.
M50-SX01-C2NPO16	Plenum Orange	650µm	TLC	29¢ /Mtr.

### DUPLEX CABLE

3.0mm PART #	DESCRIPTION	BUFFER SIZE	MFG	PRICE
M50-DX02-C2NR0	Riser Orange	900µm	TLC	45¢ /Mtr.
M50-DX02-C2NPO	Plenum Orange	900µm	TLC	53¢ /Mtr.
2.0mm				
M50-DX02-C2NR020	Riser Orange	900µm	TLC	45¢ /Mtr.
M50-DX02-C2NPO20	Plenum Orange	900µm	TLC	53¢ /Mtr.
1.6mm				
M50-DX02-C2NR016	Riser Orange	650µm	TLC	45¢ /Mtr.
M50-DX02-C2NPO16	Plenum Orange	650µm	TLC	53¢ /Mtr.

## 50/125µm - OM3 MULTIMODE-10 Gig Corning® ClearCurve® OM3 fiber

### SIMPLEX CABLE

3.0mm PART #	DESCRIPTION	BUFFER SIZE	MFG	PRICE
M50-SX01-CGNRA	Riser Aqua	900µm	TLC	28¢ /Mtr.
M50-SX01-CGNPA	Plenum Aqua	900µm	TLC	35¢ /Mtr.
2.0mm				
M50-SX01-CGNRA20	Riser Aqua	900µm	TLC	28¢ /Mtr.
M50-SX01-CGNPA20	Plenum Aqua	900µm	TLC	35¢ /Mtr.
1.6mm				
M50-SX01-CGNRA16	Riser Aqua	650µm	TLC	28¢ /Mtr.
M50-SX01-CGNPA16	Plenum Aqua	650µm	TLC	35¢ /Mtr.

### DUPLEX CABLE

3.0mm PART #	DESCRIPTION	BUFFER SIZE	MFG	PRICE
M50-DX02-CGNRA	Riser Aqua	900µm	TLC	50¢ /Mtr.
M50-DX02-CGNPA	Plenum Aqua	900µm	TLC	60¢ /Mtr.
2.0mm				
M50-DX02-CGNRA20	Riser Aqua	900µm	TLC	50¢ /Mtr.
M50-DX02-CGNPA20	Plenum Aqua	900µm	TLC	55¢ /Mtr.
1.6mm				
M50-DX02-CGNRA16	Riser Aqua	650µm	TLC	50¢ /Mtr.
M50-DX02-CGNPA16	Plenum Aqua	650µm	TLC	55¢ /Mtr.

## 50/125µm - OM4 MULTIMODE-10 Gig Corning® ClearCurve® OM4 fiber

### SIMPLEX CABLE

3.0mm PART #	DESCRIPTION	BUFFER SIZE	MFG	PRICE
M50-SX01-C4NRA	Riser Aqua	900µm	TLC	40¢ /Mtr.
M50-SX01-C4NPA	Plenum Aqua	900µm	TLC	45¢ /Mtr.
M50-SX01-C4NRM	Riser Magenta	900µm	TLC	40¢ /Mtr.
M50-SX01-C4NPM	Plenum Magenta	900µm	TLC	45¢ /Mtr.
2.0mm				
M50-SX01-C4NRA20	Riser Aqua	900µm	TLC	40¢ /Mtr.
M50-SX01-C4NPA20	Plenum Aqua	900µm	TLC	45¢ /Mtr.
M50-SX01-C4NRM20	Riser Magenta	900µm	TLC	40¢ /Mtr.
M50-SX01-C4NPM20	Plenum Magenta	900µm	TLC	45¢ /Mtr.
1.6mm				
M50-SX01-C4NRA16	Riser Aqua	650µm	TLC	40¢ /Mtr.
M50-SX01-C4NPA16	Plenum Aqua	650µm	TLC	45¢ /Mtr.
M50-SX01-C4NRM16	Riser Magenta	650µm	TLC	40¢ /Mtr.
M50-SX01-C4NPM16	Plenum Magenta	650µm	TLC	45¢ /Mtr.

### DUPLEX CABLE

3.0mm PART #	DESCRIPTION	BUFFER SIZE	MFG	PRICE
M50-DX02-C4NRA	Riser Aqua	900µm	TLC	70¢ /Mtr.
M50-DX02-C4NPA	Plenum Aqua	900µm	TLC	75¢ /Mtr.
M50-DX02-C4NRM	Riser Magenta	900µm	TLC	70¢ /Mtr.
M50-DX02-C4NPM	Plenum Magenta	900µm	TLC	75¢ /Mtr.
2.0mm				
M50-DX02-C4NRA20	Riser Aqua	900µm	TLC	70¢ /Mtr.
M50-DX02-C4NPA20	Plenum Aqua	900µm	TLC	75¢ /Mtr.
M50-DX02-C4NRM20	Riser Magenta	900µm	TLC	70¢ /Mtr.
M50-DX02-C4NPM20	Plenum Magenta	900µm	TLC	75¢ /Mtr.
1.6mm				
M50-DX02-C4NRA16	Riser Aqua	650µm	TLC	70¢ /Mtr.
M50-DX02-C4NPA16	Plenum Aqua	650µm	TLC	75¢ /Mtr.
M50-DX02-C4NRM16	Riser Magenta	650µm	TLC	70¢ /Mtr.
M50-DX02-C4NPM16	Plenum Magenta	650µm	TLC	75¢ /Mtr.

## 50/125µm - OM5 MULTIMODE-40/100 Gig Corning® ClearCurve® OM5 fiber

### SIMPLEX CABLE

2.0mm PART #	DESCRIPTION	BUFFER SIZE	MFG	PRICE
M50-SX01-C5NRLG20	Riser Lime Green	900µm	TLC	55¢ /Mtr.
M50-SX01-C5NPLG20	Plenum Lime Green	900µm	TLC	65¢ /Mtr.
1.6mm				
M50-SX01-C5NRLG16	Riser Lime Green	900µm	TLC	55¢ /Mtr.
M50-SX01-C5NPLG16	Plenum Lime Green	900µm	TLC	65¢ /Mtr.

### DUPLEX CABLE

2.0mm PART #	DESCRIPTION	BUFFER SIZE	MFG	PRICE
M50-DX02-C5NRLG20	Riser Lime Green	900µm	TLC	\$1.05 /Mtr.
M50-DX02-C5NPLG20	Plenum Lime Green	900µm	TLC	\$1.08 /Mtr.
1.6mm				
M50-DX02-C5NRLG16	Riser Lime Green	900µm	TLC	\$1.05 /Mtr.
M50-DX02-C5NPLG16	Plenum Lime Green	900µm	TLC	\$1.08 /Mtr.

**DISTRIBUTION CABLE**

TLC Distribution Cables are designed for general indoor use. Available in all fiber types, a thick durable jacket offers excellent strength and protection during installations and restorations. The 900µm color coded tight buffers allow for easy identification and termination. Cables are available in OFNR and OFNP rated constructions and also a LSZH jacket.

FIBER COUNT	CABLE OD	FIBER COUNT	CABLE OD
2	4.4mm	48	15.4mm
4	4.4mm	72	20mm
6	4.8mm	96	22.9mm
12	5.8mm	144	25.1mm
24	7.8mm		

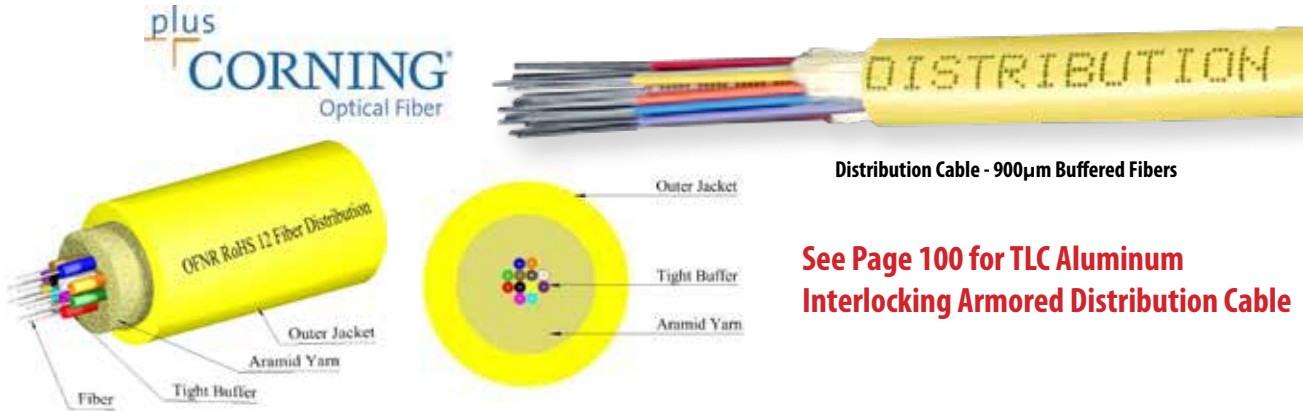

**See Page 100 for TLC Aluminum Interlocking Armored Distribution Cable**

**9/125µm - OS2 SINGLEMODE**  
**Corning® SMF-28® Ultra fiber**

PART #	FIBER COUNT	DESCRIPTION	MFG	PRICE	PART #	FIBER COUNT	DESCRIPTION	MFG	PRICE
S09-DI06-CZNR48	6	Riser Yellow	TLC	60¢ /Mtr.	S09-DI48-CZNR48	48	Riser Yellow	TLC	\$4.00 /Mtr.
S09-DI12-CZNR58	12	Riser Yellow	TLC	\$1.10 /Mtr.	S09-DI48-CZNPY48	48	Plenum Yellow	TLC	5.98 /Mtr.
S09-DI12-CZNPY58	12	Plenum Yellow	TLC	1.20 /Mtr.	S09-DI72-CZNR48	72	Riser Yellow	TLC	6.25 /Mtr.
S09-DI24-CZNR78	24	Riser Yellow	TLC	1.80 /Mtr.	S09D196CZNR48	96	Riser Yellow	TLC	7.50 /Mtr.
S09-DI24-CZNPY78	24	Plenum Yellow	TLC	2.15 /Mtr.	S09D1144CZNR48	144	Riser Yellow	TLC	9.95 /Mtr.

**62.5/125µm OM1 MULTIMODE**  
**InfiniCor® 300 fiber**

PART #	FIBER COUNT	DESCRIPTION	MFG	PRICE	PART #	FIBER COUNT	DESCRIPTION	MFG	PRICE
M62-DI04-C3NR044	4	Riser Orange	TLC	\$1.15 /Mtr.	M62-DI12-C3NR058	12	Riser Orange	TLC	\$2.50 /Mtr.
M62-DI04-C3NP044	4	Plenum Orange	TLC	1.35 /Mtr.	M62-DI12-C3NP058	12	Plenum Orange	TLC	2.80 /Mtr.
M62-DI06-C3NR048	6	Riser Orange	TLC	1.45 /Mtr.	M62-DI24-C3NR078	24	Riser Orange	TLC	5.20 /Mtr.
M62-DI06-C3NP048	6	Plenum Orange	TLC	1.50 /Mtr.	M62-DI24-C3NP078	24	Plenum Orange	TLC	5.45 /Mtr.

**50/125µm - OM3 MULTIMODE - 10 Gig**  
**Corning® ClearCurve® OM3 fiber**

PART #	FIBER COUNT	DESCRIPTION	MFG	PRICE	PART #	FIBER COUNT	DESCRIPTION	MFG	PRICE
M50-DI02-CGNRA44	2	Riser Aqua	TLC	55¢ /Mtr.	M50-DI24-CGNRA78	24	Riser Aqua	TLC	\$4.50 /Mtr.
M50-DI02-CGNPA44	2	Plenum Aqua	TLC	65¢ /Mtr.	M50-DI24-CGNPA78	24	Plenum Aqua	TLC	4.75 /Mtr.
M50-DI04-CGNRA44	4	Riser Aqua	TLC	90¢ /Mtr.	M50-DI48-CGNRA-A	48	Riser Aqua	TLC	10.25 /Mtr.
M50-DI04-CGNPA44	4	Plenum Aqua	TLC	\$1.00 /Mtr.	M50-DI48-CGNPA-A	48	Plenum Aqua	TLC	12.45 /Mtr.
M50-DI06-CGNRA48	6	Riser Aqua	TLC	1.75 /Mtr.	M50-DI72-CGNRA-A	72	Riser Aqua	TLC	13.00 /Mtr.
M50-DI06-CGNPA48	6	Plenum Aqua	TLC	1.85 /Mtr.	M50-DI72-CGNPA-A	72	Plenum Aqua	TLC	16.50 /Mtr.
M50-DI12-CGNRA58	12	Riser Aqua	TLC	2.75 /Mtr.	M50-DI96-CGNRA-A	96	Riser Aqua	TLC	16.50 /Mtr.
M50-DI12-CGNPA58	12	Plenum Aqua	TLC	3.00 /Mtr.	M50-DI144-CGNRA-A	144	Riser Aqua	TLC	23.65 /Mtr.

**50/125µm - OM4 MULTIMODE - 10 Gig**  
**Corning® ClearCurve® OM4 fiber**

PART #	FIBER COUNT	DESCRIPTION	MFG	PRICE	PART #	FIBER COUNT	DESCRIPTION	MFG	PRICE
M50-DI06-C4NRA48	6	Riser Aqua	TLC	\$1.65/Mtr.	M50DI48C4NRA-A	48	Riser Aqua	TLC	\$12.65 /Mtr.
M50-DI06-C4NPA48	6	Plenum Aqua	TLC	1.85/Mtr.	M50DI48C4NPA-A	48	Plenum	TLC	15.35 /Mtr.
M50-DI12-C4NRA58	12	Riser Aqua	TLC	\$3.20/Mtr.	M50DI72C4NRA-A	72	Riser Aqua	TLC	19.60 /Mtr.
M50-DI12-C4NPA58	12	Plenum Aqua	TLC	3.45/Mtr.	M50DI72C4NPA-A	72	Plenum	TLC	22.35 /Mtr.

**50/125µm - OM5 MULTIMODE - 100 Gig**  
**Corning® ClearCurve® OM5 fiber**

PART #	FIBER COUNT	DESCRIPTION	MFG	PRICE	PART #	FIBER COUNT	DESCRIPTION	MFG	PRICE
M50-DI12-C5NPLG-58	12	Plenum Lime Green	TLC	\$6.25/Mtr.	M50-DI24-C5NPLG-78	24	Plenum Lime Green	TLC	\$12.35 /Mtr.

## TLC MICRO-DISTRIBUTION INDOOR CABLE

FIS is proud to offer the TLC line of Micro-Distribution Cables for the Data Center market. These cables are offered in Riser, Plenum or LSZH. They are available in OS2 Singlemode, OM1 62.5µm Multimode, OM2 50µm Multimode, OM3 50µm Multimode, OM4 50µm Multimode and OM5 Multimode. Numbered sub units available with either 6 or 12 fibers per tube. Micro Distribution cables with 3mm subunits available.

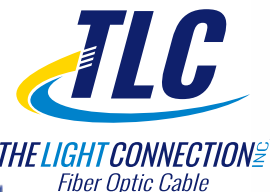

### 9/125µm - OS2 SINGLEMODE

#### Corning® SMF-28® Ultra fiber

PART #	FIBER COUNT	DESCRIPTION	PRICE
S09-MD2-CZNPY20	2	Plenum Yellow	30¢ / Mtr.
S09-MD12-CZNPY20	12	Plenum Yellow	60¢ / Mtr.
*S09-MD24-CZNPY20-Y	24	Plenum Yellow	\$1.75 / Mtr.
*S09-MD48-CZNPY20-Y	48	Plenum Yellow	3.25 / Mtr.
*S09-MD72-CZNPY20-Y	72	Plenum Yellow	4.25 / Mtr.
*S09-MD96-CZNPY20-Y	96	Plenum Yellow	6.00 / Mtr.
*S09-MD144-CZNPY20-Y	144	Plenum Yellow	8.55 / Mtr.

\*Indicates all buffers are colored Yellow

### 50/125µm - OM3 MULTIMODE

#### Corning® ClearCurve® OM3 fiber

PART #	FIBER COUNT	DESCRIPTION	PRICE
M50-MD02-CGNPA20	2	Plenum Aqua	40¢ / Mtr.
M50-MD12-CGNPA20	12	Plenum Aqua	\$1.75 / Mtr.
*M50-MD24-CGNPA20-A	24	Plenum Aqua	4.25 / Mtr.
*M50-MD48-CGNPA20-A	48	Plenum Aqua	7.25 / Mtr.
*M50-MD72-CGNPA20-A	72	Plenum Aqua	10.75 / Mtr.
*M50-MD96-CGNPA20-A	96	Plenum Aqua	15.00 / Mtr.
*M50-MD144-CGNPA20-A	144	Plenum Aqua	21.96 / Mtr.

### 50/125µm - OM4 MULTIMODE

#### Corning® ClearCurve® OM4 fiber

PART #	FIBER COUNT	DESCRIPTION	PRICE
M50-MD02-C4NPA20	4	Plenum Aqua	75¢ / Mtr.
M50-MD12-C4NPA20	12	Plenum Aqua	\$2.95 / Mtr.
*M50-MD24-C4NPA20-A	24	Plenum Aqua	5.95 / Mtr.
*M50-MD48-C4NPA20-A	48	Plenum Aqua	11.45 / Mtr.
*M50-MD72-C4NPA20-A	72	Plenum Aqua	15.90 / Mtr.
*M50-MD96-C4NPA20-A	96	Plenum Aqua	21.25 / Mtr.
*M50-MD144-C4NPA20-A	144	Aqua Plenum	31.25 / Mtr.

\*Indicates all buffers are colored Aqua

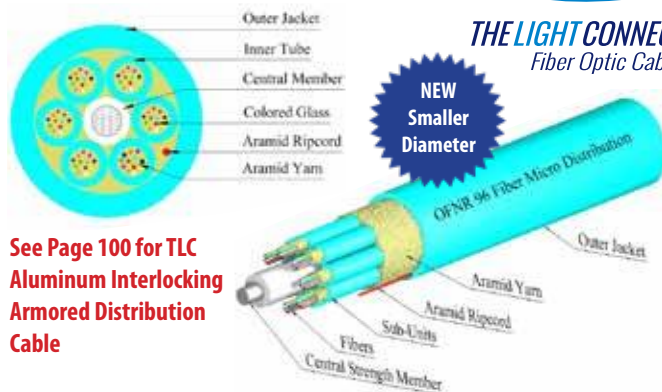

See Page 100 for TLC Aluminum Interlocking Armored Distribution Cable

Micro Distribution Cable - 250µm Fibers

### 50/125µm - OM5 MULTIMODE

#### Corning® ClearCurve® OM5 fiber

PART #	FIBER COUNT	DESCRIPTION	PRICE
M50-MD12-C5NPLG-20	12	Plenum Lime Green	\$6.25 / Mtr.
M50-MD24-C5NPLG-20	24	Plenum Lime Green	12.35 / Mtr.

### MICRO DISTRIBUTION CABLE DIAMETER CHART

FIBER COUNT	CABLE OD	FIBER COUNT	CABLE OD
2	2mm	48	6.6mm
4	2mm	72	8mm
6	2mm	96	9.3mm
12	2mm	144	10.6mm
24	6.3mm		

## INDOOR/OUTDOOR CABLE

FIS offers indoor/outdoor cable in a distribution construction in both Riser and Plenum. These cables are flexible, easy to handle and simple to install. Since they do not use gel, the connectors can be terminated directly onto the 900µm fiber without breakout kits. This provides an easy and overall less expensive installation. **Note: When used in a burial application this cable must be placed in a conduit or innerduct and is not recommended for lashing applications.**

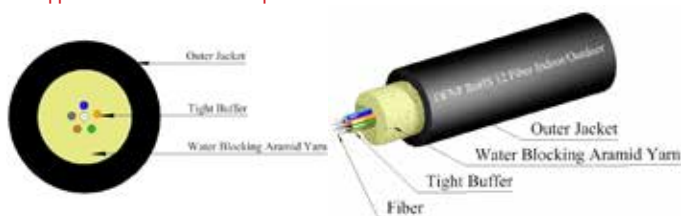

Indoor / Outdoor Cable - 900µm Buffered Fibers

### INDOOR OUTDOOR CABLE DIAMETER CHART

FIBER COUNT	CABLE OD	FIBER COUNT	CABLE OD
2	4.4mm	48	15.4mm
4	4.4mm	72	20mm
6	4.8mm	96	22.9mm
12	5.8mm	144	25.1mm
24	7.8mm		

### MULTIMODE 62.5/125µm InfiniCor® 300 fiber

PART #	FIBER COUNT	DESCRIPTION	PRICE
M62-I006-C3NRBL48	6	Riser MM 62.5/125µm - OM1	\$1.50 / Mtr.
M62-I012-C3NRBL58	12	Riser MM 62.5/125µm - OM1	2.80 / Mtr.
M62-I024-C3NRBL78	24	Riser MM 62.5/125µm - OM1	5.50 / Mtr.
M62-I002-C3NPBL44	2	Plenum MM 62.5/125µm - OM1	80¢ / Mtr.
M62-I004-C3NPBL44	4	Plenum MM 62.5/125µm - OM1	1.35 / Mtr.
M62-I006-C3NPBL48	6	Plenum MM 62.5/125µm - OM1	1.60 / Mtr.
M62-I012-C3NPBL58	12	Plenum MM 62.5/125µm - OM1	3.00 / Mtr.
M62-I024-C3NPBL78	24	Plenum MM 62.5/125µm - OM1	5.95 / Mtr.

### SINGLEMODE 9/125µm Corning® SMF-28® Ultra fiber

PART #	FIBER COUNT	DESCRIPTION	PRICE
S09-I006-CZNRBL48	6	Riser SM 9/125µm - OS2	80¢ / Mtr.
S09-I012-CZNRBL58	12	Riser SM 9/125µm - OS2	\$1.60 / Mtr.
S09-I024-CZNRBL78	24	Riser SM 9/125µm - OS2	2.50 / Mtr.
S09-I006-CZNPBL48	6	Plenum SM 9/125µm - OS2	90¢ / Mtr.
S09-I012-CZNPBL58	12	Plenum SM 9/125µm - OS2	1.75 / Mtr.

### MULTIMODE 50/125µm Corning® ClearCurve® OM3 fiber

PART #	FIBER COUNT	DESCRIPTION	PRICE
M50-I002-CGNRBL44	2	Riser 50/125 10 Gig MM - OM3	70¢ / Mtr.
M50-I004-CGNRBL44	4	Riser 50/125 10 Gig MM - OM3	95¢ / Mtr.
M50-I006-CGNRBL48	6	Riser 50/125 10 Gig MM - OM3	\$1.60 / Mtr.
M50-I012-CGNRBL58	12	Riser 50/125 10 Gig MM - OM3	2.75 / Mtr.
M50-I024-CGNRBL78	24	Riser 50/125 10 Gig MM - OM3	4.75 / Mtr.
M50-I006-CGNPBL48	6	Plenum 50/125 10 Gig MM - OM3	1.80 / Mtr.
M50-I012-CGNPBL58	12	Plenum 50/125 10 Gig MM - OM3	3.25 / Mtr.
M50-I024-CGNPBL78	24	Plenum 50/125 10 Gig MM - OM3	5.75 / Mtr.

### MULTIMODE 50/125µm Corning® ClearCurve® OM4 fiber

PART #	FIBER COUNT	DESCRIPTION	PRICE
M50-I006-C4NRBL48	6	Riser 50/125 10 Gig MM - OM4	\$1.80 / Mtr.
M50-I006-C4NPBL48	6	Plenum 50/125 10 Gig MM - OM4	2.25 / Mtr.
M50-I012-C4NRBL58	12	Riser 50/125 10 Gig MM - OM4	3.50 / Mtr.
M50-I012-C4NPBL58	12	Plenum 50/125 10 Gig MM - OM4	3.75 / Mtr.
M50-I024-C4NRBL78	24	Riser 50/125 10 Gig MM - OM4	6.40 / Mtr.
M50-I024-C4NPBL78	24	Plenum 50/125 10 Gig MM - OM4	7.25 / Mtr.

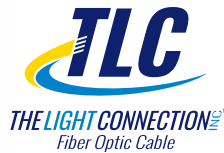

**NEW**  
Smaller  
Diameter



900µm Buffered Fibers

Refer to page 77 for the  
AIA Grounding Kit

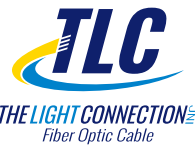

900µm Buffered Fibers



250µm Fibers



250µm Fibers

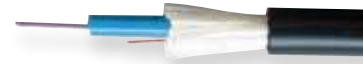

250µm Fibers



900µm Buffered Fibers

## TLC ALUMINUM INTERLOCKING ARMORED DISTRIBUTION CABLE

TLC Tight Buffered Aluminum Interlocking Armored cable consists of PVC outer jacket, PVC inner jacket with 2 to 96 tight buffered fibers surrounded by aramid yarn acting as a strength member. The core is protected by a spirally wrapped aluminum strip that offers easy installation and high crush resistance. These cables are available in OFCP rated constructions.

PART #	FIBER COUNT	DESCRIPTION	CABLE DIA.	PRICE
S09-DI06-CZNPY48-AIA2	6	SM Plenum 9/125µm - Yellow - OS2	13mm	\$2.95 /Mtr.
S09-DI12-CZNPY58-AIA2	12	SM Plenum 9/125µm - Yellow - OS2	14.7mm	3.95 /Mtr.
S09-DI24-CZNPY78-AIA2	24	SM Plenum 9/125µm - Yellow - OS2	16.2mm	6.25 /Mtr.
S09-DI48-CZNPY-AIA	48	SM Plenum 9/125µm - Yellow - OS2	23.50mm	13.50 /Mtr.
M62-DI06-C3NPO48-AIA2	6	MM Plenum 62.5/125µm - Orange - OM1	13mm	3.75 /Mtr.
M62-DI12-C3NPO58-AIA2	12	MM Plenum 62.5/125µm - Orange - OM1	14.7mm	5.25 /Mtr.
M50-DI06-CGNPA48-AIA2	6	MM Plenum 50/125µm Aqua - OM3	13mm	3.75 /Mtr.
M50-DI12-CGNPA58-AIA2	12	MM Plenum 50/125µm Aqua - OM3	14.7mm	5.50 /Mtr.
M50-DI24-CGNPA78-AIA2	24	MM Plenum 50/125µm Aqua - OM3	16.2mm	7.50 /Mtr.
M50-DI06-C4NPA48-AIA2	6	MM Plenum 50/125µm Aqua - OM4	13mm	4.50 /Mtr.
M50-DI12-C4NPA58-AIA2	12	MM Plenum 50/125µm Aqua - OM4	14.7mm	6.25 /Mtr.
M50-DI24-C4NPA78-AIA2	24	MM Plenum 50/125µm Aqua - OM4	16.2mm	9.25 /Mtr.

## TLC ALUMINUM INTERLOCKING ARMORED INDOOR/OUTDOOR CABLE

PART #	FIBER COUNT	DESCRIPTION	CABLE DIA.	PRICE
S09-I006-CZNPBL48-AIA2	6	SM Plenum 9/125µm Armored - OS2	13.0mm	\$3.25 / Mtr.
S09-I012-CZNPBL58-AIA2	12	SM Plenum 9/125µm Armored - OS2	14.7mm	3.65 / Mtr.
S09-I012-CZNRBL58-AIA2	12	SM Riser 9/125µm Armored - OS2	14.7mm	3.25 / Mtr.
M62-I006-C3NPBL48-AIA2	6	MM Plenum 62.5/125µm Armored - OM1	13.0mm	3.98 / Mtr.
M62-I012-C3NPBL58-AIA2	12	MM Plenum 62.5/125µm Armored - OM1	14.7mm	4.98 / Mtr.
M50-I006-CGNPBL48-AIA2	6	MM Plenum 50/125µm 10 Gig Armored - OM3	13.0mm	3.95 / Mtr.
M50-I012-CGNPBL58-AIA2	12	MM Plenum 50/125µm 10 Gig Armored - OM3	14.7mm	4.95 / Mtr.
M50-I024-CGNPBL78-AIA2	24	MM Plenum 50/125µm 10 Gig Armored - OM3	16.2mm	6.95 / Mtr.

## TLC ALUMINUM INTERLOCKING ARMORED MICRO DISTRIBUTION CABLE

PART #	FIBER COUNT	DESCRIPTION	CABLE DIA.	PRICE
S09-MD12-CZNPY-AIA2	12	SM Plenum Yellow Armored - OS2	14.7mm	\$2.50 / Mtr.
M50-MD12-CGNPA-AIA2	12	MM Plenum Aqua Armored - OM3	14.7mm	4.00 / Mtr.
M50-MD24-CGNPA-AIA2	24	MM Plenum Aqua Armored - OM3	16.2mm	7.65 / Mtr.
M50-MD48-CGNPA4TA-AIA	48	MM Plenum Aqua Armored - OM3	17.45mm	11.50 / Mtr.
M50-MD12-C4NPA-AIA2	12	MM Plenum Aqua Armored - OM4	14.7mm	5.25 / Mtr.
M50-MD24-C4NPA2TA-AIA2	24	MM Plenum Aqua Armored - OM4	16.2mm	10.35 / Mtr.
M50-MD48-C4NPA4TA-AIA2	48	MM Plenum Aqua Armored - OM4	17.45mm	14.35 / Mtr.

## BELDEN ARMORED CENTRAL LOOSE TUBE OSP CABLE

Belden Armored Central Tube OSP cable offers rodent protection and direct burial for outdoor applications. Cable features: surrounded by gel for moisture resistance, corrugated steel tape and a polyethylene jacket for weather and UV protection.

PART #	FIBER COUNT	DESCRIPTION	CABLE DIA.	PRICE
FSSC00660	6	SM 9/125µm - OS2	13.5mm	\$2.50 /Mtr.
FSSC01260	12	SM 9/125µm - OS2	13.5mm	2.75 /Mtr.
FS1C00660	6	MM 62.5/125µm - OM1	13.5mm	5.25 /Mtr.
FS1C01260	12	MM 62.5/125µm - OM1	13.5mm	6.10 /Mtr.
FS3C00660	6	MM 50/125µm - OM3	13.5mm	4.45 /Mtr.
FS3C01260	12	MM 50/125µm - OM3	13.5mm	5.25 /Mtr.

## BELDEN CENTRAL LOOSE TUBE OSP CABLE

Belden Central Loose Tube OSP cable features the long-term, field-proven reliability of conventional polyethylene outdoor unitized construction surrounded by gel for moisture resistance. Recommended applications include building interconnections and data trunk, long haul networking and applications requiring good ozone, moisture and weather resistance. Other fiber counts and types available.

PART #	FIBER COUNT	DESCRIPTION	CABLE DIA.	PRICE
FSSC006N0	6	SM 9/125µm - OS2	8.26mm	\$1.65 /Mtr.
FSSC012N0	12	SM 9/125µm - OS2	8.26mm	6.10 /Mtr.
FS1C006N0	6	MM 62.5/125µm - OM1	8.26mm	4.25 /Mtr.
FS1C012N0	12	MM 62.5/125µm - OM1	8.26mm	5.15 /Mtr.
FS3C006N0	6	MM 50/125µm - OM3	8.26mm	4.05 /Mtr.
FS3C012N0	12	MM 50/125µm - OM3	9.65mm	4.90 /Mtr.

## AERIAL CABLE/SELF-SUPPORTING

Aerial cable provides ease of installation and reduces time and cost. Figure 8 cable can easily be separated between the fiber and the messenger. Temperature range -55°C to +85°C. Additional configurations available.

PART #	FIBER COUNT	DESCRIPTION	CABLE DIA.	PRICE
AR04TB	4	MM 62.5/125µm - OM1	5.0mm	\$5.45 /Mtr.
AR06TB	6	MM 62.5/125µm - OM1	6.0mm	5.65 /Mtr.

## FIS FLAT DROP CABLE

FIS offers the flat stranded single tube drop cable for Fiber To The Home applications. This durable design incorporates two dielectric rigid rods for optimal tensile strength and crush protection.

PART #	FIBER COUNT	DESCRIPTION	PRICE
S09FD02CZEBL	2	Fiber SM SMF28 Ultra Dry Flat Drop Cable PE Black	55¢ /Mtr.
S09FD02CZEBLG	2	Fiber SM SMF28 Ultra Gel Flat Drop Cable PE Black	55¢ /Mtr.
S09FD02CZEBLG24G	2	Fiber SM SMF28 Ultra Gel Flat Drop Toneable (24 AWG) Cable	60¢ /Mtr.
S09FD02CZEBL	2	900um Buffer SM SMF28 Ultra Dry Flat Drop PE Black	60¢ /Mtr.
S09FD02CZEBLG24AWG	2	900um Buffer SM SMF28 Ultra Dry Flat Drop Toneable 24 AWG	60¢ /Mtr.
S09FD04CZEBL	4	Fiber SM SMF28 Ultra Dry Flat Drop Cable PE Black	60¢ /Mtr.
S09FD06CZEBL	6	Fiber SM SMF28 Ultra Dry Flat Drop Cable PE Black	65¢ /Mtr.
S09FD12CZEBL	12	Fiber SM SMF28 Ultra Dry Flat Drop Cable PE Black	80¢ /Mtr.
S09FD12CZEBLT	12	Fiber SM Drop Cable Dry Toneable (24 AWG) PE Black	80¢ /Mtr.

## CORNING® CABLE SYSTEMS DROP CABLES

SST-Drop™ Cables offer the ease of installation of standard ALTOS® cable in an easy-access stranded single-tube (SST) design. Intended for FTTH networks, bridging the space between distribution network and subscriber premise.

PART #	FIBER COUNT	DESCRIPTION	PRICE
001-EB4-14101A20	1	SM 9/125µm SST Drop™ Cable - OS2	65¢ /Mtr.
002-EB4-14101A20	2	SM 9/125µm SST Drop™ Cable - OS2	80¢ /Mtr.
012-EB4-14101A20	12	SM 9/125µm SST Drop™ Cable - OS2	\$1.00 /Mtr.

## TLC GEL FREE INDOOR/OUTDOOR CABLE

This cable has no gel fill to complicate the connectorization process. Instead, water swellable yarn replaces the gel. Each tube contains colored bare fibers, making your installation simple and fast. Fiber counts 2-12 are in one subunit and larger counts are in subunits of 12.

PART #	FIBER COUNT	DESCRIPTION	PRICE
S09-DL06-CZNRBL25	6	SM 9/125µm Riser PVC Black - OS2	70¢ /Mtr.
S09-DL12-CZNRBL25	12	SM 9/125µm Riser PVC Black - OS2	90¢ /Mtr.
S09-DL24-CZNRBL25	24	SM 9/125µm Riser PVC Black - OS2	\$1.85 /Mtr.
S09-DL48-CZNRBL25	48	SM 9/125µm Riser PVC Black - OS2	2.30 /Mtr.
S09-DL72-CZNRBL25	72	SM 9/125µm Riser PVC Black - OS2	3.55 /Mtr.
S09-DL96-CZNRBL25	96	SM 9/125µm Riser PVC Black - OS2	4.25 /Mtr.
S09-DL144-CZNRBL25	144	SM 9/125µm Riser PVC Black - OS2	5.70 /Mtr.
M50-DL06-CGNRBL25	6	MM 50/125µm Riser PVC Black - OM3	1.65 /Mtr.
M50-DL12-CGNRBL25	12	MM 50/125µm Riser PVC Black - OM3	2.45 /Mtr.
M50-DL12-C4NRBL25	12	MM 50/125µm Riser PVC Black - OM4	3.50 /Mtr.
M50-DL24-C4NPBL25	24	MM 50/125µm Plenum PVC Black - OM4	6.30 /Mtr.

## FIS MINI ARMORED CABLE

Mini Armored Cable is compact for use in data centers, broadcast or distributed antenna systems (DAS) where crowded cable tray or exposed environment is additional protected with strength spiraled armoring surrounding internal jacketed cable. Double protection much improved flexibility over traditional interlocking armored fiber cable. With outer diameter of 7.5mm it is available with Low Smoke Zero Halogen (LSZH) jacket for indoor applications or Polyurethane (PU) jacket for outdoor or rugged areas.

PART #	FIBER COUNT	DESCRIPTION	PRICE
S09-MA-06-SM-PUBL75	6	Mini Armored Fiber Cable, Singlemode G657A2, Polyurethane Jacketed, color black 7.5mm OD	\$1.65 /Mtr.
S09-MA-12-SM-PUBL75	12	Mini Armored Fiber Cable, Singlemode G657A2, Polyurethane Jacketed, color black 7.5mm OD	2.00 /Mtr.
S09-MA-06-SM-LZBL75	6	Mini Armored Fiber Cable, Singlemode G657A2, LSZH Jacketed, color black 7.5mm OD	1.10 /Mtr.
S09-MA-12-SM-PUBL75	12	Mini Armored Fiber Cable, Singlemode G657A2, LSZH Jacketed, color black 7.5mm OD	1.49 /Mtr.
M50-MA-06-OM3-LZBL75	6	Mini Armored Fiber Cable, Multimode 50/125um OM3, LSZH Jacketed, color black 7.5mm OD	1.90 /Mtr.
M50-MA-12-OM3-LZBL75	12	Mini Armored Fiber Cable, Multimode 50/125um OM3, LSZH Jacketed, color black 7.5mm OD	2.90 /Mtr.

## FIS BLUE TACTICAL CABLE

FIS Blue fiber optic tactical cable consists of a rugged, flexible polyurethane outer jacket and up to twelve 900µm tight-buffered fibers surrounded by aramid yarn and an aramid ripcord. The jacket is pressure extruded over the strength member which allows the pulling device to be attached directly to the cable's outer jacket. This will transfer the pulling force directly to the strength members with no slippage.

PART #	FIBER COUNT	DESCRIPTION	PRICE
FB-SM6-TACCABLE	6	SM 9/125µm Tactical Cable - OS2	\$1.80 /Mtr.
FB-SM-TACCABLE-12	12	SM 9/125µm Tactical Cable - OS2	2.85 /Mtr.
FB-50-TACCABLE-6	6	MM 50/125µm Tactical Cable - OM3	3.94 /Mtr.
FB-50-TACCABLE-12	12	MM 50/125µm Tactical Cable - OM3	7.55 /Mtr.

## AFL MINI-SPAN® ADSS CABLE

AFL Mini-Span® All-Dielectric Self-Supporting (ADSS) cable is designed for outside plant aerial and duct applications in local and campus network loop architectures. A separate messenger support wire hanging system is not required. Mini-Span® single-mode and laser-optimized multimode fibers are available. (Minimum order quantities may be required)

PART #	FIBER COUNT	DESCRIPTION	PRICE
AE0129C520AA4	12	SM Mini-Span® 424 - OS2	\$2.10 /Mtr.
AE0249C520AA4	24	SM Mini-Span® 424 - OS2	2.20 /Mtr.
AE0489C520AA4	48	SM Mini-Span® 424 - OS2	2.95 /Mtr.
AE0729C820EA7	72	SM Mini-Span® 535 - OS2	4.55 /Mtr.



S09FD02CZEBLG

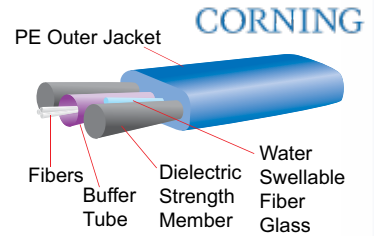

THE LIGHT CONNECTION™  
Fiber Optic Cable



Fan Out Kits on page 103



Mini Armored Cable



900µm Buffered Fibers



FIS now offers OPGW cable from AFL.  
Ask your sales associate for details.

# CABLE | FURCATION TUBE

The TLC 2mm, 3mm, 3.8mm, and 4.8mm furcation tubing consists of an inner tube surrounded by aramid yarn and an overall PVC jacket. Twelve standard colors are available. Inner tubes are available in specific sizes to accept either bare or buffered fibers.

TLC's 900 micron furcation tubing is a single tube designed specifically for the protection and termination of 250µm bare fiber. Twelve standard colors in Hytrel® as well as clear PVC are available.

## 900µm FURCATION TUBE

PART #	DESCRIPTION	PRICE
F00-FR900R-CLEAR	Clear (PVC) (Accepts 250µm Bare Fiber)	50¢ /Mtr.
F00-FR900-HN	Opaque (Accepts 250µm Bare Fiber)	50¢ /Mtr.
F00-FR900-HW	White (Accepts 250µm Bare Fiber)	50¢ /Mtr.
F00-FR900-HY	Yellow (Accepts 250µm Bare Fiber)	50¢ /Mtr.
F00-FR900-HO	Orange (Accepts 250µm Bare Fiber)	50¢ /Mtr.
F00-FR900-HA	Aqua (Accepts 250µm Bare Fiber)	50¢ /Mtr.

## 2.0mm FURCATION TUBE

Our 2.0mm furcation tubing has an inner tube surrounded by aramid fibers. The inner tube accepts 250µm bare fiber and 900µm tight buffered (1.5mm OD inner tube for 900µm) fiber. Other colors available.

PART #	DESCRIPTION	PRICE
F00-FR2NUO-900	Orange (Accepts 250µm Bare Fiber)	50¢ /Mtr.
F00-FR2NUY-900	Yellow (Accepts 250µm Bare Fiber)	50¢ /Mtr.
F00-FR2NUA-900	Aqua (Accepts 250µm Bare Fiber)	50¢ /Mtr.
F00-FR2-NUO	Orange (Accepts 900µm Tight Buffer)	50¢ /Mtr.
F00-FR2-NUY	Yellow (Accepts 900µm Tight Buffer)	50¢ /Mtr.
F00-FR2-NUR	Red (Accepts 900µm Tight Buffer)	50¢ /Mtr.
F00-FR2-NUB	Blue (Accepts 900µm Tight Buffer)	50¢ /Mtr.
F00-FR2-NUG	Green (Accepts 900µm Tight Buffer)	50¢ /Mtr.
F00-FR2-NUA	Aqua (Accepts 900µm Tight Buffer)	50¢ /Mtr.

## 3.0mm FURCATION TUBE

Our 3.0mm furcation tube that accepts 900µm has an inner tube with a Pull String. The 900µm inner hollow tube, the same tube found in FIS Universal Breakout Kits, may now be purchased separately. Includes aramid yarn strength member. Other colors available. (PS) Indicates Pull String.

PART #	DESCRIPTION	PRICE
F00-FR3NUO-900	Orange (Accepts 250µm Bare Fiber)	50¢ /Mtr.
F00-FR3NUY-900	Yellow (Accepts 250µm Bare Fiber)	50¢ /Mtr.
F00-FR3NUA-900	Aqua (Accepts 250µm Bare Fiber)	50¢ /Mtr.
F00-FR3-NUO (PS)	Orange (Accepts 900µm Tight Buffer)	50¢ /Mtr.
F00-FR3-NUY (PS)	Yellow (Accepts 900µm Tight Buffer)	50¢ /Mtr.
F00-FR3-NUR (PS)	Red (Accepts 900µm Tight Buffer)	50¢ /Mtr.
F00-FR3-NUB (PS)	Blue (Accepts 900µm Tight Buffer)	50¢ /Mtr.
F00-FR3-NUG (PS)	Green (Accepts 900µm Tight Buffer)	50¢ /Mtr.
F00-FR3-NUA (PS)	Aqua (Accepts 900µm Tight Buffer)	50¢ /Mtr.

## DUPLEX FURCATION TUBE

TLC 2.0mm and 3.0mm duplex furcation tubing consists of an inner tube surrounded by aramid fibers, and a PVC jacket sized for the industry standard connectors. The duplex design allows for professional termination of connector pairs. (PS) Indicates Pull String.

### 2.0mm

PART #	DESCRIPTION	PRICE
F00-FDX2-NUO	Orange (Accepts 250µm Bare Fiber)	75¢ /Mtr.
F00-FDX2-NUY	Yellow (Accepts 250µm Bare Fiber)	75¢ /Mtr.
F00-FDX2-NUA	Aqua (Accepts 250µm Bare Fiber)	75¢ /Mtr.

### 3.0mm

F00-FDX3-NUO (PS)	Orange (Accepts 900µm Tight Buffer)	75¢ /Mtr.
F00-FDX3-NUY (PS)	Yellow (Accepts 900µm Tight Buffer)	75¢ /Mtr.
F00-FDX3-NUG (PS)	Green (Accepts 900µm Tight Buffer)	75¢ /Mtr.
F00-FDX3-NUA (PS)	Aqua (Accepts 900µm Tight Buffer)	75¢ /Mtr.

## RIBBON FURCATION TUBE

FIS offers ribbon furcation tubing for protection of bare ribbon fibers. Standard size fits fiber counts of 4, 6, 8 and 12 fibers. There is no inner tube or strength member.

PART #	DESCRIPTION	PRICE
F00-FRRB-NRO	Orange	75¢ /Mtr.
F00-FRRB-NRY	Yellow	75¢ /Mtr.
F00-FRRB-NRA	Aqua	75¢ /Mtr.



## FEATURES

- Accepts either bare fiber or tight buffer
- Provides durable protection when breaking out cables
- Newly engineered inner tube protects against crushing and kinking
- Designed for all connector types
- 12 standard colors
- Also available with pull string for 2mm and 3mm furcation tubing

## APPLICATIONS

- Building up or breaking out of cables for termination
- Protection of bare fiber or tight buffer
- Color coded for easy identification



Spiral Wrap

## SPIRAL WRAP

PART #	DESCRIPTION	PRICE
HT316N	Nylon Spiral Cut Tubing 3/16"	\$1.49/mtr



F1-9795-3

## ROsin BAG

FIS technicians utilize rosin bags to ease the application of furcation tubing and help remove flooding gels while stripping. The rosin bags are used to dry wet surfaces making furcation quicker and easier.

PART #	DESCRIPTION	PRICE
F1-9795-3	Rosin Bags 3/pack	\$7.95



**FIS COLOR CODED BUFFER TUBE/RIBBON FAN-OUT KITS**

FIS Fan-Out Kits are designed for a simple and easy breakout from standard Buffer Tubes or Ribbon Cables. The kits are pre-configured for 4, 6 and 12 fiber applications with 25" and 36" lengths of 900µm Hytel tubing in the appropriate industry-standard color code. FIS Fan-Out Kits have a unique snap-together design that offers the ability to unsnap the unit for reentry if necessary. Each kit comes with the adapters that accommodate round cable configurations, such as Buffer Tubes, and Ribbon Cables. This cost-saving feature allows you to cover your application possibilities with just one style.

PART #	DESCRIPTION	PRICE
F1-BF0425M	4 Fiber (25" Tubing) Accepts 250µm	\$10.55
F1-BF0625M	6 Fiber (25" Tubing) Accepts 250µm	12.85
F1-BF1225M	12 Fiber (25" Tubing) Accepts 250µm	19.50
F1-BF0436M	4 Fiber (36" Tubing) Accepts 250µm	10.90
F1-BF0636M	6 Fiber (36" Tubing) Accepts 250µm	14.25
F1-BF1236M	12 Fiber (36" Tubing) Accepts 250µm	22.50



**FIS COLOR CODED BREAKOUT KITS (Custom Colors Available.)**

The FIS 2mm and 3mm Breakout Kits are designed for the quick and simple termination of distribution cables. Color coded tubing eliminates the need for marking individual fiber ends, as your cable will be color coded to TIA/EIA standards.

PART #	DESCRIPTION	PRICE
F1-BOK0640-20M	2mm, 6 Fiber (40" Tubing) Accepts 900µm	\$20.75
F1-BOK1240-20M	2mm, 12 Fiber (40" Tubing) Accepts 900µm	35.30
F1-BOK0640MA	2mm, 6 Fiber (40" Tubing) Accepts 900µm - Aqua (numbered instead of color coded)	17.50
F1-BOK1240MA	2mm, 12 Fiber (40" Tubing) Accepts 900µm - Aqua (numbered instead of color coded)	28.50
F1-BOK0640M	3mm, 6 Fiber (40" Tubing) Accepts 900µm	27.00
F1-BOK1240M	3mm, 12 Fiber (40" Tubing) Accepts 900µm	31.50
F1-BOK0640M250	3mm, 6 Fiber Colored Coded, Accepts 250µm	27.00
F1-BOK1240M250	3mm 12 Fiber Colored Coded, Accepts 250µm	31.50



**FIS COLOR CODED BUFFER TUBE/RIBBON FAN-OUT KITS (24 Fiber)**

FIS Fan-Out Kits are designed for a simple and easy breakout from standard Buffer Tubes or Ribbon Cables. The kits are pre-configured for 24 fiber applications with 25" and 36" lengths of 900µm Hytel tubing in the appropriate industry standard color code. (4 Fiber, 6 Fiber and 12 Fiber Kits are also available) FIS Fan-Out Kits have a unique snap together design that offers the ability to unsnap the unit for re-entry if necessary. Each kit comes with the adapters that accommodate round cable configurations, such as Buffer Tubes, and Ribbon Cables. This cost saving feature allows you to cover your application possibilities with just one style breakout kit.

PART #	DESCRIPTION	PRICE
F1-BF2425M	24 Fiber (25" Tubing) Accepts 250µm	\$18.95
F1-BF2436M	24 Fiber (36" Tubing) Accepts 250µm	22.25



**CORNING® BUFFER TUBE FAN-OUT KITS**

Ideal for indoor or outdoor crossconnects, these kits provide the most compact, easy-to install fan-out solution. The compact design requires no additional hardware. The 900µm fan-out assembly is color coded to match the fiber color scheme and is available in 6- or 12-fiber units in lengths of 25, 36 or 47 inches.

PART #	DESCRIPTION	PRICE
FAN-BT25-06	6 Fiber (25" Tubing)	\$16.95
FAN-BT36-06	6 Fiber (36" Tubing)	16.95
FAN-BT25-12	12 Fiber (25" Tubing)	16.95
FAN-BT36-12	12 Fiber (36" Tubing)	18.50



**CORNING® SPIDER FAN-OUT KITS**

Corning® Spider Fan-Out Kits are designed for both factory and field terminations of distribution or loose tube cables from 4 to 24 fibers. The fan-out tubing provides three layers of protection consisting of a Teflon inner tube, a dielectric strength member and an outer protective PVC jacket.

PART #	DESCRIPTION	PRICE
SFK-P06-250M	6 Fiber accepts 250µm (Orange)	\$40.95
SFK-P12-250M	12 Fiber accepts 250µm (Orange)	57.95
SFK-P24-250M	24 Fiber accepts 250µm (Orange)	96.25
SFK-P06-250S	6 Fiber accepts 250µm (Yellow)	40.95
SFK-P12-250S	12 Fiber accepts 250µm (Yellow)	57.95
SFK-P24-250S	24 Fiber accepts 250µm (Yellow)	90.50
SFK-P06-900M	6 Fiber accepts 900µm (Orange)	40.00
SFK-P06-900S	6 Fiber accepts 900µm (Yellow)	40.95



**CORNING® RIBBON FAN-OUT KITS**

Corning® Cable Systems' Ribbon Fan-Out Kits are specifically designed for the termination of 12-fiber ribbon. Kits feature a 900µm fan-out assembly that is color-coded to match the industry-standard color code.

PART #	DESCRIPTION	PRICE
RIB-FAN-1225	12 Ribbon Fiber (25" Tubing)	\$17.95
RIB-FAN-1236	12 Ribbon Fiber Fan-Out kit (36" Tubing)	19.95



**FIS LOOSE BUFFER SPLICE CLIP**

The Loose Buffer Splice Clip is a simple and easy way to get consistent splices when trying to fusion splice loose buffer fiber. This small clip prevents the fiber from pistoning while attempting a fusion slice.

PART #	DESCRIPTION	PRICE
SPLICECLIP	FIS Loose Buffer Splice Clip (Package of 8)	\$15.50



# CONSUMABLES



F1-1007S

### CANNED AIR

Before removing a fiber optic connector for inspection or cleaning, make sure the area around the connector is free from dust. The FIS Micro Duster includes an extension nozzle to provide a powerful blast of air to remove particles from areas that are otherwise inaccessible. Competitively priced. **Shipping restrictions and fees may apply.**

PART #	DESCRIPTION	PRICE
F1-1007S	FIS Canned Air (10oz.)	\$9.95



F1-8328C



F1-8327

F1-8326

### FIBER OPTIC DISPOSAL UNIT

A handy and safe solution for disposing of cleaved fiber ends. Perfect for on-site installers. Choose from three sizes to accommodate any tool kit and splice/connector station. The large unit has a snap on hinge cover, while the standard and mini containers have traditional slide tops for easy opening and closing.

PART #	DESCRIPTION	PRICE
F1-8328C	Large Fiber Optic Disposal Unit with Snap Top (3 1/2" W x 5 1/2" H)	\$5.95
F1-8327	Standard Fiber Optic Disposal Unit with Slide Top (1 7/8" W x 4 3/8" H)	3.95
F1-8326	Mini Fiber Optic Disposal Unit with Slide Top (1 5/8" W x 1 1/2" H)	2.95



F1-007PL



F1-007P

### FIS DISPENSING BOTTLE

PART #	DESCRIPTION	PRICE
F1-007PL	8 oz. Automatic Alcohol Dispensing Bottle (Plastic)	\$6.75
F1-007P	8 oz. Automatic Alcohol Dispensing Bottle (Amber Glass)	7.55



F1-8265

### PIANO WIRE

A smart way to save a connector when a fiber breaks inside a ferrule during connectorization. Also an excellent tool to remove broken fiber from bare fiber adapters. Sticky colored tabs provided to hold wire.

PART #	DESCRIPTION	PRICE
F1-8265	FIS Piano Wire (8 wires /10 dots)	\$4.95



F1-0001V

### MATCHING GEL (OPTICAL COUPLANT)

To reduce optical loss within fiber optic mechanical splices and connectors, apply optical couplant at the interface of the two mated fibers. This minimizes loss by reducing the difference in the index of refraction between the mated fibers.

PART #	DESCRIPTION	PRICE
F1-0001V	FIS Matching Gel (.4oz)	\$25.95



9006

### OPTICAL COUPLANT LIQUID

To reduce optical loss within fiber optic mechanical splices and connectors, apply optical couplant at the interface of the two mated fibers. This minimizes loss by reducing the difference in the index of refraction between the mated fibers. Available as liquid.

PART #	DESCRIPTION	PRICE
9006	Liquid Matching Couplant (.2 oz., Syringe)	\$16.25



QBE



PQBE

### CHEMTRONICS QBE® SERIES

QbE® Cleaning Platforms offer a more complete removal of microscopic contaminants, without the chance of damage to the optical fiber end face. Self-contained cleaning tools that can be used dry or wet, they are convenient and economical for use in field or OEM applications.

PART #	DESCRIPTION	PRICE
QBE	QBE® Lint Free Cleaning Wipes, 200 Perforated Wipes 2.75" x 3"	\$40.00
PQBE	Pocket QBE® Lint Free Cleaning Wipes, 200 Perforated Wipes 1.375" x 3"	54.95
QBE-R	QBE® Lint Free Cleaning Wipes for APC & MTP Recessed Connectors 200 Wipes 2.75" x 3"	55.75



WCS800



WCS100

### STICKLERS CLEANING WIPES AND BOX

Perfectly packaged for factories making jumpers and patch cords, this tool is designed for high-speed, high-volume production. Featuring a high-modulus fabric that will not lint, tear, or shred and allows for 3,200+ cleanings per roll for the large box and 600+ cleanings per roll for the small box.

PART #	DESCRIPTION	PRICE
WCS800	Sticklers Large Cleaning Box (3,200+ Cleanings)	\$38.25
WCS100	Sticklers Small Cleaning Box (600+ Cleanings)	15.95
WFW	CleanWipes™ (90 wipes)	10.50



WFW

**FIS FIBER OPTIC 4"x4" NON-WOVEN WIPES**

Non-Woven cloth wipes can be used alone or with alcohol or solvents. Provides superior cleaning of fiber optic connector ferrules without risk of scratching or lint residue.

PART #	DESCRIPTION	PRICE
F1-6702	Non-Woven Dry Wipes, 100 per pack, 4" x 4"	\$3.75
F1-6704	Non-Woven Dry Wipes, 1,200 per pack, 4" x 4"	29.95



F1-6702

**KIMWIPES**

Kim Wipes are the standard for use alone or with alcohol or solvents. Kim Wipes provide superior cleaning of fiber optic connector ferrules without risk of scratching. 280 wipes per box.

PART #	DESCRIPTION	PRICE 1-25	PRICE 25+
34-155	Individual box (4.4" x 8.4")	\$2.95	\$2.80
34-155C	Case (60 per case)	175.00	166.00
34-256C	Large Sheet Kim Wipes - 15 Boxes per case (14.7" x 16.6")	215.00	204.25



34-155

**ISOPROPYL ALCOHOL PRODUCTS**

This 99% ACS reagent grade isopropyl is used in cleaning fiber, connector end faces or prior to splicing. Also offered are dispensing bottles available in glass or plastic. Ground shipping only. Hazmat fees may apply.

PART #	DESCRIPTION	PRICE
F1-0068	1 Case of (6) 4 oz. Canned Alcohol	\$35.70
F1-0007SP	4 oz. Alcohol Bottle with Spray Top	3.95
F1-0007	1 Case of (6) 4 oz. Alcohol Squeeze Bottles	15.25
F1-000728	Bottled Alcohol (28 oz.)	9.25
F1-1007GA	1 Case Alcohol (4 gallons per case)	142.95



HAZMAT FEES  
MAY APPLY  
GALLON ONLY



GROUND  
SHIPPING  
REQUIRED



F1-0068

F1-0007

F1-000728

**FIBER OPTIC CLEANING SOLUTION**

This fast-acting cleaner can be used with dry fiber wipes or tissues to remove dirt and soils from optical fibers prior to termination and splicing or to clean the end of connector ferrules.

PART #	DESCRIPTION	PRICE
F1-6706	Fiber Optic Cleaning Solution (2 oz.)	\$15.75
F1-6706AQ	Water-based Fiber Optic Cleaner (2 oz.)	10.00



Air Ship  
Available



F1-6706

**FIBER OPTIC SPLICE AND CONNECTOR CLEANER**

Ideal for cleaning ferrules in connector bulkheads as well as individual fiber optic connectors. This fast-drying, optical-grade cleaning fluid can be used with wipes or cleaning sticks for wet/dry cleaning without chemical residue. Three-way dispenser enables you to select spray mode, dampening mode or wetting mode. Travel safe, non-flammable, non-regulated, and non-hazardous. No hazmat fees!

PART #	DESCRIPTION	PRICE
POC03M	Sticklers Splice and Connector Cleaner (3oz.)	\$15.95



Air Ship  
Available



POC03M

**ITW CHEMTRONICS CLEANING SOLUTIONS**

PART #	DESCRIPTION	PRICE
F1-ES810	Electro-Wash® 5 oz. Aerosol Can (PX) (Ground shipping required)	\$13.95
F1-ES110	Electro-Wash® 1 Gallon Bottle (PX) (Ground shipping required)	86.50
F1-ES1210	Electro-Wash® 12.5 oz. Aerosol Can (PX) (Ground shipping required)	26.95
F1-ES1607	Electro-Wash® 12 oz. Aerosol Can (NXO) (Ground shipping required) (Pictured)	72.50
F1-MXCP	Electro-Wash® MX Cleaning Pen (Pictured)	9.35



F1-ES1607



F1-MXCP



F1-1004

**PRE-MOISTENED ALCOHOL WIPES**

Fast evaporating alcohol pre-moistened wipes can be used on optical fiber to remove dirt, dust and oils. Contains: Isopropanol.

PART #	DESCRIPTION	PRICE
F1-1004	FIS Pre-Moistened Alcohol Wipes, 4"x6" wipe size (50 pk.)	\$10.95



F0-1

**POLYWATER ANHYDROUS ALCOHOL**

Type FO™ is great for cleaning glass fiber, connector end faces or prior to splicing. Type FO™ quickly removes dust, oils, and contaminants, while leaving no residue. The anhydrous alcohol in FO™ has essentially no water content. The towels are durable and non-linting. The package limits vapor exposure and eliminates spill hazards. **Hazmat fees may apply.**

PART #	DESCRIPTION	PRICE
F0-1	Type FO™ Alcohol Prep Wipe, 7.5"x12" wipe size (50 pk.)	\$35.00
F0-16	Type FO™ 16-oz Alcohol Fiber Cleaner - Hazmat fees may apply.	12.50



F1-1010

**PRE-MOISTENED DEGREASER WIPES (ICKY-PIC CLEANER)**

FIS Icky-Clean wipes can be used with outside plant, optical or copper cables. Utilize to remove Icky-Pic or gels from cables prior to splicing or termination. Great to clean up tools as well.

PART #	DESCRIPTION	PRICE
F1-1010	FIS Pre-Moistened Degreaser Wipes, 5"x8" wipe size (12 pk.)	\$10.50
F1-1010-100	FIS Pre-Moistened Degreaser Wipes, 5"x8" wipe size (100 pk.)	80.00



F1-TC1

**POLYWATER SQUEEKYKLEEN™ (ICKY-PIC CLEANER)**

SqueekyKleen™ cleans and fans fiber in two wipes without alcohol. SqueekyKleen™ is less harsh on hands, reduces chemical odors and vapor concentrations to a minimum in splice trailers and vaults. Unique formulation and specially designed high-performance towelettes work to remove pic from the entire surface of loose-tube or ribbon fibers, leaving no residue. Safe on acrylate and Mylar®.

PART #	DESCRIPTION	PRICE
F1-TC1	Telcom Cleaner-Saturated Wipe, 7.5"x12" wipe size (12 pk.)	\$17.50



F1-1091T

**POLYWATER HYDRASOL® SOLVENTS (ICKY-PIC CLEANER)**

HydraSol® is a water-based solvent cleaner that is amazingly effective at dissolving and removing cable filling greases (Icky Pic). This economical product easily rinses off hands and tools. Our tear-resistant, presoaked towelette comes in an easy-open foil pack and is especially effective for smaller cleaning jobs and fiber optic splicing.

PART #	DESCRIPTION	PRICE
F1-1091T	HydraSol® Premoistened Tissues, 7.5"x12" wipe size (12 pk.)	\$16.50
F1-1091GP	HydraSol® 1 Gallon Jug	69.25



F1-CP421



F1-1003



CP400



S1P100P

**ITW CHEMTRONICS DE-GREASER WIPES**

PART #	DESCRIPTION	PRICE
F1-CP421	Electro-Wash® Wipes, 8"x10" wipe size (25 individual wipes per box)	\$56.25



HAZMAT FEES MAY APPLY

**ITW CHEMTRONICS OPTIC PREP WIPES**

PART #	DESCRIPTION	PRICE
F1-1003	Optic Prep Tissue Pack Box, 4"x8" wipe size (50pk)	\$32.95
CP400	Pre-Saturated Cleaning Wipe - Lint Free, 4"x3" wipe size (50pk)	34.95



HAZMAT FEES MAY APPLY

**ITW CHEMTRONICS OPTIC PREP WIPES**

PART #	DESCRIPTION	PRICE
S1P100P	Pre-Saturated Wipes, 100 wipes per tube (Ground shipping required) - Hazmat Fees May Apply.	\$35.50



## PT TECH D'GEL SOLVENTS

D'Gel Cable and Tool Cleaner is a full strength solvent specifically developed for removing cable gels, blocking compounds, Icky Pic, and C-cement. It also removes grease, tar, oil, wax, resin and gum from copper and fiber optic cable. It works equally well on painted surfaces and machine equipment. D'Gel does not contain TCE, HCFC's or methylene chloride.

PART #	DESCRIPTION	PRICE
F1-1011	12 Pack Box of Premoistened Tissues	\$38.95
F1-1091G	1 Gallon Jug	79.95
F1-1091S	32 oz. Spray Bottle	26.95



F1-1091S

FC451

## CORNING FIBER-CLEAN® TOWELETTES

Remove Icky Pic and water blocking compounds with Fiber-Clean® Towelettes. Each pre-moistened tissue enables installers to clean and prepare optical fibers for connectorization and splicing. There are 45 tissues in each Fiber-Clean® "pop-up" Dispenser. **Ground shipping required.**

PART #	DESCRIPTION	PRICE
FC451	Fiber-Clean® Towelettes, , 7.5"x6" wipe size	\$25.95



TC-128

TC-35LF

TC-35LR

## POLYWATER SQUEEKYKLEEN™

No follow-up with alcohol required to get fibers squeaky clean and separated when prepping for splicing. SqueakyKleen™ is less harsh on hands and reduces chemical odors and vapor concentrations to a minimum in splice trailers and vaults. SqueakyKleen™ helps keep splice equipment clean of contamination for better fiber alignment and splice quality. Safe on acrylate and Mylar®.

PART #	DESCRIPTION	PRICE
TC-16LF	Telcom Cleaner with Flip Top (6 oz.)	\$13.50
TC-35LF	Telcom Cleaner with Flip Top (1 qt)	15.95
TC-128	Telcom Cleaner (1 gallon)	45.00
TC-35LR	Telcom Cleaner with Sprayer	19.95



12890

05930

## KIMBERLY CLARK WYPALL ALL PURPOSE TOWELS

For wiping small parts or reaching tight spaces, you can't beat WYPALL™ Detail Wipers. Unlike rags and shop towels, this small format wipe is specifically designed for detail work. Plus it delivers the durability, absorbency and convenience you need for those small but important tasks.

PART #	DESCRIPTION	PRICE
05930	WypAll Towels, 9x17" wipe size (80pk) - X80	\$18.95
12890	WypAll Towels, 11"x17" wipe size (68pk) - X90 - Highest Performing	25.95



91371

## KIMBERLY CLARK WATERLESS CLEANING WIPES

Heavy duty hand cleaning wipes. Pre-moistened wipes with a heavy-duty waterless cleanser. Gets hands clean in the same place they got dirty.

PART #	DESCRIPTION	PRICE
58310	Dispenser with 50 Ct Cleaning Wipes (9" x 12")	\$11.95
91371	Dispenser 75 Ct Waterless Cleaning Wipes (9" x 12")	15.50
91367	75 Ct Refill for 91371 Bucket Dispenser (9" x 12")	13.50



HTC-D72

## POLYWATER GRIME-AWAY™ PREMOISTENED TOWELETTES

Grime-Away™ wipes are heavy-duty towelettes pre-moistened with a multi-purpose cleaning solution. Grime-Away™ moisturizes and softens hands while cleaning tools and surfaces. Grime-Away™ towels feature a textured side to quickly remove greases, dirt, and grime. They also feature a soft side to be gentler on skin.

PART #	DESCRIPTION	PRICE
HTC-D72	Polywater Grime-Away, 10"x12" wipe size (72pk)	\$14.95

## HAND CLEANER TOWELETTES

When working with optical fiber, it is good practice to keep hands clean to ensure they are free of contaminants. However, soap and water are not always available on the jobsite. SCRUBS pre-moistened towels provide the answer, removing even hard to clean industrial soils and grease without water. Pleasant citrus fragrance and gentle on skin.

PART #	DESCRIPTION	PRICE
42272	Hand Cleaner Towels, 10"x12" wipe size (72pk)	\$20.50



42272

F1-6712



## FIS FIBER SWIPE500

This unique handheld connector ferrule end face cleaner removes dust, dirt and contaminants prior to mating a fiber optic connection. The fiber optic cleaner fits well in the technician's hand with a convenient trigger that automatically opens the top cleaning window to expose a single microfiber cleaning slot. Simply swipe the ferrule end-face with light pressure against the microfiber with the directional arrow and then release the trigger.

PART #	DESCRIPTION	PRICE
F1-6712	FIS Fiber Swipe500	\$40.95
F1-6713	Replacement Reel (20 ft)	17.95

F1-7020C



## FIS CONNECTOR CLEANER

Choose the FIS Hand Held Connector Cleaner as an alternative to alcohol or solvent and wipes. The cartridge offers lint-free, clean room grade cleaning media which effectively removes dirt, dust, oil, grease and debris from connector endfaces. A new resilient rubber pad beneath the cleaning surface prevents scratching, and a sliding cover protects the cleaning media from contamination when not in use. Reel refills available.

PART #	DESCRIPTION	PRICE
F1-7020C	FIS Connector Cleaner Universal (400 cleans)	\$12.95
F1-7021C	FIS Cleaning Media Replacement Reel (20 ft.)	5.25

F1-7111



## FIS CONNECTOR CLEANER WITHOUT RETRACTABLE COVER

PART #	DESCRIPTION	PRICE
F1-7111	FIS Connector Cleaner Universal (240 cleans)	\$17.50
F1-7112	Replacement Reel for F17111 (10ft.)	5.95

## CLETOP CLEANING PRODUCTS

The CLETOP optical fiber connector cleaners are rugged handheld tools for cleaning fiber optic connector end faces. The CLETOP cleaners quickly and effectively clean a variety of connectors. CLETOP cleaners are a safe cleaning option without the need for isopropyl alcohol, which is toxic and flammable. CLETOP cleaners have refillable cleaning tapes with 400 cleans per tape making them ideal for lab and field use. The simple push button shutter operation makes cleaning connectors quick and easy.

The CLETOP-S Series is a second generation CLETOP cleaner offering the same CLETOP cleaning performance with "drop-in" replacement tape cartridge and ergonomic design that works equally well for left or right handed operators.

PART #	DESCRIPTION	PRICE
F1-6270	Cletop Connector Cleaner - SC, FC, ST, E2000 (Replacement Blue Tape F1-6271)	\$100.00
F1-6270MTRJ	Cletop MTRJ Male Cassette with White Tape (Replacement White Tape F1-6277)	110.00
F1-6270MT	Cletop MTP/MPO Male Cassette with White Tape (Replacement White Tape F1-6277)	110.00
F1-6210MF	Cletop MTRJ/MTP Female Cassette with White Tape (LC, MU also) (Replacement White Tape F1-6277)	100.00
F1-6270S	Cletop-S Connector Cleaner - SC, FC, ST, E2000 (Blue Tape F1-0700)	90.00
F1-6270SMT	Cletop-S Connector Cleaner for LC, MU, Female MTP and MT-RJ (White Tape F1-0701)	90.00
F1-6271	Cletop Woven Film Replacement Reel Blue Tape (Type A)	28.95
F1-6277	Cletop Woven Film Replacement Reel White Tape (Type A)	28.95
F1-0700	Cletop-S Tape Cartridge Blue Tape (Type S)	28.95
F1-0701	Cletop-S Tape Cartridge White Tape (Type S)	28.95

### Note:

The Blue Tape is the original color tape. It was used on connectors with 2.5mm diameter ferrules such as the FC, ST, and SC. With the introduction of the smaller 1.25mm diameter ferrules such as used in the LC connector and multifiber connectors such as the MPX, there was some concern the smaller geometry connectors might "snag" on the somewhat looser weave of the Blue Tape. Therefore, a smoother White Tape was developed. Over time, with very few exceptions, the looser weave of the Blue Tape turned out to not be a problem for the smaller geometry ferrules. Currently, the selection of Blue or White Tape is primarily user preference.

## OPTIPOP CLEANING PRODUCTS

OPTIPOP fiber optic connector cleaners are rugged palm-sized units that offer exceptional performance field-proven by technicians over years of service. Cost-effective refillable cleaning tape with over 400 cleans per tape.

PART #	DESCRIPTION	PRICE
FCRC	Optipop Fiber Optic Connector Cleaner (25 ft.)	\$70.00
FCRR	Optipop Cassette Refill	25.00
FCRCMTP	Optipop MTP/MPO Male Fiber Optic Connector Cleaner	70.00
FCRCMTRJ	Optipop MTRJ Male Fiber Optic Connector Cleaner	70.00

## SENKO MPOPLUS®

The SENKO MPOPLUS® Effective for removing oil, dust, and dirt particulates that can have a negative impact on fiber optic performance. Pad cleans entire MPO Endface including PIN area. Easy to use with a push-pull function. Stick cleans MPO adapters. Each item is used separately.

PART #	DESCRIPTION	PRICE
SCK-PT-MPO-GSC-05	MPO Smart Cleaner GEL Stick for cleaning adapters (pack of 5)	\$12.95
SCK-PT-MPO-01	MPO Smart Cleaner GEL Pad for cleaning connector endface	5.50

SCKPTMPOGSC-05



SCKPTMPO01



**FIS BULKHEAD & PATCH CABLE FERRULE CLEANER**

The adapter or mating sleeve, when connected on far side creates a bulkhead opening which can be cleaned without removing the connector.

PART #	DESCRIPTION	PRICE
F1-6715	FIS 2.5mm Bulkhead Ferrule Cleaner (audible "click" with rotating head) (525+ cleans)	\$55.00
F1-6716	FIS 1.25mm Bulkhead Ferrule Cleaner (audible "click" with rotating head) (525+ cleans)	55.00
F1-6717	Refillable Bulkhead Fiber Optic Cleaner for 2.5mm Ferrules and Alignment Sleeves, SC, ST, FC and E2000, UPC & APC (750+ cleans)	69.00
F1-6718	Refillable Bulkhead Fiber Optic Cleaner for 1.25mm Ferrules and Alignment Sleeves, LC, and MU, UPC & APC (750+ cleans)	69.00
F1-6717R	Refill for FIS Fiber Optic Cleaner F16717 for SC, ST, FC & E2000 (750+ cleans)	56.00
F1-6718R	Refill for FIS Fiber Optic Cleaner F16718 for LC & MU (750+ cleans)	56.00
F1-6725	Connect-0 Clean Bulkhead Ferrule Cleaner for 2.5mm connectors (SC,ST,FC) (525+ cleans)	40.00
F1-67125	Connect-0 Clean Bulkhead Ferrule Cleaner for 1.25mm connectors (LC/MU) (525+ cleans)	40.00



**IBC™ BRAND CLEANING TOOLS SERIES**

The US Conec IBC™ Brand Cleaners are mechanical cleaning tools designed to clean connectors residing in an adapter or faceplate and unmated connectors. The IBC™ Brand Cleaning tools use a novel dry cleaning strand to gently sweep and lift away dust and residues from the connector end face.

**FEATURES**

- Audible "click" to alert the operator when tool is fully engaged
- Over 525+ engagements per unit
- Dry cleaning strand eliminates the need for solvents to be effective
- Impact resistant to survive drops over 1.5M

PART #	DESCRIPTION	PRICE
9392	IBC™ Cleaner SC (SC,ST, FC and E2000)	\$56.00
9393	IBC™ Cleaner LC (LC, MU) - pictured	56.00
9394	IBC Brand Cleaner HC - OptiTap FTTH Connectors <b>NEW</b>	60.00
7104	MTP/MPO Bulkhead Cleaner (525+ cleans)	71.95
12910	IBC™ Cleaner H-125 (1.25mm Harsh Environment Connectors)	68.00
12926	IBC™ M20 Cleaner SMTPE 304M (2mm Harsh Environment Connectors)	68.00
13310	IBC™ Cleaner M250 for TFOCA II® (2.5mm Connector Systems) - pictured	68.00
13964	IBC™ Mini-Clean 2.5mm (SC, ST, FC, E2000 - with key chain) - pictured	64.00
13965	IBC™ Mini-Clean 1.25mm (LC, MU - with keychain)	64.00
14303	IBC™ Brand Cleaner LC Duplex - pictured	87.50



**SENKO BRAND SN/CS CLEANERS**

The Senko brand SN/CS One-Click Cleaners offer dual cleaning of end faces and reduce cleaning times. They have self aligning cleaning tips for consistent cleaning performance of unmated and in adapter end faces. Both are RoHS and REACH compliant with no shelf life or restrictions on storage or shipments. Each model works for UPC and APC polished end faces. Most effective cleaning when inserted into adapter ports and transceiver ports in the up or down position. The cleaners lock up at the end of life cycle alerting the operator that it is time to be reordered.

PART #	DESCRIPTION	PRICE
SCKDCCS	Senko CS One-Click Duplex Cleaners	\$126.95
SCKDCSN	Senko SN One-Click Duplex Cleaners	126.95



**AFL ONE-CLICK® CLEANER**

The One-Click Cleaner is an easy-to-use option for cleaning connectors in adapters. Simply insert the One-Click Cleaner into an adapter and push until an audible "click" is heard. The One-Click Cleaner uses the mechanical push action to advance an optical grade cleaning tape while the cleaning tip is rotated to ensure the fiber end-face is effectively, but gently, cleaned. The One-Click Cleaner is a must-have for field technicians. Small enough to fit in a shirt pocket and a great addition to cleaning kits.

PART #	DESCRIPTION	PRICE
85003MZ	One-Click® Cleaner MPO/MTP (500+ cleans)	\$57.00
85001MZ	One-Click® Cleaner SC, ST, FC 2.5mm ferrules (500+ cleans)	57.00
85002MZ	One-Click® Cleaner LC/MU 1.25mm ferrules (500+ cleans)	57.00
8500-05-0007MZ	One-Click Ultra Cleaner 2.5 (enlarged cleaning) SC, ST, FC (500+ cleans)	69.00
8500-05-0008MZ	One-Click Cleaner D-LC, Duplex LC (2 x 500+ cleans)	82.50



**FERRULE MATE™**

Wouldn't it be great if you could limit your connector cleaning supplies to one versatile tool? You can, with Ferrule Mate™. The device cleans recessed fiber optic adapters as well as individual connectors. With the push of a button, the tool forwards and rotates the cleaning cloth. Cloth provides approximately 350 swipes, with a cost as low as 18 cents per cleaning. Use the SFM-250 for SC, FC, and ST. Use the SFM-125 for MU and LC.

PART #	DESCRIPTION	PRICE
SFM-250	Ferrule Mate™ 2.5mm Ferrules	\$57.00
SFM-125	Ferrule Mate™ 1.25mm Ferrules	57.00





## FIS WRAPPED SWABS - 2.5mm and 1.25mm

INTENDED FOR FERRULE END-FACE OR ALIGNMENT SLEEVE CLEANING

PART #	DESCRIPTION	PRICE
F1-25184	2.5mm Wrapped Swabs (5pk)	\$3.50
F1-25183	2.5mm Wrapped Swabs (100pk)	45.00
F1-25123	1.25mm Wrapped Swabs (5pk)	3.50
F1-25123B	1.25mm Wrapped Swabs (100 pk)	45.00

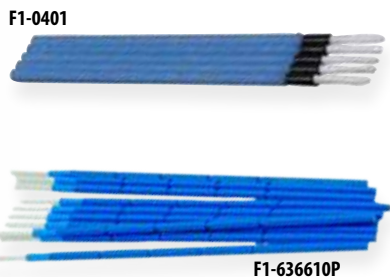

## CLETOP CLEANING SWABS

INTENDED FOR FERRULE END-FACE OR ALIGNMENT SLEEVE CLEANING

PART #	DESCRIPTION	PRICE
F1-0401	Cletop Stick 1.25mm (5 pk)	\$5.95
F1-0400	Cletop Stick 2.5mm (5 pk)	5.95
F1-0402	Cletop Stick 2.0mm MIL-AERO Application (5 pk)	5.95
F1-0403	Cletop 2 Sided Stick (2.0mm and 2.5) (5 pk)	11.50



## OPTIPOP CLEANING SWABS

INTENDED FOR FERRULE END-FACE OR ALIGNMENT SLEEVE CLEANING

PART #	DESCRIPTION	PRICE
F1-636510P	Optipop Stick Cleaner 1.25mm (10 pk)	\$7.95
F1-636610P	Optipop Stick Cleaner 2.5mm (10 pk)	7.95



## FIS MINI-FOAM TIP SWABS - 2.5mm

INTENDED FOR FERRULE END-FACE OR ALIGNMENT SLEEVE CLEANING

PART #	DESCRIPTION	PRICE
F1-0005	2.5mm Mini Foam Swabs (50 pk)	\$15.00

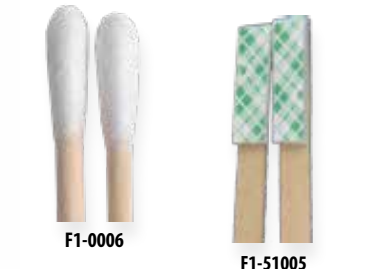

## FIS MTP CONNECTOR END-FACE CLEANING SWAB

INTENDED FOR FERRULE END-FACE OR ALIGNMENT SLEEVE CLEANING

PART #	DESCRIPTION	PRICE
F1-25LCMTPB	MTP Chamois Swab (25 per tube)	\$22.95



## FIS FUSION SPLICER V-GROOVE CLEANING SWAB

PART #	DESCRIPTION	PRICE
F1-38542F	V-Groove Cleaning Swab (50 per tube)	\$20.00



## FIS FUSION SPLICER LENS CLEANING SWAB

PART #	DESCRIPTION	PRICE
F1-51125F	Fusion Splice Lens Cleaning Swab (15 per tube)	\$20.95

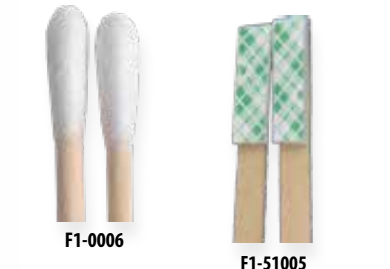

## FIS ALCOHOL CLEANING COTTON SWABS

PART #	DESCRIPTION	PRICE
F1-SWB110PK	Contact Clean Pack (Single Sided Swabs 1-dry and 1-wet (10 pk)	\$20.00

\* Not for use with mating sleeves



## FIS GENERAL PURPOSE COTTON SWABS

PART #	DESCRIPTION	PRICE
F1-0006	General Purpose Cotton Swabs, 1 Bag (100 pk)	\$4.95

\* Not for use with mating sleeves



## FIS ADHESIVE TIP DEBRIS REMOVAL SWAB

This swab has an adhesive tip for gathering fiber shards within the work area or cleaver mechanism.

PART #	DESCRIPTION	PRICE
F1-51005	Debris Removal Swab - with Adhesive (5 pack)	\$3.50
F1-5100100	Debris Removal Swab - with Adhesive (100 pack)	40.00

## CONNECTOR CLEANING STICKS

MicroCare cleaning sticks use a fibrous sintered polymer tip that is molded, not hand wound. These cleaning sticks deliver fast and consistent cleaning, even inside alignment sleeves. Compatible with a wide variety of solvents in today's optical market. 50 sticks per clamshell.

PART #	DESCRIPTION	PRICE
MCC-S25	2.5mm Clamshell (50 pk)	\$29.75
MCC-S12	1.25mm Clamshell (50 pk)	29.75
MCC-VS	Combo Pack (20) 2.5, (10) 1.25mm and (20) Military Termini	29.75





F1-6714MPO



F1-0053FSMINI



F1-0053CKM



F1-0053CKV

**FIS CLEANING KITS**

Fiber optic cleaning kits contain all the cleaning supplies you need for fast, reliable fiber optic cleaning. They help keep your installation up and running. They can be wall mounted or come in tough nylon carry cases.

PART #	DESCRIPTION	PRICE
F1-6714	FIS Fiber Optic Cleaning Station - Wall Mountable (includes: FiberSwipe 500, 2.5 & 1.25mm Bulkhead Cleaners, Cleaning Solvent & Dry Wipes)	\$195.00
F1-6714MPO	FIS Fiber Optic Cleaning Station for MPO/MTPs - Wall Mountable (includes: FiberSwipe500, RotoSwipe 2.5 & 1.25mm Bulkhead Cleaners)	295.00
F1-0053FSMINI	FIS Mini Fiber Optic Cleaning Kit (includes: degreaser wipes, alcohol wipes, FIS connector cleaner, ITW Electro Wash MX pen, mini foam swabs, and dry wipes)	69.95
F1-0053CK	FIS Fiber Optic Cleaning Kit (includes: 1.25 and 2.5mm swabs, dry wipes, alcohol wipes, canned air, connector cleaner, 4oz alcohol bottle)	75.95
F1-0053CKM	FIS Cleaning Kit with Microscope (includes: F10053CK Kit plus a 200x Microscope)	175.00
F1-0053CKV	FIS Fiber Optic Connector Endface Cleaning Kit (includes: solvent cleaner, dry wipes, one click cleaners for 1.25mm and 2.5 mm)	175.00

**FIS 5G CLEANING KITS - RRR CABLES**

New applications in the field with the implementation of high density radio heads for 5G deployment will require an increase in the use of hardened fiber optic connectors. Manufacturers of different radio heads have adopted certain hardened connector interfaces between their equipment and outdoor distribution enclosures. Technicians will find themselves confronted with new style connectors that may require deeper cleaning of the housing threads, inner body, O-rings and connector ferrule end face. The unique 5G Cleaning Kits are targeted to provide a wider selection of popular cleaning tools and solvents to address new crevices in hardened connectors that are soiled from outdoor environments.



**KIT CONTENTS & INTENDED USE**

- Pressurized Canned Air and Alcohol – Clean and dry to remove any creviced debris or water.
- Connector End face Cleaning solution – Fast evaporating solvent intended for fiber optic end face.
- Connector Endface Cleaner – Auto Advancing 2.5mm and 1.25mm end face connector cleaning.
- Cleaning swabs – (3) different style swabs for cleaning internal body components and threads.
- Dry Wipes- Woven Cleaning wipes that won't tear while using for outer or inner body cleaning.
- Moistened Towelettes- Outer connector body and cable cleaning.
- (Optional) MPO Endface Cleaner – Auto Advancing cleaner for MTP or MPO end face cleaning.

PART #	DESCRIPTION	PRICE
F15GC	5G Hardened Connector Cleaning Kit (includes Auto Advance Cleaners for SC/LC connectors)	\$268.00
F15GCMP	5G Hardened Connector Cleaning Kit w/ MPO Auto Advancing Cleaners	362.25

**CHEMTRONICS FIBER OPTIC CLEANING KITS**

A high-quality fiber optic installation starts with the connectors. Our Fiber Optic Cleaning Kit not only gives you clean connectors, but also faster transmission rates, higher bandwidth, and maintenance-free operation. Fiber optic kits include all the tools you need to achieve clear connections.

PART #	DESCRIPTION	PRICE
CFK1003	ITW Chemtronics Fiber Optic Cleaning Kit (includes: (1) QBE, (1) FW2150, (1) EB10, (5) CP421, (100) 6704F) (Not pictured)	\$145.00
CFK1000	ITW Chemtronics FTTH Fiber Optic Cleaning Kit (includes: (1) QBE, (1) ES810, (50) 48042F, (50) 38542F, (15) 51125, (100) 6704F, (5) CP421)	140.00



CFK1000

**STICKLERS FIBER OPTIC CLEANING KITS**

There are many different Sticklers™ fiber optic cleaning kits. Each has been engineered to help techs in different industries clean fiber networks quickly, reliably and inexpensively. Each kit conveniently provides all the tools a tech needs to get the job done right.

PART #	DESCRIPTION	PRICE
FK03	Sticklers Fiber Optic Cleaning Kit (includes: connector cleaner solution, wipes, clean stixx and LED flashlight)	\$105.00
FK05	Sticklers Military-Ready Cleaning Kit (includes: connector cleaner solution, wipes and Clean Stixx for S25, S16, S12, XMT, and P25 (Not Pictured))	105.00



FK03

## How To Design Your Custom Tool Kit

### Step 1:

Select your hard or soft case preference. The extra large educational kit size accommodates the most items.

### Step 2:

Select the list of items. You may choose individual or all items from FIS or start by simply adding items to a listed kit closest to what fits your desired requirement. Your kit choices include: Basic Fiber Optic Tool Kit, Connectorization Tool Kit, Fusion Splice Kit and Test Set Kit plus many more.

### Step 3:

If you choose you may add additional accessories to your kit that are most popular amongst our customers. These popular additional accessories include: patchcords, connectors, mating sleeves, splice protection sleeves, attenuators, cable cutting tools, epoxy and microscopes to name a few.



FIS is the leader in the fiber optic industry and offers the best value on Tool Kits. Every year FIS expands upon its Tool Kit line and upgrades several tools to show our commitment to providing quality kits. The Universal Connectorization Epoxy Tool Kit provides a technician with materials to prep and connectorize standard fiber optic connectors such as ST, SC, and FC. For technicians searching for the ultimate Tool Kit, review our Universal Multimode Test Set Kit and Fusion Splicing Kits.

## CUSTOMIZE ANY TOOL KIT

You have the option to customize any of the FIS Tool Kits. You can add or swap items from the FIS kits. Please contact an FIS Sales Representative for pricing.

### TEST EQUIPMENT OPTIONS

- FIS Pocket Fault Locator
- FIS Power Meters
- FIS Light Sources
- FIS Talk Sets
- FIS Mini-OTDR
- FIS Pulse Suppressors and Test Boxes

### ATTENUATOR OPTIONS

- FIS Male-Female attenuators in 1-20dB for FC, FC/APC, SC, SC/APC, ST, LC, LC/APC and MU
- FIS variable attenuators

### KEVLAR CUTTER OPTIONS

- F1KS1 - Miller Scissors
- F100201 - FIS Economy Scissors
- F16430 - Clauss Kevlar Cutters
- F19809 - Miller Kevlar Cutter

### CUSTOM KIT CASE OPTIONS

PART #	DESCRIPTION	DIMENSIONS and WEIGHT(W x L x D)	PRICE
F1-0053HARD	FIS Standard Tool Case, unloaded - <b>Empty*</b>	20" x 15" x 8", 10 lbs	\$225.00
F1-0053BSC	FIS Mini Soft Case, unloaded - <b>Empty*</b>	16" x 11" x 5", 4 lbs	150.95
F10053BAG	FIS Tool Bag, unloaded - <b>Empty*</b>	14" x 12" x 8.5", 4 lbs	60.00
F1-0053SFN	FIS Standard Die Cut Foam Bottom Insert For F1-0053HARD		40.95
F1-0053PPN	FIS Pick N' Pluck Bottom Foam Insert		60.00
F1-0053STPN	FIS Standard Leather Pallet		69.95

\* Must order bottom insert and top pallet from choices above.

### PATCH CABLE OPTIONS

- FIS Singlemode simplex and duplex patch cables
- FIS Multimode simplex and duplex patch cables
- FIS Specialty patch cables: MTP, MT-RJ, E2000, MU, ESCON, FDDI or Polarization Maintaining patch cables

### FIBER OPTIC STRIPPER OPTIONS

- F1-1301T - FIS Precision Fiber Stripper
- W01224 - Miller Stripper
- PA1171 - Paladin Fiber Optic Stripper

### MICROSCOPE OPTIONS

- F1MS200U - FIS 200x Compact Microscope
- F1VS400F2.5 - FIS 400x Handheld Microscope
- F1VSF25 - FIS 100x Handheld Universal Scope



F1-0053HARD



F1-0053BSC

# FIS BASIC FIBER OPTIC TOOL KITS



**Non-Hazardous Ships Air!**

**Basic Fiber Optic Kit  
F1-0053**

PART #	DESCRIPTION	PRICE
F1-0053	Basic Tool Kit (Pictured)	\$560.00
F1-0053C	Replacement Consumable Kit *	49.95
F1-0053R	Basic Tool Kit with New Tools & VFL (R Version)*	560.00
F1-0053SB	Basic Tool Kit with Soft Case	430.00

\*R Version can't ship air

	Basic	R Version		Basic	R Version
• PVC Electrical Tape (F1-0008)	•	•	• 4 Bit Screwdriver (F1-0027)	•	•
• 2 oz. Cleaning Solvent (F1-6706)*	•	•	• Black Marker (F1-9104)	•	•
• Trihole Fiber Stripper (F1-1301T)	•	•	• Safety Glasses (F1-S13390C)	•	•
• FIS Connector Cleaner (F1-7020C)	•	•	• (5) Degreaser Wipes (F1-1010)*	•	•
• Kevlar Scissors (F1-KS1)	•	•	• Black Work Mat (F1-0024)	•	•
• Jacket Stripper (F1-0016)	•	•	• Fiber Disposal Unit (F1-18329)	•	•
• Buffer Tube Stripper (F1-0017)	•	•	• Ruler (RMC-6)	•	•
• Miller FTS Buffer Scorer (80980)	•	•	• Fabric Tape Measure (F1-8273)	•	•
• Round Cable Slitter (MK02)	•	•	• 1/2" Nut Driver (1UG30G)	•	•
• 6" Side Cutting Pliers (200038)	•	•	• Rugged Carry Case (F10053HARD)	•	•
• (50) Foam Swabs (F1-0005)*	•	•	• 1Mtr 3mm Furcation (FO0FR3NUO)	•	•
• Utility Knife (F1-0023BLK)	•	•	• 1Mtr 900µm Furcation (FO0FR900HW)	•	•
• Tweezers (F1-0019)	•	•	• Splice Sleeve and Shrink Tube Kit (P50KIT)	•	•
• Piano Wire (F1-8265K)*	•	•	• Duct Tape (7788A202)	•	•
• Fiber Optic Wipes (F1-6705)*	•	•	• (25) Tie Wraps 7" (T50S25)	•	•
• 2.5 Ferrule Auto Cleaner (F1-6725)	•	•	• Canned Air 10oz (F1-10075)	•	•
• (20) Alcohol Towelettes (F1-1004B)	•	•	• Visual Fault Locator 2.5mm (F1VFL)	•	•
• (2) Large Black Tie Wrap (F0TWBK2)	•	•	• Mating Sleeve Kit (ST, FC, SC, LC) (F1-F0T5MSK)	•	•
• 50pk Fusion Splice Sleeves 60mm (F1-2550)	•	•	• Small Plastic Storage Case (P50)	•	•

## CONNECTORIZATION EPOXY TOOL KIT (SC, FC, ST, LC, MU)

Includes all items in FIS Basic Tool Kit (F1-0053) plus:

- Carbide Scribe (F1-9773)
- FIS Universal Crimp Tool (F1-3227)
- Rubber Polish Pad (PP-575)
- Glass Polish Plate (F1-9111)
- (5) Syringes (50147331RCS)
- Universal Polish Puck (F1-6925UN)
- (5) 0.3µm Polish Film Sheet (F1-0102-03S)
- (5) 1µm Polish Film Sheet (F1-0102-1S)
- (5) 5µm Polish Film Sheet (F1-0102-5S)
- Instructions for FIS Connectors ST, FC and SC (F217)
- (5) FIS 4gr. Blue Dye Epoxy (T60-065-B4)
- FIS Universal Microscope (F1-MS200U)
- LC/MU Crimp Die (F18825LM)
- LC/MU Polish Puck (F16925UN)
- LC Instructions (F217)
- (5) 0.5µm Diamond Film (DLF6X6.5661X)
- (5) 1.5µm Diamond Film (DLF6X61.5661X)

PART #	DESCRIPTION	PRICE
F1-0053U	Universal 2.5mm Epoxy Connectorization Tool Kit (SC, FC, ST)	\$840.00
F1-0053UO	Universal Epoxy Connectorization Tool Kit with 24-Port Heat Oven, 110 VAC & LC/MU Oven Block	1,175.00
F1-0053UO220	Universal Epoxy Connectorization Tool Kit with 24-Port Heat Oven, 220 VAC & LC/MU Oven Block	1,175.00

## FIS MINI BASIC FIBER OPTIC TOOL KIT

- Mini Soft Case (F1-0053BSC)
- PVC Electrical Tape (F1-0008)
- Tri-Hole Fiber Stripper (F1-1301T)
- FIS Connector Cleaner (F1-7020-C)
- Kevlar Scissors (F1-KS1)
- Buffer Tube Stripper (F1-0017)
- Round Cable Slitter (MK02)
- 6" Side Cutting Pliers (200038)
- (50) Foam Swabs (F1-0005)
- Fiber Optic Wipes (F1-6702)
- Utility Knife (F1-0023BLK)
- Tweezers (F1-0019)
- Needle Nose Pliers (100021)
- 4 Bit Screwdriver (F1-0027)
- Black Marker (F1-9104)
- Ruler (RMC-6)
- Fabric Tape Measure (F1-8273)
- 2 oz. Cleaning Solvent (F1-6706)
- Piano Wire (F1-8265)
- (5) Fusion Splice Sleeve 60mm (F1-1002C)

PART #	DESCRIPTION	PRICE
F1-0053MSB	Mini Basic Fiber Optic Tool Kit	\$350.00

## FIS FUSION SPLICING TOOL KIT

Includes items in FIS Basic Tool Kit \*R Version except P50, plus:

- (5) Degreaser Wipes (F1-1010)
- Cable Cutters (F1-727)
- \* Optional Lynx Cleaver (F1-LYNX)

PART #	DESCRIPTION	PRICE
F1-0053FS	Fusion Splicing Tool Kit	\$605.00
F1-0053FS-C	with Lynx Cleaver (F1-LYNX)	1,180.00



**FIS Basic Handheld Tool Bag  
F1-0053HH**



**FIS Handheld Singlemode Test & Inspection Tool Bag  
F1-0053SMTI**

**FIS Backpack Tool Kit  
F1-0053PACK**



**Now with  
E-Series  
PM & LS**



**FIS Universal MM Test Set Tool Kit  
F1-0053TS-MME**

**FIS HANDHELD TOOL BAG**

**All items included within the FIS Handheld Tool Bag (F1-0053HH):**

- Nut Driver 1/2" (1UG30G)
- FIS 3 Hole Jacket Stripper (F11301T)
- FIS Icky-Clean Fiber Optic Cleaner Towlette (F11010B)
- 3M EMSD Black Electrical Tape 3/4" x 60' (F10008)
- FIS Jacket Stripper (F10016)
- Tweezers (F10019)
- Retractable Utility Knife Black (F10023BLK)
- Screwdriver 4-Bit w/FIS name (F10027)
- FIS Fiber Optic Cleaning Solution 2oz (F16706)
- FIS Low Lint Tissues 280 Tissues/Box (F16705)
- FIS Standard Fiber Optic Disposal Unit w/Slide Top (F18327)
- Sharpie Permanent Black Marker, Fine Pt (F19104)
- Miller KS-1 Kevlar Shear (F1KS1)
- Safety Glasses - Clear (F1S13390C)
- Round Cable Jacket Stripper (MK02)
- Stainless Steel 6" Ruler (RMC6)
- Long Nose Pliers 6" Serrated with Green Handle (100021)
- Side Cutting Pliers 6" with Green Handle (200038)
- Ripley Fiber Tube Scoring Tool 1.6mm-6.0mm (80980)
- Miller Mid-Span Access Tool (MSAT5)
- FIS Bulkhead Ferrule Cleaner 2.5mm Connectors - Gray Tip (F16715)
- FIS Bulkhead Ferrule Cleaner 1.25mm connectors - Blue Tip (F16716)
- FIS Pocket Visual Fault Locator (VFL) Univ. 2.5mm Adapter (F19000VFL)
- FIS Visual Fault Locator 1.25mm Adapter (Use w/ F1-9000VFL) (F190125)
- Cable Slitters Armored (F1ACS)
- Dorcy 2AA LED Flashlight (412955)
- Greenlee Power Return Tape Measure 25' (015525A)
- FIS 2.5mm Wrapped Swabs (5pk) (F125184)
- FIS 1.25mm Wrapped Swabs (5 pk) (F125123)
- FIS Connector Cleaner Universal Blue Housing w/20' Tape (F17020C)
- Flexible Piano Wire 8 pc (F18265K)

PART #	DESCRIPTION	PRICE
F10053HH	FIS Handheld Basic Tool Bag	\$745.00
F10053OSP	FIS Handheld OSP Tool Bag (F10053HH plus Miller Flat drop splitter, MB04-7000)	795.00
F10053SMTI	FIS Handheld Singlemode Test & Inspection Tool Bag (F10053HH plus E-Series Power Meter & SM Light Source)	1,028.95
F10053MMTI	FIS Handheld Multimode Test & Inspection Tool Bag (F10053HH plus E-Series Multimode Power Meter and MM Light Source)	1,075.00

**FIS BACKPACK TOOL KIT**

**All the great products you became accustomed to in the FIS Tool Kit now in a smaller, lightweight, and durable backpack. (Special custom kits are available). Refer to page 113 for full list of contents.**

PART #	DESCRIPTION	PRICE
F1-0053PACK	FIS Backpack Basic Fiber Optic Tool Kit	\$295.00
F1-0053PACKFS	FIS Backpack Fusion Splicing Tool Kit	350.00
F1-0053PACKFSC	FIS Backpack Splicing Tool Kit with Lynx Precision Cleaver	925.00
F1-0053PACKFSCVFL	FIS Backpack Splicing Tool Kit with PFL and Lynx Cleaver	1,025.00
F1-0053PACKFSVFL	FIS Backpack Splicing Tool Kit with Pocket Fault Locator	450.00
F1-0053PACKU	FIS Backpack Universal SC, FC, ST, LC, MU	1,075.00

**FIS UNIVERSAL SM TEST SET AND CONNECTORIZATION TOOL KIT**

**Includes all items in FIS Universal Epoxy Tool Kit (F1-0053U) plus:**

- FIS E-Series Power Meter with Adapter (F1-8513PM)
- FIS E-Series SM 1310/1550nm Light Source (F1-1315LS)
- (2) Simplex 3mm SM Ultra SC/UPC-SC/UPC 2 Mtr (S9YUYUS2FISCU)
- (2) Simplex 3mm SM Ultra ST/UPC-SC/UPC 2 Mtr (S98UYUS2FISCU)
- (2) Simplex 3mm SM Ultra FC/UPC-SC/UPC 2 Mtr (S97UYUS2FISCU)
- (2) FIS Simplex 1.6mm SM Ultra LC/UPC-SC/UPC 2 Mtr (Y9LUVUS2FISCU)
- Visual Fault Locator (F1-9000)
- (1) LC SM Simplex Adapter Blue No Flange (F18005NF)
- (1) SC SM/MM Adapter Zirconia Sleeve Blue w/ Flange (F13810BC)
- (1) CORNING ST SM Adapter Threaded (8119)
- (1) Singlemode FC Adapter (F18520)

PART #	DESCRIPTION	PRICE
F10053TSSME	FIS Universal SM Test Set Tool Kit w/E-Series PM & LS	\$2,250.00

**FIS UNIVERSAL MM TEST SET TOOL KIT**

**Includes all items in FIS Universal Epoxy Tool Kit (F1-0053U) plus:**

- FIS E-Series Power Meter with Adapter (F1-8513PM)
- FIS E-Series MM 850/1300nm Light Source (F1-8513LS)
- (2) FIS Simplex MM 62.5 SC-SC 2 Mtr Patchcord (S2YYM2FISC)
- (2) Simplex MM 62.5um ST/UPC-SC/UPC 2 Mtr Patchcord (S28YM2FISC)
- (2) Simplex MM 62.5 SC-LC 2 Mtr patchcord (Y2YLM2FISC)
- (2) Simplex SC-ST MM 50um OM3 Aqua 2 Mtr Patchcord (Y8Y8M2FISC)
- (2) Simplex SC-SC MM 50um OM3 Aqua 2 Mtr Patchcord (Y8YYM2FISC)
- (2) Simplex LC/PC-SC/PC MM 50um OM3 Aqua 2 Mtr Patchcord (Y8LYM2FISC)
- (1) SC Simplex MM Adapter Zirconia Beige No Flange (F13800CNF)
- (1) LC MM Simplex Adapter Beige - No Flange (F18000A)
- (1) ST MM Adapter Bronze Sleeve (F18102SS)
- (1) 4mm Mandrel for Bend-Insensitive MM Fiber for 1.6/2mm cable (F1CCM04)
- (1) MM Mandrel Kit (50um and 62.5um) (F1MM6250)
- (1) Pocket Fault Locator (F1-9000)

PART #	DESCRIPTION	PRICE
F10053TSMME	FIS Universal MM Test Set & Connectorization Tool Kit w/E Series PM & LS	\$2,250.00

**FIS ANAEROBIC TOOL KIT (SC and LC) (NOT PICTURED)**

**Includes all items in FIS Basic Tool Kit (F1-0053) plus:**

- Anaerobic Adhesive Hardener (680)
- Anaerobic Primer (7649)
- (10) Syringe Tips (5014733IRC5)
- Carbide Scribe (F1-9773)
- Universal Crimp Tool (F1-3227)
- LC/MU Crimp Die (F1-8825LM)
- Rubber Polish Pad (PP-575)
- (5) 1µm Polish Film Sheet (F1-0102-1S)
- (5) 5µm Polish Film Sheet (F1-0102-5S)
- (5) 0.3µm Polish Film Sheet (F1-0102-03S)
- (5) 1.5µm Diamond Film Sheet (DLF6X61.5661X)
- (5) 0.5µm Diamond Film Sheet (DLF6X6.5661X)
- Glass Polish Plate (F1-9111)
- 2.5mm Universal Polish Puck (F1-6925UN)
- LC Universal Polish Puck (F1-6930UN)
- FIS Universal Microscope (F1-MS200U)

PART #	DESCRIPTION	PRICE
F1-0053AH	FIS Anaerobic Tool Kit	\$1,000.00



**DATA CENTER CLEANING STATION**

The FIS Fiber Optic Cleaning Station is a unique new product that provides immediate access to cleaning supplies for technicians. These cleaning kits are wall mountable similar to First Aid kits found throughout many facilities. Open the top cover and find cleaning notes for technicians not familiar with fiber optics. Kits include cleaning instruments for both 2.5mm and 1.25mm ferrules on patch cables and through adapters in the back plane of enclosures. Optional MPO/MTP cleaning tool can be added to kit as well. Special edition and custom kits are available. Standard kit contents: (100) 4"x4" Clean Dry Wipes, 2 oz. Cleaning Solution, Auto-Advance Connector Cleaner, 2.5mm and 1.25mm back plane ferrule cleaning tools. Optional kits with MPO/MTP cleaning tool or choice of IBC™ Cleaners/AFL One Click Cleaners.

PART #	DESCRIPTION	PRICE
F1-6714	Fiber Optic Cleaning Station, Standard Kit	\$195.00
F1-6714MPO	Fiber Optic Cleaning Station, Standard Kit with MPO/MTP cleaning tool	295.00
F1-6714IBC	Fiber Optic Cleaning Station, Special Edition Kit with IBC™ cleaning tools for 2.5/1.25mm adapters	215.00
F1-6714IBCMPO	Fiber Optic Cleaning Station, Special Edition Kit with IBC™ cleaning tools for 2.5/1.25mm adapters and MPO/MTP cleaner	275.00
F1-6714AFL	Fiber Optic Cleaning Station, Special Edition Kit with AFL cleaning tools for 2.5/1.25mm adapters	225.00
F1-6714AFLMPO	Fiber Optic Cleaning Station, Special Edition Kit with AFL cleaning tools for 2.5/1.25mm adapters and AFL MPO/MTP cleaner	295.00



**FIS FIBER OPTIC CLEANING KIT**

- Canned Air (10oz) (F1-1007S)
- Fiber Optic Wipes (F1-6702)
- 2.5mm Foam Swabs (5pk) (F1-25184)
- 1.25mm Wrapped Swabs (5pk) (F1-25123)
- Alcohol Wipes (50pk) (F1-1004)
- FIS Connector Cleaner (F1-7020-C)
- 4 oz. Bottle of Alcohol (F1-00075P)

PART #	DESCRIPTION	PRICE
F1-0053CK	Fiber Optic Cleaning Kit	\$75.95
F1-0053CKM	With 200X Microscope (Pictured)	175.00
F1-0053CKC	Replacement Consumables	39.95



**FIS MINI CLEANING KIT**

The FIS Mini Cleaning Kit provides all of the essential cleaning supplies needed for fiber splicing and connector cleaning. Kit includes: (1) FIS Connector Cleaner, (1 pack of 50) 2.5mm Mini Foam Swabs, Cleaning Pen, (1 pack of 100) 4" x 4" Non Woven Dry Wipes, (1 pack of 100) 4" x 6" Alcohol Towelettes, (1 pack of 12) FIS Icky Clean, Carry Case

PART #	DESCRIPTION	PRICE
F1-0053FSMINI	FIS Mini Fiber Optic Cleaning Kit	\$72.95



**DID YOU KNOW...  
ABOUT CLEANING WITH ENDFACE  
PICTURES AND IEC STANDARD?**

Connector cleanliness is one of the most important issues facing a fiber technician. A dirty or damaged connector is the single most common reason for network failure. Dust particles as small as 5µm can embed themselves into the end faces of connectors creating chips and pits. Damage to a connector end face can result in high attenuation and high Optical Return Loss (ORL) preventing the network to operate as intended.

IEC 61300-3-35 is the industry standard pass/fail criteria developed for connector end face polishes. Many of the microscopes sold today incorporate the ability to test to this IEC standard and many OTDR certifications now require this test to be included with the certifying scans. This standard can also be modified for a tighter or wider test specification. Each end face is separated into 4 zones (A, B, C, D) that each have their own pass/fail criteria. Even if a technician does not have access to newer equipment with built in analysis, a handheld microscope can offer assistance in verifying the end face is clean and free of any large debris. See figure at right for the location of each zone and pass/fail for IEC 61300-3-35.

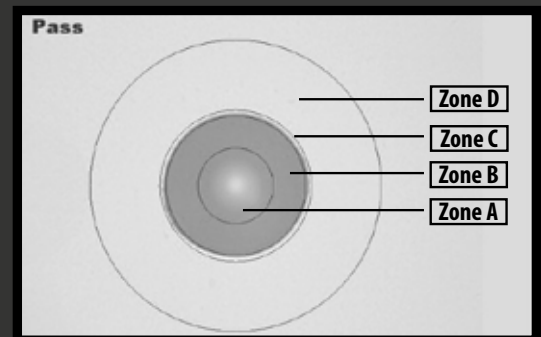

Zones	Scratches	Defects
<b>Zone A:</b> Core Zone	None	None
<b>Zone B:</b> Cladding Zone	No limit ≤ 3µm None > 3µm	No limit < 2µm 5 from 2 - 5µm None ≥ 5µm
<b>Zone C:</b> Adhesive Zone	No Limit	No Limit
<b>Zone D:</b> Contact Zone	No Limit	None ≥ 10µm



F1-1301T

## FIS PRECISION FIBER OPTIC STRIPPERS

FIS Precision Fiber Optic Strippers removes the 3mm jacket, 900µm tight buffer and 250µm buffer coating. Precision blades produce consistent clean strips. Tool length: 6.25 inches

PART #	DESCRIPTION	PRICE
F1-1301T	250µm, 900µm and 3mm Fiber Optic Stripper Three Hole	\$26.95



WO-1224

WO-1224D

WO1224T

## MILLER FIBER OPTIC STRIPPERS

The Miller Stripper is an exceptional tool recommended for stripping 250µm coated fiber and 900µm buffered fiber. The Miller Stripper has a .0055" (0.14mm) laser drilled hole, soft plastic-cushioned handle grip, and super accurate hardened stripping jaws, ensuring smooth clean stripping action.

PART #	DESCRIPTION	PRICE
WO-1224	Miller Stripper (Strips 250µm) (Miller PN F0103-S-250)	\$41.95
WO-1224D	Dual Hole Stripper (Strips 250µm or 900µm) (Miller PN F0103-D-250)	76.95
WO-1224T	Tri Hole Stripper (Strips 250µm, 900µm, 3mm Jacket) (Miller PN F0103-T-250-J)	79.95



46107

81300

The Miller CFS-2 Fiber Stripper has "Super Comfort" grips. Ergonomically enhanced handles for extra comfort and ease of use. Factory set and locked calibration screw puck provides for better and more precise strips every time. Replacement for Clauss.

PART #	DESCRIPTION	PRICE
46107	Miller CFS-2 Stripper (Strips 250µm or 3mm)	\$26.95
81300	Miller CFS-3 Tri-Hole Stripper (Strips 250µm, 900µm, 3mm Jacket)	29.95



JIC-200

## JONARD 200µm FIBER OPTIC STRIPPER

Jonard fiber optic stripper removes the 200µm-125µm buffer coating.

PART #	DESCRIPTION	PRICE
JIC-200	200µm Fiber Optic Stripper	\$33.95



PA1171

## PALADIN GRIP-STRIPPER

The multi-function fiber optic stripper from Tempo has five settings for stripping fiber optic cable. Strips outer jacket from 2.0-2.4mm cable, 2.8-3.0mm cable and 2.0-3.0mm loose tube buffer tubes. Strips 900µm buffer from loose buffer without removing acrylate coating. Strips buffer and acrylate from 900/125µm and 250/125µm fiber. Factory set and calibrated.

PART #	DESCRIPTION	PRICE
PA1171	ProGrip 5-in-1 Fiber Optic Stripper	\$52.95



45-352



## MINILITE-STRIP™

The MiniLite-Strip™ is small and features a V-notch to remove buffer and coating from 125µm fiber. An additional larger V-notch removes a wide range of outer cable jackets.

PART #	DESCRIPTION	PRICE
45-352	MiniLite-Strip	\$69.95



MS-FOK1

## MICRO-STRIP TOOL KIT

When working with optical fiber, you don't want your work to be compromised by accidentally damaging a fiber. The Fiber Optic Micro-Strip Tool Kit provides an easy and efficient way to strip fiber optic cable without nicking or damaging the optical fiber. Strips fiber buffers up to 900µm, and jackets up to 3.5 mm. Kit includes interchangeable/replaceable blades and tube guides.

PART #	DESCRIPTION	PRICE
MS-FOK1	Kit (10 blades for fiber range of 125µm to 900µm)	\$140.00
MS-1FS	Blade Holder	15.75
MS-1RB06S	Replacement Blade-Violet (Strips to 125µm)	36.95
MS-1RB12S	Replacement Blade-White (Strips to 250µm)	36.95
MS-1RB21S	Replacement Blade-Royal Blue (Strips to 500µm)	36.95



F1-9999

## THERMAL FIBER OPTIC STRIPPER

The "Soft-Strip" Thermal Stripping Tool contains a heating element that softens and strips 900µm coatings. The thermal stripper permits precise stripping of these tough coatings with less than 1 lb. of peak pulling force for a single optical fiber. Excellent for use on fiber optic couplers and other delicate components. Uses two "AA" batteries, not included.

PART #	DESCRIPTION	PRICE
F1-9999	Thermal Fiber Stripper	\$195.00

**MILLER FTS SERIES FIBER TUBE SCORERS**

Precise, one-step buffer tube scorer. Fixed, hardened carbon steel blade requires no adjustments. FTS body comprised of strong & resilient acetal polymer. Precise jacket removal of PE, PVC and rubber jacket. (Note: FIS sells armor strippers separately.)

PART #	DESCRIPTION	PRICE
80990	FTS-005 (red), Tube size up to 2mm, wall thickness 0.13 to 0.25mm	\$18.95
80980	FTS (yellow), Tube size 1.6 to 6mm, wall thickness 0.229 to 0.381mm	18.95
80985	FTS-035 (blue), Tube size 1.6 to 6mm, wall thickness 1.0 to 1.3mm	18.95

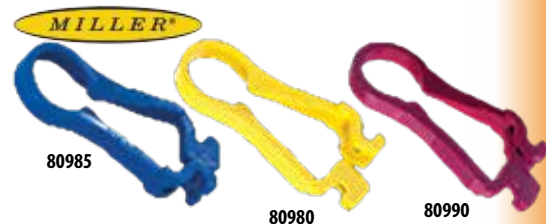

**BUFFER TUBE RINGER/SPLITTER**

Buffer Tube Ringer/Stripper with adjustable blades can be set for any depth to help assure nick-free jacket entry. Use for simplex fiber and a variety of fiber optic cables up to 1/8 inch diameter. Loose tube fiber demands a precision tool capable of cutting different buffer tube diameters without nicking the enclosed fiber. Also available is the blue buffer tube stripper for cable from 1/8 inch to 7/32 inch.

PART #	DESCRIPTION	PRICE
F1-0017	Grey Buffer Tube Stripper (For Fiber/Coax Applications)	\$26.95
F1-0021	Blue Buffer Tube Stripper (For Fiber/Coax Applications)	21.95
F1-0018	Replacement Blades (1 Set of 4 Blades)	11.95

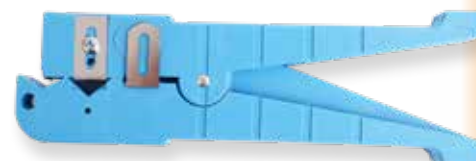

**BIG BLUE CABLE RINGER**

Strips round cable .250-.563 inches (6.4mm to 14.3mm) diameter. Adjustable blade, 1 or 2 step stripping, plus jacket slitting. .560 inch (14.22mm) blade spacing, rounded edge slitting blade included.

PART #	DESCRIPTION	PRICE
45164	Multicable Coax/Fiber Ringer Tool	\$56.95
L9226	Replacement Blade Set	17.00

45164



**MILLER ROUND CABLE SLITTERS**

The Miller Round Cable Slitters are manually operated cutting devices designed for fast, safe and precise jacket removal of PE, PVC and rubber jacket. The F1-114 is designed to strip cables from 4.5mm to 29mm Diameter. The F1-158 is designed to strip cables from 19mm to 40mm Diameter.

PART #	DESCRIPTION	PRICE
F1-114	Round Cable Slitter (4.5mm to 29mm diameter)	\$50.00
F1-158	Round Cable Slitter (19mm to 40mm diameter) (not pictured)	89.95
F1-231	1 Replacement Blade	16.95



\*Not for use with armored cable

The Round Cable Slitter removes outer jackets and insulations from 4.5mm to 28.5mm O.D. Stripping action is both circumferential, then longitudinal for removal of insulation section at the end or mid-span of wires. Adjustable depth up to 3mm. Weight: 4.2oz, Dimensions: 135 x 40 x 15mm.

PART #	DESCRIPTION	PRICE
MK02	Round Cable Slitter	\$35.95
39391	Spherical Cutting Replacement Blades	29.95

**TEMPO COMMUNICATIONS UNIVERSAL SLITTER**

Slit/Strip/Remove 0.18" (4.5mm) - 0.984" (25mm) diameter 500-1200-MCM power/telecom round cables rubber/PVC/nylon insulation. For mid-point taps. Cable support arm, stainless steel blade.

PART #	DESCRIPTION	PRICE
PA1822	Tempo Communications Universal Slitter	\$35.95



**OPTICAL FIBER SHEATH STRIPPER AND RING TOOL**

Used for stripping and butting tight buffer optical fiber cables. Use one blade to butt PVC sheathing and use the second blade to strip the sheathing. Adjustable for .018" or .031" thick plastic, rubber or fabric insulation.

PART #	DESCRIPTION	PRICE
JIC-4366	Optical Fiber Sheath Stripper	\$64.95



**ARMORED CABLE SLITTER AND CUTTER**

This tool slits outer polyethylene jacket and armor in one operation. Performs longitudinal slitting and circumferential (ringing) for end stripping. Blade rotates 90° by activating blade lever, allowing easy mid-span preparation (ringing and splitting) – Replacement blades available. Adjusts from 8-28.6mm OD.

PART #	DESCRIPTION	PRICE
F1-ACS	Armored Cable Slitter (8mm - 28.6mm cable OD's)	\$180.50
F1-ACS2	ACS-2 for smaller OD's (4mm - 10mm cable OD's)	188.00
F1-CB251K	Replacement Blade for F1-ACS and F1-ACS2	55.00
MB05-7000	ACS Plus Armored Cable Slitter (4 to 28.6 mm)	130.32





## KEVLAR® CUTTERS

When cutting Kevlar®, you need a cutting tool with very durable blades. You also want the tool to cut cleanly, and to fit comfortably in your hand. FIS offers six Kevlar® cutters that fit the bill. The Kevlar® cutter, F1-KS1, features serrated blades and high leverage cutting, utilizing long cushioned handles. The Miller Kevlar® cutter, F1-9809, also features serrated blades and cushion handles.

PART #	DESCRIPTION	PRICE
F1-00201	Economy Kevlar® Cutters (Metal Blade)	\$5.95
F1-KS1	Miller Scissors (Carbon Molybdenum and Vanadium Steel Blade)	16.50
F1-6430	Kevlar- Cutters (Carbon Steel Blade)	28.95
F1-9809	Miller Kevlar® Cutters (Steel Blade) (Not Pictured)	31.95
KC699	Kevlar Scissor (Miller PN 46175) (Not Pictured)	15.95

## MILLER SCISSORS/SPLICER KIT

Ergonomic snip for linemen and installers. One blade features ergonomically shaped, and cushioned palm rest.

PART	DESCRIPTION	PRICE
925CS-ERGO	Ergonomic Scissor/Splicer Snips	\$21.95
925CS	Traditional Serrated Scissor	16.95
925CS-KIT	Splicer's Kit	40.95

## T-STYLE JACKET STRIPPER

The dual "V" notch blade allows the quick removal of outer jacket. Plier nose, along with cushion grips and spring release are additional features making this stripper comparable to the Ideal T-Type® Stripper.

PART #	DESCRIPTION	PRICE
F1-0016	T-Style Stripper, 16-26 AWG	\$8.95
1917SS	Greenlee Stripper, 16-26 AWG	16.95

## US CONEC RIBBON STRIPPER

The US Conec Optical Cable Jacket Removal Tool eliminates the need for sharp tools such as Exacto® knives or razor blades for cable jacket removal. The tool is designed for quick, reliable, economical removal of PVC jacket from ribbon interconnect cable, 3mm round cable and 2 fiber zipcord.

PART #	DESCRIPTION	PRICE
F1-2009	US Conec Ribbon Stripper	\$30.00

## US CONEC DISPOSABLE RIBBONIZERS

The disposable ribbonizing tool utilizes a quick cure cyanoacrylate adhesive to provide a low-cost, robust ribbonization option. This solution is ideal for applications requiring excessive handling and multi-row termination applications.

PART #	DESCRIPTION	PRICE
14316	US Conec Disposable Ribbonizer, 12F, White, 10+ uses	\$0.85
14682	Disposable Ribbonizer, 8F, Purple, 10+ uses	0.85
16764	Disposable Ribbonizer, 4F, Gray, 10+ uses	0.85

## CORNING RIBBON SPLITTING TOOL

The tool closes around the ribbon fibers, as the ribbon settles into the proper slot. With actuator depressed, the tool slides along a length of the ribbon, separating the length of ribbon that is needed into smaller ribbon counts. The tool has slots to separate the ribbon into the following smaller ribbon counts: 2/2, 2/4, 2/6, 4/4, 2/10, 4/8, 6/6, and 12/12.

PART #	DESCRIPTION	PRICE
RST-000	Corning Ribbon Splitting Tool	\$1,500.00

## AFL FAT-04 FIBER ARRANGEMENT TOOL RIBBONIZER

The FAT-04 features an easy-to-use fiber arrangement method utilizing linear travel. The FAT-04 includes a spare paste applicator to allow ribbon making to continue even if one of the paste applicators needs cleaning.

PART #	DESCRIPTION	PRICE
S010212	AFL FAT-04 Fiber Arrangement Tool Ribbonizer	\$505.00
S008622	FAA-03A ribbon-forming adhesive (0.5 liter bottle)	160.00
S008720	FAA-03A ribbon-forming adhesive (4 oz. dispensing bottle)	50.00

## FITEL DE-RIBBONIZER

The S220A uses two finely positioned blades to shave the matrix off the top and bottom of ribbon fiber while leaving the individual fiber jackets untouched. After the matrix is removed, the fibers separate out easily by hand. For use with 300 and 400µm ribbons of 2 to 12 strands. Blade life is 1,000 separations.

PART #	DESCRIPTION	PRICE
S220A	Fitel De-Ribbonizer	\$735.00

## RIBBON STRIPPING KIT

This unique thermal stripping kit includes the patented "Soft-Strip" thermal stripping system and contains components for stripping from 4 to 12-fiber ribbon of various constructions: 'Bonded', 'Encapsulated' or 'Ribbonized' types. AC adapter sold separately.

PART #	DESCRIPTION	PRICE
MS-SK-1	Ribbon Stripping Kit	\$525.00
MS-T3	120 Volt AC Adapter for Thermal Stripper	45.00



**CORNING CABLE SYSTEMS MID-SPAN ACCESS TOOL**

Cutting a buffer tube mid-span without damaging the optical fibers inside requires a specialized tool. Simply attach the tool and pull it along the buffer tube to slit the tube safely.

PART #	DESCRIPTION	PRICE
OFT-000	For 2.4mm - 3.0mm Tubes CCS Mid-Access Tool	\$326.75
OFT-001	Replacement Blade for OFT-000	22.95
UAT-3000	For 4.5mm - 22.0mm Tubes Enhanced Universal Access Tool	1,396.25
UAT3-BLADES	Replacement Blade for UAT-3000	100.00

**MILLER MID-SPAN ACCESS TOOL**

The Miller Mid-Span Access Tool (MSAT-5) is used to quickly and easily to access fibers in 1.9mm to 3mm buffer tubes in a mid-span location without damage to fiber. No blade adjustment is necessary.

PART #	DESCRIPTION	PRICE
MSAT-5	Mid-Span Access Tool	\$85.50
80935	Replacement Blade (Spk)	17.95

**MILLER MID SPAN ACCESS TOOL**

The new MSAT™ 16, an exciting new solution designed to easily access fibers in buffer tubes ranging from 1 to 3 mm diameters in mid-span applications.

PART #	DESCRIPTION	PRICE
MSAT16	Mid-Span Access Tool	\$120.00

**MILLER MID-SPAN ACCESS TOOL**

This tool can access fibers in 2.0mm, 2.5mm, and 3.0mm buffer tubes. Buffer tube size gauges are located on the tool body for ease of selecting proper tube slitting channel.

PART #	DESCRIPTION	PRICE
80785	Mid Span Tool	\$315.00

**MID SPAN DROP CABLE SLITTER**

The MS-26 Mid Span Slitter is designed to open fiber jackets and loose buffer tubes (2.9mm to 6.8mm) for easy fiber access.

PART #	DESCRIPTION	PRICE
MS-6	Mid Span Drop Cable Slitter, 1.2mm to 3.3mm	\$60.95
MS-26	Large Mid Span Drop Cable Slitter, 2.9mm to 6.8mm	79.60
MS-326	Micro Duct Fiber Cable Slit And Ring Tool	94.75
MS-426	Mid Span Slit & Ring Tool (5.8mm-12mm)	135.95

**MILLER MSAT-X DUAL CHANNEL FIBER ACCESS TOOL**

Our next-generation MSAT-X mid-span tool for MDU and FTx application allows technicians to safely and accurately shave cables of 1.9 - 5mm diameter.

PART #	DESCRIPTION	PRICE
MB10-7000	Dual Channel Fiber Access Tool	\$82.54

**MILLER MBO2 ALL PURPOSE CABLE SLITTER**

The ergonomic and multi-purpose Miller® MBO2 is a precision slitter designed to perform accurate ring and longitudinal cuts on various dielectric cables up to 0.60" (15.25 mm) in diameter.

PART #	DESCRIPTION	PRICE
MB02-7001	All Purpose Purpose Cable Slitter	\$104.36

**AFL WRAPPING TUBE CABLE (WTC) CABLE ENTRY TOOL**

This tool is designed to help efficiently open Wrapping Tube Cable in both end prep and mid sheath entry. The blade angle and tool shape help prevent the blade from cutting too deep.

PART #	DESCRIPTION	PRICE
CS014530	WTC Cable Entry Tool	\$160.00

**MILLER FLAT DROP CABLE SLITTER**

The unique articulating hinge allows accurate end and mid-span stripping without disassembling the tool -- simply close the tool over the cable and pull to slit the jacket. Included are two reversible blades plus two additional replacement blades stowed in tool.

PART #	DESCRIPTION	PRICE
MB04-7000	Flat Drop Slitter With 2 Installed Blades And 2 Spare Blades	\$44.25

**DROP CABLE SLITTER**

The FOD-2000 Fiber Optic Drop Cable Slitter is a patent pending tool that simplifies the slitting of drop cable jackets at the end of the cable or mid-span. The FOD-2000 puts a slit on both sides of the jacket allowing easy access to the fiber or strength member.

PART #	DESCRIPTION	PRICE
FOD-2000	Drop Cable Slitter	\$46.95
FOD-RB25	Replacement Blade for the FOD-2000 (Pack of 25)	41.60

**DRAKA BUFFER TUBE ACCESS TOOL**

This tool is designed for mid-span entry to fibers in a multiple of buffer tube sizes. The tool "shaves" only the tube wall to access the fibers providing safe, and reliable access. The tool kit includes interchangeable inserts supporting 2.5mm, 2.7mm and 3.0mm buffer tubes. **Includes:** Tool, Carry Case, Inserts, Spare Blade and Spare Head Screw

PART #	DESCRIPTION	PRICE
20021562	Buffer Tube Access Tool	\$950.00

**Replacement Blades Are Available for All Mid-Span Access Tools.**

**Call your Sales Representative or go to [www.fiberinstrumentsales.com](http://www.fiberinstrumentsales.com) to purchase.**

**CORNING**



UAT-3000



MSAT-5



80785

MSAT16

**JONARD TOOLS**



MS-6



MS-426



MB02-7001



**AFL**



CS014530



MB10-7000



FOD-2000



MB04-7000



**Draka**

20021562



## FIS DELUXE DIAMOND SCRIBE

Housed in a deluxe metal casing, The Deluxe Diamond Scribe offers a retractable 60° cone point.

PART #	DESCRIPTION	PRICE 1-5	PRICE 6+
WO-1223	FIS Deluxe Diamond Scribe	\$17.95	\$17.00



## FIS ECONOMY DIAMOND SCRIBE

This Economy Scribe has a 60° cone point and is housed in a rugged white plastic housing.

PART #	DESCRIPTION	PRICE 1-5	PRICE 6+
FO-90-C	FIS Economy Diamond Scribe	\$8.25	\$7.85



## FIS SAPPHIRE SCRIBE

For a wider cutting surface, this scribe offers a 90° wedge. Housed in a deluxe metal casing.

PART #	DESCRIPTION	PRICE
FO-90-S	FIS Sapphire Scribe	\$22.95



## FIS 90° WEDGE DIAMOND SCRIBE

Provides a wider cutting surface. The 90° Wedge Diamond Scribe is packaged in a rugged blue plastic housing.

PART #	DESCRIPTION	PRICE
FO-90-W	FIS 90° Wedge Diamond Scribe	\$36.95



## FIS CARBIDE SCRIBE

This Carbide Scribe offers a wide cutting surface in a plastic pen-like housing.

PART #	DESCRIPTION	PRICE
F1-9773	FIS Carbide Scribe	\$23.00



## IDEAL SCRIBE TOOLS

All three Ideal Scribes offer 30° beveled DualScribe™ reversible blades doubling the tools' useful life. Non-slip grips offer precise control during scribing. Clear safety caps protect blades when not in use.

PART #	DESCRIPTION	PRICE
45358	Sapphire Blade DualScribe™ (blue handle)	\$38.65
45357	Ruby Blade DualScribe™ (red handle)	39.25
45359	Carbide Blade DualScribe™ (black handle)	59.25

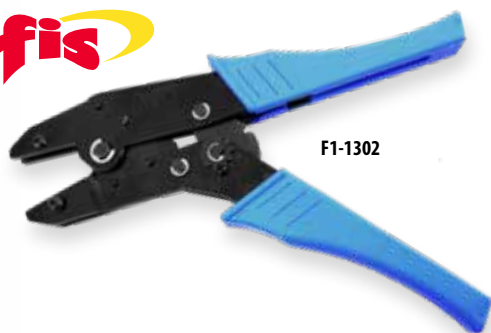

## FIS FIBER OPTIC CRIMP TOOLS

The FIS Crimp Tool is designed to successfully assemble a variety of connector styles for maximum optical performance and mechanical strength. This tool can be purchased as just a handle or with an included die for either SC/ST/FC or LC/MU connectors. (Crimp tool die measurements are in inches)

PART #	DESCRIPTION	PRICE
F1-1302	FIS Crimp Tool Handle	\$45.00
F1-3227	FIS Crimp Tool Die and Handle SC/ST/FC (.128, .137, .151, .190)	66.95
F1-8825	FIS MU/LC Crimp Tool and Die (.120 round, .128 Hex)	99.95
PA-2043	MU/LC Crimp Tool and Die (.151 round, .178 round, .213 round)	45.00



## FIS CRIMP TOOL DIES

PART #	DESCRIPTION	PRICE
F1-8825LM	FIS MU/LC Crimp Die (.120 Round, .128 Hex) (fit on FIS Crimp Tool F1-1302)	\$61.25
F1-3227M	FIS Crimp Tool Die (.128, .137, .151, .190) (fit on FIS Crimp Tool F1-1302)	45.00
PA-2051	Triple Hex Die (.068, .128, .178)	45.00



## ADDITIONAL CRIMP TOOLS

PART#	CONN. MFG	CONNECTOR TYPE	PRICE
6365CT	Corning Optical Communications	SC/FC	\$172.95
320103101	CCS	SC/ST/FC	230.00

**MAGNIFYING GLASSES**

Protect your eyes and see fiber with ease with the dual purpose Magna-Focuser. These glasses magnify objects 2.5 times, providing a critical visual advantage which still allows user both hands free. Perfect for individuals who find it difficult to work with small parts.

PART #	DESCRIPTION	PRICE
F1-1105	Magna-Focuser	\$21.95



**FIS EYE LOUPE SET**

Set includes 2X, 3X, 5X, 7X and 10X magnifications, these eye loupes allow users to make preliminary inspection of connector mating surfaces for dirt and scratches. The five piece set is made of durable lightweight plastic which makes it an excellent value.

PART #	DESCRIPTION	PRICE
98722	Eye Loupe Set	\$5.95



**RATCHETING CABLE CUTTERS**

The Ratcheting Cutter is great for aluminum armor, not intended for ACSR. Cuts up to 35mm diameter.

PART #	DESCRIPTION	PRICE
F1-900759	Greenlee Fully Ratcheting Cable Cutter	\$276.95

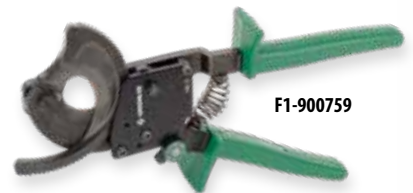

**HIGH LEVERAGE CABLE CUTTERS**

This is a utility cable cutter for up to 70mm cable. This manual tool is great for standard power, coaxial, and non-armored cables.

PART #	DESCRIPTION	PRICE
F1-727	Greenlee Cable Cutters	\$39.95



**SIDE CUTTING PLIERS**

The 6" side cutting pliers feature 1" cutting head for flush cutting, dual color cushioned handles and are manufactured of hardened steel.

PART #	DESCRIPTION	PRICE
0251-06D	Greenlee 6" Side Cutting Pliers	\$25.00



**LINEMAN'S B SIDE CUT PLIERS**

These pliers are high leverage for cutting bolts, nails, and many gauges of wire including high-strength wire. Cutting edges cut clean and remain sharp.

PART #	DESCRIPTION	PRICE
0151-08D	Greenlee 8" High Leverage Side Cutting Pliers	\$36.95



**UTILITY KNIVES**

PART #	DESCRIPTION	PRICE
0652-11	Greenlee Utility Knife - Molded for secure, comfortable grip, retractable 3-position blade for safety and convenience, pop-up holder for blade storage	\$12.50
9952-11	Replacement Blades (5pk)	4.95
0652-23	Greenlee Folding Utility Knife - High finish stainless steel handle with molded features for added comfort in rugged environments, 10 extra blades	25.00



**6" LONG NOSE SIDE CUTTING PLIERS**

- Forged from chrome vanadium steel for greater durability and strength
- Cuts both solid and stranded copper wire
- Serrated jaws and laser-hardened cutting edges
- Through-hardened steel for longer life
- Rugged riveted construction for smooth precise action

PART #	DESCRIPTION	PRICE
0351-06M	Greenlee 6" Long Nose Side Cutting Pliers	\$25.00





F1-IRD5-36



F1-IRD5-35



F1-SF1

808060



FOC-100



PA1900



0253-01C



F1-0911DH

F1-0912



FITMINIGUN



F1-5527

## FIS LASER SAFETY GLASSES

These high quality safety glasses employ superior laser safety lens technology. Laser protective dyes are molded into the plastic and will not scratch off, photobleach or degrade over time. The lenses protect from light wavelengths in the range of 800-1790nm. Glasses come with a protective carry case, lanyard and cleaning cloth. There are 2 styles to choose from: standard wrap-around and over-the-glasses. These are proudly made in the USA.

PART #	DESCRIPTION	PRICE
F1-IRD5-36	FIS Laser Safety Glasses, Over-The-Glasses Style, Adjustable Frames	\$135.95
F1-IRD5-35	FIS Laser Safety Glasses, Wrap-Around Style, Adjustable Frames	135.95

## INSERTION/EXTRACTION TOOLS

The Fiber Optic Connector Insertion/Extraction Tools are capable of reaching into very tight spaces to perform tasks. They have been designed to work with virtually all rectangular or square cross-section connectors.

PART #	DESCRIPTION	PRICE
F1-SF1	Extraction Tool	\$62.85
808060	Miller Extraction Tool	43.50

## FOCUS™ REMOVAL TOOL

The Focus™ removal tool from Cable Prep® inserts and removes SC and LC fiber optic connectors without disturbing adjacent connectors, even when working in densely populated panels.

PART #	DESCRIPTION	PRICE
FOC-100	Focus Removal Tool	\$58.95

## CAN WRENCH

- Strips PVC insulation, outer jacket of AWG22/4 and 24/4 telephone cable, insulation of AWG 22 (.34 mm2) and AWG 24 (.20 mm2) wire
- Durable shock-resistant design
- 3/8" (9.5 mm) and 7/16" (11 mm) hex sockets for accessing panels

PART #	DESCRIPTION	PRICE
PA1900	Can Wrench	\$16.95

## 7pc. NUT DRIVER / SCREW DRIVER SETS

The sets have rugged hollow shafts and heavy duty construction for longer life. Handles and shafts marked for easy identification of nut driver size.

**Nut Driver Set Contains:** 3/16", 1/4", 5/16", 11/32", 3/8", 7/16", and 1/2" Nut Drivers with 3" Shank

**Screw Driver Set Contains:** 3/16"x4", 3/16"x6" and 1/4"x4" Cabinet Tips, 1/4"x4" and 5/16"x6" Keystone Tip, #1x3" and #2x4" Phillips Tip

PART #	DESCRIPTION	PRICE
0253-01C	7pc. Nut Driver Set	\$50.00
0153-02C	7pc. Screw Driver Set	52.95

## HEAT GUN

The FIS Heat Gun is designed to shrink splice protection sleeves or breakout kit shrink tube. The heat gun provides a variable temperature range adjustment, allowing the user to apply the required heat.

PART #	DESCRIPTION	PRICE
F1-0911DH	FIS Digital Heat Gun 110V	\$46.50
F1-0912	FIS Heat Gun 220V	218.00

## SHRINK TUBE KIT

A complete, compact kit that includes a lightweight, portable heat gun and a variety of multicolored heat shrinkable tubing in six-inch cut pieces. Used for splicing, identification, cable repair.

PART #	DESCRIPTION	PRICE
FITMINIGUN	Portable Heat Gun Kit with variety pack (110V Only)	\$145.00
FIT221	Variety Pack Refill (60 - 6" cut pieces)	55.00

## COLORLED SHRINK TUBES

The 13mm and 26mm are quality shrink tubes that contain adhesive inside of the tubes (black tubes only). All shrink tubes have a shrink ratio of 2:1.

PART #	DESCRIPTION	PRICE
F1-5527-GN	Green Shrink Tube (3/16")	39¢ /ft
F1-5527-RD	Red Shrink Tube (3/16")	39¢ /ft
F1-5527-BL	Black Shrink Tube (3/16")	39¢ /ft
F1-5527-YE	Yellow Shrink Tube (3/16")	39¢ /ft
F1-5527-13A	13mm Black Adhesive Shrink Tube	95¢ /ft
F1-5527-26A	26mm Black Adhesive Shrink Tube	\$1.75 /ft

**CABLE PULLING LUBRICANT**

Polywater CGL Lubricant is a high performance gel lubricant for fiber optic, copper or coaxial cable pulls. It clings to cable for long distance horizontal pulls. The lubricant is compatible with PE and LSZH communication cable jackets. UL listed.

PART #	DESCRIPTION	PRICE
CGL-35	1 Quart Squeeze Bottle Polywater Lubricant CGL	\$10.25
CGL-128	1 Gallon Bucket Polywater Lubricant CGL	26.95
CGL-640	5 Gallon Bucket Polywater Lubricant CGL	100.85



CGL-35

FTTX-35LR

**POLYWATER FTTX LUBRICANT**

High Performance concentrated silicone lubricant that is fast drying to eliminate the "insertion loss" effect on data cables. Sprays easily in a stream to reduce mess during installation. Dries fast at the receiving side for quick splice or termination. Effective for fabric woven innerduct applications

PART #	DESCRIPTION	PRICE
FTX-35LR	1 quart Spray Bottle Polywater Lubricant FTTx	\$25.00



TracerTape™

**TRACERTAPE™**

TracerTape™ is a functional product that is used for locating, pulling and measuring your duct and fiber. The TracerTape incorporates a solid corrosion resistant copper conductor which provides easy detection. Call for double wire tracer tape.

PART #	DESCRIPTION	TENSILE/LBS.	PRICE
WPT1250	3,000 ft. Single Wire Reel	1,250 lbs.	\$260.00

**GREENLEE PULLING LINES**

Greenlee 595 Nylon Fish Line is strong, and lightweight. It is center feed for fast payout without tangling and is mildew-resistant. It can be pulled into the run with the wire to provide a means to add wires later. Greenlee 430 Poly Line is ready-to-use, pre-punched hole in lid with resealable cap. Can be used with power fishing systems directly from the container. It resists tangling when dispensing. It is rot and mildew resistant.

PART #	DESCRIPTION	PRICE
595	2,150' Center Feed Fish Line	\$45.00
430	6,500' Poly Line	75.00
430-500	500' Poly Line	15.00



430-500

430

**DURAWHEEL**

The DuraWheel is ideal when you need to measure distances that are beyond the length of measuring tapes. Designed for rugged commercial use, the DW-PRO comes with a case, pistol grip brake and counter controls.

PART #	DESCRIPTION	PRICE
DW-PRO	DuraWheel Pro (12.5" wheel diameter) (feet)	\$175.00



DW-PRO

**GREENLEE FISH POLES**

Greenlee has the most innovative fishing systems designed to perform on the jobsite. Whether you're going a few short feet or through many walls and bends, having Greenlee's Fish Pole products on the jobsite will make the job easier for any commercial, industrial or utility application. These lightweight, durable poles are designed for both pushing and pulling cables and allow for use in cramped spaces.

PART #	DESCRIPTION	PRICE
540-15	Glo Stix Kit, 3/16" dia, (3) 5ft sections, 15 ft overall length	\$65.95
11427	Glo Stix's Replacement Section, 3/16" dia, (3) 5ft sections, 15 ft overall length	27.95
11426	Whisk Nose Tip	17.95
10497	Hook Nose Tip	11.95
10498	Bullet Nose Tip	9.95
FP12	12 Foot Fish Pole	86.50
FP18	18 Foot Fish Pole	135.00

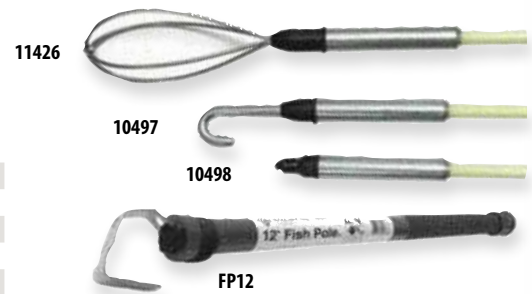

11426

10497

10498

FP12

**CABLE CASTER**

This hand held device enables installers to fire a dart with pull rope up to 50 ft. Monofilament line attached to the dart is projected out from a take-up reel on the Cable Caster. Pull strings or ropes can be attached to the monofilament line and reeled back to the installer.

PART #	DESCRIPTION	PRICE
F1-9112	Cable Caster Installation Tool	\$79.95
F1-6259	Cable Caster Darts (4 Pack)	9.50



F1-9112

**FIS CABLE DISPENSER**

Cable Dispenser locks into an open position on padded, anti-skid legs that can not collapse. A removable, 5/8" solid spindle, capable of holding over 200 lbs., allows for simple installation of cable reels up to 25" in diameter and 16" in width.

PART #	DESCRIPTION	PRICE
F1-6111	Cable Dispenser	\$265.00



F1-6111



## FIS FIBER OPTIC TIE WRAPS

It's easy for installers to over-cinch thin zip ties, resulting in macrobends that attenuate fiber optic cables. With copper cables, the weight of cables pressing against thin ties can damage or deform them enough to create crosstalk issues. To solve these problems, FIS created the Universal Cable Strap with Foam Padding. FIS Fiber Optic Tie Wraps are 1" wide and 12" long, and they are available in your choice of colors. Substitute "X" with color of your choice: AQ = Aqua, BK = Black, BL = Blue, GR = Green, OR = Orange, and YE = Yellow.

PART #	DESCRIPTION	PRICE
FOTW-X-6	Tie Wrap with Foam Padding (Pack of 6)	\$8.50
FOTW-X-50	Tie Wrap with Foam Padding (Pack of 50)	68.00
FOTW-X-100	Tie Wrap with Foam Padding (Pack of 100)	135.00

## FIS BASIC FIBER OPTIC TIE WRAPS

The FIS Basic Fiber Optic Tie Wrap is just like the current FIS Fiber Optic Tie Wrap offer, but without the padding. It is designed for communications cable with the wide design profile and reusable nature. FIS Basic Tie Wraps are 1" wide and 12" long, and they are available in your choice of colors. Substitute "X" with color of your choice: AQ = Aqua, BK = Black, BL = Blue, GR = Green, OR = Orange, and YE = Yellow.

PART #	DESCRIPTION	PRICE
BTW-X-6	Basic Tie Wrap (Pack of 6)	\$4.75
BTW-X-50	Basic Tie Wrap (Pack of 50)	35.00
BTW-X-100	Basic Tie Wrap (Pack of 100)	68.00



## VELCRO® Brand ROLL

This VELCRO® Brand Roll dispenses just like a tape roll and can be cut to the desired length. The center core of the roll has a male/female Velcro patch attached, which enables the roll to be affixed to any ladder or steel surface for convenient dispensing.

PART #	DESCRIPTION	PRICE
F1-VROLL	75' Velcro® Brand Roll 3/4" Black with Center Core	\$25.95



## HOOK AND LOOP FASTENER TIE WRAP

Protect your Fiber Optic and Category cable from over cinching with tie wraps. These low-cost wraps are reusable and are available in red and black. Now provided with cutout for screw mount support.

PART #	DESCRIPTION	PRICE
CT733	Red Tie Wrap 1"x 8" (75 pk)	\$29.95
CT255	Black Tie Wrap 1"x 8" (75 pk)	26.95
CT-3105	Black Tie Wrap 3/4" x 5" (25 pk)	9.95
CT-3108	Black Tie Wrap 1"x 8" (25 pk)	9.95
CT-3012	Black Tie Wrap 1"x 12" (25 pk)	15.00

Connector and Cable Clamps



F1-6209

## CONNECTOR AND CABLE CLAMPS

The ability to secure a connector or cable to a desired location is possible with this adhesive backed clamp. Re-enterable and adjustable up to 5/8".

PART #	DESCRIPTION	PRICE
F1-6209	Connector and Cable Clamps	.40¢
F1-13187	Cable Holder (package of 10)	\$6.95

F1-9124



Expandable Fiber Bracket

## EXPANDABLE FIBER BRACKET

Designed to hold up to six 3.0mm fiber optic cables, this bracket provides expansion capabilities to fiber optic systems. Made from flame retardant nylon, cables snap into grooves without damaging the fiber.

PART #	DESCRIPTION	PRICE
F1-9124	Expandable Fiber Bracket (Package of 10)	\$2.75



## TIE WRAPS

Available from FIS are two sizes of tie wraps. The 4" long by 1/8" wide wrap is excellent for securing simplex or duplex cable. The 7" long by 3/16" wide wrap is designed to handle wrap diameters up to 1-1/4".

PART #	DESCRIPTION	PRICE
T18S	4" Tie Wraps (100 pk)	\$2.25
T50S	7" Tie Wraps (100 pk)	3.25

CCS-0601



CCS-0201

## CABLE CLAMPS

Use the Cable Clamp to organize copper or fiber cords and bulk cable. These clamps are available in 2 sizes: small (holding up to 1" in diameter), and large (up to 3").

PART #	DESCRIPTION	PRICE
CCS-0601	Small Cable Clamp (color red)	.85¢
CCS-0201	Large Cable Clamp (color blue)	\$1.60

**DYMO RHINO™ INDUSTRIAL 5200 HARD CASE KIT**

Rugged, versatile, and packed with time-saving features, the Rhino™ 5200 meets key ANSI and TIA/EIA 606-A labeling standards – and labels up to 77% faster than the competition. Proprietary Rhino “Hot Key” to automatically size, space and format text for perfect patch panel labels – then press another to print matching cable flags or face plate tabs, without retyping. Print module and fixed-length labels, horizontal and vertical wire wraps, terminal and 110 blocks and much more. Print Code 39 and Code 128 barcodes. Access 100+ industry symbols, fractions, and punctuation marks with a few quick keystrokes. Add the optional quick-charging lithium-ion battery for uninterrupted productivity.



**Kit Contents:** Rhino Industrial 5200 Label Maker, 3/4" White IND Vinyl Label Cartridge, 3/8" White IND Vinyl Label Cartridge, User Manual CD-ROM, Quick Reference Guide, AC Adapter, Carry Case, Rechargeable Lithium-ion Battery.

PART #	DESCRIPTION	PRICE
1756589	RHINO 5200 Hard Case Kit	\$389.00

**DYMO RHINO™ ACCESSORIES**

PART #	DESCRIPTION	PRICE
DY18443	RHINO 3/8" White Vinyl Label Cartridge	\$25.00
DY18444	RHINO 1/2" White Vinyl Label Cartridge	27.25
DY18488	1/2" Flex Nylon - Black/White Label Cartridge	31.45

**CABLE MARKER TAPE DISPENSER**

A dispenser holding 10 rolls of tape, numbered 0-9, gives you the ability to tag patch cables in your fiber optic system for easy identification. The 0-9 rolls of tape may be purchased under a separate part number. **Replace "X" with desired number 0-9 for replacements.**

PART #	DESCRIPTION	PRICE
STD09X	ScotchCode Wire Marker Dispenser with Tape STD-0-9	\$51.50
SDR09	Numerical marker, numbers 0 through 9	29.85
SDRX	Replacement Reel, individual numbers 0-9 (Replace "X" w/ individual number)	2.98



**DID YOU KNOW...**  
**LABELING STANDARDIZATION**



ANSI/TIA-606-B is a voluntary standard that establishes the labeling and record keeping standards for telecommunications and network systems in industrial, residential, and healthcare facilities. It identifies what needs to be labeled and provides a recommended identification scheme that is harmonized with the ISO/IEC TR14763-2-1 international identification scheme.

**The labeling principles that underlie 606-B include the following:**

- Labeling must be logical and consistent, across all locations, matching the project drawings.
- The labeling scheme must identify the associated physical locations (building, room, cabinet, rack, port, etc.)
- Labeling must be easily read, durable, and capable of surviving for the life of the component that was labeled.
- The labeling system, and the identifiers used, must be agreed upon by all stakeholders.
- Labeling should be pervasive; cables and connecting hardware should be labeled, but so should conduits and firestops, grounding and bonding locations, racks, cabinets, ports, and telecommunications spaces.

These principles are then translated into specific requirements.

**Requirements For Labels**

- All labels must use a permanent identifier that can be easily traced — that is, a useful numbering scheme. This scheme must be logical in its organization, using alphanumeric characters for ease of reference.
- Each cable and each pathway must be labeled on each end, and each label should identify the termination points of both ends of the cable.
- All labels must meet requirements for legibility, defacement, and adhesion, specified in UL969.
- Labels for station connections may appear on the face plate.
- All jack, connector, and block hardware may be labeled on either the outlet or panel.
- All labels must match up with the permanent record.

Custom Prints Available



F1-Alum



F1-Flex



F1-Dome

## SIGNS/POSTS

Baked enamel aluminum sign with clear protective coat forms extra UV and fade resistance. Fiberglass flexible marker post, 6ft, orange, with 2.875" x 13" vinyl/teldar label applied. No anchors are included. Dome marker post, 6ft, orange cap printed with black graphics.

PART #	DESCRIPTION	PRICE
F1-Alum	Aluminum Sign, 9" x 12", black on orange	\$35.25
F1-Flex	Flexible Line Marker Post, 3" x 6', orange	48.00
F1-Dome	Domed Marker Post, 3" x 6', orange cap, white pipe	36.95

Custom Prints Available



## "WARNING" "BURIED FIBER OPTIC CABLE" MARKER

Clearly identify vulnerable underground assets with durable ground-level markers. Made of long-lasting and damage-resistant plastic, soil markers are perfect for urban, high-traffic, or other locations where posts and signs can't be used. These rugged markers can be walked on, driven over, or mowed over. 7" disk with 13" stake included.

PART #	DESCRIPTION	PRICE
SOILMARKER	7" disk with 13" Stake	\$12.75
SOILMARKERSS	7" disk with 13" Stainless Steel Stake	50.00

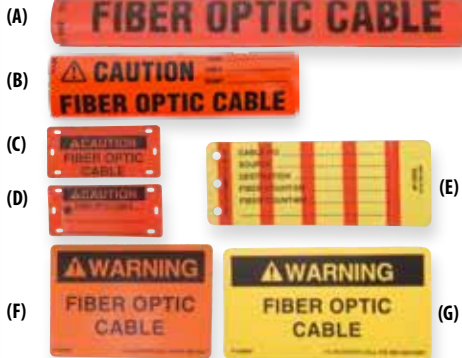

## WARNING LABELS

Warning labels are available from FIS in a variety of sizes and colors with many standard logos offered. Selection includes Wrap Around, Tie On, Sticky Back and Write-On. Call for Custom Labels.

PART #	DESCRIPTION	PRICE
F1-0099-SF	8" Long Wrap Around (Black on Orange) (A)	\$1.50
F1-0094F	4" Long Wrap Around (Black on Orange) (B)	1.65
F1-0100SF	3-7/8" x 1-3/4" Tie On (Black on Orange-20pk) (C)	14.95
F1-0100SL	3-7/8" x 1-3/4" Tie On with self laminating flap (20-pk) (D)	13.60
F1-0095	Write-On Cover All Tag (Black on Yellow-25pk) (E)	23.50
F1-0099F	2-3/4" x 4" Sticky Back (Black on Orange) (F)	60¢
F1-0096F	3-1/4" x 1-3/4" Sticky Back (Black on Yellow) (G)	60¢
F1-0092	2-3/4" x 5" Sticky Back (Black on Yellow) (Same Text as F)	60¢
F1-3801	Outdoor Durable Permanent Black Sharpie (Not Pictured)	1.25

Custom Sizes and Prints Available



F1-CC

## CABLE CLIPPER LABELS

Extruded outdoor-durable black PVC cable marker clips over cable. Fits cable diameters 0.5" to 1.0". Secured to cable with urethane adhesive strip. Labels available in a variety of colors to include your company name, logo, and emergency phone numbers. Background is brightly colored with Arial font black letters. Outdoor durable, minimum 10 years. Easy to read from ground, text height approximately 0.75" to 1". Standard size clipper is 6" length.

PART #	DESCRIPTION	PRICE
F1-CC	Clips with Reflective Laminated Label Applied. 6" Length. (generic print)	\$10.35

551165



## BURIED CABLE MARKER TAPES

Protect and locate buried fiber optic cable by placing buried marker tape above cable. Tape is 3" wide continuous strip labeled "Caution, Fiber Optic Line Buried Below." Available in detectable and non-detectable varieties.

PART #	DESCRIPTION	PRICE
551165	3" x 1000' Non-Detectable Terra Tape	\$12.95
F1-6508	3" x 1000' Detectable Tape (metallic material)	25.00



F1-RKIT

## REFLECTIVE NUMBER AND LETTER KITS

Reflective Number and Letter Kits are an excellent solution for marking and labeling your field assets. These letters are highly reflective, you can easily see them in all weather and at all times of day. Laminated for extra protection against UV rays, abrasion and chemicals, these durable 3M Scotchlite™ reflective labels are available in convenient kits that contain 25 each A-Z, 25 each 0-9, 25 each dash and blank and a handy storage case. Stock color is Black character on orange reflective background. Other colors are available.

PART #	DESCRIPTION	PRICE
F1-RKIT	Reflective Labeling Kit	\$170.00



**FIS PORTABLE TABLE**

These tables are perfect for splicing and terminating fiber optic cable. Tables weigh approximately 15-25lbs. The Work Table Kit is sold separately and includes a lamp (110VAC), magnifier, and universal clamp. Carrying Case sold separately.

PART #	DESCRIPTION	PRICE
F1-CT36	Work Table (22"x28")	\$535.00
F1-CT53	Work Table (22"x44")	950.00
F1-CT70	Work Table (22"x58")	795.00
FIS-AK	Work Table Kit (see description above)	525.00
CL400	Carrying Case	110.00



**FIS SPLICE TENTS**

Splice tents for outside field applications are made of tough urethane coated polyester fabric. FIS offers the standard splice tents and the new Space Saver splice tents. Space Savers have approximately 25% shorter folded length for storage and can be set over a cable or pipe.

PART #	DESCRIPTION	PRICE
F1-97976GF	FIS Tent (6'L x 6'W x 6' 8"H) with floor	\$830.00
F1-97978GF	FIS Tent (8'L x 8'W x 7' 8"H) with floor	1,135.00
F1-97976GS	FIS Space Saver Tent (6'L x 6'W x 6' 8"H) without floor	640.00
F1-97978GS	FIS Space Saver Tent (8'L x 8'W x 7' 8"H) without floor	895.00
F1-979710GS	FIS Space Saver Tent (10'L x 8'W x 8' 4"H) without floor	1,150.00



**TEMPO COMMUNICATIONS TRACKER II CABLE LOCATOR**

With its inductive signal application, the Tracker II can be used on active or dead systems. Now you can trace the path and determine the depth of wires and metallic pipes without having to deactivate the systems. High frequency transmitter provides range up to 4000 feet (1219 m) and depths to 7 ft. (2 m). The transmitter offers three methods of connection: direct, inductive coupler, or inductive antenna.

PART #	DESCRIPTION	PRICE
501	Cable Locator TRACKER II	\$810.00



**TEMPO MARKER-MATE**

Marker-Mate™ Electronic Marker Locator is designed to locate all brands of buried, electronic markers, including the patented Tempo Omni Marker™, and Uni Marker™. This locator sets an industry standard with the capability of detecting all seven application-based electronic marker types simultaneously (power, water, sanitary, telephone, gas, cable TV, non-potable water.) Marker disks available.

PART #	DESCRIPTION	PRICE
EML100	Marker Mate	\$1,015.00



**DID YOU KNOW...**

**THE IMPORTANCE HAVING CLEAN FIBER OPTIC COMPONENTS**

Within an optical network, clean fiber optic components are a requirement for quality connections between active fiber optic equipment and passive components. One of the most basic and important procedures for the optimal performance is to clean all of the fiber optic connections. Any contamination on the ferrule endface of a fiber connection can cause a failure of the component or failure of the whole system. Even microscopic dust and dirt particles can cause a variety of problems for optical connections. A particle that partially or completely blocks the optical fiber's core can generate strong back reflections, which can cause instability in the system. Dust and dirt particles trapped between two fiber faces can scratch the glass surfaces. Even if a particle is only on the cladding or the edge of the endface, it can cause an air gap or misalignment between the fiber cores, which can induce additional loss in the connection and contribute to the total link loss in the system.

- A 1µm dust particle on a singlemode core can block up to 1% of the light (a 0.05dB loss).
- A 9µm dust or dirt particle is still too small to see without a microscope, but it can completely block the fiber core of singlemode fiber. By comparison a typical human hair is 50µm to 75µm in diameter, as much as eight times larger.

So, even though dust might not be visible, it is still present in the air and can deposit onto the connector. Dust and dirt are not the only types of loss inducing contaminations, these may also include such materials as:

- Oils (frequently from human hands)
- Film residues, from vapors in the air
- Coatings, left after water or other solvents evaporate away

These contaminants can be more difficult to remove than dust particles and can also induce loss and damage if not removed with proper cleaning procedures.



OVERSIZED SHIPPING FEE  
MAY APPLY

**IN STOCK**



Innerduct Cutters

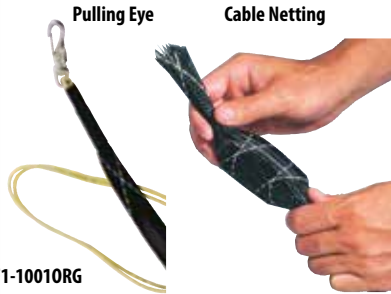

Pulling Eye

Cable Netting

F1-1001ORG

**INNERDUCT**

Fiber Instrument Sales distributes an Innerduct product line consisting of corrugated HDPE, riser rated PVC and plenum rated PVDF Innerduct in a variety of colors and sizes. A full line of fittings and accessories that complement the product line are available as well. The plenum and riser product lines are both UL 2024 listed and are among the most flexible flame-rated Innerduct products on the market. The HDPE outside plant products offer high tensile strength while being impervious to abrasion, scouring and root penetration. **Innerduct available in 250 and 500 foot coils.**

**HDPE CORRUGATED INNERDUCT - OUTDOOR RATED**

PART #	DESCRIPTION	OUT. DIA.	IN. DIA.	PRICE
F1-14383P250	Single-Wall Orange with 900 lb. Pull Tape -250ft	1.35"	1.049"	\$185.00/Coil
F1-14383P500	Single-Wall Orange with 900 lb. Pull Tape -500ft	1.35"	1.049"	\$21.00/Coil
F1-14383SP250	Split HDPE Orange -250ft	1.35"	1.049"	\$196.00/Coil
F1-14383SP500	Split HDPE Orange -500ft	1.35"	1.049"	\$357.00/Coil

**INDOOR RATED INNERDUCT**

PART #	DESCRIPTION	OUT. DIA.	IN. DIA.	PRICE
F1-14363P250	Riser Rated Orange with 900 lb. Pull Tape -250ft	1.35"	1.049"	\$235.75/Coil
F1-14363P500	Riser Rated Orange with 900 lb. Pull Tape -500ft	1.35"	1.049"	\$423.00/Coil
F1-11437P250	Plenum Rated Orange with 900 lb. Pull Tape -250ft	1.35"	1.049"	\$539.00/Coil
F1-11437P500	Plenum Rated Orange with 900 lb. Pull Tape -500ft	1.35"	1.049"	\$1,015.00/Coil

**INNERDUCT CUTTERS**

PART #	DESCRIPTION	PRICE
F1-SL200	Innerduct Cutters - Will Cut Diameters 1/2" to 1.5"	\$70.00

**INNERDUCT COUPLING**

PART #	DESCRIPTION	PRICE
PCCP-100	Innerduct Coupling 1 1/4" to connect two smaller pieces	\$14.50

**FIS FIBER OPTIC PULLING EYE AND CABLE NETTING**

The FIS pulling eye will protect connectors while providing a pulling point with properly distributed tensions on cable assemblies. Available as a stand-alone component or installed by FIS on your custom cable assembly. The pulling eye has a rotating end clip to minimize cable twisting and the connectors are protected with cable netting.

PART #	DESCRIPTION	PRICE
F1-1001	FIS Pulling Eye Kit for Multifibers Yellow	\$16.25
F1-1001ORG	FIS Pulling Eye Kit for Multifibers Orange	16.25
F1-1001BR	FIS Pulling Eye Kit for Simplex and Duplex	8.50
F1-1001A	Pulling Eye Installed by FIS	19.95
F1-5700	Cable Netting (Expands up to 2", pulls down to 1/2")	99c/ft

**DID YOU KNOW...  
KEY FEATURES OF FURCATION TUBING**

- Designed to terminate to a wide range of connector styles.
- Accommodates bare or tight buffered fibers.
- Provides durable fiber protection and emulates standard simplex and duplex cable.
- Consists of an inner tube surrounded by aramid yarn and a PVC jacket.
- 12 standard colors for easy identification.

**OTHER COLORS AVAILABLE**

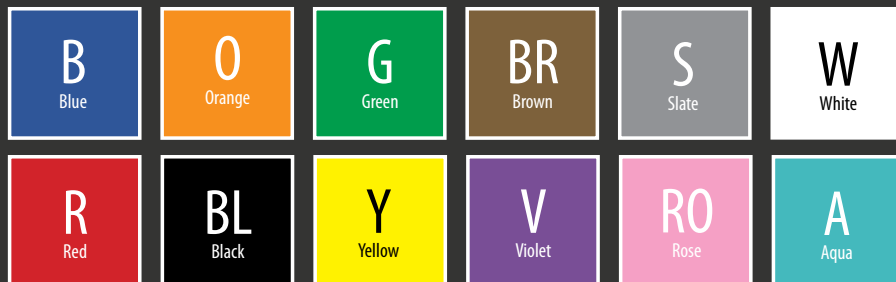

# CONNECTIVITY

## FIS BOBTAIL CONNECTOR

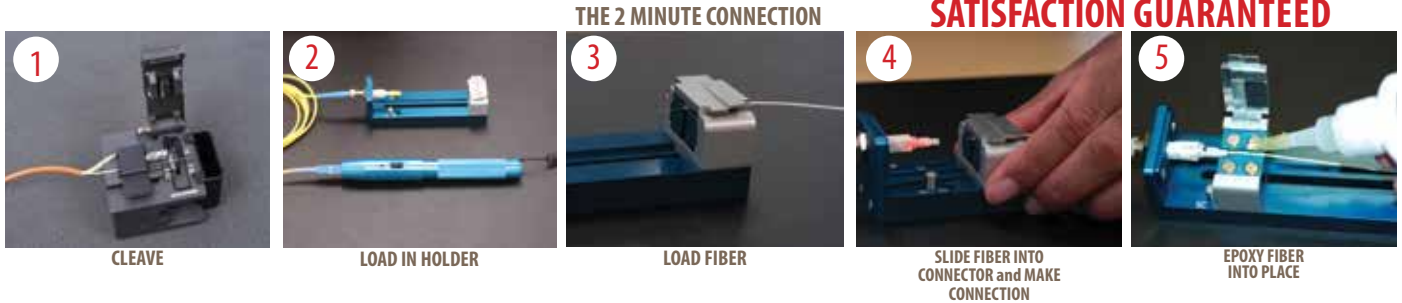

**FIS BOBTAIL™ NO-POLISH CONNECTOR (No Fiber Polishing Required)**  
 FIS Bobtail Connectors provide a pre-polished, quick termination style connector for an industry leading value. Bobtail's are ideal for many applications including, but not limited to, local area networks, restoration work, testing applications, and laboratory settings. The open epoxy canal allows application of Super Glue or any Cyanoacrylate adhesives. As always, your satisfaction is guaranteed or return the connectors to FIS for a complete refund.

PART #	DESCRIPTION	BOOT SIZE	PRICE
F1-0066-BT	Bobtail ST Pre-polished Connector - 62.5µm (OM1)	900µm	\$5.35
F1-00650-BT	Bobtail ST Pre-polished Connector - 50µm (OM2)	900µm	5.35
F1-0069-BT	Bobtail ST Pre-polished Connector - Singlemode	900µm	5.95
F1-5066-BT	Bobtail LC Pre-polished Connector - 62.5µm (OM1)	900µm	5.95
F1-506650-BT	Bobtail LC Pre-polished Connector - 50µm (OM2)	900µm	5.95
F1-5069-BT	Bobtail LC Pre-polished Connector - Singlemode	900µm	6.95
F1-3066-BT	Bobtail SC Pre-polished Connector - 62.5µm (OM1)	900µm	4.95
F1-306650-BT	Bobtail SC Pre-polished Connector - 50µm (OM2)	900µm	4.95
F1-3069-BT	Bobtail SC Pre-polished Connector - Singlemode	900µm	5.95

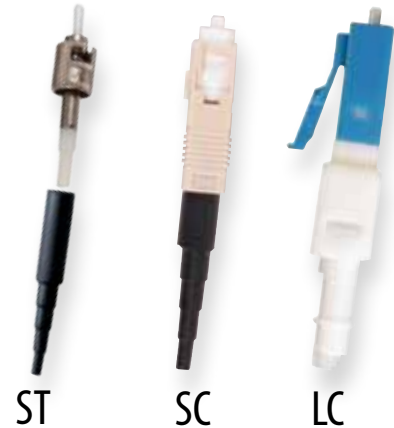

	Connector A (leading competitor)	Connector B (leading competitor)	Bobtail™ Connector
Test #1	.6*	1.7	1.7
Test #2	.5*	1.8	1.3
Test #3	.4	1.8	1.2
Test #4	.5	2.1	1.9
Test #5	1.0*	1.3	2.1
Test #6	.8	1.6	2.3
	.6 lbs. average	1.71 lbs. average	1.75 lbs. average

\* Connector broke off fiber



**CAUTION:**  
 FIS discourages the use of the Bobtail or any mechanical splice style connector in 10 G network systems.

**SEE ONLINE VIDEO:**  
[www.fiberinstrumentsales.com/information/fis-tv-videos/bobtail-connector](http://www.fiberinstrumentsales.com/information/fis-tv-videos/bobtail-connector)

### FIS UNIVERSAL SLIDING BOBTAIL HOLDER

The FIS assembly tool is now designed with a precision machined sled to aid in the insertion of the prepared field fiber. This feature virtually eliminates fiber stub breakage and minimizes insertion loss. Includes adapter plates for SC, LC, and ST Bobtail Connectors.

PART #	DESCRIPTION	PRICE
F1-00SUNBTH	FIS Universal Sliding Bobtail Holder	\$150.00

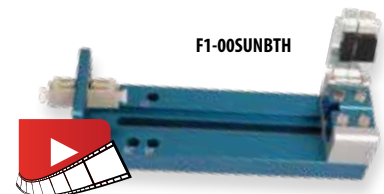

### CYANOACRYLATE ADHESIVE FOR BOBTAIL CONNECTORS

This quick set cyanoacrylate adhesive is provided for terminating FIS Bobtail connectors. An accelerant provides even faster cure time, less than 60 seconds.

PART #	DESCRIPTION	PRICE
F1BTXY	Two Part Epoxy for Bobtail Connector	\$32.95



CORNING



25 PACKS AVAILABLE

**UNICAM® PRETIUM™ PRE-POLISHED CONNECTOR AND TOOL KIT (No Fiber Polishing Required)**

The UniCam® Pretium™ Tool Kit can quickly install a UniCam Connector in about 45 seconds. From the cleaver, with its integrated fiber scrap bin and dual-clamp precision hold, to the installation tool with its immediate go/no-go feedback signal, the UniCam® Pretium™ Tool Kit was thoughtfully designed with the needs of network installers in mind.

DESCRIPTION	PART #
Trash Container	2104498-01
Scissors	100294-01
Black Permanent Marker	2104499-01
Fiber Optic Cleaning Fluid	*
Fiber Wipes	*
Pretium Cleaver	FBC-007
Pretium UniCam Installation Tool	TL-UCP
Cable Jacket Stripping Tool	3206001-01
Dual-Hole Stripping Tool	2104502-01
1.25 mm Ferrule Adapter	VFL-A125
UniCam Crimp Tool	3201007-01
Lanyards (2)	02-002853-001
Cleaning Stick - Size 2.5 mm	*
2.5 mm Ferrule Adapter (with Installation Tool)	VFL-250

PART#	DESCRIPTION	PRICE
TKT-UNICAM-PFC	Pretium™ Tool Kit	\$2,000.00
TKT-UNICAM-PFCZ	Pretium™ High Performance Install Kit	4,875.50

**CONNECTORS AND ACCESSORIES**

PART #	STYLE	TYPE	FERRULE	TYPICAL LOSS	PRICE	PART #	STYLE	TYPE	FERRULE	TYPICAL LOSS	PRICE
95-000-50	ST	MM, 62.5/125µm	Composite	.3dB	\$11.50	95-050-41	SC	MM, 50/125µm	Zirconia	.3dB	\$15.85
95-050-51	ST	MM, 50/125µm	Zirconia	.3dB	15.25	95-050-41X	SC	MM, OM3 10G	Zirconia	.3dB	14.70
95-000-51	ST	MM, 62.5/125µm	Zirconia	.3dB	14.75	95-000-99	LC	MM, 62.5/125µm	Zirconia	.3dB	15.60
95-200-51	ST	SM, 8.3/125µm	Zirconia	.4dB	16.65	95-050-99	LC	MM, 50/125µm	Zirconia	.3dB	15.75
95-000-41	SC	MM, 62.5/125µm	Zirconia	.3dB	14.35	95-200-99	LC	SM, 8.3/125µm	Zirconia	.3dB	18.75
95-200-41	SC	SM, 8.3/125µm	Zirconia	.4dB	17.25	95-050-99X	LC	MM, OM3 10G	Zirconia	.3dB	15.95
95-000-40	SC	MM, 62.5/125µm	Composite	.3dB	11.50	TL-UC-01		Universal UniCam Installation Tool			535.00

**FIS FTX FIELD TERMINATION KIT (NO FIBER POLISHING REQUIRED)**

The FIS FTX Termination Kit includes all the supplies you need to successfully install the FTX series quick term connectors in a convenient carrying case. The FTX connectors are a good solution for field termination of singlemode fibers in Fiber to the "X" applications such as Fiber to the Home, Fiber to the Antenna, Fiber to the MDU, and Fiber to the Business. The FTX connector is available in SC/APC and SC/UPC versions for both 3mm jacketed fiber as well as 900um tight buffered fiber.

**Kit Includes:** Lynx Precision Cleaver, Tri Hole Stripper, Kevlar Cutters, Fiber Shard Container, Pre-Saturated Alcohol Wipes and Carry Case

PART #	DESCRIPTION	PRICE
F1FTXKIT	FIS FTX Field Termination Kit	\$695.00

**FIS FTX QUICK TERMINATION CONNECTOR**

The new quick termination fiber optic SC/UPC and SC/APC connector is available in two variations to install onto Singlemode 3mm jacketed or 900um fiber. Intended for Fiber to "x" applications such as home, antenna or Multi-Dwelling residences, it meets Telcordia GR-326 Core test standards. As with all field terminated mechanical connectors utilizing a precision cleaver is necessary for best performance.

PART #	DESCRIPTION	PRICE
F1SCAFTX3	SC/APC Quick termination mechanical splice connector, 3mm cable strain relief boot	\$4.95
F1SCAFTX9	SC/APC Quick termination mechanical splice connector, 900um fiber strain relief boot	4.95
F1SCUFTX3	SC/UPC Quick termination mechanical splice connector, 3mm fiber strain relief boot	4.95
F1SCUFTX9	SC/UPC Quick termination mechanical splice connector, 900um fiber strain relief boot	4.95
F1FTXKIT	FIS FTX Field Termination Kit (Tri-hole Stripper, Kevlar Cutter, Lynx Cleaver, Shard Container, Wipes)	695.00



**AFL FASTConnect® FIELD-INSTALLABLE**

**(No Fiber Polishing Required)**

The FASTConnect Tool Kit provides all necessary installation tools required for fiber preparation of 250/900µm, 2mm and 3mm cordage for AFL's prepolished FASTConnect. The Kit carrying case contains all industry standard termination tools, installation instructions, as well as adequate storage for carrying extra FAST connectors for on-site convenience.



**KIT CONTENTS**

QTY	DESCRIPTION	PART #
1	CT-50 Universal Cleaver	S014080
1	FASTConnect SC Assembly Tool	CS007780
1	FASTConnect LC Assembly Tool	CS007779
1	3mm Cable Clamp	S014704
1	2mm Cable Clamp	S014705
1	250/900µm Cable Clamp	CS004442
1	Fiber Preparation Fluid	FRF1-00-0900
1	Installation Instructions	CS007701
1	Strip Length Template	CS001203
1	Assembly Video	CS001204
1	Carrying Case	CS001202

**NEW  
6 PACKS**



PART #	DESCRIPTION	PRICE
CS001201	FASTConnect Tool Kit	\$1,753.00

**FASTConnect**

PART #	DESCRIPTION	PRICE - 6 pack
FAST-SC-MM50-6	FASTConnect-SC 50/125µm MM 900µm Boot	\$61.95
FAST-SC-MM50L-6	FASTConnect-SC OM3 10G, 900µm Boot	65.30
FAST-SC-MM62.5-6	FASTConnect-SC 62.5/125µm MM 900µm Boot	61.95
FAST-SC-SM-6	FASTConnect-SC SM 900µm Boot	91.65
FAST-ST-MM62.5-6	FASTConnect-ST 62.5/125µm 900µm Boot	64.70
FAST-ST-SM-6	FASTConnect-ST SM 900µm Boot	80.25
FAST-LC-MM62.5-6	FASTConnect-LC 62.5/125µm 900µm Boot	68.95
FAST-LC-MM50-6	FASTConnect-LC 50/125µm 900µm Boot	68.50
FAST-LC-MM50L-6	FASTConnect-LC OM3 10G 900µm Boot	71.95
FAST-LC-SM-6	FASTConnect-LC SM 900µm Boot	85.60



**HOT MELT ACCESSORIES**

PART #	DESCRIPTION	PRICE
F1-9110	FIS 6 Port Hot Melt Oven 110V	\$425.00
F1-9110220	FIS 6 Port Hot Melt Oven 220V	925.00
F1-9130	FIS 12 Port Hot Melt Oven 110V	715.00
6192A	2µm 5" Polish Film 50 Pack	24.00
6192B	2µm 4" Polish Film for 6850A Polisher (with hole) 50 per Pack	15.00
6192-AA	Singlemode Final Polish Film for Hot Melts	60¢

**CORNING  
CORNING HOT MELT**

CORNING Hot Melts continue to be a popular choice among installers in the field. The Hot Melt connectors utilize an advanced adhesive technology eliminating the application of epoxy. The connectors provide quick termination in 2 minutes or less and are re-heatable to allow for fiber repositioning.

**Fiber polishing required with Hot Melt Connectors.**

**CORNING HOT MELT CONNECTORS (Fiber Polishing Required)**

PART #	STYLE	FIBER SIZE	TYPICAL LOSS	TYPE	PRICE
6100	ST	125µm	.2dB	Multimode	\$6.25
8100YS	ST	126µm	.2dB	Singlemode	7.25
6200	FC	125µm	.2dB	Multimode	7.99
8200W	FC	126µm	.2dB	Singlemode	9.55
6300W	SC	125µm	.2dB	Multimode	6.00
8300	SC	126µm	.2dB	Singlemode	7.30





See pages 152-153 for Custom Drilling Prices



F1-3066

CORNING



8306

SEIKOH GIKEN



SSCPE3C1261A300G

## SC CONNECTORS

The SC connector is a non-optical disconnect connector with a 2.5mm pre-radiused zirconia ferrule. Available in simplex and duplex styles, this connector features a push-pull connection design for quick patching of cables into rack or wall mounts. Utilize the reusable duplex holding clip to create duplex connections. \*Add "100" to the end of the part number for bulk part numbers (ex. F13066100).



PART #	TYPE	BOOT SIZE	FERRULE SIZE	FERRULE	PRICE	100pk BULK PRICE
<b>FIS</b>						
F1-3066	Multimode	3mm	127µm	Zirconia	\$2.30	\$210.00
F1-306620	Multimode	2mm	127µm	Zirconia	2.30	210.00
F1-3066900	Multimode	900µm	127µm	Zirconia	2.30	210.00
F1-3061	Multimode	3mm	127µm	Stainless Alloy	3.95	----
F1-3069	Singlemode	3mm	126µm	Zirconia	2.95	230.00
F1-306920	Singlemode	2mm	126µm	Zirconia	2.95	230.00
F1-3069900	Singlemode	900µm	126µm	Zirconia	2.95	230.00
F1-3069APC	Singlemode APC	3mm	126µm	Zirconia	5.50	450.00
F1-3069900APC	Singlemode APC	900µm	126µm	Zirconia	5.50	450.00
F1-3069APC20	Singlemode APC	2mm	126µm	Zirconia	5.50	450.00
F1-3066AR	Multimode (Anaerobic)	3mm	125µm	Zirconia	3.25	----
F1-CLBK	Duplex Clip (Black for Multimode)				0.50	----
F1-CLBL	Duplex Clip (Blue for Singlemode)				0.50	----
F1-3066AQ	Multimode 10 Gig	3.0mm	127µm	Zirconia	2.95	230.00
F1-3066AQ20	Multimode 10 Gig	1.6/ 2.0mm	127µm	Zirconia	2.95	230.00
F1-3066AQ900	Multimode 10 Gig	900µm	127µm	Zirconia	2.95	230.00
SCMM3BGE (NEW-Import)	Simplex - Multimode	3mm		Zirconia	\$0.90	\$85.00
SCMM2BGE (NEW-Import)	Simplex - Multimode	2mm		Zirconia	0.90	85.00
SCMM9BGE (NEW-Import)	Simplex - Multimode	900µm		Zirconia	0.90	85.00
SCOM33AQ (NEW-Import)	Simplex - Multimode (OM3)	3mm		Zirconia	1.10	100.00
SCOM32AQ (NEW-Import)	Simplex - Multimode (OM3)	2mm		Zirconia	1.10	100.00
SCOM39AQ (NEW-Import)	Simplex - Multimode (OM3)	900µm		Zirconia	1.10	100.00
SCSM3BLK (NEW-Import)	Simplex - Singlemode	3mm		Zirconia	1.20	110.00
SCSM2BLK (NEW-Import)	Simplex - Singlemode	2mm		Zirconia	1.20	110.00
SCSM9BLK (NEW-Import)	Simplex - Singlemode	900µm		Zirconia	1.20	110.00
SCASM3BLK (NEW-Import)	Simplex - Singlemode APC	3mm		Zirconia	1.20	110.00
SCASM2BLK (NEW-Import)	Simplex - Singlemode APC	2mm		Zirconia	1.20	110.00
SCASM9BLK (NEW-Import)	Simplex - Singlemode APC	900µm		Zirconia	1.20	110.00

## CORNING (Formerly 3M)

6306	Multimode	3mm	125µm	Zirconia	\$3.15	
8306	Singlemode	3mm	126µm	Zirconia	3.60	
8306SCAPC	Singlemode APC	3mm	126µm	Zirconia	5.45	
8306SCAPC900	Singlemode APC	900µm	126µm	Zirconia	5.75	

## CORNING

95-100-48SP	Multimode	3mm	125.5µm	Zirconia	\$5.10	
95-100-48SP2	Multimode	2mm	125.5µm	Zirconia	5.10	
95-101-41SP	Multimode (Anaerobic)	3mm	125µm	Zirconia	5.65	

## SEIKOH GIKEN

SSCPE3C1261A300G	Singlemode	3mm	126µm	Zirconia	\$3.25	
SSCPNE871251B300G	Singlemode APC	3mm	125µm	Zirconia	5.95	



Connectors Available In 2mm, 3mm & 900µm Versions

# BUY FIS IN BULK AND SAVE

## MTP® CONNECTORS

US Conec manufactures durable MTP® brand connectors that provide quick connection for up to 72 optical fibers. MTP® ferrules are available as Standard or Elite options (see table below for specifications). MTP® Connectors have variants of 8, 12, 16, 24, 32, 48, and 72 fibers, with the 12 and 24 options being the most common. From 12 - 72 fibers listed are 12 & 24 variations.



PART #	DESCRIPTION	FERRULE	CABLE TYPE	PRICE
MTP-12MM	MTP Connector 12 Fiber Multimode OM1 Male Beige Housing	Standard	Ribbon/Oval	\$15.75
MTP-12MF	MTP Connector 12 Fiber Multimode OM1 Female Beige Housing	Standard	Ribbon/Oval	15.75
MTP-12SM	MTP Connector 12 Fiber Singlemode APC Male <b>Green Housing</b>	Standard	Ribbon/Oval	21.95
MTP-12SF	MTP Connector 12 Fiber Singlemode APC Female <b>Green Housing</b>	Standard	Ribbon/Oval	21.50
MTP-12MMRD	MTP Connector 12 Fiber Multimode Male OM3/4 <b>Aqua Housing</b>	Standard	3.0mm/Round	16.95
MTP-12MFRD	MTP Connector 12 Fiber Multimode Female OM3/4 <b>Aqua Housing</b>	Standard	3.0mm/Round	16.95
MTP-12MFRD2	MTP Connector 12 Fiber Multimode Female OM3/4 <b>Aqua Housing</b>	Standard	2.0mm/Round	15.95
MTP-12MMRD2	MTP Connector 12 Fiber Multimode Male OM3/4 <b>Aqua Housing</b>	Standard	2.0mm/Round	16.95
MTP-12MMRD2M	MTP Connector 12 Fiber Multimode Male OM4 <b>Magenta Housing</b>	Standard	2.0mm/Round	17.95
MTP-12SMRD	MTP Connector 12 Fiber Singlemode APC Male <b>Green Housing</b>	Standard	3.0mm/Round	21.50
MTP-12SFRD	MTP Connector 12 Fiber Singlemode APC Female <b>Green Housing</b>	Standard	3.0mm/Round	21.50
MTP-12MMBRD	MTP Connector 12 Fiber Multimode OM1 Male Beige Housing	Standard	3.0mm/Round	15.75
MTP-12MFBRD	MTP Connector 12 Fiber Multimode OM1 Female Beige Housing	Standard	3.0mm/Round	15.75
MTP-12SMFE0V	MTP Connector 12 Fiber Singlemode APC Female <b>Mustard Housing</b>	Elite	Ribbon/Oval	38.95
MTP-12SMME0V	MTP Connector 12 Fiber Singlemode APC Male <b>Mustard Housing</b>	Elite	Ribbon/Oval	38.95
MTP-12MMME0V	MTP Connector 12 Fiber Multimode OM3/4 Male <b>Aqua Housing</b>	Elite	Ribbon/Oval	25.75
MTP-24MFE0V	MTP Connector 24 Fiber Multimode OM3/4 Female <b>Aqua Housing</b>	Elite	Ribbon/Oval	38.95
MTP-24MME0V	MTP Connector 24 Fiber Multimode OM3/4 Male <b>Aqua Housing</b>	Elite	Ribbon/Oval	38.95
MTP-24SM0V	MTP Connector 24 Fiber Singlemode APC Male <b>Green Housing</b>	Standard	Ribbon/Oval	42.95
MTP-24SFOV	MTP Connector 24 Fiber Singlemode APC Female <b>Green Housing</b>	Standard	Ribbon/Oval	42.95

NOTE: Singlemode MTP Connectors are angled at 8° to improve performance (indicated by green housing)



MTP12MM



MTP12MMME0V



MTP12MMRD2M

### STANDARD FERRULES VS. ELITE FERRULES SPECIFICATIONS

	STANDARD FERRULES		ELITE FERRULES	
	Standard Singlemode MT Ferrule	Standard Multimode MT Ferrule	MM MT Elite® Multimode MT Ferrule	SM MT Elite® Singlemode MT Ferrule
Insertion Loss	0.25dB Typical (All Fibers) 0.75dB Maximum (Single Fiber) <sup>1</sup>	0.20dB Typical (All Fibers) 0.60dB Maximum (Single Fiber) <sup>2,3</sup>	0.1dB Typical (All Fibers) 0.35dB Maximum (Single Fiber) <sup>2,3</sup>	0.10dB Typical (All Fibers) 0.35dB Maximum (Single Fiber) <sup>1</sup>
Optical Return Loss	>60dB (8° Angle Polish)	>20dB	>20dB	>60dB (8° Angle Polish)

## MTP PRO Connector Field Tool

The MTP® PRO connector offers quick and effective polarity and pin reconfiguration in the field while ensuring product integrity and performance by utilizing the MTP® PRO field tool. The PRO connectors are available as an option on cable assemblies (see page 12). Purchase the Pro field tool to change gender or polarity, extra pin exchanges are available in ten packs.

PART #	DESCRIPTION	PRICE
18814	MTP Pro Field Tool	\$100.00
18841	MTP Pro Pin Exchanger, SM Elite, Female (No Pins), Yellow holder, 10 pack	18.50
18843	MTP Pro Pin Exchanger, SM Elite, Male (With Pins), Yellow holder, 10 pack	69.95
18256	MTP Pro Pin Exchanger, MM, Female (No Pins), Aqua holder, 10 pack	18.50
18842	MTP Pro Pin Exchanger, MM, Male (With Pins), Aqua holder, 10 pack	35.50

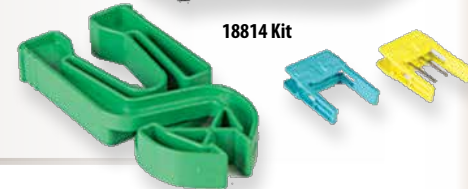

18814 Kit

## MTP® ADAPTERS

PART #	DESCRIPTION	COLOR	PRICE
MTP-ADPT	MTP Adapter, Full Flange, Key Up to Key Down (Type A or C), Standard Footprint	Black	\$5.95
MTP-9299	MTP Adapter, Screw Mount 30 Degree Angle, Key Up to Key Down (Type A or C)	Black	14.95
MTP-RFADPT	MTP Adapter, Reduced Flange, Key Up to Key Down (Type A or C), Standard Footprint	Black	5.65
12219	MTP Adapter, Full Flange, Key Up to Key Down (Type A or C), SC Footprint	Aqua	7.50
5306	MTP Adapter, Full Flange, 1 Dust Cap, Key Up to Key Up (Type B)	Gray	5.75
12196	MTP Adapter, Full Flange, 2 Dust Cap, Key Up to Key Up (Type B)	Gray	6.50
12228	MTP Adapter SC Footprint Reduced Flange, Key Up to Key Down (Type A or C), SC Footprint	Green	6.00



MTP-ADPT



MTP-RFADPT



12228



12219



See pages 152-153 for Custom Drilling Prices



F1-0066

CORNING



6105

CORNING



95-250-06SP



## ST CONNECTORS

The ST connector utilizes a bayonet twist-lock connection with 2.5mm ferrule; the ST connector features reliable and durable field installation. The design of the ST connector enables installers to crimp the back of the body directly onto the cable jacket and Kevlar®. This eliminates cable pull-away, ensuring a strong termination. Upon request, FIS ST connectors can be supplied without FIS markings. Stainless alloy ferrules can be custom drilled. \*Add "100" to the end of the part number for bulk part numbers (ex. F10066100)

PART #	TYPE	BOOT SIZE	FERRULE SIZE	FERRULE	PRICE	100pk BULK PRICE
<b>FIS</b>						
F1-0066	Multimode	3mm	127µm	Zirconia	\$1.60	\$150.00
F1-006620	Multimode	2mm	127µm	Zirconia	1.60	150.00
F1-0066900BLK	Multimode	900µm	127µm	Zirconia	1.60	150.00
F1-0067	Multimode	3mm	140µm	Zirconia	3.50	----
F1-0069	Singlemode	3mm	126µm	Zirconia	2.30	170.00
F1-006920	Singlemode	2mm	126µm	Zirconia	2.30	170.00
F1-0069900	Singlemode	900µm	126µm	Zirconia	2.30	170.00
F1-0061	Multimode	3mm	127µm	Stainless Alloy	3.50	----
F1-006120	Multimode	2mm	127µm	Stainless Alloy	3.50	----
F1-0063	Multimode	3mm	140µm	Stainless Alloy	3.50	----
F1-0064	Multimode	3mm	230µm	Stainless Alloy	3.50	----
F1-0065	Plastic Fiber	3mm	1000µm	Stainless Alloy	3.50	----
F1-1066AR	Multimode (Anaerobic)	3mm	125µm	Zirconia	2.75	----
F1-0066AQ	Multimode 10 Gig	3mm	127µm	Zirconia	2.30	170.00
F1-0066AQ20	Multimode 10 Gig	2mm	127µm	Zirconia	2.30	170.00
F1-0066AQ900	Multimode 10 Gig	900µm	127µm	Zirconia	2.30	170.00
STMM3BLK (NEW-Import)	Simplex - Multimode	3mm		Zirconia	\$0.80	\$75.00
STMM2BLK (NEW-Import)	Simplex - Multimode	2mm		Zirconia	0.80	75.00
STMM9BLK (NEW-Import)	Simplex - Multimode	900µm		Zirconia	0.80	75.00
STSM3BLK (NEW-Import)	Simplex - Singlemode	3mm		Zirconia	0.90	85.00
STSM2BLK (NEW-Import)	Simplex - Singlemode	2mm		Zirconia	0.90	85.00
STSM9BLK (NEW-Import)	Simplex - Singlemode	900µm		Zirconia	0.90	85.00
<b>CORNING (Formerly 3M)</b>						
6105	Multimode	3mm	125µm	Zirconia	\$2.50	
8106	Singlemode	3mm	126µm	Zirconia	3.25	
<b>CORNING</b>						
95-100-44SP	Multimode	3mm	125.5µm	Zirconia	\$5.10	
95-100-44SP2	Multimode	2mm	125.5µm	Zirconia	5.10	
95-250-06SP	Singlemode	3mm	125.5µm	Composite	5.25	



F1-2073



See pages 152-153 for Custom Drilling Prices



## FIS FC CONNECTORS

FC connectors are specifically designed for telecommunication applications and provide non-optical disconnect performance. Designed with a threaded coupling for durable connections. The ferrule is PC finished to a pre-radius, which ensures low back reflection. Stainless alloy ferrules can be custom drilled to your specifications. All FIS FC connectors use narrow key (2.0mm).

\*Add "100" to the end of the part number for bulk part numbers (ex. F2073100)

PART #	TYPE	BOOT SIZE	FERRULE SIZE	FERRULE	PRICE	100pk BULK PRICE
<b>FIS</b>						
F1-2073	Multimode	3mm	127µm	Zirconia	\$3.75	\$298.00
F-1207320	Multimode	2mm	127µm	Zirconia	3.75	298.00
F1-2073900	Multimode	900µm	127µm	Zirconia	3.75	298.00
F1-2777	Multimode	3mm	140µm	Zirconia	4.45	----
F1-2771	Multimode	3mm	128µm	Stainless Alloy	4.45	----
F1-2772	Multimode	3mm	140µm	Stainless Alloy	4.45	----
F1-2774	Multimode	3mm	230µm	Stainless Alloy	4.45	----
F1-2070	Singlemode	3mm	126µm	Zirconia	4.25	330.00
F1-207020	Singlemode	2mm	126µm	Zirconia	4.25	330.00
F1-2070900	Singlemode	900µm	126µm	Zirconia	4.25	330.00
F1-2070APC	Singlemode APC	3mm	126µm	Zirconia	5.50	450.00
F1-2070APC20	Singlemode APC	2mm	126µm	Zirconia	5.50	450.00
F1-2070900APC	Singlemode APC	900µm	126µm	Zirconia	5.50	450.00
F1-2073AQ	Multimode 10 Gig	3mm	127µm	Zirconia	4.25	330.00
F1-2073AQ900	Multimode 10 Gig	900µm	127µm	Zirconia	4.25	330.00





## LC CONNECTORS

The LC connector licensed by Lucent Technologies provides a pull-proof design and small size perfect for high-density applications. Available in simplex or duplex versions. The LC connector is provided with a 1.25mm zirconia ferrule. The LC also incorporates a unique latching mechanism providing stability in system rack mounts.

\*Add "100" to the end of the part number for bulk part numbers (ex. F15066100)

PART #	TYPE	BOOT SIZE	FERRULE SIZE	FERRULE	PRICE	100pk BULK PRICE
<b>FIS</b>						
F1-5066	Simplex-MM	3mm	128µm	Zirconia	\$2.30	\$200.00
F1-5066AAQ	Simplex-MM OM3/OM4 - Aqua	3mm	126µm	Zirconia	2.50	210.00
F1-506616AAQ	Simplex-MM OM3/OM4 - Aqua	1.6-2mm	128µm	Zirconia	2.50	210.00
F1-506616	Simplex-MM	1.6-2mm	128µm	Zirconia	2.30	200.00
F1-506616M	Simplex-MM OM4 - Magenta	1.6-2mm	128µm	Zirconia	2.75	250.00
F1-5066900	Simplex-MM	900µm	128µm	Zirconia	2.30	200.00
F1-5069	Simplex-SM	3mm	126µm	Zirconia	2.75	265.00
F1-506916	Simplex-SM	1.6-2mm	126µm	Zirconia	2.75	265.00
F1-5069900	Simplex-SM	900µm	126µm	Zirconia	2.75	265.00
F1-5069APC	Simplex APC	3mm	126µm	Zirconia	5.35	450.00
F1-5069900APC	Simplex APC	900µm	126µm	Zirconia	5.35	450.00
F1-6066	Duplex-MM	3mm	128µm	Zirconia	4.75	400.00
F1-606616	Duplex-MM	1.6-2mm	128µm	Zirconia	4.75	400.00
F1-606616M	Duplex-MM OM3 - Magenta	1.6-2mm	128µm	Zirconia	5.00	----
F1-6066AQ	Duplex-MM OM3/OM4 - Aqua	3mm	128µm	Zirconia	5.00	----
F1-606616AQ	Duplex-MM OM3/OM4 - Aqua	1.6-2mm	128µm	Zirconia	5.00	----
F1-6069	Duplex-SM	3mm	126µm	Zirconia	5.75	500.00
F1-606916	Duplex-SM	1.6-2mm	126µm	Zirconia	5.75	500.00
F1-6069900	Duplex-SM	900µm	126µm	Zirconia	5.75	500.00
F1-5066AR	Anaerobic-MM	3mm	128µm	Zirconia	3.50	----
F1-6067	Duplex Mini LC-SM - Blue *	1.6mm	126µm	Zirconia	5.75	----
F1-6068AQ	Duplex Mini LC-MM OM3/OM4 - Aqua *	1.6mm	127µm	Zirconia	4.75	----
F1-6068	Duplex Mini LC-MM - Beige *	1.6mm	127µm	Zirconia	4.75	----

\*The Mini LC Connector is designed with a narrow ferrule pitch (5.25mm) to work with the Mini SFP (mSFP) transceiver.

## CCS

95-100-LCSP	Simplex-MM	3.0mm	125.5µm	Zirconia	\$5.25	
95-100-LCSP2	Simplex-MM	2.0mm	125.5µm	Zirconia	5.25	
TRIGGER-BP-D	LC Clips(each) - Simplex to duplex converters					30¢



F1-5066AQ



F1-6068AQ

CORNING



95-100-LCSP

## FC CONNECTORS

\*Add "100" to the end of the part number for bulk part numbers (ex. FCMM3BLK100)

PART #	TYPE	BOOT SIZE	FERRULE SIZE	FERRULE	PRICE	BULK PRICE
<b>FIS</b>						
FCMM3BLK (NEW-Import)	Simplex - Multimode	3mm		Zirconia	\$1.10	\$ 95.00
FCMM2BLK (NEW-Import)	Simplex - Multimode	2mm		Zirconia	1.10	95.00
FCMM9BLK (NEW-Import)	Simplex - Multimode	900µm		Zirconia	1.10	95.00
FCSM3BLK (NEW-Import)	Simplex - Multimode	3mm		Zirconia	1.20	100.00
FCSM2BLK (NEW-Import)	Simplex - Multimode	2mm		Zirconia	1.20	100.00
FCSM9BLK (NEW-Import)	Simplex - Multimode	900µm		Zirconia	1.20	100.00
FCASM3BLK (NEW-Import)	Simplex - Singlemode APC	3mm		Zirconia	1.20	100.00
FCASM2BLK (NEW-Import)	Simplex - Singlemode APC	2mm		Zirconia	1.20	100.00
FCASM9BLK (NEW-Import)	Simplex - Singlemode APC	900µm		Zirconia	1.20	100.00

## CORNING

6202	Multimode with Plastic Housing	3mm	125µm	Zirconia	\$4.25	
8206FCAPC	Singlemode with Plastic Housing APC	3mm	126µm	Zirconia	6.95	

## CCS

95-100-10SP	Multimode	3mm	125µm	Zirconia	\$5.10	
95-100-10SP2	Multimode	2mm	125.5µm	Zirconia	5.25	

## SEIKOH GIKEN

SAP8311260A300G	Singlemode	3mm	126µm	Zirconia	\$4.25	
SNP8871261B3K2G	Singlemode APC	3mm	126µm	Zirconia	5.95	

CORNING



6202

QUANTITY DISCOUNTS AVAILABLE

1. Choose your style
2. Choose your color



"X"

R  
RED



B  
BLACK



GR  
GREEN



W  
WHITE



Y  
YELLOW



BLU  
BLUE



AQ  
AQUA

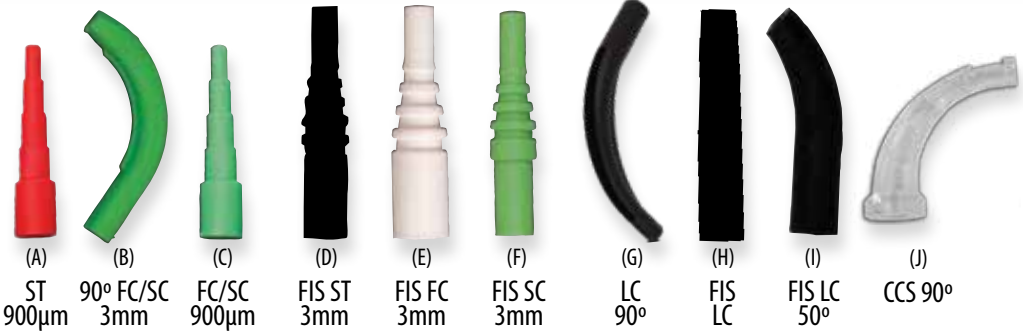

## STRAIN RELIEF BOOTS

Designed to be utilized on .128, .151, and .190 crimp sleeves. FIS boots are available in Red (R), Black (B), Green (GR), Blue (BLU), Aqua (AQ), White (W), and Yellow (Y). Replace X with abbreviation of color in parenthesis. Replace "x" with color code.

PART #	DESCRIPTION (See Strain Relief Boot style chart above)	ID	Length	Crimp Size	PRICE
667342900-25-X	FIS ST 900µm Boot (A) (25 pk.)	0.15	1.13"	0.128	\$6.25
CONN90-25-X	FIS SC and FC 3mm 90° Boot (B) (25 pk.)	0.20	1.40"	0.190	13.75
CONN107900-25-X	FIS SC and FC 900µm Boot (C) (25 pk.)	0.17	1.13"	0.179	6.25
667342-BC-25-X	FIS ST 3mm Boot (D) (25 pk.)	0.15	1.47"	0.128	6.25
6673422-BC-25-X	FIS ST 2mm Boot (25 pk.)	0.15	1.47"	0.128	6.25
CONN107BC-25-X	FIS FC 3mm Boot (E) (25 pk.)	0.20	1.25"	0.190	6.25
CONN1072-BC-25-X	FIS FC 2mm Boot (25 pk.)	0.20	1.25"	0.190	6.25
CONN205-25-X	FIS SC 3mm Boot (F) (25 pk.)	0.20	1.47"	0.190	6.25
F1-LC 90-BLK-25	FIS LC 90° 2mm Boot Black (G) (25 pk.)	0.137	1.44"	0.128	6.25
LCBOOTBL25	FIS LC 3mm Boot Black (H) (25 pk.)	0.137	1.10"	0.128	6.25
F1-LC45BL25	FIS LC 50° 2mm Boot Black (I) (25 pk.)	0.137	1.0"	0.128	6.25
F1-LC90M2590	FIS LC 90° 2mm Boot White (not shown) (25 pk.)	0.137	1.40"	0.128	6.25
F1-LC90GR25	FIS LC 90° 2mm Boot Green (not shown) (25 pk.)	0.137	1.40"	0.128	6.25
CONN205-X-M20	FIS SC 2mm Boot (not shown) (25pk.)	0.20	1.47"	0.190	6.25
9540002BP	Corning 90° Radius Boot Clip for ST/SC/FC 3mm Boots, Clear (J), for 3mm Cable				1.80
95400004BPC	Corning 90° Radius Boot Clip for LC Boots, Clear, for 2mm Cable				65¢

## FERRULE PROTECTION CAPS

FIS protection caps are designed to provide protection against various elements that could damage either the ferrule or fiber. The universal clear protection caps fit ST, FC and SC style 2.5mm ferrules.

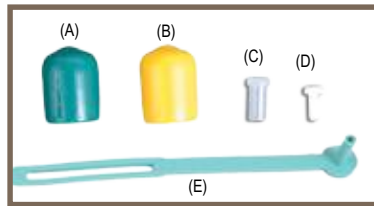

PART #	DESCRIPTION	PRICE
CPCYGR-B	Green Dust Cap Covers FC Housing (A) (100 pk.)	\$25.00
CPCY-B	Yellow Dust Cap Covers FC Housing (B) (100 pk.)	25.00
CAPB-B	Universal Clear Cap for 2.5mm Ferrules (C) (100 pk.)	25.00
F1-0125	Universal Dust Cap for 1.25mm Ferrules (D) (100 pk.)	25.00
F1-0125SA-100	Universal Dust Cap for 1.25mm Ferrules with jacket strap Aqua (E) (100 pk.)	25.00
F1-0125SBK-100	Universal Dust Cap for 1.25mm Ferrules with jacket strap Black (100 pk.)	25.00
F1-90010M	Universal Dust Cap for 2.5mm Ferrules with jacket strap (100 pk.)	25.00

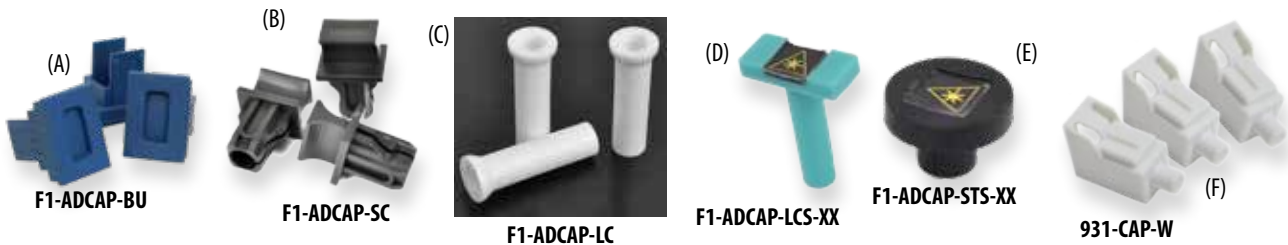

## MATING SLEEVE ADAPTER CAPS

The dust caps for adapters are easy to misplace and now FIS makes them just as easy to replace. Available in multiple colors, see chart above. Replace XX with the color desired: BL=Black, BU=Blue, GR=Green, BE=Beige AQ=Aqua.

PART #	DESCRIPTION	PRICE
F1-ADCAP-100-BU	SC Mating Sleeve Adapter Dust Cap, Blue - 100 pk.	A \$19.00
F1-ADCAP-100-CL	SC Mating Sleeve Adapter Cap, Clear - 100pk	19.00
F1-ADCAP-100-XX	SC Mating Sleeve Adapter Cap - 100pk (Specify Color)	19.00
F1-ADCAP-SC	SC Mating Sleeve Click-in Style Adapter Cap, Black - 100pk.	B 35.00
F1-ADCAP-LC	LC Mating Sleeve Round Head Adapter Cap, White - 100pk.	C 35.00
F1-ADCAP-LCS-XX	LC Mating Sleeve Square Head with Laser Warning Sticker - 100pk (Specify Color)	D 47.95
F1-ADCAP-FCS-XX	FC Mating Sleeve Round Head with Laser Warning Sticker - 100pk (Specify Color)	47.95
F1-ADCAP-STS-XX	ST Mating Sleeve Round Head with Laser Warning Sticker - 100pk (Specify Color)	E 47.95
931-CAP-W	LC Uniboot Dust Cap White - 100pk	F 35.00

**LASER SAFETY CAPS FOR MATING SLEEVES WITH METAL TILE**

FIS has created a solution to the problem of laser light emitted from fiber optic bulkhead adapters. Our new Laser Safety Caps come with a warning symbol on each to visually alert people to potentially harmful exposure to laser light and cap has a built-in metal tile to stop laser light up to +18dBm. They are available for SC, LC, ST and FC styles. Replace X with the color desired: BL=Black, BLU=Blue, GR=Green, BE=Beige, AQ=Aqua, CL=Clear.

PART #	DESCRIPTION	PRICE
F1-BLSCST-X25	ST Bulkhead Laser Safety Cap - (25 pk.) (A)	\$19.95
F1-BLSCSC-X25	SC Bulkhead Laser Safety Cap - (25 pk.) (B)	19.95
F1-BLSCFC-X25	FC Bulkhead Laser Safety Cap - (25 pk.) (C)	19.95
F1-BLSCLC-X25	LC Bulkhead Laser Safety Cap - (25 pk.) (D)	19.95

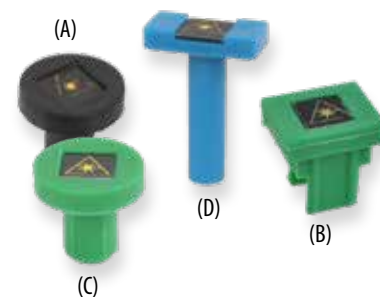

**METAL CAP AND CHAINS**

PART #	DESCRIPTION	PRICE
F1-9229-LC	Cap and Chain for LC Mating Sleeves	\$2.50
F1-9229-SC	Cap and Chain for SC Mating Sleeves	2.50
F1-9229-ST	Cap and Chain for ST Mating Sleeves	3.50
F1-9229-CH	Cap and Chain for FC Mating Sleeves	3.50



**MALE – FEMALE ADAPTERS**

Traditionally UPC and APC connectors have been incompatible to mate together due to the air-gap created between the two mating ferrules. This air-gap creates both undesirable high attenuation and high reflection in your network. The FIS M/F UPC-APC adapters allow UPC and APC fiber optic links to be mated together, adding flexibility to your network, while creating less than 1.0dB of Insertion Loss and -50dB of Return Loss.

Note: When purchasing these adapters be aware of the fiber type indicated and match to your application.

PART #	DESCRIPTION	HOUSING	SLEEVE	PRICE
F1-W1FSCA-SCU	SC/APC Female to SC/UPC Male (Singlemode)	Metal	Zirconia	\$9.95
F1-W1FSCU-SCA	SC/UPC Female to SC/APC Male (Singlemode)	Metal	Zirconia	9.95



See page 105 for a complete list of hybrid-adapters.

**BUFFERED FIBER ADAPTERS**

A Buffered Fiber Adapter enables you to make a quick, temporary connection to a cleaved buffered fiber without the need to connectorize. ST, FC, SC and SMA style adapters available. **Not recommended for use with test equipment.**

PART #	DESCRIPTION	PRICE
F1-8194	ST Buffered Fiber Adapter (For Use 900µm buffer)	\$39.95
F1-8294	FC Buffered Fiber Adapter (For Use 900µm buffer)	42.75
F1-8494	SC Buffered Fiber Adapter (For Use 900µm buffer)	45.00
F1-8394	SMA-905 Buffered Fiber Adapter (For Use 900µm buffer)	45.00



**DID YOU KNOW...**

**The Importance of Cleaves and Field Terminations**

Good cleave quality and consistency on field terminations significantly increases overall performance, especially on single mode fiber networks. Using an upgraded cleaver is the easiest and best way to achieve optimum results.

Although many manufacturers claim some increased performance using mechanically-spliced, quick termination field connectors, using a new precision optical cleaver is your most effective and cost-efficient option, especially when transitioning from factory-terminated fiber ends to field-terminated ends. The use of index matching gel inside the connector further aids in reducing the reflections resulting from any cleaving process.

The return on investing in a high-quality cleaver, sometimes \$600 to \$1300, that provides better results – and ultimately few issues during testing – is quickly recovered by eliminating costly connector replacements, technician field calls and system down-time.



# Buy FIS Bulk Epoxy Packs and Save!!

## FIS EPOXY FOR CONNECTORIZATION

Each pre-measured two-part packet contains the proper ratio for connectorization. Every packet includes specific directions for use with fiber optic connectors. The 2 gram pack will prepare 25 - 35 connectors. The 4 gram pack will prepare 50 - 70 connectors.

PART #	STYLE	2 GRAM PRICE	4 GRAM PRICE
H05-100-RX	Quick Cure, 5 Minutes at 100°C, Potlife 90 Minutes - Single Pack	\$5.00	\$6.00
T60-065-BX	Blue Dye, 1 Hour at 60°C or 30 Minutes at 80°C, Potlife 45 Minutes - Single Pack	5.00	6.00
T120-023-CX	Room Cure, 30 Minutes at 23°C, Potlife 5 Minutes - Single Pack	5.00	6.00
H15-080-RX	Heat Cure, 15 Minutes at 80°C, Potlife 90 Minutes - Single Pack	5.00	6.00
H05-100-RX-50	Quick Cure - 50 Pack	185.00	225.00
T60-065-BX-50	Blue Dye - 50 Pack	185.00	225.00
T120-023-CX-50	Room Cure - 50 Pack	185.00	225.00
H15-080-RX-50	Heat Cure - 50 Pack	185.00	225.00



Replace "X" with "2" for 2 Gram Package or "4" for 4 Gram Package.

## EPO-TEK EPOXY

The two-part EPO-TEK Epoxy is a favorite of many fiber optic users. The epoxy remains liquid until heat is applied. The application of heat provides a quick cure, turning the epoxy to a reddish-brown color. The EPO-TEK Epoxy will not react like other epoxies to coating applied to the larger core/clad diameter of specialty fibers.

PART #	DESCRIPTION	PRICE
353ND	EPO-TEK Epoxy (8 oz. Kit)	\$72.00



## LOCTITE EPOXY / TRA-CON ECCOBOND EPOXY

PART #	DESCRIPTION	PRICE
BAF123	Loctite F123 - Quick Cure, 1 Hour at 60°C or 30 Minutes at 80°C, Pot Life Estimate 4 Hours, 2.42 gram	\$7.95
BAF253	Loctite F253 - Quick Cure, 5 Minutes at 100°C, Pot Life Estimate 1 Minutes, 2.5 gram	13.25
BAF113SC	Loctite F113SC - Blue Dye, 1 Hour at 65°C or 18 Hours at 25°C, Pot Life Estimate 35-60 Minutes, 2.5 gram	8.95
BAF120	Loctite F120 - Room Cure, 1 Hour at 65°C or 24 Hours at 25°C, Pot Life Estimate 5 Minutes, 2.5 gram	10.75
BAF112	Loctite 112 - Blue Dye, 15 Minutes at 90°C or 1 Hour at 65°C or 24 Hours at 25 degrees, Pot Life Estimate 30-60 Minutes, 2.5 gram	9.80
501202-1	Epoxy Mixer (Roller)	7.75

## ANAEROBIC ADHESIVE

This two-part system self cures in minutes with no heat required. The retaining compound is injected into the connector with a syringe needle. Dip or spray the fiber with primer and connectorize as usual. Sets in 30 seconds, fully cured in minutes. Domestic ground shipment only.

PART #	DESCRIPTION	PRICE
680	Anaerobic Adhesive Hardener, 10 milliliter	\$12.75
7649	Primer, 1.75 ounce	17.95
F1-ANAEROBICKIT	Kit (Anaerobic Adhesive-10ml, Primer 1.75oz and Syringe Tip)	65.00



## HYSOL EPOXY

Contained in two separate tubes or packets, the Hysol Epoxy can be heat or time cured. Hysol Epoxy is excellent for general connector use. A quick dry, 4 gram, mini packet is available for individual connector repair.

PART #	DESCRIPTION	PRICE
F1-707010	Hysol Epoxy (3.4 oz.) (10 sets in each case)	\$142.95
F1-608	Mini Packet (4gm) Fast Cure Epoxy	2.95



## ULTRAVIOLET (UV) ADHESIVE

PART #	DESCRIPTION	PRICE
WO-1057	UV Adhesive (1 oz. bottle)	\$45.50



353ND



BAF113SC



680

7649

F1-ANAEROBICKIT



F1-608

F1-707010



WO-1057

## EPOXY APPLICATION SYRINGE

When assembling multiple fiber optic connectors, these Epoxy Syringes enable you to work quickly and efficiently. The included dispensers (needles) enable you to easily inject epoxy into connectors. Economically priced, they can be replaced the moment the epoxy is no longer easily workable. A larger diameter 1.1mm applicator needle is also available, F1-4012, which can be used with the 501473-3IR empty syringe.

PART #	DESCRIPTION	PRICE
501473-3IRC5	Empty Syringe with .9mm Needle (5 pk.)	\$1.30
501473-3IRC25	Empty Syringe with .9mm Needle (25 pk.)	6.50
501473-3IRC100	Empty Syringe with .9mm Needle (100 pk.)	26.00
F1-4012	1.1mm Applicator Needle for CORNING/3M Connectors (25 pk.)	47.95

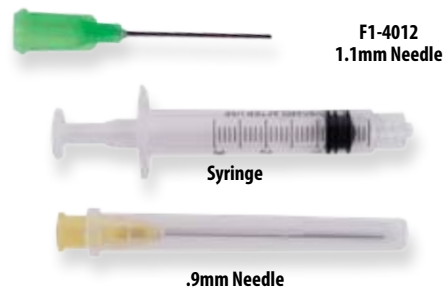

## FIS MPO/MTP CURING OVEN

Maximize productivity with the FIS MPO/MTP Cure Oven. Designed to cure up to 24 MPO/MTP ferrules at one time. The MPO/MTP Oven's temperature control is adjustable between 50° and 150°C to work with the cure schedules of all the popular brands of epoxies. The FIS MPO/MTP Cure Oven also features a built in timer for convenience. Like the rest of our family of connector cure ovens, the MPO/MTP Cure Oven is designed to be simple, durable and easy to use.

PART #	DESCRIPTION	PRICE
F19778	FIS MTP Curing Oven	\$1,570.00



## FIS CONNECTOR HEAT OVEN

To prevent epoxy "out gassing" that can cause fiber fractures and other connector problems, it is important that a connector curing oven provide reliable operation. The FIS Connector Oven is preferred by many installers because it is simple, dependable, and easy-to-use.

PART #	DESCRIPTION	PRICE
F1-9772	24 Port Heat Oven (FC/ST/D4/SMA/SC) 4011-0000 Included	\$275.00
F1-977220	24 Port Heat Oven (220 V) (FC/ST/D4/SMA/SC)4011-0000 Included	275.00
9091	MU/LC Holding Block	80.00
9090	Universal Holding Block (side A - ST, FC, SMA, D4, side B - Biconic, SC)	80.00
9092	MTRJ/MTP Ferrule Holding Block	80.00
4011-0000	24 Port Block (FC,ST,D4,SMA,SC)	80.00
F1-OVSTND	Curing Stand	30.95
8032-0000	Thermometer	17.95

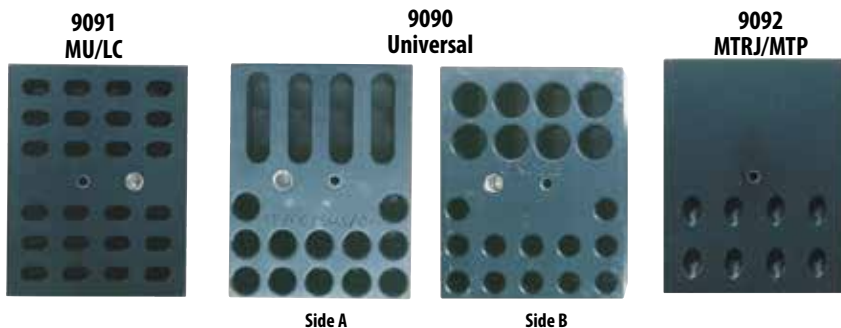

## OVEN PROTECTION SLEEVES

Use to prevent breakage of protruding fiber during connector heat oven curing process. These oven protection sleeves are reusable.

PART #	DESCRIPTION	PRICE
80879000M-100	Oven Protection Sleeve, 2.5mm Ferrules (100pk)	\$40.00
867730011	Molex Oven Protection Sleeve, 1.25mm Ferrules (Each)	\$2.25



## FIS HOT MELT AND DUAL PURPOSE HEAT OVENS

Sometimes, you may use epoxy-style connectors. Other times, you may prefer Corning/3M Hot-Melt connectors. This Dual Purpose Oven lets you use both! This unit includes an 8-port epoxy heater block, with temperature settings up to 100°C, and a 6-port hot melt block factory set at 245°C, which accepts 3M/Corning Hot Melt connectors. Each block has its own switch.

PART #	DESCRIPTION	PRICE
F1-9110	FIS 6 Port Hot Melt Oven (110v) (pictured) (Hot Melts Only)	\$460.00
F1-9110220	FIS 6 Port Hot Melt Oven (220v) (Hot Melts Only)	1,130.00
F1-9130	FIS 12 Port Hot Melt Oven (Hot Melts Only)	715.00
F1-9150	FIS 14 Port Dual Purpose Hot Melt / Standard Epoxy Oven	780.00
F1-5225	FIS ST/SC/FC Universal Connector Holder	46.95





**For Quality Assurance 3M™ Polish Film Is Sold Only In Factory Packs of 25 or 50. Order film in quantities of 25's or 50's.**

**Call for other grades, sizes and pressure sensitive adhesive (PSA) backed products.**

### 3M™ DIAMOND LAPPING FILMS

Premium diamond abrasive film to cut and polish hard ceramic ferrules and glass cores at the same level, at a consistent rate.

### 3M™ POLISHING FILM - MT

- Eliminates slurries and messy cleanup
- High first-pass yield minimizes rework
- Precisely graded particles are coated on a high-strength backing

### 3M™ LAPPING FILMS

- Micron graded materials on uniform polyester backing
- Provides consistent, repeatable finishes in sequence
- Use on ceramic, stainless steel, plastic and composite ferrules
- Innovative, cost-effective method to finish fiber optic connectors

### 3M™ FINAL POLISH DISCS

For final polishing fiber optic connectors, this film meets industry standards for back reflection.

- Eliminates slurries and messy cleanup
- High first-pass yield minimizes rework
- Meets Telcordia Standards GR-326

## 3M™ LAPPING FILM 5" DISCS

PART #	MATERIAL	GRIT	PACK SIZE	PACK PRICE
DLF5XN.5661X-25	Diamond	.5µm	25	\$118.95
DLF5XN01661X-25	Diamond	1µm	25	118.95
DLF5XN03661X-25	Diamond	3µm	25	118.95
DLF5XN06661X-25	Diamond	6µm	25	118.95
DLF5XN15661X-25	Diamond	15µm	25	118.95
A05XN.05263X-50	Aluminum Oxide	.05µm	50	25.00
A05XN.3263X-50	Aluminum Oxide	.3µm	50	26.95
A05XN03263X-50	Aluminum Oxide	3µm	50	25.00
SC5XN15461X-50	Silicon Carbide	15µm	50	25.00
HDF5XN0.5662XW-25	Diamond H	.5µm	25	125.00
HDF5XN01662XW-25	Diamond H	1µm	25	156.25
HDF5XN1.5662XW-25	Diamond H	1.5µm	25	156.25
HDF5XN03662XW-25	Diamond H	3µm	25	156.25
HDF5XN06662XW-25	Diamond H	6µm	25	156.25
863X5NH-50	5" Final Polish		50	132.50
865X5NH-50	5" Final Polish		50	195.00

## 3M™ POLISHING FILM - MT 5" DISCS

PART #	MATERIAL	GRIT	PACK SIZE	PACK PRICE
FCO-0.55XN598PSA-50	Cerium Oxide Flock Film PSA	0.5µm	50	\$98.95
FAO-0.55XN298PSA-50	Aluminum Oxide Flock Film PSA	0.5µm	50	177.35
FAO-015XN298PSA-50	Aluminum Oxide Flock Film PSA	1µm	50	100.95
FSC-035XN498PSA-50	Silicon Carbide Flock Film PSA	3µm	50	177.00
SC155XN468PSA-50	Silicon Carbide Lapping Film PSA	15µm	50	50.00
SC035XN468PSA-50	Silicon Carbide Lapping Film PSA	3µm	50	50.00
SC305XN468PSA-50	Silicon Carbide Lapping Film PSA	30µm	50	58.95

## 3M™ LAPPING FILM 4" DISCS

PART #	MATERIAL	GRIT	PACK SIZE	PACK PRICE
DLF4XN.5661X-50	Diamond	.5µm	50	\$235.00
DLF4XN01661X-50	Diamond	1µm	50	235.00
DLF4XN03661X-50	Diamond	3µm	50	235.00
DLF4XN06661X-50	Diamond	6µm	50	235.00
DLF4XN15661X-50	Diamond	15µm	50	275.00
A04XN.05263X-50	Aluminum Oxide	.05µm	50	30.00
A04XN.3263X-50	Aluminum Oxide	.3µm	50	25.00
A04XN03263X-50	Aluminum Oxide	3µm	50	25.00
SC4XN15461X-50	Silicon Carbide	15µm	50	25.00
HDF4XN0.5662XW-25	Diamond H	.5µm	25	168.25
HDF4XN01662XW-25	Diamond H	1µm	25	168.25
HDF4XN1.5662XW-25	Diamond H	1.5µm	25	168.25
HDF4XN03662XW-25	Diamond H	3µm	25	168.25
HDF4XN06662XW-25	Diamond H	6µm	25	168.25
863X4NH-50	4" Final Polish		50	115.75
865X4NH-50	4" Final Polish		50	246.50

## 3M™ LAPPING FILM 9" X 13" SHEETS

PART #	MATERIAL	GRIT	PACK SIZE	PACK PRICE
A09X130.3261X-50	Aluminum Oxide	.3µm	50	\$125.50
A09X1301262X-50	Aluminum Oxide	1µm	50	140.00
A09X1302262X-50	Aluminum Oxide	2µm	50	140.00
A09X1303261X-50	Aluminum Oxide	3µm	50	140.00
A09X1312261X-50	Aluminum Oxide	12µm	50	140.00
A09X1309261X-50	Aluminum Oxide	9µm	50	163.95
SC9X1305461X-50	Silicon Carbide	5µm	50	163.95
SC9X1315461X-50	Silicon Carbide	15µm	50	163.95
SC9X1330461X-50	Silicon Carbide	30µm	50	169.95

## 3M™ LAPPING FILM 9" X 6.5" SHEETS

PART #	MATERIAL	GRIT	PACK SIZE	PACK PRICE
A09X60.3261X-50	Aluminum Oxide	.3µm	50	\$81.95
A09X601262X-50	Aluminum Oxide	1µm	50	81.95
A09X602262X-50	Aluminum Oxide	2µm	50	81.95
A09X603261X-50	Aluminum Oxide	3µm	50	81.95
A09X609261X-50	Aluminum Oxide	9µm	50	81.95
SC9X605461X-50	Silicon Carbide	5µm	50	81.95
SC9X615461X-50	Silicon Carbide	15µm	50	81.95
SC9X630461X-50	Silicon Carbide	30µm	50	81.95

## 3M™ LAPPING FILM 6" x 6" SHEETS

PART #	MATERIAL	GRIT	PACK SIZE	PACK PRICE
DLF6X6.5661X-25	Diamond	.5µm	25	\$231.75
DLF6X601661X-25	Diamond	1µm	25	148.75
DLF6X603661X-25	Diamond	3µm	25	148.75
DLF6X606661X-25	Diamond	6µm	25	148.75
A06X6.05263X-50	Aluminum Oxide	.05µm	50	67.50
A06X603263X-50	Aluminum Oxide	3µm	50	50.75
A06X605261X-50	Aluminum Oxide	5µm	50	42.50
863X6X6NH-50	Final Polish		50	197.50

## 3M™ DIAMOND LAPPING FILM 3" X 6" SHEETS

PART #	GRIT	PACK SIZE	PACK PRICE
DLF3X601661X-25	1µm	25	\$124.75
DLF3X603661X-25	3µm	25	124.75



Attention Cable Assembly Houses  
FIS Proudly Offers Our

**Cable Assembly Partnership Program (CAP)**

FIS has joined with Manufacturers to offer preferred pricing and services under our Cable Assembly Partnership (CAP) Program. Cable Assembly Companies that qualify as CAP members will receive:

- Incredible pricing on cable, polish film, epoxy and connectors
- No quantity buys required
- Based on regular use of FIS and 3M products
- Limited memberships available
- Expanding product lines

## Let Us Quote A 3 Step Polishing Solution!

With 20 years of cable assembly experience, FIS can show you how to achieve maximum value using specific 3M™ Lapping Films. The following are our current recommendations. The films highlighted above provide exceptional value in terms of pricing and performance.

Steps	3M™ 5" Disc Value	Mineral	Micron Size / Color
#1 De-Nub and Epoxy Removal	461X	Silicon Carbide	15µm / Gray
#2 Refine (Level Connector)	661X	Diamond	1µm / Lav 3µm / PNK 6µm / BRW
	662XW	Diamond	1µm / Lav 3µm / PNK 6µm / BRW
#3 Polish (Finish)	863XW	Silicon Dioxide	Final Polish/Translucent
	865X	Silica	Final Polish / White

### FIS POLISH FILM-SOLD IN PACKS OF 25 SHEETS

When choosing polish film, you want to achieve two things; a high-quality end face finish, and maximum value for your money. FIS Polish Films provide both! Carefully graded abrasives are bonded with quality adhesives, enabling you to polish more connectors per sheet.

#### LARGE SHEETS 9" X 13"

PART #	MATERIAL	GRIT	COLOR	PACK SIZE	PACK PRICE
F1-0109-03	Aluminum Oxide	.3µm	White	25	\$42.95
F1-0109-1	Aluminum Oxide	1µm	Lt. Green	25	21.95
F1-0109-3	Aluminum Oxide	3µm	Pink	25	21.95
F1-0109-5	Silicon Carbide	5µm	Black	25	21.95
F1-0109-9	Aluminum Oxide	9µm	Lt. Blue	25	21.95
F1-0109-12	Aluminum Oxide	12µm	Dark Yellow	25	21.95
F1-0109-15	Silicon Carbide	15µm	Dark Grey	25	21.95
F1-0109-5-1-03	3 in 1 Film	(5, 1, .3µm)		25	35.95

#### STANDARD SHEETS 9" X 6.5"

PART #	MATERIAL	GRIT	COLOR	PACK SIZE	PACK PRICE
F1-0102-03	Aluminum Oxide	.3µm	White	25	\$23.95
F1-0102-1	Aluminum Oxide	1µm	Lt. Green	25	11.95
F1-0102-3	Aluminum Oxide	3µm	Pink	25	11.95
F1-0102-5	Silicon Carbide	5µm	Black	25	11.95
F1-0102-9	Aluminum Oxide	9µm	Lt. Blue	25	11.95
F1-0102-12	Aluminum Oxide	12µm	Dark Yellow	25	11.95
F1-0102-15	Silicon Carbide	15µm	Dark Grey	25	11.95

#### FIS DIAMOND POLISH FILM SHEETS (Sold in packs of 10.)

PART #	DESCRIPTION	GRIT	COLOR	PACK SIZE	PACK PRICE
F1-010715-10	3" x 6" Sheet	1µm	Violet	10	\$47.95
F1-010735-10	3" x 6" Sheet	3µm	Pink	10	47.95
F1-010730S-10	3" x 6" Sheet	30µm	Green	10	57.95

#### FIS MACHINE POLISHING DISCS (Sold in packs of 10 and 25 discs.)

PART #	SIZE	TYPE	GRIT	COLOR	PACK SIZE	PACK PRICE
F1-010705D-25	4" diameter	Aluminum Oxide	.05µm	Yellow	25	\$19.95
F1-01071DD-10	4" diameter	Diamond	1µm	Violet	10	38.95
F1-01073DD-10	4" diameter	Diamond	3µm	Pink	10	38.95
F1-01076DD-10	4" diameter	Diamond	6µm	Grey	10	38.95
F1-010730DD-10	4" diameter	Diamond	30µm	Green	10	38.95
F1-010805D	5" diameter	Aluminum Oxide	.05µm	Yellow	25	\$11.95
F1-01081DD-10	5" diameter	Diamond	1µm	Violet	10	50.00
F1-01083DD-10	5" diameter	Diamond	3µm	Pink	10	50.00
F1-01086DD-10	5" diameter	Diamond	6µm	Brown	10	50.00
F1-010830DD-10	5" diameter	Diamond	30µm	Green	10	51.25





SFP-560A2



## SFP-560A RUGGEDIZED POLISH MACHINE

Seikoh Giken's SFP-560A provides high volume assemblers with an ultra ruggedized polisher for long hours and everyday operation. Mechanical durability, low operational costs and reduced maintenance requirements offer near zero downtime for maximum return on investment.

PART #	DESCRIPTION	PRICE
SFP-560A2	SFP-560A Ruggedized Polish Machine	\$21,950.00

## SFP-550C MASS PRODUCTION POLISHING MACHINE

This high-performance polish machine offers superior quality and maximum throughput at a very affordable price. Utilizing a patented, high speed rotation and revolution method, this polisher prepares connectors which exceed Telcordia GR-326 requirements for end face geometry. Standard capacity 18 connectors, up to 48 LC/MU.

### FEATURES

- Compatible with all existing SFP series I.P.C. Holders
- Increased turntable speed
- Exceeds all requirements for GR-326 End-Face Geometry requirement

### STANDARD PACKAGE - SFP550C

DESCRIPTION	PART #	QTY
Main Body	SFP-550C	1
Cable Holder	FP-CH	1
Operating Manual	FP-IM12	1
Process Manual	FP-MM12	1
Maintenance Manual	FP-PM12	1
2A Fuse	FP-F2A	1
Hexagon Wrench	FP-TS	1



SFP-550C



PART #	DESCRIPTION	PRICE
SFP-550C	SFP-550C Polisher with standard package	\$9,700.00
SFP-550E3	SFP-550E3 High Capacity Programmable Polisher with standard package	13,175.00
PH55-FP-20	FC/PC Polish Fixture (20 position)	4,025.00
PH55-FP8RC-18-1	FC/APC Polish Fixture (18 position)	4,800.00
PH55-CP-20	SC/PC Polish Fixture (20 position)	4,025.00
PH55-CP8C-18	SC/APC Polish Fixture (18 position)	4,800.00
PH55-SP-20	ST/PC Polish Fixture (20 position)	4,025.00
PH55-PL-24	LC Polish Fixture (24 position)	4,200.00
PH55-MT-24S1	MT/PC Fixture, 24 Position (1mm Protrusion Type)	6,700.00

### ACCESSORIES FOR SFP-550C

PART #	DESCRIPTION	QTY.	PRICE
GASD	30µm Silicon Carbide Adhesive Removal Film	500	\$264.00
DR5D-9U	9µm Diamond Rough Polish Film	20	88.00
DG5D-5U	5µm Diamond Rough Polish Film	20	88.00
DH5D-3U	3µm Diamond Middle Polish Film	20	88.00
DI5D-1.5U	1.5µm Diamond Middle Polish Film	20	88.00
SF5D	1µm Aluminum Oxide Final Polish Film	500	390.00
XF5D	0.5µm Silica Final Polish Film	100	210.00



PH55-MT24S1

## SFP-70D2 POLISHING MACHINE

The Seikoh Giken SFP-70D2 polishing machine polishes 2 ferrules at a time. It is best suited for lab use and as a re-polishing solution at mass production line. Its portability and light weight make this machine great for field polishing and re-polishing.

### FEATURES

- High performance polishing for a variety of applications
- Ergonomic, simple design for ease of use
- Uses SG patented Independent Pressure Control
- Short cycle times (2 min. typical for reworks)

PART #	DESCRIPTION	PRICE
SFP-70D2	Programmable Polisher with standard accessories	\$3,500.00
PH072-FP-2	FC/PC Polish Fixture (2 position)	500.00
PH072-FP8RC-2	FC/APC Polish Fixture (Conical Narrow Key)	1,000.00
PH072-CP-2	SC/PC Polish Fixture (2 position)	500.00
PH072-CP8C-2	SC/APC Polish Fixture (Conical 2 position)	1,000.00
PH072-SP-2	ST/PC Polish Fixture	500.00
PH072-PL-2	LC/PC Polish Fixture	500.00

### ACCESSORIES FOR SFP-70D2

PART #	DESCRIPTION	PACK QTY.	PACK PRICE
GA07	Height Adjustment Polishing Film	200	\$81.00
DR07-9U	9µm Diamond Rough Polishing Film	20	100.00
DH07-3U	3µm Diamond Medium Polishing Film	20	100.00
XF07	Final Polishing Film	100	200.00



SFP-70D2





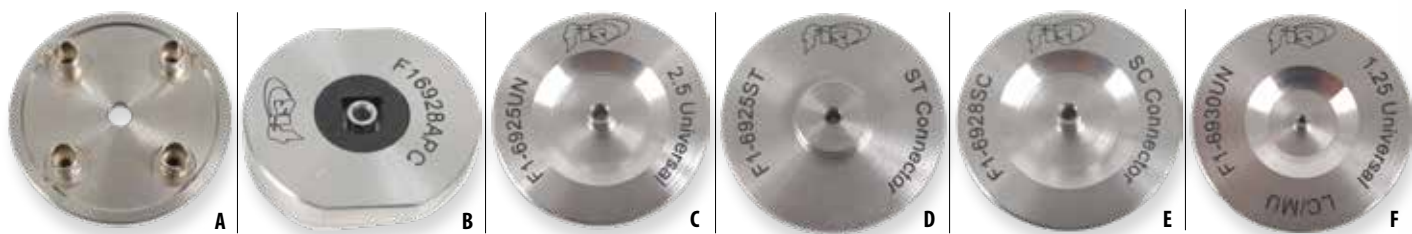

## HAND POLISHING DISCS

The metal fiber optic polishing discs are especially durable and are machined to close tolerances. They are designed to hold your fiber optic endface at exactly the correct angle to the polishing film during the polishing process.

PART #	DESCRIPTION	PRICE
F1-6925UN	ST/SC/FC Universal 2.5mm Polish Disc (C)	\$45.00
F1-6925ST	ST Polish Disc (D)	45.00
F1-6977ST	ST 4 Position Polish Disc (A)	125.00
F1-6928SC	SC Polish Disc (E)	45.00
F1-6928APC	SC/APC Polish Disc (B)	75.00
F1-6925FC	FC/PC Polish Disc	45.00
F1-6925FCAPC	FC/APC Polish Disc	75.00
F1-6930UN	MU/LC Polish Disc (F)	45.00
F1-6900APC	LC/APC Polish Disc	75.00
F1-6925SMA	SMA Polish Disc	45.00
F1-6926	D4 Polish Disc	85.00
F1-6927	Biconic Polish Disc (may not work with all brands)	150.00

## ULTRA PRECISION POLISHING PADS

Ultra Pads are color coded for easy recognition by the machine operators. 4" and 5" discs are .079" thick and 6" x 6" squares are 0.250" thick.

PART #	DESCRIPTION	PRICE
F1-70D4	4" Circular Rubber Pad 70 Durometer (purple)	\$23.95
F1-90D4	4" Circular Rubber Pad 90 Durometer (black)	23.95
F1-70D5	5" Circular Rubber Pad 70 Durometer (purple)	23.95
F1-90D5	5" Circular Rubber Pad 90 Durometer (black)	23.95
F1-70DX6	6" x 6" Square Rubber Pad 70 Durometer (purple)	23.95
F1-90DX6	6" x 6" Square Rubber Pad 90 Durometer (black)	23.95



## POLISH PLATES, PADS AND MATS

The polishing of fiber optic connectors calls for both a hard flat surface and a cushioned pad. The 9" x 13" or 6" x 9" polish plate is available in safety glass and mounted on four rubber feet for support. When polishing PC style pre-radius connectors, use the soft polish pad on the glass plate. Placing the lapping film over the pad assures the removal of epoxy and proper polish of fiber without destroying the pre-radius of the ferrule.

PART #	DESCRIPTION	PRICE
F1-9111	FIS Polish Glass Plate (9" x 13") (A)	\$29.95
F1-9111A	FIS Polish Glass Plate (6" x 9") (B)	20.50
PP-575	5.75" Square Polishing Pad, 1/16" Thick 70 Durometer (C)	7.50
F1-0024	Large Black Work Mat (22" x 14") (D)	9.75
PPG-575	5.75" Square Polishing Pad with 1/4" Acrylic Plate (not pictured)	20.50

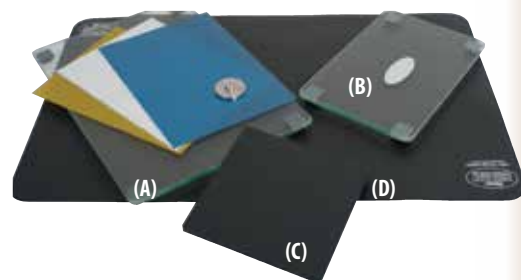

### DID YOU KNOW...

#### What is meant by the term "Air Polish"?

After curing an epoxy connector and removing from oven the exposed fiber tip is typically scribed and picked off, then disposed in shards container. The remaining small tip of fiber then left protruding out the end of the ferrule is removed by an "Air Polish". Refer to manufacturer termination instructions but often a 5um silicon carbide film is utilized and by holding the connector in one hand and the film in the opposite hand technician can "Air Polish." Gently brush the dull looking side of the film with exposed fiber tip in a "figure 8" motion until the fiber tip is almost flush with the ferrule endface. Often you will also remove some of the epoxy bead but be sure to stop prior to removing the entire epoxy bead as the following polish steps to not use an aggressive grit size to remove scratches below ferrule tip.

# CONNECTIVITY | MALE - FEMALE ADAPTERS



**F1-8705-CSTSCS**  
ST (male) - SC (female) (Singlemode)  
Metal Housing  
Zirconia Sleeve  
\$25.00



**F1-8705-CSCFCS**  
SC (male) - FC (female) (Singlemode)  
Polymer Housing  
Zirconia Sleeve  
\$25.00



**F1-8705-CSTFCS**  
ST (male) - FC (female) (Singlemode)  
Metal Housing  
Zirconia Sleeve  
\$25.00



**F1-8705-SCSCS**  
SC (male) - SC (female) (Singlemode)  
Polymer Housing  
Zirconia Sleeve  
\$25.00



**F1-8705-CSCST**  
SC (male) - ST (female) (62.5/125µm)  
Polymer Housing  
Zirconia Sleeve  
\$20.00



**F1-8705-STST**  
ST (male) - ST (female) (62.5/125µm)  
Metal Housing  
Zirconia Sleeve  
\$20.00



**F1-FCLCMF**  
FC (male) - LC (female) (Singlemode)  
Metal Housing  
Zirconia Sleeve  
\$35.00



**F1-LCSCMF**  
LC (male) - SC (female) (Singlemode)  
Polymer Housing  
Zirconia Sleeve  
\$28.95



**F1-SCLCMF**  
SC (male) - LC (female) (Singlemode)  
Polymer Housing  
Zirconia Sleeve  
\$28.95



**1102-0000100**

**924700A099100**

**1102-0000100** Stainless Phillips Head Machine Thread Screws for Flanged Adapters 5/16"(8mm) Length 100/pack **\$11.75**

**924700A099100** Stainless Phillips Head Tapping Thread Screws for Flanged Adapters 5/16"(8mm) Length 100/pk **\$11.75**



**F1-8705-CSCSTS**  
SC (male) - ST (female) (Singlemode)  
Polymer Housing  
Zirconia Sleeve  
\$25.00

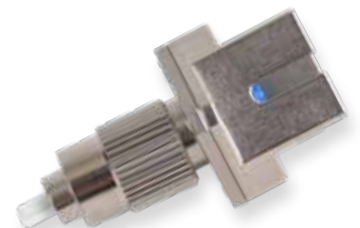

**F1-8705-CFCSCS**  
FC (male) - SC (female) (Singlemode)  
Metal Housing  
Zirconia Sleeve  
\$28.95



**F1-4732**  
SMA905 (female) - ST (female) (SM/MM)  
Metal Housing  
Zirconia Sleeve  
\$25.00



**F1-29202**  
ST (female) - FC (female) (SM/MM)  
Metal Housing  
Zirconia Sleeve  
\$3.95



**F1-19202**  
SC (female) - ST (female) (SM/MM)  
Metal Housing  
Zirconia Sleeve  
\$2.95



**F1-34202**  
SC (female) - FC (female) (SM/MM)  
Metal Housing  
Zirconia Sleeve  
\$3.75



**F1-2821CC**  
FC/APC (female) - SC/APC (female) (Square Flange)  
Metal Housing  
Zirconia Sleeve  
\$4.75



**F1-2822CC**  
FC/APC (female) - SC/APC (female) (Rectangular Flange)  
Metal Housing  
Zirconia Sleeve  
\$4.75

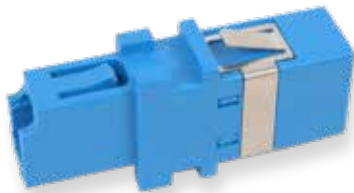

**F1-SCLFF**  
SC (female) - LC (female)  
Polymer Housing  
Zirconia Sleeve  
\$23.95



**F1-SCMUFF**  
SC (female) - MU (female)  
Polymer Housing  
Zirconia Sleeve  
\$35.00



**F1-LCMUFF**  
LC (female) - MU (female) (SM/MM)  
Polymer Housing  
Zirconia Sleeve  
\$23.95

## FIS SINGLEMODE FIBER OPTIC ADAPTER KIT

The FIS fiber optic adapter kit provides installers with all the popular mating sleeves to test or plug in fiber optic cables. **Perfect for Installers. Singlemode adapters work for multimode connectors.**

PART #	DESCRIPTION	PRICE
F1-ADPTKIT	FIS Adapter Kit (includes 24 adapters)	\$79.00

### KIT CONTENTS (CONTAINS TWO OF EACH):

LC-LC, LC/APC-LC/APC, SC-SC, SC/APC-SC/APC, ST-ST, FC-FC, FC/APC-FC/APC, FC/APC-SC/APC, SC-FC, FC-ST, SC-ST, MU-MU



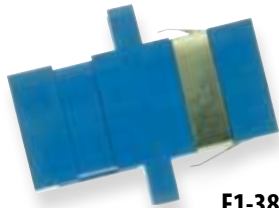

**F1-3810BC**  
Singlemode - Blue  
SC - Style 3  
Polymer Housing  
Zirconia Sleeve  
\$2.00



**F1-8601**  
Duplex Singlemode - Blue  
SC - Style 3  
Polymer Housing  
Zirconia Sleeve  
\$3.50



**F1-8601NF**  
Duplex Singlemode - Blue (No Flange)  
SC - Style 5  
Polymer Housing  
Zirconia Sleeve  
\$2.25



**F1-4800T**  
Singlemode APC - Green  
SC - Style 3  
Polymer Housing  
Zirconia Sleeve  
\$2.00



**F1-4800NFT**  
Singlemode APC - Green (No Flange)  
SC - Style 5  
Polymer Housing  
Zirconia Sleeve  
\$1.25



**F1-8701**  
Duplex Singlemode APC - Green  
SC - Style 3  
Polymer Housing  
Zirconia Sleeve  
\$3.75

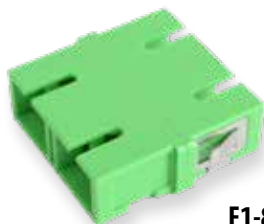

**F1-8701NF**  
Duplex Singlemode APC - Green (No Flange)  
SC - Style 5  
Polymer Housing  
Zirconia Sleeve  
\$1.25



**F1-8650**  
Duplex Multimode - 10 Gig - Aqua  
SC - Style 3  
Polymer Housing  
Zirconia Sleeve  
\$3.25



**F1-8350NF**  
Multimode - 10 Gig - Aqua (No Flange)  
SC - Style 5  
Polymer Housing  
Zirconia Sleeve  
\$1.00



**F1-8600ET**  
Duplex Multimode - Beige (No Flange)  
SC - Style 5  
Polymer Housing  
Phos. Bronze Sleeve  
\$2.75

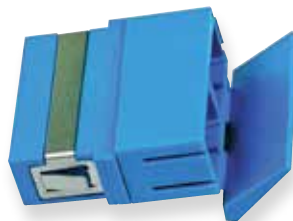

**F1-SCRD**  
Duplex Singlemode - Blue (No Flange)  
SC - Style 5 with Shutter  
Polymer Housing  
Zirconia Sleeve  
\$5.25



**F1-8620**  
Duplex Multimode - Black  
SC - Style 3  
Polymer Housing  
Phos. Bronze Sleeve  
\$2.75

**Call Your FIS Sales Representative  
for availability of other adapters!**



**F18005NF**  
Singlemode –Blue (No Flange)  
LC - Style 5  
Polymer Housing  
Zirconia Sleeve  
\$1.75



**F1-8035**  
Duplex Singlemode-Blue  
LC - Style 3  
SC Footprint  
Polymer Housing  
Zirconia Sleeve  
\$3.75



**F1-8050NF**  
Duplex Multimode – 10  
Gig Aqua (No Flange)  
LC - Style 5  
SC Footprint  
Polymer Housing  
Zirconia Sleeve  
\$2.75



**F1-8010NF**  
Duplex Singlemode – Blue  
(No Flange), Square  
LC - Style 5  
Polymer Housing  
Zirconia Sleeve  
\$2.95



**F1-LCAD02R**  
Duplex Singlemode – Blue  
LC - Style 3 with Shutter  
SC Footprint  
Polymer Housing  
Zirconia Sleeve  
\$5.35



**F1-8008**  
Singlemode - APC - Green  
LC APC - Style 5  
SC Footprint  
Polymer Housing  
Zirconia Sleeve  
\$2.00



**F1-8018**  
Duplex singlemode APC - Green  
LC APC  
Style 3 - SC Footprint  
Polymer Housing  
Zirconia Sleeve  
\$4.25



**F1-8015NF**  
Duplex Singlemode APC –  
Green (No Flange)  
LC APC - Style 5  
SC Footprint  
Polymer Housing  
Zirconia Sleeve  
\$3.25



**F1-8000A**  
Multimode-Beige (No Flange)  
LC - Style 5  
Polymer Housing  
Phos. Bronze Sleeve  
\$1.50



**F1-8030**  
Duplex Multimode-Beige  
LC - Style 3  
SC Footprint  
Polymer Housing  
Phos. Bronze Sleeve  
\$2.95



**F1-8020CNF**  
Duplex Multimode-Beige (No Flange)  
(No Flange), Square  
LC - Style 5  
Polymer Housing  
Zirconia Sleeve  
\$2.25



**F1-8050**  
Duplex MM -10 Gig - Aqua  
LC - Style 3  
SC Footprint  
Polymer Housing  
Phos. Bronze Sleeve  
\$3.00



**F1-8045NF**  
Quad Singlemode-Blue (No Flange)  
LC - Style 5  
SC Duplex Footprint  
Polymer Housing  
Zirconia Sleeve  
\$4.10



**F1-8040**  
Quad Multimode-Beige  
LC - Style 3  
SC Duplex Footprint  
Polymer Housing  
Phos. Bronze Sleeve  
\$5.00



**F1-8041**  
Quad Multimode -10 Gig - Aqua  
LC - Style 3  
SC Duplex Footprint  
Polymer Housing  
Phos. Bronze Sleeve  
\$5.00



**1102-0000100**

**92470A099100**

**1102-0000100** Stainless Phillips Head  
Machine Thread Screws for Flanged Adapters  
5/16" (8mm) Length 100/pack **\$11.75**

**924700A099100** Stainless Phillips Head  
Tapping Thread Screws for Flanged Adapters  
5/16" (8mm) Length 100/pk **\$11.75**

Please refer to "style" Columns when making your selection.



Floating Style 1



Threaded Style 2

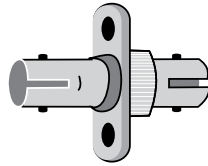

Flanged Style 3

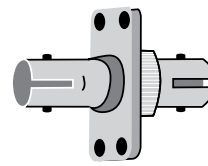

Rectangular Flanged Style 4

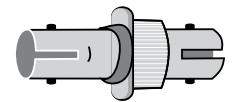

No Flanged Style 5



F1-8102SS



8119



6113



106110-1000



F1-8501S



F1-8520



8211APC



106152-0100



F1-890M



106102-0000



F1-5910S



F1-5915

**ST ADAPTERS**

PART #	TYPE	STYLE	HOUSING	SLEEVE	PRICE
F1-8102SS	Multimode	2	Metal	Phos. Bronze	\$1.30
F1-8200A	Singlemode	2	Metal	Zirconia	1.30

**CORNING**

6112	Multimode	2	Metal	Phos. Bronze	\$2.95
8119	Singlemode	2	Metal	Zirconia	2.85
6113	Duplex Multimode	2	Metal	Phos. Bronze	4.75
8113	Duplex Singlemode	2	Metal	Zirconia	4.95

**MOLEX**

106110-1000	Singlemode	2	Metal	Zirconia	\$4.50
-------------	------------	---	-------	----------	--------

**MT-RJ ADAPTERS**

PART #	TYPE	STYLE	HOUSING	PRICE
F1-890M	SM / MM	SC Footprint	Polymer	\$1.65

**FC ADAPTERS**

PART #	TYPE	STYLE	HOUSING	SLEEVE	PRICE
F1-8501SZ	Multimode	4	Metal	Zirconia	\$2.50
F1-8510	Multimode	2	Metal	Phos. Bronze	2.50
F1-8520	SM / MM	2	Metal	Zirconia	3.50
F1-8521S	Singlemode - APC	4	Metal	Zirconia	3.75
F1-8525	Singlemode - APC	2	Metal	Zirconia	3.75

**CORNING**

8211	Singlemode	2	Metal	Zirconia	\$4.75
8211APC	Singlemode - APC	2	Metal	Zirconia	5.25

**MOLEX**

106152-0100	SM / MM	4	Metal	Zirconia	\$7.45
106152-1000	SM / MM	2	Metal	Zirconia	6.25
106152-3000	Singlemode - APC	2	Metal	Zirconia	5.75

**MU ADAPTERS**

PART #	TYPE	HOUSING	SLEEVE	PRICE
F1-5910S	Singlemode	Simplex - Polymer	Zirconia	\$5.00
F1-5915	Singlemode	Duplex - Polymer	Zirconia	6.70

Multimode Available  
Call For More Information



F1-8721AXX



F1-8731AXX

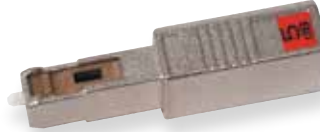

F1-9521AXX



F1-9621AXX



F1-8751AXX

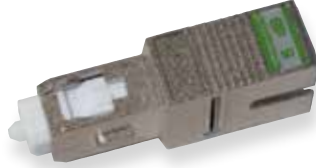

F1-8741AXX



F1-8761AXX



F1-8771AXX

## SINGLEMODE MALE-TO-FEMALE ATTENUATORS

FIS male-to-female attenuators contain doped fiber suitable for both Singlemode wavelengths 1310nm and 1550nm operation. Fixed attenuation values are available in 1dB increments from 1 to 20dB. FIS stocks standard 5, 10, 15, 20dB attenuation levels in most styles.

Attenuation Tolerance: 1 to 10dB  $\pm$  0.5dB; 11 to 30dB  $\pm$  5% | Operating Temperature: -40°C to +75°C | ORL: UPC  $\geq$  55dB / APC  $\geq$  65dB

TO SPECIFY ATTENUATION LEVEL REPLACE "XX" with desired attenuation level ex. 01=1dB, 02=2dB, 03=3dB, 04=4dB, etc. (Attenuators up to 20dB in stock.)

PART #	DESCRIPTION	PRICE
F1-8721AXX	FC/UPC Male to Female Attenuator	\$10.25
F1-8751AXX	FC/APC Male to Female Attenuator	11.95
F1-8731AXX	SC/UPC Male to Female Attenuator	10.25
F1-8741AXX	SC/APC Male to Female Attenuator	11.95
F1-9621AXX	ST/UPC Male to Female Attenuator	10.25
F1-8761AXX	LC/UPC Male to Female Attenuator	11.95
F1-8771AXX	LC/APC Male to Female Attenuator	13.95
F1-9521AXX	MU/UPC Male to Female Attenuator	13.95

## FIS SINGLEMODE BULKHEAD FEMALE-TO-FEMALE ATTENUATORS

FIS Bulkhead Attenuators utilize a wavelength sensitive neutral density filter to achieve attenuation. Available in 5, 10, 15 and 20dB values. Select from 1310nm or 1550nm options.

Attenuation Tolerance: 1 to 10dB  $\pm$  0.5dB; 11 to 30dB  $\pm$  5% | Operating Temperature: -40°C to +75°C | ORL: UPC  $\geq$  55dB / APC  $\geq$  65dB



SC



ST

### ST ATTENUATOR 1310nm/1550nm

PART #	DESCRIPTION	PRICE
F18125SF	FIS ST Bulkhead Attenuator SM 1310/1550nm 5dB	\$10.95
F18126SF	FIS ST Bulkhead Attenuator SM 1310/1550nm 10dB	10.95
F18127SF	FIS ST Bulkhead Attenuator SM 1310/1550nm 15dB	10.95
F18128SF	FIS ST Bulkhead Attenuator SM 1310/1550nm 20dB	10.95

### SC ATTENUATOR 1310nm/1550nm

PART #	DESCRIPTION	PRICE
F18325SF	FIS SC SM Bulkhead Attenuator 1310/1550nm 5dB	\$10.95
F18326SF	FIS SC SM Bulkhead Attenuator 1310/1550nm 10dB	10.95
F18327SF	FIS SC SM Bulkhead Attenuator 1310/1550nm 15dB	10.95
F18328SF	FIS SC SM Bulkhead Attenuator 1310/1550nm 20dB	10.95

## FIS BULK MATING SLEEVE ADAPTERS

FIS multimode and singlemode ST, SC, LC and FC adapters bulk packaged in lots of 100 pieces. These adapters offer the best value in performance and cost savings.

PART #	DESCRIPTION	PRICE
F1-8102SS-100	FIS MM ST - (100 pk.)	\$117.00
F1-8200A-100	FIS SM ST - (100 pk.)	117.00
F1-8020NF-100	FIS MM LC Duplex - (100 pk.), Beige, Square Footprint	200.00
F1-8010NF-100	FIS SM LC Duplex - (100 pk.), Blue, Square Footprint	200.00
F1-8520-100	FIS SM FC Style 2 - (100 pk.)	300.00
F1-3800BC-100	FIS MM SC Beige - (100 pk.)	90.00
F1-3810BC-100	FIS SM SC Blue - (100 pk.)	157.00
F1-4800BC-100	FIS SM SC/APC Green - (100 pk.)	200.00
F1-8600ET-100	FIS MM SC Duplex - (100 pk.), Beige	250.00



Other part numbers available upon request

F1-3800BC-100



F1-0031-40C

## VARIABLE ATTENUATORS

This Variable Attenuator uses collimator lens technology enabling the user to change attenuation through the twist of a top-mounted screw. Use this variable attenuator to simulate the loss in a fiber system or testing your system's dynamic range. A power meter and light source can be used to determine the fixed attenuation value your system requires. The attenuator has a 0.8dB typical insertion loss and is available in a 2 meter length and may be connectorized. A low back reflection style is prepared with ultra PC connectors maintaining the internal low back reflection characteristics. Attenuation range: 0.8dB to 60dB.

PART #	DESCRIPTION	PRICE
F1-0031-40C	SM Attenuator 8-9µm Core (2 Meter Unconnectorized) Return Loss <-40dB	\$150.00
F1-1033-35C	MM Attenuator 62.5µm Core (2 Meter Unconnectorized) Return Loss <-35dB	225.00
F1-0031-LBR	SM Low Back Reflection Attenuator with FC/UPC Connector Return Loss <-50dB	175.00



F1-2250

## AIR-GAP VARIABLE ATTENUATORS

The Air-Gap Variable Attenuator has a ceramic alignment sleeve that provides a low insertion loss of .15dB and can be used on both multimode and singlemode applications. Included tool provides ability to increase attenuation to desired "level". Device may replace mating sleeve at the patchpanel, enabling variable attenuation levels to be introduced to the system. Attenuation range is 0dB to 20dB.

PART #	DESCRIPTION	PRICE
F1-2250	Air-Gap Variable ST Attenuator	\$62.75
F1-2251	Air-Gap Variable FC Attenuator	62.75



## FIS IN-LINE FIXED ATTENUATORS

The FIS In-Line Fixed Attenuator is built to meet your low reflection attenuation requirements. Each cord is custom built to accommodate up to 10 meters of cable and the connector styles of your choice. The 5dB and 10dB versions hold a +/- .5dB tolerance with the 15dB and 20dB holding a 1dB tolerance. Please specify operating wavelength. The in-line attenuator provides negligible back reflection and is therefore recommended for use with UPC or APC style patch cable.

PART #	DESCRIPTION	PRICE
F1-ATS + 5dB or 10dB	In-line Attenuator	patch cable price + \$39.00
F1-ATS + 15dB or 20dB	In-line Attenuator	patch cable price + 49.00

FOR USE WITH 3mm JACKETED CABLE



F1-10015

## FIS 3-STEP ATTENUATORS

The FIS 3-Step Attenuator is a completely passive device and achieves attenuation by exceeding the recommended bend radius specifications of the fiber cable, including ClearCurve fiber, without introducing back-reflections. This unit is designed for 3mm jacket types and a wavelength of 1310nm, but can also be used with various jacket sizes and wavelengths with varying attenuation levels. Use any combination of the three loops to achieve desired attenuation levels.

PART #	DESCRIPTION	PRICE
F1-10007	3-Step Attenuator 2-7dB (1310nm Singlemode) *	\$31.50
F1-10015	3-Step Attenuator 5-15dB (1310nm Singlemode) *	31.50
F1-10020	3-Step Attenuator 5-20dB (1310nm Singlemode) *	31.50

\*Note: Performance / Attenuation levels differ with new Bend Insensitive fiber

FOR USE WITH 3mm JACKETED CABLE



F1-0045

## FIS CLIP-ON VARIABLE ATTENUATOR

The Clip-On Variable Attenuator is a completely passive device, which works by physical attenuation of a 3mm jacketed singlemode cable. May be used with smaller jacket sizes however, attenuation performance may vary. It can be attached at any point in a cable, providing attenuation levels from 0 to >47dB at 1550nm (0 to >21dB at 1310nm) and low back reflection. Good for hundreds of uses, and leaves no lasting effects on the cable. Dimensions: Length = 1 1/2", Diameter = 3/4"

PART #	DESCRIPTION	PRICE
F1-0045	Clip-On Variable Attenuator *	\$49.00

\*Note: Performance / Attenuation levels differ with new Bend Insensitive fiber



## TYPICAL ATTENUATION LEVELS (Installed At Light Source)

COLOR	850nm (dB)	1300nm (dB)
Red	2.5	7.4
Blue	3.6	9.1
Green	4.8	10.2
Gold	5.5	11.3
Silver	6	11.7

## FIS ST, SMA OR FDDI FIXED ATTENUATORS

The washer style attenuator is placed at the light source, spacing the mated connectors to cause attenuation. The attenuators of various thicknesses are not assigned specific dB values, several factors will dictate actual loss.

PART #	DESCRIPTION	PRICE
A450-FIS	ST Attenuators (Qty. 5) 1 Each Color	\$12.75 set
A40D-FIS	SMA Attenuators (Qty. 5) 1 Each Color	12.75 set
A450-FDDI	FDDI Attenuators (Qty. 10) 2 Each Color	28.25 set
A450-20	ST Attenuators (Qty. 10), State Color	28.60
A40D-20	SMA Attenuators (Qty. 10), State Color	28.60



# FIBER FENCE Security System

Your application may be perimeter fence monitoring or delivering a no-spark sensor signal miles in distance for detection. Utilizing an infrared light source through optical fiber is a cost effective reliable solution. Zone mapping software constantly alerts you of a zone violation. Call FIS and we design and quote your security system for you.



## APPLICATIONS



AGRICULTURE



MANHOLE COVERS



MINING OPERATIONS



NO SPARK ENVIRONMENTS

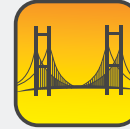

PIPELINES, RAILS, BRIDGES



CHEMICAL PLANTS

**OUTDOOR LONG DISTANCE SECURITY**  
 Call 800-5000-FIS(347) to Design and Quote Your Security System.

Monitor 10 Acres For Less Than \$1,000

### FIBER FENCE 10 ACRE KIT

The kit contains everything you need to monitor a 10 acre perimeter. You receive a Zone Control Unit, 53 Mini Mouse trips, 4 Corner Guards, 3,000ft FIBER FENCE fiber, zip ties, and an Instruction Manual. We can help with your design and other fiber optic tools and products.

PART #	DESCRIPTION	PRICE
OMS-FF10KIT	Fiber Fence 10 Acre Kit	\$995.00

### ZONE CONTROL UNIT

The heart of the FIBER FENCE Security System is the Zone Control Unit. A powerful laser sends light to the fence and sensors. The Zone Control Unit utilizes 9v DC power and may be rack mounted in a remote location. The Zone Control Unit is available in the 23dB range 1310nm single mode fiber coupled laser version.

PART #	DESCRIPTION	PRICE
OMS-CML	Zone Control Unit (10 mile range)	\$495.00

### OPTI-MAG SENSOR - THE "COVER COP"

The "Cover Cop" is sealed and contains a powerful internal magnet and spring mechanism. It is mounted in the specified proximity to the selected target (i.e. door, manhole cover or gate). When the target is moved away from the sensor, attenuation is created thus triggering the Zone Control Unit. Each "Cover Cop" is rated for approximately 10,000 cycles.

PART #	DESCRIPTION	PRICE
OMS-PRX	FIBER FENCE Opti-Mag Proximity Sensor	\$105.00

### FIBER FENCE MINI MOUSE TRIP SENSOR

The Mini Mouse Trip is a passive sensor designed to be mounted to the fence. It secures the fiber to the fence and will create attenuation triggering an alarm when the fiber or fence is disturbed. The sensor does not require a manual reset.

PART #	DESCRIPTION	PRICE
OMS-MMT	FIBER FENCE Mini Mouse Trip Sensor	\$5.95

### FIBER FENCE MOUSE TRIP™ SENSOR

The Mouse Trip sensors are designed to be mounted to the fence and are tripped when the fence is disturbed. Triggered sensors must be reset.

PART #	DESCRIPTION	PRICE
OMS-MT	FIBER FENCE Mouse Trip Sensor	\$69.00

### ZONE MAPPING SOFTWARE

The Zone Mapping Software allows the user to input a map and identify the perimeter with multiple zones. Each zone is protected by a Zone Control Unit. The software can also send text or e-mail messages for alarms and resets if the computer has internet access.

PART #	DESCRIPTION	PRICE
OMS-ZMAP	Zone Mapping Software	\$350.00

### FIBER CABLE

The 900µm specially jacketed fiber cable can be customized to include connectors, Loop-Back modules to return to the Control Unit, and cut to length upon request.

PART #	DESCRIPTION	PRICE
OMS-SMPX	Simplex Bend Sensitive FIBER FENCE Singlemode Fiber	.45 per mt
OMS-DPX	Duplex Bend Sensitive FIBER FENCE Singlemode Fiber	.65 per mt
OMS-CNG	Corner Guard	\$7.50



OMS-CML



OMS-PRX



OMS-MMT



OMS-MT



OMS-ZMAP

Note: When possible, additional technical assistance for your specific application may be available. Installers are solely responsible for the actual installation of the system.

## Manufactured Ferrules and Custom Connectors to Receive Oversized Variable Fiber Diameters

Many applications require ferrules only, or not mounted into the ST, SC, FC or SMA style connectors. Select from our “Stock Ferrule Sizes” that we offer in four sizes below, which provides the best tolerances at no minimum purchase. If your fiber diameter size requirements are different, see Standard and Premium selections below.

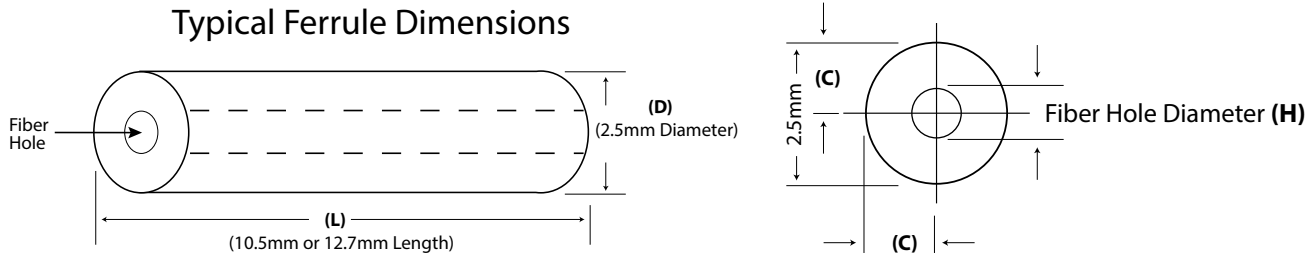

**Material:** Stainless Alloy  
**Diameter (D)** – All Ferrules Offered Are 2.5mm Diameter

### STOCK FERRULE SIZES

Fiber Hole Diameter (H)	Hole Tolerance	Concentricity (C)	Length (L)	Diameter (D)
127µm	-2/+10µm	25µm	10.5mm & 12.7mm	2.5mm
140µm	-0/+10µm	25µm	10.5mm & 12.7mm	2.5mm
230µm	-0/+10µm	25µm	10.5mm & 12.7mm	2.5mm
1000µm	-0/+20µm	25µm	10.5mm & 12.7mm	2.5mm

<b>Purchasing Information</b>	No Minimum Purchase   \$2.30 each   Quantity Discounts Available   \$57.50/25 Pack Ex: FD-SF-1000-127 (Stock Ferrule, 1000µm, 12.7mm Length)
-------------------------------	---

### STANDARD DRILLED FERRULES

Fiber Hole Diameter (H)	Hole Tolerance	Concentricity (C)	Length (L)	Diameter (D)
127µm to 1300µm	-0/+50µm	50µm	10.5mm & 12.7mm	2.5mm

<b>Purchasing Information</b>	Minimum Purchase 25   No Charge for Drill Bit If Inventoried   Add \$50 If Not Listed and 6 week Lead Time \$3.25 each   Quantity Discounts Available Ex: FD-SD-0500-105 (Standard Drilled Ferrule, 500µm, 10.5mm Length)
-------------------------------	---

### PREMIUM DRILLED FERRULES

Fiber Hole Diameter (H)	Hole Tolerance	Concentricity (C)	Length (L)	Diameter (D)
127µm to 490µm	-4/+10µm	25µm	10.5mm & 12.7mm	2.5mm
500µm to 990µm	-6/+15µm	25µm	10.5mm & 12.7mm	2.5mm
1000µm to 1500µm	-10/+20µm	25µm	10.5mm & 12.7mm	2.5mm

<b>Purchasing Information</b>	Minimum Purchase 500   No Charge for Drill Bit If Inventoried   Add \$50 If Not Listed and 6 week Lead Time \$3.95 each   Quantity Discounts Available   \$325 Setup for <500 Ex: FD-PD-0230-105 (Premium Drilled Ferrule, 230µm, 10.5mm Length)
-------------------------------	--

Note: Large Quantity Requirements of Different Diameter and Lengths Are Available.

## Drill Sizes Inventoried

127µm	210µm	270µm	330µm	360µm	440µm	520µm	580µm	660µm	740µm	850µm	1010µm	1120µm
130µm	220µm	280µm	335µm	370µm	450µm	525µm	590µm	670µm	750µm	860µm	1015µm	1200µm
140µm	225µm	290µm	340µm	380µm	460µm	530µm	600µm	680µm	760µm	890µm	1020µm	1250µm
150µm	230µm	295µm	350µm	390µm	470µm	540µm	610µm	690µm	770µm	900µm	1030µm	1270µm
160µm	240µm	300µm	330µm	400µm	480µm	550µm	620µm	700µm	800µm	930µm	1040µm	1370µm
170µm	250µm	310µm	335µm	410µm	490µm	570µm	630µm	710µm	810µm	970µm	1050µm	1500µm
180µm	260µm	320µm	340µm	420µm	500µm	550µm	640µm	720µm	830µm	990µm	1080µm	1525µm
190µm	265µm	325µm	350µm	430µm	510µm	570µm	650µm	730µm	840µm	1000µm	1100µm	



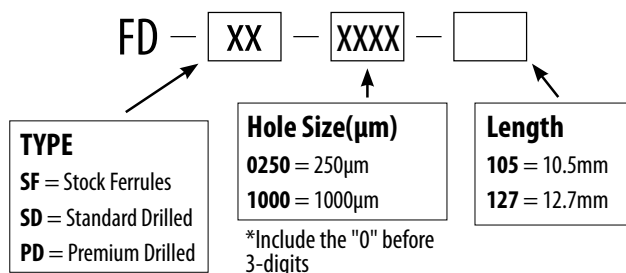

## Creating Your 2.5mm Diameter Ferrule Part Number



**Ex:** FD - SD - 0250 - 105  
(Standard Drilled Ferrule, 250µm, 10.5mm Length)

## Custom Connectors

Your custom ferrule mounted in a standard style fiber optic connector creates your custom connector. Expect low loss connections when using these standard connectors with available low cost mating sleeves. Quantity discounts are available.

			
<b>ST Connector</b>	<b>SC Connector</b>	<b>FC Connector</b>	<b>SMA905 Connector</b>
12.7mm Ferrule Only	10.5mm Ferrule Only	10.5mm Ferrule Only	3mm Diameter Ferrule, Produced by drilling a larger hole size to a 125µm standard SMA905
Connector: \$3.50 Plus Ferrule: \$3.25 (SD) / \$3.75 (PD)	Connector: \$3.95 Plus Ferrule: \$3.25 (SD) / \$3.75 (PD)	Connector: \$4.45 Plus Ferrule: \$3.25 (SD) / \$3.75 (PD)	Connector: \$6.25 Plus Ferrule: \$3.25 (SD)

Quantity Discounts Available

## Create Your Custom Drilled Connector

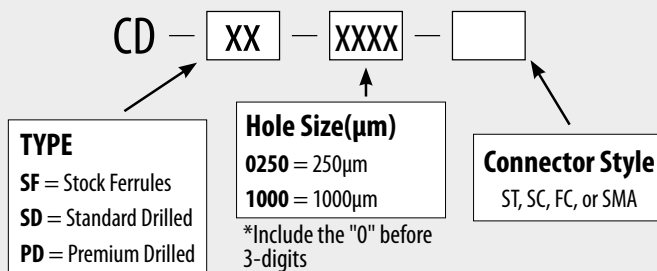

**Ex:** CD - PD - 1000 - ST  
(Premium Drilled Ferrule, 1000µm, ST Connector)

## Mating Sleeve Part Numbers

Connector Type	Part Number	Price
ST	F1-8102SS	\$0.85
SC	F1-3810BC	\$2.00
FC	F1-8501SZ	\$2.50
SMA	F1-93330	\$8.35

# COPPER



## CAT 6 AND CAT 5e PATCH CABLES

### FEATURES:

- Meet or Exceed Performance Standards
- 4-pair Stranded Unshielded, 24 AWG Conductor Cables
- Non-Plenum (CMR) Rated
- Pre-terminated with 8 Position RJ 45 Plug
- Available in a Variety of Lengths and Colors
- Universal Wiring ANSI/TIA T568A/T568B Standards

#### CATEGORY 5e STRANDED UNSHIELDED PATCH CABLE WITH SNAGLESS BOOTS

FIS

PART #	LENGTH	PRICE
CT-6080-03-XX	3ft	\$1.55
CT-6080-05-XX	5ft	2.00
CT-6080-07-XX	7ft	2.40
CT-6080-10-XX	10ft	3.00
CT-6080-15-XX	15ft	4.15
CT-6080-25-XX	25ft	6.40

(Note: When ordering the above Cat 5e cords, replace XX with color: BK=Black, BU=Blue, GN=Green, GY=Gray, OR=Orange, RD=Red, WH=White, YE=Yellow)

#### CATEGORY 6 STRANDED, UNSHIELDED PATCH CABLE WITH SNAGLESS BOOT

FIS

PART #	LENGTH	PRICE
CT-6081-03-XX	3ft	\$1.95
CT-6081-05-XX	5ft	2.50
CT-6081-07-XX	7ft	3.10
CT-6081-10-XX	10ft	3.85
CT-6081-15-XX	15ft	5.25
CT-6081-25-XX	25ft	8.00

(Note: When ordering the above Cat 6 cords, replace XX with color: BK=Black, BU=Blue, GN=Green, GY=Gray, OR=Orange, RD=Red, WH=White, YE=Yellow)



#### CATEGORY 6™ BULK 4 PAIR CABLE

HITACHI

PART #	DESCRIPTION	PRICE
30024-8-XX-2	CAT6 UTP Riser Cable (CMR) - 550MHz	CALL
30237-8-XX-2	CAT6 UTP Plenum Cable (CMP) - 550MHz	CALL



#### CATEGORY 6 BULK 4 PAIR CABLE

PART #	DESCRIPTION	PRICE
6A234UTPRM3-X	CAT 6 23awg Riser Cable - 250MHz	CALL
6B234UTPM3-X	CAT 6 23awg Plenum Cable - 250MHz	CALL
6B234UTPENHM3-X	CAT 6 23awg Plenum Cable - 550MHz	CALL



#### CATEGORY 5e BULK 4 PAIR CABLE

HITACHI

PART #	DESCRIPTION	PRICE
38696-8-XX-2	CAT 5e UTP Riser Cable (CMR) - 400MHz	CALL
39419-8-XX-2	CAT 5e UTP Plenum Cable (CMP) - 400MHz	CALL



#### CATEGORY 5e BULK 4 PAIR CABLE

PART #	DESCRIPTION	PRICE
5AE244UTPRM2-X	CAT 5e Riser Cable - 100MHz	CALL
5BE244UTPM2-X	CAT 5e Plenum Cable - 350MHz	CALL
5BE244UTP350M2-X	CAT 5e Plenum Cable - 350MHz	CALL

(Note: When ordering, replace XX with BK = Black, BL = Blue, BR = Brown, GA = Gray, GR = Green, RD = Red, WH = White, and YE = Yellow.)

## CUSTOM COPPER ASSEMBLIES:

Custom Cat 3, 5e, 6 and 6A Patch Cords can be made with or without snagless boots. Available in Black, Blue, Green, Pink, Purple, Red, White, and other colors. Each patch cord is tested and verified to ensure performance per TIA standards.

- Any Length
- Any Wiring Configuration
- Any Color
- Booted or Non-Booted
- Labeling Available
- You Provide the Spec
- Cross-over also Available

Other Copper assemblies are available.

**Call for more information!**

**FLUKE DSX CABLEANALYZER AND FIBER OPTIC MODULES**

The DSX CableAnalyzer Series from Fluke Networks is the testing platform for today - and tomorrow. This revolutionary new future-proof platform significantly reduces total time to certify by improving every aspect of the testing process. The AC Wiremap feature validates twisted-pair cabling for Power over Ethernet services in accordance with TIA/EIA standards, even if a Midspan power supply is used.

**FEATURES**

- Unmatched speed for Cat 5e, 6, 6a, 8, Class Fa, I/II and all current standards.
- Enables testing and certification of twisted pair cabling for up to 40 Gigabit Ethernet deployments
- Intertek Verified to ANSI/TIA-1152 Level 2AG – the most stringent accuracy requirement

PART #	DESCRIPTION	PRICE
DSX2-8000	A complete copper certification kit for cabling contractors testing Cat 8 and below channel and permanent links.	\$14,542.00
DSX2-8000MI	2GHZ DSX Cableanalyzer V2, w/ Wi-Fi	20,615.00
DSX2-8000-PRO	2GHZ DSX Multimode OLTS INSPC V2, w/ Wi-Fi	63,802.00
DSX2-8000QI	2GHZ DSX QUAD OLTS INSPC V2, w/ Wi-Fi	25,822.00
DSX2-8000QOI	2GHZ DSX QUAD OTDR OLTS INSPC V2, w/ Wi-Fi	37,679.00



DSX2-8000



**FLUKE LINKIQ™ CABLE+ NETWORK TESTER**

The LinkIQ™ Cable+Network Tester is the solution to verify cable performance up to 10G and solve network connectivity problems. LinkIQ™ validates cable performance using frequency-based measurements to calculate maximum bandwidth (10BASE-T to 10GBASE-T), which ensure that tested links meet performance requirements. LinkIQ™ also provides nearest switch diagnostics including advertised data rate, switch name and port number and VLAN information, plus PoE testing and load test up to Class 8 (90 W). Additional features include: Cable Toning, Port Blink, 802.1x authentication, Remote Office Locators, and the ability to manage results via LinkWare PC.

**Additional features of LIQ-KIT include:** Cable Toning, Port Blink, 802.1x authentication, Remote Office Locators, and the ability to manage results via LinkWare PC.

PART #	DESCRIPTION	PRICE
LIQ-100	LinkIQ™ Cable+Network tester includes LinkIQ™ with remote ID #1, RJ45-RJ45 patch cord, AC charger, RJ45/11 universal coupler, and carrying case	\$2,359.00
LIQ-KIT	LinkIQ™ Cable+Network tester includes LinkIQ™ with remote IDs #1-7, RJ45-RJ45 patch cord, AC charger, RJ45/11 universal coupler, Intellitone Pro 200 probe and duffel bag carrying case	2,829.00



LIQ-100



LIQ-KIT

**MOLEX UTP SINGLE LINE TESTER**

- Verifies 1, 2, 3, and 4 pair UTP channels
- Unique 3-in-1 design
- Built-in Modular Jacks for USOC, EIA 568A and 568B
- Tests Open and Short Circuits

PART #	DESCRIPTION	PRICE
33-100	SLT3 UTP Single Line Tester	\$98.50



33-100



**TEMPO COPPER TESTING KITS**

The TEMPO tone and probe kit is used by technicians everywhere to identify single conductors or cables within a bundle at a cross-connect point, or at remote ends. It is designed for accurate wire identification, the 801K virtually eliminates power-related noise from their tone and probe operation.

**Tone and Probe Kit Includes:** 77HP High Power Tone Generator and the 200EP Inductive Amplifier in a Rugged, Woven Polyester Carrying Case.

PART #	DESCRIPTION	PRICE
701KG	Professional Tone & Probe Tracing Kit (Pictured)	\$125.00
801K	Premium Tone and Probe Kit	205.00



701KG

**TEMPO NETCAT STRUCTURED WIRING TESTER AND TROUBLESHOOTER**

The NETcat® Pro is a digital tool for fast, accurate checking of cables, wiring and network service. Operated using a backlit touch screen display, the Pro not only tests wiring continuity and proper pair allocation, but measures the length of cables and determines if network service is available.

**FEATURES**

- Verifies the Integrity of Both Twisted Pair and Coaxial Telecom Cable
- Test Wiring Continuity and Check for the Correct Allocation of Wire Pairs
- Fast, Accurate Checking of Cables, Wiring, and Network Service
- Measures the Length of Cables and Determines if Network Service is Available

PART #	DESCRIPTION	PRICE
NC-100	NETcat Micro Digital Voice and Video Wiring Tester	\$110.00
NC-500	NETcat Pro Digital VDV Wiring Troubleshooter	375.00



NC-500

**AUTHORIZED FULL LINE  
SIGNAMAX  
DISTRIBUTOR**



SKFL-3

DKFL-12

**SIGNAMAX**



KJ4MT-8600



KJ458MT



KJ458-C6C



CMK-SC



KRJ45/5-100



KRJ45FT-C6C

**SIGNAMAX**



48458MX-C5E



24458MDX-C6

**SIGNAMAX KEYSTONE FACEPLATES AND SURFACE MOUNT BOXES**

PART #	DESCRIPTION	PRICE
SKFL-1	1 port Single Gang Keystone Faceplate with Labeling Windows	\$1.05
SKFL-2	2 port Single Gang Keystone Faceplate with Labeling Windows	1.05
SKFL-3	3 port Single Gang Keystone Faceplate with Labeling Windows	1.05
SKFL-4	4 port Single Gang Keystone Faceplate with Labeling Windows	1.00
SKFL-6	6 port Single Gang Keystone Faceplate with Labeling Windows	1.00
SKFLA-2	2 port Angled Single Gang Keystone Faceplate with Labeling Windows	1.25
SKFLA-4	4 port Angled Single Gang Keystone Faceplate with Labeling Windows	1.25
DKFL-6	6 port Double Gang Keystone Faceplate with Labeling Windows	1.89
DKFL-12	12 port Double Gang Keystone Faceplate with Labeling Windows	1.89
DKFLA-8	8 port Angled Double Gang Keystone Faceplate with Labeling Windows	1.89
SMKL-1	1 port Surface Mount Multimedia Box	1.20
SKFD-1	Single Gang Surface Mount Faceplate Box	1.00
DKFD-2	Double Gang Surface Mount Faceplate Box	1.29
SMKL-2	2 port Surface Mount Multimedia Box	1.69
SMKL-4	4 port Surface Mount Multimedia Box	2.39

[Note: The standard color for all the above is light ivory. For other colors add the following to the p/n -BK (Black), -GY (Gray), -WH (White)] (Faceplates also available without labeling window option.)  
[Note: Stainless Steel Wall Plates also available]

**SIGNAMAX KEYSTONE JACKS AND FIBER CONNECTOR MODULES**

**FEATURES:**

- Keystone jacks exceed all performance requirements as defined in TIA/EIA568-B
- Terminated with 110 tooling or 4 Pair MT Series Tool
- Ability to mount either color-coded icon tabs or dust covers

PART #	DESCRIPTION	PRICE
KJMT-8600	4 Pair Termination Tool for MT Series	\$26.99
KJ458MT-C6AC*	Cat 6A 10G MT Series Keystone Jack 568A/B Light Ivory	6.50
KJ458MT-C6AC	Cat6A 10G Screened Keystone Jack 568A/B	6.82
KJ458MT-C6C	Cat6+ MT Series Keystone Jack 568A/B Light Ivory	3.95
KJ458MT-C5E*	Cat5E+ MT Series Keystone Jack 568A/B Light Ivory	2.39
KJ126MT-C3**	Cat3 Voice Grade MT Series Keystone Jack Light Ivory	1.89
CMK-BL**	Blank Keystone Module	20¢
CMK-F***	F-Type Keystone Connector Module	\$1.25
CMK-BNC***	BNC Keystone Connector Module	2.05
CMK-ST**	ST MM/SM Fiber Connector Module	2.95
CMK-SC**	SC MM/SM Fiber Connector Module	3.15
CMK-LC**	LC MM/SM Fiber Connector Module	6.45

\*(Note: When ordering, other than Light Ivory color, add the following to the p/n: -BK (Black), -BU (Blue), -GN (Green), -GR (Gray), -OR (Orange), -RD (Red), -WH (White), -YE (Yellow))

**UNSHIELDED RJ-45 MODULAR PLUGS / FIELD INSTALLABLE MODULAR PLUGS**

**FEATURES:**

- Used for field termination of patch cords and applications

PART #	DESCRIPTION	PRICE
KRJ45/5-100	RJ-45 for 24AWG Stranded Cable - 100 Pack	\$18.60
KRJ45/5SLD-100	RJ-45 for 24AWG Solid Cable - 100 Pack	29.95
KRJ45FT-C5E	Cat 5e Unscreened Field Installable Modular Plug	2.95
KRJ45FT-C6C	Cat 6 Unscreened Field Installable Modular Plug	4.29

**SIGNAMAX PATCH PANELS**

PART #	DESCRIPTION	PRICE
24458-C6A	Cat 6A 10Gig 1U, 19" Rack Mountable	\$164.55
48458-C6A	Cat 6A 10Gig 2U, 19" Rack Mountable	339.00
24458MDX-C6	Cat 6 24 port 1U, 19" Rack Mountable MDX-Series	109.00
48458MDX-C6	Cat 6 48 port 2U, 19" Rack Mountable MDX-Series w/ cable management	209.00
24458MDX-C5E	Cat 5e 24 port 1U, 19" Rack Mountable MDX-Series w/ cable management	69.00
48458MX-C5E	Cat 5e 48 port 1U, 19" Rack Mountable MDX-Series w/ cable management	129.00
12458M-C5E	Cat 5e 12 port Mini Wall Mount	48.49
12458M-C6C	Cat6 12 Port Mini Wall Mount	74.79
24U-HDMMP	24 Port Unloaded Patchpanel Accepts Keystone Jacks, 19" Rack Mountable	35.29
48U-HDMMP	48 Port Unloaded Patchpanel Accepts Keystone Jacks, 19" Rack Mountable	49.49

[Note: Screened/Shielded Patch Panels for Cat 5e, 6 and 6A also available.]

**PROUDLY OFFERING COPPER PRODUCTS**  
Call for more information!



# NETWORK EQUIPMENT



## FIS SFP MODULES

A small form-factor pluggable (SFP) is a compact, hot-pluggable (swappable) network interface module used for both telecommunication and data communications applications. SFPs originated from the original larger GBIC (1 Gig speeds) modules. The form factor and electrical interface are specified by a multi-source agreement (MSA) that was jointly developed and supported by many network component vendors. Several vendors rejected the MSA agreement and developed their own Standard. FIS provides SFP modules for 100 Mbps(SFP) , 1 Gbps(SFP), 10 Gbps(SFP+) and 40 Gbps (QSFP+) and 100 Gbps(QSFP28) Ethernet switches in MSA format. Cisco, Alcatel-Lucent, Dell, Juniper and a many other non-MSA formats are also available. Medias available include Singlemode and Multimode fiber as well as UTP copper. **Ask your FIS salesperson to quote any non MSA standard programed SFP.**

PART #	DESCRIPTION	PRICE
OCA1-IO	SFP 100MB Fast Ethernet 1310nm FX Multimode, 2 km range, MSA Standard Compatible	\$26.00
ODD0-IO	SFP 1 Gigabit Ethernet 850nm SX Multimode, 550 m range, DDM, MSA Standard Compatible	18.00
OC9C-IO	SFP 1 Gigabit Ethernet 1310nm LX Singlemode, 10 km range, DDM, MSA Standard Compatible	20.00
OC9C20K-IO	SFP 1 Gigabit Ethernet 1310nm LX Singlemode, 20 km range, DDM, MSA Standard Compatible	25.00
OCB1-IO	SFP 1 Gigabit Ethernet 1550nm EX Singlemode, 40 km range, DDM, MSA Standard Compatible	26.00
OCB8-IO	SFP 1 Gigabit Ethernet 1550nm ZX Singlemode, 80 km range, DDM, MSA Standard Compatible	69.00
OCB81-IO	SFP 1 Gigabit Ethernet 1550nm EZX Singlemode, 120 km range, DDM, MSA Standard Compatible	132.00



SFP

## FIS WDM SFP MODULES

When limited by available fibers FIS carries Singlemode fiber WDM SFP modules. These SFPs transmit and receive over the same fiber using Wavelength Division Multiplexing (WDM) fiber optic technology. These SFPs utilize two different light sources (LASER) to achieve full duplex transmission over a single fiber minimizing fiber usage.

PART #	DESCRIPTION	PRICE
ODEC-IO	SFP 1 Gigabit Ethernet 1310-TX/1550-RX WDM LX Singlemode, 10 km range, DDM, MSA Standard Compatible	\$48.00
OE1B-IO	SFP 1 Gigabit Ethernet 1550-TX/1310-RX WDM LX Singlemode, 10 km range, DDM, MSA Standard Compatible	50.00
20KMODEC-IO	SFP 1 Gigabit Ethernet 1310-TX/1550-RX WDM LX Singlemode, 20 km range, DDM, MSA Standard Compatible	55.00
20KMOE1D-IO	SFP 1 Gigabit Ethernet 1550-TX/1310-RX WDM LX Singlemode, 20 km range, DDM, MSA Standard Compatible	57.00



WDM SFP

## FIS SFP+ MODULES (10 GIG)

SFP+ (enhanced small form-factor pluggable) is an enhanced version of the standard SFP that supports data rates up to 16Gbit/s. This product is available in a singlemode and multimode version.

PART #	DESCRIPTION	PRICE
1565-IO	SFP+ 10 Gigabit Ethernet 850nm SR Multimode, 300 m range, DDM, MSA Standard Compatible	\$27.00
1469-IO	SFP+ 10 Gigabit Ethernet 1310nm LR Singlemode, 10 km range, DDM, MSA Standard Compatible	51.00
146920K-IO	SFP+ 10 Gigabit Ethernet 1310nm LR Singlemode, 20 km range, DDM, MSA Standard Compatible	55.00



SFP+

## FIS QSFP+ MODULES (40 GIG)

QSFP+ (enhanced quad small form-factor pluggable) is an evolution of the QSFP which can carry 4 channels simultaneously. The QSFP+ can support 4 channels each up to 10Gbit/s, together all the 4 channels combine for a single 40 Gbit/s Ethernet link, 4 channels transmitting and 4 channels receiving, so 8 fibers in total are required for transmission.

PART #	DESCRIPTION	PRICE
3486-IO	QSFP+ 40 Gigabit Ethernet 850nm SR4 Multimode, 100 m range, DDM, MSA Standard Compatible	\$100.00
346B-IO	QSFP+ 40 Gigabit Ethernet 1310nm LR4 Singlemode, 10 km range, DDM, MSA Standard Compatible	469.00



QSFP+

## FIS QSFP28 MODULES (100 GIG)

QSFP28 is a transceiver designed for 100Gbit/s data rate. Like the QSFP in utilizes 4 transmit and 4 receive channels with 8 fibers, however the "28" stands for each channel or lane carries up to 28Gbit/s rather than 10Gbit/s, so four lanes carry up to 100Gbit/s transmit and 4 lanes carry up to 100Gbit/s in receive direction. These are available in multimode or singlemode. Recommended using OM3, OM4 or OM5 multimode fiber with QSFP28 module.

PART #	DESCRIPTION	PRICE
5B7E-IO	QSFP28 100 Gigabit Ethernet 850nm SR4 Multimode, 100 m range, DDM, MSA Standard Compatible	\$229.00
5B74-IO	QSFP28 100 Gigabit Ethernet 1310nm LR4 Singlemode, 10 km range, DDM, MSA Standard Compatible	1,000.00



QSFP28

## INTEGRA OPTICS SMART CODER 2

The Smart Coder 2 is the perfect device to maintain, test and recode your SFPs, SFP+s and QSFP+s. This device can recode any FIS SFP to over 50 OEM platforms to fit the device required. The testing option of the Smart Coder2 allows the end user to conduct diagnostic monitoring on both FIS and Non-FIS brand SFPs. Testing includes transmit power, receive power, temperature, performance and more.

PART #	DESCRIPTION	PRICE
SMARTCODER2	SMART CODER 2 enables you to easily reconfigure FIS SFPs and test all manufacturer SFP	\$1,949.00



## QSFP+ AOC (ACTIVE OPTICAL CABLE) 40 GIG

A QSFP+ (Quad Small Form-factor Pluggable) active optical cable (AOC) is the combination of a passive fiber optic cable and the active QSFP+s required to achieve 40 Gig network speeds. When purchasing this cable you have both the active and passive components needed to complete a 40 Gbps Ethernet circuit. The passive fiber optic portion of the AOC is a Singlemode or Multimode MPO to MPO connector cable (you chose the length) with 12 fibers (lanes). The reason for 12 fibers instead of the traditional 2 (one transmit, one receive) is due to the fact that the fiber equipment (QSFP+) only has the ability to transmit at a maximum speed of 10 Gbps per lane, due to this speed limitation it is required to use a minimum of 8 fibers to achieve the 40 Gbps required. The active components of the AOC are the 2 QSFP+ modules that are attached to ends of the passive fiber cable. The QSFP+ uses 8 total fibers, 4 fibers (4 x 10 Gbps = 40 Gbps) in each direction for a total of 8. AOCs are hot-pluggable (swappable) which makes using it a convenient and fast installation. Use the part number table to configure your AOC cable's length, fiber and cable type. All AOCs come with pull tabs for each SFP removal. Contact your FIS representative for pricing.

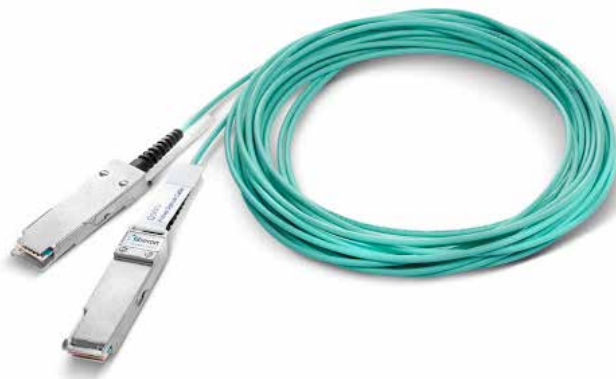

PART #	DESCRIPTION	PRICE
F4M-AOC-QSFPP-F-1-1	High Speed (40 Gig) Quad SFP+ (QSFP+) Fiber Optic Assembly 1 meter, MM, OM3	\$145.00
	Each additional meter	2.15ea

## QSFP+ AOC (Active Optical Cable)

## ORDER CODES

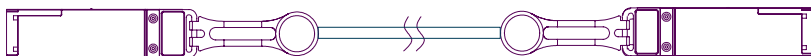

Note:

- 1) Various cable lengths available for all types
- 2) Long lengths available
- 3) Latch/tab available on Top or Bottom position

**F4M-AOC - QSFP - F - S - S**

CODE	TYPE	CABLE LENGTH	CABLE TYPE
F4M-AOC	QSFP-F (Fiber)	5 5m	1 Standard OM3
		10 10m	S Specify
		15 15m	
		30 30m	
		50 50m	
		100 100m	
	S Specify		

## QSFP+ COPPER CABLE 40 GIG

A high speed QSFP+ (Quad Small Form-factor Pluggable) cable is the combination of a twinax copper cable and the active QSFP+s required to achieve 40 Gig network speeds. The copper portion of the cable is a single twinax to twinax connection. The copper cable can range from 30 to 24 AWG; due to power requirements it is recommended that cables over 3 meters utilize 24 AWG. The active components of this cable are the 2 QSFP+ modules that are attached to ends of the twinax cable. All of these cables are hot-pluggable (swappable). Use the part number table to configure your cable's length, AWG (American Wire Gauge) and cable jacket type (PVC, or Non-Halogen). All AOCs come with pull tabs for each SFP removal. Contact your FIS representative for pricing.



PART #	DESCRIPTION	PRICE
F4M-QSFPP-C-.5-30-1	High Speed (40 Gig) Quad SFP+(QSFP+) Copper Cable 30AWG PVC Jacket, half meter	\$38.00
	Each additional half meter	1.40ea
F4M-QSFPP-C-3.5-24-1	High Speed (40 Gig) Quad SFP+(QSFP+) Copper Cable 24AWG PVC Jacket, 3.5 meters	\$87.00
	Each additional half meter	2.60ea

## High Speed QSFP+ Copper Cable

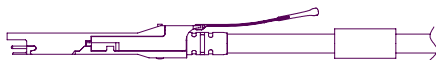
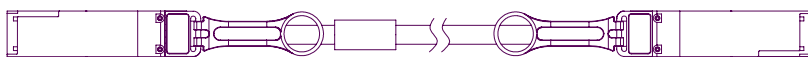

Note:

- 1) Copper type maximum length recommended at 15 meters
- 2) Various cable lengths available for all types
- 3) Latch/tab available on Top or Bottom position

**F4M - QSFP-C - S - 28 - 1**

CODE	TYPE	CABLE LENGTH	AWG	CABLE JACKET
F4M-	QSFP-C	5 5m	30 30AWG	1 PVC
	QSFP-CA	10 10m	28 28AWG	2 Non-Halogen
		15 15m	26 26AWG	3 Other
		S Specify	24 24AWG	



## SFP+ COPPER/COPPER ACTIVE CABLE 10 GIG

A high speed SFP+ (Small Form-factor Pluggable) cable is the combination of a twinax copper cable and the active SPF+s required to achieve 10 Gig network speeds. The copper portion of the cable is a single twinax to twinax connection. The copper cable can range from 30 to 24 AWG; due to power requirements it is recommended that cables over 3 meters utilize 24 AWG. The active components of this cable are the 2 SFP+ modules that are attached to ends of the twinax cable. All of these cables are hot-pluggable (swappable). Use the part number table to configure your cable's length, AWG (American Wire Gauge) and cable jacket type (PVC, or Non-Halogen). All AOCs come with pull tabs for each SFP removal. Contact your FIS representative for pricing.



PART #	DESCRIPTION	PRICE
F4M-SFPP-C-.5-30-1	10 Gig SFP+ Copper Cable 30AWG PVC Jacket, half meter Each additional half meter	\$17.35 1.25ea

## High Speed SFP+Copper Cable



**F4M - SFPP - C - 5 - 28 - 1**



CODE	TYPE	CABLE LENGTH	AWG	CABLE JACKET	
F4M-	SFPP-C	SFP+/Copper	1 1m	30 30AWG	1 PVC
	SFPP-CA	SFP+/Copper Active	5 5m	28 28AWG	2 Non-Halogen
			10 10m	26 26AWG	3 Other
			S Specify	24 24AWG	

Note:

- 1) Copper type maximum length recommended at 15 meters
- 2) Various cable lengths available for all types
- 3) Latch/tab available on Top or Bottom position

## QSFP+ TO 4X SFP+ BREAKOUT CABLE ASSEMBLIES 40 GIG - 10GIG

A high speed SFP+ (Small Form-factor Pluggable) cable is the combination of a twinax copper cable and the active SPF+s required to achieve 10 Gig network speeds. The copper portion of the cable is a single twinax to twinax connection. The copper cable can range from 30 to 24 AWG; due to power requirements it is recommended that cables over 3 meters utilize 24 AWG. The active components of this cable are the SFP+ modules that are attached to ends of the twinax cable. All of these cables are hot-pluggable (swappable). Use the part number table to configure your cable's length, AWG (American Wire Gauge) and cable jacket type (PVC, or Non-Halogen). All AOCs come with pull tabs for each SFP removal. Contact your FIS representative for pricing.



PART #	DESCRIPTION	PRICE
F4M-QSSFP-C-1-30-1	QSFP+ to 4x SFP+ Breakout cable assemblies 30AWG, 1 meter, 40 Gig - 10Gig Each additional meter	\$79.00 1.40ea
F4M-QSSFP-C-4-24-1	QSFP+ to 4x SFP+ Breakout cable assemblies 24AWG, 4 meters, 40 Gig - 10Gig Each additional meter	\$94.00 13.50ea

## QSFP+ to 4x SFP+ Breakout Cable Assemblies

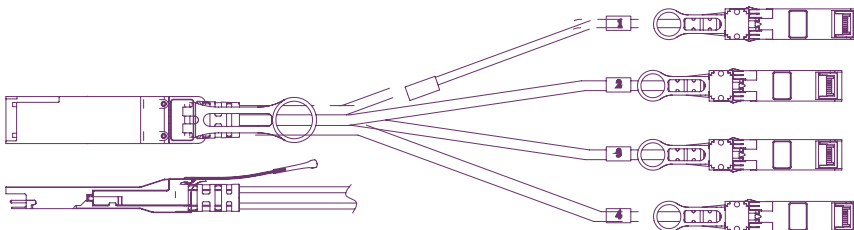

**F4M - QSSFP - C - 1 - 28 - 2**

CODE	TYPE	CABLE LENGTH	AWG	CABLE JACKET	
F4M-	QSSFP-C	QSFP+ to 4XSFP	1 1m	30 30AWG	1 PVC
			5 5m	28 28AWG	2 Non-Halogen
			10 10m	26 26AWG	3 Other
			S Specify	24 24AWG	

Note:

- 1) Various cable lengths available for all types
- 2) Latch/tab available on Top or Bottom position



# FIS MEDIA CONVERTERS AND SWITCHES

FIS offers a full line of quality Ethernet network active equipment, including fixed and SFP port multiport media converters and switch gear, as well as a comprehensive line of SFPs to match your specific network requirements.



F1-DU10001320SC

### FIS MEDIA CONVERTERS 10/100 BASE

These Ethernet Media Converters meet IEEE Standards and are 10/100Base-TX and 100Base-FX with MDI/MDI-X auto negotiation. Full set of LED Indicators and 10/100Mbps and full/half duplex automatically configured in twisted pair port. The Multimode converters have a range of 2km and the Singlemode converters have a range of 20km.

PART #	DESCRIPTION	PRICE
F1-OEC32S1-202	10/100 Base-T/TX to 100 Base-FX Media Converter, SM/SC 2km	\$91.25
F1-DU-100-13-20-SC	10/100 Base-T/TX to 100 Base-FX Media Converter, SM/SC 20km	50.00
F1-DU-100-13-20-ST	10/100 Base-T/TX to 100 Base-FX Media Converter, SM/ST 20km	50.00
F1-DU-100-13-2-FC	10/100 Base-T/TX to 100 Base-FX Media Converter, SM/FC 20km	50.00



F1-SFP0101G

### FIS MEDIA CONVERTERS 10/100/1000 BASE

The FIS 10/100/1000 Base media converters are designed to convert 1000BASE-SX fiber to 1000Base-T copper media or vice versa. These Ethernet Media Converters meet IEEE Standards and have MDI/MDI-X auto negotiation.

See SFP modules on page 157

PART #	DESCRIPTION	PRICE
F1-DU-1000-13-2-ST	10/100/1000 Base-T/TX to 1000 Base-FX Media Converter, MM/ST 220m (62.5) / 550m (50)	\$85.00
F1-DU-1000-13-2-SC	10/100/1000 Base-T/TX to 1000 Base-FX Media Converter, MM/SC 220m (62.5) / 550m (50)	80.00
F1-DU-1000-13-20-ST	10/100/1000 Base-T/TX to 1000 Base-FX Media Converter, SM/ST 20km	80.00
F1-DU-1000-13-20-SC	10/100/1000 Base-T/TX to 1000 Base-FX Media Converter, SM/SC 20km	80.00
F1-SFP0101G	10/100/1000 Base-T/TX to 1000 Base-FX Media Converter, SFP Port	60.00
F1-SFP01P02	Media Converter (2) x 1.25 Gigabit SFP to (1) 2.5 Gigabit SFP	140.00



F1-DU4001320

### FIS SWITCHES 10/100 BASE

These FIS Switches are an inexpensive way to connect remote LAN devices using an existing fiber backbone. FIS has multiple options available for both Multimode and Singlemode. See SFP modules on page 157

PART #	DESCRIPTION	PRICE
F1-DU4001320	10/100 Switch, Multimode, SC, 4UTP	\$60.00
F1-SFP0108F	10/100M Switch, SFP Slot, 8UTP	75.00
F1-SFP0116F	10/100M Switch, SFP Slot, 16UTP	95.00



F1-SFP0801G

### FIS SWITCHES 10/100/1000 BASE

These FIS 10/100/1000 base switches are built with multiple SFP ports to support a wide range of network requirements. This powerful feature enables the switch to be extremely versatile at a low cost to the installer.

See SFP modules on page 157

PART #	DESCRIPTION	PRICE
F1-SFP0202G	10/100/1000 Media Converter, 2 SFP Slots, 2UTP	\$85.00
F1-SFP0204G	10/100/1000 Media Converter, 2 SFP Slots, 4UTP	125.00
F1-SFP0802G	10/100/1000 Media Converter, 8 SFP Slots, 1UTP	165.00

### FIS PoE SWITCHES

The FIS PoE Switch provides power and data from a single point, using power over Ethernet over a single CAT5e cable. The eight RJ45 network ports plus one fiber port can be used for any 10/100 Mbps link and four of these ports can supply industry-standard IEEE 802.3af power.

PART #	DESCRIPTION	PRICE
F1-PSE1009F	8 Port 10/100 Base 802.3af PoE + 1-Port Fiber 10/100 Base Desktop Switch	\$175.00
F1-PSE1009F-35-20	8 Port 10/100 Base 802.3af PoE + 1-Port Fiber 10/100 Base, Fiber is 1310nmT/1550nmR, 20Km	185.00



F1-SWMM1

### FIS THREE-PORT MINI SWITCHES

FIS mini-switches provide a simple and inexpensive way to add additional computers to a network. The 3-Port Mini Switch has (2) 100Mbps fiber ports and (1) 10/100Mbps twisted pair copper port.

PART #	DESCRIPTION	PRICE
F1-SWMM1	3-Port Mini Switch with (2) 100 Base-FX MM/SC and One 10/100 Base-T/TX Port	\$110.00
F1-SWSM1	3-Port Mini Switch with (2) 100 Base-FX SM/SC and One 10/100 Base-T/TX Port	110.00



FIS 8-Port Mini Switches

### FIS EIGHT-PORT DESKTOP SWITCHES

This 8-Port Switch is an inexpensive way to connect remote LAN devices using existing fiber backbone. FIS has 8-Port Desktop Switches with one fiber port in each. The 8-port switch has (1)100 Base-FX and (7) 10/100 Base-T/TX ports. Multimode units support up to 2km and Singlemode up to 20km. External power supply included.

PART #	DESCRIPTION	PRICE
F1-JC08A-MS	8-Port Switch with 1 MM/SC Fiber Port and (7) 10/100 T/TX (RJ45)	\$90.00
F1-JC08A-MT	8-Port Switch with 1 MM/ST Fiber Port and (7) 10/100 T/TX (RJ45)	90.00
F1-JC08A-S2	8-Port Switch with 1 SM/SC Fiber Port and (7) 10/100 T/TX (RJ45)	125.00

## SIGNAMAX MEDIA CONVERTERS

Signamax Connectivity Systems Switching Media Converters provide intelligent solutions for long distance connections between legacy copper networks and new fiber based installations. Extended distance Singlemode, as well as Gigabit versions are also available. Use the same converters for either wall or chassis mount. **Lifetime warranty.**

PART #	DESCRIPTION	DISTANCE	PRICE
065-1100	10/100 Base-T/TX to 100 Base-FX, MM/ST (with link fault signaling)	2km	\$105.95
065-1110	10/100 Base-T/TX to 100 Base-FX, MM/SC (with link fault signaling)	2km	105.95
065-1120	10/100 Base-T/TX to 100 Base-FX, SM/SC (with link fault signaling)	15km	255.00
065-1120ED	10/100 Base-T/TX to 100 Base-FX, SM/SC (with link fault signaling)	40km	427.00
065-1174	10/100 Base-T/TX to 100 Base FX MM/LC (with link fault signaling)	2km	184.00
065-1132	100 Base-FX, SM/SC to 100 Base-FX MM/SC	15km SM / 2km MM	469.00
065-1196SFPDR*	10/100/1000 Base-T/TX to 1000/100 Base-SFP Converter	SFP	255.00
065-1196A	10/100/1000 Base-T/TX to 1000 Base-SX, MM/SC Switching	220m (62.5) / 550m (50)	335.00
065-1196AED	10/100/1000 Base-T/TX to 1000 Base-SX, MM/SC Switching	2km	769.00
065-1196ALX	10/100/1000 Base-T/TX to 1000 Base-LX, SM/SC Switching	10km	545.00
065-1195	1000 Base-TX to 1000 Base-SX MM/SC Gigabit Converter	220m (62.5) / 550m (50)	399.00
065-1194	1000 Base-LX SM/SC to 1000 Base-SX MM/SC Gigabit Converter	10km SM / 220m (62.5) / 550m (50)	959.00
065-1194ED	1000 Base-SX MM/SC to 1000 Base-LX SM/SC Extended Distance	20km	1,104.00
065-1197	1000 Base-T to 1000 Base-LX SM/SC (with link fault signaling)	10km	619.00
065-1050GSFP*	10/100/1000 Base-T/TX to 1000 Base-SFP, (PSE), PoE/PoE+, 36 watts	SFP	399.00
065-1200SC10	12-Channel Media Converter 10/100 Base-TX to 100 Base-FX MM/SC	2km	1,859.00
065-1200SC20	12-Channel Media Converter 10/100 Base-TX to 100 Base-FX SM/SC	15km	4,500.00
065-1200SC95	12-Channel Media Converter 1000 Base-TX to 1000 Base-SX MM/SC	220m(62.5) / 550m (50)	4,285.00

\*(Note: Fiber Types and Distances SFP dependent and SFP Insert Modules Sold Separately)

# SIGNAMAX



065-1110



SC10070

## SIGNAMAX GIGABIT UNMANAGED ETHERNET SWITCHES

PART #	DESCRIPTION	PRICE
SC10100	8 Port 10/100/1000 Base T/TX (RJ45) Unmanaged Compact Switch	\$49.00
SC10070	16 Port 10/100/1000 Base T/TX (RJ45) with 2 - 1000 Base SFP Ports Unmanaged Switch	184.00
SC10040	24 Port 10/100/1000 Base T/TX (RJ45) with 2 - 1000 Base SFP Ports Unmanaged Switch	215.00



SC30060

## SIGNAMAX GIGABIT MANAGED ETHERNET SWITCHES

PART #	DESCRIPTION	PRICE
SC30060	8 Port 10/100/1000 Base T/TX (RJ45) with 2 - 1000 Base SFP Ports Managed Switch	\$235.00
SC30040	24 Port 10/100/1000 Base T/TX (RJ45) with 4 - 1000 Base SFP Ports Managed Switch	460.00
SC30010	48 Port 10/100/1000 Base T/TX (RJ45) with 4 - 1000 Base SFP Ports Managed Switch	855.00



SC10060

## SIGNAMAX UNMANAGED POWER OVER ETHERNET (PoE+) SWITCHES

PART #	DESCRIPTION	PRICE
SC10110	4 Port 10/100/1000 Base T/TX (RJ45) PoE+ 2 - 10/100/1000 Base T/TX (RJ45) Unmanaged Switch, 60 watts	\$119.00
SC10091	8 Port 10/100 Base T/TX (RJ45) PoE+ 2 - 10/100 Base T/TX (RJ45), Unmanaged Switch, 105 watts	160.00
SC10080	8 Port 10/100/1000 Base T/TX (RJ45) PoE+ 2 - 1000 Base SFP Ports Unmanaged Switch, 125 watts	355.00
SC10060	16 Port 10/100 Base T/TX (RJ45) PoE+ 2 - 1000 Base SFP Ports Unmanaged Switch, 235 watts	335.00
SC10050	16 Port 10/100/1000 Base T/TX (RJ45) PoE+ 2 - 1000 Base SFP Ports Unmanaged Switch, 235 watts	398.00
SC10030	24 Port 10/100 Base T/TX (RJ45) PoE+ 2 - 1000 Base SFP Ports Unmanaged Switch, 235 watts	395.00
SC10020	24 Port 10/100 Base T/TX (RJ45) PoE+ 2 - 1000 Base SFP Ports Unmanaged Switch, 385 watts	475.00
SC10010	24 Port 10/100/1000 Base T/TX (RJ45) PoE+ 2 - 1000 Base SFP Ports Unmanaged Switch	552.00

## SIGNAMAX

### SIGNAMAX MANAGED POWER OVER ETHERNET (PoE+) SWITCHES

This new stackable managed power over ethernet (PoE) switch provides the capability to remotely power wireless access points, VoIP telephones, powered device media converters and other devices that meet the IEEE 802.1af PoE standard.



SC30030

PART #	DESCRIPTION	PRICE
SC30050	8 Port 10/100/1000 Base T/TX (RJ45) PoE+ 2 - 1000 Base SFP Ports Managed Switch, 125 watts	\$435.00
SC30030	24 Port 10/100/1000 Base T/TX (RJ45) PoE+ 4 - 1000 Base SFP Ports Managed Switch, 200 watts	789.00
SC30020	24 Port 10/100/1000 Base T/TX (RJ45) PoE+ 4 - 1000 Base SFP Ports Full Power Managed Switch, 370 watts	1,050.00
SC31020	24 Port 10/100/1000 Base T/TX (RJ45) PoE+ 4 - 1000 Base SFP Ports Full Power Managed Switch, 740 watts	1,577.00
SC50010	48 Port 10/100/1000 Base T/TX (RJ45) PoE+ 4 - 1/10 GbE SFP Ports Full Power Managed Switch, 820 watts	2,760.00

### SIGNAMAX FIBER ETHERNET ACCESS SWITCHES

Signamax's fiber Ethernet switches accommodate growing networks that require fiber connectivity. With 8 or 24 SFP ports these switches can be configured with multiple media types (UTP, Multimode and Singlemode fiber) for Gigabit and Fast Ethernet networks.



SC10121

PART #	DESCRIPTION	PRICE
065-7310SFP	8 Port 100 Base SFP (RJ45) with 1-10/100/1000 Base T/TX Dual Media Port PoE+ 1 - 1000 Base SFP Ports Unmanaged Switch	\$289.00
SC10121	8 Port 1000/GbE SFP Ports with 2-10/100/1000 Base T/TX Dual Media Port Unmanaged Switch	309.00
065-7890SFPDP	24 Port 100/1000 SFP Ports with 4-10/100/1000 Base T/TX Ports with 4 - Dual Media Ports supporting 10/100/1000 Base T/TX Ports plus 4 - 1000 Base / 10 GbE SFP+	2,235.00

### SIGNAMAX MANAGED INDUSTRIAL SWITCHES

These Hardened Managed Switches are designed to operate in rugged environments with extreme temperature conditions -40° F to 167° F (-40° C to 75° C).



SI30040

PART #	DESCRIPTION	PRICE
SI30050	8 Port 10/100/1000 Base T/TX (RJ45) 2 - 1000 Base SFP Ports Industrial Managed Switch	\$855.00
SI30040	8 Port 10/100/1000 Base T/TX (RJ45) PoE+ 2 - 1000 Base SFP Ports Industrial Managed Switch, 240 watts	1,050.00
SI30030	16 Port 10/100/1000 Base T/TX (RJ45) 4 - 1000 Base SFP Ports Industrial Managed Switch,	1,380.00
SI30021	16 Port 10/100/1000 Base T/TX (RJ45) PoE+ 4 - 1000 Base SFP Ports Industrial Managed Switch, 240 watts	1,709.00
SI30010	8 Port 10/100/1000 Base T/TX (RJ45) 8 - 100/1000/GbE SFP Ports 4 - 1000 Base SFP Ports Industrial Managed Switch	1,511.00

### SIGNAMAX DIN-RAIL INDUSTRIAL HARDENED MEDIA CONVERTERS

Signamax Din-Rail Industrial Hardened Media Converters have been developed to operate in harsh industrial environments that require ruggedized equipment that can operate in severe temperature extremes. These media converters are an affordable solution for outdoor environments, transportation roadside systems, shop floors, and other harsh environments where consistent operation at temperature extremes of -40°F to 167°F (-40°C to 75°C) are necessary.

(Meets NEMA TS1 Environmental Requirements for Traffic Control Equipment)



MI10060

PART #	DESCRIPTION	PRICE
MI10060	2 Port 10/100 T/TX (RJ45) to 100 Base FX SM/SC Industrial Media Converter	\$279.00
MI10050	2 Port 10/100 T/TX (RJ45) to 100 Base FX MM/SC Industrial Media Converter	186.00
MI10040	2 Port 10/100 T/TX (RJ45) PoE+ to 100 Base FX SM/SC Industrial Media Converter	414.00
MI10030	2 Port 10/100 T/TX (RJ45) PoE+ to 100 Base FX MM/SC Industrial Media Converter	279.00
MI10020	2 Port 10/100/1000 T/TX (RJ45) to 2 - 1000 Base SFP Ports Industrial Media Converter	279.00
MI10010	2 Port 10/100/1000 T/TX (RJ45) PoE+ to 2 - 1000 Base FP Ports Industrial Media Converter	349.00
065-1800Z	10/100 Base T/TX to 100 Base FX Industrial Media Converter PoE+ ST/MM 2km Span	819.00
065-1810Z	10/100 Base T/TX to 100 Base FX Industrial Media Converter PoE+ SC/MM 3km Span	761.00
065-1820Z	10/100 Base T/TX to 100 Base FX Industrial Media Converter PoE+ SC/SM 20km Span	895.00

[Note: 48 Volt, 75, 120, 240 Watt and 24 Volt, 30,60,75,120 Watt Din Rail Mt. Power supplies available.]

### SIGNAMAX UNMANAGED HARDENED INDUSTRIAL SWITCHES

Signamax's Hardened Industrial DIN-Rail Mount Switches have been developed to operate in harsh industrial environments that require ruggedized equipment that can operate in severe temperature extremes. These switches are an affordable solution for outdoor environments, transportation roadside systems, shop floors, and other harsh environments where consistent operation at temperature extremes of -40°F to 167°F (-40°C to 75°C) is necessary. (Meets NEMA TS1 and TS2 Environmental Requirements for Traffic Control Equipment)



SI10021

PART #	DESCRIPTION	PRICE
SI10050	4 Port 10/100 Base T/TX (RJ45) PoE+ and 4 Port 10/100 Base T/TX (RJ45) Industrial Switch, 120 watts	\$149.00
SI10041	4 Port 10/100/1000 Base T/TX (RJ45) and 2 - 1000 Base SFP Ports Industrial Switch	249.00
SI10031	4 Port 10/100/1000 Base T/TX (RJ45) PoE+ and 2 - 1000 Base SFP Ports Industrial Switch, 120 watts	349.00
SI10021	8 Port 10/100/1000 Base T/TX (RJ45) and 2 - 1000 Base SFP Ports Industrial Switch	420.00
SI10011	8 Port 10/100/1000 Base T/TX (RJ45) PoE+ and 2 - 1000 Base SFP Ports Industrial Switch, 240 watts	552.00
065-7407GPOEP	4 Port 10/100/1000 Base T/TX (RJ45) PoE+ with 2 - 100/1000X SFP Ports	735.00
065-7410GPOEP	8 Port 10/100/1000 Base T/TX (RJ45) PoE+ with 2 - 100/1000X SFP Ports	885.00

[Note: 48 Volt, 75,120,240 Watt and 24 Volt, 30,60,75,120 Watt Din Rail Mt Power Supplies Available. Other 4, 6, 8 Managed 10/100 and 10/100/1000 Industrial Din Rail Mt. Switches available with and without PoE ports available.]

## FIS FIBER OPTIC VIDEO TRANSMITTERS AND RECEIVERS

- Electronic-to-photonic signal conversion
- NTSC/PAL signal
- Low-profile stand-alone devices
- No field adjustments required
- Transparent to cameras and monitoring equipment



Fiber optic video transmitters and receivers include the ability to convert video signals from coaxial cameras so that they can be transmitted over fiber optic cable. These low-profile standalone devices can be placed anywhere needed. They require no field adjustments during installation or additional maintenance thereafter. These devices are designed to be transparent to cameras and monitoring equipment regardless of the manufacturer. The receiver includes an indicator light that provides quick verification of system status.



Video Transmitter

S-850TX

### FIS FIBER OPTIC VIDEO TRANSMITTERS

PART #	DESCRIPTION	FIBER MODE	MAX. DISTANCE	PRICE
S-850TX	Standalone Fiber Optic Video Transmitter	MM 850nm	4 Km	\$150.00
S-1300TX	Standalone Fiber Optic Video Transmitter	MM 1300nm	8 Km	185.00
S-1310TX	Standalone Fiber Optic Video Transmitter	SM 1310nm	20 Km	220.00

### FIS FIBER OPTIC VIDEO RECEIVERS

PART #	DESCRIPTION	FIBER MODE	PRICE
S-850RX	Standalone Fiber Optic Video Receiver	MM 850nm	\$150.00
S-1300RX	Standalone Fiber Optic Video Receiver	SM/MM 1300nm	195.00

All include power supply



S-850RX  
Video Receiver

### SILENT ALARM TRANSMITTER AND RECIEVER

Our single channel 850nm converter is designed to provide a high performance, low cost solution for the transmission of Normally Open/Normally Closed contacts (NO/NC) over a single MM fiber. Alarm installers can now take a dry contact closure and wire it to our Fiber Optic transmitter and when the contact alarms it will convert that signal to light and send it to a multimode receiver (S-850RX) as listed above.

PART #	DESCRIPTION	PRICE
S-850SATX	Silent Alarm TX with power supply, MM 850nm	\$125.00
S-850RX	Fiber Optic Reciever, MM 850nm	144.00



S-850SATX  
Silent Transmitter

**fis UNIVERSITY**  
PREMIER FIBER OPTIC EDUCATION

Offering A  
Variety of Training Options

Same Great Class.

- Live Online Training
- Fiber I & II Hands On Training
- Custom Corporate Training
- At Your Own Pace Online Training

www.fissales.com | 1-800-5000-FIS(347)



# **fis** UNIVERSITY

## PREMIER FIBER OPTIC EDUCATION

### *About FIS University*

*Founded in 1985 by Fiber Instrument Sales, the nation's leading supplier and manufacturer of fiber optic components, FIS University's instructors have trained more than 25,000+ professionals world-wide in both basic and advanced techniques related to connectorization, testing and fiber optic splicing.*

### **NEW! Live Online Training**

**On completion of class student earns 16 BICSI CEC's!**

Live online learning. This course will cover the same material that is taught in our physical course and showcases the same equipment used throughout the training by the instructor. You will see your instructor via a video feed. It's just as though you were having a one on one conversation. This real time interaction is as if you were talking face to face. Discussions are always welcome and encouraged. FREE Johnny's Tool Box & fiber manual, a \$275.00 value. This tool box and manual is all you need to follow along for the entire training and it is included in the training price.

**Johnny's Tool Box** contains all the essential tools you will need to complete your training.

#### **TOOL BOX CONTENTS:**

- FIS University Training Manual
- Field Termination Cleaver
- FIS Mini Visual Fault Locator 2.5mm Adapter w/ black case
- Miller KS-1 Kevlar Shear
- FIS Three Hole Fiber Optic Stripper
- Universal SM & MM Fiber Optic Ultra Splice
- FIS Simplex 3mm SM Ultra SC/UPC-SC/UPC 2 Meters
- FIS Fiber Optic Alcohol Towelettes, 4" x 6"
- LED Fiber Inspection Scope w/Universal 2.5mm UPC/APC adapter

**Fiber cable included for class use:** Simplex, Duplex, Distribution, Breakout, Micro Distribution, Loose Tube Gel Filled, Indoor/Outdoor, Ribbon and Aluminum Interlocking Armored (AIA) Fiber.

### **Fiber Optics I and II – Two Days**

Fiber Instrument Sales offers training through FIS University, a leader in fiber training since its inception in 1996. This specialized training provides the technician with a solid foundation to build their careers in fiber optics. Our hands on training covers such topics as connectorization techniques, test equipment operation, fusion splicing, OTDR operation, network cabling installation and restoration, LAN applications and more. These courses are recognized by leading industry organizations including BICSI and ETA.

**View full curriculum and register online at [www.fiberinstrumentsales.com](http://www.fiberinstrumentsales.com)**

### **Online Fiber Optic Video Training**

If you can't make it to one of our world class training sessions, we have a great alternative, online training. Learn what you would like when you would like. You can go at your own pace and learn in the comfort of your office or home. This course includes 9 full hours of instructional videos brought to you by one of the most respected fiber experts in the industry.

### **Custom and Corporate**

We can provide you with fiber optic training uniquely geared for your organization. FIS University has developed and delivered thousands of customized courses, videos, and other training materials for organizations around the world, each geared specifically to the skill level and subject matter unique to your organization. Select a time & location convenient for you. **Learn more at [www.fiberinstrumentsales.com](http://www.fiberinstrumentsales.com)**



# Training Sessions Are Held Across The Nation!

## 2022 Training Schedule

### Fiber Optics I & II and Live Online Training

May 10-11 **Live Online**  
May 25-26 Atlantic City, NJ

June 7-8 **Live Online**  
June 13-14 Boise, ID  
June 13-14 Billings, MT  
June 20-22 Brightside  
June 28-29 **Live Online**

July 11-13 Brightside  
July 19-20 Minneapolis, MN  
July 19-20 **Live Online**  
July 21-22 Des Moines, IA  
July 25-27 Brightside

August 8-10 Brightside  
August 15-16 Kansas City, MO  
August 16-17 **Live Online**  
August 17-18 St. Louis, MO  
August 22-24 Brightside

September 12-14 Brightside  
September 19-21 Brightside  
September 27-28 **Live Online**

October 3-5 Brightside  
October 17-19 Brightside  
October 25-26 **Live Online**

November 7-8 Pittsburgh, PA  
November 9-10 Cleveland, OH  
November 15-16 Albany, NY  
November 22-23 **Live Online**

December 5-6 Boston, MA  
December 7-8 New York City, NY  
December 13-14 **Live Online**



\*These are tentative dates for the 2022 year and are subject to change. Visit us on the web at [www.fiberinstrumentsales.com](http://www.fiberinstrumentsales.com) for an up to date schedule.

To learn more about FISU's Training Programs, visit [www.fisuniversity.com](http://www.fisuniversity.com), call 1-800-5000-FIS (347), or email [training@fissales.com](mailto:training@fissales.com)

#### Further questions?

Contact Training Coordinator Grace Edel at 315-737-2169 or email [gedel@fissales.com](mailto:gedel@fissales.com)

BICSI recognizes FIS University's Live Online Training & Fiber Optic I and II courses for BICSI Continuing Education Credits (CECs)



### FIBER OPTIC TRAINING CLASSES

PART #	DESCRIPTION	PRICE
F267	Live Online Fiber Optic Training (2 days)	\$349.00
F265	Fiber Optic Hands-On I & II (2-day)	\$450.00
F265	Fiber Optic Hands-On I & II (2-day, Brightside)	649.00
F230	Fiber Optic Hands-On Day I (only)	\$225.00
F260	Fiber Optic Hands-On Day II (only)	\$275.00
TRAINING	Online Fiber Optic Video Training	\$195.00

### FIBER OPTIC TEXTBOOK

PART #	DESCRIPTION	PRICE
F1-MANUAL	FIS Training Manual 5th Edition	\$39.99
F1-9791	FIS Lab Manual 4th Edition	\$19.95



F1-MANUAL

## CLASSES IN THE ADIRONDACKS A UNIQUE TRAINING EXPERIENCE

Ask about training at beautiful Brightside-On-Raquette, our lakeside training center in the Adirondack Mountains of New York State. The Brightside provides a unique and relaxing environment in which to learn about fiber optic theory and techniques. This class follows the same curriculum as the standard FIS 2-day fiber classes.

The registration fee includes training, all meals and two-night's lodging in your own private room at The Brightside. Enjoy hiking, fishing, swimming, kayaking and more at this beautiful location on Raquette Lake.

**Brightside Training Class: \$649.00 / Person**

For more information about the tools used in class, recommended books and dvd's for a better understanding of fiber optics go to the website: [www.fiberinstrumentsales.com](http://www.fiberinstrumentsales.com)

Call 1.800.5000.FIS (347)  
Ask For Our Rental Department!



### OTDR RENTAL RATES

Launch cable included



FIS THUNDERBOLT



FIS MINI OTDR



FTB730C



AFL FLEXSCAN



VIATI T-BERD QUAD



	1 Week	2 Weeks	1 Month
FIS THUNDER BOLT	\$375.00	\$450.00	\$575.00
FIS Mini OTDR	\$375.00	\$450.00	\$575.00
EXFO MAX-720/730	\$575.00	\$675.00	\$800.00
AFL FLEXSCAN SM	\$475.00	\$575.00	\$700.00
VIATI T-BERD QUAD	\$575.00	\$675.00	\$800.00

### FUSION SPLICER RENTAL RATES

Includes cleaver, 1 spare set of electrodes, battery and charge cord



FIS CA6



FIS AC5



AFL 90S



SUMITOMO Q102CA



AFL 90R

	1 Week	2 Weeks	4 Weeks
<b>CORE ALIGNMENT</b>			
FIS CA6 <i>Cheetah SOC Compatible</i>	\$450.00	\$550.00	\$750.00
<b>CORE ALIGNMENT</b>			
AFL 90S, or SUMITOMO Q102CA <i>Cheetah SOC Compatible</i>	\$775.00	\$875.00	\$1,000.00
<b>ACTIVE V-GROOVE (Clad Alignment)</b>			
FIS AC5 <i>Cheetah SOC Compatible</i>	\$200.00	\$250.00	\$300.00
SUMITOMO Q101VSP <i>Cheetah SOC Compatible</i>	\$510.00	\$680.00	\$850.00
<b>MASS FUSION SPLICER (12 FIBER)</b>			
AFL 90R or SUMITOMO Q101M12	\$1,095.00	\$1,460.00	\$1,825.00

### TEST EQUIPMENT RATES



FIS MPO Test Set



AFL SMLP5-5



EXFO FOT-945 Max Tester



Fluke DSX-8000



Viavi Quad OLTS



	1 Week	2 Weeks	4 Weeks
<b>FIS MPO Test Set</b>			
FIS MPO 850 or 1310 Source Test Set	\$275.00	\$550.00	\$995.00
<b>AFL / SMLP5-5</b>			
PM and LS (Singlemode or Multimode, Downloadable Power Meter)	\$175.00	\$235.00	\$295.00
<b>EXFO MAX-945</b>			
MaxTester (pair) (Quad)	\$695.00	\$850.00	\$1,150.00
<b>FLUKE NETWORKS</b>			
VERSIV DSX-8000 (Copper Cable Analyzer)	\$425.00	\$550.00	\$695.00
<b>FLUKE NETWORKS</b>			
VERSIV DSX-5000 (w/ OLTS Modules, Copper and Fiber Analyzer)	\$1,110.00	\$1,400.00	\$1,850.00
<b>VIATI Loss Test Set</b>			
Viavi Quad OLTS	\$175.00	\$235.00	\$295.00



## FIBER OPTIC EQUIPMENT CALIBRATIONS / VERIFICATIONS



Stay compliant with industry standards by taking advantage of our full service calibration lab. All equipment is inspected, calibrated to NIST traceable standards, and verified to be in conformance with the manufacturer's specifications. Turn around time is typically 10 business days or less for standard services. All calibration services include a NIST traceable calibration / verification certificate. Units are available to rent for extended service or repairs.

E-mail us with any questions [calibration@fissales.com](mailto:calibration@fissales.com).

Visit us on our website at [www.fiberinstrumentsales.com/calibration/](http://www.fiberinstrumentsales.com/calibration/)



### All Verifications come with the following Service Features

- All calibration and/or verification services include a NIST traceable calibration certificate
- Verification of conformance with the manufacturer's specifications
- Ensure correct operation and performance

### OTDR VERIFICATION

	PRICE
FIS Handheld OTDR	\$300.00
EXFO Handheld OTDR	350.00
AFL Handheld OTDR	350.00
Anritsu Handheld OTDR	500.00
Platform OTDR and 1 Module	850.00
Additional Modules (Price Each)	350.00
Other Manufacturers - Call for pricing	

### TEST SET KIT VERIFICATION

	PRICE
FIS	\$140.00
EXFO	200.00
AFL	300.00
Anritsu	300.00
Other Manufacturers - Call for pricing	

\*Return Shipping Not Included in Pricing

### POWER METER AND LIGHT SOURCE VERIFICATION

	PRICE
FIS	\$75.00
EXFO	100.00
AFL	150.00
Anritsu	150.00
Other Manufacturers - Call for pricing	

### CLEAVER MAINTENANCE

	PRICE
Cleaver Maintenance and Evaluation, Blade Adjustment, Adjust Blade Height, Verify Proper Performance, and Replace Diamond Cleaver Blade*	\$210.00
<i>*Cost to service a cleaver with an autorotating cleaver blade is \$275.00</i>	
<i>*Subject to Program Availability</i>	

### FUSION SPLICER MAINTENANCE

	PRICE
Splicer Maintenance and Evaluation, Replace Electrodes, Clean Optical Components, Detailed Cleaning, and Diagnostic and Performance Tests	\$250.00

## Save Money! FIS NEW-2-YOU PROGRAM / FIS UPGRADE PROGRAM

Fiber Instrument Sales can save you money by providing a selection of pre-owned test and splicer equipment. We have demo models, overstock items, rental inventory, and an occasional trade-in all available at 20% to 60% off the original price.

Fiber Instrument Sales is also looking to purchase well kept, up to date used splicers and OTDRs. If you have a unit you are interested in selling and that unit is in working order (no repairs needed) please contact us for possible quote.

Contact your FIS sales representative for more information on New-2-You / FIS Upgrade Program. You may also contact FIS Services at 800-500-0347 extension 2176 and 2114; or at: [rentals@fissales.com](mailto:rentals@fissales.com).



# WHY FINANCE ?

Roughly **79%** of U.S. businesses - both small and fortune 500 - finance their equipment.\*

#### Retain Working Capital

Financing equipment allows for affordable monthly payments so that you can use working capital for day-to-day operational expenses.

#### Seasonal Payment Schedule

Protect your positive cash flow during seasonal fluctuations by financing with no money down and flexible 24-72 month finance terms.

#### Potential Tax Benefits

IRS Section 179 allows for equipment purchase write-offs. Consult with a tax advisor to take advantage of the benefit.

#### Cover All Related Expenses

Finance 100% of your purchase including installation, services, and software with one easy monthly payment.

\*Statistic provided by the Equipment Leasing and Financing Association.



Ask your FIS Sales Representative for details or email:

**1-800-500-FIS(347)**  
[qualitycontrol@fissales.com](mailto:qualitycontrol@fissales.com)

# INDEX

- Active Equipment ..... 157-162
- Adapters, Fiber Optic ..... 144-148
- Adapter Kit, Fiber Optic ..... 145
- Adapter Plates ..... 70, 72, 73
- Adapters, Buffered Fiber ..... 137
- Adapters, FC Hybrid ..... 144, 145
- Adapters, Hybrid ..... 144, 145
- Adapters, LC Hybrid ..... 144, 145
- Adapters, ST Hybrid ..... 144, 145
- Adhesive, Anaerobic ..... 138
- Adhesive, Bobtail ..... 129
- Adhesives, UV ..... 138
- Aerial Cable, Self-Supporting ..... 100, 101
- Air, Canned ..... 104
- Alcohol Isopropyl ..... 105
- Anaerobic Adhesive ..... 138
- Antenna Analyzer ..... 30
- Aqua Patch Cables, 10 Gig ..... 8
- Armored Cable ..... 100-101
- Assemblies ..... 6-16
- Attenuators, Bulkhead ..... 149
- Attenuators, Fiber Optic ..... 149, 150
- Backbone Trunk Cable Assemblies ..... 12, 13
- Bare Fiber ..... 94, 95
- Bare Fiber Pigtail Kit ..... 36
- Bend Optimized Cable ..... 96-101
- Bobtail Adhesive ..... 129
- Bobtail Installation Kit ..... 129
- Bobtail Quick Term Connectors ..... 129
- Boots, Connector ..... 136
- Break-Out Kits ..... 103
- Broadcast Cable Reels ..... 19
- Buffered Fiber Adapters ..... 137
- Bulk Connectors & Adapters ..... 132, 134, 135, 149
- Bulkhead / Adapter Cleaners ..... 109
- Buried Cable Marker Tapes ..... 126
- Cable ..... 95-101
- Cable Aerial, Self-Supporting ..... 100, 101
- Cable, Armored ..... 100-101
- Cable Assemblies ..... 6-19
- Cable Assemblies, Broadcast, Custom ..... 16
- Cable Assemblies, Copper ..... 154
- Cable Assemblies, Custom ..... 10-14
- Cable Assemblies, SMPTE ..... 16
- Cable Assemblies, TFOCA II ..... 16
- Cable, Bend Optimized ..... 96-101
- Cable Caster ..... 123
- Cable Clamps ..... 124
- Cable, Copper ..... 154
- Cable, Custom Fiber Optic ..... 94
- Cable Cutting / Slitting Tools ..... 117-119
- Cable Dispenser ..... 17, 123
- Cable, Distribution ..... 98, 100
- Cable, Drop ..... 81, 101
- Cable, Duplex ..... 95, 96
- Cable, Fiber Optic ..... 95-101
- Cable, Fiber, Tactical/Broadcast ..... 17, 101
- Cable, Gigabit ..... 96-100
- Cable, Large Core Fiber Optic ..... 94, 95
- Cable, Loose Tube ..... 100
- Cable Management ..... 65, 69, 77, 79
- Cable Management Racks ..... 65, 69
- Cable, Micro-Distribution ..... 99, 100
- Cable Preparation Tools ..... 116-119, 121
- Cable Pull Tape / String ..... 123
- Cable Pulling Lubricant ..... 123
- Cable Reels, Broadcast ..... 19
- Cable, Ribbon ..... 96
- Cable, Simplex ..... 95, 96, 97
- Cable Spools ..... 94, 123
- Cable Stripping Tools ..... 61, 116
- Cable Ties ..... 124
- Cable, Tight Buffer ..... 95
- Calibration Services ..... 167
- Canned Air ..... 104
- Cap & Chain, Metal ..... 137
- Cat 5e, 6, 6A Products ..... 154-156
- Cleaning Kits ..... 111, 115
- Cleaning Pen, Fiber Optic ..... 105
- Cleaning Solutions, Fiber Optic ..... 105-107
- Cleaning Wipes, Fiber Optic ..... 104-107
- Cleavers, Fiber Optic ..... 60, 61
- Closures, Outdoor, Splice ..... 82-85, 88-92
- Compact Node Cables ..... 14
- Connectors, Fiber Optic ..... 129-135
- Connector Boots ..... 136
- Connector Cleaner Cartridges ..... 108
- Connector Epoxy ..... 138
- Connector Ferrules ..... 152, 153
- Connector Heat Ovens ..... 139
- Connector Removal Tools ..... 122
- Connectors & Adapters Bulk ..... 132, 134, 135, 149
- Connectors & Mating Sleeves ..... 129-135, 144-148
- Connectors, Bobtail Quick Term ..... 129
- Connectors, FC ..... 134, 135
- Connectors, Fiber Optic ..... 129-135
- Connectors, Fusion Splice-On ..... 50, 51, 55, 59
- Connectors, Hot Melt ..... 131
- Connectors, LC ..... 135
- Connectors, MTP ..... 133
- Connectors, Quick Termination ..... 129-131
- Connectors, SC ..... 132
- Connectors, ST ..... 134
- Connectors, Terminator ..... 134
- Consumables ..... 104-111
- Continuity Tester ..... 47
- Copper ..... 154-156
- Copper Cable ..... 154
- Copper Cable Assemblies ..... 154
- Copper Cabling Patch Panels ..... 156
- Copper Connectors, Jacks & Inserts ..... 156
- Copper Faceplates & Outlets ..... 156
- Copper Test Equipment ..... 34, 35, 155
- Couplers / Splitters ..... 15, 80, 86, 87
- Coupler Modules ..... 15, 80, 86, 87
- Coupler Modules, Custom ..... 15, 80, 86, 87
- Crimp Tools, Fiber Optic ..... 120
- Custom Broadcast Cable Assemblies ..... 16
- Custom Cable Assemblies ..... 10-13, 16
- Custom Coupler Modules ..... 15, 80, 86, 87
- Custom Drilling Service ..... 152-153
- Custom Fiber Optic Enclosures ..... 67-68
- Custom Test Boxes ..... 37
- Custom Mode Conditioning Patch Cables ..... 14
- Custom Splitters & CWDM Pre-Terminated Systems ..... 15, 80, 86, 87
- Custom MTP Backbone Assemblies ..... 12, 13
- Custom Patch Cables ..... 10-11
- Custom Rack Mounts ..... 67
- Data Center Cabling ..... 99
- Disposal Unit, Fiber Optic ..... 104
- Distribution Cable ..... 98-100
- Drilling Service, Custom ..... 152-153
- Drop Cables ..... 81, 101
- Duplex Cable ..... 96, 97
- E2000 Patch Cables / Mating Sleeves ..... 14
- Elastomeric Lab Splice ..... 62
- Enclosures, Outdoor ..... 82-85, 88-92
- Enclosures, Rack & Wall Mount ..... 64-69, 72-75
- Epoxy ..... 138
- Epoxy Application Syringe ..... 139
- Epoxy Connectors ..... 132-135
- Ethernet Active Devices ..... 160-162
- Ethernet Desktop Switches ..... 160, 161
- Ethernet Fiber Modules ..... 160, 161, 162
- Ethernet Mini Switches ..... 160
- Ethernet Switches ..... 160-162
- Eye Loupe Set ..... 121
- Fan-Out Kits ..... 103
- Fault Locator ..... 46-47, 48
- FC Connectors ..... 134, 135
- FC Hybrid Adapters ..... 144, 145
- FC Mating Sleeves ..... 144, 145, 148
- Ferrule Protection Caps ..... 136
- Ferrules, Connector ..... 152, 153
- Fiber, Bare ..... 95
- Fiber Fence Security ..... 151
- Fiber Identifier ..... 38, 39
- Fiber Inspection Probes ..... 23, 29, 31, 44, 45
- Fiber Modules, Ethernet ..... 160, 161, 162
- Fiber Optic Adapter Kit ..... 145
- Fiber Optic Attenuators ..... 149, 150
- Fiber Optic Cable ..... 95-101
- Fiber Optic Cleaning Solutions ..... 105-107
- Fiber Optic Cleaning Wipes ..... 104-107
- Fiber Optic Connectors ..... 129-135
- Fiber Optic Disposal Unit ..... 104
- Fiber Optic Patch Cables ..... 6-14
- Fiber Optic Sensors ..... 151
- Fiber Optic Swabs ..... 110
- Fiber Optic Talk Sets ..... 41
- Fiber Optic Tool Kits ..... 112-114
- Fiber, Specialty ..... 95
- Fish Tape/Poles ..... 123
- Flush Mount Patch Frame ..... 64
- Furcation Tubes ..... 102
- Fusion Splice-On Connectors ..... 50, 51, 55, 59
- Fusion Splicer Rentals ..... 166
- Fusion Splitters ..... 52-53, 56-59
- Glasses, Safety and Magnifying ..... 122
- Hand Tools ..... 116-122
- Heat Gun ..... 122
- Heat Ovens, Connector ..... 139
- Heater Protection Sleeve ..... 139
- Hermaphroditic 4 Channel Connectors ..... 16
- Hot Melt Connectors ..... 131
- Hybrid Adapters ..... 144, 145
- Identifier, Fiber ..... 38, 39
- Innerduct and Accessories ..... 128
- Inspection Microscopes ..... 23, 29, 31, 44, 45
- Inspection Probes ..... 23, 29, 31, 44, 45
- Interconnects, Rack ..... 64, 65, 67, 68, 72, 73
- Kim Wipes ..... 105
- Kits, Installation ..... 112-114
- Kits/Connector Restoration ..... 130, 131
- Labels ..... 125, 126
- Laser Safety Caps ..... 137
- Launch Boxes ..... 37
- LC Connectors ..... 135
- LC Hybrid Adapters ..... 144, 145
- LC Mating Sleeves ..... 147
- Locators, Underground ..... 127
- Loopback Modules ..... 14
- Loose Tube Cable ..... 100
- Magnifying and Safety Glasses ..... 121, 122
- Mandrels ..... 36
- Marker Tapes, Buried Cable ..... 126
- Matching Gel ..... 104
- Mating Sleeves, FC ..... 148
- Mating Sleeves, LC ..... 147
- Mating Sleeves, SC ..... 146
- Mating Sleeves, ST ..... 148
- Mechanical Splice Protection Sleeves ..... 62
- Mechanical Splices ..... 62
- Media Converters ..... 160-162
- Micro-Distribution Cable ..... 99, 100
- Microscopes, Inspection ..... 23, 29, 31, 44, 45
- Microscopes, Video ..... 23, 29, 31, 44, 45
- Mini OTDR's ..... 20, 30, 32, 33
- Mode Conditioning Patch Cables ..... 14
- MTP Backbone Assemblies, Custom ..... 12-13
- MTP Cassettes ..... 12-13, 68
- MTP Connectors ..... 133
- MT-RJ Mating Sleeves ..... 148
- MU Mating Sleeves ..... 148
- Multimode Patch Cables ..... 8-9
- NID's, Fiber Optic ..... 82, 83, 89
- Node Cables, Compact ..... 14
- Optical Couplant ..... 104
- Optical Loss Test Equipment ..... 28, 34, 42, 43
- Optical Spectrum Analyzer ..... 22, 24, 26, 27, 28
- OTDR Test Boxes ..... 37
- OTDR Rentals ..... 166
- OTDR's ..... 20-22, 24, 26, 27, 30-34
- Outside Plant ..... 80-93
- Oven Protection Sleeves ..... 139
- Patch Panels, Copper Cabling ..... 156
- Patch Panels, Fiber Optic ..... 64-69, 72, 73
- Patch Cables, 10 Gig OM3 & OM4 Aqua ..... 8
- Patch Cables, Custom ..... 10-12
- Patch Cables, Fiber Optic ..... 6-14
- Patch Cables, Mode Conditioning ..... 14
- Patch Cables, Multimode ..... 8, 9
- Patch Cables, Polarization Maintaining ..... 14
- Patch Cables, Singlemode ..... 6, 7
- Piano Wire ..... 104
- Pigtail, Gold Tipped ..... 36
- Pigtail Kit, Bare Fiber ..... 36
- Pigtail Snap Packs ..... 71
- Pigtails for Splicing ..... 71
- Pigtails, Distribution Style ..... 71
- Planar Lightwave Splitters ..... 86
- Plastic Fiber Optic Cable ..... 94
- Plates, Adapter ..... 70, 72, 73
- Pocket Fault Locator ..... 46, 47
- Polarization Maintaining Patch Cables ..... 14
- Polish Films ..... 140-141
- Polish Machines ..... 142
- Polish Plates, Pads & Mats ..... 143
- Polishing Discs ..... 143
- Power Meter & Light Source ..... 34, 40-43
- Power Meter/Light Source Rentals ..... 166
- Precision Cleavers ..... 60
- Pre-loaded Distribution Interconnects ..... 67, 68
- Probe, Inspection ..... 23, 29, 31, 44, 45
- Protection Sleeve Heater ..... 49
- Pulse Boxes, Test ..... 37
- Quick Termination Connectors ..... 129-131
- Rack & Wall Mount Enclosures ..... 64-69, 72-75
- Rack Mounts, Custom ..... 67, 68
- Racks, Cable Management ..... 65, 79
- Rentals ..... 166
- Ribbon Cable ..... 96
- SC Adapter Caps ..... 136, 137
- SC Connectors ..... 132
- SC Mating Sleeves ..... 144-146
- Scribe Tools ..... 120
- Sensors, Fiber Optic ..... 151
- Service Cables ..... 14
- SFP-Small Form Pluggable ..... 157
- Shrink Tubes, Colored ..... 122
- Signs, Warning ..... 126
- Simplex Cable ..... 96, 97
- Singlemode Patch Cables ..... 6, 7
- SMPTE Cable Assemblies ..... 16
- SMPTE Cleaning Kit ..... 19
- SMPTE Test Set ..... 19
- Sno Shoes, Fiber Optic ..... 91, 92
- Specialty Fiber ..... 95
- Spectrum Analyzer, Optical ..... 22, 24, 26, 27, 28
- Spectrum Analyzer, Wireless ..... 30
- Splice Bridges ..... 76
- Splice Closures, Outdoor ..... 82-85, 88-92
- Splice on Connectors ..... 50, 51, 55, 59
- Splice Holding Chips ..... 76
- Splice Tents ..... 127
- Splice Sleeves ..... 63, 88
- Splice Trays ..... 73, 76, 88, 89, 90, 91, 92
- Splitters, Fusion ..... 50-53, 56-59
- Splitters, Lab ..... 62
- Splitters Mechanical ..... 62
- Splitters, Planar Lightwave ..... 86
- ST Connectors ..... 134
- ST Hybrid Adapters ..... 144, 145
- ST Mating Sleeves ..... 148
- Stripping Tools, Cable ..... 61, 116, 118
- Swabs, Fiber Optic ..... 110
- Switch Modules, Ethernet ..... 160-162
- Switches, Ethernet ..... 160-162
- Switches, Ethernet Desktop ..... 160, 161
- Switches, Mini, Ethernet ..... 160
- Syringe, Epoxy ..... 139
- Table, Portable ..... 59, 127
- Tactical/Broadcast Fiber Optic Cable ..... 17, 101
- Tactical/Broadcast Products ..... 16-19
- Talk Sets, Fiber Optic ..... 41
- Terminator Connectors ..... 37
- Test Boxes ..... 14
- Test Equipment, Fiber Optic ..... 20-48
- Test Equipment, Copper ..... 34, 35, 155
- Test Equipment Rentals ..... 166
- Test Equipment, Ruggedized ..... 20, 40, 48
- Test Set, Optical Loss ..... 28, 34, 42, 43
- Test Set Rentals ..... 166
- Test Set, SMPTE ..... 19
- TFOCA II Cable Assemblies ..... 16
- Tie Wraps ..... 124
- Tight Buffer Cable ..... 95
- Tools ..... 112-128
- Tool Kits, Fiber Optic ..... 112-114
- Tools, Cable Preparation ..... 116-119, 121
- Tools, Copper Cabling ..... 156
- Tracer Tape ..... 123
- Training & Education ..... 164, 165
- Trunk Cable Assemblies, Backbone ..... 12, 13
- UV Adhesives ..... 138
- Velcro Roll ..... 124
- Video Microscopes ..... 23, 29, 31, 44, 45
- Video Transmitters & Receivers ..... 163
- Visual Fault Locator ..... 46, 47
- Wave Division Multiplexers ..... 15, 87
- WDM's ..... 15, 87
- Wireless Test Equipment ..... 30
- Work Tables/Platforms ..... 59, 127

## TRAINING

- Fiber Optic Lab Manual ..... 165
- Fiber Optic Training Posters ..... 165
- Textbooks ..... 165
- Training Programs ..... 164
- Training Schedule ..... 165

# FIS SATISFACTION GUARANTEED POLICY

If you are not 100% satisfied with your order, call toll-free to arrange for an exchange or return of goods. Any stock items contained in this catalog may be returned upon your prompt inspection of received goods.\*

Any discrepancies with an order must be reported to FIS within 24 hours of receipt. Return Merchandise Authorization (RMA) numbers must be requested within 3 days of receipt of your product and returned to FIS head office within 7 days from receipt of goods. All product returned must be marked with an FIS RMA number and be new and in unopened, full shipping unit quantities. Credit cannot be issued without an FIS authorized RMA.

\*Non-Standard ("Custom") Products, as defined by FIS as Products that are special orders, custom orders, and orders for non-standard products, products not customarily in stock or orders for value-added products are non-cancellable and non-refundable. Custom cut cable ordered in error is non returnable. Custom made and un-cataloged items will not be accepted for return. FIS reserves the right to charge a re-stocking fee.

**Order Information: Minimum Order:** \$50.00. Terms: 30 days net. FOB: Oriskany, New York. Amex, Discover, Mastercard and Visa accepted. In all cases freight will be charged for all product shipped. Overdue accounts are subject to a 2% monthly finance charge. In case of price deviations, notification will be made prior to processing of your order. Photographs may not accurately portray present product. Specification sheets available on most catalog items. Quantity discounts available on all items upon request. First time orders for new accounts cannot be processed unless accompanied by a completed credit application. Please allow 3 working days for your application to be processed. TERMS: Net 30 days from date of invoice unless otherwise stated.

**IMPORTANT NOTICE:** Prices subject to change without notice. All statements, technical information and recommendations related to the Seller's products are based on information believed to be reliable, but the accuracy or completeness thereof is not guaranteed. Before utilizing the product, the user should determine the suitability of the product for its intended use. The user assumes all risks and liability whatsoever in connection with such use. Any statements of recommendations of the Seller which are not contained in the Seller's current publication shall have no force or effect unless contained in an agreement(s) signed by an authorized officer of Seller.

**PRICE NOTICE:** FIS will strive to maintain the prices as listed within this catalogue, however, in the event FIS experiences unexpected price increases from their vendors or related suppliers, or in the event of supply chain disruption, FIS reserves the right to update pricing to account for the change in market or supply chain costs. The prices as listed within this catalogue are subject to change.

## Terms and Conditions

The Standard Terms and Conditions of Sale ("Terms") as published at <https://www.fiberinstrumentsales.com/docs/Fiber-Instrument-Sales-Standard-Terms-Conditions.pdf> are applicable to all quotes, bids and sales of products and goods by Fiber Instrument Sales, Inc. to the Customer. Except as otherwise provided for therein, these Terms may only be modified or amended upon a mutual written contract amendment signed by authorized representatives of both Supplier and Buyer. No oral agreements or representations shall be valid or binding upon the Supplier or Buyer. Supplier may update, amend, modify or supplement such Terms from time to time upon prior notice to Buyer.

## Warranty Overview

Fiber Instrument Sales Inc, hereafter referred to as FIS, warrants that a product will be free from defects in materials and workmanship and conforms to FIS Specifications. The warranty period for a product is a specified, fixed period commencing on the customer's date of purchase. A valid proof of purchase may be required. If the customer does not have a valid proof of purchase, the warranty period will be measured from the date of sale indicated within FIS records. If, during the warranty period, the product is not in good working order, FIS may, at its option, repair or replace it at no additional charge, except as is set forth below.

The warranty period for products sold and manufactured by FIS is as follows:

- All products, excluding test and fiber splicing equipment: 30 Days
- Distributed test and fiber splicing equipment: Original manufacturer's warranty applies
- FIS manufactured test and fiber splicing equipment: 1 year

## Items Not Covered by Warranty

FIS does not warrant uninterrupted or error-free operation of product or equipment. Unless specified otherwise, FIS references the original equipment manufacturer's warranty and its subsequent requirements on non-Fiber Instrument Sales Inc. products. Any technical or other support provided for a product under warranty, such as assistance via telephone with "how-to" questions and those regarding use, setup and installation, will be provided WITHOUT WARRANTIES OF ANY KIND.

## Extent of Warranty

The warranty does not cover the repair or exchange of a product resulting from misuse, accident, modification, unsuitable physical or operating environment, improper maintenance by the customer, or failure caused by a product for which FIS is not responsible. The warranty may be voided by removal or alteration of product, parts, security or identification labels. Distributed products not manufactured by FIS will be replaced or credited if determined to be defective, not including labor or any associated cost of repair or replacement.

THESE WARRANTIES ARE THE CUSTOMER'S EXCLUSIVE WARRANTIES AND REPLACE ALL OTHER WARRANTIES OR CONDITIONS, EXPRESS OR IMPLIED, INCLUDING, BUT NOT LIMITED TO, THE IMPLIED WARRANTIES OR CONDITIONS OF MERCHANTABILITY AND FITNESS FOR A PARTICULAR PURPOSE. THESE WARRANTIES GIVE THE CUSTOMER SPECIFIC LEGAL RIGHTS AND YOU MAY ALSO HAVE OTHER RIGHTS WHICH VARY FROM JURISDICTION TO JURISDICTION. SOME JURISDICTIONS DO NOT ALLOW THE EXCLUSION OR LIMITATION OF EXPRESS OR IMPLIED WARRANTIES, SO THE ABOVE EXCLUSION OR LIMITATION MAY NOT APPLY TO THE CUSTOMER. IN THAT EVENT, SUCH WARRANTIES ARE LIMITED IN DURATION TO THE WARRANTY PERIOD. NO WARRANTIES APPLY AFTER THAT PERIOD.

## Warranty Service

Warranty service may be obtained from FIS by returning a Return Material Authorization Form (RMA), during the warranty period for the FIS - manufactured product, to FIS's Quality Assurance Manager. The customer may be required to present proof of purchase or other similar proof of warranty entitlement. The customer may be responsible for any associated transportation charges, duties and insurance. The product, once arriving at FIS, will be evaluated to determine cause of failure, with warranty action determined from evaluation.

Fiber Instrument Sales, Inc.  
161 Clear Road  
Oriskany, NY 13424

Standard  
U.S. Postage  
**PAID**  
Fiber Instrument  
Sales, Inc.

Где купить:  
ООО "КОМПАНИЯ ОПТУЛС"  
г.Москва, ул.Иловайская, д.3, стр.2  
Tel.: +7 (495) 646-00-96  
E-Mail: sale@opttools.ru  
Internet: www.opttools.ru



## ASSOCIATIONS:



## PARTNERS:



161 Clear Road, Oriskany, NY 13424  
Outside the US: 1-315-736-2206

Fax: (315) 736-2285  
Email: info@fiberinstrumentsales.com