

PREISKATALOG WERKZEUGE 2017

PRICE CATALOGUE TOOLS | CATALOGUE DE PRIX OUTILS | CATALOGO DE PRECIOS HERRAMIENTAS

HEYCO



www.heyco-tools.de





WIR STATTEN VISIONEN AUS

HEYCO wurde 1937 durch die Brüder Max und Ernst Heynen ursprünglich als Hersteller von Handwerkzeugen gegründet. Neben der Fertigung von Handwerkzeugen wurde seit 1980 das Fertigungsspektrum kontinuierlich erweitert und HEYCO entwickelte sich zusätzlich zum kompetenten Lieferanten von Kunststoff- und Schmiedeteilen für die Automobilindustrie.

Bei den Automotive Kunden ist HEYCO als Entwicklungspartner für das Modul- und Systemgeschäft anerkannt und wird für die Prototypenfertigung geschätzt. Unter Berücksichtigung der Kundenvorgabe entstehen an den Produktionsstandorten qualitativ anspruchsvolle, technisch und wirtschaftlich ausgereifte Komponenten für die Automobil- sowie deren Zulieferindustrie.

Im angestammten Geschäft exportiert HEYCO heute Werkzeuge in über 70 Länder.

WE MATERIALIZE VISIONS

In 1937, HEYCO was originally founded by Max and Ernst Heynen as a manufacturer of hand tools. Besides this, the range of products was continuously expanded since 1980. HEYCO emerged as a competent supplier of plastic- and forged components for the automotive industry.

HEYCO is widely recognised as development partner for the module- and systems business by its automotive customers and is much valued for its prototype production. Taking into account customer specifications, HEYCO produces technically and economically mature high grade components.

In its traditional field of business activity, HEYCO is exporting tools to more than 70 countries.

NOUS ANTICIPONS L'AVENIR

HEYCO a été fondée en 1937 par les frères Max et Ernst Heynen en tant que fabricant d'outils à main. Outre la fabrication d'outils à main depuis 1980, la gamme de production est en constante expansion, Heyco c'est également développé en tant que fournisseur de pièces en fer forgé et en plastique pour l'industrie automobile.

Dans le secteur automobile Heyco est reconnu comme un partenaire de développement pour les entreprises et le système de modules, et valorisé pour le prototypage rapide. Soumis aux exigences des clients dans les usines de production, ils produisent des composants avancés, des composants de qualité, techniquement en ordre et économique pour l'industrie automobile et le fournisseur d'industrie.

Dans les outils économiques traditionnels Heyco exporte dans plus de 70 pays.

CONVERTIMOS VISIONES EN REALIDAD

En 1937 los hermanos Max y Ernst Heynen fundaron HEYCO empezando con la fabricación de herramientas manuales. Aparte de esta producción, desde 1980 la gama de productos se ha ido ampliando continuamente, convirtiéndose así HEYCO en un competente proveedor de piezas de plástico y acero forjado para la industria del automóvil.

Para el sector del automóvil, HEYCO es un interlocutor innovador reconocido para el desarrollo de módulos y sistemas, gozando su producción de prototipos de gran prestigio. Tomando como referencia las especificaciones de sus clientes, de los centros de producción salen componentes de la calidad más exigente, tecnológica y comercialmente perfeccionados para la industria del automóvil y sus proveedores.

A día de hoy HEYCO exporta herramientas a más de 70 países.

HAUPTSITZ UND VERWALTUNG

HEYCO-WERK
Heynen GmbH & Co. KG
Birgden III/1
42855 Remscheid
Germany
Tel.: +49 (0) 2191 205-0
Fax: +49 (0) 2191 205-266
E-Mail: info@heyco.de
www.heyco.de

ZWEIGNIEDERLASSUNGEN DEUTSCHLAND

HEYCO-WERK SÜD
94104 Tittling
Germany

HEYCO-WERK REMSCHEID
Industriegebiet Bergisch-Born
42897 Remscheid
Germany

AUSLANDSGESELLSCHAFTEN

HEYCO-WERK IRELAND Ltd.
Ballina Co. Mayo
Republic of Ireland

HEYCO-WERK ČR s.r.o.
CZ-39701 Pisek
Czech Republic

HEAD OFFICE AND ADMINISTRATION

HEYCO-WERK
Heynen GmbH & Co. KG
Birgden III/1
42855 Remscheid
Germany
Phone: +49 (0) 2191 205-0
Fax: +49 (0) 2191 205-266
E-Mail: info@heyco.de
www.heyco.de

GERMAN BRANCHES

HEYCO-WERK SÜD
94104 Tittling
Germany

HEYCO-WERK REMSCHEID
Industriegebiet Bergisch-Born
42897 Remscheid
Germany

FOREIGN SUBSIDIARIES

HEYCO-WERK IRELAND Ltd.
Ballina Co. Mayo
Republic of Ireland

HEYCO-WERK ČR s.r.o.
CZ-39701 Pisek
Czech Republic

SIÈGE SOCIAL ET ADMINISTRATION

HEYCO-WERK
Heynen GmbH & Co. KG
Birgden III/1
42855 Remscheid
Germany
Phone: +49 (0) 2191 205-0
Copie: +49 (0) 2191 205-266
E-Mail: info@heyco.de
www.heyco.de

USINES EN ALLEMAGNE

HEYCO-WERK SÜD
94104 Tittling
Germany

HEYCO-WERK REMSCHEID
Industriegebiet Bergisch-Born
42897 Remscheid
Germany

FILIALES ÉTRANGÈRES

HEYCO-WERK IRELAND Ltd.
Ballina Co. Mayo
République d'Irlande

HEYCO-WERK ČR s.r.o.
CZ-39701 Pisek
République Tchèque

SEDE SOCIAL Y ADMINISTRACION

HEYCO-WERK
Heynen GmbH & Co. KG
Birgden III/1
42855 Remscheid
Germany
Fono: +49 (0) 2191 205-0
Fax: +49 (0) 2191 205-266
E-Mail: info@heyco.de
www.heyco.de

FILIALES EN ALEMANIA

HEYCO-WERK SÜD
94104 Tittling
Germany

HEYCO-WERK REMSCHEID
Industriegebiet Bergisch-Born
42897 Remscheid
Germany

COMPAÑIAS EN EL EXTRANJERO

HEYCO-WERK IRELAND Ltd.
Ballina Co. Mayo
Republic of Ireland

HEYCO-WERK ČR s.r.o.
CZ-39701 Pisek
Republica Checa



STANDORTE

OUR LOCATIONS

LES SITES

EMPLAZAMIENTOS

HEYCO-WERK REMSCHEID BIRGDEN III *Bergisches Land*

Max und Ernst Heynen legten wie alle Bergischen Gründer großen Wert auf ein familiäres Betriebsklima. So wohnten sie nach guter alter Sitte gleich dort, wo sie auch arbeiteten.

Seit 1937 wuchs unser Stammhaus mit Verwaltung, Zentrallager und Versand kontinuierlich zu seiner heutigen Größe. Dabei wurde das Elternhaus Heynen in den Bürokomplex eingebunden.



In typical Bergisches Land tradition, Max and Ernst Heynen always placed a high value on providing a family environment in their company. As was the good old-fashioned custom, they lived where they worked.

From 1937, our headquarters – administration, central warehouse and distribution centre – continuously expanded to its current size.

As the company grew, the Heynen home was integrated into the office complex.

Comme tous les entrepreneurs de la région, Max et Ernst Heynen accordaient une grande importance à un climat d'entreprise familial. Et c'est pourquoi, conformément aux meilleures traditions, ils avaient élu domicile près de leur lieu de travail.

Depuis 1937, le siège de notre entreprise, qui comprend les services administratifs, l'entrepôt principal et l'expédition, n'a cessé de se développer pour atteindre sa taille actuelle. La maison familiale des Heynen se trouve à présent intégrée au complexe administratif.

Como todos los empresarios de la región Bergisches Land, Max y Ernst Heynen le daban gran importancia a un ambiente empresarial familiar. De este modo, vivían, tal como era costumbre, en el mismo lugar donde trabajaban.

Desde 1937 nuestra casa central ha seguido creciendo continuamente con su administración, almacén central y distribución, hasta adquirir sus dimensiones actuales. Ello se llevó a cabo integrando la casa paterna Heynen en el complejo de oficinas.

HEYCO-WERK REMSCHEID/ BERGISCH-BORN *Bergisches Land*



HEYCO-WERK SÜD *Bayerischer Wald*

HEYCO-WERK IRELAND Ltd. *Irland*



HEYCO-WERK CR s.r.o. *Tschechien*



ZERTIFIKATE

CERTIFICATION

LES CERTIFICATS

CERTIFICADOS

WIR HALTEN, WAS
WIR VERSPRECHEN

WE KEEP
OUR PROMISES

NOUS TENONS
NOS PROMESSES

LO QUE PROMETEMOS
LO CUMPLIMOS

ZERTIFIZIERTES QM
SYSTEM

TS/ISO 16949
DIN EN ISO 9001

CERTIFIED
QM SYSTEM

TS/ISO 16949
DIN EN ISO 9001

SYSTEME
CERTIFIE QM

TS/ISO 16949
DIN EN ISO 9001

SISTEMA
QM CERTIFICADO

TS/ISO 16949
DIN EN ISO 9001





PRODUKT-
GRUPPEN

PRODUCT
GROUPS

LES GAMMES
DE PRODUITS

GRUPOS
DE PRODUCTOS

WIR ZEIGEN, WAS
WIR KÖNNEN

WE SHOW WHAT
WE CAN DO

NOUS MONTRONS CE
QUE NOUS SAVONS FAIRE

DEMOSTRAMOS DE LO
QUE SOMOS CAPACES

Qualitätswerkzeuge
Schmiedekomponenten
Technische
Kunststoffprodukte
IMD - Inset Moulding

Quality tools
Precision mouldings
Technical
plastic products
In mould decoration

Outils de qualité
Composants forgés
Matières
plastiques techniques
Moulage par insertion
IMD

Herramientas de calidad
Componentes de forja
Productos
técnicos de plástico
Moldeado por inserción
IMD



WIR PRÜFEN STÄNDIG,
WAS WIR TUN

WE KEEP A CLOSE EYE
ON WHAT WE DO

NOUS CONTRÔLONS
CONSTAMMENT CE QUE
NOUS FAISONS

CONTROLAMOS
CONSTANTEMENTE LO
QUE HACEMOS





ABKÜRZUNGEN UND HINWEISE

ST 00	standardmäßig
G 05	gesandstrahlt
A 10	schwarz
AS 11	schwarz, teilweise geschliffen
ASD 13	schwarz, teilweise geschliffen, Griffe kunststoffbeschichtet
L 20	lackiert
LS 21	lackiert, teilweise geschliffen
LD 24	lackiert, Griffe kunststoffbeschichtet
LG 25	lackiert, teilweise gesandstrahlt
B 30	brüniert
BI 32	brüniert, mit Kunststoffhüllen
BV 33	brüniert, VDE 1000 Volt schutzisoliert
PH 36	phosphatiert
PHS 37	phosphatiert, teilweise geschliffen
P 40	poliert
MS 45	Messing
N 50	vernickelt
ND 54	vernickelt, Griffe kunststoffbeschichtet
NI 55	vernickelt, mit Kunststoffhüllen
Z 60	verzinkt, blau chromatiert
ZCG 61	verzinkt, gelb chromatiert
K 68	antikorrosive Spezialbeschichtung
CL 70	chromfarbig
C 80	verchromt
CP 82	verchromt, teilweise poliert
CPP 83	verchromt, ganz poliert
CI 85	verchromt, kunststoffüberzogen
CPI 86	verchromt, Kopf poliert, mit Kunststoffhüllen
CPD 87	verchromt, Kopf poliert, Griffe kunststoffbeschichtet
CPV 88	verchromt, Kopf poliert, VDE-Isoliergriffhüllen

ABBREVIATIONS AND NOTES

ST 00	standard
G 05	sandblasted
A 10	black
AS 11	black, partly ground
ASD 13	black, partly ground, plastic coated handles
L 20	lacquered
LS 21	lacquered, partly ground
LD 24	lacquered, plastic coated handles
LG 25	lacquered, partly sandblasted
B 30	gun-metal finish
BI 32	gun-metal finish, insulated
BV 33	gun-metal finish, VDE 1000 volt insulated
PH 36	phosphated
PHS 37	phosphated, partly ground
P 40	polished
MS 45	brass
N 50	nickel plated
ND 54	nickel plated, plastic coated handles
NI 55	nickel plated, insulated
Z 60	zinc plated, blue chromatised
ZCG 61	zinc plated, yellow chromatised
K 68	special anti-corrosive plating
CL 70	chrome coloured
C 80	chrome plated
CP 82	chrome plated, partly polished
CPP 83	chrome plated, fully polished
CI 85	chrome plated, insulated
CPI 86	chrome plated, polished head, insulated
CPD 87	chrome plated, polished head, plastic coated handles
CPV 88	chrome plated, polished head, VDE insulated handles

ABRÉVIATIONS ET INDICATIONS

ST 00	standard
G 05	sablé
A 10	noir
AS 11	noir, partiellement meulé
ASD 13	noir, partiellement poli, branches gainées plastique
L 20	laqué
LS 21	laqué, partiellement meulé
LD 24	laqué, branches gainées plastique
LG 25	laqué, partiellement sablé
B 30	bruni
BI 32	bruni, branches gainées plastique
BV 33	bruni, isolé VDE 1000 volts
PH 36	phosphaté
PHS 37	phosphaté, partiellement meulé
P 40	poli
MS 45	laiton
N 50	nickelé
ND 54	nickelé, branches gainées plastique
NI 55	nickelé, branches gainées plastique
Z 60	galvanisé, bleu passivé
ZCG 61	galvanisé, jaune passivé
K 68	couche spéciale anticorrosive
CL 70	couleur chrome
C 80	chromé
CP 82	chromé, partiellement poli
CPP 83	chromé, entièrement poli
CI 85	chromé, gainé plastique
CPI 86	chromé, tête polie, branches gainées plastique
CPD 87	chromé, tête polie, branches gainées plastique
CPV 88	chromé, tête polie, branches isolées VDE 1000 volts

ABREVIATURAS E INFORMACIÓN

ST 00	estándar
G 05	granallado
A 10	negro
AS 11	negro, parcialmente pulido
ASD 13	negro, parcialmente pulido, mangos plastificados
L 20	barnizado
LS 21	barnizado, parcialmente pulido
LD 24	barnizado, mangos plastificados
LG 25	barnizado, parcialmente granallado
B 30	pavonado
BI 32	pavonado, con fundas de plástico
BV 33	pavonado, aislado VDE 1000 V
PH 36	fosfatado
PHS 37	fosfatado, parcialmente amolado
P 40	pulido
MS 45	latonado
N 50	niquelado
ND 54	niquelado, mangos plastificados
NI 55	niquelado, con fundas de plástico
Z 60	cincado, cromatizado azul
ZCG 61	cincado, cromatizado amarillo
K 68	recubrimiento especial anticorrosivo
CL 70	cromatizado
C 80	cromado
CP 82	cromado, parcialmente pulido espejo
CPP 83	cromado, enteramente pulido espejo
CI 85	cromado, plastificado
CPI 86	cromado, cabeza pulida, con fundas de plástico
CPD 87	cromado, cabeza pulida, mangos plastificados
CPV 88	cromado, cabeza pulida, aislado VDE 1000 V

00000000000

Artikel läuft aus,
Lagervorrat vorhanden

POZIDRIV®
eingetragenes Warenzeichen der Firma
European Industrial Services Ltd.

TORX®
eingetragenes Warenzeichen der Firma
CAMCAR/TEXTRON INC.

Alle Katalogartikel werden technisch
ständig optimiert; daher sind Änderungen
jederzeit und ohne Ankündigung
möglich.

Der Nachdruck dieses Kataloges oder
von Teilen daraus, die Vervielfältigung,
Speicherung und Übermittlung jed-
weder Art, auch durch Datenverar-
beitungsanlagen, sind nur mit unserer
schriftlichen Genehmigung gestattet.

00000000000

Production discontinued,
small stocklots

POZIDRIV®
Registered trade mark
of European Industrial Services Ltd.

TORX®
Registered trade mark
of CAMCAR/TEXTRON INC.

All catalogue articles are continuously
updated to the latest technical standards.
As a result, specifications are subject to
change without prior notice.

Reprint of this catalogue or parts thereof,
reproduction, storage in retrieval systems,
unauthorized utilization and transmission
in any form or by any means including
computer systems is only permitted with
our prior consent in writing.

00000000000

Fabrication suspendue petites
quantités encore en stock

POZIDRIV®
marque déposée par la société
European Industrial Services Ltd.

TORX®
marque déposée par la société
CAMCAR/TEXTRON INC.

Les produits du catalogue étant soumis
à des améliorations techniques
permanentes, le fabricant se réserve le
droit de modifier leurs caractéristiques
à tout moment et sans préavis.

Toute reproduction, copie ou diffusion,
totale ou partielle de ce catalogue, par
quelque procédé que ce soit,
notamment par photocopie ou par
équipement informatique, est interdite
sans notre autorisation écrite.

00000000000

Artículo fuera de programa,
disponible salvo venta

POZIDRIV®
marca registrada de
European Industrial Services Ltd.





TORX®
marca registrada de
CAMCAR/TEXTRON INC.

Todos los artículos del catálogo están
sometidos a perfeccionamiento
continuo. Por eso, están sujetos a
posibles modificaciones sin previo aviso.

La reproducción de este catálogo
íntegra o parcial, cualquier tipo de
memorización y transmisión, incluso
mediante sistemas informáticos
requerirán sin falta nuestra autorización
por escrito.





























SYMBOLE

	Gewicht in Gramm
	Packeinheit
	Länge
	Durchmesser
	auf Seite
	metrische Schlüsselweiten für Schrauben und Muttern mit Außensechskant
	amerikanische Zoll-Schlüsselweiten für Schrauben und Muttern mit Außensechskant
	britische Zoll-Schlüsselweiten für Schrauben und Muttern mit Außensechskant, Maßangaben nach Bolzenstärken
	metrische Schlüsselweiten für Innensechskantschrauben
	amerikanische Zoll-Schlüsselweiten für Innensechskantschrauben
	Schlüsselweite bei TORX®-Schrauben
	Innensechskant
	Innensechskant Schon-Profil
	Innen-Doppelsechskant
	Innen-Doppelsechskant Schon-Profil
	Innenvierkant
	Außenvierkant
	Außensechskant für Innensechskantschrauben
	für Schlitzschrauben
	für Kreuzschlitzschrauben PHILLIPS-RECESS
	für Kreuzschlitzschrauben POZIDRIV®
	KREUZmix für Kreuzschlitzschrauben PHILLIPS-RECESS + POZIDRIV®
	für Innenvielzahn-Schrauben XZN
	für Innenkeilprofil-Schrauben RIBE CV
	für Innen-TORX®-Schrauben
	für Außen-TORX®-Schrauben

SYMBOLS

	weight in grammes
	packing unit
	length
	diameter
	on page
	spanner openings in metric for hexagon head screws, bolts and nuts
	spanner openings in inches (american sizes) for hexagon head screws, bolts and nuts
	spanner openings in inches (british sizes) for hexagon head screws, bolts and nuts sizes stated for diameter of bolt
	sizes in metric for hexagon socket screws and bolts
	sizes in inches (American sizes) for hexagon socket screws and bolts
	size in millimetres for TORX®-screws
	inside hexagon
	inside hexagon Schon-Profil (profile saver)
	inside bihexagon
	inside bihexagon – Schon-Profil (profile saver)
	inside square
	outside square
	outside hexagon
	for plain slot screws
	for cross slot screws PHILLIPS-RECESS
	for cross slot screws POZIDRIV®
	CROSS-MIX for cross slot screws PHILLIPS-RECESS + POZIDRIV®
	for multi-spline socket screws XZN
	for fluted socket screws RIBE CV
	for TORX®-socket screws
	for TORX®-head screws

SYMBOLES

	poids en grammes
	unité d'emballage
	longueur
	diamètre
	page
	ouvertures métriques pour vis et écrous hexagonaux
	ouvertures en pouces (dimensions américaines) pour vis et écrous hexagonaux
	ouvertures en pouces (dimensions britanniques) pour vis et écrous hexagonaux, dimensions indiquées pour le diamètre du boulon
	ouvertures métriques pour vis à pans creux
	ouvertures en pouces (dimensions américaines) pour vis à pans creux
	ouvertures métriques pour vis TORX®
	6 pans intérieur
	6 pans intérieur – profil d'usure
	12 pans intérieur
	12 pans intérieur – profil d'usure
	carré femelle
	carré mâle
	6 pans mâle
	pour vis à fente
	pour vis cruciformes PHILLIPS-RECESS
	pour vis cruciformes POZIDRIV®
	Cruciforme Mixte pour vis cruciformes PHILLIPS-RECESS + POZIDRIV®
	pour vis denture multiple XZN
	pour vis à empreinte à créneaux RIBE CV
	pour vis TORX® intérieures
	pour vis TORX® extérieures

SÍMBOLOS

	peso en gramos
	unidad de envase
	longitud
	diámetro
	en página
	medidas métricas para tornillos y tuercas con hexágono exterior
	medidas en pulgadas AF para tornillos y tuercas con hexágono exterior
	medidas en pulgadas Whitworth para tornillos y tuercas con hexágono exterior, medidas referentes al grosor del bulón
	medidas métricas para tornillos con hexágono interior
	medidas en pulgadas AF para tornillos con hexágono interior
	medidas para tornillos TORX®
	hexágono interior
	hexágono interior perfil conservador
	estrella interior
	estrella interior perfil conservador
	cuadrado interior
	cuadrado exterior
	hexágono exterior
	para tornillos ranurados
	para tornillos PHILLIPS-RECESS
	para tornillos POZIDRIV®
	CRUZmix para tornillos con ranurado en cruz PHILLIPS-RECESS + POZIDRIV®
	para tornillos XZN
	para tornillos RIBE CV
	para tornillos TORX® interiores
	para tornillos TORX® exteriores





	10 – 12
	12 – 13
	13 – 14
	15
	15 – 16
	16
	17 – 22
	22 – 23
	23
	23 – 24
	24 – 26
	27
	27
	28
	28
	29
	29 – 30
	31 – 32
	33

Doppelmaulschlüssel

DIN 3110 / ISO 1085

Chrom-Vanadium

CP = verchromt, Köpfe poliert

Double ended open jaw
wrenches

DIN 3110 / ISO 1085

Chrome-Vanadium, CP = chromium

plated, polished heads

Clés à fourche

DIN 3110 / ISO 1085

Chrome-Vanadium

CP = chromées, têtes polies

Llaves fijas de dos bocas
abiertas

DIN 3110 / ISO 1085

Cromo Vanadio

CP = cromado, cabezas pulidas espejo



Code	⊕MM	←L→ mm	H mm	D ₁ mm	D ₂ mm	g	g	EAN	€
00350040582	4 x 5	103	3,3	11,6	13,7	10	10	008265	6,15
00350055582	5 x 5,5	104	3,3	13,7	14,7	10	10	008289	6,15
00350055782	5,5 x 7	122	3,6	15,7	17,7	20	10	008302	4,90
00350060782	6 x 7	122	3,6	15,7	17,7	20	10	008333	4,05
00350080982	8 x 9	140	3,9	20,8	22,9	32	10	008388	4,20
00350081082	8 x 10	140	3,9	20,8	22,9	31	10	008418	5,05
00350101182	10 x 11	156	4,8	23,9	26,9	54	10	008456	4,80
00350101282	10 x 12	156	4,8	23,9	26,9	53	10	008487	5,40
00350101382	10 x 13	172	5,3	24,0	30,0	67	10	008517	6,40
00350111382	11 x 13	172	5,3	28,0	31,0	65	10	008548	6,40
00350121382	12 x 13	172	5,3	28,0	31,0	61	10	008562	5,70
00350121482	12 x 14	172	5,3	28,0	31,0	59	10	008593	6,30
00350131482	13 x 14	190	5,7	32,5	34,9	92	10	008616	6,30
00350131582	13 x 15	190	5,7	32,5	34,9	91	10	008647	6,95
00350131682	13 x 16	190	5,7	32,5	34,9	90	10	008661	7,20
00350131782	13 x 17	204	5,9	32,1	38,2	110	10	008692	7,05
00350141582	14 x 15	190	5,7	32,5	34,9	90	10	008722	6,10
00350141782	14 x 17	204	5,9	32,1	38,2	105	10	008753	7,05
00350161782	16 x 17	204	5,9	36,1	39,2	105	10	008777	6,60
00350161882	16 x 18	204	5,9	36,1	39,2	105	10	008791	8,00
00350171982	17 x 19	223	6,5	40,2	42,3	155	10	008821	8,10
00350181982	18 x 19	223	6,5	40,2	42,3	150	10	008845	7,85
00350182182	18 x 21	236	6,8	40,2	46,4	180	10	008869	10,10
00350192282	19 x 22	236	6,8	44,9	48,4	190	10	008890	9,35
00350192482	19 x 24	250	7,3	42,3	52,5	230	10	008913	10,70
00350202282	20 x 22	236	6,8	44,9	48,4	185	10	008937	9,05
00350212382	21 x 23	250	7,3	47,4	51,5	265	5	008951	10,10
00350212482	21 x 24	250	7,3	47,4	51,5	260	5	008975	11,55
00350222482	22 x 24	250	7,3	47,4	51,5	260	5	009002	10,60
00350242682	24 x 26	265	7,8	52,5	58,6	320	5	009026	12,15
00350242782	24 x 27	265	7,8	52,5	58,6	310	5	009057	12,15
00350252882	25 x 28	280	8,1	55,2	61,3	350	5	009095	13,90
00350272982	27 x 29	280	8,1	58,6	64,4	360	5	009118	17,75
00350273082	27 x 30	280	8,1	58,6	64,4	355	5	009132	17,10
00350273282	27 x 32	302	8,6	59,7	69,9	455	5	009156	17,10
00350303282	30 x 32	302	8,6	64,8	70,3	480	5	009187	17,10
00350303482	30 x 34	302	8,6	64,8	72,9	510	5	009200	19,45
00350303682	30 x 36	325	8,8	63,0	74,5	540	5	009224	30,60
00350323682	32 x 36	325	8,8	66,5	74,5	550	5	009231	30,60
00350364182	36 x 41	358	8,8	74,5	84,0	730	5	009248	40,65
00350414682	41 x 46	400	9,8	84,0	93,5	1000	5	009255	54,20
00350465082	46 x 50	450	10,8	93,5	105,0	1470	3	009262	75,50

Code	⊕AF	←L→ mm	H mm	D ₁ mm	D ₂ mm	g	g	EAN	€
00350660682	1/4 x 5/16	130	3,9	17,7	20,8	28	10	009279	5,15
00350660982	5/16 x 3/8	140	3,9	20,8	22,9	32	10	009286	5,35
00350661382	3/8 x 7/16	156	4,8	23,9	26,9	55	10	009293	5,80
00350661782	7/16 x 1/2	172	5,3	28,0	31,0	67	10	009316	6,75
00350661982	1/2 x 9/16	190	5,7	32,5	34,9	92	10	009323	7,15
00350662282	9/16 x 5/8	190	5,7	32,5	34,9	91	10	009347	7,45
00350662582	19/32 x 11/16	204	5,9	36,1	39,2	110	10	009354	8,20
00350662782	5/8 x 11/16	204	5,9	36,1	39,2	105	10	009361	8,20
00350662882	5/8 x 3/4	223	6,5	40,2	42,3	155	10	009378	8,95
00350663082	11/16 x 3/4	223	6,5	40,2	42,3	150	10	009385	8,95
00350663582	3/4 x 25/32	236	6,8	44,9	48,4	190	10	009392	9,70
00350663782	3/4 x 7/8	236	6,8	44,9	48,4	185	10	009408	10,35
00350664182	13/16 x 7/8	236	6,8	44,9	48,4	180	10	009415	10,35
00350664382	7/8 x 15/16	250	7,3	47,4	51,5	260	5	009422	11,65
00350664682	15/16 x 1	265	7,8	52,5	58,6	310	5	009439	13,55
00350665082	1 x 1.1/8	280	8,1	55,7	61,3	345	5	009453	15,20
00350665382	1.1/16 x 1.1/4	302	8,6	59,7	69,9	460	5	009460	18,85
00350665582	1.1/8 x 1.5/16	302	8,6	64,8	70,3	480	5	009477	18,85
00350665882	1.3/16 x 1.5/16	302	8,6	64,8	70,3	470	5	009484	19,60
00350666082	1.1/4 x 1.3/8	325	8,8	66,5	74,5	555	5	009507	39,25
00350666482	1.5/16 x 1.1/2	325	8,8	66,5	74,5	540	5	009514	39,25
00350666882	1.7/16 x 1.5/8	358	8,8	74,5	84,0	725	5	009521	50,30
00350666982	1.1/2 x 1.5/8	358	8,8	74,5	84,0	710	5	009538	50,30
00350667482	1.11/16 x 1.7/8	400	9,8	84,0	93,5	990	5	009545	63,75
00350667782	1.13/16 x 2	450	10,8	93,5	105,0	1465	3	009552	81,20

B 350

Doppelmaulschlüssel-Satz

Double ended open jaw wrench set

Jeux de clés à fourche

Juegos de llaves fijas de dos bocas abiertas

in attraktiver Kartonverpackung

in attractive cardboard-carton

en emballage carton à fenêtre

en atractivo estuche de cartón

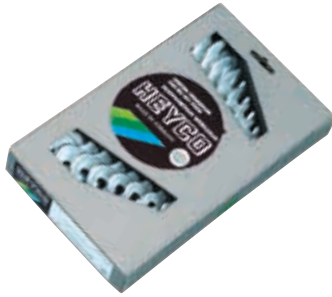

Code	No.	MM	=1				g	EAN	€
00350844082	B 350-8-M	6 x 7	8 x 9	10 x 11	12 x 13	700	094350	48,15	
		14 x 15	16 x 17	18 x 19	20 x 22				

HP 350

Doppelmaulschlüssel-Satz

Double ended open jaw wrench set

Jeux de clés à fourche

Juegos de llaves fijas de dos bocas abiertas

im Kunststoffhalter

in plastic holder

sur présentoir-support en plastique

en clip de plástico



Code	No.	MM	=1				g	EAN	€
00350644082	HP 350-8-M	6 x 7	8 x 9	10 x 11	12 x 13	812	340006	50,35	
		14 x 15	16 x 17	18 x 19	20 x 22				

K 350

Doppelmaulschlüssel-Sätze

Double ended open jaw wrench sets

Jeux de clés à fourche

Juegos de llaves fijas de dos bocas abiertas



Code	No.	MM	=1				g	EAN	€
00350942082	K 350-6-M-1	6 x 7	8 x 9	10 x 11	12 x 13	365	009675	31,20	
		14 x 15	16 x 17						
00350942182	K 350-6-M-2	8 x 9	10 x 11	12 x 13	14 x 15	495	009682	35,15	
		16 x 17	18 x 19						
00350942282	K 350-6-M-3	10 x 11	12 x 13	14 x 15	16 x 17	645	009699	40,05	
		18 x 19	20 x 22						
00350943482	K 350-7-M	6 x 7	8 x 9	10 x 11	12 x 13	600	009712	41,80	
		14 x 15	17 x 19	20 x 22					
00350943582	K 350-7-M-1	5,5 x 7	8 x 10	11 x 13	16 x 18	1345	129199	72,25	
		14 x 15	17 x 19	20 x 22					
00350944082	K 350-8-M	6 x 7	8 x 9	10 x 11	12 x 13	700	009729	48,15	
		14 x 15	16 x 17	18 x 19	20 x 22				
00350945582	K 350-10-M	6 x 7	8 x 9	10 x 11	12 x 13	1270	009736	70,45	
		14 x 15	16 x 17	18 x 19	20 x 22				
		21 x 23	24 x 27						
00350945682	K 350-10-M-1	6 x 7	8 x 9	10 x 11	12 x 13	1280	163377	70,45	
		14 x 15	16 x 17	18 x 19	20 x 22				
		21 x 23	24 x 26						
00350947082	K 350-12-M	6 x 7	8 x 9	10 x 11	12 x 13	2100	009743	101,40	
		14 x 15	16 x 17	18 x 19	20 x 22				
		21 x 23	24 x 27	25 x 28	30 x 32				
00350947282	K 350-12-M-2	6 x 7	8 x 9	10 x 11	12 x 13	1995	366846	101,55	
		14 x 15	16 x 17	18 x 19	20 x 22				
		21 x 23	24 x 26	25 x 28	27 x 32				
00350948082	K 350-13-M	6 x 7	8 x 9	10 x 11	12 x 13	2475	009750	119,15	
		14 x 15	16 x 17	18 x 19	20 x 22				
		21 x 23	24 x 26	25 x 28	27 x 32				
		30 x 32							
00350948582	K 350-14-M	6 x 7	8 x 9	10 x 11	12 x 13	4300	009767	217,60	
		14 x 15	16 x 17	18 x 19	20 x 22				
		21 x 23	24 x 27	25 x 28	30 x 32				
		36 x 41	46 x 50						
00350948682	K 350-14-M-1	6 x 7	8 x 9	10 x 11	12 x 13	4310	310559	217,60	
		14 x 15	16 x 17	18 x 19	20 x 22				
		21 x 23	24 x 26	25 x 28	30 x 32				
		36 x 41	46 x 50						

K 350

Doppelmaulschlüssel-Sätze

Double ended open jaw wrench sets

Jeux de clés à fourche

Juegos de llaves fijas de dos bocas abiertas



Code	No.	AF	=1	g	EAN	€
00350962082	K 350-6-AF-1	1/4 x 5/16 1/2 x 9/16 3/4 x 25/32	3/8 x 7/16 5/8 x 11/16 13/16 x 7/8	650	009774	46,30
00350962182	K 350-6-AF-2	3/8 x 7/16 5/8 x 11/16 13/16 x 7/8	1/2 x 9/16 3/4 x 25/32 15/16 x 1	935	009781	54,75
00350964082	K 350-8-AF	1/4 x 5/16 1/2 x 9/16 3/4 x 25/32 15/16 x 1	3/8 x 7/16 5/8 x 11/16 13/16 x 7/8 1.1/16 x 1.1/4	1420	009798	78,85
00350967082	K 350-12-AF	1/4 x 5/16 1/2 x 9/16 5/8 x 11/16 3/4 x 25/32 7/8 x 15/16 1 x 1.1/8	3/8 x 7/16 19/32 x 11/16 5/8 x 3/4 13/16 x 7/8 15/16 x 1 1.1/16 x 1.1/4	2290	009804	122,75

R 350

Doppelmaulschlüssel-Sätze

Double ended open jaw wrench sets

Jeux de clés à fourche

Juegos de llaves fijas de dos bocas abiertas

in Kunststoff-Rolltaschen mit Riemen

in plastic wallets, with strap

en trousse plastique, avec lanière

en bolsas de plástico, con correa



Code	No.	MM	=1	g	EAN	€
00350744082	R 350-8-M	6 x 7 8 x 9 10 x 11 12 x 13 14 x 15 16 x 17 18 x 19 20 x 22		820	009644	62,90
00350747082	R 350-12-M	6 x 7 8 x 9 10 x 11 12 x 13 14 x 15 16 x 17 18 x 19 20 x 22 21 x 23 24 x 27 25 x 28 30 x 32		2355	009651	123,60
00350747182	R 350-12-M-1	6 x 7 8 x 9 10 x 11 12 x 13 14 x 15 16 x 17 18 x 19 20 x 22 21 x 23 24 x 26 25 x 28 30 x 32		2365	163735	123,60

Code	No.	AF	=1	g	EAN	€
00350767082	R 350-12-AF	1/4 x 5/16 1/2 x 9/16 5/8 x 11/16 3/4 x 25/32 7/8 x 15/16 1 x 1.1/8	3/8 x 7/16 19/32 x 11/16 5/8 x 3/4 13/16 x 7/8 15/16 x 1 1.1/16 x 1.1/4	2545	009668	145,05

894

Einmaulschlüssel

Single ended open jaw wrenches

Clés à fourche simples

Llaves fijas de una boca abierta

DIN 894 / ISO 3318
PH = phosphatiert (5,5 - 75 mm)
L = lackiert (80 - 135 mm)

DIN 894 / ISO 3318
PH = phosphated (5,5 - 75 mm)
L = lacquered (80 - 135 mm)

DIN 894 / ISO 3318
PH = phosphatées (5,5 - 75 mm)
L = laquées (80 - 135 mm)

DIN 894 / ISO 3318
PH = fosfatado (5,5 - 75 mm)
L = barnizado (80 - 135 mm)

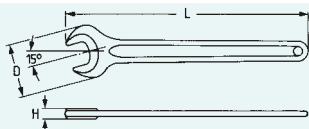

Code	PH	MM	←L→ mm	H mm	D mm	g		EAN	€
00894006036	6		73	3,0	15,0	8	10	019537	3,45
00894007036	7		77	3,2	17,0	10	10	019544	3,45
00894008036	8		94	3,4	19,0	13	10	019551	2,60
00894009036	9		99	3,9	20,5	16	10	019568	3,45
00894010036	10		105	4,4	22,0	20	10	019575	2,60
00894011036	11		111	4,9	24,5	23	10	019582	2,85
00894012036	12		124	4,9	26,0	26	10	019599	3,00
00894013036	13		125	5,1	28,5	35	10	019605	3,00
00894014036	14		140	5,4	30,0	47	10	019612	3,10
00894015036	15		141	5,4	32,5	47	10	019629	3,85
00894017036	17		155	5,9	35,5	65	10	019636	3,00

894

Einmaulschlüssel

DIN 894 / ISO 3318
PH = phosphatiert (5,5 – 75 mm)
L = lackiert (80 – 135 mm)

Single ended open jaw
wrenches

DIN 894 / ISO 3318
PH = phosphated (5,5 – 75 mm)
L = lacquered (80 – 135 mm)

Clés à fourche simples

DIN 894 / ISO 3318
PH = phosphatées (5,5 – 75 mm)
L = laquées (80 – 135 mm)

Llaves fijas de una boca
abierta

DIN 894 / ISO 3318
PH = fosfatado (5,5 – 75 mm)
L = barnizado (80 – 135 mm)

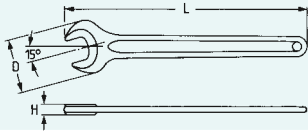

Code	PH	MM	←L→ mm	H mm	D mm	g		EAN	€
00894018036		18	155	6,4	38,5	70	10	019643	3,90
00894019036		19	170	6,9	40,0	83	10	019650	3,85
00894022036		22	193	7,9	46,0	105	10	019667	4,50
00894024036		24	215	8,9	50,0	150	10	019674	6,00
00894027036		27	238	9,8	56,0	200	5	019681	6,85
00894030036		30	261	10,8	62,0	265	5	019698	8,25
00894032036		32	273	11,8	66,5	295	5	019704	9,05
00894036036		36	300	12,8	74,0	425	5	019711	12,55
00894038036		38	301	13,3	78,0	440	5	019728	15,35
00894041036		41	335	13,8	83,5	560	5	019735	15,55
00894046036		46	369	14,8	93,0	710	5	019742	18,80
00894050036		50	401	15,8	101,0	950	5	019759	26,10
00894055036		55	445	16,8	111,5	1200	3	019766	29,15
00894060036		60	480	17,8	122,0	1450	1	019773	37,15
00894065036		65	518	18,7	131,5	1875	1	019780	45,15
00894070036		70	557	19,7	141,5	2275	1	019797	59,50
00894075036		75	595	20,7	152,0	2700	1	019803	84,55

Code	L	MM	←L→ mm	H mm	D mm	g		EAN	€
00894080020	80		645	22,0	162,2	3000	1	019810	114,60
00894085020	85		690	23,0	173,0	3400	1	019827	147,35
00894090020	90		690	23,0	173,0	3200	1	019834	164,40
00894095020	95		847	25,0	195,0	5800	1	019841	246,10
00894100020	100		847	25,0	195,0	5500	1	019858	252,15
00894105020	105		1000	28,0	217,0	7450	1	019865	336,65
00894110020	110		1000	28,0	217,0	7400	1	019872	364,25
00894115020	115		1000	28,0	225,0	7300	1	019889	410,55
00894120020	120		1000	28,0	225,0	7250	1	019896	459,25
00894125020	125		1000	28,0	225,0	7200	1	019902	550,90
00894130020	130		1000	28,0	225,0	7150	1	019919	577,55
00894135020	135		1000	28,0	225,0	7100	1	019926	634,35

895

Doppelmaulschlüssel

DIN 895 / ISO 3318
PH = phosphatiert
(6 x 7 – 55 x 60 mm)
L = lackiert
(65 x 70 – 75 x 80 mm)

Double ended open jaw
wrenches

DIN 895 / ISO 3318
PH = phosphated
(6 x 7 – 55 x 60 mm)
L = lacquered
(65 x 70 – 75 x 80 mm)

Clés à fourche

DIN 895 / ISO 3318
PH = phosphatées
(6 x 7 – 55 x 60 mm)
L = laquées
(65 x 70 – 75 x 80 mm)

Llaves fijas de dos bocas
abiertas

DIN 895 / ISO 3318
PH = fosfatado
(6 x 7 – 55 x 60 mm)
L = barnizado
(65 x 70 – 75 x 80 mm)

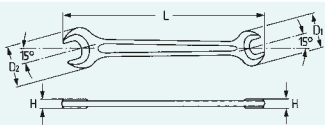

Code	PH	MM	←L→ mm	H mm	D ₁ mm	D ₂ mm	g		EAN	€
00895060736		6 x 7	95	3,2	14,5	17,0	15	10	019933	2,65
00895080936		8 x 9	110	4,0	19,0	20,5	20	10	019957	2,60
00895081036		8 x 10	115	4,4	19,0	22,5	25	10	019964	2,60
00895091036		9 x 10	120	4,4	20,5	22,5	25	10	019971	2,80
00895091136		9 x 11	120	4,9	20,5	24,0	28	10	019988	3,10
00895101136		10 x 11	120	4,9	22,5	24,0	28	10	019995	2,75
00895101236		10 x 12	125	4,9	22,5	26,0	32	10	020007	3,75
00895101336		10 x 13	115	5,1	22,5	28,5	35	10	020014	3,10
00895101436		10 x 14	140	5,4	22,5	30,0	40	10	020045	4,50
00895111336		11 x 13	135	5,4	24,0	28,5	43	10	020052	3,10
00895121336		12 x 13	140	5,4	26,0	28,5	45	10	020069	3,10
00895121436		12 x 14	140	5,4	26,0	30,0	45	10	020076	3,10

895

Doppelmaulschlüssel

DIN 895 / ISO 3318
PH = phosphatiert
(6 x 7 – 55 x 60 mm)
L = lackiert
(65 x 70 – 75 x 80 mm)

Double ended open jaw wrenches

DIN 895 / ISO 3318
PH = phosphated
(6 x 7 – 55 x 60 mm)
L = lacquered
(65 x 70 – 75 x 80 mm)

Clés à fourche

DIN 895 / ISO 3318
PH = phosphatées
(6 x 7 – 55 x 60 mm)
L = laquées
(65 x 70 – 75 x 80 mm)

Llaves fijas de dos bocas abiertas

DIN 895 / ISO 3318
PH = fosfatado
(6 x 7 – 55 x 60 mm)
L = barnizado
(65 x 70 – 75 x 80 mm)

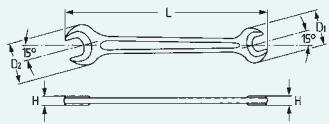

Code	PH	MM	←L→ mm	H mm	D ₁ mm	D ₂ mm	g	g	EAN	€
00895131436		13 x 14	140	5,4	28,5	30,0	48	10	020083	4,00
00895131536		13 x 15	140	5,4	28,5	32,0	50	10	020090	3,55
00895131736		13 x 17	155	5,9	28,5	36,0	70	10	020106	3,60
00895141536		14 x 15	140	5,4	30,0	32,0	50	10	020113	4,00
00895141736		14 x 17	155	5,9	30,0	36,0	68	10	020120	3,65
00895161736		16 x 17	155	5,9	34,0	36,0	73	10	020137	4,30
00895161836		16 x 18	165	5,9	34,0	38,5	80	10	020144	4,50
00895171936		17 x 19	170	6,9	36,0	40,0	90	10	020151	4,00
00895172136		17 x 21	190	7,9	36,0	43,5	105	10	020168	5,70
00895172236		17 x 22	190	7,9	36,0	46,0	125	10	020175	5,40
00895192236		19 x 22	195	7,9	40,0	46,0	140	10	020182	5,30
00895192436		19 x 24	205	8,8	40,0	50,0	165	10	020199	6,05
00895212336		21 x 23	215	8,4	43,5	48,0	170	5	020205	7,10
00895222436		22 x 24	220	8,7	46,0	50,0	180	5	020212	7,10
00895222736		22 x 27	230	9,8	46,0	56,0	225	5	020229	8,25
00895242736		24 x 27	240	9,8	50,0	56,0	245	5	020236	8,25
00895242936		24 x 29	265	10,8	50,0	59,0	280	5	020243	11,35
00895243036		24 x 30	265	10,8	50,0	62,0	280	5	020250	8,80
00895273236		27 x 32	270	11,8	56,0	65,5	340	5	020267	11,35
00895303236		30 x 32	275	11,8	62,0	65,5	400	5	020274	11,35
00895303636		30 x 36	305	12,8	62,0	73,5	480	5	020281	15,00
00895323636		32 x 36	305	12,8	65,5	73,5	480	5	020298	15,00
00895364136		36 x 41	340	13,8	73,5	84,0	710	5	020304	21,60
00895414636		41 x 46	380	14,8	84,0	93,5	935	5	020311	25,95
00895465036		46 x 50	420	15,8	93,5	101,5	1210	3	020328	34,15
00895505536		50 x 55	460	16,8	101,5	111,0	1500	1	020335	43,30
00895556036		55 x 60	500	17,8	111,0	122,5	1860	1	020342	51,50

Code	L	MM	←L→ mm	H mm	D ₁ mm	D ₂ mm	g	g	EAN	€
00895657020		65 x 70	580	20,0	132,0	142,0	2600	1	020359	119,15
00895758020		75 x 80	662	22,0	152,0	162,0	4100	1	020397	182,20

K 895

Doppelmaulschlüssel-Sätze

Double ended open jaw wrench sets

Jeux de clés à fourche

Juegos de llaves fijas de dos bocas abiertas

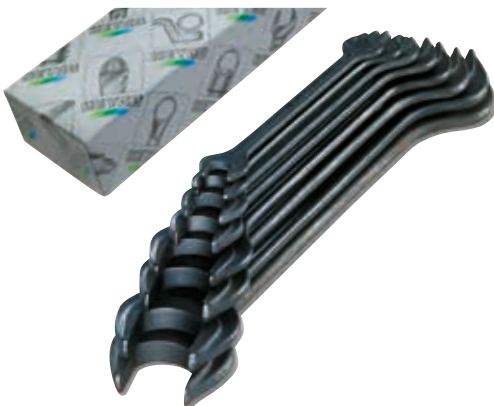

Code	No.	MM	g	EAN	€
00895942036	K 895-6-M-1	6 x 7 8 x 9 10 x 11 12 x 13 14 x 15 16 x 17	230	020403	18,60
00895942136	K 895-6-M-2	8 x 9 10 x 11 12 x 13 14 x 15 16 x 18 17 x 19	315	020410	19,65
00895942236	K 895-6-M-3	10 x 11 12 x 13 14 x 15 16 x 18 17 x 19 19 x 22	435	020427	22,35
00895944036	K 895-8-M	6 x 7 8 x 9 10 x 11 12 x 13 14 x 15 16 x 18 17 x 19 19 x 22	470	020434	28,00
00895947036	K 895-12-M	6 x 7 8 x 9 10 x 11 12 x 13 14 x 15 16 x 18 17 x 19 19 x 22 21 x 23 22 x 27 24 x 29 30 x 32	1545	020441	62,80

370

Magnetschlüssel-Sätze

N = vernickelt, Stahlblech, gehärtet,
8 Maulschlüssel, 1 Schraubendreher,
1 Kontaktfeile, 1 Fühlerlehrenblatt
0,40 mm

Ignition wrench sets

N = nickel plated, sheet steel,
hardened, 8 single ended open
jaw wrenches, 1 screwdriver
blade, 1 contact file, 1 feeler
gauge blade 0,40 mm

Jeux de clés magnétos

N = nickelées, tôle d'acier, trempées,
8 clés à fourche simples, 1 tournevis,
1 lime à contacts, 1 jauge d'épaisseur 0,40 mm

Juegos de llaves para delco

N = niquelado, troqueladas de acero,
templadas, 8 llaves fijas de una boca,
1 hoja de destornillador, 1 lima para
contactos, 1 hoja de galga de espesores
de 0,40 mm



Code	No.	MM	=10				g	EAN	€
00370524050	370-M	4 6	4,5 6,5	5 7	5,5 7,5	50	009859	9,30	

Code	No.	AF	=10				g	EAN	€
00370534050	370-AF	3/16 5/16	7/32 11/32	1/4 3/8	9/32 7/16	60	009866	9,75	

380

Klauen Schlüssel

Chrom-Vanadium
C = verchromt
Betätigung mit Drehstift
HEYCO 900

Crowfoot wrenches

Chrome-Vanadium
C = chromium plated
to be used with tommy bar
HEYCO 900

Clés à griffe

Chrome-Vanadium
C = chromées
à utiliser avec broche
HEYCO 900

Llaves de boca fija abierta, tipo garra

Cromo Vanadio
C = cromado
a usar con pasador
HEYCO 900

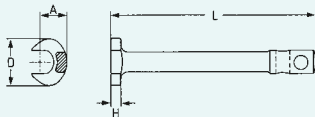

Code	MM	←L→ mm	D mm	H mm	A mm	für/for	g	EAN	€	
00380001380	13	160	28	5,5	16,5	900-8	100	5	009880	25,80
00380001480	14	160	28	5,5	17,5	900-8	100	5	009897	25,80
00380001780	17	200	33	6	20,0	900-10	150	5	009903	28,55
00380001980	19	200	37	7	22,0	900-12	250	5	009910	32,65
00380002280	22	200	46	8	26,0	900-12	300	5	009927	36,70
00380002480	24	250	46	9	28,5	900-14	450	5	009934	46,90
00380002780	27	250	52	10	32,0	900-14	500	5	009941	48,95
00380003080	30	250	57	11	34,0	900-16	650	5	009958	56,10
00380003280	32	250	61	12	37,0	900-16	700	5	009965	60,20
00380003680	36	315	68	13	42,5	900-18	1150	3	009989	85,70
00380004180	41	315	76	14	48,0	900-18	1230	3	009996	96,90
00380004680	46	315	85	15	52,0	900-20	1500	1	010015	121,40
00380005080	50	315	92	15	56,0	900-20	1600	1	010039	151,80
00380005580	55	395	105	20	60,0	900-20	2636	1	010053	177,45
00380006080	60	395	105	20	64,0	900-20	2583	1	125009	221,90

390

Verstellbare Einmaulschlüssel

DIN 3117 A / 3117 B
Chrom-Vanadium
PHS = phosphatiert, Kopf geschliffen
schwedisches Modell, linksgängig
Maulstellung 15° / DIN 3117 A

Adjustable wrenches

DIN 3117 A / 3117 B
Chrome-Vanadium
PHS = phosphated, ground head
Swedish pattern, left hand
movement
15° head angle / DIN 3117A

Clés à molette

DIN 3117 A / 3117 B
Chrome-Vanadium
PHS = phosphatées, tête meulée
modèle suédois, mouvement à gauche
angle de la tête 15° / DIN 3117A

Llaves ajustables

DIN 3117 A / 3117 B
Cromo Vanadio
PHS = fosfatado, cabeza amolada
modelo sueco, giro a la izquierda
ángulo de boca 15° / DIN 3117 A

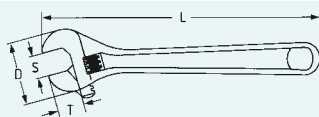

Code	PHS	←L→ mm	"	S mm	"	T mm	D mm	g	EAN	€	
00390000437		115	4	13	1/2	13,5	32,0	52	1	010084	22,85
00390000637		160	6	20	11/16	19,5	45,5	125	1	010107	24,95
00390000837		205	8	24	7/8	24,0	57,0	245	1	010121	29,20
00390001037		255	10	29	1.1/8	28,0	66,0	410	1	010152	36,05
00390001237		310	12	34	1.5/16	33,0	80,0	685	1	010176	53,40
00390001537		380	15	44	1.11/16	42,5	100,0	1275	1	010190	76,10
00390001837		460	18	53	2.1/16	51,0	120,5	2110	1	010213	133,60

390

Verstellbare Einmaulschlüssel

DIN 3117 A / 3117 B
 CP = verchromt, Kopf poliert
 amerikanisches Modell, rechtsgängig
 Maulstellung 22° / DIN 3117 B

Adjustable wrenches

DIN 3117 A / 3117 B
 Chrome-Vanadium
 CP = chromium plated, polished
 head, American pattern, right hand
 movement,
 22° head angle / DIN 3117 B

Clés à molette

DIN 3117 A / 3117 B
 Chrome-Vanadium
 CP = chromées, tête polie
 modèle américain, mouvement à droite
 angle de la tête 22° / DIN 3117 B

Llaves ajustables

DIN 3117 A / 3117 B
 Cromo Vanadio
 CP = cromado, cabeza pulida espejo
 modelo americano, giro a la derecha
 ángulo de boca 22° / DIN 3117 B

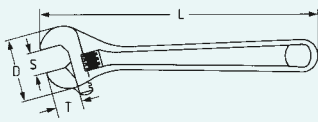

Code	CP	←L→		S		T	D	g	g	EAN	€
		mm	"	mm	"	mm	mm				
0039000482		115	4	13	1/2	13,5	32,0	52	1	010091	25,70
0039000682		160	6	20	11/16	19,5	45,5	125	1	010114	27,10
0039000882		205	8	24	7/8	24,0	57,0	245	1	010145	33,10
00390001082		255	10	29	1.1/8	28,0	66,0	410	1	010169	42,25
00390001282		310	12	34	1.5/16	33,0	80,0	685	1	010183	60,75
00390001582		380	15	44	1.11/16	42,5	100,0	1275	1	010206	90,30
00390001882		460	18	53	2.1/16	51,0	120,5	2110	1	010220	142,30

392

Verstellbare Einmaulschlüssel

- Übergroße Maulweite
- Hohe Belastbarkeit
- Kraftvolles Drehmoment
- Parallele Backenflächen sichern perfektes Greifen der Mutter
- Metrische Mess-Skala auf dem Maul

Adjustable wrenches

- Super wide opening
- High resistance
- High torque
- Parallel jaw surfaces ensure perfect grip of the nut
- Metric measuring scale on jaw

Clés à molette

- Ouverture extra-large
- Haute résistance
- Très haut couple
- Les surfaces parallèles des mâchoires assurent une
- Désignation de dimension métrique sur la mâchoire

Llaves ajustables

- Apertura extra-grande
- Gran resistencia
- Fuerte par de torsión
- Paralelidad de precisión de las bocas garantiza un perfecto agarre de la tuerca
- Escala métrica en la boca

Länge 150 mm (SW 34)
 50% weniger Gewicht
 62% größere Öffnung

Length 150 mm (SW 34)
 50% less in weight
 62% wider opening

Longueur 150 mm (SW 34)
 50% de poids en moins
 62% d'ouverture en plus

Largo 150 mm (SW 34)
 Peso reducido (-50%)
 Mayor apertura de boca (+62%)

SW 34 mm (1.3/8")
 nur 205 gr.

SW 34 mm (1.3/8")
 205 gr.

SW 34 mm (1.3/8")
 205 gr.

Apertura max. 34 mm (1.3/8")
 Peso solamente 205 grs.

Länge 200 mm (SW 39)
 68% weniger Gewicht
 78% größere Öffnung

Length 200 mm (SW 39)
 68% less in weight
 78% wider opening

Longueur 200 mm (SW 39)
 68% de poids en moins
 78% d'ouverture en plus

Largo 200 mm (SW 39)
 Peso reducido (-68%)
 Mayor apertura de boca (+78%)

SW 39 mm (1.1/2")
 nur 345 gr.

SW 39 mm (1.1/2")
 345 gr.

SW 39 mm (1.1/2")
 345 gr.

Apertura max. 39 mm (1.1/2")
 Peso solamente 345 grs.

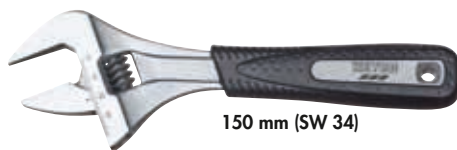

150 mm (SW 34)

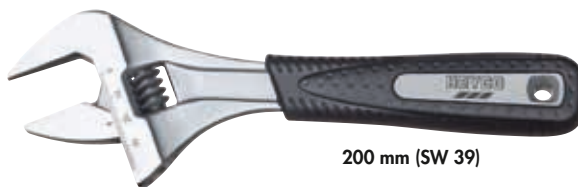

200 mm (SW 39)

Code	CP	←L→		S		T	D	g	g	EAN	€
		mm	"	mm	"	mm	mm				
00392340682		150	6	34	1.3/8	30	62	205	1	361964	42,15

Code	CP	←L→		S		T	D	g	g	EAN	€
		mm	"	mm	"	mm	mm				
00392390882		200	8	39	1.1/2	33	70	345	1	361971	47,55



Ringmaulschlüssel

Chrom-Vanadium

DIN 3113 A/ISO 3318 · ISO 7738
CP = verchromt, Kopf und Ring
poliert
5,5 – 50 mm · AF 1/4 – 2

DIN 3113 B/ISO 3318 · ISO 7738
C = verchromt
55 – 80 mm · AF 2.1/8 – 2.7/16

Combination wrenches

Chrome-Vanadium

DIN 3113 A/ISO 3318 · ISO 7738
CP = chromium plated, polished
head and ring
5,5 – 50 mm · AF 1/4 – 2

DIN 3113 B/ISO 3318 · ISO 7738
C = chromium plated
55 – 80 mm · AF 2.1/8 – 2.7/16

Clés mixtes

Chrome-Vanadium

DIN 3113 A/ISO 3318 · ISO 7738
CP = chromées, têtes polies
5,5 – 50 mm · AF 1/4 – 2

DIN 3113 B/ISO 3318 · ISO 7738
C = chromées
55 – 80 mm · AF 2.1/8 – 2.7/16

Llaves combinadas

Cromo Vanadio

DIN 3113 A/ISO 3318 · ISO 7738
CP = cromado, cabezas pulidas espejo
5,5 – 50 mm · AF 1/4 – 2

DIN 3113 B/ISO 3318 · ISO 7738
C = cromado
55 – 80 mm · AF 2.1/8 – 2.7/16



DIN 3113 A/ISO 3318 · ISO 7738
CP



DIN 3113 B/ISO 3318 · ISO 7738
C

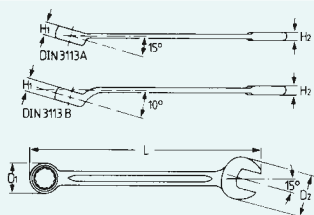

Code	CP	MM	L mm	H ₁ mm	H ₂ mm	D ₁ mm	D ₂ mm	g	g	EAN	€
0040005582		5,5	100	5,0	3,9	10,1	15,7	14	10	010282	6,95
0040006082		6	100	5,0	3,9	10,1	15,7	14	10	010299	6,20
0040007082		7	110	5,5	4,2	11,5	17,0	16	10	010312	6,25
0040008082		8	120	5,9	4,4	12,9	19,0	23	10	010336	6,40
0040009082		9	130	6,4	4,7	14,5	20,9	33	10	010350	6,75
0040010082		10	140	6,9	5,0	15,9	22,8	40	10	010381	6,75
0040011082		11	150	7,4	5,2	17,3	25,4	48	10	010404	7,35
0040012082		12	160	7,9	5,5	18,7	26,7	58	10	010435	7,95
0040013082		13	170	8,4	5,8	20,2	29,3	63	10	010466	7,95
0040014082		14	180	8,9	6,1	21,6	31,2	88	10	010497	8,40
0040015082		15	190	9,3	6,3	23,1	33,0	97	10	010527	9,00
0040016082		16	200	9,8	6,6	24,6	34,5	105	10	010558	9,55
0040017082		17	210	10,3	6,9	25,4	37,3	135	10	010589	9,25
0040018082		18	220	10,8	7,1	27,4	38,4	145	10	010602	11,15
0040019082		19	230	11,1	7,3	28,8	40,4	155	10	010633	10,90
0040020082		20	240	11,4	7,5	30,2	42,3	175	10	010657	13,30
0040021082		21	250	11,7	7,7	31,7	44,2	200	10	010664	13,40
0040022082		22	260	12,0	7,9	33,0	46,6	230	10	010695	15,20
0040023082		23	270	12,4	8,1	34,5	48,8	255	10	010701	15,80
0040024082		24	280	12,7	8,3	35,8	50,1	280	5	010718	17,05
0040025082		25	290	13,0	8,5	37,3	52,8	300	5	010725	17,20
0040026082		26	300	13,3	8,7	38,7	53,9	335	5	010732	17,65
0040027082		27	310	13,6	8,9	40,2	55,9	375	5	010749	19,70
0040028082		28	320	13,9	9,1	41,5	57,8	400	5	010756	22,80
0040029082		29	330	14,2	9,3	42,8	59,8	440	5	010763	23,00
0040030082		30	340	14,6	9,5	44,3	62,6	490	5	010770	23,50
0040032082		32	360	15,2	9,9	47,2	66,9	590	5	010787	25,75
0040034082		34	380	15,8	10,3	50,1	69,5	680	5	010794	34,15
0040036082		36	400	22,8	14,1	54,6	77,5	1090	5	010800	49,35
0040038082		38	400	22,8	14,1	54,6	77,5	1070	5	010817	63,90
0040041082		41	450	25,8	15,8	62,1	83,7	1450	3	010824	65,10
0040046082		46	500	28,8	17,5	69,6	93,1	1960	1	010831	101,45
0040050082		50	540	31,2	18,9	75,6	102,6	2600	1	010848	124,70

Code	C	MM	L mm	H ₁ mm	H ₂ mm	D ₁ mm	D ₂ mm	g	g	EAN	€
0040055080		55	610	28,2	18,0	84,5	113,0	2850	1	010855	251,10
0040060080		60	660	31,0	20,0	90,0	123,0	3600	1	010862	316,40
0040065080		65	710	33,0	22,0	98,0	133,0	4550	1	010879	375,70
0040070080		70	760	35,0	24,0	105,0	143,0	5800	1	010886	415,45
0040075080		75	810	38,0	26,0	110,0	153,0	6650	1	010893	507,40
0040080080		80	860	41,0	28,0	119,0	163,0	8500	1	010909	601,15

Code	CP	AF	L mm	H ₁ mm	H ₂ mm	D ₁ mm	D ₂ mm	g	g	EAN	€
00400631282		1/4	100	5,0	3,9	10,1	15,7	14	10	010916	6,45
00400631682		5/16	120	5,9	4,4	12,9	19,0	23	10	010923	6,45
00400631982		3/8	140	6,9	5,0	15,9	22,8	41	10	010947	7,65
00400632182		7/16	150	7,4	5,2	17,3	25,4	48	10	010961	7,65
00400632382		1/2	170	8,4	5,8	20,2	29,3	64	10	010985	8,40
00400632582		9/16	180	8,9	6,1	21,6	31,2	88	10	011005	9,35
00400632682		19/32	190	9,3	6,3	23,1	33,0	97	10	011012	11,55

400

Ringmaulschlüssel

Chrom-Vanadium

DIN 3113 A/ISO 3318 · ISO 7738
CP = verchromt, Kopf und Ring
poliert
5,5 – 50 mm · AF 1/4 – 2

DIN 3113 B/ISO 3318 · ISO 7738
C = verchromt
55 – 80 mm · AF 2.1/8 – 2.7/16

Combination wrenches

Chrome-Vanadium

DIN 3113 A/ISO 3318 · ISO 7738
CP = chromium plated, polished
head and ring
5,5 – 50 mm · AF 1/4 – 2

DIN 3113 B/ISO 3318 · ISO 7738
C = chromium plated
55 – 80 mm · AF 2.1/8 – 2.7/16

Clés mixtes

Chrome-Vanadium

DIN 3113 A/ISO 3318 · ISO 7738
CP = chromées, têtes polies
5,5 – 50 mm · AF 1/4 – 2

DIN 3113 B/ISO 3318 · ISO 7738
C = chromées
55 – 80 mm · AF 2.1/8 – 2.7/16

Llaves combinadas

Cromo Vanadio

DIN 3113 A/ISO 3318 · ISO 7738
CP = cromado, cabezas pulidas espejo
5,5 – 50 mm · AF 1/4 – 2

DIN 3113 B/ISO 3318 · ISO 7738
C = cromado
55 – 80 mm · AF 2.1/8 – 2.7/16



DIN 3113 A/ISO 3318 · ISO 7738
CP



DIN 3113 B/ISO 3318 · ISO 7738
C

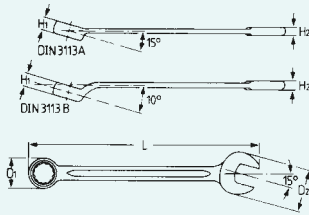

Code	CP	AF	←L→ mm	H ₁ mm	H ₂ mm	D ₁ mm	D ₂ mm			EAN	€
00400632782	5/8		200	9,8	6,6	24,6	34,5	105	10	011029	10,80
00400632982	11/16		210	10,3	6,9	25,9	37,3	135	10	011043	11,65
00400633182	3/4		230	11,1	7,3	28,8	40,4	155	10	011050	13,40
00400633282	25/32		240	11,4	7,5	30,2	42,3	175	10	011067	17,40
00400633382	13/16		250	11,7	7,7	31,7	44,2	205	10	011074	15,05
00400633482	7/8		260	12,0	7,9	33,0	46,6	230	10	011081	17,15
00400633582	15/16		280	12,7	8,3	35,8	50,1	285	5	011098	19,75
00400633782	1		290	13,0	8,5	37,3	52,8	295	5	011104	19,35
00400633882	1.1/16		310	13,6	8,9	40,2	55,9	375	5	011111	28,00
00400633982	1.1/8		330	14,2	9,3	42,8	59,8	445	5	011128	29,20
00400634182	1.1/4		360	15,2	9,9	47,2	66,9	595	5	011135	32,45
00400634282	1.5/16		360	15,2	9,9	47,2	66,9	580	5	011142	32,45
00400634382	1.3/8		400	22,8	14,1	54,6	77,5	1165	5	011159	56,10
00400634482	1.7/16		400	22,8	14,1	54,6	77,5	1080	5	011166	56,10
00400634582	1.1/2		400	22,8	14,1	54,6	77,5	1060	3	011173	56,10
00400634782	1.5/8		450	25,8	15,8	62,1	83,7	1450	3	011180	70,60
00400634982	1.3/4		500	28,8	17,5	69,6	93,1	2020	1	011197	105,75
00400635082	1.13/16		500	28,8	17,5	69,6	93,1	1960	1	011203	105,75
00400635282	2		540	31,2	18,9	75,6	102,6	2600	1	011210	132,50

Code	C	AF	←L→ mm	H ₁ mm	H ₂ mm	D ₁ mm	D ₂ mm			EAN	€
00400635480	2.1/8		610	31,2	18,0	84,5	113,0	2900	1	011227	266,55
00400635580	2.3/16		610	31,2	18,0	84,5	113,0	2750	1	011234	266,55
00400635680	2.1/4		610	31,2	18,0	84,5	113,0	2650	1	011241	266,55
00400635780	2.5/16		660	31,2	20,0	90,0	122,0	3700	1	011258	358,65
00400635880	2.3/8		660	31,2	20,0	90,0	122,0	3600	1	011265	358,65
00400635980	2.7/16		660	31,2	20,0	90,0	122,0	3500	1	011272	358,65

B 400

Ringmaulschlüssel-Sätze

in attraktiver Kartonverpackung

Combination wrench sets

in attractive cardboard-carton

Jeux de clés mixtes

en emballage carton à fenêtre

Juegos de llaves combinadas

en atractivo estuche de cartón



Code	No.	MM			EAN	€
00400824082	B 400-8-M	6 7 8 9 10 13 17 19	=1	480	094374	60,45
00400827082	B 400-12-M	8 9 10 11 12 13 14 15 16 17 18 19		990	094381	101,35

HP 400

Ringmaulschlüssel-Satz

im Kunststoffhalter

Combination wrench set

in plastic holder

Jeux de clés mixtes

sur présentoir-support en plastique

Juegos de llaves combinadas

en clip de plástico



Code	No.	MM	=1		EAN	€
00400627382	HP 400-12-M	6 8 10 11 12 13		1070	340419	104,65
		14 15 16 17 18 19				

K 400

Ringmaulschlüssel-Sätze

Combination wrench sets

Jeux de clés mixtes

Juegos de llaves combinadas



Code	No.	MM	=1		EAN	€
00400924082	K 400-8-M	6 7 8 9 10 13 17 19		480	011470	60,45
00400924382	K 400-8-M-2	10 12 13 14 17 19 22 24		1031	366853	83,25
00400925582	K 400-10-M	8 9 10 11 12 13 14 17 19 22		875	011487	86,55
00400927082	K 400-12-M	8 9 10 11 12 13 14 15 16 17 19 22		1075	011494	105,15
00400927282	K 400-12-M-2	6 7 8 9 10 11 12 13 14 17 19 22		905	011524	99,20
00400927582	K 400-12-M-3	10 11 12 13 14 17 19 22 24 27 30 32		2468	366877	159,50
00400928582	K 400-14-M	8 9 10 11 12 13 14 15 16 17 19 21 22 24		1527	366211	135,70
00400928982	K 400-15-M	6 7 8 9 10 11 12 13 17 19 22 24 27 30 32		2550	011548	176,50
00400928882	K 400-16-M	6 7 8 10 11 12 13 14 15 17 19 22 24 27 30 32		2524	366228	187,55
00400929082	K 400-17-M	6 7 8 9 10 11 12 13 14 15 16 17 18 19 20 21 22		1450	011555	155,55
00400929582	K 400-22-M	8 9 10 11 12 13 14 15 16 17 18 19 20 21 22 23 24 26 27 28 30 32		4320	011562	284,20
00400929882	K 400-26-M	6 7 8 9 10 11 12 13 14 15 16 17 18 19 20 21 22 23 24 25 26 27 28 29 30 32		5090	011579	336,75

Code	No.	AF	=1		EAN	€
00400932082	K 400-6-AF	3/8 7/16 1/2 9/16 5/8 3/4		500	011586	57,40
00400934082	K 400-8-AF	5/16 3/8 7/16 1/2 9/16 5/8 11/16 3/4		660	011593	75,50
00400935582	K 400-10-AF	5/16 3/8 7/16 1/2 9/16 5/8 11/16 3/4 13/16 7/8		1095	011609	107,65
00400937082	K 400-12-AF	5/16 3/8 7/16 1/2 9/16 5/8 11/16 3/4 13/16 7/8 15/16 1		1675	011616	146,70
00400939082	K 400-17-AF	1/4 5/16 3/8 7/16 1/2 9/16 19/32 5/8 11/16 3/4 25/32 13/16 7/8 15/16 1 1.1/16 1.1/4		2930	011623	240,10
00400939582	K 400-22-AF	1/4 5/16 3/8 7/16 1/2 9/16 19/32 5/8 11/16 3/4 25/32 13/16 7/8 15/16 1 1.1/16 1.1/8 1.1/4 1.5/16 1.3/8 1.7/16 1.1/2		7260	011630	470,10



Die passende Antwort auf Biegen und Brechen

Hervorragend in Form und hart im Nehmen.

Klassische Legierungen haben einen guten Ruf. Ohne Zweifel. Gewohnt, Gutes immer wieder zu verbessern, schmiedeten wir hochwertigen Chrom-Vanadium-Stahl zur Schlüsselgeneration **maxline**. Ein starkes Stück Werkzeug, das bei aller Eleganz und Leichtigkeit selbst außergewöhnlichen Belastungen moderner Verschraubungstechniken spielend gewachsen ist.

DIN ist gut, wir sind besser.

Normen sind das Maß der Technik. Sind sie erfüllt, ist alles bestens. Die nach DIN 899 geforderte Drehmomentbelastbarkeit haben wir nicht nur erreicht, sondern weit übertroffen. Mit viel Erfahrung, CAD, erstklassigem Werkstoff und den gewohnt präzisen Fertigungsverfahren.

Wir sparen, wo wir können.

Probieren geht über studieren. An diesem empirischen Grundsatz orientierten sich Generationen von Werkzeugmachern. Heute eröffnet uns die Computertechnik mit ihrer Finite-Elemente-Methode ungeahnte Möglichkeiten. Design und Geometrie erfahren eine Optimierung, Material wird an wenig beanspruchten Stellen reduziert, an kritischen zugefügt. Es entwickelt sich Schritt für Schritt eine funktionale Ästhetik. Das Ergebnis liegt vor Ihnen. Leicht, schlank und bärenstark.

Ein Finish für die Sinne.

Wir meinen, daß sich die inneren Werte der **maxline**-Generation auch äußerlich zeigen sollten. Deshalb haben wir sie mit unserem neuen HEYCO-Finish ausgestattet. Die sympathisch feine Oberfläche harmoniert aufs Beste mit der angenehmen, griffsicheren Struktur.

Schraubköpfe leben länger.

Das spezielle **maxline**-Profil setzt mit Doppel-Sechskant an den Flächen, nicht an den Kanten der Schraubköpfe an. Dadurch werden zum einen die Schraubkanten geschont, zum anderen sind Schlüssel und Schraube höher belastbar. Eine positive Auswirkung auf die erheblich längere Lebensdauer beider Beteiligten.

Die beiden Computerdarstellungen zeigen im Detail die Kraftübertragung vom Schlüssel auf die Schraube.

The ultimate answer to bending and breakage

Tough tools. Tomorrow's design.

Classic alloys have a good reputation, no doubt about it. We have a tradition of improving on good ideas. That's why we use top-quality chrome vanadium steel to forge **maxline**. The new generation of wrenches. Don't be fooled by good looks and light weight. These tough tools are more than a match for the high torque demands on today's bolted joints. See the following sections for more details.

DIN is good. We're better.

Standards are the metrics of technology. Any good tool will meet them. We not only designed our tools to withstand the torque load required by DIN 899. We went a step further and practically doubled that torque. With a world of experience, CAD technology, first-class materials and the precision engineering we're famous for.

We save wherever we can.

Hands-on practice beats classroom theory. Generations of toolmakers have followed this empirical principle. The finite-element method of today's computer technology has opened up new opportunities. We've optimized design and geometry, decreased the amount of material where stresses are low, and increased it at critical points. Step by step, we have reinvented functional, aesthetic tools. You're looking at the result: light, trim, tough.

Elegant finish.

We believe that the superior quality that goes into the **maxline** generation should show on the outside. So we gave these tools our new HEYCO finish. The tough abrasive surface blends in perfectly with the comfortable, non-slip grip.

Bolt heads last longer.

With its double hex box design, the special **maxline** profile applies force to the full surface of the bolt head, not to the outer edges. This has the double advantage of reducing wear on the bolt while increasing the load tolerance of both wrench and bolt. And this makes it easier for everyone.

The two computer graphics show in detail how force is transferred from the wrench to the bolt.

H
G
F
E
D
C
B
A

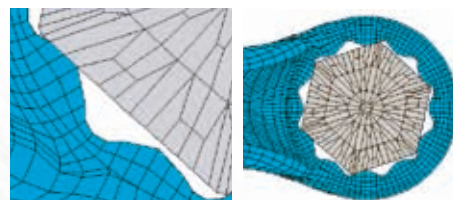
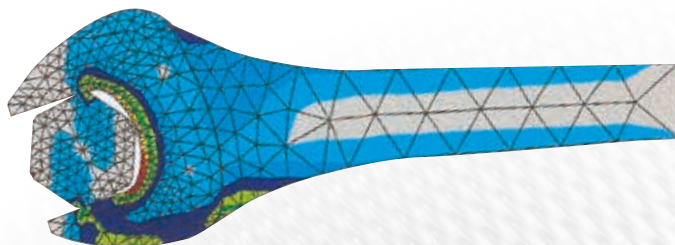

La réponse aux problèmes de casse et de déformation

En pleine forme et durs à la tâche

Les alliages classiques ont bonne réputation. Sans aucun doute. Habitué à améliorer constamment ce qui est déjà bien, nous forgerons désormais **maxline**, la nouvelle génération de clés, à partir d'un acier de haute qualité au chrome-vanadium. Malgré son élégance et sa légèreté, cet outil puissant maîtrise facilement les sollicitations les plus extrêmes des techniques de vissage modernes. Vous en lisez plus ci-dessous.

La norme DIN c'est bien, nous sommes meilleurs

Les normes sont la mesure de la technique. Tout est pour le mieux lorsqu'elles sont remplies. Or, ce n'est pas seulement la capacité de sollicitation au couple exigée par la norme DIN 899 que nous avons atteinte, mais presque le double. Grâce à notre grande expérience, à la C.A.O., à une matière de toute première qualité et à la précision habituelle de nos procédés de fabrication.

Economiser partout où c'est possible

Expérience passe science. Des générations d'outilleurs se fondent sur ce principe empirique. De nos jours, la technologie des ordinateurs et notamment la C.A.O. (Croquis Assisté par Ordinateur) nous ouvre des horizons inespérés. Optimisation du design et de la géométrie. Réduction de la matière aux endroits peu sollicités, apport aux endroits critiques. Léger, mince et superpuissant.

Une finition pour les sens

Nous pensons que les valeurs cachées de la génération **maxline** doivent également se voir de l'extérieur. C'est pourquoi nous lui avons donné notre nouvelle finition HEYCO. La surface à l'aspect sympathique et pur s'harmonise au mieux avec la structure antidérapante agréable au toucher.

Longévité accrue des têtes de vis

Avec son six pans double, le profil spécial de **maxline** saisit les têtes de vis par les faces et non par les angles. Cela permet de ménager les angles des têtes de vis tout en exerçant une sollicitation plus élevée sur la clé et sur la vis. Un effet positif pour une longévité accrue de la vis et de l'outil.

A l'ordinateur, le détail de la transmission de la force de la clé sur la vis se représente comme suit.

La combinación ideal de dos herramientas

Avanzado diseño y superior rendimiento.

Fiel a nuestra costumbre de constantes mejoras, forjamos la nueva línea **maxline** de acero al cromo vanadio extra, calidad. Una gran herramienta que a pesar de su forma estilizada aguanta los elevados pares de apriete exigidos incluso en condiciones extremas.

La norma DIN es exigente, nosotros exigimos más.

Normas establecen las exigencias técnicas básicas. Si se cumplen, vale. Pero nosotros no solamente cumplimos con los pares de apriete exigidos por la norma DIN 899, sino casi los doblamos, gracias a la experiencia de muchos años, diseño por ordenador, acero de calidad y técnicas de fabricación de gran precisión.

Economizamos todo lo que se puede.

El diseño por ordenador abre nuevos horizontes con el método de elementos finitos. Se optimizan diseño y geometría, el material se reduce en los puntos que no hacen esfuerzo y se aumenta en los puntos críticos. Paso a paso se desarrolla una estética funcional. El resultado está a la vista: Una llave ligera, elegante y de superior resistencia.

Dos herramientas en una.

La llave **maxline** combina en una sola pieza dos herramientas diferentes. Sustituyendo dos tipos de llaves, las de boca abierta y las de boca estrella acodada, le ahorran dinero y sitio en su caja de herramientas.

La vida de las tuercas se alarga.

El perfil especial **maxline** de la boca estrella ejerce la presión sobre los planos del exágono de la tuerca, no en los cantos. Gracias a ello, los cantos no se redondean, pudiéndose aplicar pares de apriete superiores. El resultado es una mayor duración tanto de la tuerca como de la llave.

Los dos gráficos de ordenador reproducen en detalle la aplicación de la fuerza desde la llave a la tuerca.

R 400

Ringmaulschlüssel-Sätze

in Kunststoff-Rolltaschen mit Riemen

Combination wrench sets

in plastic wallets, with strap

Jeux de clés mixtes

en trousse plastique, avec lanière

Juegos de llaves combinadas

en bolsas de plástico, con correa



Code	No.	⊕MM	=1	g	EAN	€
00400724082	R 400-8-M	6 7 8 9 10 13 17 19		605	011388	75,10
00400727182	R 400-12-M-1	8 9 10 11 12 13 14 15 16 17 18 19		1160	113853	125,40
00400727282	R 400-12-M-2	6 7 8 9 10 11 12 13 14 17 19 22		1075	011395	123,20
00400728082	R 400-13-M	10 11 12 13 14 15 16 17 18 19 20 21 22		1725	011401	153,85
00400728182	R 400-13-M-2	6 7 8 9 10 11 12 13 14 15 17 19 22		1185	011418	132,35

Code	No.	⊕AF	=1	g	EAN	€
00400734082	R 400-8-AF	5/16 3/8 7/16 1/2 9/16 5/8 11/16 3/4		785	011425	90,35
00400737082	R 400-12-AF	5/16 3/8 7/16 1/2 9/16 5/8 11/16 3/4 13/16 7/8 15/16 1		1840	011432	168,90
00400738082	R 400-13-AF	1/4 5/16 3/8 7/16 1/2 9/16 5/8 11/16 3/4 13/16 7/8 15/16 1		1875	011449	177,35

410

Ringmaulschlüssel *maxline*

DIN 3113 B/ISO 3318 · ISO 7738
Hochwertiger Chrom-Vanadium-Stahl,
dadurch Steigerung der Drehmoment-
Werte auf nahezu das Doppelte als
DIN/EN/ISO
CPP = verchromt,
ganz poliert

Combination wrenches *maxline*

DIN 3113 B/ISO 3318 · ISO 7738
High-grade Chrome-Vanadium
steel for more strength and
approx. double torque as required
by DIN/EN/ISO
CPP = chromium plated,
fully polished

Clés mixtes *maxline*

DIN 3113 B/ISO 3318 · ISO 7738
Un acier au Chrome-Vanadium de haute
qualité double approximativement
le couple de torsion par rapport aux
exigences des normes DIN/EN/ISO
CPP = chromées,
entièrement polies

Llaves combinadas *maxline*

DIN 3113 B/ISO 3318 · ISO 7738
Acero al cromo vanadio de alta aleación,
por tanto aumento de los pares
de apriete al casi el doble de lo exigido
en las normas DIN/EN/ISO
CPP = cromado,
enteramente pulido espejo

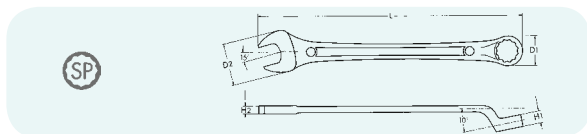

Code	⊕MM	←L→ mm	H ₁ mm	H ₂ mm	D ₁ mm	D ₂ mm	g		EAN	€
00410010083	10	149	6,9	4,9	15,7	21,9	49	10	097030	8,30
00410011083	11	161	7,4	5,2	16,8	23,9	60	10	097047	8,75
00410012083	12	173	7,8	5,5	18,1	25,9	74	10	097054	9,45
00410013083	13	185	8,3	5,9	19,4	28,0	88	10	097061	10,10
00410014083	14	197	8,8	6,1	20,7	30,0	100	10	097078	10,30
00410015083	15	209	9,2	6,4	21,9	32,1	120	10	097085	12,10
00410016083	16	221	9,7	6,7	23,1	34,2	145	10	097092	13,15
00410017083	17	233	10,2	7,0	24,3	36,1	165	10	097108	13,60
00410018083	18	245	10,7	7,3	25,7	38,2	185	10	097115	15,20
00410019083	19	257	11,2	7,6	27,1	40,3	215	10	097122	16,05
00410020083	20	269	11,6	7,8	28,4	42,3	245	10	097139	17,05
00410021083	21	281	12,0	8,2	29,7	44,3	275	5	097146	17,40
00410022083	22	293	12,5	8,5	31,1	46,3	315	5	097153	19,75
00410024083	24	317	13,5	9,1	33,8	50,4	390	5	097160	22,35
00410027083	27	352	14,8	9,9	37,8	56,1	530	5	097177	24,95
00410030083	30	388	16,3	10,9	41,8	61,6	675	5	097184	31,90
00410032083	32	412	17,2	11,4	44,5	65,5	830	5	097191	33,55
00410034083	34	436	18,2	12,0	47,3	69,3	1025	3	097207	44,50
00410036083	36	460	19,1	12,6	49,9	73,1	1145	3	097214	55,70
00410041083	41	520	21,5	14,1	56,6	82,6	1640	3	097221	71,95

K 410

Ringmaulschlüssel-Sätze *maxline*

DIN 3113 B/ISO 3318 · ISO 7738

Combination wrench sets *maxline*

DIN 3113 B/ISO 3318 · ISO 7738

Jeux de clés mixtes *maxline*

DIN 3113 B/ISO 3318 · ISO 7738

Juegos de llaves combinadas *maxline*

DIN 3113 B/ISO 3318 · ISO 7738



Code	No.	MM	g	EAN	€
00410945083	K 410-9-M	10 13 16 17 18 19 21 22 24	1830	100853	135,70
00410946083	K 410-11-M	10 13 16 17 18 19 21 22 24 27 30	3035	100860	192,65
00410948583	K 410-14-M	10 11 12 13 14 15 16 17 18 19 20 21 22 24	2440	100877	193,25

430

Starter- und Blockschlüssel

Starter and manifold wrenches

Chrom-Vanadium
CP = verchromt,
Ringe poliert

Chrome-Vanadium
CP = chromium plated,
polished rings

Clés polygonales demi-lune

Chrom-Vanadium
CP = chromées,
têtes polies

Llaves de estrella de dos bocas, para motor de arranque

Cromo Vanadio
CP = cromado,
cabezas pulidas espejo



Code	MM	L mm	H ₁ mm	H ₂ mm	D ₁ mm	D ₂ mm	g	EAN	€
00430111382	11 x 13	150	6,8	7,0	17,9	20,8	70	011678	14,30
00430141682	14 x 16	185	8,2	8,4	23,8	26,7	110	011685	17,35
00430141782	14 x 17	185	8,2	8,4	23,8	26,7	105	011692	17,35
00430192282	19 x 22	235	11,3	11,0	29,8	34,3	225	011715	22,45

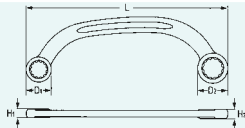

450

Doppelringschlüssel

Double ended ring wrenches

DIN 837 / ISO 1085
Chrom-Vanadium
CP = verchromt, Ringe poliert
gerade

DIN 837 / ISO 1085
Chrome-Vanadium, CP = chromium
plated, polished rings
straight

Clés polygonales

DIN 837 / ISO 1085
Chrom-Vanadium
CP = chromées, têtes polies
droites

Llaves de estrella planas, de dos bocas

DIN 837 / ISO 1085
Cromo Vanadio
CP = cromado, cabezas pulidas espejo



Code	MM	L mm	H mm	D ₁ mm	D ₂ mm	g	EAN	€
00450060782	6 x 7	95	4,2	10,0	11,5	10	011753	6,90
00450080982	8 x 9	110	4,8	13,0	14,0	15	011760	7,85
00450101182	10 x 11	120	5,4	16,0	17,0	23	011791	8,25
00450101382	10 x 13	138	6,1	16,0	20,0	30	011821	9,90
00450121382	12 x 13	138	6,1	18,5	20,0	38	011838	8,95
00450131782	13 x 17	170	7,4	20,0	25,5	55	011869	10,95
00450141582	14 x 15	155	6,7	21,0	23,0	43	011876	10,40
00450141782	14 x 17	170	7,4	21,0	25,5	55	011883	11,40
00450161782	16 x 17	170	7,4	24,5	25,5	60	011890	10,85
00450171982	17 x 19	190	8,2	25,5	28,0	80	011937	11,75
00450181982	18 x 19	190	8,2	27,0	28,0	85	011944	11,75
00450202282	20 x 22	210	8,9	29,5	32,5	115	011982	13,10
00450212382	21 x 23	232	9,8	30,5	33,5	140	011999	15,10
00450222482	22 x 24	232	9,8	32,5	35,5	145	012002	15,80
00450242682	24 x 26	255	10,7	35,5	38,0	175	162684	16,95
00450242782	24 x 27	255	10,7	35,5	39,0	185	012019	16,95
00450252882	25 x 28	278	11,6	36,5	41,0	220	012026	18,65
00450303282	30 x 32	305	12,3	43,5	46,0	300	012033	22,40
00450364182	36 x 41	365	14,3	51,5	59,0	500	012040	40,45



K 450

Doppelringschlüssel-Sätze | Double ended ring wrench sets

Jeux de clés polygonales

Juegos de llaves de estrella planas, de dos bocas



Code	No.	MM	=1				g	EAN	€
00450944082	K 450-8-M	6 x 7 14 x 15	8 x 9 16 x 17	10 x 11 18 x 19	12 x 13 20 x 22	390	012057	78,05	
00450947082	K 450-12-M	6 x 7 14 x 15 21 x 23	8 x 9 16 x 17 24 x 27	10 x 11 18 x 19 25 x 28	12 x 13 20 x 22 30 x 32	1235	012064	150,90	

475

Doppelringschlüssel

Double ended ring wrenches

Clés polygonales

Llaves de estrella acodadas, de dos bocas

DIN 838 / ISO 1085
Chrom-Vanadium
CP = verchromt, Ringe poliert,
C = verchromt (ab 55 x 60 mm)
tief gekröpft, lange Form

DIN 838 / ISO 1085
Chrome-Vanadium
CP = chromium plated, polished rings
C = chromium plated, (as from
55 x 60 mm) deep offset, long type

DIN 838 / ISO 1085
Chrome-Vanadium
CP = chromées, têtes polies
C = chromées (de 55 x 60 mm)
contre-coudées profondément, modèle long

DIN 838 / ISO 1085
Cromo Vanadio
CP = cromado, cabezas pulidas espejo
C = cromado (desde 55 x 60 mm)
acodado profundo, modelo largo

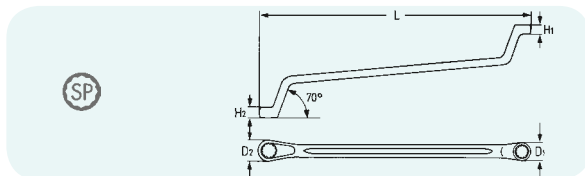

Code	CP	MM	L mm	H ₁ mm	H ₂ mm	D ₁ mm	D ₂ mm	g	mm	EAN	€
00475055782		5,5 x 7	165	5,8	6,3	10,6	12,2	42	10	012194	10,20
00475060782		6 x 7	165	5,8	6,3	10,6	12,2	43	10	012200	8,80
00475070882		7 x 8	170	6,0	6,7	12,2	13,5	55	10	012217	10,70
00475080982		8 x 9	180	6,7	7,3	13,7	15,1	61	10	012224	8,95
00475081082		8 x 10	180	6,7	7,5	13,7	16,4	67	10	012231	10,40
00475091182		9 x 11	195	7,3	8,1	15,1	17,9	78	10	012248	11,60
00475101182		10 x 11	195	7,5	8,1	16,4	17,9	85	10	012255	9,75
00475101382		10 x 13	216	7,5	9,0	16,4	20,9	115	10	012279	12,05
00475111382		11 x 13	216	8,4	9,0	18,3	20,9	115	10	012286	12,60
00475121382		12 x 13	216	8,4	9,0	19,7	20,9	120	10	012293	10,45
00475121482		12 x 14	216	8,4	9,3	19,7	22,3	110	10	012309	12,15
00475131482		13 x 14	238	9,0	9,3	20,9	22,3	145	10	012316	12,15
00475131582		13 x 15	238	9,0	9,3	20,9	24,0	145	10	012323	12,35
00475131682		13 x 16	238	9,0	10,2	20,9	25,4	150	10	012330	14,10
00475131782		13 x 17	262	9,0	10,4	20,9	27,0	185	5	012347	13,70
00475141582		14 x 15	238	9,6	10,1	22,4	25,0	150	10	012354	11,25
00475141782		14 x 17	262	9,3	10,4	22,2	27,0	185	5	012361	13,70
00475161782		16 x 17	262	10,2	10,4	25,4	27,0	200	5	012378	12,75
00475171982		17 x 19	290	10,8	11,0	27,0	29,7	260	5	012415	14,80
00475181982		18 x 19	290	10,8	11,0	27,8	29,7	250	5	012422	13,85
00475182182		18 x 21	290	11,0	11,8	28,4	32,4	265	5	012439	18,85
00475192282		19 x 22	320	11,0	12,2	29,7	34,0	320	5	012453	18,50
00475192482		19 x 24	326	11,0	12,8	29,7	37,0	365	5	012477	21,55
00475202282		20 x 22	320	11,5	12,2	31,8	34,0	340	5	012484	16,25
00475212382		21 x 23	326	11,8	12,5	32,4	35,3	350	5	012491	19,80
00475212482		21 x 24	326	11,8	12,8	32,4	37,0	345	5	012507	22,20
00475222482		22 x 24	326	12,2	12,8	34,0	37,0	350	5	012521	21,55
00475242682		24 x 26	337	12,8	13,9	37,0	41,0	420	5	012538	23,50
00475242782		24 x 27	337	12,8	13,9	37,0	41,0	445	5	012552	22,20
00475243082		24 x 30	346	12,8	14,6	37,0	45,5	490	5	012569	24,90
00475252882		25 x 28	346	13,0	14,2	39,2	43,0	495	5	012576	24,50

475

Doppelringschlüssel

DIN 838 / ISO 1085

Chrom-Vanadium

CP = verchromt, Ringe poliert,
C = verchromt (ab 55 x 60 mm)
tief gekröpft, lange Form

Double ended ring wrenches

DIN 838 / ISO 1085

Chrome-Vanadium

CP = chromium plated, polished rings
C = chromium plated, (as from
55 x 60 mm) deep offset, long type

Clés polygonales

DIN 838 / ISO 1085

Chrom-Vanadium

CP = chromées, têtes polies
C = chromées (de 55 x 60 mm)
contre-coudées profondément, modèle long

Llaves de estrella acodadas, de dos bocas

DIN 838 / ISO 1085

Cromo Vanadio

CP = cromado, cabezas pulidas espejo
C = cromado (desde 55 x 60 mm)
acodado profundo, modelo largo

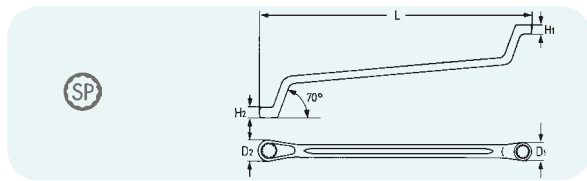

Code	CP	MM	←L→ mm	H ₁ mm	H ₂ mm	D ₁ mm	D ₂ mm	g	g	EAN	€
00475272982		27 x 29	346	13,9	14,6	40,5	45,3	505	5	012583	31,75
00475273082		27 x 30	346	13,9	14,6	40,5	45,3	515	5	012590	28,95
00475273282		27 x 32	358	13,9	15,5	42,0	49,0	585	5	012606	28,30
00475303282		30 x 32	360	14,8	15,5	45,5	49,0	615	5	012620	28,30
00475303482		30 x 34	380	14,8	16,5	45,5	51,8	600	5	012637	32,25
00475303682		30 x 36	412	16,0	17,6	45,5	53,7	805	5	012644	48,00
00475323682		32 x 36	412	17,0	18,2	48,2	53,5	860	5	012651	48,00
00475364182		36 x 41	440	18,0	19,5	53,5	60,5	1140	3	012668	59,35
00475414682		41 x 46	476	19,7	21,4	63,0	70,0	1300	3	012675	80,70
00475465082		46 x 50	500	21,4	22,4	67,0	73,0	1660	1	012682	109,65

Code	C	MM	←L→ mm	H ₁ mm	H ₂ mm	D ₁ mm	D ₂ mm	g	g	EAN	€
00475556080		55 x 60	612	25,0	26,0	86,0	94,0	3935	1	012699	184,95
00475657080		65 x 70	688	27,0	28,0	103,0	110,0	5200	1	012705	350,10
00475758080		75 x 80	770	29,0	30,0	121,0	127,0	7100	1	013108	511,85

Code	CP	AF	←L→ mm	H ₁ mm	H ₂ mm	D ₁ mm	D ₂ mm	g	g	EAN	€
00475660682		1/4 x 5/16	170	6,0	6,7	12,2	13,5	55	10	012712	10,45
00475660982		5/16 x 3/8	180	6,7	7,5	13,7	16,4	64	10	012729	11,20
00475661382		3/8 x 7/16	195	7,5	8,1	16,4	17,9	87	10	012736	12,50
00475661782		7/16 x 1/2	216	8,4	9,0	18,3	20,9	110	10	012743	13,30
00475661982		1/2 x 9/16	239	9,0	9,3	20,9	22,3	145	10	012750	13,70
00475662282		9/16 x 5/8	239	9,3	9,7	22,3	25,0	145	10	012767	13,80
00475662782		5/8 x 11/16	262	10,2	10,4	25,4	27,0	190	5	012774	14,75
00475662882		5/8 x 3/4	290	10,2	11,0	25,4	29,7	230	5	012781	16,35
00475663082		11/16 x 3/4	290	10,8	11,0	27,8	29,7	265	5	012798	17,00
00475663582		3/4 x 25/32	290	11,0	11,4	29,7	31,8	260	5	012804	17,00
00475663782		3/4 x 7/8	320	11,0	12,2	29,7	34,0	305	5	012811	20,55
00475664182		13/16 x 7/8	320	11,5	12,2	31,8	34,0	315	5	012828	20,55
00475664382		7/8 x 15/16	326	12,2	12,8	34,0	37,0	350	5	012835	22,90
00475664682		15/16 x 1	337	12,8	13,9	37,0	41,0	445	5	012842	25,45
00475665082		1 x 1.1/8	346	13,0	14,2	39,2	43,0	500	5	012859	28,05
00475665382		1.1/16 x 1.1/4	358	13,9	15,5	42,0	49,0	600	5	012866	32,00
00475665582		1.1/8 x 1.5/16	360	14,6	15,5	45,5	50,0	585	5	012873	32,85
00475665882		1.3/16 x 1.5/16	360	14,6	15,5	45,5	50,0	590	5	012880	32,85
00475666082		1.1/4 x 1.3/8	412	17,0	18,2	48,2	53,5	840	5	012897	55,70
00475666482		1.5/16 x 1.1/2	412	17,0	18,2	48,2	53,5	820	5	012903	55,70
00475666882		1.7/16 x 1.5/8	440	18,0	19,5	53,5	60,5	1030	3	012910	70,75
00475667482		1.11/16 x 1.7/8	476	19,7	21,4	63,0	70,0	1260	3	012927	91,15
00475667782		1.13/16 x 2	500	21,4	22,4	67,0	73,0	1570	1	012934	121,30



K 475

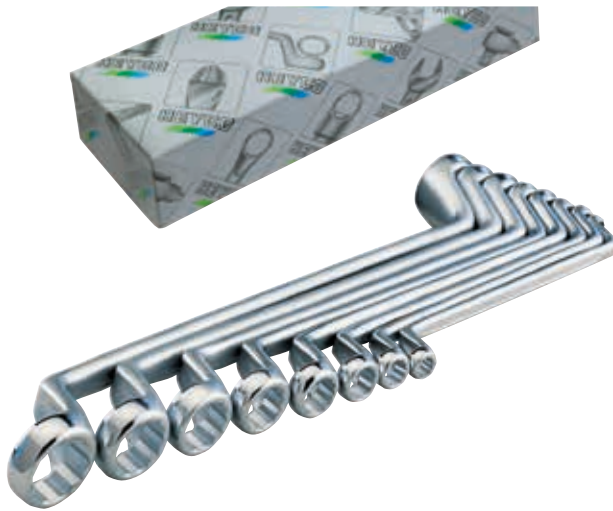

Doppelringschlüssel-Sätze | Double ended ring wrench sets



Jeux de clés polygonales

Juegos de llaves de estrella planas, de dos bocas

Code	No.	MM	 =1	 g	EAN	€	
00475942082	K 475-6-M-1	6 x 7 14 x 15	8 x 9 16 x 17	10 x 11 12 x 13	660	013122	61,90
00475942182	K 475-6-M-2	8 x 9 16 x 17	10 x 11 18 x 19	12 x 13 14 x 15	865	013139	67,00
00475944082	K 475-8-M	6 x 7 14 x 15	8 x 9 16 x 17	10 x 11 18 x 19 20 x 22	1250	013160	92,35
00475947082	K 475-12-M	6 x 7 14 x 15 21 x 23	8 x 9 16 x 17 24 x 27	10 x 11 18 x 19 25 x 28 30 x 32	3155	013184	186,90
00475948582	K 475-14-M	6 x 7 14 x 15 21 x 23 36 x 41	8 x 9 16 x 17 24 x 27 46 x 50	10 x 11 18 x 19 25 x 28 30 x 32	5955	013207	355,85

Code	No.	AF	 =1	 g	EAN	€
00475962082	K 475-6-AF-1	1/4 x 5/16 1/2 x 9/16 3/4 x 25/32	3/8 x 7/16 5/8 x 11/16 13/16 x 7/8	1050	013214	88,75
00475962182	K 475-6-AF-2	3/8 x 7/16 5/8 x 11/16 13/16 x 7/8	1/2 x 9/16 3/4 x 25/32 15/16 x 1	1445	013221	103,90
00475964082	K 475-8-AF	1/4 x 5/16 1/2 x 9/16 3/4 x 25/32 15/16 x 1	3/8 x 7/16 5/8 x 11/16 13/16 x 7/8 1.1/16 x 1.1/4	2100	013238	146,30
00475967082	K 475-12-AF	1/4 x 5/16 1/2 x 9/16 5/8 x 3/4 3/4 x 7/8 7/8 x 15/16 1 x 1.1/8	3/8 x 7/16 5/8 x 11/16 3/4 x 25/32 13/16 x 7/8 15/16 x 1 1.1/16 x 1.1/4	3485	013245	234,30

R 475

Doppelringschlüssel-Sätze | Double ended ring wrench sets
in Kunststoff-Rolltaschen mit Riemen | in plastic wallets, with strap







Jeux de clés polygonales

Juegos de llaves de estrella planas, de dos bocas

en trousse plastique, avec lanière

en bolsas de plástico, con correa

Code	No.	MM	 =1	 g	EAN	€	
00475744082	R 475-8-M	6 x 7 14 x 15	8 x 9 16 x 17	10 x 11 18 x 19 20 x 22	1375	013085	114,70
00475747082	R 475-12-M	6 x 7 14 x 15 21 x 23	8 x 9 16 x 17 24 x 27	10 x 11 18 x 19 25 x 28 30 x 32	3320	013092	217,50
00475747182	R 475-12-M-1	6 x 7 14 x 15 21 x 23	8 x 9 16 x 17 24 x 26	10 x 11 18 x 19 25 x 28 30 x 32	3310	163728	218,75

Code	No.	AF	 =1	 g	EAN	€
00475767082	R 475-12-AF	1/4 x 5/16 1/2 x 9/16 5/8 x 3/4 3/4 x 7/8 7/8 x 15/16 1 x 1.1/8	3/8 x 7/16 5/8 x 11/16 3/4 x 25/32 13/16 x 7/8 15/16 x 1 1.1/16 x 1.1/4	3650	013115	264,90

493

Doppel-Gelenksteck-schlüssel

Verbesserte Ausführung mit Nietstiften
Chrom-Vanadium
CP = verchromt, Köpfe poliert

Double ended swivel wrenches

Improved pattern, with rivet pin
Chrome-Vanadium, CP = chromium plated, polished heads

Clés à douilles articulées

Exécution améliorée, avec axe riveté
Chrome-Vanadium
CP = chromées, douilles polies

Llaves de vaso articuladas, de dos bocas

Modelo mejorado, con remaches
Cromo Vanadio
CP = cromado, vasos pulidos espejo

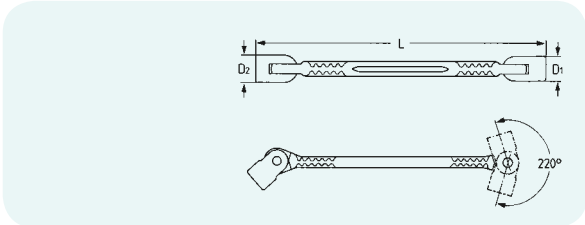

6 x 7 mm

8 x 9 – 21 x 23 mm
AF 3/8 x 7/16 – 3/4 x 7/8

Code	MM	←L→ mm	D ₁ mm	D ₂ mm	g		EAN	€
00493060782	6 x 7	175	10,0	11,0	47	10	013405	29,65
00493080982	8 x 9	186	12,0	13,5	68	10	013429	29,65
00493101182	10 x 11	199	14,5	16,0	100	10	013443	31,70
00493121382	12 x 13	213	17,5	19,0	145	10	013467	34,00
00493141582	14 x 15	229	20,0	21,5	210	10	013504	37,30
00493161782	16 x 17	246	22,5	24,0	275	10	013528	42,15
00493181982	18 x 19	265	25,0	26,5	350	5	013566	46,10
00493202282	20 x 22	285	28,0	30,5	490	5	013580	50,85

Code	AF	←L→ mm	D ₁ mm	D ₂ mm	g		EAN	€
00493661382	3/8 x 7/16	199	14,5	16,0	100	10	013634	32,05
00493661982	1/2 x 9/16	229	20,0	21,5	210	10	013658	37,05
00493662782	5/8 x 11/16	246	22,5	24,0	275	10	013672	43,00
00493663782	3/4 x 7/8	285	28,0	30,5	490	5	013719	49,85

R 493

Doppel-Gelenksteck-schlüssel-Sätze

in Kunststoff-Rolltaschen mit Riemen

Double ended swivel wrench sets

in plastic wallets, with strap

Jeux de clés à douilles articulées

en trousse plastique, avec lanière

Juegos de llaves de vaso articuladas, de dos bocas

en bolsas de plástico, con correa



Code	No.	MM		g	EAN	€
00493742082	R 493-6-M-1	6 x 7 14 x 15	8 x 9 16 x 17	10 x 11 12 x 13	975	013733 224,05
00493742182	R 493-6-M-2	8 x 9 16 x 17	10 x 11 18 x 19	12 x 13 14 x 15	1275	013740 240,45
00493743082	R 493-7-M	8 x 9 16 x 17	10 x 11 18 x 19	12 x 13 20 x 22	1795	013757 291,60

495

Öldienstschlüssel

Chrom-Vanadium
C = verchromt

9 ■ für Innenvierkant-Schrauben
1 ■ für Ölfaß-Schlitzschrauben

Drain plug wrenches

Chrome-Vanadium
C = chromium plated

9 ■ for hollow square screws
1 ■ for slotted oil barrel plugs

Clés de vidange d'huile

Chrom-Vanadium
C = chromées

9 ■ pour vis à carré femelle
1 ■ pour vis à tête fendue

Llaves para cárter

Cromo Vanadio
C = cromado

9 ■ para tornillos de cárter
1 ■ para tornillos de barril de aceite



Code	←L→ mm	g		EAN	€
00495000080	220	440	5	013771	28,95

497

Offene Doppelring- schlüssel

DIN 3118
Chrom-Vanadium
C = verchromt

für Überwurfmutter an Rohrleitungs-
Verschraubungen

8 x 10 – 13 x 14 mm,
Köpfe 30° geschlitzt,
15° abgewinkelt



14 x 17 – 30 x 32 mm,
Köpfe 15° geschlitzt,
15° abgewinkelt



Flare nut ring wrenches

DIN 3118
Chrome-Vanadium
C = chromium plated

for cap and union nuts on pipes

88 x 10 – 13 x 14 mm,
rings with gap at 30°,
angled at 15°



14 x 17 – 30 x 32 mm,
rings with gap at 15°,
angled at 15°



Clés à tuyauter

DIN 3118
Chrome-Vanadium
C = chromées

pour écrous et vis à chapeau,
pour fixation
de raccords de tuyaux

8 x 10 – 13 x 14 mm,
têtes fendues à 30°,
coudées 15°



14 x 17 – 30 x 32 mm,
têtes fendues à 15°,
coudées 15°



Llaves de estrella abierta, de dos bocas

DIN 3118
Cromo Vanadio
C = cromado

para tuercas y tornillos de racores

8 x 10 – 13 x 14 mm,
cabezas con abertura
de 30°, inclinadas a 15°



14 x 17 – 30 x 32 mm,
cabezas con abertura
de 15°, inclinadas a 15°

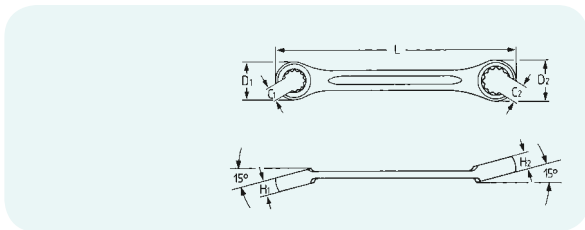

Code	C	ØMM	←L→ mm	H ₁ mm	H ₂ mm	D ₁ mm	D ₂ mm	C ₁ mm	C ₂ mm	△g	📦	EAN	€
00497081080		8 x 10	140	7,0	8,5	18,0	20,0	6,0	7,0	50	10	013801	12,75
00497091180		9 x 11	150	8,5	9,0	20,0	22,0	6,5	8,5	60	10	013818	12,75
00497101180		10 x 11	150	8,5	9,0	20,0	22,0	7,0	8,5	60	10	013825	12,75
00497101280		10 x 12	150	8,5	10,0	20,0	24,0	7,0	9,0	60	10	013832	12,75
00497111380		11 x 13	175	10,0	11,0	26,0	28,0	8,5	10,0	120	10	387322	14,30
00497121480		12 x 14	170	9,0	11,0	25,0	28,0	9,0	11,0	95	10	013849	14,30
00497131480		13 x 14	170	10,5	11,0	26,0	28,0	10,0	11,0	105	10	013856	14,30
00497131580		13 x 15	175	10,0	11,0	26,0	28,0	10,0	12,0	120	10	387339	14,30
00497141780	•	14 x 17	200	11,0	12,0	28,0	30,0	11,0	14,0	140	5	013863	15,30
00497171980	•	17 x 19	210	12,0	14,0	30,0	32,0	14,0	15,0	150	5	013870	17,35
00497192280	•	19 x 22	220	14,0	16,0	32,0	38,0	15,0	17,0	205	5	013894	21,40
00497222480	•	22 x 24	235	16,0	17,0	38,0	42,0	17,0	18,0	275	5	013900	23,45
00497242680	•	24 x 26	255	16,0	17,0	43,0	46,0	19,0	20,5	320	5	170924	26,50
00497242780	•	24 x 27	255	17,0	18,0	42,0	46,0	18,0	20,0	315	5	013917	29,60
00497303280	•	30 x 32	280	21,0	23,0	50,0	52,0	21,0	24,0	435	5	013924	38,75

800

Hakenschlüssel mit Nase

DIN 1810 A
B = brüniert
für Nutmutter DIN 1804

Hook wrenches

DIN 1810 A
B = gun-metal-finish
for slotted round nuts DIN 1804

Clés à ergots

DIN 1810 A
B = brunies
pour écrous à encoches DIN 1804

Llaves de gancho con uña

DIN 1810 A
B = pavonado
para tuercas con muesca según DIN 1804

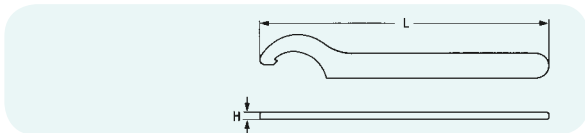

Code	ØMM	←L→ mm	H mm	△g	📦	EAN	€
00800001230	12/14	110	3,0	25	10	016321	7,30
00800001630	16/20	110	3,0	25	10	016338	7,30
00800002530	25/28	136	4,0	45	10	016345	7,95
00800003030	30/32	136	4,0	50	10	016352	8,00
00800003430	34/36	170	5,0	90	10	016369	8,45
00800004030	40/42	170	5,0	90	10	016376	8,45
00800004530	45/50	206	6,0	155	10	016383	10,00
00800005230	52/55	206	6,0	160	10	016390	10,00
00800005830	58/62	242	7,0	255	10	016406	13,35
00800006830	68/75	242	7,0	255	10	016413	13,35
00800008030	80/90	280	8,0	410	5	016420	20,30
00800009530	95/100	280	8,0	385	5	016437	20,30
00800011030	110/115	335	10,0	745	5	016444	32,55
00800012030	120/130	335	10,0	720	5	016451	33,35
00800013530	135/145	385	10,0	1000	5	016468	43,90
00800015530	155/165	385	10,0	965	5	016475	43,90
00800018030	180/195	470	10,0	1580	5	016482	81,85
00800020530	205/220	470	10,0	1580	5	016499	81,85
00800023030	230/245	560	10,0	2250	1	016505	138,45

808

Einringschlüssel

DIN 3111 / ISO 3318
L = lackiert
gerade

Single ended ring
wrenches

DIN 3111 / ISO 3318
L = lacquered
straight

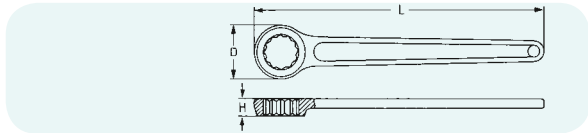

Clés polygonales simples

DIN 3111 / ISO 3318
L = laquées
droites

Llaves de estrella, de una boca

DIN 3111 / ISO 3318
L = barnizado
planas

Code	MM	←L→ mm	D mm	H mm	g		EAN	€
00808001320	13	138	25,0	8,3	60	10	016727	25,90
00808001420	14	138	25,0	8,3	60	10	016734	25,90
00808001720	17	155	31,0	9,5	100	10	016741	26,10
00808001920	19	171	30,0	11,5	120	10	016758	27,45
00808002220	22	190	36,0	13,0	150	10	016765	31,40
00808002420	24	215	38,0	15,0	205	10	016772	32,45
00808002720	27	230	41,5	16,0	240	10	016789	35,05
00808003020	30	254	46,0	18,0	320	10	016796	38,25
00808003220	32	265	49,0	19,0	350	10	016802	40,80
00808003620	36	295	55,0	22,0	500	5	016819	48,65
00808004120	41	330	63,0	25,0	780	5	016826	61,55
00808004620	46	365	70,5	27,0	950	3	016833	70,25
00808005020	50	400	77,0	28,0	1240	3	016840	84,40
00808005520	55	442	83,5	29,5	1610	3	016857	96,15
00808006020	60	475	89,5	30,0	1930	1	016864	118,70
00808006520	65	510	97,0	32,0	2210	1	016871	142,75

810

Schlag-Maulschlüssel

DIN 133
L = lackiert
Andere Größen auf Anfrage

Slogging open jaw
wrenches

DIN 133
L = lacquered
Other sizes on request

Clés à fourche à frapper

DIN 133
L = laquées
D'autres dimensions sur demande

Llaves de golpe, de una boca
abierta

DIN 133
L = barnizado
Otros tamaños sobre pedido

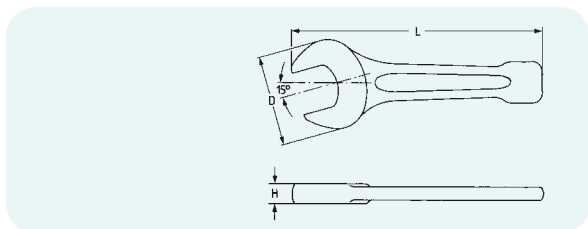

Code	MM	←L→ mm	H mm	D mm	g		EAN	€
00810002420	24	180	16,0	56	320	5	016949	22,40
00810002720	27	180	16,0	56	310	5	016956	22,40
00810003020	30	190	17,0	62	415	5	016963	25,05
00810003220	32	190	17,0	62	415	5	016970	27,05
00810003620	36	215	17,5	76	640	5	016987	35,05
00810003820	38	215	17,5	76	620	5	016994	43,35
00810004120	41	235	18,5	86	900	5	017007	43,00
00810004620	46	255	20,0	98	1400	3	017014	56,80
00810005020	50	275	21,0	105	1600	3	017021	64,85
00810005520	55	300	23,0	116	2100	3	017038	76,25
00810006020	60	320	24,5	128	2600	1	017045	82,70
00810006520	65	342	27,0	138	3400	1	017052	107,55
00810007020	70	375	30,0	154	4200	1	017069	138,45
00810007520	75	375	30,0	154	4100	1	017076	148,00
00810008020	80	408	34,0	174	6200	1	017083	186,55
00810008520	85	408	34,0	174	6100	1	017090	202,05
00810009020	90	445	38,0	194	7900	1	017106	259,80
00810009520	95	445	38,0	194	7700	1	017113	270,10
00810010020	100	485	44,0	215	11200	1	017120	405,05
00810010520	105	485	44,0	215	10800	1	017137	459,25
00810011020	110	510	47,0	235	13100	1	017144	502,15
00810011520	115	510	47,0	235	12700	1	017151	583,05
00810012020	120	545	50,0	255	17700	1	017168	596,10
00810012520	125	545	50,0	255	17400	1	017175	676,85
00810013020	130	575	55,0	275	19100	1	017182	886,65
00810013520	135	575	55,0	275	18700	1	017199	913,25
00810014020	140	575	55,0	275	18300	1	017205	990,75
00810014520	145	640	60,0	305	28500	1	017212	1.375,15
00810015020	150	640	60,0	305	28000	1	017229	1.433,65
00810015520	155	640	60,0	305	27500	1	017236	1.511,95
00810016020	160	640	60,0	305	27000	1	017243	1.666,70
00810016520	165	715	70,0	342	42000	1	017250	1.839,55
00810017020	170	715	70,0	342	41000	1	017267	2.512,25
00810017520	175	715	70,0	342	40000	1	017274	2.608,45
00810018020	180	715	70,0	342	39000	1	017281	2.899,20
00810018520	185	715	70,0	342	38000	1	017298	3.138,35

810

Schlag-Maulschlüssel

DIN 133
L = lackiert
Andere Größen auf Anfrage

Slogging open jaw wrenches

DIN 133
L = lacquered
Other sizes on request

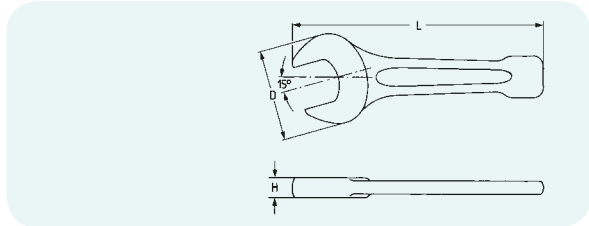

Clés à fourche à frapper

DIN 133
L = laquées
D'autres dimensions sur demande

Llaves de golpe, de una boca abierta

DIN 133
L = barnizado
Otros tamaños sobre pedido

Code	MM	←L→ mm	H mm	D mm	g		EAN	€
00810019020	190	800	78,0	392	56000	1	017304	3.376,50
00810019520	195	800	78,0	392	55000	1	017311	3.593,10
00810020020	200	800	78,0	392	53000	1	017328	3.690,50
00810021020	210	800	78,0	392	51000	1	017335	4.534,10
00810022020	220	800	72,0	415	49000	1	017342	5.896,45
00810023020	230	800	72,0	415	47000	1	017359	7.066,15

Code	AF	←L→ mm	H mm	D mm	g		EAN	€
00810633420	7/8	180	16,0	56	320	5	017366	26,95
00810633720	1	180	16,0	56	310	5	017373	26,95
00810633820	1.1/16	180	16,0	56	310	5	017380	26,95
00810633920	1.1/8	180	16,0	56	305	5	017397	26,95
00810634020	1.3/16	190	17,0	62	450	5	017403	30,15
00810634120	1.1/4	190	17,0	62	415	5	017410	32,55
00810634220	1.5/16	190	17,0	62	405	5	017427	32,55
00810634320	1.3/8	215	17,5	76	650	5	017434	41,95
00810634420	1.7/16	215	17,5	76	640	5	017441	41,95
00810634520	1.1/2	215	17,5	76	630	5	017458	41,95
00810634620	1.9/16	235	18,5	86	910	5	017465	51,60
00810634720	1.5/8	235	18,5	86	900	5	017472	51,60
00810634820	1.11/16	235	18,5	86	890	5	017489	51,60
00810634920	1.3/4	235	18,5	86	870	5	017496	68,20
00810635020	1.13/16	255	20,0	98	1400	3	017502	68,20
00810635120	1.7/8	255	20,0	98	1390	3	017519	68,20
00810638020	1.15/16	275	21,0	105	1590	3	017809	77,95
00810635220	2	275	21,0	105	1600	3	017526	77,95
00810635320	2.1/16	275	21,0	105	1550	3	017533	77,95
00810635420	2.1/8	275	21,0	105	1500	3	017540	91,90
00810635520	2.3/16	300	23,0	116	2100	3	017557	91,90
00810635620	2.1/4	300	23,0	116	2050	3	017564	91,90
00810635720	2.5/16	300	23,0	116	2000	3	017571	99,75
00810635820	2.3/8	320	24,5	128	2600	1	017588	99,75
00810635920	2.7/16	320	24,5	128	2550	1	017595	99,75
00810636020	2.1/2	320	24,5	128	2500	1	017601	129,00
00810636120	2.9/16	342	27,0	138	3400	1	017618	129,00
00810636220	2.5/8	342	27,0	138	3350	1	017625	129,00
00810639520	2.11/16	375	30,0	154	4250	1	017878	166,85
00810636320	2.3/4	375	30,0	154	4200	1	017632	166,85
00810636420	2.13/16	375	30,0	154	4150	1	017649	166,85
00810638320	2.7/8	375	30,0	154	4100	1	017830	166,85
00810636520	2.15/16	375	30,0	154	4100	1	017656	166,85
00810636620	3	375	30,0	154	4050	1	017663	177,05
00810636720	3.1/8	408	34,0	174	6250	1	017670	222,75
00810636820	3.1/4	408	34,0	174	6150	1	017687	222,75
00810636920	3.3/8	408	34,0	174	6050	1	017694	242,45
00810637020	3.1/2	445	38,0	194	7950	1	017700	312,15
00810637120	3.5/8	445	38,0	194	7850	1	017717	312,15
00810637220	3.3/4	445	38,0	194	7700	1	017724	323,35
00810637320	3.7/8	485	44,0	215	11250	1	017731	485,95
00810637420	4	485	44,0	215	11150	1	017748	485,95
00810637520	4.1/8	485	44,0	215	10800	1	017755	551,20
00810637620	4.1/4	510	47,0	235	13200	1	017762	602,95
00810639620	4.3/8	510	47,0	235	13000	1	017885	602,95
00810637720	4.1/2	510	47,0	235	12700	1	017779	699,25
00810637820	4.5/8	510	47,0	235	12650	1	017786	715,60
00810638120	4.3/4	545	50,0	255	17700	1	017816	715,60
00810639720	4.7/8	545	50,0	255	17450	1	017892	813,55
00810638220	5	545	50,0	255	17400	1	017823	813,55
00810637920	5.1/4	575	55,0	275	18750	1	017793	1.095,65
00810638620	5.1/2	575	55,0	275	18300	1	017847	1.189,35
00810638720	5.5/8	640	60,0	305	28400	1	017854	1.651,15
00810639020	6	640	60,0	305	27900	1	017861	1.814,70

820

Schlag-Ringschlüssel

DIN 7444

L = lackiert

Andere Größen auf Anfrage

Slogging ring wrenches

DIN 7444

L = lacquered

Other sizes on request

Clés polygonales à frapper

DIN 7444

L = laquées

D'autres dimensions sur demande

Llaves de golpe, de una boca estrella

DIN 7444

L = barnizado

Otros tamaños sobre pedido

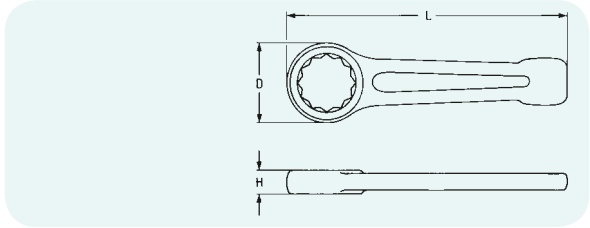

Code	MM	←L→ mm	H mm	D mm	g		EAN	€
00820002420	24	165	15,0	43	260	5	018028	24,80
00820002720	27	180	16,0	46	280	5	018035	30,65
00820003020	30	190	17,0	52	420	5	018042	35,95
00820003220	32	190	17,0	52	400	5	018059	36,90
00820003620	36	205	18,0	58	540	5	018066	46,75
00820003820	38	205	19,0	59	530	5	018073	52,95
00820004120	41	230	20,0	66	700	5	018080	61,35
00820004620	46	240	22,0	74	900	3	018097	65,80
00820005020	50	255	24,0	80	1150	3	018103	75,90
00820005520	55	270	25,0	86	1380	3	018110	85,20
00820006020	60	280	26,0	93	1540	1	018127	91,15
00820006520	65	300	30,0	102	2100	1	018134	120,40
00820007020	70	330	33,0	110	2850	1	018141	135,05
00820007520	75	330	33,0	110	2700	1	018158	143,65
00820008020	80	360	36,0	126	3900	1	018165	216,70
00820008520	85	360	36,0	126	3700	1	018172	251,10
00820009020	90	390	40,0	142	5150	1	018189	324,20
00820009520	95	390	40,0	142	4900	1	018196	345,80
00820010020	100	420	45,0	155	6450	1	018202	391,20
00820010520	105	420	45,0	155	6200	1	018219	433,50
00820011020	110	450	48,0	170	8000	1	018226	495,35
00820011520	115	450	48,0	170	7750	1	018233	546,90
00820012020	120	480	54,0	182	9500	1	018240	846,25
00820012520	125	480	54,0	182	9250	1	018257	1.086,15
00820013020	130	520	58,0	202	13200	1	018264	1.186,00
00820013520	135	520	58,0	202	12800	1	018271	1.232,50
00820014020	140	520	58,0	210	12500	1	018288	1.432,10
00820014520	145	580	64,0	228	18800	1	018295	1.875,75
00820015020	150	580	64,0	228	18500	1	018301	2.002,20
00820015520	155	580	64,0	228	18200	1	018318	2.145,10
00820016020	160	580	64,0	240	17800	1	018325	2.206,05
00820016520	165	650	70,0	265	28600	1	018332	2.359,10
00820017020	170	650	70,0	265	28000	1	018349	2.877,70
00820017520	175	650	70,0	265	27400	1	018356	3.127,90
00820018020	180	650	70,0	265	27000	1	018363	3.455,70
00820018520	185	700	75,0	290	34000	1	018370	3.572,65
00820019020	190	700	75,0	290	33000	1	018387	3.852,10
00820019520	195	700	75,0	290	32000	1	018394	3.928,55
00820020020	200	700	75,0	290	31000	1	018400	3.996,65
00820021020	210	750	80,0	320	39000	1	018417	4.250,30
00820022020	220	750	80,0	320	37000	1	018424	5.368,50
00820023020	230	750	80,0	320	35000	1	018431	6.595,70

Code	AF	←L→ mm	H mm	D mm	g		EAN	€
00820633420	7/8	165	15,0	43	240	5	018448	26,95
00820633720	1	165	15,0	43	250	5	018462	29,65
00820633820	1.1/16	180	16,0	46	280	5	018479	36,85
00820633920	1.1/8	180	16,0	46	275	5	018486	36,85
00820634020	1.3/16	190	17,0	52	420	5	018493	43,10
00820634120	1.1/4	190	17,0	52	400	5	018509	44,30
00820634220	1.5/16	190	17,0	52	390	5	018516	44,30
00820634320	1.3/8	205	18,0	58	550	5	018523	55,95
00820634420	1.7/16	205	18,0	58	540	5	018530	55,95
00820634520	1.1/2	205	18,0	58	530	5	018547	55,95
00820634620	1.9/16	230	20,0	66	710	5	018554	73,65
00820634720	1.5/8	230	20,0	66	700	5	018561	73,65
00820634820	1.11/16	230	20,0	66	690	5	018578	73,65
00820634920	1.3/4	240	22,0	74	910	3	018585	79,00
00820635020	1.13/16	240	22,0	74	900	3	018592	79,00
00820635120	1.7/8	240	22,0	74	890	3	018608	79,00
00820638020	1.15/16	255	24,0	80	1160	3	018899	91,15

820

Schlag-Ringschlüssel

DIN 7444
L = lackiert
Andere Größen auf Anfrage

Slogging ring wrenches

DIN 7444
L = lacquered
Other sizes on request

Clés polygones à frapper

DIN 7444
L = laquées
D'autres dimensions sur demande

Llaves de golpe, de una boca estrella

DIN 7444
L = barnizado
Otros tamaños sobre pedido

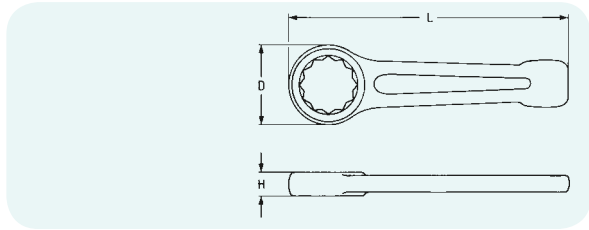

Code	AF	←L→ mm	H mm	D mm	g		EAN	€
00820635220	2	255	24,0	80	1140	3	018615	91,15
00820635320	2.1/16	255	24,0	80	1130	3	018622	91,15
00820635420	2.1/8	270	25,0	86	1390	3	018639	102,25
00820635520	2.3/16	270	25,0	86	1375	3	018646	102,25
00820635620	2.1/4	270	25,0	86	1370	3	018653	108,30
00820635720	2.5/16	280	26,0	93	1550	1	018660	108,30
00820635820	2.3/8	280	26,0	93	1540	1	018677	108,30
00820635920	2.7/16	280	26,0	93	1530	1	018684	108,30
00820636020	2.1/2	280	26,0	93	1520	1	018691	143,65
00820636120	2.9/16	300	30,0	102	2100	1	018707	143,65
00820636220	2.5/8	300	30,0	102	2080	1	018714	143,65
00820639520	2.11/16	300	30,0	102	2050	1	019001	143,65
00820636320	2.3/4	330	33,0	110	2850	1	018721	161,70
00820636420	2.13/16	330	33,0	110	2820	1	018738	161,70
00820638320	2.7/8	330	33,0	110	2800	1	018929	161,70
00820636520	2.15/16	330	33,0	110	2700	1	018745	174,55
00820636620	3	330	33,0	110	2680	1	018752	174,55
00820636720	3.1/8	360	36,0	126	3910	1	018769	259,80
00820636820	3.1/4	360	36,0	126	3890	1	018776	259,80
00820636920	3.3/8	360	36,0	126	3690	1	018783	300,10
00820637020	3.1/2	390	40,0	142	5170	1	018790	388,70
00820637120	3.5/8	390	40,0	142	5130	1	018806	388,70
00820637220	3.3/4	390	40,0	142	4900	1	018813	415,45
00820637320	3.7/8	420	45,0	155	6480	1	018820	468,65
00820637420	4	420	45,0	155	6430	1	018837	468,65
00820637520	4.1/8	420	45,0	155	6200	1	018844	521,10
00820637620	4.1/4	450	48,0	170	8050	1	018851	593,40
00820639620	4.3/8	450	48,0	170	7980	1	019018	594,20
00820637720	4.1/2	450	48,0	170	7780	1	018868	657,15
00820637820	4.5/8	450	48,0	170	7750	1	018875	657,15
00820638120	4.3/4	480	54,0	182	9500	1	018905	1.015,70
00820639720	4.7/8	480	54,0	182	9220	1	019025	1.303,65
00820638220	5	480	54,0	182	9200	1	018912	1.303,65
00820638420	5.1/8	520	58,0	202	13200	1	018936	1.422,55
00820637920	5.1/4	520	58,0	202	12830	1	018882	1.479,30
00820638520	5.3/8	520	58,0	202	12790	1	018943	1.479,30
00820638620	5.1/2	520	58,0	210	12950	1	018950	1.718,50
00820638720	5.5/8	580	64,0	228	18850	1	018967	2.250,65
00820638820	5.3/4	580	64,0	228	18780	1	018974	2.250,65
00820638920	5.7/8	580	64,0	228	18520	1	018981	2.402,10
00820639020	6	580	64,0	228	18450	1	018998	2.402,10

840

Zug-Ringschlüssel

Chrom-Vanadium
C = verchromt
schwere Ausführung, gekröpft,
zu verwenden mit Aufsteckrohr
HEYCO 845
Andere Größen auf Anfrage

Single ended ring
wrenches

Chrome-Vanadium
C = chromium plated
heavy duty pattern, offset,
to be used with tubular handles
HEYCO 845
Other sizes on request

Clés polygonales contre-
coudées gros effort

Chrome-Vanadium
C = chromées
modèle lourd, coudées,
à utiliser avec rallonge HEYCO 845
D'autres dimensions sur demande

Llave de estrella acodada,
de una boca

Cromo Vanadio
C = cromado
modelo pesado, acodado,
para usar con mango tubular HEYCO 845
Otros tamaños sobre pedido

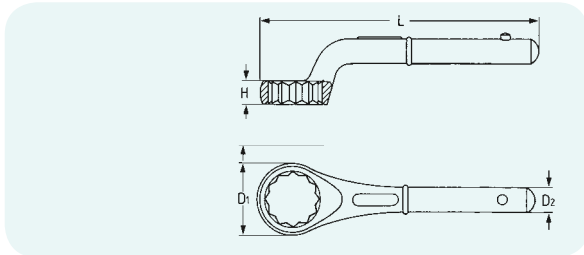

Code	ØMM	←L→ mm	H mm	D ₁ mm	D ₂ mm	für/for	g	g	EAN	€
00840002280	22	180	17,0	38		845-0	440	5	019209	36,90
00840002480	24	180	17,0	38	18,5	845-0	420	5	019216	36,90
00840002780	27	190	17,0	41		845-0	450	5	019223	38,05
00840003080	30	200	18,0	48		845-0	520	5	019230	41,40
00840003280	32	235	18,0	49		845-1	750	5	019247	44,85
00840003680	36	245	20,0	54	21,5	845-1	840	5	019254	50,85
00840004180	41	265	22,0	62		845-1	1000	5	019261	60,70
00840004680	46	280	23,0	69		845-2	1200	3	019278	71,80
00840005080	50	290	25,5	76	24,5	845-2	1400	3	019285	82,00
00840005580	55	300	28,0	81		845-2	1500	3	019292	90,30
00840006080	60	345	30,5	90		845-3	2300	1	019308	116,15
00840006580	65	355	33,0	98		845-3	2700	1	019315	130,70
00840007080	70	365	35,5	105		845-3	2800	1	019322	148,00
00840007580	75	375	38,0	110		845-3	3100	1	019339	166,85
00840008080	80	385	40,5	125	29,5	845-3	3800	1	019346	186,55
00840008580	85	385	40,5	125		845-3	3600	1	019353	192,75
00840009080	90	410	45,0	140		845-3	5100	1	019360	342,25
00840009580	95	410	45,0	140		845-3	4800	1	019377	371,55
00840010080	100	412	45,0	143		845-3	4900	1	019384	402,45

845

Aufsteckrohre

Z = verzinkt
für Zug-Ringschlüssel HEYCO 840

Tubular handles

Z = zinc plated
for single ended ring wrenches
HEYCO 840

Rallonges

Z = galvanisé, bleu passivé
pour clés polygonales HEYCO 840

Mangos tubulares

Z = cincado, cromatizado azul
para llaves de estrella acodadas, de una
boca HEYCO 840



Code	No.	für/for HEYCO 840	←L→ mm	Ø innen/inside mm	g	g	EAN	€
00845000060	845-0	22-30 mm	460	19	625	5	146349	29,15
00845000160	845-1	32-41 mm	610	22	1125	1	146356	36,55
00845000260	845-2	46-55 mm	760	25	2150	1	146363	58,45
00845000360	845-3	60-100 mm	860	30	2875	1	146370	71,25





1/4 36 – 45



3/8 46 – 57



1/2 58 – 81



3/4 82 – 84

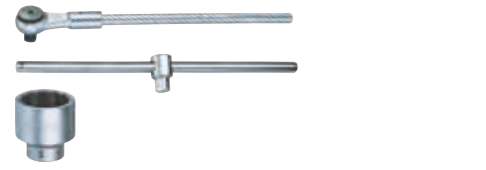

1 85



86



3/8 1/2 87 – 90



IMPACT 1/2 3/4 1 91 – 101



1/4 3/8 1/2 102 – 111



3/8 1/2 3/4



$\frac{1}{4}$ " 25-00-15

$\frac{3}{8}$ " 40-00-10

$\frac{3}{8}$ " 40-00-15

$\frac{1}{2}$ " 50-00-10

$\frac{1}{2}$ " 50-00-15



Perfektion im Detail

- Auslöseknopf sorgt für leichtes Aufstecken und Abziehen der Steckschlüsseinsätze
- Kugelarretierung sorgt für sicheren Halt während der Anwendung
- Profilierter Schalthebel für Rechts-/Linkslauf, abrutschsicher
- Kupplungsrad verhindert bei leichtgängigen Schraubverbindungen eine ungewollte Drehbewegung
- Kraftvolles Design des Schaftes, ausgelegt für höchste Beanspruchung
- 2-Komponenten-Griff mit besonderer Haptik für ermüdungsfreies Arbeiten
- Aufhängeloch dient der übersichtlichen Aufbewahrung
- Feinverzahnung mit bis zu 72 Zähnen, garantiert einen kleinen Schwenkwinkel
- Modulare Bauweise für einfache Wartung und Pflege

Perfection in detail

- Release button for effortless mounting and removal of the sockets
- Ball stop for reliable locking during operation
- Molded shift lever for clockwise-/ anticlockwise operation, slip proof
- Turning-/retaining (SDR-) wheel prevents unwanted rotary motion on free-moving bolted connections
- Powerful design of the shaft made for highest demands
- 2K-handle with special ergonomics allows fatigue-free working
- Pin hole for a clearly arranged storage
- Fine gearing with up to 72 teeth ensures a small swivel angle
- Modular construction for easy maintenance

Evolution eines Dauerläufers für höchste Ansprüche

Evolution of a durator for highest demands



La perfection en détail

- Un bouton de déverrouillage permet l'assemblage ou le retrait facile de la douille de tournevis
- Le verrouillage à bille assure une bonne prise en main lors de l'utilisation
- Levier profilé pour marche avant/marche arrière, empêche le glissement
- Le levier empêche le mouvement indésiré de vis lisse
- La tige a été conçue pour une charge maximale
- Poignée à 2 composants - ergonomie spéciale pour pouvoir travailler sans fatigue
- Un trou de montage permet un rangement propre et utile
- Une denture fine ayant jusqu'à 72 dents assure un petit angle de pivotement
- Design modulaire permet un entretien facile

La perfección del detalle

- Botón de desenganche para colocar y quitar las llaves de vaso
- Sujeción de bola para dar una sujeción segura
- Palanca perfilada para movimiento a derecha e izquierda, antideslizante
- Rueda de embrague que evita giros imprevistos en el vaso de unión ligera
- Diseño compacto del mango para máximos esfuerzos
- Mango de dos componentes, tacto especial para reducir el cansancio en el trabajo
- Agujero para colgar
- Dentado fino de hasta 72 dientes, para facilitar ángulo de giro pequeños
- Construcción modular para simplificar el mantenimiento y limpieza



25-00-10 - 25-16

1/4" Antriebs- und Verbindungsteile

DIN 3122 + 3123 / ISO 3315 + 3316

1/4" Accessories

DIN 3122 + 3123 / ISO 3315 + 3316

1/4" Accessoires

DIN 3122 + 3123 / ISO 3315 + 3316

1/4" Accesorios

DIN 3122 + 3123 / ISO 3315 + 3316

Code	No.	Ausf. finish					←L→ mm	g		EAN	€
00025010583	25-00-15	CPP	Hebelumschaltknarre VARICAT NEU	Reversible ratchet VARICAT NEW	Cliquet réversible à levier VARICAT NOUVEAU	Carraca reversible VARICAT NUEVO	140	96	1	404272	43,85
00025011080	25-01-1	C	Durchsteckknarre	Ratchet, push-thru type	Cliquet	Carraca de cuadrillo pasante	150	80	10	000337	26,20
00025030083	25-03	CPP	Griff mit Gleitstück	Sliding T-handle	Poignée coulissante	Mango corredizo	114	40	10	000351	7,85
00025040083	25-04	CPP	Verlängerung	Extension bar	Rallonge	Alargadera	55	24	10	000375	5,70
00025050083	25-05	CPP	Verlängerung	Extension bar	Rallonge	Alargadera	105	45	10	000382	6,05
00025051083	25-05-1	CPP	Verlängerung	Extension bar	Rallonge	Alargadera	150	65	10	000399	6,30
00025055083	25-05-5	CPP	Schwenkbare Verlängerung	Wobble extension	Rallonge articulée	Alargadera oscilante	100	45	10	112849	7,90
00025060083	25-06	CPP	Kardangelenk	Universal joint	Cardan universel	Articulación universal	35	23	10	000405	17,45
00025070083	25-07	CPP	Gelenkgriff	Swivel handle	Poignée articulée	Mango articulado	155	115	10	000412	18,00
00025080083	25-08	CPP	Steckgriff	Spinner handle	Rallonge emmanchée	Mango recto	145	60	10	000429	8,30
00025110080	25-11	C	Biegsame Verlängerung	Flexible extension	Rallonge flexible	Alargadera flexible	120	50	10	113846	13,85
00025150083	25-15	CPP	Verbindungsstück	Converter	Augmentateur	Amplificador	27	17	10	000559	7,30
00025160083	25-16	CPP	Verbindungsvierkant	Square coupler	Carré conducteur	Adaptador	20	6	10	000566	2,85
06101003080	6101-30	C	Verbindungsstück	Converter	Augmentateur	Amplificador	25	20	10	118452	1,60



25-00-15 · 72 Zähne/teeth · DIN 3122 D · ISO 3315



25-06 · DIN 3123 C · ISO 3316



25-01-1 · 20 Zähne/teeth · DIN 3122 C · ISO 3315



25-07 · DIN 3122 F · ISO 3315



25-03 · DIN 3122 A · ISO 3315



25-08 · DIN 3122 E · ISO 3315



25-04 · DIN 3123 B · ISO 3316



25-11 · ~ DIN 3123 B · ISO 3316



25-05 · DIN 3123 B · ISO 3316



25-15 · DIN 3123 A · ISO 3316



25-16 · DIN 3122 CV · ISO 3315



25-05-1 · DIN 3123 B · ISO 3316

Chrom-Vanadium
C = verchromt
CPP = verchromt, ganz poliert
mit Kugel-Arretierung

Chrome-Vanadium
C = chromium plated
CPP = chromium plated, fully polished
with spring-loaded retaining ball



25-05-5



6101-30 Verbindungsstück für Bits 1/4"/connector for bits 1/4"

25-6

Steckschlüssel-Einsätze

DIN 3124 / ISO 2725
 Chrom-Vanadium
 CPP = verchromt, ganz poliert
 mit Kugelfangrinne

Sockets

DIN 3124 / ISO 2725
 Chrome-Vanadium
 CPP = chromium plated, fully
 polished, with ball retaining groove

Douilles

DIN 3124 / ISO 2725
 Chrome-Vanadium
 CPP = chromées, entièrement polies
 avec gorge de verrouillage pour bille

Llaves de vaso

DIN 3124 / ISO 2725
 Cromo Vanadio
 CPP = cromado, cabeza pulida espejo
 con ranura de retención por bola

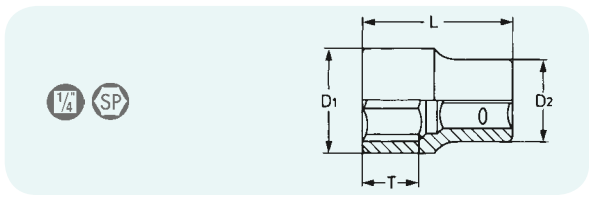

Code	MM	L mm	D ₁ mm	D ₂ mm	T mm	g	g	EAN	€
00025000483	4	25	6,8	11,8	6,5	9	10	000177	3,60
00025004583	4,5	25	7,3	11,8	7,5	9	10	000283	3,70
00025000583	5	25	7,9	11,8	7,5	10	10	000184	3,60
00025005583	5,5	25	8,5	11,8	8,0	10	10	000290	3,70
00025000683	6	25	9,2	11,8	8,0	10	10	000191	3,60
00025000783	7	25	10,5	11,8	8,0	11	10	000207	3,60
00025000883	8	25	11,8	11,8	8,0	11	10	000214	3,60
00025000983	9	25	13,4	12,0	8,0	13	10	000221	3,75
00025001083	10	25	14,0	12,0	8,0	13	10	000238	3,75
00025001183	11	25	15,8	12,5	10,0	15	10	000245	3,75
00025001283	12	25	17,2	13,5	10,0	18	10	000252	3,85
00025001383	13	25	18,0	13,5	11,0	18	10	000269	3,85
00025001483	14	25	19,5	14,5	12,0	22	10	000276	3,85

Code	AF	L mm	D ₁ mm	D ₂ mm	T mm	g	g	EAN	€
00025630583	1/8	25	6,4	11,8	4,0	9	10	001020	3,75
00025630783	5/32	25	6,8	11,8	6,5	9	10	001037	3,75
00025630883	3/16	25	7,8	11,8	7,5	10	10	001044	3,75
00025631083	7/32	25	8,7	11,8	8,0	10	10	001051	3,85
00025631283	1/4	25	9,8	11,8	8,0	10	10	001068	3,85
00025631483	9/32	25	10,7	11,8	8,0	11	10	001075	3,85
00025631683	5/16	25	11,8	11,8	8,0	11	10	001082	3,85
00025631883	11/32	25	13,4	12,0	8,0	13	10	001099	3,85
00025631983	3/8	25	14,0	12,0	8,0	13	10	001105	3,85
00025632183	7/16	25	15,8	12,5	10,0	15	10	001112	4,00
00025632383	1/2	25	18,0	13,5	11,0	19	10	001129	4,00
00025632583	9/16	25	19,5	14,5	12,0	22	10	001136	4,10

25-19

Steckschlüssel-Einsätze, extra lang

DIN 3124 / ISO 2725
 Chrom-Vanadium
 CPP = verchromt, ganz poliert
 mit Kugelfangrinne

Sockets, extra deep

DIN 3124 / ISO 2725
 Chrome-Vanadium
 CPP = chromium plated, fully
 polished, with ball retaining groove

Douilles, extra longues

DIN 3124 / ISO 2725
 Chrome-Vanadium
 CPP = chromées, entièrement polies
 avec gorge de verrouillage pour bille

Llaves de vaso, extra largo

DIN 3124 / ISO 2725
 Cromo Vanadio
 CPP = cromado, cabeza pulida espejo
 con ranura de retención por bola



Code	MM	L mm	D ₁ mm	D ₂ mm	T mm	g	g	EAN	€
00025190483	4	50	6,8	11,8	11,8	17	10	365146	4,10
00025194583	4,5	50	7,0	11,8	15,3	19	10	365153	4,10
00025190583	5	50	7,8	11,8	15,8	21	10	365160	4,10
00025195583	5,5	50	8,2	11,8	15,8	21	10	365177	4,10
00025190683	6	50	9,2	11,8	17,2	22	10	365184	4,10
00025190783	7	50	10,5	11,8	20,7	23	10	365191	4,10
00025190883	8	50	11,8	11,8	20,9	25	10	365207	4,10
00025190983	9	50	12,9	12,9	21,4	29	10	365214	4,10
00025191083	10	50	14,5	14,5	21,4	35	10	365221	4,10
00025191183	11	50	15,8	15,8	21,4	42	10	365238	4,10
00025191283	12	50	16,8	16,8	25,7	45	10	365245	4,10
00025191383	13	50	17,8	17,8	25,4	52	10	365252	4,10
00025191483	14	50	19,6	19,6	30,8	52	10	365269	4,10

25-20

Steckschlüssel-Einsätze

Chrom-Vanadium
 CPP = verchromt, ganz poliert
 mit Kugelfangrinne
 für Außen-TORX®-Schrauben

Sockets

Chrome-Vanadium
 CPP = chromium plated, fully
 polished, with ball retaining groove
 for TORX®-head screws

Douilles

Chrom-Vanadium
 CPP = chromées, entièrement polies
 avec gorge de verrouillage pour bille
 pour vis TORX®-extérieures

Llaves de vaso

Cromo Vanadio
 CPP = cromado, cabeza pulida espejo
 con ranura de retención por bola
 para tornillos TORX® exteriores



Code	Größe size	mm	L mm	T mm	D ₁ mm	D ₂ mm	g	g	EAN	€
00025200483	E 4	3,86	25	5	5,4	12	9	10	000733	4,75
00025200583	E 5	4,75	25	5	6,7	12	10	10	000740	4,75
00025200683	E 6	5,74	25	5	7,7	12	10	10	000757	4,75
00025200783	E 7	6,22	25	6	8,3	12	10	10	000764	4,75
00025200883	E 8	7,52	25	7	9,6	12	11	10	000771	4,75
00025201083	E 10	9,42	25	8	11,3	12	12	10	000788	4,75

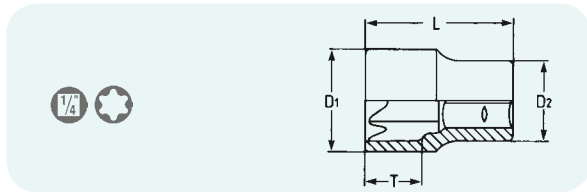

25-30 - 25-36

Schraubendreher-Einsätze

Körper:
 Chrom-Vanadium
 CPP = verchromt, ganz poliert
 mit Kugelfangrinne

Screwdriver sockets

Socket bodies:
 Chrome-Vanadium
 CPP = chromium plated, fully
 polished, with ball retaining groove

Douilles tournevis

Douilles:
 Chrome-Vanadium
 CPP = chromées, entièrement polies
 avec gorge de verrouillage pour bille

Llaves de vaso con
 destornillador

Cuerpo:
 Cromo Vanadio
 CPP = cromado, enteramente pulido
 espejo, con ranura de retención por bola

Bits:
 Sonderstahl
 PH = phosphatiert

Bits:
 Special steel
 PH = phosphated

Embouts:
 Acier Spécial
 PH = phosphaté

Puntas:
 Acero aleado
 PH = fosfatado



25-30 für Schlitz-Schrauben/for plain slot screws

Code	mm	mm	L ₁ mm	L ₂ mm	D ₁ mm	D ₂ mm	g	g	EAN	€
00025300183	3	0,5	34,5	15	12	11	13	10	000795	5,70
00025300283	3,5	0,6	34,5	15	12	11	13	10	000801	5,70
00025300383	4	0,8	34,5	15	12	11	13	10	000818	5,70
00025300483	5,5	1,0	34,5	15	12	11	14	10	000825	5,70
00025300583	6,5	1,2	34,5	15	12	11	15	10	000832	5,70
00025300683	8	1,2	34,5	15	12	11	15	10	094343	5,70

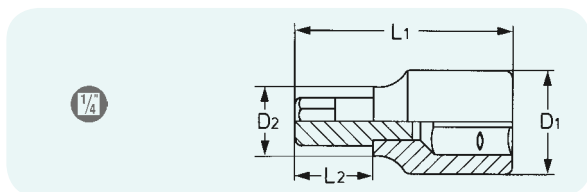

25-31 für Innensechskant-Schrauben/for hexagon socket screws, DIN 7422/ISO 1174

Code	MM	L ₁ mm	L ₂ mm	D ₁ mm	D ₂ mm	g	g	EAN	€
00025310183	3	34,5	15	12	11	13	10	000849	5,70
00025310283	4	34,5	15	12	11	14	10	000856	5,70
00025310383	5	34,5	15	12	11	15	10	000863	5,70
00025310483	6	34,5	15	12	11	15	10	000870	5,70
00025310583	8	34,5	15	12	11	18	10	000887	5,70

Code	AF	L ₁ mm	L ₂ mm	D ₁ mm	D ₂ mm	g	g	EAN	€
00025313083	1/8	34,5	15	12	11	13	10	094558	5,70
00025313183	5/32	34,5	15	12	11	14	10	094565	5,70
00025313283	3/16	34,5	15	12	11	14	10	094572	5,70
00025313383	7/32	34,5	15	12	11	15	10	094589	5,70
00025313483	1/4	34,5	15	12	11	16	10	094596	5,70
00025313683	5/16	34,5	15	12	11	18	10	094602	5,70

25-30 - 25-36

Schraubendreher-Einsätze

Screwdriver sockets

Körper:
Chrom-Vanadium
CPP = verchromt, ganz poliert
mit Kugelfangrinne

Socket bodies:
Chrome-Vanadium
CPP = chromium plated, fully
polished, with ball retaining groove

Bits:
Sonderstahl
PH = phosphatiert

Bits:
Special steel
PH = phosphated

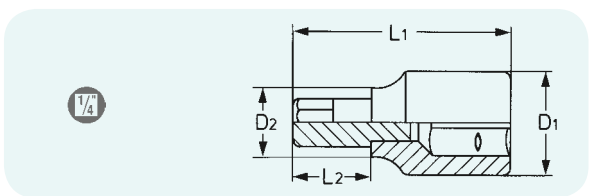

Douilles tournevis

Douilles:
Chrom-Vanadium
CPP = chromées, entièrement polies
avec gorge de verrouillage pour bille

Embout:
Acier Spécial
PH = phosphaté

Llaves de vaso con destornillador

Cuerpo:
Cromo Vanadio
CPP = cromado, enteramente pulido
espejo, con ranura de retención por bola

Puntas:
Acero aleado
PH = fosfatado

25-32 für Kreuzschlitz-Schrauben/for cross slot screws PHILLIPS-RECESS

Code	No.	L ₁ mm	L ₂ mm	D ₁ mm	D ₂ mm			EAN	€
00025320183	1	34,5	15	12	11	13	10	000894	5,70
00025320283	2	34,5	15	12	11	14	10	000900	5,70
00025320383	3	34,5	15	12	11	15	10	000917	5,70
00025320483	4	34,5	15	12	11	17	10	000924	5,70

25-35 für Kreuzschlitz-Schrauben/for cross slot screws POZIDRIV®

Code	No.	L ₁ mm	L ₂ mm	D ₁ mm	D ₂ mm			EAN	€
00025350183	1	34,5	15	12	11	13	10	094473	5,70
00025350283	2	34,5	15	12	11	14	10	094480	5,70
00025350383	3	34,5	15	12	11	15	10	094497	5,70
00025350483	4	34,5	15	12	11	17	10	094503	5,70

25-36 für Innen-TORX®-Schrauben/for TORX®-socket screws

Code	Größe size	mm	L ₁ mm	L ₂ mm	D ₁ mm	D ₂ mm			EAN	€
00025360683	T 6	1,67	34,5	15	12	11	13	10	094527	6,40
00025360783	T 7	1,99	34,5	15	12	11	13	10	094510	6,40
00025360883	T 8	2,31	34,5	15	12	11	13	10	000931	6,40
00025360983	T 9	2,50	34,5	15	12	11	13	10	000948	6,40
00025361083	T 10	2,74	34,5	15	12	11	13	10	000955	6,40
00025361583	T 15	3,27	34,5	15	12	11	14	10	000962	6,40
00025362083	T 20	3,86	34,5	15	12	11	14	10	000979	6,40
00025362583	T 25	4,43	34,5	15	12	11	14	10	000986	6,40
00025362783	T 27	4,99	34,5	15	12	11	14	10	094534	6,40
00025363083	T 30	5,52	34,5	15	12	11	15	10	000993	6,40
00025364083	T 40	6,65	34,5	15	12	11	15	10	094541	6,40

25-50

Satz mit Schraubendreher- und Steckschlüssel-Einsätzen

Combined set of sockets and screwdriver sockets

Compositions de douilles et de douilles-tournevis

Juegos de llaves de vaso con destornillador

Chrom-Vanadium
CPP = verchromt, ganz poliert
Metallkasten 174 x 81 x 31 mm

Chrome-Vanadium
CPP = chromium plated, fully polished
Metal case 174 x 81 x 31 mm

Chrom-Vanadium
CPP = chromées, entièrement polies
Coffret métallique 174 x 81 x 31 mm

Cromo Vanadio
CPP = cromado, enteramente pulido
Caja metálica 174 x 81 x 31 mm



für TORX®-Schrauben/for TORX®-screws

Code	No.	tlg./pcs.			EAN	€
00025500083	25-50-E/T	17	515	1	125337	106,95

enthaltend/containing			
Stck./pcs.	Artikel/article	No.	Maße/dimensions
6		25-20	E 4 E 5 E 6 E 7 E 8 E 10
11		25-36	T 6 T 7 T 8 T 9 T 10 T 15 T 20 T 25 T 27 T 30 T 40

1/4"

25-70

Steckschlüssel-Einsätze auf Aluminium-Klemmleiste, 13-tlg.

Aluminium-Klemmleiste grün eloxiert.
Chrom-Vanadium
CPP = verchromt, ganz poliert
mit Kugelfangrinne

Sockets on aluminium socket rail, 13 pcs.

Aluminium socket rail, anodized.
Chrome-Vanadium
CPP = chromium plated, fully polished, with ball retaining groove

Assortiment douilles sur bande alu, 13 pcs.

Bloc aluminium anodisé.
Chrome-Vanadium
CPP = chromées, entièrement polies avec gorge de verrouillage pour bille

Juego de 13 llaves de vaso en regla de sujeción de aluminio

Regla de sujeción, de aluminio anodizado color verde.
Cromo Vanadio
CPP = cromado, cabeza pulida espejo con ranura de retención por bolae

1/4" SP

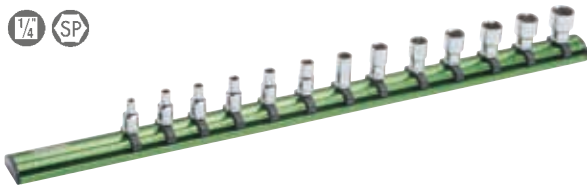

Code	No.	tlg./pcs.			EAN	€
00025700083	25-70-M	13	465	1	366716	84,75

enthaltend/containing			
Stck./pcs.	Artikel/article	No.	Maße/dimensions
13		25-70-M	MM 4 4,5 5 5,5 6 7 8 9 10 11 12 13 14

987-25

Aluminium-Klemmleiste, leer

zur Aufnahme von max. 13 Einsätzen
Kugelgefederter Aufnahme gewähr-
leistet perfekten Halt der Einsätze.
Sicherer Halt der Klemmleiste durch
Magnet an Metallflächen.

Aluminium socket rail,
empty

for max. 13 sockets
Spring-loaded retaining ball
ensures a perfect hold of the
sockets. A strong magnet securely
holds the socket rail to ferrous metal.

Bornes en aluminium, vide

pour max. 13 inserts
Les billes à ressort assurent une parfaite
prise en main.
Blocage des bornes dues aux aimants et les
surfaces métalliques.

Regla de aluminio anodizado
color verde

para sujeción de 13 llaves de vaso
Sujeción con muelle, garantiza una firme
colocación de los vasos.
Regla sujeta por imán.

1/4"

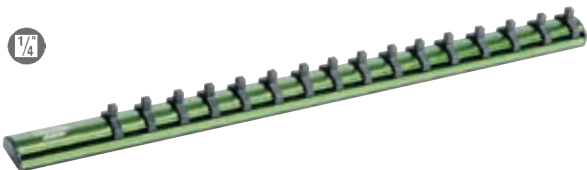

Code	No.	tlg./pcs.			EAN	€
98710251600	987-25	1	253	1	365276	35,65

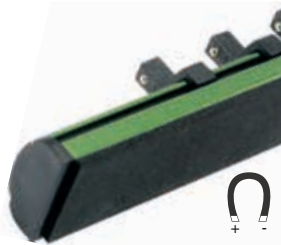

27-3010 - 27-90

Steckschlüssel-Garnituren

Chrom-Vanadium
 CPP = verchromt,
 ganz poliert
 Metallkasten 174 x 81 x 31 mm

Socket sets

Chrome-Vanadium
 CPP = chromium plated,
 fully polished
 Metal case 174 x 81 x 31 mm

Compositions de douilles

Chrom-Vanadium
 CPP = chromées,
 entièrement polies
 Coffret métallique 174 x 81 x 31 mm

Juegos de llaves de vaso

Cromo Vanadio
 CPP = cromado,
 enteramente pulido espejo
 Caja metálica 174 x 81 x 31 mm



Code	No.	tlg./pcs.			EAN	€
00027301083	27-3010-M	17	700	1	099683	130,65

enthaltend/containing			
Stck./pcs.	Artikel/article	No.	Maße/dimensions
12	SP	25-6	MM 4 4,5 5 5,5 6 7 8 9 10 11 12 13
1		25-00-15	140 mm
1		25-03	115 mm
1		25-05	100 mm
1		25-06	35 mm
1		25-08	145 mm

Code	No.	tlg./pcs.			EAN	€
00027800083	27-80-M	17	690	1	001242	112,35

wie/as 27-3010-M, jedoch/but			
Stck./pcs.	Artikel/article	No.	Maße/dimensions
1		25-01-1	150 mm

Code	No.	tlg./pcs.			EAN	€
00027401083	27-4010-AF	17	690	1	099690	132,85

wie/as 27-3010-M, jedoch/but			
Stck./pcs.	Artikel/article	No.	Maße/dimensions
12	SP	25-6	AF 1/8 5/32 3/16 7/32 1/4 9/32 5/16 11/32 3/8 7/16 1/2 9/16

Code	No.	tlg./pcs.			EAN	€
00027900083	27-90-AF	17	690		001266	113,50

wie/as 27-3010-M, jedoch/but			
Stck./pcs.	Artikel/article	No.	Maße/dimensions
12	SP	25-6	AF 1/8 5/32 3/16 7/32 1/4 9/32 5/16 11/32 3/8 7/16 1/2 9/16
1		25-01-1	150 mm

1/4"

27-3510

Steckschlüssel-Garnitur

Chrom-Vanadium
 CPP = verchromt,
 ganz poliert
 Metallkasten 225 x 115 x 38 mm

Socket set

Chrome-Vanadium
 CPP = chromium plated,
 fully polished
 Metal case 225 x 115 x 38 mm

Compositions de douilles

Chrome-Vanadium
 CPP = chromées,
 entièrement polies
 Coffret métallique 225 x 115 x 38 mm

Juegos de llaves de vaso

Cromo Vanadio
 CPP = cromado,
 enteramente pulido espejo
 Caja metálica 225 x 115 x 38 mm

1/4" SP



Code	No.	tlg./pcs.	g		EAN	€
00027351083	27-3510-M	18	960	1	096736	137,25

enthaltend/containing			
Stck./pcs.	Artikel/article	No.	Maße/dimensions
12		25-6	MM 4 4,5 5 5,5 6 7 8 9 10 11 12 13
1		25-00-15	140 mm
1		25-03	115 mm
1		25-04	50 mm
1		25-05-1	150 mm
1		25-06	35 mm
1		25-08	145 mm

29-3010

Steckschlüssel-Garnitur

Chrom-Vanadium
 CPP = verchromt,
 ganz poliert
 Metallkasten 320 x 120 x 38 mm

Socket set

Chrome-Vanadium
 CPP = chromium plated,
 fully polished
 Metal case 320 x 120 x 38 mm

Compositions de douilles

Chrom-Vanadium
 CPP = chromées,
 entièrement polies
 Coffret métallique 320 x 120 x 38 mm

Juegos de llaves de vaso

Cromo Vanadio
 CPP = cromado,
 enteramente pulido espejo
 Caja metálica 320 x 120 x 38 mm

1/4" SP



Code	No.	tlg./pcs.	g		EAN	€
00029301083	29-3010-M	29	1349	1	099706	198,80

enthaltend/containing			
Stck./pcs.	Artikel/article	No.	Maße/dimensions
12		25-6	MM 4 4,5 5 5,5 6 7 8 9 10 11 12 13
2		25-30	5,5 6,5 mm
5		25-31	MM 3 4 5 6 8
4		25-32	PH No. 1 2 3 4
1		25-00-15	140 mm
1		25-03	115 mm
1		25-04	50 mm
1		25-05	100 mm
1		25-06	35 mm
1		25-08	145 mm

30-3010

Kombinierte Steckschlüssel-Garnitur

Chrom-Vanadium
 CPP = verchromt,
 ganz poliert
 Metallkasten 407 x 162 x 52 mm

Combined set of Sockets

Chrome-Vanadium
 CPP = chromium plated,
 fully polished
 Metal case 407 x 162 x 52 mm

Compositions de douilles

Chrom-Vanadium
 CPP = chromées,
 entièrement polies
 Coffret métallique 407 x 162 x 52 mm

Juegos combinados de llaves de vaso

Cromo Vanadio
 CPP = cromado,
 enteramente pulido espejo
 Caja metálica 407 x 162 x 52 mm



Code	No.	tlg./pcs.			EAN	€
00030301083	30-3010-M	49	3265	1	114003	372,70

enthaltend/containing			
Stck./pcs.	Artikel/article	No.	Maße/dimensions
8	SP	25-6	MM 4 4,5 5 5,5 6 7 8 9
1		25-00-15	140 mm
1		25-05	100 mm
1		25-06	35 mm
1		25-08	145 mm
12	SP	40-6	MM 10 11 12 13 14 15 16 17 18 19 21 22
1		40-00-10	200 mm
1		40-03	200 mm
1		40-04	125 mm
1		40-05	250 mm
1		40-06	50 mm
1		40-14	25 mm
1		40-19-1	MM 20,8
1		40-19-3	AF 5/8
6		3500	3 3,5 4 5 6,5 8 mm
5		3510	MM 3 4 5 6 8
3		3520	PH No. 1 2 3
1		3530	PZ No. 2
1		6201-30	30 mm
1		6101-30	25 mm

31-1910

Steckschlüssel-Garnitur

Chrom-Vanadium
 CPP = verchromt,
 ganz poliert
 Metallkasten 320 x 120 x 38 mm

Socket set

Chrome-Vanadium
 CPP = chromium plated,
 fully polished
 Metal case 320 x 120 x 38 mm

Compositions de douilles

Chrom-Vanadium
 CPP = chromées,
 entièrement polies
 Coffret métallique 320 x 120 x 38 mm

Juegos de llaves de vaso

Cromo Vanadio
 CPP = cromado,
 enteramente pulido espejo
 Caja metálica 320 x 120 x 38 mm



Code	No.	tlg./pcs.			EAN	€
00031191083	31-1910-M	28	1688	1	366488	206,30

enthaltend/containing			
Stck./pcs.	Artikel/article	No.	Maße/dimensions
12	SP	25-6	MM 4 4,5 5 5,5 6 7 8 9 10 11 12 13
10	SP	25-19	MM 4 5 6 7 8 9 10 11 12 13
1		25-00-15	140 mm
1		25-03	114 mm
1		25-04	55 mm
1		25-05-1	150 mm
1		25-06	35 mm
1		25-08	145 mm

40-00-1 - 40-16

3/8" Antriebs- und Verbindungsteile

DIN 3122 + 3123

3/8" Accessories

DIN 3122 + 3123

3/8" Accessoires

DIN 3122 + 3123

3/8" Accesorios

DIN 3122 + 3123

Code	No.	Ausf. finish					←L→ mm	 g		EAN	€
00040011082	40-00-1	CP	Durchstecknarre	Ratchet, push-thru type	Cliquet	Carraca de cuadradillo pasante	198	190	5	001518	28,00
00040007082	40-00-7	CP	Umschaltknarre	Reversible ratchet	Cliquet réversible	Carraca reversible	198	285	5	001488	50,75
00040010083	40-00-10	CPP	Hebelumschaltknarre VARICAT NEU	Reversible ratchet VARICAT NEW	Cliquet réversible à levier VARICAT NOUVEAU	Carraca reversible VARICAT NUEVO	195	269	1	001501	49,00
00040010583	40-00-15	CPP	Hebelumschaltknarre VARICAT NEU	Reversible ratchet VARICAT NEW	Cliquet réversible à levier VARICAT NOUVEAU	Carraca reversible VARICAT NUEVO	195	269	1	404289	51,00
00040027082	40-00-27	CP	Aufsteck-Umschaltknarre	Reversible ratchet unit	Cliquet réversible adaptateur	Cabeza de carraca reversible	50	200	5	001563	36,40
00040020083	40-02	CPP	Kurbel	Speed brace	Vilebrequin	Berbiquí	304	260	5	098235	22,80
00040030083	40-03	CPP	Griff mit Gleistück	Sliding T-handle	Poignée coulissante	Mango corredizo	200	160	10	098242	13,25
00040040083	40-04	CPP	Verlängerung	Extension bar	Rallonge	Alargadera	125	90	10	098259	10,70
00040041083	40-04-1	CPP	Verlängerung	Extension bar	Rallonge	Alargadera	75	62	10	099119	9,20
00040041583	40-04-15	CPP	Schwenkbare Verlängerung	Wobble extension	Rallonge articulée	Alargadera oscilante	75	60	10	103021	8,60
00040042583	40-04-25	CPP	Schwenkbare Verlängerung	Wobble extension	Rallonge articulée	Alargadera oscilante	150	105	10	103038	11,60
00040050083	40-05	CPP	Verlängerung	Extension bar	Rallonge	Alargadera	250	165	10	098266	13,70
00040055083	40-05-5	CPP	Schwenkbare Verlängerung	Wobble extension	Rallonge articulée	Alargadera oscilante	250	165	10	103045	14,20
00040060083	40-06	CPP	Kardangelenke	Universal joint	Cardan universel	Articulación universal	50	60	10	098273	22,80
00040070083	40-07	CPP	Gelenkgriff	Swivel handle	Poignée articulée	Mango articulado	224	215	10	098280	38,40
00040140083	40-14	CPP	Verbindungsstück	Converter	Réducteur	Reductor	25	30	10	098297	8,05
00040150083	40-15	CPP	Verbindungsstück	Converter	Augmentateur	Amplificador	35	50	10	098303	8,25
00040160083	40-16	CPP	Verbindungsstück	Square coupler	Carré conducteur	Adaptador	25	15	10	098310	4,10
06201003080	6201-30	C	Verbindungsstück	Converter	Réducteur	Reductor	20	20	10	036589	4,20



40-00-1 · 30 Zähne/teeth · DIN 3122 C · ISO 3315



40-04 · DIN 3123 B · ISO 3316



40-04-1 · DIN 3123 B · ISO 3316



40-00-7 · 45 Zähne/teeth · DIN 3122 D · ISO 3315



40-04-15



40-04-25



40-00-10 · 48 Zähne/teeth · DIN 3122 D · ISO 3315



40-05 · DIN 3123 B · ISO 3316



40-05-5

40-04-15
40-04-25 =
40-05-5



40-00-15 · 72 Zähne/teeth · DIN 3122 D · ISO 3315



40-06 · DIN 3123 C · ISO 3316



40-07 · DIN 3122 F · ISO 3315



40-00-27 · 60 Zähne

40-02 · DIN 3122 B · ISO 3315



40-14 $\frac{3}{8}$ $\frac{1}{4}$ · DIN 3123 A · ISO 3316



40-15 $\frac{3}{8}$ $\frac{1}{2}$ · DIN 3123 A · ISO 3316



40-16 · DIN 3122 CV · ISO 3315



6201-30



40-03 · DIN 3122 A · ISO 3315

$\frac{3}{8}$ $\frac{3}{8}$ Chrom-Vanadium
CP = verchromt, teilweise poliert
CPP = verchromt, ganz poliert
mit Kugel-Arretierung

$\frac{3}{8}$ $\frac{3}{8}$ Chrome-Vanadium
CP = chromium plated, polished head
CPP = chromium plated, fully polished
with spring-loaded retaining ball

40-6

Steckschlüssel-Einsätze

DIN 3124 / ISO 2725
Chrom-Vanadium
CPP = verchromt, ganz poliert
mit Kugelfangrinne

Sockets

DIN 3124 / ISO 2725
Chrome-Vanadium
CPP = chromium plated, fully
polished, with ball retaining groove

Douilles

DIN 3124 / ISO 2725
Chrome-Vanadium
CPP = chromées, entièrement polies
avec gorge de verrouillage pour bille

Llaves de vaso

DIN 3124 / ISO 2725
Cromo Vanadio
CPP = cromado, cabeza pulida espejo
con ranura de retención por bola

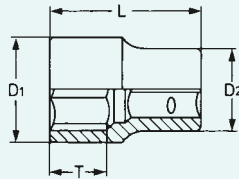

Code	MM	←L→ mm	T mm	D ₁ mm	D ₂ mm	g	g	EAN	€
00040600683	6	25,5	8,0	9,3	17,0	18	10	099058	5,65
00040600783	7	25,5	8,0	10,9	17,0	18	10	099065	5,65
00040600883	8	25,5	8,0	12,0	17,0	20	10	098327	5,65
00040600983	9	25,5	8,0	13,4	17,0	20	10	098334	5,65
00040601083	10	25,5	8,5	14,6	17,0	22	10	098341	5,65
00040601183	11	25,5	8,5	15,9	17,0	22	10	098358	5,65
00040601283	12	25,5	8,5	17,0	17,0	23	10	098365	5,65
00040601383	13	25,5	9,0	18,0	18,0	28	10	098372	5,65
00040601483	14	26,0	10,5	19,6	19,6	32	10	098389	5,65
00040601583	15	27,0	13,0	21,0	21,0	39	10	098396	6,20
00040601683	16	27,0	13,0	22,0	22,0	42	10	098402	6,20
00040601783	17	27,0	13,0	23,4	23,4	51	10	098419	6,20
00040601883	18	27,0	13,0	24,0	24,0	51	10	098426	6,20
00040601983	19	29,0	15,0	26,0	24,0	58	10	098433	6,20
00040602083	20	29,0	15,0	27,1	25,5	60	10	098440	6,80
00040602183	21	29,0	15,0	28,0	26,0	68	10	098457	6,80
00040602283	22	31,0	17,0	29,6	27,0	80	10	098464	6,80

40-12

Steckschlüssel-Einsätze

DIN 3124 / ISO 2725
Chrom-Vanadium
CPP = verchromt, ganz poliert
mit Kugelfangrinne

Sockets

DIN 3124 / ISO 2725
Chrome-Vanadium
CPP = chromium plated, fully
polished, with ball retaining groove

Douilles

DIN 3124 / ISO 2725
Chrome-Vanadium
CPP = chromées, entièrement polies
avec gorge de verrouillage pour bille

Llaves de vaso

DIN 3124 / ISO 2725
Cromo Vanadio
CPP = cromado, cabeza pulida espejo
con ranura de retención por bola

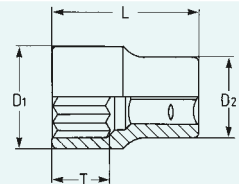

Code	MM	←L→ mm	T mm	D ₁ mm	D ₂ mm	g	g	EAN	€
00040000683	6	25,5	8,0	9,3	17,0	18	10	099089	5,65
00040000783	7	25,5	8,0	10,9	17,0	18	10	099072	5,65
00040000883	8	25,5	8,0	12,0	17,0	20	10	098471	5,65
00040000983	9	25,5	8,0	13,4	17,0	20	10	098488	5,65
00040001083	10	25,5	8,5	14,6	17,0	22	10	098495	5,65
00040001183	11	25,5	8,5	15,9	17,0	22	10	098501	5,65
00040001283	12	25,5	8,5	17,0	17,0	22	10	098518	5,65
00040001383	13	25,5	9,0	18,0	18,0	27	10	098525	5,65
00040001483	14	26,0	10,5	19,6	19,6	32	10	098532	5,65
00040001583	15	27,0	13,0	21,0	21,0	38	10	098549	6,20
00040001683	16	27,0	13,0	22,0	22,0	42	10	098556	6,20
00040001783	17	27,0	13,0	23,4	23,4	48	10	098563	6,20
00040001883	18	27,0	13,0	24,0	24,0	49	10	098570	6,20
00040001983	19	29,0	15,0	26,0	24,0	57	10	098587	6,20
00040002083	20	29,0	15,0	27,1	25,5	64	10	098594	6,80
00040002183	21	29,0	15,0	28,0	26,0	68	10	098600	6,80
00040002283	22	31,0	17,0	29,6	27,0	78	10	098617	6,80

Code	AF	←L→ mm	T mm	D ₁ mm	D ₂ mm	g	g	EAN	€
00040031283	1/4	25,5	8,0	10,0	17,0	18	10	098624	5,65
00040031483	9/32	25,5	8,0	11,0	17,0	18	10	098631	5,65
00040031683	5/16	25,5	8,0	12,0	17,0	20	10	098648	5,65
00040031883	11/32	25,5	8,0	12,5	17,0	20	10	098655	5,65
00040031983	3/8	25,5	8,0	14,5	17,0	22	10	098662	5,65
00040032183	7/16	25,5	8,5	16,0	17,0	23	10	098679	5,65
00040032383	1/2	25,5	9,0	18,0	18,0	26	10	098686	5,65
00040032583	9/16	26,5	10,5	20,0	20,0	34	10	098693	5,65
00040032683	19/32	27,0	13,0	21,0	21,0	38	10	098709	6,20
00040032783	5/8	27,0	13,0	22,0	22,0	44	10	098716	6,20
00040032883	21/32	27,0	13,0	23,0	23,4	50	10	098723	6,20
00040032983	11/16	27,0	13,0	24,0	24,0	52	10	098730	6,20
00040033183	3/4	29,0	15,0	26,0	24,0	57	10	098747	6,20
00040033283	25/32	29,0	15,0	27,1	25,5	64	10	098754	6,80
00040033383	13/16	29,0	15,0	28,0	26,0	68	10	098761	6,80
00040033483	7/8	31,0	17,0	30,0	27,0	81	10	098778	6,80

40-17-1/2

Glühkerzeneinsätze mit Gelenk

- Chrom-Vanadium, verchromt
- Mit geschraubtem Kardangelen
- Ideal für enge Bauräume
- Mit Gummieinsatz zum Halten der losen Glühkerze
- Länge: 160 mm

Glow plug sockets with joint

- Chrome-Vanadium, chromium plated
- With bolted universal joint
- Ideal for restricted locations
- With rubber insert to hold the loose glow plug
- Length: 160 mm

Clés à bougies

- Acier chromé
- Avec cardan vissé
- Idéal pour les accès difficiles
- Avec insert en caoutchouc pour maintenir le bougie
- Longueur: 160 mm

Llave para bujías, articulada

- Cromo vanadio, cromadas
- Con articulación Kardan
- Ideal para espacios reducidos
- Con injerto de goma para sujetar la bujía
- Longitud: 160 mm

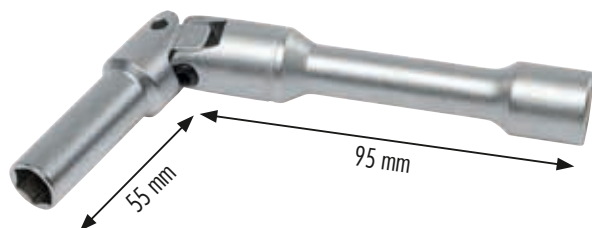

Code	No.	ØMM	←L→ mm	g	g	EAN	€
00040170183	40-17-1	8	160	180	5	394221	22,45
00040170283	40-17-2	10	160	180	5	394238	22,45

40-18-1/2

Zündkerzeneinsätze, extra lang

- Chrom-Vanadium, verchromt, teilweise poliert
- Besonders gut geeignet für extrem tiefsitzende Kerzen
- Kreuzrändelung für mehr Grip

Spark plug sockets, extra deep

- Chrome-Vanadium, chromium plated, head polished
- Best suited for extremely deep mounted spark/glow plug sockets
- Cross knurling provides better grip

Douille pour bougie extra longue

- Chrome-Vanadium, chromé, partiellement polis
- Particulièrement adapté pour les bougies extrêmement profond
- Moleté pour plus de prise

Llaves de vaso para bujías extra-largas

- Cromo vanadio, cromadas, parcialmente pulida
- Especialmente apta para bujías en alojamiento profundo
- Grafilado para mejor agarre



Code	No.	ØMM	←L→ mm	g	g	EAN	€
00040180183	40-18-1	14	250	280	5	394061	19,40
00040180283	40-18-2	16	250	280	5	394085	19,90

40-19-1 - 40-19-3

Steckschlüssel-Einsätze für Zündkerzen

- ~ DIN 3124 / ISO 2725
- Chrom-Vanadium
- CP = verchromt, teilweise poliert
- extra lang, mit Kugelfangrinne, mit Gummieinsatz, 19 mm Außen-Sechskant

Spark plug sockets

- ~ DIN 3124 / ISO 2725
- Chrome-Vanadium
- CP = chromium plated, head polished, extra deep, with ball retaining groove, with rubber insert, 19 mm hexagon plug

Douilles pour bougies

- ~ DIN 3124 / ISO 2725
- Chrome-Vanadium
- CP = chromées, partiellement polies
- avec gorge de verrouillage pour bille, extra longues; avec bague de caoutchouc de retenue de la bougie, 19 mm embase

Llaves de vaso para bujías

- ~ DIN 3124 / ISO 2725
- Cromo Vanadio
- CP = cromado, cabeza pulida espejo
- extra-largas, con ranura de retención por bola, con injerto de goma, hexágono exterior de 19 mm



Code	No.	ØMM	ØAF	←L→ mm	T mm	D mm	g	g	EAN	€
00040190183	40-19-1	20,8	13/16	65	15,0	28,0	140	10	098785	13,65
00040190283	40-19-2	18		65	10,0	24,0	130	10	098792	12,95
00040190383	40-19-3	16	5/8	65	15,0	22,0	100	10	098808	12,30

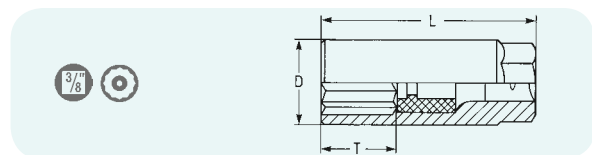

40-20

Steckschlüssel-Einsätze

Chrom-Vanadium
 CPP = verchromt, ganz poliert
 mit Kugelfangrinne
 für Außen-TORX®-Schrauben

Sockets

Chrome-Vanadium
 CPP = chromium plated, fully
 polished, with ball retaining groove
 for TORX®-head screws

Douilles

Chrom-Vanadium
 CPP = chromées, entièrement polies
 avec gorge de verrouillage pour bille
 pour vis TORX®-extérieures

Llaves de vaso

Cromo Vanadio
 CPP = cromado, cabeza pulida espejo
 con ranura de retención por bola
 para tornillos TORX® exteriores



Code	Größe size	★ mm	←L→ mm	T mm	D ₁ mm	D ₂ mm	g	mm	EAN	€
00040200583	E 5	4,75	28	5	7,0	17	20	10	112771	7,20
00040200683	E 6	5,74	28	6	8,0	17	22	10	112788	7,20
00040200783	E 7	6,22	28	7	9,0	17	25	10	112795	7,20
00040200883	E 8	7,52	28	7	10,0	17	28	10	112801	7,20
00040201083	E 10	9,42	28	8	12,0	17	30	10	112818	7,20
00040201283	E 12	11,17	28	8	14,5	17	32	10	112825	7,20
00040201483	E 14	12,90	28	10	16,5	17	35	10	112832	7,20

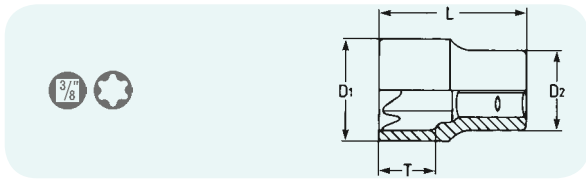

40-30 - 40-36

Schraubendreher-Einsätze

Körper:
 Chrom-Vanadium
 CPP = verchromt, ganz poliert
 mit Kugelfangrinne

Bits:
 Sonderstahl
 PH = phosphatiert

Screwdriver sockets

Socket bodies:
 Chrome-Vanadium
 CPP = chromium plated, fully
 polished, with ball retaining groove

Bits:
 Special steel
 PH = phosphated

Douilles tournevis

Douilles:
 Chrom-Vanadium
 CPP = chromées, entièrement polies
 avec gorge de verrouillage pour bille

Embouts:
 Acier Spécial
 PH = phosphaté

Llaves de vaso con destornillador

Cuerpo:
 Cromo Vanadio
 CPP = cromado, enteramente pulido
 espejo, con ranura de retención por bola

Puntas:
 Acero aleado
 PH = fosfatado



40-30 für Schlitz-Schrauben/for plain slot screws

Code	↑ mm	↓ mm	L ₁ mm	L ₂ mm	D ₁ mm	D ₂ mm	g	mm	EAN	€
00040300183	5,5	1,0	52	22	19	14	42	10	001709	8,80
00040300283	8,0	1,2	52	22	19	15	47	10	001716	10,35
00040300383	10,0	1,6	52	22	19	16	49	10	001723	10,65

40-31 für Innensechskant-Schrauben/for hexagon socket screws, DIN 7422/ISO 1174

Code	MM	L ₁ mm	L ₂ mm	D ₁ mm	D ₂ mm	g	mm	EAN	€
00040310183	4	42	12	19	14	41	10	001730	7,00
00040310283	5	42	12	19	14	41	10	001747	7,00
00040310383	6	42	12	19	14	42	10	001754	7,00
00040310783	7	42	12	19	14	43	10	172270	7,00
00040310483	8	42	12	19	15	45	10	001761	7,00
00040310583	10	42	12	19	16	49	10	001778	7,00

40-31 für Innensechskant-Schrauben/for hexagon socket screws, DIN 7422/ISO 1174

Code	AF	L ₁ mm	L ₂ mm	D ₁ mm	D ₂ mm	g	mm	EAN	€
00040313083	1/8	42	12	19	14	40	10	001785	7,70
00040313183	5/32	42	12	19	14	40	10	001792	7,70
00040313283	3/16	42	12	19	14	42	10	001808	7,70
00040313383	7/32	42	12	19	14	42	10	001815	7,85
00040313483	1/4	42	12	19	15	43	10	001822	7,85
00040313683	5/16	42	12	19	15	45	10	001839	7,85
00040313883	3/8	42	12	19	16	49	10	001846	8,25

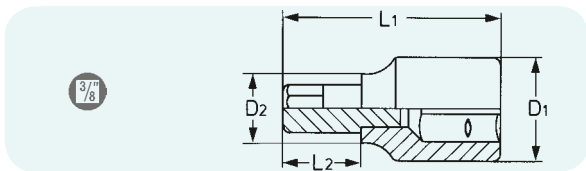

40-30 - 40-36

Schraubendreher-Einsätze Screwdriver sockets

Körper:
Chrom-Vanadium
CPP = verchromt, ganz poliert
mit Kugelfangrinne

Bits:
Sonderstahl
PH = phosphatiert

Socket bodies:
Chrome-Vanadium
CPP = chromium plated, fully
polished, with ball retaining groove

Bits:
Special steel
PH = phosphated

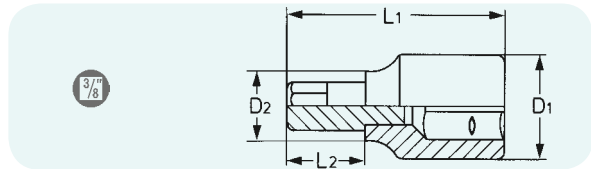

Douilles tournevis

Douilles:
Chrom-Vanadium
CPP = chromées, entièrement polies
avec gorge de verrouillage pour bille

Emboutis:
Acier Spécial
PH = phosphaté

Llaves de vaso con destornillador

Cuerpo:
Cromo Vanadio
CPP = cromado, enteramente pulido
espejo, con ranura de retención por bola

Puntas:
Acero aleado
PH = fosfatado

40-32 für Kreuzschlitz-Schrauben/for cross slot screws PHILLIPS-RECESS

Code	No.	L ₁ mm	L ₂ mm	D ₁ mm	D ₂ mm	g	pcs	EAN	€
00040320183	1	46	16	19	14	41	10	001853	10,55
00040320283	2	46	16	19	14	41	10	001860	10,55
00040320383	3	46	16	19	15	43	10	001877	10,55

40-35 für Kreuzschlitz-Schrauben/for cross slot screws POZIDRIV®

Code	No.	L ₁ mm	L ₂ mm	D ₁ mm	D ₂ mm	g	pcs	EAN	€
00040350183	1	46	16	19	14	40	10	001891	11,00
00040350283	2	46	16	19	14	41	10	001907	11,00
00040350383	3	46	16	19	15	45	10	001914	11,00

40-36 für Innen-TORX®-Schrauben/for TORX®-socket screws

Code	Größe size	mm	L ₁ mm	L ₂ mm	D ₁ mm	D ₂ mm	g	pcs	EAN	€
00040361083	T 10	2,74	45	15	19	14	40	10	001938	9,75
00040361583	T 15	3,27	45	15	19	14	41	10	001945	9,75
00040362083	T 20	3,86	45	15	19	15	42	10	001952	9,75
00040362583	T 25	4,43	45	15	19	15	42	10	001969	9,75
00040362783	T 27	4,99	45	15	19	15	42	10	001976	9,75
00040363083	T 30	5,52	45	15	19	15	42	10	001983	9,75
00040364083	T 40	6,65	45	15	19	15	44	10	001990	9,75
00040364583	T 45	7,82	45	15	19	15	45	10	002003	9,75
00040365083	T 50	8,83	48	18	19	16	49	10	002010	9,75

40-50

Satz mit Schraubendreher- und Steckschlüssel-Einsätzen Combined set of sockets and screwdriver sockets

Chrom-Vanadium
CPP = verchromt,
ganz poliert
Metallkasten 225 x 115 x 38 mm

Chrome-Vanadium
CPP = chromium plated,
fully polished
Metal case 225 x 115 x 38 mm



Compositions de douilles et de douilles-tournevis

Chrom-Vanadium
CPP = chromées,
entièrement polies
Coffret métallique 225 x 115 x 38 mm

Juegos de llaves de vaso con destornillador

Cromo Vanadio
CPP = cromado,
enteramente pulido espejo
Caja metálica 225 x 115 x 38 mm

für TORX®-Schrauben/for TORX®-screws

Code	No.	tlg./pcs.	g	pcs	EAN	€
00040500083	40-50-E/T	16	1040	1	125344	136,75

enthaltend/containing			
Stck./pcs.	Artikel/article	No.	Maße/dimensions
7		40-20	E 5 E 6 E 7 E 8 E 10 E 12 E 14
9		40-36	T 10 T 15 T 20 T 25 T 27 T 30 T 40 T 45 T 50

40-70 - 40-71**Steckschlüssel-Einsätze
auf Aluminium-Klemm-
leiste, 16-tlg.**

Aluminium-Klemmleiste grün eloxiert.
Chrom-Vanadium
CPP = verchromt, ganz poliert
mit Kugelfangrinne

Sockets on aluminium
socket rail, 16 pcs.

Aluminium socket rail, anodized.
Chrome-Vanadium
CPP = chromium plated, fully
polished, with ball retaining groove

Assortiment douilles sur bande
alu, 16 pces.

Bloc aluminium anodisé.
Chrome-Vanadium
CPP = chromées, entièrement polies
avec gorge de verrouillage pour bille

Juego de 16 llaves de vaso en
regla de sujeción de aluminio

Regla de sujeción, de aluminio anodizado
color verde.
Cromo Vanadio
CPP = cromado, cabeza pulida espejo
con ranura de retención por bolae

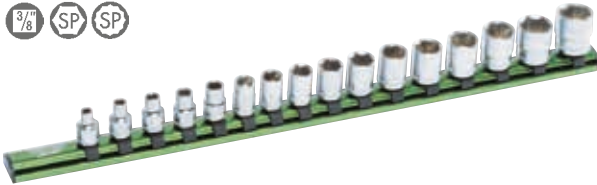

Code	No.	tlg./pcs.			EAN	€
00040700083	40-70-M	16	891	1	366723	134,65
00040710083	40-71-M	16	901	1	366730	134,65

enthaltend/containing

Stck./pcs.	Artikel/article	No.	Maße/dimensions
16		40-70-M	MM 6 7 8 9 10 11 12 13 14 15 16 17 18 19 21 22
16		40-71-M	MM 6 7 8 9 10 11 12 13 14 15 16 17 18 19 21 22

987-40**Aluminium-Klemmleiste,
leer**

zur Aufnahme von max. 16 Einsätzen
Kugelgefederter Aufnahme gewähr-
leistet perfekten Halt der Einsätze.
Sicherer Halt der Klemmleiste durch
Magnet an Metallflächen.

Aluminium socket rail,
empty

for max. 16 sockets
Spring-loaded retaining ball
ensures a perfect hold of the
sockets. A strong magnet securely
holds the socket rail to ferrous metal.

Bornes en aluminium, vide

pour max. 16 inserts
Les billes à ressort assurent une parfaite
prise en main.
Blocage des bornes dues aux aimants et les
surfaces métalliques.

Regla de aluminio anodizado
color verde

para sujeción de 16 llaves de vaso
Sujeción con muelle, garantiza una firme
colocación de los vasos.
Regla sujeta por imán.

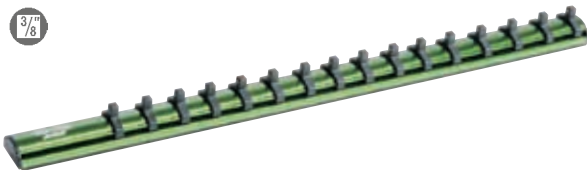

Code	No.	tlg./pcs.			EAN	€
98710401600	987-40	1	269	1	365283	38,60



40-75 - 40-88

Kombi-Spender mit Steckschlüssel- und Schraubendreher-Einsätzen

aus Stahlblech, zum Aufstellen und Hängen; problemloses Bestücken beider Schütten durch herausnehmbares Oberteil; variable Einteilung durch Trennleistensystem, daher Zusammenstellung von Sortimenten nach Wahl möglich. Folgende Sortimente führen wir standardmäßig:

Dispensers containing sockets and screwdriver sockets

sheet steel, for counter-display and wall mounting; simple re-filling of both dispenser units with removable upper tray; variable system of partitions permits composition of different assortments to choice. The following assortments represent our standard range:

Présentoirs combinés avec douilles et douilles-tournevis

en tôle d'acier, à poser ou à accrocher; facile à remplir grâce à la partie supérieure amovible; cloisons réglables permettant une composition variable au choix. Les compositions suivantes sont standardisées:

Expositor combinado de llaves de vaso y vasos con destornillador

de chapa de acero, de sobremesa o para colgar; ambos cargadores facilmente recargables, gracias a la parte superior desmontable; separaciones ajustables por sistema de listones que permiten componer los surtidos a elección del usuario. Los siguientes surtidos son standard:



40-75



40-85

Code	No.	tlg./pcs.	g	Box	EAN	€
00040750083	40-75-M	347	23230	1	098815	2.767,95

157 Doppel-6-kant Steckschlüssel-Einsätze/bihexagon sockets MM,
190 Schraubendreher-Einsätze/screwdriver sockets
enthaltend/containing

Stck./pcs.	Artikel/article	No.	Maße/dimensions
je 10 each		40-12	MM 6 7 8 9 10 11 12 13 14 15
je 9 each		40-12	MM 16 17 18
je 8 each		40-12	MM 19 20
je 7 each		40-12	MM 21 22
je 10 each		40-30	5,5 8 9 mm
je 10 each		40-31	MM 4 5 6 8 10
je 10 each		40-32	PH No. 1 2 3
je 10 each		40-35	PZ No. 1 2 3
je 10 each		40-36	T 15 T 20 T 25 T 27 T 30

Code	No.	tlg./pcs.	g	Box	EAN	€
00040760083	40-76-M	347	23350	1	098822	2.767,95

157 6-kant Steckschlüssel-Einsätze/hexagon sockets MM,
190 Schraubendreher-Einsätze/screwdriver sockets
wie/as 40-75-M, jedoch/but

Stck./pcs.	Artikel/article	No.	Maße/dimensions
je 10 each		40-6	MM 6 7 8 9 10 11 12 13 14 15
je 9 each		40-6	MM 16 17 18
je 8 each		40-6	MM 19 20
je 7 each		40-6	MM 21 22

Code	No.	tlg./pcs.	g	Box	EAN	€
00040850083	40-85-M	314	19550	1	098839	1.977,95

157 Doppel-6-kant Steckschlüssel-Einsätze/bihexagon sockets MM,
157 6-kant Steckschlüssel-Einsätze/hexagon sockets MM
enthaltend/containing

Stck./pcs.	Artikel/article	No.	Maße/dimensions
je 10 each		40-12	MM 6 7 8 9 10 11 12 13 14 15
je 9 each		+	MM 16 17 18
je 8 each		+	MM 19 20
je 7 each		40-6	MM 21 22

Code	No.	tlg./pcs.	g	Box	EAN	€
00040880083	40-88-M/AF	314	19300	1	098846	1.977,95

157 Doppel-6-kant Steckschlüssel-Einsätze/bihexagon sockets MM,
157 Doppel-6-kant Steckschlüssel-Einsätze/bihexagon sockets AF
enthaltend/containing

Stck./pcs.	Artikel/article	No.	Maße/dimensions
je 10 each		40-12	MM 6 7 8 9 10 11 12 13 14 15
je 9 each		40-12	MM 16 17 18
je 8 each		40-12	MM 19 20
je 7 each		40-12	MM 21 22
je 10 each		40-12	AF 1/4 9/32 5/16 11/32 3/8 7/16
je 20 each		40-12	AF 1/2
je 10 each		40-12	AF 9/16 19/32
je 9 each		40-12	AF 5/8 21/32 11/16
je 8 each		40-12	AF 3/4 25/32
je 7 each		40-12	AF 13/16 7/8

41-0010 - 41-3010

Steckschlüssel-Garnituren

Chrom-Vanadium
 CPP = verchromt,
 ganz poliert
 Metallkasten 318 x 119 x 49 mm

Socket sets

Chrome-Vanadium
 CPP = chromium plated,
 fully polished
 Metal case 318 x 119 x 49 mm

Compositions de douilles

Chrom-Vanadium
 CPP = chromées,
 entièrement polies
 Coffret métallique 318 x 119 x 49 mm

Juegos de llaves de vaso

Cromo Vanadio
 CPP = cromado,
 enteramente pulido espejo
 Caja metálica 318 x 119 x 49 mm

3/8

Neu
New

Code	No.	tlg./pcs.	g		EAN	€
00041001083	41-0010-M	23	2490	1	100402	222,90

enthaltend/containing

Stck./pcs.	Artikel/article	No.	Maße/dimensions
17		40-12	MM 6 7 8 9 10 11 12 13 14 15 16 17 18 19 20 21 22
1		40-00-10	200 mm
1		40-30	9 mm
1		40-03	200 mm
1		40-04	125 mm
1		40-05	250 mm
1		40-06	50 mm

Code	No.	tlg./pcs.	g		EAN	€
00041500083	41-50-M	23	2485	1	098884	202,00

wie/as 41-0010-M, jedoch/but

Stck./pcs.	Artikel/article	No.	Maße/dimensions
1		40-00-1	195 mm

Code	No.	tlg./pcs.	g		EAN	€
00041301083	41-3010-M	23	2440	1	100426	222,90

wie/as 41-0010-M, jedoch/but

Stck./pcs.	Artikel/article	No.	Maße/dimensions
17		40-6	MM 6 7 8 9 10 11 12 13 14 15 16 17 18 19 20 21 22

Code	No.	tlg./pcs.	g		EAN	€
00041800083	41-80-M	23	2485	1	098907	202,00

wie/as 41-0010-M, jedoch/but

Stck./pcs.	Artikel/article	No.	Maße/dimensions
17		40-6	MM 6 7 8 9 10 11 12 13 14 15 16 17 18 19 20 21 22
1		40-00-1	195 mm

Code	No.	tlg./pcs.	g		EAN	€
00041101083	41-1010-AF	23	2425	1	100419	217,40

wie/as 41-0010-M, jedoch/but

Stck./pcs.	Artikel/article	No.	Maße/dimensions
16		40-12	AF 1/4 9/32 5/16 11/32 3/8 7/16 1/2 9/16 19/32 5/8 21/32 11/16 3/4 25/32 13/16 7/8

HEYCO



Gute Arbeit braucht
gutes Werkzeug

Good work needs
good tools



43-0010 - 43-3010

Steckschlüssel-Garnituren

Chrom-Vanadium
 CPP = verchromt,
 ganz poliert
 Metallkasten 225 x 115 x 40 mm

Socket sets

Chrome-Vanadium
 CPP = chromium plated,
 fully polished
 Metal case 225 x 115 x 40 mm

Compositions de douilles

Chrom-Vanadium
 CPP = chromées,
 entièrement polies
 Coffret métallique 225 x 115 x 40 mm

Juegos de llaves de vaso

Cromo Vanadio
 CPP = cromado,
 enteramente pulido espejo
 Caja metálica 225 x 115 x 40 mm

3/8



Code	No.	tlg./pcs.			EAN	€
00043001083	43-0010-M	15	1297	1	100433	163,05

enthaltend/containing

Stck./pcs.	Artikel/article	No.	Maße/dimensions
12		40-12	MM 8 9 10 11 12 13 14 15 16 17 18 19
1		40-00-10	200 mm
1		40-04	125 mm
1		40-06	50 mm

Code	No.	tlg./pcs.			EAN	€
00043500083	43-50-M	15	1250	1	098945	142,20

wie/as 43-0010-M, jedoch/but

Stck./pcs.	Artikel/article	No.	Maße/dimensions
1		40-00-1	195 mm

Code	No.	tlg./pcs.			EAN	€
00043301083	43-3010-M	15	1296	1	100471	163,05

wie/as 43-0010-M, jedoch/but

Stck./pcs.	Artikel/article	No.	Maße/dimensions
12		40-6	MM 8 9 10 11 12 13 14 15 16 17 18 19

Code	No.	tlg./pcs.			EAN	€
00043800083	43-80-M	15	1275	1	098969	142,20

wie/as 43-0010-M, jedoch/but

Stck./pcs.	Artikel/article	No.	Maße/dimensions
12		40-6	MM 8 9 10 11 12 13 14 15 16 17 18 19
1		40-00-1	195 mm

Code	No.	tlg./pcs.			EAN	€
00043101083	43-1010-AF	15	1294	1	100464	163,05

wie/as 43-0010-M, jedoch/but

Stck./pcs.	Artikel/article	No.	Maße/dimensions
12		40-12	AF 1/4 5/16 11/32 3/8 7/16 1/2 9/16 19/32 5/8 21/32 11/16 3/4

3/8"

44-0010 - 44-3010**Steckschlüssel-Garnituren**

Chrom-Vanadium
 CPP = verchromt,
 ganz poliert
 Metallkasten 407 x 162 x 52 mm

Socket sets

Chrome-Vanadium
 CPP = chromium plated,
 fully polished
 Metal case 407 x 162 x 52 mm

3/8"

**Compositions de douilles**

Chrome-Vanadium
 CPP = chromées,
 entièrement polies
 Coffret métallique 407 x 162 x 52 mm

Juegos de llaves de vaso

Cromo Vanadio
 CPP = cromado,
 enteramente pulido espejo
 Caja metálica 407 x 162 x 52 mm

Code	No.	tlg./pcs.			EAN	€
00044001083	44-0010-M	23	2885	1	097368	238,00

enthaltend/containing

Stck./pcs.	Artikel/article	No.	Maße/dimensions
11		40-12	MM 8 10 11 12 13 14 15 16 17 18 19
1		40-00-10	200 mm
1		40-03	200 mm
1		40-04-1	75 mm
1		40-05	250 mm
1		40-06	50 mm
1		40-19-1	MM 20,8 AF 13/16
1		40-19-3	MM 16 AF 5/8
5		40-31	MM 4 5 6 8 10 mm

Code	No.	tlg./pcs.			EAN	€
00044500083	44-50-M	23	2845	1	100532	215,95

wie/as 44-0010-M, jedoch/but

Stck./pcs.	Artikel/article	No.	Maße/dimensions
1		40-00-1	195 mm

Code	No.	tlg./pcs.			EAN	€
00044301083	44-3010-M	23	2905	1	095319	238,00

wie/as 44-0010-M, jedoch/but

Stck./pcs.	Artikel/article	No.	Maße/dimensions
11		40-6	MM 8 10 11 12 13 14 15 16 17 18 19

Code	No.	tlg./pcs.			EAN	€
00044800083	44-80-M	23	2860	1	100549	217,05

wie/as 44-0010-M, jedoch/but

Stck./pcs.	Artikel/article	No.	Maße/dimensions
11		40-6	MM 8 10 11 12 13 14 15 16 17 18 19
1		40-00-1	195 mm

47-0010**Steckschlüssel-Garnitur**

Chrom-Vanadium
 CPP = verchromt,
 ganz poliert
 Metallkasten 318 x 119 x 49 mm

Socket set

Chrome-Vanadium
 CPP = chromium plated,
 fully polished
 Metal case 318 x 119 x 49 mm

3/8"

**Compositions de douilles**

Chrome-Vanadium
 CPP = chromées,
 entièrement polies
 Coffret métallique 318 x 119 x 49 mm

Juegos de llaves de vaso

Cromo Vanadio
 CPP = cromado,
 enteramente pulido espejo
 Caja metálica 318 x 119 x 49 mm

für TORX®-Schrauben/for TORX®-screws

Code	No.	tlg./pcs.			EAN	€
00047001083	47-0010	20	2215	1	329650	256,80

enthaltend/containing

Stck./pcs.	Artikel/article	No.	Maße/dimensions
7		40-20	E 5 E 6 E 7 E 8 E 10 E 12 E 14
8		40-36	T 15 T 20 T 25 T 27 T 30 T 40 T 45 T 50
1		40-00-10	198 mm
1		40-03	200 mm
1		40-04-1	75 mm
1		40-04	125 mm
1		40-06	50 mm

45-0010 - 45-3010**Steckschlüssel-Garnituren**

Chrom-Vanadium
 CPP = verchromt,
 ganz poliert
 Metallkasten 407 x 162 x 52 mm

Socket sets

Chrome-Vanadium
 CPP = chromium plated,
 fully polished
 Metal case 407 x 162 x 52 mm

Compositions de douilles

Chrom-Vanadium
 CPP = chromées,
 entièrement polies
 Coffret métallique 407 x 162 x 52 mm

Juegos de llaves de vaso

Cromo Vanadio
 CPP = cromado,
 enteramente pulido espejo
 Caja metálica 407 x 162 x 52 mm

3/8



Code	No.	tlg./pcs.			EAN	€
00045001083	45-0010-M	39	3180	1	100556	309,60

enthaltend/containing

Stck./pcs.	Artikel/article	No.	Maße/dimensions
17		40-12	MM 6 7 8 9 10 11 12 13 14 15 16 17 18 19 20 21 22
1		40-00-10	200 mm
1		40-03	200 mm
1		40-04	125 mm
1		40-05	250 mm
1		40-06	50 mm
1		40-19-1	MM 20,8 AF 13/16
1		40-19-3	MM 16 AF 5/8
1		3301	225 mm
3		3500	4 6 8 mm
4		3510	MM 4 5 6 8
3		3520	PH No. 1 2 3
3		3530	PZ No. 1 2 3
1		6201-30	

Code	No.	tlg./pcs.			EAN	€
00045500083	45-50-M	39	3150	1	098990	288,70

wie/as 45-0010-M, jedoch/but

Stck./pcs.	Artikel/article	No.	Maße/dimensions
1		40-00-1	195 mm

Code	No.	tlg./pcs.			EAN	€
00045301083	45-3010-M	39	3245	1	100563	309,60

wie/as 45-0010-M, jedoch/but

Stck./pcs.	Artikel/article	No.	Maße/dimensions
17		40-6	MM 6 7 8 9 10 11 12 13 14 15 16 17 18 19 20 21 22

Code	No.	tlg./pcs.			EAN	€
00045800083	45-80-M	39	3190	1	099003	288,70

wie/as 45-0010-M, jedoch/but

Stck./pcs.	Artikel/article	No.	Maße/dimensions
17		406	MM 6 7 8 9 10 11 12 13 14 15 16 17 18 19 20 21 22
1		40-00-1	195 mm

50-00-1 - 50-16

1/2" Antriebs- und Verbindungsteile

DIN 3122 + 3123

1/2" Accessories

DIN 3122 + 3123

1/2" Accessoires

DIN 3122 + 3123

1/2" Accesorios

DIN 3122 + 3123

Code	No.	Ausf. finish					L mm	g		EAN	€
00050011082	50-00-1	CP	Durchstecknarre	Ratchet, push-thru type	Cliquet	Carraca de cuadradillo pasante	270	475	5	002782	32,85
00050007082	50-00-7	CP	Umschaltnarre	Reversible ratchet	Cliquet réversible	Carraca reversible	270	480	5	002690	50,35
00050010083	50-00-10	CPP	Hebelumschaltnarre VARICAT NEU	Reversible ratchet VARICAT NEW	Cliquet réversible à levier VARICAT NOUVEAU	Carraca reversible VARICAT NUEVO	270	269	1	002744	62,00
00050010583	50-00-15	CPP	Hebelumschaltnarre VARICAT NEU	Reversible ratchet VARICAT NEW	Cliquet réversible à levier VARICAT NOUVEAU	Carraca reversible VARICAT NUEVO	270	269	1	404296	64,00
00050401083	50-40-10	CPP	Hebelumschaltnarre talenta	Reversible ratchet talenta	Cliquet réversible à levier talenta	Carraca reversible talenta	200	265	1	315776	49,00
00050018082	50-00-18	C	Umschaltnarre mit Gelenk	Flex. head reversible ratchet	Cliquet réversible articulé	Carraca reversible, articulada	395	725	5	002836	101,45
00050027082	50-00-27	C	Aufsteck-Umschaltnarre	Reversible ratchet unit	Cliquet réversible adaptateur	Cabeza de carraca reversible	55	205	5	002850	41,60
00050020083	50-02	CPP	Kurbel	Speed brace	Vilebrequin	Berbiquí	405	590	5	002843	24,15
00050030083	50-03	CPP	Griff mit Gleitstück	Sliding T-handle	Poignée coulissante	Mango corredizo	300	400	10	002874	15,55
00050040083	50-04	CPP	Verlängerung	Extension bar	Rallonge	Alargadera	125	180	10	003130	10,70
00050041083	50-04-1	CPP	Verlängerung	Extension bar	Rallonge	Alargadera	75	130	10	003154	9,70
00050042583	50-04-25	CPP	Schwenkbare Verlängerung	Wobble extension	Rallonge articulée	Alargadera oscilante	50	90	10	103052	11,05
00050045083	50-04-5	CPP	Schwenkbare Verlängerung	Wobble extension	Rallonge articulée	Alargadera oscilante	125	180	10	103069	12,65
00050050083	50-05	CPP	Verlängerung	Extension bar	Rallonge	Alargadera	250	325	10	003185	14,80
00050055083	50-05-5	CPP	Schwenkbare Verlängerung	Wobble extension	Rallonge articulée	Alargadera oscilante	250	325	10	103076	16,25
00050060083	50-06	CPP	Kardangelen	Universal joint	Cardan universel	Articulación universal	70	160	10	003215	27,10
00050080083	50-08	CPP	Gelenkgriff	Swivel handle	Poignée articulée	Mango articulado	385	675	5	003352	45,90
00050090083	50-09	CPP	Gelenkgriff	Swivel handle	Poignée articulée	Mango articulado	450	785	5	003369	53,60
00050100083	50-10	CPP	Winkelgriff	Offset handle	Poignée coudeé	Mango acodado	200	270	10	003376	13,55
00050141083	50-14-1	CPP	Verbindungsstück	Converter	Réducteur	Reductor	36	52	10	003383	10,35
00050150083	50-15	CPP	Verbindungsstück	Converter	Réducteur	Convertidor	45	120	10	003390	12,90
00050160083	50-16	CPP	Verbindungsstück	Square coupler	Carré conducteur	Adaptador	34	45	10	003406	3,70



50-00-1 · 30 Zähne/teeth · DIN 3122 C · ISO 3315



50-00-7 · 45 Zähne/teeth · DIN 3122 D · ISO 3315



50-00-10 · 48 Zähne/teeth · DIN 3122 D · ISO 3315



50-00-15 · 72 Zähne/teeth · DIN 3122 D · ISO 3315



50-40-10 · 32 Zähne/teeth · DIN 3122 D · ISO 3315

alles ausser Antrieb maximal minimiert/
minimized to optimum, with exception of the drive
Verkaufständer/Display Stands No. 1187



50-00-18 · 60 Zähne/teeth



50-02 · DIN 3122 B · ISO 3315



50-03 · DIN 3122 A · ISO 3315



50-04 · DIN 3123 B · ISO 3316



50-04-1 · DIN 3123 B · ISO 3316



50-04-5



50-04-25

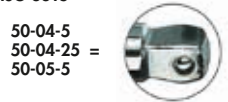

50-04-5 = 50-05-5



50-05 · DIN 3123 B · ISO 3316



50-05-5



50-06 · DIN 3123 C · ISO 3316



50-10 · DIN 3122 G · ISO 3315



50-08 - 50-09 · DIN 3122 F · ISO 3315



50-14-1 1/2 3/4
DIN 3123 A · ISO 3316

Chrom-Vanadium
CP = verchromt, teilweise poliert
CPP = verchromt, ganz poliert
mit Kugel-Arretierung



50-15 1/2 3/4
DIN 3123 A · ISO 3316

Chrome-Vanadium
CP = chromium plated, polished head
CPP = chromium plated, fully polished
with spring-loaded retaining ball



50-00-27
60 Zähne/teeth

50-6

Steckschlüssel-Einsätze

DIN 3124 / ISO 2725
 Chrom-Vanadium
 CPP = verchromt, ganz poliert
 mit Kugelfangrinne

Sockets

DIN 3124 / ISO 2725
 Chrome-Vanadium
 CPP = chromium plated, fully
 polished, with ball retaining groove

Douilles

DIN 3124 / ISO 2725
 Chrome-Vanadium
 CPP = chromées, entièrement polies
 avec gorge de verrouillage pour bille

Llaves de vaso

DIN 3124 / ISO 2725
 Cromo Vanadio
 CPP = cromado, cabeza pulida espejo
 con ranura de retención por bola

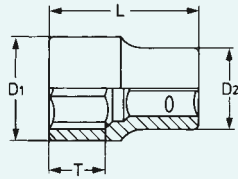

Code	ØMM	←L→ mm	T mm	D ₁ mm	D ₂ mm	g	g	EAN	€
00050600583	5	40	6,5	8,6	22,5	53	10	004489	7,40
00050605583	5,5	40	6,5	9,2	22,5	54	10	004762	7,40
00050600683	6	40	6,5	9,8	22,5	50	10	004496	7,40
00050600783	7	40	9,5	11,0	22,5	55	10	004502	7,40
00050600883	8	40	9,5	12,0	22,5	55	10	004519	6,75
00050600983	9	40	11,0	13,2	22,5	55	10	004526	6,75
00050601083	10	40	13,5	14,6	22,5	55	10	004533	6,40
00050601183	11	40	15,0	16,4	22,5	57	10	004540	6,40
00050601283	12	40	15,0	17,8	22,5	57	10	004557	6,40
00050601383	13	40	15,0	19,0	22,5	60	10	004564	6,40
00050601483	14	40	15,0	20,3	22,5	60	10	004571	6,80
00050601583	15	40	15,0	21,5	23,0	68	10	004588	6,80
00050601683	16	40	15,0	22,5	23,0	68	10	004595	6,80
00050601783	17	40	15,0	24,0	23,0	70	10	004601	7,40
00050601883	18	40	15,0	25,0	23,0	78	10	004618	7,40
00050601983	19	40	15,0	26,5	23,0	78	10	004625	7,55
00050602083	20	40	15,0	27,8	23,0	83	10	004632	7,55
00050602183	21	40	15,0	28,8	23,0	83	10	004649	8,30
00050602283	22	40	16,0	30,3	24,0	90	10	004656	8,20
00050602383	23	43	18,0	31,6	25,0	110	10	004663	9,00
00050602483	24	43	18,0	32,8	26,0	115	10	004670	9,00
00050602583	25	43	18,0	33,8	28,0	135	10	004687	9,90
00050602683	26	43	18,0	35,0	28,0	140	10	004694	9,90
00050602783	27	43	18,0	36,5	29,0	150	10	004700	11,30
00050602883	28	43	18,0	37,7	30,0	160	10	004717	11,45
00050602983	29	43	18,0	38,8	31,0	185	10	004724	12,35
00050603083	30	43	18,0	40,2	29,0	170	10	004731	12,15
00050603283	32	43	18,0	42,4	29,0	180	10	004748	12,15
00050603483	34	43	18,0	45,0	29,0	194	10	004755	13,15

50-12

Steckschlüssel-Einsätze

DIN 3124 / ISO 2725
 Chrom-Vanadium
 CPP = verchromt, ganz poliert
 mit Kugelfangrinne

Sockets

DIN 3124 / ISO 2725
 Chrome-Vanadium
 CPP = chromium plated, fully
 polished, with ball retaining groove

Douilles

DIN 3124 / ISO 2725
 Chrome-Vanadium
 CPP = chromées, entièrement polies
 avec gorge de verrouillage pour bille

Llaves de vaso

DIN 3124 / ISO 2725
 Cromo Vanadio
 CPP = cromado, cabeza pulida espejo
 con ranura de retención por bola

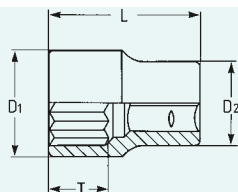

Code	ØMM	←L→ mm	T mm	D ₁ mm	D ₂ mm	g	g	EAN	€
00050000883	8	40	9,5	12,0	22,5	53	10	002331	6,75
00050000983	9	40	11,0	13,2	22,5	53	10	002348	6,75
00050001083	10	40	13,5	14,6	22,5	53	10	002362	6,40
00050001183	11	40	15,0	16,4	22,5	55	10	002379	6,40
00050001283	12	40	15,0	17,8	22,5	55	10	002393	6,40
00050001383	13	40	15,0	19,0	22,5	58	10	002416	6,40
00050001483	14	40	15,0	20,3	22,5	58	10	002430	6,80
00050001583	15	40	15,0	21,5	23,0	66	10	002454	6,80
00050001683	16	40	15,0	22,5	23,0	66	10	002478	6,80
00050001783	17	40	15,0	24,0	23,0	68	10	002492	7,40
00050001883	18	40	15,0	25,0	23,0	74	10	002508	7,40
00050001983	19	40	15,0	26,5	23,0	74	10	002522	7,55
00050002083	20	40	15,0	27,8	23,0	79	10	002539	7,55
00050002183	21	40	15,0	28,8	23,0	79	10	002546	8,30
00050002283	22	40	16,0	30,3	24,0	86	10	002553	8,20
00050002383	23	43	18,0	31,6	25,0	105	10	002560	9,00
00050002483	24	43	18,0	32,8	26,0	110	10	002584	9,00

50-12

Steckschlüssel-Einsätze

DIN 3124 / ISO 2725
 Chrom-Vanadium
 CPP = verchromt, ganz poliert
 mit Kugelfangrinne

Sockets

DIN 3124 / ISO 2725
 Chrome-Vanadium
 CPP = chromium plated, fully
 polished, with ball retaining groove

Douilles

DIN 3124 / ISO 2725
 Chrome-Vanadium
 CPP = chromées, entièrement polies
 avec gorge de verrouillage pour bille

Llaves de vaso

DIN 3124 / ISO 2725
 Cromo Vanadio
 CPP = cromado, cabeza pulida espejo
 con ranura de retención por bola

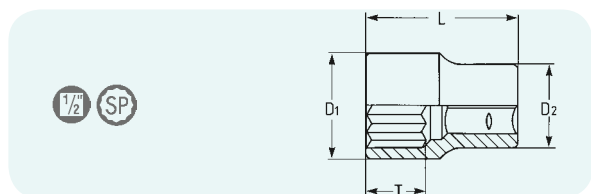

Code	⊘MM	←L→ mm	T mm	D ₁ mm	D ₂ mm	g	g	EAN	€
00050002583	25	43	18,0	33,8	28,0	130	10	002591	9,90
00050002683	26	43	18,0	35,0	28,0	135	10	002607	9,90
00050002783	27	43	18,0	36,5	29,0	145	10	002614	11,30
00050002883	28	43	18,0	37,7	30,0	155	10	002621	11,45
00050002983	29	43	18,0	38,8	31,0	180	10	002638	12,35
00050003083	30	43	18,0	40,2	29,0	165	10	002645	12,15
00050003283	32	43	18,0	42,4	29,0	175	10	002652	12,15
00050003383	33	43	18,0	44,0	29,0	170	10	002669	13,15
00050003483	34	43	18,0	45,0	29,0	192	10	002676	13,15

Code	⊘AF	←L→ mm	T mm	D ₁ mm	D ₂ mm	g	g	EAN	€
00050031983	3/8	40	12,0	14,0	22,5	53	10	002881	6,75
00050032183	7/16	40	15,0	16,4	22,5	53	10	002904	6,75
00050032383	1/2	40	15,0	17,8	22,5	57	10	002928	6,75
00050032583	9/16	40	15,0	20,3	22,5	60	10	002942	6,95
00050032683	19/32	40	15,0	21,5	23,0	66	10	002959	6,95
00050032783	5/8	40	15,0	22,5	23,0	66	10	002966	6,95
00050032983	11/16	40	15,0	25,0	23,0	72	10	002980	8,15
00050033183	3/4	40	15,0	26,5	23,0	74	10	002997	8,15
00050033283	25/32	40	15,0	27,7	23,0	80	10	003000	8,35
00050033383	13/16	40	15,0	28,8	23,0	77	10	003017	8,35
00050033483	7/8	40	16,0	30,3	24,0	87	10	003031	8,80
00050033583	15/16	43	18,0	32,7	26,0	110	10	003048	9,90
00050033683	31/32	43	18,0	33,8	28,0	125	10	003055	9,90
00050033783	1	43	18,0	35,0	28,0	135	10	003062	9,90
00050033883	1.1/16	43	18,0	36,5	29,0	145	10	003079	11,80
00050033983	1.1/8	43	18,0	38,8	31,0	165	10	003086	12,35
00050034083	1.3/16	43	18,0	40,3	29,0	170	10	003093	12,35
00050034183	1.1/4	43	18,0	42,4	29,0	175	10	003109	13,10

Code	⊘W	←L→ mm	T mm	D ₁ mm	D ₂ mm	g	g	EAN	€
00050070383	1/8	40	11,0	13,2	22,5	52	10	003239	7,70
00050070483	3/16	40	15,0	16,5	22,5	57	10	003246	7,70
00050070583	1/4	40	15,0	19,0	22,5	60	10	003253	7,70
00050070683	5/16	40	15,0	21,5	23,0	68	10	003260	8,35
00050070783	3/8	40	15,0	25,0	23,0	75	10	003277	9,25
00050070883	7/16	40	15,0	29,0	23,0	80	10	003284	11,00
00050070983	1/2	43	18,0	31,5	25,0	105	10	003291	11,00
00050071083	9/16	43	18,0	35,0	28,0	130	10	003307	11,00
00050071183	5/8	43	18,0	37,7	30,0	155	10	003314	13,60
00050071283	11/16	43	18,0	40,3	29,0	170	10	003321	13,80
00050071383	3/4	43	18,0	44,0	29,0	175	10	003338	13,80

50-19

Steckschlüssel-Einsätze,
extra lang

DIN 3124 / ISO 2725

Chrom-Vanadium

CP = verchromt, teilweise poliert
mit KugelfangrinneSockets,
extra deep

DIN 3124 / ISO 2725

Chrome-Vanadium

CP = chromium plated, head
polished, with ball retaining grooveDouilles,
extra longues

DIN 3124 / ISO 2725

Chrome-Vanadium

CP = chromées, partiellement polies
avec gorge de verrouillage pour billeLlaves de vaso,
extra largo

DIN 3124 / ISO 2725

Cromo Vanadio

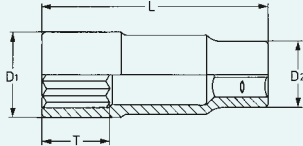
CP = cromado, cabeza pulida espejo
con ranura de retención por bola

Code	MM	←L→ mm	T mm	D ₁ mm	D ₂ mm	g		EAN	€
00050191082	10	80	13,0	15,2	23,0	105	10	099874	11,30
00050191182	11	80	14,0	16,3	23,0	110	10	099881	11,30
00050191282	12	80	15,5	17,8	23,0	115	10	003451	11,30
00050191382	13	80	12,0	18,9	23,0	125	10	003468	11,30
00050191482	14	80	15,0	20,2	23,0	130	10	003475	12,10
00050191582	15	80	16,0	21,5	23,0	150	10	003482	12,10
00050191682	16	80	16,0	22,8	23,5	160	10	003499	12,35
00050191782	17	80	15,0	24,0	23,0	135	10	003505	12,35
00050191882	18	80	24,5	24,5	23,5	120	10	003512	13,45
00050191982	19	80	15,0	26,6	23,5	140	10	003529	13,45
00050192182	21	80	18,0	29,1	23,5	165	10	003536	13,45
00050192282	22	80	23,0	30,5	23,5	175	10	003543	13,45
00050192482	24	80	24,0	32,9	24,3	200	10	003550	15,00
00050192682	26	80	24,0	35,2	25,8	240	10	003567	20,00
00050192782	27	80	27,0	36,8	26,3	240	10	003574	20,00
00050193082	30	80	32,0	40,0	27,0	265	10	003581	21,10
00050193282	32	80	32,0	43,0	29,0	290	10	003598	22,30

Code	AF	←L→ mm	T mm	D ₁ mm	D ₂ mm	g		EAN	€
00050195282	9/16	80	15,0	20,2	23,0	135	10	003611	18,65
00050195482	11/16	80	15,0	24,0	23,0	130	10	003635	21,55
00050195582	3/4	80	18,0	26,6	23,0	140	10	003642	21,55
00050195682	13/16	80	18,0	29,1	23,5	165	10	003659	21,55
00050195782	15/16	80	24,0	32,9	24,3	200	10	003666	21,55

50-19-1 - 50-19-3

Zündkerzen-Einsätze,
extra lang

~ DIN 3124 / ISO 2725

Chrom-Vanadium

CP = verchromt, teilweise poliert
mit Kugelfangbohrung,
mit GummeinsatzSpark plug sockets,
extra deep

~ DIN 3124 / ISO 2725

Chrome-Vanadium

CP = chromium plated, polished
head, with ball retaining groove,
with rubber insertDouilles pour bougies,
extra longues

~ DIN 3124 / ISO 2725

Chrome-Vanadium

CP = chromées, partiellement polies
avec gorge de verrouillage pour bille,
avec bague de caoutchouc de retenue de
la bougieLlaves de vaso, para bujías,
extra largo

~ DIN 3124 / ISO 2725

Cromo Vanadio

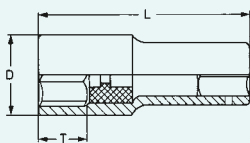
CP = cromado, cabeza pulida espejo
con ranura de retención por bola,
con injerto de goma para bujías

Code	No.	MM	AF	←L→ mm	T mm	D mm	g		EAN	€
00050190182	50-19-1	20,8	13/16	80	10,0	27,0	140	10	003413	13,60
00050190382	50-19-3	16	5/8	80	8,5	22,0	125	10	003444	12,35

50-20

Steckschlüssel-Einsätze

Chrom-Vanadium
 CPP = verchromt, ganz poliert
 mit Kugelfangrinne
 für Außen-TORX®-Schrauben

Sockets

Chrome-Vanadium
 CPP = chromium plated, fully
 polished, with ball retaining groove
 for TORX®-head screws

Douilles

Chrome-Vanadium
 CPP = chromées, entièrement polies
 avec gorge de verrouillage pour bille
 pour vis TORX®-extérieures

Llaves de vaso

Cromo Vanadio
 CPP = cromado, cabeza pulida espejo
 con ranura de retención por bola
 para tornillos TORX® exteriores

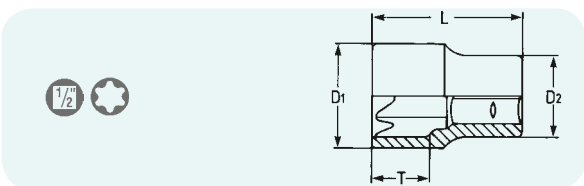

Code	Größe size	mm	L mm	T mm	D ₁ mm	D ₂ mm	g	g	EAN	€
00050201083	E 10	9,42	36	6,4	13,2	21,0	45	10	003697	9,15
00050201183	E 11	10,08	37	7,2	13,7	21,0	46	10	003703	9,15
00050201283	E 12	11,17	37	8,0	15,0	21,0	47	10	003710	9,15
00050201483	E 14	12,90	37	8,8	16,3	21,0	49	10	003727	9,15
00050201683	E 16	14,76	37	9,6	18,8	22,0	57	10	003734	9,60
00050201883	E 18	16,70	37	11,1	20,4	22,0	57	10	003741	10,55
00050202083	E 20	18,49	37	12,7	22,9	22,0	62	10	003758	11,45
00050202483	E 24	22,16	40	15,9	26,8	26,0	100	10	003765	12,35

50-30 - 50-36

Schraubendreher-Einsätze

Körper:
 Chrom-Vanadium
 CPP = verchromt, ganz poliert
 mit Kugelfangrinne

Screwdriver sockets

Socket bodies:
 Chrome-Vanadium
 CPP = chromium plated, fully
 polished, with ball retaining groove

Douilles tournevis

Douilles:
 Chrome-Vanadium
 CPP = chromées, entièrement polies
 avec gorge de verrouillage pour bille

Llaves de vaso con destornillador

Cuerpo:
 Cromo Vanadio
 CPP = cromado, enteramente pulido
 espejo, con ranura de retención por bola

Bits:
 Sonderstahl
 PH = phosphatiert

Bits:
 Special steel
 PH = phosphated

Embouts:
 Acier Spécial
 PH = phosphaté

Puntas:
 Acero aleado
 PH = fosfatado

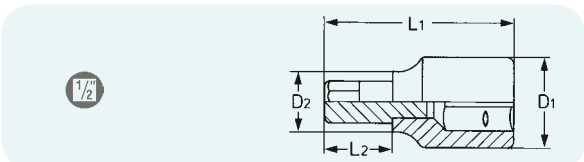

50-30 für Schlitz-Schrauben/for plain slot screws

Code	mm	mm	L ₁ mm	L ₂ mm	D ₁ mm	D ₂ mm	g	g	EAN	€
00050300183	8	1,2	62	22	22,5	16,0	71	10	003789	10,30
00050300283	8	1,6	62	22	22,5	18,0	77	10	003796	10,45
00050300383	10	1,6	62	22	22,5	20,0	87	10	003802	10,80
00050300483	12	2,0	62	22	22,5	25,0	115	10	003819	11,80
00050300583	14	2,5	62	22	24,0	28,0	141	10	003826	13,65

50-31 für Innensechskant-Schrauben/for hexagon socket screws, DIN 7422/ISO 1174

Code	MM	L ₁ mm	L ₂ mm	D ₁ mm	D ₂ mm	g	g	EAN	€
00050310183	4	52	12	22,5	15,0	67	10	003833	8,05
00050310283	5	52	12	22,5	15,0	67	10	003840	8,05
00050312183	5	120	80	22,5	16,0	80	10	396959	10,15
00050311483	5	180	140	22,5	15,0	96	10	003963	10,95
00050310383	6	52	12	22,5	15,0	68	10	003857	7,95
00050312283	6	120	80	22,5	16,0	100	10	396966	10,15
00050311583	6	137	97	22,5	15,0	87	10	003970	10,85
00050311683	6	160	120	22,5	15,0	93	10	003987	10,90
00050311783	7	52	12	22,5	15,0	69	10	003994	7,95
00050311383	7	100	60	22,5	15,0	89	10	003956	9,15
00050312383	7	120	80	22,5	16,0	100	10	396973	10,15
00050310483	8	52	12	22,5	15,0	70	10	003864	8,05
00050311083	8	100	60	22,5	15,0	90	10	003925	9,15
00050311283	8	120	80	22,5	15,0	99	10	003949	10,35
00050312083	9	52	12	22,5	18,0	80	10	395655	8,15
00050310583	10	52	12	22,5	17,0	79	10	003871	8,25
00050312483	10	120	80	22,5	18,0	120	10	396980	10,45
00050311183	10	140	100	22,5	17,0	140	10	003932	11,60
00050310683	12	52	12	22,5	20,0	90	10	003888	8,45
00050312583	12	120	80	22,5	20	140	10	396997	11,35
00050311883	12	140	100	22,5	20,0	170	10	099898	11,45
00050310783	14	52	12	22,5	24,5	115	10	003895	10,40
00050312683	14	120	80	22,5	25	200	10	397000	12,85
00050311983	14	140	100	22,5	24,5	200	10	099904	13,35
00050310883	17	60	20	24,0	27,5	163	10	003901	12,35
00050310983	19	60	20	24,0	30,0	188	10	003918	12,95

50-30 - 50-36

Schraubendreher-Einsätze | Screwdriver sockets

Douilles tournevis

Llaves de vaso con
destornillador

50-30



50-31



50-32



50-33



50-34





50-35



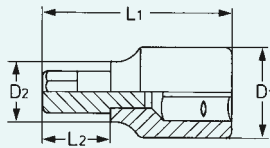

50-36

1/2



50-31  für Innensechskant-Schrauben/for hexagon socket screws, DIN 7422/ISO 1174

Code	AF	L ₁ mm	L ₂ mm	D ₁ mm	D ₂ mm			EAN	€
00050313283	3/16	52	12	22,5	16,0	68	10	004007	8,80
00050313483	1/4	52	12	22,5	16,0	70	10	004014	8,85
00050313683	5/16	52	12	22,5	16,0	70	10	004021	8,85
00050313883	3/8	52	12	22,5	18,0	80	10	004038	9,00
00050314083	7/16	52	12	22,5	20,0	85	10	004045	9,50
00050314283	1/2	52	12	22,5	25,0	115	10	004052	9,95
00050314483	9/16	60	20	24,0	28,0	150	10	004069	11,00
00050315083	3/4	60	20	24,0	30,0	185	10	004076	12,95



50-32  für Kreuzschlitz-Schrauben/for cross slot screws PHILLIPS-RECESS

Code	No.	L ₁ mm	L ₂ mm	D ₁ mm	D ₂ mm			EAN	€
00050320283	2	56	16	22,5	16,0	70	10	004083	11,55
00050320383	3	56	16	22,5	16,0	70	10	004090	11,55
00050320483	4	56	16	22,5	18,0	75	10	004106	11,55



50-33  für Innenvielzahn-Schrauben/for multi-spline socket screws XZN

Code	für Schrauben for screws	L ₁ mm	L ₂ mm	D ₁ mm	D ₂ mm			EAN	€
00050330183	M 5	52	12	22,5	16,0	70	10	004113	11,00
00050330283	M 6	52	12	22,5	16,0	70	10	004120	11,00
00050330383	M 8	53	13	22,5	16,0	70	10	004137	11,00
00050330483	M 8	100	60	22,5	16,0	90	10	004144	11,80
00050330583	M 10	53	13	22,5	18,0	80	10	004151	12,60
00050330683	M 10	120	80	22,5	18,0	120	10	004168	15,00
00050330783	M 12	55	15	22,5	20,0	90	10	004175	14,50
00050330883	M 12	100	60	22,5	20,0	130	10	004182	15,75
00050331183	M 12	140	100	22,5	20,0	170	10	004212	16,25
00050330983	M 14	58	18	22,5	25,0	115	10	004199	15,75
00050331083	M 16	60	20	24,0	28,0	150	10	004205	17,50



50-34  für Innenkeilprofil-Schrauben/for fluted socket screws RIBE CV

Code	für Schrauben for screws	L ₁ mm	L ₂ mm	D ₁ mm	D ₂ mm			EAN	€
00050340183	M 5	63	23	22,5	16,0	68	10	004229	12,00
00050340283	M 6	63	23	22,5	16,0	70	10	004236	12,25
00050340383	M 8	63	23	22,5	16,0	70	10	004243	12,60
00050340483	M 10	63	23	22,5	18,0	78	10	004250	12,65
00050340583	M 12	63	23	22,5	20,0	93	10	004267	13,80
00050340683	M 14	63	23	22,5	25,0	120	10	004274	15,55
00050340783	M 16	63	23	24,0	28,0	152	10	004281	17,30

50-35  für Kreuzschlitz-Schrauben/for cross slot screws POZIDRIV®

Code	No.	L ₁ mm	L ₂ mm	D ₁ mm	D ₂ mm			EAN	€
00050350283	2	56	16	22,5	16,0	70	10	004298	12,65
00050350383	3	56	16	22,5	16,0	70	10	004304	12,65
00050350483	4	56	16	22,5	18,0	75	10	004311	12,65

50-36  für Innen-TORX®-Schrauben/for TORX®-socket screws

Code	Größe size	 mm	L ₁ mm	L ₂ mm	D ₁ mm	D ₂ mm			EAN	€
00050362083	T 20	3,86	55	15	22,5	16,0	65	10	004328	12,10
00050362583	T 25	4,43	55	15	22,5	16,0	65	10	004335	12,10
00050362783	T 27	4,99	55	15	22,5	16,0	67	10	004342	12,10
00050363083	T 30	5,52	55	15	22,5	16,0	68	10	004359	12,10
00050364083	T 40	6,65	55	15	22,5	16,0	70	10	004366	12,10
00050364183	T 40	6,65	120	80	22,5	16,0	100	10	099911	15,40
00050364583	T 45	7,82	55	15	22,5	16,0	72	10	004373	12,10
00050364683	T 45	7,82	120	80	22,5	16,0	110	10	099928	15,40
00050365083	T 50	8,83	58	18	22,5	18,0	80	10	004380	12,90
00050365183	T 50	8,83	140	100	22,5	18,0	120	10	099935	15,30
00050365583	T 55	11,22	58	18	22,5	25,0	110	10	004397	16,40
00050365683	T 55	11,22	140	100	22,5	25,0	170	10	099942	18,35
00050366083	T 60	13,25	58	18	22,5	25,0	115	10	004403	16,40

1/2"

50-50

Satz mit Schraubendreher- und Steckschlüssel-Einsätzen

Chrom-Vanadium
CPP = verchromt,
ganz poliert
Metallkasten 225 x 115 x 38 mm

Combined set of sockets
and screwdriver sockets

Chrome-Vanadium
CPP = chromium plated,
fully polished
Metal case 225 x 115 x 38 mm

Compositions de douilles
et de douilles-tournevis

Chrome-Vanadium
CPP = chromées,
entièrement polies
Coffret métallique 225 x 115 x 38 mm

Juegos de llaves de vaso con
destornillador

Cromo Vanadio
CPP = cromado,
enteramente pulido espejo
Caja metálica 225 x 115 x 38 mm



für TORX®-Schrauben/for TORX®-screws

Code	No.	tlg./pcs.			EAN	€
00050500083	50-50-E/T	16	1550	1	004410	192,85

enthaltend/containing			
Stck./pcs.	Artikel/article	No.	Maße/dimensions
je 1 each		50-20	E 10 E 11 E 12 E 14 E 16 E 18 E 20 E 24
je 1 each		50-36	T 25 T 27 T 30 T 40 T 45 T 50 T 55 T 60

50-55-2 - 50-58

Sätze mit Schraubendreher-Einsätzen

Chrom-Vanadium
CPP = verchromt,
ganz poliert
Metallkasten 225 x 115 x 38 mm

Sets with screwdriver
sockets

Chrome-Vanadium
CPP = chromium plated,
fully polished
Metal case 225 x 115 x 38 mm

Jeux de douilles tournevis

Chrome-Vanadium
CPP = chromées,
entièrement polies
Coffret métallique 225 x 115 x 38 mm

Juegos de llaves de vaso
con destornillador

Cromo Vanadio
CPP = cromado,
enteramente pulido espejo
Caja metálica 225 x 115 x 38 mm



für Innensechskant-Schrauben/for hexagon socket screws

Code	No.	tlg./pcs.			EAN	€
00050550283	50-55-2-M	8	1200	1	004434	85,95

enthaltend/containing			
Stck./pcs.	Artikel/article	No.	Maße/dimensions
8		50-31	MM 5 x 52 6 x 52 7 x 52 8 x 52 10 x 52 12 x 52 14 x 52 17 x 52

für Innen-TORX®-Schrauben/for TORX®-socket screws

Code	No.	tlg./pcs.			EAN	€
00050580083	50-58	8	1120	1	004472	117,85

enthaltend/containing			
Stck./pcs.	Artikel/article	No.	Maße/dimensions
8		50-36	T 25 T 27 T 30 T 40 T 45 T 50 T 55 T 60

50-78 - 50-79

Steckschlüssel-Einsätze auf Aluminium-Klemmleiste, 16-tlg.

Aluminium-Klemmleiste grün eloxiert.
Chrom-Vanadium
CPP = verchromt, ganz poliert mit Kugelfangrinne

Sockets on aluminium socket rail, 16 pcs.

Aluminium socket rail, anodized.
Chrome-Vanadium
CPP = chromium plated, fully polished, with ball retaining groove

Assortiment douilles sur bande alu, 16 pces.

Bloc aluminium anodisé.
Chrome-Vanadium
CPP = chromées, entièrement polies avec gorge de verrouillage pour bille

Juego de 16 llaves de vaso en regla de sujeción de aluminio

Regla de sujeción, de aluminio anodizado color verde.
Cromo Vanadio
CPP = cromado, cabeza pulida espejo con ranura de retención por bolae



Code	No.	tlg./pcs.			EAN	€
00050780083	50-78-M	16	1841	1	366693	170,30
00050790083	50-79-M	16	1716	1	366709	170,30

enthaltend/containing			
Stck./pcs.	Artikel/article	No.	Maße/dimensions
16		50-78-M	MM 10 11 12 13 14 15 16 17 18 19 21 22 24 27 30 32
16		50-79-M	MM 10 11 12 13 14 15 16 17 18 19 21 22 24 27 30 32

987-50

Aluminium-Klemmleiste, leer

zur Aufnahme von max. 16 Einsätzen
Kugelfedernte Aufnahme gewährleistet perfekten Halt der Einsätze.
Sicherer Halt der Klemmleiste durch Magnet an Metallflächen.

Aluminium socket rail, empty

for max. 16 sockets
Spring-loaded retaining ball ensures a perfect hold of the sockets. A strong magnet securely holds the socket rail to ferrous metal.

Bornes en aluminium, vide

pour max. 16 inserts
Les billes à ressort assurent une parfaite prise en main.
Blocage des bornes dues aux aimants et les surfaces métalliques.

Regla de aluminio anodizado color verde

para sujeción de 16 llaves de vaso
Sujeción con muelle, garantiza una firme colocación de los vasos.
Regla sujeta por imán.

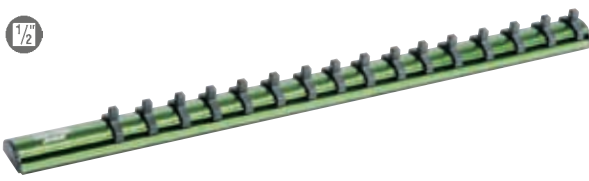

Code	No.	tlg./pcs.			EAN	€
98710501600	987-50	1	301	1	365290	40,80

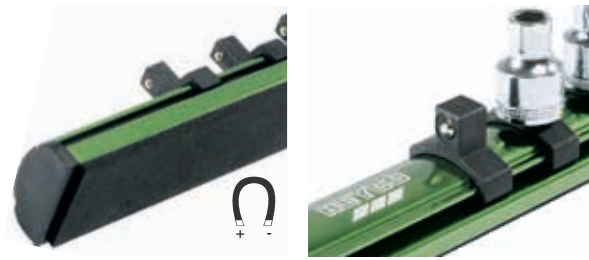

1/2"

50-65 - 50-77

Kombi-Spender mit Steckschlüssel- und Schraubendreher-Einsätzen

aus Stahlblech, zum Aufstellen und Hängen; problemloses Bestücken beider Schütten durch herausnehmbares Oberteil; variable Einteilung durch Trennleistensystem, daher Zusammenstellung von Sortimenten nach Wahl möglich; aufschiebbare Zusatzschale mit Hartschauminlage zum senkrechten Einstecken von Schraubendreher-Einsätzen extra lang. Folgende Sortimente führen wir standardmäßig:

Dispensers containing sockets and screwdriver sockets

sheet steel, for counter-display and wall mounting; simple re-filling of both dispenser units with removable upper tray; variable system of partitions permits composition of different assortments to choice; additional slide-on tray with hard foam insert for vertical presentation of screwdriver sockets, converters etc.

The following assortments represent our standard range:

Présentoirs combinés avec douilles et douilles-tournevis

en tôle d'acier, pour présentation sur comptoir ou montage mural; remplissage facile des deux glissières grâce à la partie supérieure démontable; un système variable de cloisonnement permet des compositions différentes au choix; le plateau additionnel enfilable avec insert troué de mousse rigide permet l'insertion verticale des douilles tournevis, augmentateurs/réducteurs, etc.

Les compositions suivantes sont standardisées:

Expositor combinado de llaves de vaso y vasos con destornillador

de chapa de acero, de sobremesa o para colgar, ambos cargadores facilmente recargables, gracias a la parte superior desmontable; separaciones ajustables por sistema de listones que permiten componer los surtidos a elección del usuario, suplemento acoplable con cama de espuma de polietileno, para la colocación vertical de llaves de vaso con destornillador reductores/ampliadores.

Los siguientes surtidos son standard:

1/2"



50-65

Code	No.	tlg./pcs.			EAN	€
00050650083	50-65-M	325	40098	1	004779	3.488,65

317 Schraubendreher-Einsätze/screwdriver sockets, 8 Verbindungsstücke/converters enthaltend/containing

Stck. pcs.	Artikel/article	No.	Maße/dimensions
4		40-15	35 mm
4		50-14-1	38 mm
je 10 each		50-30	8 x 1,2 8 x 1,6 10 x 1,6 12 x 2,0 14 x 2,5 mm
je 9 each		50-31	MM 4 x 52 5 x 52
4		50-31	MM 5 x 180
9		50-31	MM 6 x 52
je 4 each		50-31	MM 6 x 137 6 x 160 7 x 100
9		50-31	MM 8 x 52
8		50-31	MM 8 x 100
4		50-31	MM 8 x 120
9		50-31	MM 10 x 52
8		50-31	MM 10 x 140
je 9 each		50-31	MM 12 x 52 14 x 52 17 x 60 19 x 60
je 10 each		50-32	PH No. 2 3
je 10 each		50-33	M 6 x 52 8 x 53
4		50-33	M 8 x 100
10		50-33	M 10 x 53
4		50-33	M 10 x 120
10		50-33	M 12 x 55
je 4 each		50-33	M 12 x 100 12 x 140
je 10 each		50-35	PZ No. 2 3
je 9 each		50-36	T 20 T 25 T 30 T 40 T 45 T 50

Code	No.	tlg./pcs.			EAN	€
00050750083	50-75-M	258	32750	1	004854	2.174,05

198 Doppel-6-kant Steckschlüssel-Einsätze/bihexagon sockets MM, 52 Schraubendreher-Einsätze/screwdriver sockets, 8 Verbindungsstücke/converters enthaltend/containing

Stck. pcs.	Artikel/article	No.	Maße/dimensions
je 10 each		50-12	MM 8 9 10 11 12 13 14 15 16
je 8 each		50-12	MM 17 18 19 20 21 22 23 24 25
je 6 each		50-12	MM 26 27 28 29 30 32
4		40-15	35 mm
4		50-14-1	38 mm
je 4 each		50-30	8 x 1,2 10 x 1,6 mm
je 4 each		50-31	MM 4 x 52 5 x 52 6 x 52 8 x 52 10 x 52 12 x 52 14 x 52 17 x 60 19 x 60
je 4 each		50-32	PH No. 2 3

50-65 - 50-77

Kombi-Spender mit Steckschlüssel- und Schraubendreher-Einsätzen

Dispensers containing sockets and screwdriver sockets

Présentoirs combinés avec douilles et douilles-tournevis

Expositor combinado de llaves de vaso y vasos con destornillador



50-77

Code	No.	tlg./pcs.			EAN	€
00050760083	50-76-M	258	33550	1	004892	2.174,05

198 6-kant Steckschlüssel-Einsätze/hexagon sockets MM, 52 Schraubendreher-Einsätze/screwdriver sockets, 8 Verbindungsstücke/converters wie/as 50-75-M, jedoch/but

Stck. pcs.	Artikel/article	No.	Maße/dimensions
		50-6	Mengen und Maße siehe/quantities and dimensions see 50-75

Code	No.	tlg./pcs.			EAN	€
00050770083	50-77-AF	266	32975	1	004922	2.235,85

206 Doppel-6-kant Steckschlüssel-Einsätze/bihexagon sockets AF, 52 Schraubendreher-Einsätze/screwdriver sockets, 8 Verbindungsstücke/converters enthaltend/containing

Stck. pcs.	Artikel/article	No.	Maße/dimensions
je 20 each		50-12	AF 3/8 7/16 1/2 9/16
10		50-12	AF 19/32
20		50-12	AF 5/8
8		50-12	AF 11/16
16		50-12	AF 3/4
je 8 each		50-12	AF 25/32 13/16 7/8 15/16 31/32 1
je 6 each		50-12	AF 1.1/16 1.1/8 1.3/16 1.1/4
4		40-15	35 mm
4		50-14-1	38 mm
je 4 each		50-30	8 x 1,2 12 x 2,0 mm
je 4 each		50-31	AF 3/16 1/4 5/16 3/8 52 mm
8		50-31	AF 1/2 x 52 mm
8		50-31	AF 9/16 x 60 mm
4		50-31	AF 3/4 x 60 mm
je 4 each		50-32	PH No. 2 3

50-80 - 50-80-40

Kombi-Spender, leer und Zubehör

50-80 Kombi-Spender, leer, mit 2 Schütten
 50-80-10 Trennleiste für Kombi-Spender (untere Schütte)
 50-80-20 Trennleiste für Kombi-Spender (obere Schütte)
 50-80-30 Aufschiebbare Zusatzschale für Kombi-Spender
 50-80-40 Gelochte Hartschaum-Einlage für Zusatzschale 50-80-30

L = lackiert, Z = verzinkt
 ST = standardmäßig
 (Hartschaum, schwarz)

Dispensers, empty and accessories

50-80 Dispenser, empty, with 2 trays
 50-80-10 Partitions for dispenser (lower tray)
 50-80-20 Partitions for dispenser (upper tray)
 50-80-30 Slide-on tray for dispenser
 50-80-40 Perforated hard foam insert for slide-on tray 50-80-30

L = lacquered, Z = galvanized
 ST = standard
 (hard foam, black)

Présentoirs combinés, vides et accessoires

50-80 Présentoir combiné, vide, avec 2 glissières
 50-80-10 Cloisonnement pour présentoir combiné (glissière inférieure)
 50-80-20 Cloisonnement pour présentoir combiné (glissière supérieure)
 50-80-30 Plateau additionnel enfilable sur présentoir combiné
 50-80-40 Insert troué de mousse rigide pour plateau additionnel 50-80-30

L = laquées, Z = galvanisés
 ST = standard
 (mousse rigide noire)

Expositores combinados, vacíos y accesorios

50-80 Expositor combinado, vacío, con 2 cargadores
 50-80-10 Listón separador para expositor combinado (cargador inferior)
 50-80-20 Listón separador para expositor combinado (cargador superior)
 50-80-30 Suplemento acoplable para expositor combinado
 50-80-40 Cama de espuma de polietileno perforada para suplemento 50-80-30

L = barnizado, Z = zincado
 ST = standard
 (espuma de polietileno, negro)



Benötigtes Zubehör-Sortiment für Kombi-Spender/required accessories for dispenser:

Code	No.	für Kombi-Spender for dispenser			bestehend aus consisting of Stck. No.		EAN	€
00050800100	50-80-1	40-75	40-76		1 50-80 16 50-80-10 18 50-80-20	004984		
00050800200	50-80-2	40-85	40-88		1 50-80 16 50-80-10 16 50-80-20	004991		
00050800300	50-80-3	50-65			1 50-80 13 50-80-10 13 50-80-20 1 50-80-30 1 50-80-40	005004	auf Anfrage	
00050800400	50-80-4	50-75	50-76	50-77	1 50-80 9 50-80-10 13 50-80-20 1 50-80-30 1 50-80-40	005011	on request	

Code	No.	Ausf. finish	Maße/dimensions mm	g	Stk. No.	EAN	€
00050800020	50-80	L	470 x 320 x 234	8250	1	004977	auf Anfrage
00050801060	50-80-10	Z	289 x 20 x 1,5	65	10	005035	
00050802060	50-80-20	Z	234 x 20 x 1,5	53	10	005042	
00050803020	50-80-30	L	474 x 155 x 36	1300	1	005059	on request
00050804000	50-80-40	ST	470 x 150 x 20	25	1	005066	

50-85 - 50-87 / 50-95 - 50-97

Einsatzspender mit Steckschlüssel-Einsätzen

aus Stahlblech, zum Aufstellen und Hängen

Socket dispensers

sheet steel, for counter display and wall mounting

Présentoirs avec douilles

en tôle d'acier, pour présentation sur comptoir ou montage mural

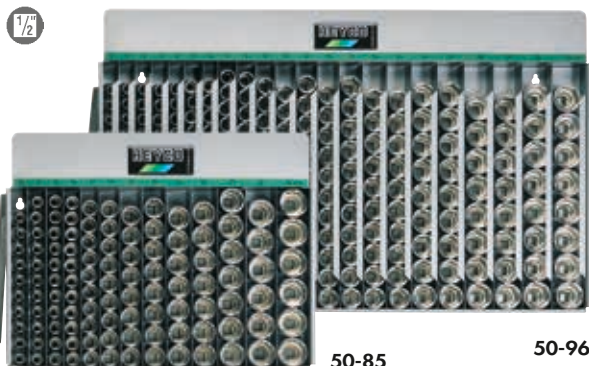

Expositores de llaves de vaso

de chapa de acero, de sobremesa y para colgar





Code	No.	tlg./pcs.	g	Stk. No.	EAN	€
00050850083	50-85-M	102	12100	1	005073	837,45

enthaltend/containing

Stck./pcs.	Artikel/article	No.	Maße/dimensions
je 10 each	 	50-12	MM 10 11 13 14
je 9 each		50-12	MM 17 19
8		50-12	MM 21
je 7 each		50-12	MM 22 24
je 6 each		50-12	MM 25 27
je 5 each		50-12	MM 30 32

Code	No.	tlg./pcs.	g	Stk. No.	EAN	€
00050860083	50-86-M	102	12500	1	005080	837,45

wie/as 50-85-M, jedoch/but

Stck./pcs.	Artikel/article	No.	Maße/dimensions
	 	50-6	Mengen und Maße siehe/quantities and dimensions see 50-85-M

50-85 - 50-87 / 50-95 - 50-97

Einsatzspender mit Steckschlüssel-Einsätzen

aus Stahlblech, zum Aufstellen und Hängen

Socket dispensers

sheet steel, for counter display and wall mounting

Présentoirs avec douilles

en tôle d'acier, pour présentation sur comptoir ou montage mural

Expositores de llaves de vaso

de chapa de acero, de sobremesa y para colgar

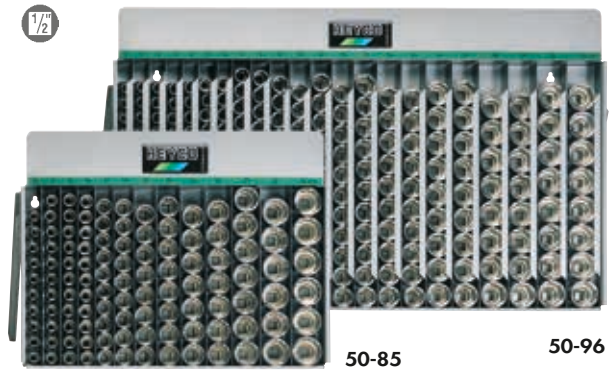

Code	No.	tlg./pcs.			EAN	€
00050870083	50-87-AF	109	12300	1	005097	893,65

enthaltend/containing			
Stck./pcs.	Artikel/article	No.	Maße/dimensions
je 10 each		50-12	AF 3/8 7/16 1/2 9/16 5/8 11/16
9		50-12	AF 3/4
je 8 each		50-12	AF 13/16 7/8
7		50-12	AF 15/16
je 6 each		50-12	AF 1 1.1/8
5		50-12	AF 1.1/4

Code	No.	tlg./pcs.			EAN	€
00050950083	50-95-M	278	31400	1	005127	2.234,65

enthaltend/containing			
Stck./pcs.	Artikel/article	No.	Maße/dimensions
je 16 each		50-12	MM 10 11 12 13 14 15 16
15		50-12	MM 17
14		50-12	MM 18
je 13 each		50-12	MM 19 20
je 12 each		50-12	MM 21 22
je 11 each		50-12	MM 23 24
je 10 each		50-12	MM 25 26 27
je 9 each		50-12	MM 28 29 30
8		50-12	MM 32

Code	No.	tlg./pcs.			EAN	€
00050960083	50-96-M	278	32500	1	005134	2.234,65

wie/as 50-95-M, jedoch/but			
Stck./pcs.	Artikel/article	No.	Maße/dimensions
		50-6	Mengen und Maße siehe/quantities and dimensions see 50-95-M

Code	No.	tlg./pcs.			EAN	€
00050970083	50-97-AF	294	30800	1	005141	2.332,75

enthaltend/containing			
Stck./pcs.	Artikel/article	No.	Maße/dimensions
je 32 each		50-12	AF 3/8 7/16 1/2
je 16 each		50-12	AF 9/16 19/32
32		50-12	AF 5/8
15		50-12	AF 11/16
je 13 each			50-12
12	50-12		AF 7/8
je 11 each		50-12	AF 15/16 31/32
je 10 each		50-12	AF 1 1.1/16
je 9 each		50-12	AF 1.1/8 1.3/16
8		50-12	AF 1.1/4

50-90 - 50-100

Einsatzspender, leer

L = lackiert

Socket dispensers, empty

L = lacquered

Présentoirs, vides

L = laquées

Expositores vacíos

L = barnizado

Code	No.	für No.	Maße mm			EAN	€
00050900020	50-90	50-85 – 50-89	450 x 330 x 55	3250	1	005110	auf Anfrage
00050000120	50-100	50-95 – 50-99	745 x 455 x 55	6500	1	002317	on request



57-0010

Steckschlüssel-Garnitur

Chrom-Vanadium
CPP = verchromt,
ganz poliert
Metallkasten 407 x 162 x 53 mm

Socket set

Chrome-Vanadium
CPP = chromium plated,
fully polished
Metal case 407 x 162 x 53 mm



Compositions de douilles

Chrome-Vanadium
CPP = chromées,
entièrement polies
Coffret métallique 407 x 162 x 53 mm

Juegos de llaves de vaso

Cromo Vanadio
CPP = cromado,
enteramente pulido espejo
Caja metálica 407 x 162 x 53 mm

für TORX®-Schrauben/for TORX®-screws

Code	No.	tlg./pcs.			EAN	€
00057001083	57-0010	20	3886	1	329667	339,35

enthaltend/containing			
Stck./pcs.	Artikel/article	No.	Maße/dimensions
7		50-20	E 10 E 12 E 14 E 16 E 18 E 20 E 24
8		40-36	T 25 T 27 T 30 T 40 T 45 T 50 T 55 T 60
1		50-00-10	270 mm
1		40-03	200 mm
1		40-04	125 mm
1		40-06	50 mm

67-50 - 67-80

Expert „75 Jahre Edition“

Chrom-Vanadium
CP = verchromt, teilweise poliert
Lieferbar mit Steckschlüssel-Einsätzen
6-Kt. oder 12-Kt.
in hochwertigem Kunststoffkoffer ABS
480 x 320 x 150 mm

Expert „75 Years Edition“

Chrome-Vanadium
CP = chromium plated, partly
polished, available with sockets,
hexagon or 12-point
in a high grade ABS case
480 x 320 x 150 mm

Expert „Edition 75 Années“

Chrome-Vanadium
CP = chromées, partiellement polis
disponible avec Sockets 6-pt ou 12 points
Coffre de haute qualité ABS
480 x 320 x 150 mm

Expert „Edición 75 Años“

Cromo Vanadio
CP = cromado, pulido en parte
se suministra con un jgo. de llaves de vaso
hexagonales o estrella
en cofre ABS de alta gama
480 x 320 x 150 mm



Code	No.	tlg./pcs.			EAN	€
00067500082	67-50-M-CP	77	11656	1	377217	873,10

enthaltend/containing			
Stck./pcs.	Artikel/article	No.	Maße/dimensions
12		50-12 CPP	MM 10 11 12 13 14 15 16 17 19 21 22 24
1		50-00-10 CPP	275 mm
1		50-04 CPP	125 mm
1		50-05 CPP	250 mm
1		50-06 CPP	80 mm
2		50-19-1	20,8 mm / 5/8 AF
1		300 CPI	240 mm
13		400 CP	MM 6 8 10 11 12 13 14 15 16 17 19 22 24
1		1200 CPI	180 mm
1		1213 CPI	160 mm
8		1340 B	MM 2 2.5 3 4 5 6 8 10
8		1348 B	T 9 10 15 20 25 27 30 40
1		1424 N	3 x 65 mm
1		1520 LS	300 g
1		1664 ST	18 mm
1		1721 ST	110 mm, 1W
1		1840-5 ST	5 m
2		4511 C	PH No. 1 2
2		4530 C	5,5 x 100 mm 8,0 150 mm
12		25-6	MM 4 4,5 5 5,5 6 7 8 9 10 11 12 13
1		25-00-10	140 mm
1		25-03	115 mm
1		25-04	50 mm
1		25-05-1	150 mm
1		25-06	35 mm
1		25-08	145 mm



Expert  

Werkzeugsortiment Expert „75 Jahre Edition“
Der Werkzeugkoffer mit der besonderen Ausstattung

Tool set Expert „75 Years Edition“
The tool set with the exceptional configuration

Jeu d'outils Expert „Edition 75 Années“
La boîte à outils avec l'équipement spécial

Expert juego herramientas „Edición 75 Años“
El cofre de herramientas con el equipamiento especial



- Bis zu 30 kg belastbarer Doppelaluminiumrahmen, mit Kippzylinderschloss
Maße: 480 x 320 x 150 mm
- Twin-aluminium frame, resilient up to 30 kg, with tip cylinder lock
Dimensions: 480 x 320 x 150 mm
- Cadre aluminium double chargeable jusque 30 kg, avec cylindre kipp
Dimensions: 480 x 320 x 150 mm
- Marco doble de aluminio, carga hasta 30 kgs., con cerradura cilíndrica
Medidas: 480 x 320 x 150 mm



- Sicherer Halt der Werkzeuge beim Transport durch hochwertige Schaumstoffeinlage
- Secure locking of tools at transport through high grade foam inlay
- Les instruments sont en cours de transport bien protégée grâce à une mousse de haute qualité
- Firme sujeción de las htas. durante el transporte, gracias a la cama de poliespan



- Inklusive herausnehmbarer 1/4" Steckschlüssel-Garnitur, 17-tlg.
- Including detachable 1/4" socket set, 17 pcs.
- Y compris jeu de douilles 1/4" , 17 pcs., démontable
- Inclusive jgo.extraíble de llaves de vaso 1/4" de 17 pzs.

1/2" 1/4"

67-50 – 67-80

Expert „75 Jahre Edition“

Chrom-Vanadium
 CP = verchromt, teilweise poliert
 Lieferbar mit Steckschlüssel-Einsätzen
 6-Kt. oder 12-Kt.
 in hochwertigem Kunststoffkoffer ABS
 480 x 320 x 150 mm

Expert „75 Years Edition“

Chrome-Vanadium
 CP = chromium plated, partly
 polished, available with sockets,
 hexagon or 12-point
 in a high grade ABS case
 480 x 320 x 150 mm

Expert „Edition 75 Années“

Chrom-Vanadium
 CP = chromées, partiellement polis
 disponible avec Sockets 6-pt ou 12 points
 Coffre de haute qualité ABS
 480 x 320 x 150 mm

Expert „Edición 75 Años“

Cromo Vanadio
 CP = cromado, pulido en parte
 se suministra con un jgo. de llaves de vaso
 hexagonales o estrella
 en cofre ABS de alta gama
 480 x 320 x 150 mm

SP SP



Code	No.	tlg./pcs.	g	g	EAN	€
00067520082	67-52-AF	77	11741	1	388046	873,10

wie/as 67-50-M, jedoch/but

Stck./pcs.	Artikel/article	No.	Maße/dimensions
12	SP	50-12 AF	AF 3/8" / 7/16" / 1/2" / 9/16" / 19/32" / 5/8" / 11/16" / 3/4" / 13/16" / 7/8" / 15/16" / 1"
13		400 AF	AF 1/4" / 5/16" / 3/8" / 7/16" / 1/2" / 9/16" / 19/32" / 5/8" / 11/16" / 3/4" / 7/8" / 15/16" / 1"
1		27-4010 AF	AF 1"
8		1340 AF	AF 5/64" / 3/32" / 1/8" / 5/32" / 3/16" / 1/4" / 5/16" / 3/8"

Code	No.	tlg./pcs.	g	g	EAN	€
00067800082	67-80-M-CP	77	11741	1	377224	873,10

wie/as 67-50-M, jedoch/but

Stck./pcs.	Artikel/article	No.	Maße/dimensions
12	SP	50-6 CPP	MM 10 11 12 13 14 15 16 17 19 21 22 24

70-0 - 70-3010

Steckschlüssel-Garnituren

Chrom-Vanadium
 CPP = verchromt,
 ganz poliert
 Metallkasten 318 x 119 x 49 mm

Socket sets

Chrome-Vanadium
 CPP = chromium plated,
 fully polished
 Metal case 318 x 119 x 49 mm

Compositions de douilles

Chrom-Vanadium
 CPP = chromées,
 entièrement polies
 Coffret métallique 318 x 119 x 49 mm

Juegos de llaves de vaso

Cromo Vanadio
 CPP = cromado,
 enteramente pulido espejo
 Caja metálica 318 x 119 x 49 mm

1/2"



70-0010



Code	No.	tlg./pcs.	g	g	EAN	€
00070001083	70-0010-M	15	2795	1	100570	195,10

enthaltend/containing

Stck./pcs.	Artikel/article	No.	Maße/dimensions
12	SP	50-12 CPP	MM 10 11 12 13 14 15 16 17 18 19 20 22
1		50-00-10 CP	275 mm
1		50-03 CPP	300 mm
1		50-05 CPP	250 mm

Code	No.	tlg./pcs.	g	g	EAN	€
00070000083	70-0-M	15	2715	1	005394	180,70

wie/as 70-0010-M, jedoch/but

Stck./pcs.	Artikel/article	No.	Maße/dimensions
1		50-00-7 CP	270 mm

Code	No.	tlg./pcs.	g	g	EAN	€
00070500083	70-50-M	15	2710	1	005523	162,00

wie/as 70-0010-M, jedoch/but

Stck./pcs.	Artikel/article	No.	Maße/dimensions
1		50-00-1 CP	270 mm

70-0 - 70-3010

Steckschlüssel-Garnituren | Socket sets

1/2



70-0010

Compositions de douilles

Juegos de llaves de vaso

Code	No.	tlg./pcs.			EAN	€
00070301083	70-3010-M	15	2825	1	100778	195,10

wie/as 70-0010-M, jedoch/but

Stck./pcs.	Artikel/article	No.	Maße/dimensions
12		50-6 CPP	MM 10 11 12 13 14 15 16 17 18 19 20 22

Code	No.	tlg./pcs.			EAN	€
00070300083	70-30-M	15	2745	1	005509	180,70

wie/as 70-0010-M, jedoch/but

Stck./pcs.	Artikel/article	No.	Maße/dimensions
12		50-6 CPP	MM 10 11 12 13 14 15 16 17 18 19 20 22
1		50-00-7 CP	270 mm

Code	No.	tlg./pcs.			EAN	€
00070800083	70-80-M	15	2740	1	005592	162,00

wie/as 70-0010-M, jedoch/but

Stck./pcs.	Artikel/article	No.	Maße/dimensions
12		50-6 CPP	MM 10 11 12 13 14 15 16 17 18 19 20 22
1		50-00-1 CP	270 mm

Code	No.	tlg./pcs.			EAN	€
00070101083	70-1010-AF	15	2855	1	100594	206,10

wie/as 70-0010-M, jedoch/but

Stck./pcs.	Artikel/article	No.	Maße/dimensions
12		50-12 CPP	AF 3/8 7/16 1/2 9/16 19/32 5/8 11/16 3/4 25/32 13/16 7/8 15/16

72-4010 - 72-4310

Steckschlüssel-Garnituren

Socket sets

Chrom-Vanadium
CPP = verchromt,
ganz poliert
in Schaumstoffeinlage
Metallkasten 318 x 119 x 49 mm

Chrome-Vanadium
CPP = chromium plated,
fully polished
in foam-insert
Metal case 318 x 119 x 49 mm

1/2 3/8



72-4310

Compositions de douilles

Juegos de llaves de vaso

Chrom-Vanadium
CPP = chromées,
entièrement polies
insert en mousse
Coffret métallique 318 x 119 x 49 mm

Cromo Vanadio
CPP = cromado,
enteramente pulido espejo
en bandeja de polispam
Caja metálica 318 x 119 x 49 mm

Code	No.	tlg./pcs.			EAN	€
00072401083	72-4010-M	21	2547	1	329704	218,20

enthaltend/containing

Stck./pcs.	Artikel/article	No.	Maße/dimensions
9		40-12 CPP	MM 6 7 8 9 10 11 12 13 14
9		50-12 CPP	MM 15 16 17 18 19 21 22 23 24
1		50-40-10 CPP	200 mm
1		50-14-1 CPP	36 mm
1		50-04-5 CPP	125 mm

Code	No.	tlg./pcs.			EAN	€
00072431083	72-4310-M	21	2625	1	329711	218,20

wie/as 72-4010-M, jedoch/but

Stck./pcs.	Artikel/article	No.	Maße/dimensions
9		40-6 CPP	MM 6 7 8 9 10 11 12 13 14
9		50-6 CPP	MM 15 16 17 18 19 21 22 23 24

1/2" SP

73-03 - 73-3310

Steckschlüssel-Garnituren

Chrom-Vanadium
 CPP = verchromt,
 ganz poliert
 Metallkasten 450 x 187 x 52 mm

Socket sets

Chrome-Vanadium
 CPP = chromium plated,
 fully polished
 Metal case 450 x 187 x 52 mm

1/2" SP



73-0310

Compositions de douilles

Chrome-Vanadium
 CPP = chromées,
 entièrement polies
 Coffret métallique 450 x 187 x 52 mm

Juegos de llaves de vaso

Cromo Vanadio
 CPP = cromado,
 enteramente pulido espejo
 Caja metálica 450 x 187 x 52 mm

Code	No.	tlg./pcs.			EAN	€
00073030083	73-03-M	23	4850	1	005677	284,25

enthaltend/containing

Stck./pcs.	Artikel/article	No.	Maße/dimensions
18		50-12 CPP	MM 10 11 12 13 14 15 16 17 18 19 20 21 22 23 24 27 30 32
1		50-00-7 CPP	270 mm
1		50-03 CPP	300 mm
1		50-04 CPP	125 mm
1		50-05 CPP	250 mm
1		50-06 CPP	80 mm

Code	No.	tlg./pcs.			EAN	€
00073330083	73-33-M	23	5130	1	304664	284,25

wie/as 73-03-M, jedoch/but

Stck./pcs.	Artikel/article	No.	Maße/dimensions
18		50-6 CPP	MM 10 11 12 13 14 15 16 17 18 19 20 21 22 24 27 30 32
1		50-00-7 CP	270 mm

Code	No.	tlg./pcs.			EAN	€
00073031083	73-0310-M	23	5215	1	329827	298,65

wie/as 73-03-M, jedoch/but

Stck./pcs.	Artikel/article	No.	Maße/dimensions
18		50-12 CPP	MM 10 11 12 13 14 15 16 17 18 19 20 21 22 23 24 27 30 32
1		50-00-10 CP	275 mm

Code	No.	tlg./pcs.			EAN	€
00073331083	73-3310-M	23	5360	1	329810	298,65

wie/as 73-03-M, jedoch/but

Stck./pcs.	Artikel/article	No.	Maße/dimensions
18		50-6 CPP	MM 10 11 12 13 14 15 16 17 18 19 20 21 22 23 24 27 30 32
1		50-00-10 CP	275 mm

75-0 - 75-3310

Steckschlüssel-Garnituren

Chrom-Vanadium
 CPP = verchromt,
 ganz poliert
 Metallkasten 450 x 187 x 52 mm

Socket sets

Chrome-Vanadium
 CPP = chromium plated,
 fully polished
 Metal case 450 x 187 x 52 mm

1/2"



75-0010

Compositions de douilles

Chrom-Vanadium
 CPP = chromées,
 entièrement polies
 Coffret métallique 450 x 187 x 52 mm

Juegos de llaves de vaso

Cromo Vanadio
 CPP = cromado,
 enteramente pulido espejo
 Caja metálica 450 x 187 x 52 mm

Code	No.	tlg./pcs.			EAN	€
00075001083	75-0010-M	24	5450	1	100617	332,80

enthaltend/containing

Stck./pcs.	Artikel/article	No.	Maße/dimensions
18		50-12 CPP	MM 12 13 14 15 16 17 18 19 20 21 22 23 24 26 27 28 30 32
1		50-00-10 CPP	275 mm
1		50-02 CPP	405 mm
1		50-03 CPP	300 mm
1		50-04 CPP	125 mm
1		50-05 CPP	250 mm
1		50-06 CPP	80 mm

Code	No.	tlg./pcs.			EAN	€
00075000083	75-0-M	24	5360	1	005691	318,45

wie/as 75-0010-M, jedoch/but

Stck./pcs.	Artikel/article	No.	Maße/dimensions
1		50-00-7 CP	270 mm

Code	No.	tlg./pcs.			EAN	€
00075500083	75-50-M	24	5355	1	005882	299,75

wie/as 75-0010-M, jedoch/but

Stck./pcs.	Artikel/article	No.	Maße/dimensions
1		50-00-1 CP	270 mm

Code	No.	tlg./pcs.			EAN	€
00075301083	75-3010-M	24	5520	1	100679	332,80

wie/as 75-0010-M, jedoch/but

Stck./pcs.	Artikel/article	No.	Maße/dimensions
18		50-6 CPP	MM 12 13 14 15 16 17 18 19 20 21 22 23 24 26 27 28 30 32

Code	No.	tlg./pcs.			EAN	€
00075300083	75-30-M	24	5430	1	005851	318,45

wie/as 75-0010-M, jedoch/but

Stck./pcs.	Artikel/article	No.	Maße/dimensions
18		50-6 CPP	MM 12 13 14 15 16 17 18 19 20 21 22 23 24 26 27 28 30 32
1		50-00-7 CP	270 mm

Code	No.	tlg./pcs.			EAN	€
00075800083	75-80-M	24	5425	1	005943	299,75

wie/as 75-0010-M, jedoch/but

Stck./pcs.	Artikel/article	No.	Maße/dimensions
18		50-6 CPP	MM 12 13 14 15 16 17 18 19 20 21 22 23 24 26 27 28 30 32
1		50-00-1 CP	270 mm



1/2"

75-0 - 75-3310

Steckschlüssel-Garnituren

Chrom-Vanadium
CPP = verchromt,
ganz poliert
Metallkasten 450 x 187 x 52 mm

Socket sets

Chrome-Vanadium
CPP = chromium plated,
fully polished
Metal case 450 x 187 x 52 mm

1/2"



75-0010

Compositions de douilles

Chrome-Vanadium
CPP = chromées,
entièrement polies
Coffret métallique 450 x 187 x 52 mm

Juegos de llaves de vaso

Cromo Vanadio
CPP = cromado,
enteramente pulido espejo
Caja metálica 450 x 187 x 52 mm

Code	No.	tlg./pcs.			EAN	€
00075101083	75-1010-AF	24	5460	1	100655	341,60

wie/as 75-0010-M, jedoch/but

Stck./pcs.	Artikel/article	No.	Maße/dimensions
18		50-12 CPP	AF 3/8 7/16 1/2 9/16 19/32 5/8 11/16 3/4 25/32 13/16 7/8 15/16 31/32 1 1.1/16 1.1/8 1.3/16 1.1/4

Code	No.	tlg./pcs.			EAN	€
00075100083	75-10-AF	24	5375	1	005745	326,15

wie/as 75-0010-M, jedoch/but

Stck./pcs.	Artikel/article	No.	Maße/dimensions
18		50-12 CPP	AF 3/8 7/16 1/2 9/16 19/32 5/8 11/16 3/4 25/32 13/16 7/8 15/16 31/32 1 1.1/16 1.1/8 1.3/16 1.1/4
1		50-00-7 CP	270 mm

Code	No.	tlg./pcs.			EAN	€
00075600083	75-60-AF	24	5370	1	005929	307,45

wie/as 75-0010-M, jedoch/but

Stck./pcs.	Artikel/article	No.	Maße/dimensions
18		50-12 CPP	AF 3/8 7/16 1/2 9/16 19/32 5/8 11/16 3/4 25/32 13/16 7/8 15/16 31/32 1 1.1/16 1.1/8 1.3/16 1.1/4
1		50-00-1 CP	270 mm

75-0 - 75-3310

Steckschlüssel-Garnituren

Chrom-Vanadium
CPP = verchromt,
ganz poliert
Metallkasten 450 x 187 x 52 mm

Socket sets

Chrome-Vanadium
CPP = chromium plated,
fully polished
Metal case 450 x 187 x 52 mm

1/2"



75-0110

Compositions de douilles

Chrome-Vanadium
CPP = chromées,
entièrement polies
Coffret métallique 450 x 187 x 52 mm

Juegos de llaves de vaso

Cromo Vanadio
CPP = cromado,
enteramente pulido espejo
Caja metálica 450 x 187 x 52 mm

Code	No.	tlg./pcs.			EAN	€
00075011083	75-0110-M	26	5550	1	100624	344,90

enthaltend/containing

Stck./pcs.	Artikel/article	No.	Maße/dimensions
20		50-12 CPP	MM 10 11 12 13 14 15 16 17 18 19 20 21 22 23 24 26 27 28 30 32
1		50-02 CPP	405 mm
1		50-00-10 CPP	275 mm
1		50-03 CPP	300 mm
1		50-04 CPP	125 mm
1		50-05 CPP	250 mm
1		50-06 CPP	80 mm

Code	No.	tlg./pcs.			EAN	€
00075311083	75-3110-M	26	5650	1	100686	344,90

wie/as 75-0110-M, jedoch/but

Stck./pcs.	Artikel/article	No.	Maße/dimensions
20		50-6 CPP	MM 10 11 12 13 14 15 16 17 18 19 20 21 22 23 24 26 27 28 30 32

75-0 - 75-3310**Steckschlüssel-Garnituren**

Chrom-Vanadium
 CPP = verchromt,
 ganz poliert
 Metallkasten 450 x 187 x 52 mm

Socket sets

Chrome-Vanadium
 CPP = chromium plated,
 fully polished
 Metal case 450 x 187 x 52 mm

1/2

**75-0310****Compositions de douilles**

Chrom-Vanadium
 CPP = chromées,
 entièrement polies
 Coffret métallique 450 x 187 x 52 mm

Juegos de llaves de vaso

Cromo Vanadio
 CPP = cromado,
 enteramente pulido espejo
 Caja metálica 450 x 187 x 52 mm

Code	No.	tlg./pcs.			EAN	€
00075031083	75-0310-M	23	5500	1	100631	303,05

enthaltend/containing

Stck./pcs.	Artikel/article	No.	Maße/dimensions
17		50-12 CPP	MM 10 11 12 13 14 15 16 17 18 19 21 22 24 27 30 32 34
1		50-00-10 CPP	275 mm
1		50-03 CPP	300 mm
1		50-04 CPP	125 mm
1		50-04-1 CPP	75 mm
1		50-05 CPP	250 mm
1		50-06 CPP	80 mm

Code	No.	tlg./pcs.			EAN	€
00075331083	75-3310-M	23	5540	1	095357	303,05

wie/as 75-0310-M, jedoch/but

Stck./pcs.	Artikel/article	No.	Maße/dimensions
17		50-6 CPP	MM 10 11 12 13 14 15 16 17 18 19 21 22 24 27 30 32 34

76-0010**Steckschlüssel-Garnitur**

Chrom-Vanadium
 CPP = verchromt, ganz poliert
 In hochwertiger 2-K Schaumstoff-
 einlage
 Metallkasten 407 x 162 x 53 mm

Socket set

Chrome-Vanadium
 CPP = chromium plated,
 fully polished
 high quality 2-K-foam insert
 Metal case 407 x 162 x 53 mm

1/2

**Compositions de douilles**

Chrom-Vanadium
 CPP = chromées, entièrement polies
 insert en mousse de haute qualité en
 2 composants
 Coffret métallique 407 x 162 x 53 mm

Juegos de llaves de vaso

Cromo Vanadio
 CPP = cromado,
 enteramente pulido espejo
 en bandeja de polispam de gran calidad
 Caja metálica 407 x 162 x 53 mm

Code	No.	tlg./pcs.			EAN	€
00076001083	76-0010-M	20	4198	1	366495	253,15

enthaltend/containing

Stck./pcs.	Artikel/article	No.	Maße/dimensions
16		50-12	MM 10 11 12 13 14 15 16 17 18 19 21 22 24 27 30 32
1		50-00-10	275 mm
1		50-04	125 mm
1		50-05	250 mm
1		50-06	70 mm

1/2"

77-0 - 77-30

Kombinierte Steck-
schlüssel- und Schraub-
dreher-Einsatz-Garnituren

Chrom-Vanadium
CPP = verchromt,
ganz poliert
Metallkasten 450 x 187 x 52 mm

Combined socket and
screwdriver socket sets

Chrome-Vanadium
CPP = chromium plated,
fully polished
Metal case 450 x 187 x 52 mm

Compositions de douilles
et de douilles-tournevis

Chrome-Vanadium
CPP = chromées,
entièrement polies
Coffret métallique 450 x 187 x 52 mm

Juegos combinados de llaves
de vaso y llaves de vaso con
destornillador

Cromo Vanadio
CPP = cromado,
enteramente pulido espejo
Caja metálica 450 x 187 x 52 mm

1/2"



77-0

Code	No.	tlg./pcs.			EAN	€
00077000083	77-0-M	36	5860	1	006025	419,80

enthaltend/containing			
Stck./pcs.	Artikel/article	No.	Maße/dimensions
18		50-12 CPP	MM 12 13 14 15 16 17 18 19 20 21 22 23 24 26 27 28 30 32
1		50-00-7 CP	270 mm
3		50-30 CPP	8 x 1,2 12 x 2,0 14 x 2,5 mm
7		50-31 CPP	MM 5 6 8 10 12 14 17
3		50-32 CPP	PH No. 2 3 4
1		50-03 CPP	300 mm
1		50-04 CPP	125 mm
1		50-05 CPP	250 mm
1		50-06 CPP	80 mm

Code	No.	tlg./pcs.			EAN	€
00077300083	77-30-M	36	5940	1	006056	419,80

wie/as 77-0-M, jedoch/but			
Stck./pcs.	Artikel/article	No.	Maße/dimensions
18		50-6 CPP	MM 12 13 14 15 16 17 18 19 20 21 22 23 24 26 27 28 30 32

78-0 - 78-3010

Steckschlüssel-Garnituren

Chrom-Vanadium
CPP = verchromt,
ganz poliert
Metallkasten 450 x 187 x 52 mm

Socket sets

Chrome-Vanadium
CPP = chromium plated,
fully polished
Metal case 450 x 187 x 52 mm

Compositions de douilles

Chrome-Vanadium
CPP = chromées,
entièrement polies
Coffret métallique 450 x 187 x 52 mm

Juegos de llaves de vaso

Cromo Vanadio
CPP = cromado,
enteramente pulido espejo
Caja metálica 450 x 187 x 52 mm

1/2"



78-0010

Code	No.	tlg./pcs.			EAN	€
00078001083	78-0010-M	18	4820	1	100693	266,75

enthaltend/containing			
Stck./pcs.	Artikel/article	No.	Maße/dimensions
13		50-12 CPP	MM 10 11 12 13 14 15 17 19 22 24 27 30 32
1		50-00-10 CPP	275 mm
1		50-03 CPP	300 mm
1		50-04 CPP	125 mm
1		50-05 CPP	250 mm
1		50-06 CPP	80 mm

Code	No.	tlg./pcs.			EAN	€
00078000083	78-0-M	18	4160	1	006087	252,35

wie/as 78-0010-M, jedoch/but			
Stck./pcs.	Artikel/article	No.	Maße/dimensions
1		50-00-7 CP	270 mm

Code	No.	tlg.			EAN	€
00078301083	78-3010-M	18	4920	1	100709	266,75

wie/as 78-0010-M, jedoch/but			
Stck./pcs.	Artikel/article	No.	Maße/dimensions
13		50-6 CPP	MM 10 11 12 13 14 15 17 19 22 24 27 30 32

78-0 - 78-3010

Steckschlüssel-Garnituren

Chrom-Vanadium
 CPP = verchromt,
 ganz poliert
 Metallkasten 450 x 187 x 52 mm

Socket sets

Chrome-Vanadium
 CPP = chromium plated,
 fully polished
 Metal case 450 x 187 x 52 mm

Compositions de douilles

Chrom-Vanadium
 CPP = chromées,
 entièrement polies
 Coffret métallique 450 x 187 x 52 mm

Juegos de llaves de vaso

Cromo Vanadio
 CPP = cromado,
 enteramente pulido espejo
 Caja metálica 450 x 187 x 52 mm

Code	No.	tlg./pcs.			EAN	€
00078300083	78-30-M	18	4200	1	006117	252,35

wie/as 78-0010-M, jedoch/but											
Stck./pcs.	Artikel/article	No.	Maße/dimensions								
13		50-6 CPP	MM 10	11	12	13	14	15	17	19	
			22	24	27	30	32				
1		50-00-7 CP	270 mm								

79-0010 - 79-3310

Steckschlüssel-Garnituren

Chrom-Vanadium
 CPP = verchromt,
 ganz poliert
 Metallkasten 450 x 187 x 52 mm

Socket sets

Chrome-Vanadium
 CPP = chromium plated,
 fully polished
 Metal case 450 x 187 x 52 mm

Compositions de douilles

Chrom-Vanadium
 CPP = chromées,
 entièrement polies
 Coffret métallique 450 x 187 x 52 mm

Juegos de llaves de vaso

Cromo Vanadio
 CPP = cromado,
 enteramente pulido espejo
 Caja metálica 450 x 187 x 52 mm



Code	No.	tlg./pcs.			EAN	€
00079001083	79-0010-M	32	6190	1	100730	371,40

enthaltend/containing											
Stck./pcs.	Artikel/article	No.	Maße/dimensions								
18		50-12 CPP	MM 8	10	11	12	13	14	15	16	17
			18	19	21	22	24	27	30	32	34
1		50-00-10-CPP	275 mm								
8		50-31 CPP	MM 4	5	6	7	8	10	12	14	
1		50-03 CPP	300 mm								
1		50-04 CPP	125 mm								
1		50-04-1 CPP	75 mm								
1		50-05 CPP	250 mm								
1		50-06 CPP	80 mm								

Code	No.	tlg./pcs.			EAN	€
00079301083	79-3010-M	32	6320	1	095364	371,40

wie/as 79-0010-M, jedoch/but														
Stck./pcs.	Artikel/article	No.	Maße/dimensions											
18		50-6 CPP	MM 8	10	11	12	13	14	15	16	17	18	19	21
			22	24	27	30	32	34						

Code	No.	tlg./pcs.			EAN	€
00079031083	79-0310-M	32	6110	1	097351	407,75

wie/as 79-0010-M, jedoch/but										
Stck./pcs.	Artikel/article	No.	Maße/dimensions							
8		50-36 CPP	T 25	T 27	T 30	T 40	T 45	T 50	T 55	T 60

Code	No.	tlg./pcs.			EAN	€
00079331083	79-3310-M	32	6240	1	095333	407,75

wie/as 79-0010-M, jedoch/but											
Stck./pcs.	Artikel/article	No.	Maße/dimensions								
18		50-6 CPP	MM 8	10	11	12	13	14	15	16	17
			18	19	21	22	24	27	30	32	34
8		50-36 CPP	T 25	T 27	T 30	T 40	T 45	T 50	T 55	T 60	



79-0010



84-0010

Kombinierte Steckschlüssel-Garnitur

Chrom-Vanadium
 CPP = verchromt, ganz poliert
 In hochwertiger 2-K Schaumstoff-
 einlage
 Metallkasten 407 x 162 x 53 mm

Combined set of sockets

Chrome-Vanadium
 CPP = chromium plated,
 fully polished
 high quality 2-K-foam insert
 Metal case 407 x 162 x 53 mm

Compositions de douilles

Chrome-Vanadium
 CPP = chromées, entièrement polies
 insert en mousse de haute qualité en
 2 composants
 Coffret métallique 407 x 162 x 53 mm

Juegos combinados de llaves de vaso

Cromo Vanadio
 CPP = cromado,
 enteramente pulido espejo
 en bandeja de polispam de gran calidad
 Caja metálica 407 x 162 x 53 mm



Code	No.	tlg./pcs.			EAN	€
00084001083	84-0010-M	23	3401	1	366471	272,25

enthaltend/containing				
Stck./pcs.	Artikel/article	No.	Maße/dimensions	
6		25-6	MM 5,5 6 7 8 10 11	
		25-00-10	140 mm	
		25-05	150 mm	
10		25-06	35 mm	
		50-12	MM 12 13 14 15 16 17 18 19 21 22	
		50-00-10	275 mm	
		50-04	125 mm	
		50-06	70 mm	

84-3010

Kombinierte Steckschlüssel-Garnitur

Chrom-Vanadium
 CPP = verchromt, ganz poliert
 In hochwertiger 2-K Schaumstoff-
 einlage
 Metallkasten 407 x 162 x 53 mm

Combined set of sockets

Chrome-Vanadium
 CPP = chromium plated,
 fully polished
 high quality 2-K-foam insert
 Metal case 407 x 162 x 53 mm

Compositions de douilles

Chrome-Vanadium
 CPP = chromées, entièrement polies
 insert en mousse de haute qualité en
 2 composants
 Coffret métallique 407 x 162 x 53 mm

Juegos combinados de llaves de vaso

Cromo Vanadio
 CPP = cromado,
 enteramente pulido espejo
 en bandeja de polispam de gran calidad
 Caja metálica 407 x 162 x 53 mm



Code	No.	tlg./pcs.			EAN	€
00084301083	84-3010-M	23	3466	1	366464	272,25

enthaltend/containing				
Stck./pcs.	Artikel/article	No.	Maße/dimensions	
6		25-6	MM 5,5 6 7 8 10 11	
		25-00-10	140 mm	
		25-05	150 mm	
10		25-06	35 mm	
		50-6	MM 12 13 14 15 16 17 18 19 21 22	
		50-00-10	275 mm	
		50-04	125 mm	
		50-06	70 mm	

94-2550

Kombinierter Werkzeug-Satz

Chrom-Vanadium
ST = standardmäßig
Metallkasten 450 x 187 x 52 mm

Combined set of tools

Chrome-Vanadium
ST = standard
Metal case 450 x 187 x 52 mm

Composition d'outils combinés

Chrome-Vanadium
ST = standard
Coffret métallique 450 x 187 x 52 mm

Conjuntos de herramientas combinados

Cromo Vanadio
ST = estándar
Caja metálica 450 x 187 x 52 mm



für TORX®-Schrauben/for TORX®-screws

Code	No.	tlg./ pcs.	g		EAN	€
00094255000	94-2550-E/T	49	3655	1	125368	372,40

enthaltend/containing						
Stck./pcs.	Artikel/article	No.	Maße/dimensions			
6		25-20	E 4	E 5	E 6	E 7 E 8 E 10
10		25-36	T 6	T 7	T 8 T 9	T 10 T 15 T 20 T 25 T 27 T 30
7		50-20	E 11	E 12	E 14	E 16 E 18 E 20 E 24
5		50-36	T 40	T 45	T 50	T 55 T 60
11		1348	T 10	T 15	T 20	T 25 T 27 T 30 T 40 T 45 T 50 T 55 T 60
10		1415	T 6	T 7	T 8 T 9	T 10 T 15 T 20 T 25 T 27 T 30

1186

Verkaufsdisplay Hebelumschaliknarren

Chrom-Vanadium
CPP = verchromt, ganz poliert

Sales display for reversible ratchets

Chrome-Vanadium
CPP = chromium plated, fully polished

Display cliquets réversibles

Chrom-Vanadium
CPP = chromées, entièrement polies

Display de autoventa para carracas reversibles

Cromo Vanadio
CPP = cromado, enteramente pulido espejo



Code	tlg. pcs.	Maße dimensions	g		EAN	€
01186001083	26	355 x 280 x 420 mm	10225	1	311464	1.460,85

enthaltend/containing						
Stck./pcs.	Artikel/article	No.				
10	1/4"	25-00-10				
9	3/8"	40-00-10				
7	1/2"	50-00-10				

1187

Verkaufsdisplay Hebelumschaliknarren

Chrom-Vanadium
CPP = verchromt, ganz poliert

Sales display for reversible ratchets

Chrome-Vanadium
CPP = chromium plated, fully polished

Display cliquets réversibles

Chrom-Vanadium
CPP = chromées, entièrement polies

Display de autoventa para carracas reversibles

Cromo Vanadio
CPP = cromado, enteramente pulido espejo



Code	tlg. pcs.	Maße dimensions	g		EAN	€
01187541083	12	205 x 205 x 350 mm	4362	1	325546	683,05

enthaltend/containing						
Stck./pcs.	Artikel/article	No.				
12	1/2"	50-40-10				



100-00-5 - 100-16

3/4" Antriebs- und Verbindungsteile

DIN 3122 + 3123

3/4" Accessories

DIN 3122 + 3123

3/4" Accessoires

DIN 3122 + 3123

3/4" Accesorios

DIN 3122 + 3123

Code	No.	Ausf. finish					←L→ mm	g		EAN	€
0010000680	100-00-6	C	Umschaltknarre	Reversible ratchet	Cliquet réversible	Carraca reversible	490	1535	2	006582	109,40
00100011080	100-01-1	C	Durchsteckknarre	Ratchet, push-thru type	Cliquet	Carraca de cuadradillo pasante	490	1460	2	006735	96,15
00100030180	100-03-1	C	Griff mit Gleitstück	Sliding T-handle	Poignée coulissante	Mango corredizo	485	1445	2	006759	39,15
00100040080	100-04	C	Verlängerung	Extension bar	Rallonge	Alargadera	200	550	2	006971	27,05
00100050080	100-05	C	Verlängerung	Extension bar	Rallonge	Alargadera	400	1050	2	006988	36,90
00100060080	100-06	C	Kardangelen	Universal joint	Cardan universel	Articulación universal	110	535	2	006995	77,80
00100070080	100-07	C	Gelenkgriff	Swivel handle	Poignée articulée	Mango articulado	500	1770	2	007008	87,60
00100140080	100-14	C	Verbindungsstück	Converter	Réducteur	Reductor	60	160	10	007015	19,95
00100150080	100-15	C	Verbindungsstück	Converter	Augmentateur	Ampliador	60	325	10	007022	31,80
00100160080	100-16	C	Verbindungsstück	Square coupler	Carré conducteur	Adaptador	45	130	10	007039	10,70



100-00-6 · 50 Zähne/teeth · DIN 3122 D · ISO 3315



100-06 · DIN 3123 C · ISO 3316



100-01-1 · 36 Zähne/teeth · DIN 3122 C · ISO 3315



100-07 · DIN 3122 F · ISO 3315



100-03-1 · DIN 3122 A · ISO 3315



100-14 · DIN 3123 A · ISO 3316



100-04 · DIN 3123 B · ISO 3316



100-15 · DIN 3123 A · ISO 3316



100-05 · DIN 3123 B · ISO 3316



100-16 · DIN 3122 CV · ISO 3315

Chrom-Vanadium
C = verchromt
mit Stiftsicherung

Chrome-Vanadium
C = chromium plated
with locking pin

100-6

Steckschlüssel-Einsätze

DIN 3124 / ISO 2725
 Chrom-Vanadium
 C = verchromt
 mit Stiftsicherung

Sockets

DIN 3124 / ISO 2725
 Chrome-Vanadium
 C = chromium plated
 with locking pin

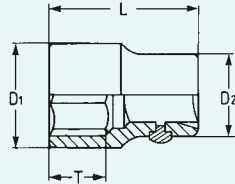

Douilles

DIN 3124 / ISO 2725
 Chrome-Vanadium
 C = chromées
 avec poussoir de verrouillage de sécurité

Llaves de vaso

DIN 3124 / ISO 2725
 Cromo Vanadio
 C = cromado
 con pasador de seguridad

Code	⊘MM	←L→ mm	T mm	D ₁ mm	D ₂ mm	g	SP	EAN	€
00100602280	22	52	18,0	32,2	36,0	220	5	007053	13,60
00100602480	24	52	18,0	34,2	36,0	220	5	007060	13,65
00100602780	27	54	18,0	38,0	36,0	225	5	007077	14,80
00100603080	30	56	20,0	42,0	38,0	280	5	007084	15,90
00100603280	32	56	22,0	44,0	38,0	320	5	007091	15,90
00100603680	36	65	24,0	50,0	42,0	440	5	007107	20,20
00100603880	38	65	25,0	52,0	45,0	480	5	007114	20,45
00100604180	41	65	27,0	56,0	45,0	570	5	007121	29,15
00100604680	46	65	30,0	62,0	49,2	690	5	007138	32,40
00100605080	50	65	32,0	68,0	48,0	820	5	007145	39,85
00100605580	55	70	32,0	74,5	48,0	960	5	007152	45,25

100-12

Steckschlüssel-Einsätze

DIN 3124 / ISO 2725
 Chrom-Vanadium
 C = verchromt
 mit Stiftsicherung

Sockets

DIN 3124 / ISO 2725
 Chrome-Vanadium
 C = chromium plated
 with locking pin

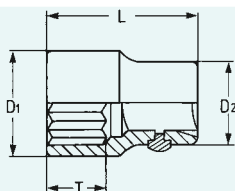

Douilles

DIN 3124 / ISO 2725
 Chrome-Vanadium
 C = chromées
 avec poussoir de verrouillage de sécurité

Llaves de vaso

DIN 3124 / ISO 2725
 Cromo Vanadio
 C = cromado
 con pasador de seguridad

Code	⊘MM	←L→ mm	T mm	D ₁ mm	D ₂ mm	g	SP	EAN	€
00100002280	22	52	18,0	32,3	36,0	210	5	006599	13,60
00100002480	24	52	18,0	34,2	36,0	210	5	006605	13,65
00100002780	27	54	18,0	38,0	36,0	220	5	006612	14,80
00100002980	29	56	20,0	40,0	38,0	250	5	006629	15,90
00100003080	30	56	20,0	42,0	38,0	275	5	006636	15,90
00100003280	32	56	22,0	44,0	38,0	300	5	006643	15,90
00100003380	33	56	22,0	46,0	38,0	315	5	006650	18,50
00100003680	36	65	24,0	50,0	42,0	415	5	006667	20,20
00100003880	38	65	25,0	52,0	45,0	470	5	006674	20,45
00100004180	41	65	27,0	56,0	45,0	550	5	006681	29,15
00100004680	46	65	30,0	62,0	49,5	610	5	006698	32,40
00100005080	50	65	32,0	68,0	48,0	790	5	006704	39,85
00100005580	55	70	32,0	74,5	48,0	860	5	006711	45,25
00100006080	60	70	32,0	80,5	48,0	1020	5	006728	52,50

Code	⊘AF	←L→ mm	T mm	D ₁ mm	D ₂ mm	g	SP	EAN	€
00100033480	7/8	52	18,0	32,2	36,0	200	5	006803	14,15
00100033580	15/16	52	18,0	34,2	36,0	220	5	006810	14,40
00100033780	1	54	18,0	37,0	36,0	210	5	006827	15,05
00100033880	1.1/16	54	18,0	38,5	36,0	220	5	006834	15,55
00100033980	1.1/8	54	18,0	40,0	38,0	250	5	006841	17,50
00100034080	1.3/16	56	20,0	42,0	38,0	275	5	006858	17,50
00100034180	1.1/4	56	22,0	44,0	38,0	300	5	006865	17,50
00100034280	1.5/16	56	22,0	46,0	38,0	325	5	006872	17,50
00100034380	1.3/8	65	24,0	48,0	42,0	400	5	006889	22,15
00100034480	1.7/16	65	24,0	50,0	42,0	425	5	006896	22,15
00100034580	1.1/2	65	25,0	52,0	45,0	470	5	006902	23,90
00100034780	1.5/8	65	27,0	56,0	45,0	540	5	006919	26,25
00100034880	1.11/16	65	30,0	58,0	45,0	570	5	006926	32,05
00100034980	1.3/4	65	30,0	60,0	48,0	620	5	006933	34,95
00100035080	1.13/16	65	30,0	62,0	49,5	655	5	006940	34,95
00100035180	1.7/8	65	30,0	64,0	48,0	700	5	006957	34,95
00100035280	2	65	32,0	68,0	48,0	745	5	006964	38,15

3/4"

101-0 - 101-80**Steckschlüssel-Garnituren**

Chrom-Vanadium
C = verchromt
Metallkasten 515 x 220 x 84 mm

Socket sets

Chrome-Vanadium
C = chromium plated
Metal case 515 x 220 x 84 mm

3/4"



101-0

Compositions de douilles

Chrome-Vanadium
C = chromées
Coffret métallique 515 x 220 x 84 mm

Juegos de llaves de vaso

Cromo Vanadio
C = cromado
Caja metálica 515 x 220 x 84 mm

Code	No.	tlg./pcs.			EAN	€
00101000080	101-0-M	14	11700	1	007237	496,95

enthaltend/containing

Stck./pcs.	Artikel/article	No.	Maße/dimensions
10		100-12 C	MM 22 24 27 30 32 36 38 41 46 50
1		100-00-6 C	490 mm
1		100-03-1 C	485 mm
1		100-04 C	200 mm
1		100-05 C	400 mm

Code	No.	tlg./pcs.			EAN	€
00101500080	101-50-M	14	11625	1	007299	485,95

wie/as 101-0-M, jedoch/but

Stck./pcs.	Artikel/article	No.	Maße/dimensions
1		100-01-1 C	490 mm

Code	No.	tlg./pcs.			EAN	€
00101300080	101-30-M	14	11925	1	007282	496,95

wie/as 101-0-M, jedoch/but

Stck./pcs.	Artikel/article	No.	Maße/dimensions
10		100-6 C	MM 22 24 27 30 32 36 38 41 46 50

Code	No.	tlg./pcs.			EAN	€
00101800080	101-80-M	14	11850	1	007329	485,95

wie/as 101-0-M, jedoch/but

Stck./pcs.	Artikel/article	No.	Maße/dimensions
10		100-6 C	MM 22 24 27 30 32 36 38 41 46 50
1		100-01-1 C	490 mm

Code	No.	tlg./pcs.			EAN	€
00101100080	101-10-AF	14	11405	1	007275	498,10

wie/as 101-0-M, jedoch/but

Stck./pcs.	Artikel/article	No.	Maße/dimensions
10		100-12	AF 7/8 15/16 1 1.1/16 1.1/8 1.1/4 1.1/2 1.5/8 1.3/4 2

Code	No.	tlg./pcs.			EAN	€
00101600080	101-60-AF	14	11330	1	007312	488,15

wie/as 101-0-M, jedoch/but

Stck./pcs.	Artikel/article	No.	Maße/dimensions
10		100-12	AF 7/8 15/16 1 1.1/16 1.1/8 1.1/4 1.1/2 1.5/8 1.3/4 2
1		100-01-1 C	490 mm

105-00-6 - 105-14

1" Antriebs- und
Verbindungssteile

1" Accessories

1" Accessoires

1" Accesorios

DIN 3122 + 3123

DIN 3122 + 3123

DIN 3122 + 3123

DIN 3122 + 3123

Code	No.	Ausf. finish					←L→ mm	g		EAN	€
00105000680	105-00-6	C	Umschaltknarre	Reversible ratchet	Cliquet réversible	Carraca reversible	640	3835	1	007350	244,00
00105030080	105-03	C	Griff mit Gleitstück	Sliding T-handle	Poignée articulée	Mango corredizo	640	3010	1	007466	86,90
00105040080	105-04	C	Verlängerung	Extension bar	Rallonge	Alargadera	205	1065	2	007602	58,85
00105050080	105-05	C	Verlängerung	Extension bar	Rallonge	Alargadera	405	1825	2	007619	80,50
00105140080	105-14	C	Verbindungsstück	Converter	Réducteur	Reductor	80	475	2	007626	38,10



105-00-6 · 72 Zähne/teeth · DIN 3122 D · ISO 3315



105-03 · DIN 3123 B · ISO 3316



105-04 · DIN 3123 B · ISO 3316



105-05 · DIN 3122 A · ISO 3315



105-14 · DIN 3123 A · ISO 3316 ·

1" Chrom-Vanadium
C = verchromt, mit Stiftsicherung

1" Chrome-Vanadium
C = chromium plated, with locking pin

105-12

Steckschlüssel-Einsätze

Sockets

Douilles

Llaves de vaso

DIN 3124 / ISO 2725

Chrom-Vanadium

C = verchromt
mit Stiftsicherung

DIN 3124 / ISO 2725

Chrome-Vanadium

C = chromium plated
with locking pin

DIN 3124 / ISO 2725

Chrome-Vanadium

C = chromées

avec poussoir de verrouillage de sécurité

DIN 3124 / ISO 2725

Cromo Vanadio

C = cromado

con pasador de seguridad

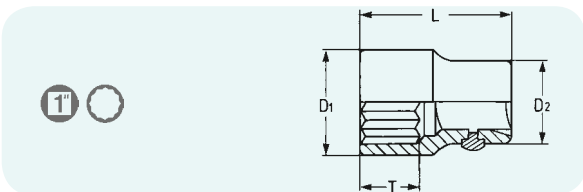

Code	MM	←L→ mm	T mm	D ₁ mm	D ₂ mm	g		EAN	€
00105003680	36	64	32,5	54,0	51,0	580	1	007367	43,05
00105004180	41	70	32,0	57,0	45,0	695	1	007374	47,05
00105004680	46	75	34,0	65,0	50,0	890	1	007381	57,55
00105005080	50	77	38,0	71,0	54,0	1050	1	007398	59,35
00105005580	55	82	41,0	77,5	57,0	1325	1	007404	70,70
00105006080	60	86	43,5	83,5	57,0	1505	1	007411	78,85
00105006580	65	87	44,0	88,0	55,0	1715	1	007428	96,85
00105007080	70	95	49,0	96,0	60,0	2030	1	007435	104,60
00105007580	75	100	52,5	102,5	60,0	2280	1	007442	114,60
00105008080	80	103	54,0	105,0	60,0	2670	1	007459	125,65

Code	AF	←L→ mm	T mm	D ₁ mm	D ₂ mm	g		EAN	€
00105034480	1.7/16	64	31,5	54,0	51,0	590	1	007473	45,45
00105034580	1.1/2	68	35,5	56,0	51,0	640	1	007480	47,80
00105034780	1.5/8	69	34,5	60,0	51,0	710	1	007497	57,45
00105035080	1.13/16	73	35,0	66,0	54,0	890	1	007503	64,45
00105035280	2	77	38,0	71,0	54,0	1020	1	007527	70,00
00105035580	2.3/16	82	41,0	77,5	57,0	1305	1	007534	77,95
00105035680	2.1/4	84	42,5	80,0	57,0	1360	1	007541	77,95
00105035880	2.3/8	86	43,5	83,5	57,0	1500	1	007558	85,90
00105036280	2.5/8	92	47,0	92,0	57,0	1895	1	007565	109,70
00105036380	2.3/4	95	49,0	96,0	60,0	2035	1	007572	118,05
00105036780	3.1/8	105	55,5	108,5	60,0	2695	1	007596	144,15

106-0

Steckschlüssel-Garnitur

Socket set

Compositions de douilles

Juegos de llaves de vaso

Chrom-Vanadium

C = verchromt

Metallkasten 775 x 260 x 125 mm

Chrome-Vanadium

C = chromium plated

Metal case 775 x 260 x 125 mm

Chrome-Vanadium

C = chromées

Coffret métallique 775 x 260 x 125 mm

Cromo Vanadio

C = cromado

Caja metálica 775 x 260 x 125 mm



Code	No.	tlg./pcs.	g		EAN	€
00106000080	106-0-M	14	31340	1	007633	1.389,25

enthaltend/containing

Stck./pcs.	Artikel/article	No.	Maße/dimensions
10		105-12 C	MM 36 41 46 50 55 60 65 70 75 80
1		105-00-6 C	640 mm
1		105-03 C	640 mm
1		105-04 C	205 mm
1		105-05 C	405 mm

3301-1

Magnet-Bithalter

zur Aufnahme von Bits mit Außensechskant 1/4", Klinge verchromt, mit 2-K Kunststoffheft

Magnetic bitholder

for bits 1/4"-drive, chromium plated, with 2-K plastic handle

Adaptateur magnétique

pour embots 1/4", couteau chromatisé, avec manche à 2 composantes

Soporte imantado para puntas de destornillador

Para acoplamiento de puntas con hexágono exterior de 1/4", hoja cromada, mango de plástico de dos componentes



Code	No.	←L→ mm	g	10	EAN	€
03301010080	3301-1	200	102	10	366204	15,40

3305

Schlagdreher

N = vernickelt mit Kugel-Arretierung, einstellbar für Rechts- und Linksgang

Impact drivers

N = nickel plated with spring-loaded retaining ball, adjustable for right- and left hand rotation

Tournevis à frapper

N = nickelées avec arrêt par bille de verrouillage, réglable pour pas à droite et gauche, 120 Nm

Destornilladores de golpe

N = niquelado reversibles para giro a derecha e izquierda, 120 Nm con retención por bola



Code	←L→ mm	Ø mm	g	1	EAN	€
03305000050	140	33,0	635	1	034806	32,00

3310

Schlagschraubendreher-Satz

ST = standardmäßig Metallkasten 225 x 115 x 40 mm

Impact driver set

ST = standard Metal case 225 x 115 x 40 mm

Compositions de tournevis à frapper

ST = standard Coffrets métalliques 225 x 115 x 40 mm

Juegos de destornilladores de golpe

ST = estándar Cajas metálicas 225 x 115 x 40 mm



Code	No.	tlg./pcs.	g	1	EAN	€
03310000000	3310	13	1325	1	034813	79,00

enthaltend/containing

Stck. pcs.	Artikel/article	No.	Maße/dimensions
1	1/2	3305	Schlagdreher/impact driver
1	5/16 1/2	6302-31	Verbindungsstück/adaptor
je 1 each	5/16	3501-2 3501-4 3501-5 3501-7	Bit-Schraubendrehereinsatz/screwdriver bit für Schlitzschrauben/for plain slot screws 6 x 1,0 mm 8 x 1,2 mm 9 x 1,6 mm 12 x 2,0 mm
je 1 each	5/16	3511-3 3511-4 3511-5 3511-6	Bit-Schraubendrehereinsatz/screwdriver bit für Innensechskantschrauben/for hexagon socket screws MM 5 MM 6 MM 8 MM 10
je 1 each	5/16	3521-2 3521-3 3521-4	Bit-Schraubendrehereinsatz/screwdriver bit für Kreuzschlitzschrauben/for cross slot screws PH No. 2 PH No. 3 PH No. 4
4			T 30 T 40 T 45 T 50



Universal-Steckschlüssel-Einsätze

für Maschinen-Schrauber und Handbetätigungen

Bisher wurden normalerweise zwei absolut unterschiedliche Steckschlüssel-Einsätze für den handbetriebenen und maschinenbetätigten Arbeitsbereich verwendet.

Die neu entwickelten, extra dünnen und leichten HEYCO-Universal-Steckschlüssel-Einsätze sind so konzipiert, daß sie für beide Arbeitsbereiche eingesetzt werden können.

- Extrem belastbar
- Speziell dünnwandig
- Phosphatiert
- Aus speziellem, hochwertigem Chrom-Molybdän-Stahl
- Für Einsatz an engen Stellen im Kfz-Handwerk, im Maschinenbau sowie im Montagebereich

Universal sockets

for power drive and hand

So far under normal circumstances two different types of sockets had to be used for manual operation and for application with power driven tools.

The newly developed light weight HEYCO-Universal-Sockets with extra thin walls are designed to be used in both fields of application.

- Extremely tough
- Extra thin walls
- Phosphated
- From special, high grade chrome-molybdenum-steel
- For application in tight areas, in automotive engineering, mechanical engineering and general assembly work

Douilles universelles

pour utilisation manuelle et sur machine

Jusqu'à présent, il n'y avait exclusivement que deux types de douilles différents utilisables soit à la main, soit sur machine.

Les douilles universelles HEYCO nouvellement conçues, aux parois extra-minces et légères en poids, ont été étudiées pour convenir parfaitement aux deux types d'utilisation.

- Extrêmement résistantes
- Parois extra-minces
- Phosphatées
- En acier spécial au Chrome-Molybdène, de haute qualité
- Pour utilisation aux endroits difficiles d'accès, dans les domaines de l'automobile, de la construction mécanique comme du montage

Llaves de vaso universales

para atornillar a máquina y a mano

Hasta la fecha, se utilizaban dos tipos de llaves de vaso claramente diferenciados para el atornillado manual o a máquina.

El nuevo modelo de llaves de vaso universales HEYCO, con paredes delgadas y poco peso, permite su utilización indistinta en ambas aplicaciones.

- Extremadamente resistentes
- Paredes especialmente delgadas
- Fosfatadas
- De acero especial al cromo molibdeno de alta calidad
- Para utilizar en sitios de difícil acceso en la reparación de automóviles, construcción de maquinaria y trabajos de montaje en general

3700 - 3806-10

Universal-Steckschlüssel-Einsätze und Verbindungsteile

für Maschinen-Schrauber und Handbetrieb

Universal-socket-programme

for power drive and hand

Gamme de douilles universelles et accessoires

pour visseuse et utilisation manuelle

Gama universal de llaves de vaso

para uso manual y en atornillador

3700

Steckschlüssel-Einsätze

42 Cr Mo 4
PH = phosphatiert
extra dünnwandig

Sockets

42 Cr Mo 4
PH = phosphatés
extra thin walls

Douilles

42 Cr Mo 4
PH = phosphatées
parois extra-minces

Llaves de vaso

42 Cr Mo 4
PH = fosfatado
paredes extra-delgadas

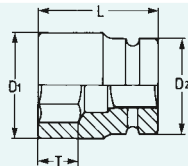

Code	ØMM	←L→ mm	T mm	D ₁ mm	D ₂ mm	g		EAN	€
03700000636	6	30	4	10,5	19	35	10	087253	3,90
03700000736	7	30	8	11,5	19	33	10	101676	3,90
03700000836	8	30	8	12,5	19	33	10	101683	3,90
03700000936	9	30	8	14,0	19	35	10	101690	3,90
03700001036	10	30	8	15,0	19	34	10	101706	3,90
03700001136	11	30	9	17,0	19	35	10	101713	3,90
03700001236	12	30	9	17,5	19	34	10	101720	3,90
03700001336	13	30	9	19,0	19	34	10	101737	4,30
03700001436	14	30	9	20,0	20	36	10	101744	4,30
03700001536	15	30	11	21,0	22	50	10	101751	4,30
03700001636	16	30	11	22,5	22	57	10	101768	5,25
03700001736	17	30	11	24,0	22	57	10	101775	5,25
03700001836	18	30	11	25,0	22	61	10	101782	5,25
03700001936	19	30	11	26,0	22	63	10	101799	5,25
03700002036	20	30	12	27,0	22	61	10	101805	5,50
03700002136	21	30	13	28,0	22	68	10	101812	5,70
03700002236	22	30	13	30,0	23	77	10	101829	5,70

3700-19

Steckschlüssel-Einsätze, extra lang

42 Cr Mo 4
PH = phosphatiert
extra dünnwandig

Sockets, extra deep

42 Cr Mo 4
PH = phosphatés
extra thin walls

Douilles, extra longues

42 Cr Mo 4
PH = phosphatées
parois extra-minces

Llaves de vaso, serie extra-larga

42 Cr Mo 4
PH = fosfatado
paredes extra-delgadas

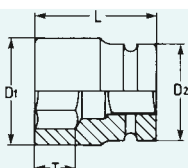

Code	ØMM	←L→ mm	T mm	D ₁ mm	D ₂ mm	g		EAN	€
03700190736	7	65	12	11,5	19	67	10	101836	5,35
03700190836	8	65	12	12,5	19	70	10	101843	5,35
03700190936	9	65	12	14,0	19	74	10	101850	5,35
03700191036	10	65	25	15,0	19	72	10	101867	5,35
03700191136	11	65	25	17,0	19	76	10	101874	5,35
03700191236	12	65	25	17,5	19	74	10	101881	5,35
03700191336	13	65	25	19,0	19	76	10	101898	5,70
03700191436	14	65	25	20,0	20	83	10	101904	5,80
03700191536	15	65	25	21,0	22	114	10	101911	5,80
03700191636	16	65	25	22,5	22	130	10	101928	6,45
03700191736	17	65	25	24,0	22	131	10	101935	6,45
03700191836	18	65	25	25,0	22	142	10	101942	6,45
03700191936	19	65	25	26,0	22	153	10	101959	7,20
03700192036	20	65	25	27,0	22	144	10	101966	7,20
03700192136	21	65	25	28,0	22	173	10	101973	8,00
03700192236	22	65	25	30,0	23	169	10	101980	8,00

3704-15 - 3705-50

Schwenkbare Verlängerungen

42 Cr Mo 4
PH = phosphatiert
10° schwenkbar

Wobble extensions

42 Cr Mo 4
PH = phosphated
10° angle flexibility

Rallonge articulée

42 Cr Mo 4
PH = phosphatées
orientable à 10°

Alargadera oscilante

42 Cr Mo 4
PH = fosfatado
10° oscilante

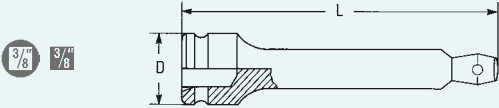

Code	No.	←L→ mm	T mm	D mm	g	mm	EAN	€
03704001536	3704-15	75	11,5	19	74	10	103618	9,10
03704002536	3704-25	150	11,5	19	140	10	103625	11,80
03705005036	3705-50	250	11,5	19	233	10	103632	18,10

3800

Steckschlüssel-Einsätze

42 Cr Mo 4
PH = phosphatiert
extra dünnwandig

Sockets

42 Cr Mo 4
PH = phosphated
extra thin walls

Douilles

42 Cr Mo 4
PH = phosphatées
parois extra-minces

Llaves de vaso

42 Cr Mo 4
PH = fosfatado
paredes extra-delgadas

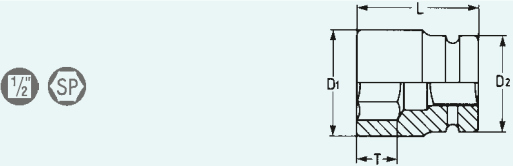

Code	MM	←L→ mm	T mm	D ₁ mm	D ₂ mm	g	mm	EAN	€
03800001036	10	38	12	15,5	22,0	50	10	095623	5,85
03800001136	11	38	12	16,7	22,0	50	10	095630	5,85
03800001236	12	38	12	18,0	22,0	50	10	095647	5,85
03800001336	13	38	12	19,2	24,0	63	10	095654	6,20
03800001436	14	38	12	21,0	24,0	67	10	095661	6,70
03800001536	15	38	12	21,7	24,0	66	10	095678	6,70
03800001636	16	38	12	23,0	24,0	66	10	095685	6,70
03800001736	17	38	13	24,0	24,0	64	10	095692	6,90
03800001836	18	38	13	25,0	25,0	73	10	095708	6,90
03800001936	19	38	13	26,0	26,0	76	10	095715	7,30
03800002036	20	38	13	27,5	27,5	93	10	095722	7,80
03800002136	21	38	13	28,0	28,0	94	10	095739	7,80
03800002236	22	38	13	29,5	29,5	105	10	095746	7,80
03800002336	23	38	13	30,5	30,5	112	10	095753	7,80
03800002436	24	45	20	32,0	32,5	135	10	095760	11,00
03800002536	25	45	20	33,0	33,5	145	10	095777	11,00
03800002636	26	50	22	35,0	35,5	184	10	095784	11,00
03800002736	27	50	22	36,0	36,5	189	10	095791	12,20
03800002836	28	50	22	37,5	37,5	214	10	095807	12,20
03800002936	29	50	22	38,5	38,0	230	10	095814	12,20
03800003036	30	50	22	40,0	38,0	240	10	095821	12,35
03800003236	32	50	22	42,0	38,0	245	10	095845	12,90

3800-19

Steckschlüssel-Einsätze, extra lang

42 Cr Mo 4
PH = phosphatiert
extra dünnwandig

Sockets, extra deep

42 Cr Mo 4
PH = phosphated
extra thin walls

Douilles, extra longues

42 Cr Mo 4
PH = phosphatées
parois extra-minces

Llaves de vaso, serie extra-larga

42 Cr Mo 4
PH = fosfatado
paredes extra-delgadas

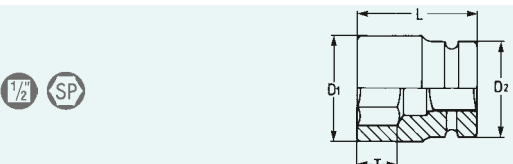

Code	MM	←L→ mm	T mm	D ₁ mm	D ₂ mm	g	mm	EAN	€
03800191036	10	78	14	15,5	22,0	108	10	101997	10,45
03800191136	11	78	14	16,7	22,0	110	10	102000	10,45
03800191236	12	78	14	18,0	22,0	118	10	102017	10,45
03800191336	13	78	14	19,2	24,0	135	10	102024	10,70
03800191436	14	78	17	21,0	24,0	144	10	102031	10,70
03800191536	15	78	17	21,7	24,0	147	10	102048	10,70
03800191636	16	78	17	23,0	24,0	144	10	102055	11,00
03800191736	17	78	17	24,0	24,0	148	10	102062	11,00
03800191836	18	78	17	25,0	25,0	153	10	102079	11,20
03800191936	19	78	19	26,0	26,0	166	10	102086	11,90
03800192036	20	78	19	27,5	27,5	172	10	102093	11,90
03800192136	21	78	24	28,0	28,0	180	10	102109	11,90
03800192236	22	78	24	29,5	29,5	205	10	102116	12,40
03800192336	23	78	24	30,5	30,5	228	10	102123	13,20
03800192436	24	78	24	32,0	32,0	147	10	102130	16,00

3804-25 - 3805-50

Schwenkbare Verlängerungen

42 Cr Mo 4
PH = phosphatiert
10° schwenkbar

Wobble extensions

42 Cr Mo 4
PH = phosphated
10° angle flexibility

Rallonge articulée

42 Cr Mo 4
PH = phosphatées
orientable à 10°

Alargadera oscilante

42 Cr Mo 4
PH = fosfatado
10° oscilante



1/2" 1/2"

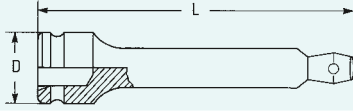

Code	No.	←L→ mm	T mm	D mm	g	g	EAN	€
03804002536	3804-25	50	16	25	91	10	103649	18,00
03804005036	3804-50	125	16	25	215	10	103656	22,50
03805005036	3805-50	250	16	25	419	10	103663	27,50

3706-10 - 3806-10

Kugelgelenke

42 Cr Mo 4
PH = phosphatiert

Swivel universal joints

42 Cr Mo 4
PH = phosphated

Rotules

42 Cr Mo 4
PH = phosphatées

Articulación con rótula

42 Cr Mo 4
PH = fosfatado



1/2" 1/2"

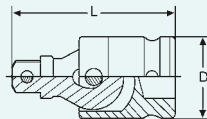

Code	←L→ mm	T mm	D mm	g	g	EAN	€
03706001036	50	16	25	100	10	126310	17,50
03806001036	60	16	32	199	10	107371	25,00

IMPACT

6300 - 6601-41

Steckschlüssel-Einsätze
und Verbindungsteile

für Maschinen-Schrauber

IMPACT-Socket-program

for impact- and power drive

Gamme IMPACT

pour Boulonneuses (air comprimé)

Gama de llaves de vaso de
IMPACTO

para uso en atornilladores

6300

IMPACT-Steckschlüssel-
Einsätze

DIN 3129 / ISO 2725
Chrom Molybdän
PH = phosphatiert

IMPACT-Sockets

DIN 3129 / ISO 2725
Chrome molybdenum
PH = phosphated

Douilles IMPACT

DIN 3129 / ISO 2725
Chrome molybdène
PH = phosphatées

Llaves de vaso de IMPACTO

DIN 3129 / ISO 2725
Cromo molibdeno
PH = fosfatado

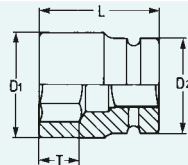

Code	MM	←L→ mm	T mm	D ₁ mm	D ₂ mm	g		EAN	€
0630000836	8	38	9	16,0	25,0	87	10	036602	4,80
06300001036	10	38	12	17,4	25,0	88	10	036619	4,80
06300001136	11	38	12	18,7	25,0	88	10	036626	4,80
06300001236	12	38	12	20,0	25,0	90	10	036633	4,80
06300001336	13	38	12	21,0	25,0	89	10	036640	4,80
06300001436	14	38	12	22,5	25,0	90	10	036657	4,80
06300001536	15	38	12	23,5	30,0	130	10	036664	4,80
06300001636	16	38	13	24,0	30,0	130	10	036671	5,00
06300001736	17	38	13	26,5	30,0	130	10	036688	5,00
06300001836	18	38	13	26,5	30,0	130	10	036695	5,00
06300001936	19	38	13	28,5	30,0	130	10	036701	5,00
06300002036	20	38	13	30,0	30,0	130	10	036718	5,40
06300002136	21	38	13	30,2	30,0	130	10	036725	5,40
06300002236	22	38	13	32,8	30,0	145	10	036732	5,40
06300002336	23	38	13	33,5	30,0	130	10	036749	5,70
06300002436	24	45	20	35,5	30,0	180	10	036756	5,70
06300002736	27	50	22	39,0	30,0	200	10	036787	6,70
06300003036	30	50	22	42,5	30,0	225	10	036794	8,40
06300003236	32	50	17	44,0	30,0	240	10	395969	9,20
06300003336	33	50	17	46,0	38,0	255	10	395976	9,50
06300003436	34	50	17	48,0	38,0	288	10	395983	11,00

Code	AF	←L→ mm	T mm	D ₁ mm	D ₂ mm	g		EAN	€
06300032136	7/16	40	6,0	18	24,0	71	10	395822	5,40
06300032336	1/2	40	6,0	20	24,0	71	10	395839	5,40
06300032536	9/16	40	7,0	22	24,0	71	10	395846	5,40
06300032736	5/8	40	8,0	25	25,0	77	10	395853	5,50
06300032936	11/16	40	9,0	26	26,0	94	10	395860	5,50
06300033136	3/4	40	9,5	28	28,0	113	10	395877	5,50
06300033336	13/16	40	11,0	30	30,0	121	10	395884	7,30
06300033436	7/8	40	13,0	32	30,0	133	10	395891	7,40
06300033536	15/16	40	13,0	34	30,0	152	10	395907	7,40
06300033736	1	40	13,0	36	30,0	142	10	395914	10,70
06300033836	1.1/16	45	13,0	38	30,0	181	10	395921	10,70
06300033936	1.1/8	50	17,0	40	30,0	209	10	395938	13,70
06300034236	1.1/4	50	17,0	44	30,0	240	10	395945	14,80
06300034136	1.5/16	50	17,0	46	38,0	256	10	395952	18,40

6300-19

IMPACT-Steckschlüssel-Einsätze, extra lang

DIN 3129 / ISO 2725
Chrom Molybdän
PH = phosphatiert

IMPACT-Sockets, extra deep

DIN 3129 / ISO 2725
Chrome molybdenum
PH = phosphated

Douilles IMPACT, extra longues

DIN 3129 / ISO 2725
Chrome molybdène
PH = phosphatées

Llaves de vaso de IMPACTO, serie extra-larga

DIN 3129 / ISO 2725
Cromo molibdeno
PH = fosfatado

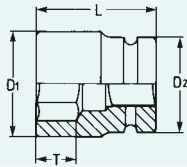

Code	ØMM	←L→ mm	T mm	D ₁ mm	D ₂ mm	g	Box	EAN	€
06300190836	8	78	4,0	15,0	24,0	117	10	395990	11,60
06300191036	10	78	14,0	17,5	25,0	155	10	036800	11,60
06300191336	13	78	14,0	21,3	25,0	165	10	036817	11,60
06300191436	14	78	17,0	22,5	25,0	175	10	036824	11,60
06300191636	16	78	17,0	25,0	30,0	240	10	036831	11,80
06300191736	17	78	17,0	26,0	30,0	250	10	036848	11,80
06300191836	18	78	17,0	27,8	30,0	250	10	036855	11,80
06300191936	19	78	19,0	28,7	30,0	260	10	036862	11,80
06300192136	21	78	24,0	30,0	30,0	245	10	036879	11,80
06300192236	22	78	24,0	32,0	30,0	270	10	036886	11,80
06300192336	23	78	13,0	32,0	30,0	277	10	396003	12,40
06300192436	24	78	24,0	35,0	30,0	280	10	036893	12,20
06300192736	27	78	24,0	38,7	30,0	310	10	036909	14,20
06300193036	30	78	16,5	42,0	30,0	456	10	396010	15,00
06300193236	32	78	17,0	44,0	30,0	376	10	396027	16,00

6300-18

IMPACT-Einsätze, mit Schutzhülse

DIN 3129 / ISO 2725
Chrom Molybdän
PH = phosphatiert

IMPACT-Sockets, with plastic sleeve

DIN 3129 / ISO 2725
Chrome molybdenum
PH = phosphated

Douilles IMPACT avec manchon de protection

DIN 3129 / ISO 2725
Chrome molybdène
PH = phosphatées

Llaves de vaso de IMPACTO con casquillo de protección

DIN 3129 / ISO 2725
Cromo molibdeno
PH = fosfatado



Code	ØMM	←L→ mm	T mm	D ₁ mm	D ₂ mm	g	Box	EAN	€
06300181736	17	85	20	24,3	30,0	204	10	396034	14,70
06300181936	19	85	20	26,3	30,0	212	10	396041	14,70
06300182136	21	85	20	28,3	30,0	235	10	396058	14,70
06300182236	22	85	20	30,3	32,0	267	10	396065	14,70

6300-31

IMPACT-Schraubendreher-Einsätze für Innensechskant-Schrauben

DIN 3129 / ISO 2725
Chrom Molybdän
PH = phosphatiert

IMPACT-Screwdriver-sockets for hexagon socket screws

DIN 3129 / ISO 2725
Chrome molybdenum
PH = phosphated

Douille tournevis IMPACT pour vis six pans

DIN 3129 / ISO 2725
Chrome molybdène
PH = phosphatées

Destornillador de IMPACTO para tornillos de hexágono interior

DIN 3129 / ISO 2725
Cromo molibdeno
PH = fosfatado



Code	ØMM	←L→ mm	T mm	D ₂ mm	g	Box	EAN	€
06300310236	5	60	10	25,0	76	10	396072	11,90
06300310336	6	60	10	25,0	78	10	396089	11,90
06300310436	8	60	10	25,0	88	10	396096	11,90
06300310536	10	60	10	25,0	95	10	396102	11,90
06300310636	12	60	10	25,0	105	10	396119	12,60
06300310736	14	60	10	25,0	121	10	396126	12,60
06300310836	17	60	10	25,0	145	10	396133	14,20
06300310936	19	60	10	25,0	163	10	396140	14,20

6300-20

IMPACT-Steckschlüssel-
Einsätze für
Aussen-TORX® Schrauben

DIN 3129 / ISO 2725
Chrom Molybdän
PH = phosphatiert

IMPACT-Sockets
for TORX®-Head screws

DIN 3129 / ISO 2725
Chrome molybdenum
PH = phosphated

Douille IMPACT
pour vis mâles TORX®

DIN 3129 / ISO 2725
Chrome molybdène
PH = phosphatées

Destornillador de IMPACTO
para tornillos TORX® exteriores

DIN 3129 / ISO 2725
Cromo molibdeno
PH = fosfatado



Code	mm	←L→ mm	T mm	D ₁ mm	D ₂ mm	g	g	EAN	€
06300201036	E 10	38	10	15,0	25,0	88	10	396157	7,80
06300201236	E 12	38	10	16,0	25,0	87	10	396171	7,80
06300201436	E 14	38	10	19,0	25,0	89	10	396195	7,80
06300201636	E 16	38	10	20,0	25,0	87	10	396201	7,80
06300201836	E 18	38	10	22,0	25,0	88	10	396218	7,80
06300202036	E 20	38	10	25,0	25,0	136	10	396225	8,50
06300202436	E 24	45	10	28,5	30,0	159	10	396232	8,50

6300-36

IMPACT-Schraubendreher
Einsätze für
Innen-TORX® Schrauben

DIN 3129 / ISO 2725
Chrom Molybdän
PH = phosphatiert

IMPACT-Screwdriver
sockets for
TORX® socket screws

DIN 3129 / ISO 2725
Chrome molybdenum
PH = phosphated

Douille tournevis IMPACT
pour vis TORX®

DIN 3129 / ISO 2725
Chrome molybdène
PH = phosphatées

Destornillador de IMPACTO
para tornillos TORX® interiores

DIN 3129 / ISO 2725
Cromo molibdeno
PH = fosfatado



Code	mm	←L→ mm	T mm	D ₂ mm	g	g	EAN	€
06300363036	T-30	60	3,18	25,0	76	10	396249	18,30
06300364036	T-40	60	3,30	25,0	78	10	396256	18,80
06300364536	T-45	60	3,81	25,0	81	10	396263	20,10
06300365036	T-50	60	4,57	25,0	84	10	396270	21,20
06300366036	T-60	60	7,62	25,0	101	10	396294	22,00
06300367036	T-70	60	8,89	25,0	113	10	396287	21,20

6300-50

IMPACT-Schraubendreher-
und Steckschlüsseleinsatz-
Sortiment, 13-tlg.

Für Aussen-TORX® Schrauben und
Innen-TORX® Schrauben.
Metallkasten 220 x 110 x 40 mm

DIN 3129 / ISO 2725
Chrom Molybdän
PH = phosphatiert

IMPACT-Combined set of
sockets and screwdriver
sockets, 13 pcs.

For TORX®-Head screws and
TORX® socket screws.
Metal case 220 x 110 x 40 mm

DIN 3129 / ISO 2725
Chrome molybdenum
PH = phosphated

Tournevis IMPACT et jeu de
douilles, 13 pcs.

Pour vis mâles TORX® et vis TORX®.
Coffret métallique 220 x 110 x 40 mm

DIN 3129 / ISO 2725
Chrome molybdène
PH = phosphatées

Juego combinado de
destornilladores y vasos de
IMPACTO, de 13 piezas

Para tornillos TORX® exteriores y tornillos
TORX® interiores.
Cajas metálicas 220 x 110 x 40 mm

DIN 3129 / ISO 2725
Cromo molibdeno
PH = fosfatado



Code	No.	tlg./pcs.	g	g	EAN	€
06300500036	6300-50	13	1750	1	405859	175,00

enthaltend/containing

Stck./pcs.	Artikel/article	No.	Maße/dimensions
7		6300-20	E 10 12 14 16 18 20 24
6		6300-36	T 30 40 45 50 60 70

6300-55

IMPACT-Schraubendreher-einsatz-Sortiment, 8-tlg.

Für Innensechskant-Schrauben.
Metallkasten 170 x 80 x 30 mm

DIN 3129 / ISO 2725
Chrom Molybdän
PH = phosphatiert

IMPACT-Set with screw driver sockets, 8 pcs.

For hexagon socket screws.
Metal case 170 x 80 x 30 mm

DIN 3129 / ISO 2725
Chrome molybdenum
PH = phosphated

Jeu de douilles tournevis IMPACT, 8 pces.

Pour vis six pans.
Coffret métallique 170 x 80 x 30 mm

DIN 3129 / ISO 2725
Chrome molybdène
PH = phosphatées



Juego de destornilladores de IMPACTO, de 8 piezas

Para tornillos de hexágono interior.
Cajas metálicas 170 x 80 x 30 mm

DIN 3129 / ISO 2725
Cromo molibdeno
PH = fosfatado



Code	No.	tlg./pcs.	g		EAN	€
06300550036	6300-55	8	800	1	405804	99,00

enthaltend/containing			
Stck./pcs.	Artikel/article	No.	Maße/dimensions
8	  	6300-31	MM 5 6 8 10 12 14 17 19

6300-58

IMPACT-Schraubendreher-einsatz-Sortiment, 6-tlg.

Für Innen-TORX® Schrauben.
Metallkasten 170 x 80 x 30 mm

DIN 3129 / ISO 2725
Chrom Molybdän
PH = phosphatiert

IMPACT-Set with screw driver sockets, 6 pcs.

For TORX® socket screws.
Metal case 170 x 80 x 30 mm

DIN 3129 / ISO 2725
Chrome molybdenum
PH = phosphated

Jeu de douilles tournevis IMPACT, 6 pces.

Pour vis TORX®.
Coffret métallique 170 x 80 x 30 mm

DIN 3129 / ISO 2725
Chrome molybdène
PH = phosphatées



Juego de destornilladores de IMPACTO, de 6 piezas

Para tornillos TORX® interiores.
Cajas metálicas 170 x 80 x 30 mm

DIN 3129 / ISO 2725
Cromo molibdeno
PH = fosfatado



Code	No.	tlg./pcs.	g		EAN	€
06300580036	6300-58	6	800	1	405835	120,00

enthaltend/containing			
Stck./pcs.	Artikel/article	No.	Maße/dimensions
6	  	6300-36	T 30 40 45 50 60 70

6500

IMPACT-Steckschlüssel-Einsätze

DIN 3129 / ISO 2725
Chrom Molybdän
PH = phosphatiert

IMPACT-Sockets

DIN 3129 / ISO 2725
Chrome molybdenum
PH = phosphated

Douilles IMPACT

DIN 3129 / ISO 2725
Chrome molybdène
PH = phosphatées

Llaves de vaso de IMPACTO

DIN 3129 / ISO 2725
Cromo molibdeno
PH = fosfatado

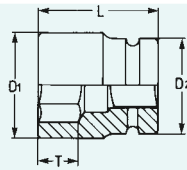

Code	⊙MM	←L→ mm	T mm	D ₁ mm	D ₂ mm	⚖ g	📦	EAN	€
06500001736	17	50	12	31,0	44,0	365	10	037050	13,30
06500001836	18	51	14	31,0	44,0	330	10	396300	13,30
06500001936	19	50	14	33,0	44,0	389	10	037067	13,30
06500002236	22	50	16	37,0	44,0	375	10	037074	14,40
06500002436	24	50	16	39,2	44,0	390	10	037081	14,40
06500002736	27	54	16	43,0	44,0	415	10	037098	15,60
06500003036	30	54	23	47,0	44,0	430	10	037104	15,60
06500003236	32	56	23	49,2	44,0	450	10	037111	17,30
06500003336	33	56	23	51,0	44,0	485	5	037128	19,90
06500003436	34	57	21	51,0	44,0	500	5	396317	21,20
06500003636	36	56	23	54,0	44,0	505	5	037135	19,70
06500003836	38	58	24	57,0	44,0	568	5	037142	23,80
06500004136	41	58	24	60,0	44,0	640	5	037159	26,30
06500004636	46	63	27	67,0	44,0	740	5	037166	31,00

Code	⊙AF	←L→ mm	T mm	D ₁ mm	D ₂ mm	⚖ g	📦	EAN	€
06500033436	7/8	51	14	36,00	42,0	320	10	396324	15,70
06500033536	15/16	51	14	38,50	42,0	340	10	396331	15,40
06500033736	1	53	16	40,00	42,0	340	10	396348	16,40
06500033836	1.1/16	53	20	42,50	44,0	380	10	396355	16,60
06500033936	1.1/8	53	20	44,00	44,0	390	10	396362	16,90
06500034136	1.1/4	57	21	48,50	44,0	450	5	396379	18,70
06500034236	1.5/16	57	21	50,00	44,0	490	5	396386	21,70
06500034336	1.3/8	57	21	52,50	44,0	500	5	396393	21,70
06500034436	1.7/16	57	21	53,50	44,0	500	5	396409	26,40
06500034536	1.1/2	57	22	56,02	44,0	520	5	396416	26,40
06500034736	1.5/8	58	22	60,00	44,0	590	5	396423	28,50
06500034836	1.11/16	62	25	62,50	44,0	650	5	396430	30,10
06500034936	1.3/4	62	25	64,00	44,0	670	5	396447	30,80
06500035236	1.7/8	68	30	68,00	44,0	820	1	396454	40,00
06500035136	2	68	30	71,00	44,0	830	1	396461	46,10

6500-19

IMPACT-Steckschlüssel- Einsätze, extra lang

DIN 3129 / ISO 2725
Chrom Molybdän
PH = phosphatiert

IMPACT-Sockets, extra deep

DIN 3129 / ISO 2725
Chrome molybdenum
PH = phosphated

Douilles IMPACT, extra longues

DIN 3129 / ISO 2725
Chrome molybdène
PH = phosphatées

Llaves de vaso de IMPACTO, serie extra-larga

DIN 3129 / ISO 2725
Cromo molibdeno
PH = fosfatado

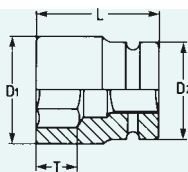

Code	ØMM	←L→ mm	T mm	D ₁ mm	D ₂ mm	g		EAN	€
06500191736	17	90	26	30,0	44,0	490	5	396591	20,60
06500191936	19	95	23	33,0	44,0	590	5	037173	20,70
06500192136	21	90	26	35,0	44,0	530	5	396607	20,80
06500192236	22	95	23	37,0	44,0	655	5	037180	22,00
06500192436	24	95	51	39,2	44,0	710	5	037197	22,00
06500192736	27	95	62	42,5	44,0	780	5	037203	22,70
06500193036	30	95	62	47,0	44,0	710	5	037210	27,60
06500193236	32	95	62	49,2	44,0	890	5	037227	29,40
06500193336	33	95	62	51,0	44,0	810	5	037234	35,90
06500193436	34	95	62	52,0	44,0	835	5	037241	38,70
06500193636	36	95	62	54,0	44,0	995	5	037258	36,10
06500193836	38	90	34	56,0	44,0	880	5	396614	36,60
06500194136	41	95	60	60,0	44,0	1100	5	037265	37,30
06500194636	46	90	34	66,0	44,0	1500	2	037272	40,00



6500-31

IMPACT-Schraubendreher-Einsätze für Innensechskant-Schrauben

DIN 3129 / ISO 2725
Chrom Molybdän
PH = phosphatiert

IMPACT-Screwdriver-sockets for hexagon socket screws

DIN 3129 / ISO 2725
Chrome molybdenum
PH = phosphated

Douille tournevis IMPACT pour vis six pans

DIN 3129 / ISO 2725
Chrome molybdène
PH = phosphatées

Destornillador de IMPACTO para tornillos de hexágono interior

DIN 3129 / ISO 2725
Cromo molibdeno
PH = fosfatado



Code	MM	←L→ mm	T mm	D ₂ mm	g	mm	EAN	€
06500310736	14	90	20	44,0	550	10	396621	21,30
06500310836	17	90	20	44,0	570	10	396638	21,30
06500310936	19	90	20	44,0	580	10	396645	21,30
06500312036	22	90	20	44,0	600	10	396652	21,30
06500312136	24	90	20	44,0	620	10	396669	21,30
06500312236	27	90	20	44,0	650	10	396676	21,30

6600

IMPACT-Steckschlüssel-Einsätze

DIN 3129 / ISO 2725
Chrom Molybdän
PH = phosphatiert

IMPACT-Sockets

DIN 3129 / ISO 2725
Chrome molybdenum
PH = phosphated

Douilles IMPACT

DIN 3129 / ISO 2725
Chrome molybdène
PH = phosphatées

Llaves de vaso de IMPACTO

DIN 3129 / ISO 2725
Cromo molibdeno
PH = fosfatado

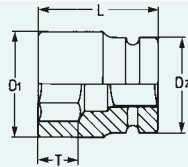

Code	MM	←L→ mm	T mm	D ₁ mm	D ₂ mm	g	mm	EAN	€
06600001936	19	58	17	35,0	54,0	565	5	037517	22,00
06600002436	24	58	17	42,0	54,0	640	5	037531	22,00
06600002736	27	58	17	46,0	54,0	640	5	037548	22,00
06600003036	30	60	21	50,0	54,0	688	5	037562	22,00
06600003236	32	60	21	52,0	54,0	678	5	037579	22,00
06600003336	33	60	21	53,0	54,0	683	5	037586	24,50
06600003436	34	64	22	54,0	54,0	710	5	396683	24,50
06600003636	36	65	30	56,0	54,0	678	5	037593	24,50
06600003836	38	65	30	59,0	54,0	752	5	037609	29,10
06600004136	41	67	31	63,0	54,0	886	5	037623	29,10
06600004236	42	68	24	64,0	54,0	900	5	396690	31,70
06600004636	46	74	36	69,0	54,0	1018	5	037630	31,70
06600005036	50	80	42	74,0	54,0	1220	1	037647	36,60
06600005536	55	84	44	80,0	54,0	1425	1	037654	38,40
06600006036	60	87	44	86,0	54,0	1840	1	037661	43,20
06600006536	65	90	46	92,0	54,0	2100	1	037678	65,80
06600007036	70	96	40	99,0	54,0	2300	1	396706	78,10
06600007536	75	102	45	105,0	60,3	2830	1	396713	88,60
06600008036	80	102	45	111,5	60,3	2890	1	396720	95,40

Code	AF	←L→ mm	T mm	D ₁ mm	D ₂ mm	g	mm	EAN	€
06600033736	1	60	19	42,5	54,0	520	5	396737	23,60
06600034136	1.1/4	64	22	51,5	54,0	690	5	396744	23,60
06600034436	1.7/16	66	22	56,5	54,0	750	5	396751	30,40
06600034536	1.1/2	66	22	59,0	54,0	800	5	396768	30,40
06600034736	1.5/8	68	24	62,5	54,0	830	5	396775	30,40
06600035036	1.13/16	72	26	69,0	60,3	1130	5	396782	42,80
06600035136	1.7/8	72	26	70,0	60,3	1250	1	396799	44,50
06600035636	2.1/4	84	36	82,5	60,3	1700	1	396805	63,80

6600-19

IMPACT-Steckschlüssel-Einsätze, extra lang

DIN 3129 / ISO 2725
Chrom Molybdän
PH = phosphatiert

IMPACT-Sockets,
extra deep

DIN 3129 / ISO 2725
Chrome molybdenum
PH = phosphated

Douilles IMPACT,
extra longues

DIN 3129 / ISO 2725
Chrome molybdène
PH = phosphatées

Llaves de vaso de IMPACTO,
serie extra-larga

DIN 3129 / ISO 2725
Cromo molibdeno
PH = fosfatado

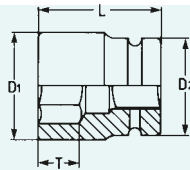

Code	ØMM	←L→ mm	T mm	D ₁ mm	D ₂ mm	g	Stk.	EAN	€
06600192236	22	100	21	40,0	54,0	960	5	037692	34,70
06600192436	24	100	21	42,0	54,0	1000	5	037708	34,70
06600192736	27	100	23	46,0	54,0	1090	5	037715	34,70
06600193036	30	100	50	50,0	54,0	1055	5	037722	37,60
06600193236	32	100	50	52,0	54,0	1065	5	037739	38,80
06600193336	33	100	50	53,0	54,0	1095	5	037746	42,40
06600193436	34	108	35	54,0	54,0	1240	5	396812	42,40
06600193636	36	100	64	56,0	54,0	1300	5	037753	40,30
06600193836	38	100	64	58,0	54,0	1250	5	037760	43,70
06600194136	41	100	64	63,0	54,0	1266	2	037784	45,80
06600194636	46	100	62	69,0	54,0	1535	2	037791	59,50
06600195036	50	100	62	74,0	54,0	1487	2	037807	64,00
06600195536	55	100	60	80,0	54,0	1812	1	037814	70,00

6600-31

IMPACT-Schraubendreher-Einsätze für Innensechskant-Schrauben

DIN 3129 / ISO 2725
Chrom Molybdän
PH = phosphatiert

IMPACT-Screwdriver-sockets for hexagon socket screws

DIN 3129 / ISO 2725
Chrome molybdenum
PH = phosphated

Douille tournevis IMPACT pour vis six pans

DIN 3129 / ISO 2725
Chrome molybdène
PH = phosphatées

Destornillador de IMPACTO para tornillo con hexágono interior

DIN 3129 / ISO 2725
Cromo molibdeno
PH = fosfatado



Code	ØMM	←L→ mm	T mm	D ₂ mm	g	Stk.	EAN	€
06600310936	19	100	20	54,0	850	5	396829	29,80
06600312036	22	100	20	54,0	920	5	396836	29,80
06600312136	24	100	20	54,0	960	5	396843	29,80
06600312236	27	100	20	54,0	1020	5	396850	29,80
06600312336	30	100	20	54,0	1090	5	396867	29,80
06600312436	32	100	20	54,0	1120	5	396874	29,80

6300-19

IMPACT-Steckschlüssel-Garnitur, extra lang

Chrom Molybdän
PH = phosphatiert

In hochwertiger 2-K
Schaumstoffeinlage
Metallkasten 318 x 119 x 49 mm

IMPACT-Socket set,
extra deep

Chrome molybdenum
PH = phosphated

High quality 2-K-foam insert
Metal case 318 x 119 x 49 mm

IMPACT Compositions de
douilles, extra longues

Chrome molybdène
PH = phosphatées

Insert en mousse de haute qualité
en 2 composants
Coffret métallique 318 x 119 x 49 mm

Juegos de llaves de vaso de
IMPACTO, extra-larga

Cromo molibdeno
PH = fosfatado

En bandeja de polispam de gran calidad
Cajas metálicas 318 x 119 x 49 mm



Code	No.	tlg./pcs.	g	Stk.	EAN	€
06300901136	6300-19-M	10	3972	1	366518	164,05

enthaltend/containing

Stk./pcs.	Artikel/article	No.	Maße/dimensions
10		6300-19	MM 13 14 16 17 18 19 21 22 24 27

6301-2 – 6601-5

Verlängerungen

für IMPACT-Steckschlüssel-Einsätze

DIN 3121 / ISO 1174
Chrom-Vanadium
PH = phosphatiert

Extension bars

for IMPACT-Sockets

DIN 3121 / ISO 1174
Chrome-Vanadium
PH = phosphated

Rallonges

pour douilles IMPACT

DIN 3121 / ISO 1174
Chrome-Vanadium
PH = phosphatées

Alargaderas

para llaves de vaso de IMPACTO

DIN 3121 / ISO 1174
Cromo Vanadio
PH = fosfatado

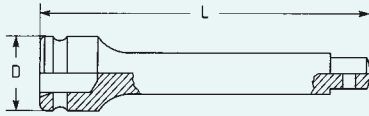

6301-2 – 6301-4

Code	No.	←L→ mm	D mm	g		EAN	€
06301001236	6301-2	125	25,0	240	10	036930	12,10
06301001436	6301-4	250	25,0	485	10	036954	18,30

6501-3 – 6501-5

Code	No.	←L→ mm	D mm	g		EAN	€
06501001336	6501-3	175	44,0	875	5	037296	28,30
06501001436	6501-4	250	44,0	1165	5	037302	34,10
06501001536	6501-5	330	44,0	1455	5	037319	44,50

6601-3 – 6601-5

Code	No.	←L→ mm	D mm	g		EAN	€
06601001336	6601-3	175	54,0	1440	5	037883	40,60
06601001436	6601-4	250	54,0	1950	5	037890	47,60
06601001536	6601-5	330	54,0	2485	2	037906	57,50

6301-10 – 6601-10

Kugelgelenke

für IMPACT-Steckschlüssel-Einsätze

DIN 3121 / ISO 1174
Chrom-Vanadium
PH = phosphatiert

Universal joints

for IMPACT-Sockets

DIN 3121 / ISO 1174
Chrome-Vanadium
PH = phosphated

Rotule

pour douilles IMPACT

DIN 3121 / ISO 1174
Chrome-Vanadium
PH = phosphatées

Articulaciones universales

para llaves de vaso de IMPACTO

DIN 3121 / ISO 1174
Cromo Vanadio
PH = fosfatado

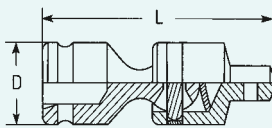

6301-10

Code	←L→ mm	D mm	g		EAN	€
06301001036	60	32	185	10	036916	22,20

6501-10

Code	←L→ mm	D mm	g		EAN	€
06501001036	105	44,0	620	5	037289	47,60

6601-10

Code	←L→ mm	D mm	g		EAN	€
06601001036	133	54,0	1380	5	037869	69,70

6301-22 - 6601-20

Verbindungsstücke

für IMPACT-Steckschlüssel-Einsätze

DIN 3121 / ISO 1174
Chrom-Vanadium
PH = phosphatiert

Converters

for IMPACT-Sockets

DIN 3121 / ISO 1174
Chrome-Vanadium
PH = phosphated

Réducteurs/Augmentateurs

pour douilles IMPACT

DIN 3121 / ISO 1174
Chrome-Vanadium
PH = phosphatées

Reductores/Amplificadores

para llaves de vaso de IMPACTO

DIN 3121 / ISO 1174
Cromo Vanadio
PH = fosfatado

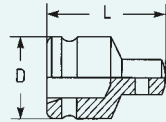

6301-22 ^{1/2}

Code	No.	■	←L→ mm	D mm	g	g	EAN	€
06301002236	6301-22	3/4	48	30	160	10	036978	10,50

6501-20 - 6501-22 ^{3/4}

Code	No.	■	←L→ mm	D mm	g	g	EAN	€
06501002036	6501-20	1/2	56	44,0	310	10	037326	14,20
06501002236	6501-22	1	63	44,0	400	10	037340	17,50

6601-20 ¹

Code	■	←L→ mm	D mm	g	g	EAN	€
06601002036	3/4	75	54,0	660	5	037920	22,50

6301-40-1 - 6601-40

Sicherungs-Gummiringe

für IMPACT-Steckschlüssel-Einsätze

DIN 3129 / ISO 2725
ST = standardmäßig
(Gummi, schwarz)

• Sicherungs-Gummiringe und Sicherungs-Stifte gehören nicht zum Lieferumfang der IMPACT-Steckschlüssel-Einsätze sowie Zubehörteile und müssen gesondert bestellt werden

Retaining rings

for IMPACT-Sockets

DIN 3129 / ISO 2725
ST = standard
(rubber, black)

• Retaining rings and pins are not included with the IMPACT-Sockets and accessories and need to be ordered separately

Bagues de verrouillage

pour douilles IMPACT

DIN 3129 / ISO 2725
ST = standard
(caoutchouc, noir)

• Les bagues et goupilles caoutchouc de verrouillage ne font pas partie du programme des douilles et accessoires IMPACT et doivent être commandées séparément

Arandelas de seguridad

para llaves de vaso de IMPACTO

DIN 3129 / ISO 2725
ST = estándar
(caucho negro)

• Las arandelas y los pasadores de seguridad no están incluidos en el suministro de llaves de vaso y accesorios de IMPACTO, por lo que han de pedirse por separado



Code	No.	für/for □	○MM	g	g	EAN	€
06301104000	6301-40-1	1/2	4 x 19	1	20	036992	0,90
06301204000	6301-40-2	1/2	4 x 24	2	20	037012	1,00
06501004000	6501-40	3/4	5 x 36	3	20	037357	1,20
06601004000	6601-40	1	7 x 45	8	20	037944	1,30

6301-41-1 - 6601-41

Verbindungsstifte

für IMPACT-Steckschlüssel-Einsätze

DIN 3129 / ISO 2725
PH = phosphatiert

• Sicherungs-Gummiringe und Sicherungs-Stifte gehören nicht zum Lieferumfang der IMPACT-Steckschlüssel-Einsätze sowie Zubehörteile und müssen gesondert bestellt werden

Retaining pins

for IMPACT-Sockets

DIN 3129 / ISO 2725
PH = phosphated

• Retaining rings and pins are not included with the IMPACT-Sockets and accessories and need to be ordered separately

Goupilles de verrouillage

pour douilles IMPACT

DIN 3129 / ISO 2725
PH = phosphatées

• Les bagues et goupilles caoutchouc de verrouillage ne font pas partie du programme des douilles et accessoires IMPACT et doivent être commandées séparément

Pasadores de seguridad

para llaves de vaso de IMPACTO

DIN 3129 / ISO 2725
PH = fosfatado

• Las arandelas y los pasadores de seguridad no están incluidos en el suministro de llaves de vaso y accesorios de IMPACTO, por lo que han de pedirse por separado



Code	No.	für/for □	○MM	g	g	EAN	€
06301104136	6301-41-1	1/2	3 x 20	1	20	037005	0,50
06301204136	6301-41-2	1/2	3 x 25	2	20	037029	0,60
06501004136	6501-41	3/4	4 x 35	4	20	037364	1,00
06601004136	6601-41	1	5 x 45	7	20	037951	1,20

6700

IMPACT Werkzeuggarnitur für Druckluftantrieb, 45-tlg.

- Neueste Generation von Impact-Einsätzen
- Kostenreduzierung und optimale Ressourcenschonung durch Austauschbarkeit der Bits
- Mehrfache Kugelarretierung
- Sicherer und passgenauer Halt
- Justierbarer Druckbolzen
- Optimale Anpassung der Aufnahme an die Bits
- Bitschonende Konstruktion für optimale Kraftübertragung
- Hohe Standzeit und Langlebigkeit der Bits
- Hochwertiger Chrom-Molybdän Stahl
- Passgenaue Schaumstoffeinlage im robusten Metallkasten

IMPACT Tool set for operation with compressed air, 45 pcs.

- Latest Generation of IMPACT-Sockets
- Cost reduction and optimum resource conservation through exchangeability of bits
- Multiple ball stop
- Secure and accurate locking
- Adjustable pressure bolt
- Optimum adaption of the holder to the bits
- Bit preserving design for optimum power transmission
- High durability of the bits
- High Grade Chromium Molybdenum Steel
- Accurately fitting foam inlay in a sturdy metal box

Jeu d'outil IMPACT pour fonctionnement avec air comprimé - 45 pièces

- Dernière génération de douilles impact
- Réduction des coûts grâce à l'interchangeabilité des embouts
- Arrêt multiple à billes
- Blocage sécurisé et exacte
- Goupille à pression réglable
- Adaptation optimale du porte-embouts
- Conception idéal des embouts pour une transmission de puissance optimale
- Haute durabilité et longévité des embouts
- Acier chromé molybdène haute qualité
- Insert en mousse en robuste boîtier métallique

Juego de herramientas de IMPACTO para accionamiento con aire comprimado, de 45 pzas

- Última generación de llaves de IMPACTO
- Reducción de costos y óptimo ahorro de energía, gracias a la intercambiabilidad de las puntas
- Sujeción por bolas múltiples
- Sujeción firme y precisa
- Perno de presión ajustable
- Óptima adaptación de la sujeción a las puntas
- Diseño adecuado para óptima transmisión de la fuerza
- Larga duración de las puntas
- Acero al cromo molibdeno
- Cama de polietileno en caja metálica resistente

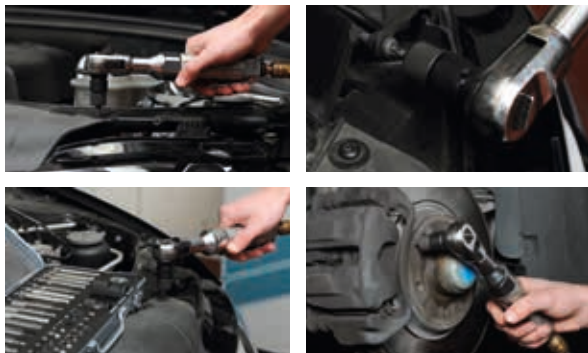

Code	No.	tlg./pcs.			EAN	€
06700904200	6700	45	3900	1	386998	155,40

enthaltend/containing			
Stck./pcs.	Artikel/article	←L→ mm	Maße/dimensions
			3/8"x10 1/2"x10 1/2"x14
		30 75	5/6/7/8/10/12 9/10/13/14
		30 75	5/6/8/10 12/14
		75	16
		30 75	4/5/6/7/8/10/12 13/14/17/19
		30 75	20/25/30/40/45 40/55/60/90/100
		75	70/80

Ersatzteile/Spare parts

Code	←L→ mm	mm		€	Code	←L→ mm	mm		€
06740001036		3/8"x10	1	11,55	06715364005		75	1	1,15
06750001036		1/2"x10	1	12,60	06715365505		75	1	1,15
06750001436		1/2"x14	1	13,65	06715331205		75	1	1,90
06710362005		30	TX20	1	06715340905		75	1	1,25
06710362505		30	TX25	1	06715341005		75	1	1,25
06710363005		30	TX30	1	06720360605		75	1	5,25
06710364005		30	TX40	1	06720360905		75	1	5,80
06710364505		30	TX45	1	06720361005		75	1	6,85
06710330505		30	M5	1	06720360705		75	1	2,65
06710330605		30	M6	1	06720360805		75	1	7,35
06710330805		30	M8	1	06720331405		75	1	2,65
06710331005		30	M10	1	06720331605		75	1	5,25
06710340505		30	R15	1	06720341305		75	1	2,50
06710340605		30	R16	1	06720341405		75	1	2,50
06710340705		30	R17	1	06720301305		75	1	2,30
06710340805		30	R18	1	06720301405		75	1	2,30
06710341005		30	R110	1	06720301705		75	1	3,35
06710341205		30	R112	1	06720301905		75	1	4,75
06710300405		30	4	1					
06710300505		30	5	1					
06710300605		30	6	1					
06710300705		30	7	1					
06710300805		30	8	1					
06710301005		30	10	1					
06710301205		30	12	1					

664 - 796

Drehmomentschlüssel

Übersichts-Tabelle der Drehmomentbereiche

Torque wrenches

Tabular summary of torque ranges

Clés dynamométriques

Tableau synoptique de la capacité des clés dynamométriques

Llaves dinamométricas

Cuadro sinóptico de las gamas de pares de apriete

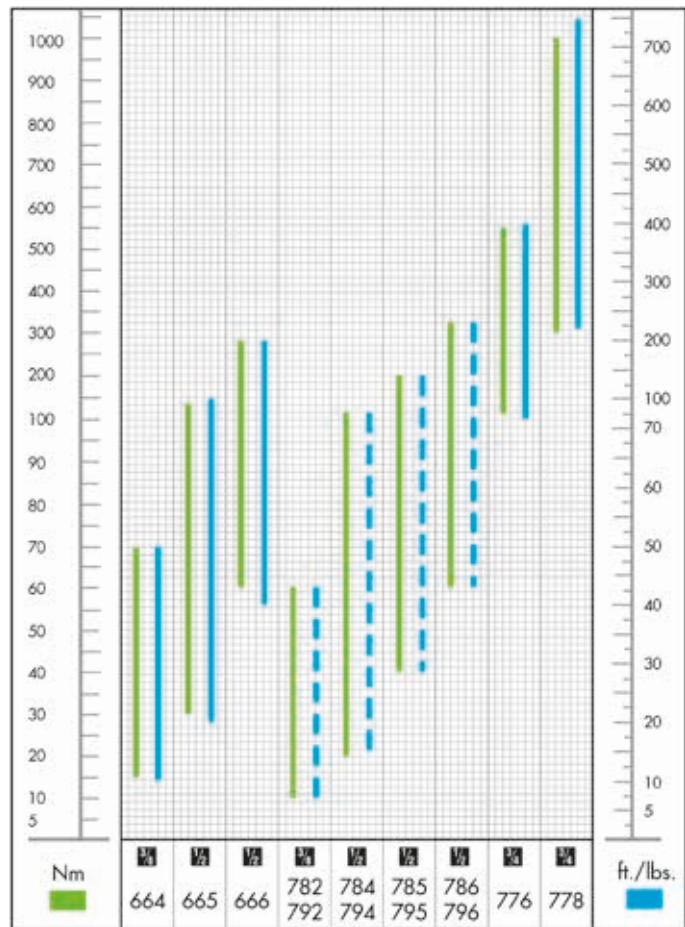

664 - 666

Drehmomentschlüssel mit eingebauter Durchsteckknarre

Verwendung für Rechts- und Linksgewinde, Einstellung durch Rändelschraube am Griffende; automatische Auslösung mit akustischem und fühlbarem Signal bei Erreichen des eingestellten Drehmoments. Genauigkeitsgrad $\pm 4\%$

CPP = verchromt, ganz poliert

Zur Entlastung der Messfeder von allen Drehmomentschlüsseln muß nach Gebrauch immer der kleinste Wert eingestellt werden.

Torque wrenches with built-in push-thru ratchet

For right and left hand threads; setting, with knurled knob at end of handle; automatic release with audible and tactile signal when set torque is reached. Release accuracy $\pm 4\%$

CPP = chromium plated, fully polished

To discharge the measuring spring, all Torque wrenches must always be reset to their lowest value.

Clés dynamométriques avec cliquet

À utiliser pour pas à droite et à gauche, réglage par vis moletée en bout de poignée, déclenchement automatique avec signal acoustique et sensitif dès que le couple programmé est atteint. Degré de précision: $\pm 4\%$

CPP = chromées, entièrement polies

Après utilisation, toujours ramener le réglage de couple de toutes les clés dynamométriques à leur valeur la plus basse, afin de délester le ressort de pression.

Llaves dinamométricas con carraca de cuadradillo pasante

Con carraca de cuadradillo pasante para giro a derecha e izquierda, ajuste mediante tuerca en el extremo del mango de disparo con señal acústica y perceptible al alcanzar el par de apriete. Grado de precisión $\pm 4\%$

CPP = cromado, enteramente pulido espejo

Una vez terminado el trabajo y para evitar una sobrecarga del resorte, conviene ajustar todas las llaves dinamométricas al valor más bajo de la escala.



3/8" 664 · 30 Zähne/teeth · Meßbereich/torque range:
Nm 15 - 70, kpm 1,5 - 7, ft./lbs. 10 - 50



1/2" 665 · 30 Zähne/teeth · Meßbereich/torque range:
Nm 30 - 140, kpm 3 - 14, ft./lbs. 20 - 100



1/2" 666 · 30 Zähne/teeth · Meßbereich/torque range:
Nm 60 - 280, kpm 6 - 28, ft./lbs. 40 - 200

Code	No.	Skaleneinteilung graduation of scale Nm kpm ft./lbs.	←L→ mm	g	g	EAN	€
00664000083	664	15-70 1,5-7 10-50	395-430	1110	1	015522	156,40
00665000083	665	30-140 3-14 20-100	485-520	1365	1	015553	161,70
00666000083	666	60-280 6-28 40-200	520-555	1490	1	015560	177,05



Digitale Drehmomentschlüssel mit integriertem Drehwinkelmessgerät

24-Stunden
Kalibrierungsservice -
Austauschservice

24
- calibration
- exchange service

- Im hochwertigen Metallkasten mit Schaumstoffeinlage
- Drehmoment-Drehwinkelmessung (nicht bei 762)
- Drehwinkelmessbereich größer als >360° möglich
- Voreinstellen von bis zu 10 Messwerten möglich
- Speicherplatz für bis zu 50 Messwerte
- Messwerte können durch mitgelieferte Software zur weiteren Bearbeitung in Excel exportiert werden
- Akustische und optische Signalisierung beim Annähern und Erreichen des voreingestellten Wertes
- Präzise Messgenauigkeit $\pm 2\%$
- Einstellbare Drehmomenteinheiten: Nm, in/lb, ft/lb, kg/cm
- Schaltet bei Nichtgebrauch nach 5 min. automatisch ab um Strom zu sparen
- Ergonomischer 2-K-Griff

Digital torque wrenches with integrated digital angle applicator

- In high quality metal case with foam insert
- Torque and angle measurement (not possible with 762)
- Torque Angle Measurement 360° and more
- Presetting for up to 10 measured values
- Memory for up to 50 measured values
- Measured values can be exported for further processing in excel via supplied software
- Audible and visual signal when approaching and reaching the preset value
- Accuracy $\pm 2\%$
- Adjustable Torque Units: Nm, in/lb, ft/lb, kg/cm
- Automatic turn off after 5 min when it's not in use, to save power
- Ergonomic 2-K-Handle

Clé dynamométrique numérique avec dispositif de mesure d'angle intégré

- En boîtier métallique de haute qualité avec insert en mousse
- Mesure du couple et de l'angle (pas 762)
- Zone angulaire de rotation supérieur à >360° possible
- Préréglage jusqu'à 10 lectures possibles
- Mémoire jusqu'à 50 lectures
- Les valeurs mesurées peuvent être exporté vers excel par logiciel inclus pour traitement
- Signalisation sonore et visuelle à l'approche de la valeur définie
- Précision de la mesure précise de $\pm 2\%$
- Unités de couple réglables: Nm, in/lb, ft/lb, kg/cm
- S'éteint automatiquement après 5 minutes de non utilisation, pour économiser l'énergie
- Poignée ergonomique à 2 composants

Llaves dinamométricas digitales con goniómetro incorporado

- En caja metálica con bandeja de polispam
- Goniómetro (no en 762)
- Posibilidad de angulos de medición superiores a 360
- Posibilidad de preajuste de 10 valores de medición
- Capacidad de memoria de hasta 50 valores de medición
- Mediante un software incluido, se pueden trasvasar las mediciones a Excel para su procesamiento posterior
- Señales acústicas y visuales al aproximar o alcanzar el valor preajustado
- Precisión de medición de $\pm 2\%$
- Unidades de par variables: Nm, in/lb, ft/lb, kg/cm
- Desconexión automática a los 5 minutos de terminar su uso
- Mango ergonómico de plástico de dos componentes



762 - 766

Digitale Drehmomentschlüssel

Chrom-Vanadium
C = verchromt
Hebelumschaltknarrenkopf mit 48 Zähnen in hochwertiger 2-K Schaumstoffeinlage

Digital torque wrenches

Chrome-Vanadium
C = chromium plated
Reversible ratchet head with 48 teeth in high quality 2-K-foam insert

Clé dynamométrique digital

Chrome-Vanadium
C = chromées
Tête de cliquet réversible à 48 dents insert en mousse de haute qualité en 2 composants

Llave dinamométrica digital

Cromo Vanadio
C = cromado
Cabezal de carraca reversible de 48 dientes en bandeja de polispam de gran calidad



Code	No.	■	←L→ mm	Nm	g	g	EAN	€
00762200080	762	1/4"+3/8"	390	12-60	660	1	373110	529,55
• 00764200080	764	1/2"	410	27-135	1000	1	373158	661,95
• 00765200080	765	1/2"	545	40-200	1180	1	373169	706,10
• 00766200080	766	1/2"	640	68-340	1380	1	373219	750,20

* Mit integrierter Drehwinkelmessung / with integrated angle measurement

782 - 786

Drehmomentschlüssel VARI TORQUE mit Hebelumschaltknarre VARICAT

DIN ISO 6789, Typ II, Klasse A
Chrom-Vanadium
C = verchromt
Hebelumschaltknarrenkopf mit 32 Zähnen

Torque wrenches VARI TORQUE with reversible ratchet VARICAT

DIN ISO 6789, Type II, Class A
Chrome-Vanadium
C = chromium plated
Reversible ratchet head with 32 teeth

Clé dynamométrique VARI TORQUE avec cliquet réversible VARICAT

DIN ISO 6789, type II, classe A
Chrome-Vanadium
C = chromées
Tête de cliquet réversible à 32 dents

Llaves dinamométricas VARI TORQUE con cabezal de carraca reversible VARICAT

DIN ISO 6789, tipo II, clase A
Cromo Vanadio
C = cromado
Cabezal de carraca reversible de 32 dientes



Code	No.	■	←L→ mm	Nm	Skalen- einteilung graduation of scale	g	g	EAN	€
00782000080	782	3/8"	320	10-60	0,5 Nm	660	1	136760	319,00
00784000080	784	1/2"	415	20-120	1,0 Nm	1000	1	136777	342,40
00785000080	785	1/2"	520	40-200	1,0 Nm	1180	1	136784	346,40
00786000080	786	1/2"	640	60-320	2,0 Nm	1380	1	136791	374,30

792 - 796

Drehmomentschlüssel VARI TORQUE für Einsteckwerkzeuge (*) (**)

DIN ISO 6789, Typ II, Klasse A
Chrom-Vanadium
C = verchromt

Torque wrenches VARI TORQUE for insert tools (*) (**)

DIN ISO 6789, Type II, Class A
Chrome-Vanadium
C = chromium plated

Clé dynamométrique VARI TORQUE pour outils à emmanchement (*) (**)

DIN ISO 6789, type II, classe A
Chrome-Vanadium
C = chromées

Llaves dinamométricas VARI TORQUE para herramientas intercambiables (*) (**)

DIN ISO 6789, tipo II, clase A
Cromo Vanadio
C = cromado



Code	No.	←L→ mm	Nm	Skalen- einteilung graduation of scale Nm	Einsteck- vierkant plug mm	g	EAN	€
00792000080	792	290	10-60	0,5	9x12	1	136616	270,95
00795000080	795	485	40-200	1,0	14x18	1	136630	290,10
00796000080	796	605	60-320	2,0	14x18	1	136647	317,95

für Einsteckwerkzeuge/for insert tools:

Einsteckknarren VARICAT Reversible ratchet heads VARICAT	792-10 mit Einsteckvierkant/with plug 794-10 mit Einsteckvierkant/with plug	9x12 mm 14x18 mm
Einsteckhalter mit Antriebsvierkant Adapter heads with square	792-21 mit Einsteckvierkant/with plug 794-21 mit Einsteckvierkant/with plug	9x12 mm 14x18 mm
Einsteckmaulschlüssel Open ended jaw wrench insert tools	792-31 mit Einsteckvierkant/with plug 794-31 mit Einsteckvierkant/with plug	9x12 mm 14x18 mm
Einsteckringsschlüssel Ring wrench insert tools	792-41 mit Einsteckvierkant/with plug 794-41 mit Einsteckvierkant/with plug	9x12 mm 14x18 mm
Einsteckringsschlüssel, offen Open ring wrench insert tools	792-51 mit Einsteckvierkant/with plug	9x12 mm

VARITORQUE

Drehmomentschlüssel mit Zertifikat

- Mit der bewährten Hebelumschaltknarre **VARICAT**
- Präzisionswerkzeuge von höchster Genauigkeit und Zuverlässigkeit
- Einstellskala mit Arretierung
- Automatische Kurzwegauslösung
- Hörbares und fühlbares Signal bei Erreichen des eingestellten Drehmomentes
- Höchste Genauigkeit $\pm 3\%$
- Mit integrierter Hebelumschaltknarre oder mit Adapter für Einsteckwerkzeuge
- Verschleißbeanspruchte Teile sind aus Chrom-Vanadium-Stahl präzise gefertigt und gehärtet
- Kunststoffteile aus schlagfestem und chemikalienbeständigen Werkstoffen
- Niedrige Betätigungskraft durch große Längen
- Ergonomisch geformter Griff

Torque wrenches with calibration certificate

- With the approved reversible ratchet **VARICAT**
- Precision tools of highest accuracy and reliability
- Adjustment scale with locking device
- Automatic release
- Audible and tactile signals, when the set torque is reached
- Accuracy $\pm 3\%$
- With integrated reversible ratchet or with adapter for insert tools
- Parts exposed to wear are accurately manufactured from Chrome-Vanadium Steel and are hardened
- Plastic parts are made from shock-proof materials that are resistant to chemicals
- Greater leverage ensures low operating force
- Ergonomically designed handle

Clé dynamométrique avec certificat

- Avec le cliquet à levier **VARICAT** de qualité éprouvée
- Outils de précision à haute sensibilité et fiabilité
- Echelle de réglage avec blocage
- Déconnexion rapide automatique
- Signal acoustique et sensitif dès que le couple programmé est atteint
- Haute précision: $\pm 3\%$
- Avec cliquet à levier intégré ou avec adaptateur pour outils à emmanchement
- Les pièces d'usure sont usinées avec précision en acier au Chrome-Vanadium et trempés
- Éléments plastiques en matériaux antichocs et résistants aux produits chimiques
- Faible force de mise en oeuvre grâce à une grande longueur
- Poignée ergonomique

Llaves dinamométricas con certificado

- Con cabezal de carraca **VARICAT**
- Herramientas de precisión de óptima exactitud y fiabilidad
- Escala de ajuste con fijación
- Disparo automático de corto recorrido
- Señal palpable y acústica al alcanzar el par de apriete seleccionado
- Máxima precisión $\pm 3\%$
- Carraca reversible integrada o con adaptador para herramientas intercambiables
- Todos los elementos sujetos a desgaste están fabricados de acero al cromo vanadio, mecanizados con precisión y templados
- Los elementos de plástico se fabrican de material antichoque y resistente a productos químicos
- Poco esfuerzo de accionamiento gracias a su gran largura
- Empuñadura ergonómica

Qualitätsprüf-Zertifikat
nach DIN 55350 - 16 - 4.1.2

HEYCO

Prüfobjekt:
Drehmoment-Schlüssel

Hersteller:
HEYCO-WERK

Artikel Nr.:
785

Serien Nr.:
01-234004

Einstellbereich:
40 - 200 Nm

Prüfeinrichtung:
5413-2355 C001
Drehmoment-Prüfgerät Fa. SCHATZ

Meßmittel:
5413-1406 Drehmoment-Sensor Fa. SCHATZ 0,1-300 Nm

KPIL - Faktor: 93,8 %

QM SYSTEM
QIS-9000
VDA 6.1

Prüfwerte nach DIN: 6789 Ausgabe:12/93 Genauigkeit: $\pm 3\%$

40 Nm		120 Nm		200 Nm	
min.	max.	min.	max.	min.	max.
38,8 Nm	41,2 Nm	116,4 Nm	123,6 Nm	194 Nm	206 Nm

Die Rückführung der Meßmittel ist gemäß DIN ISO 9001 durch das akkreditierte Kalibrierlabor DKD-K09301, Fa. Schatz, Remscheid, beliebar sichergestellt (meßmittelabhängig).

Datum: 05.07.2001 Prüfer: *J. Heide*

Dieses Zertifikat ist ein kostenloser Service.

137/054-99-2

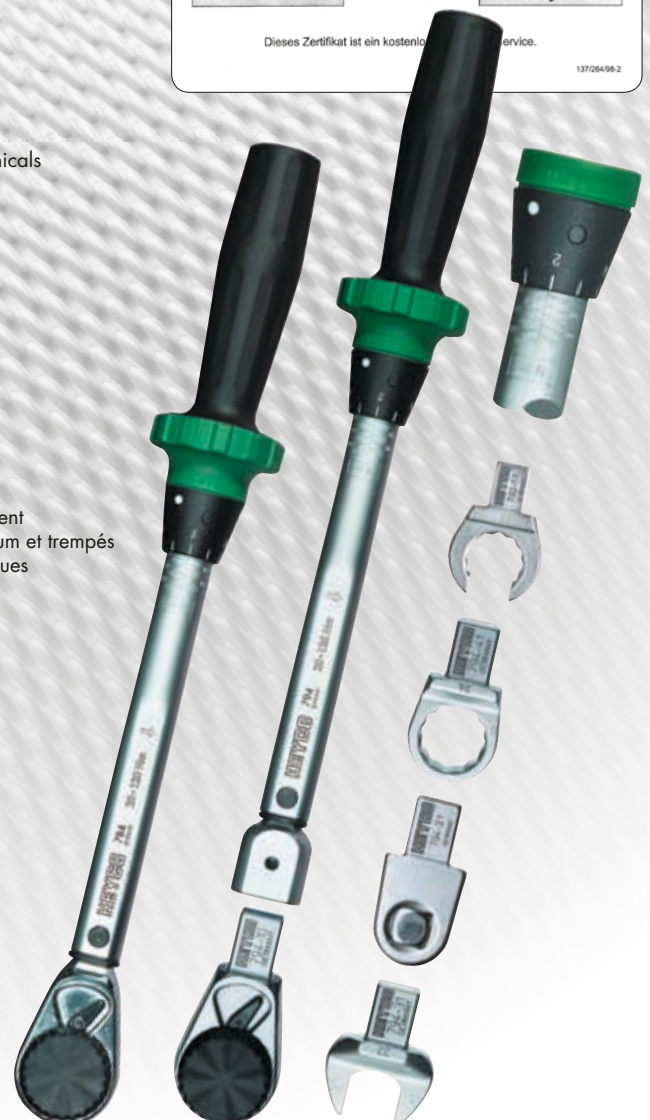

792-10 794-10

Einsteckknarren VARICAT *

Chrom-Vanadium
CPP = verchromt, ganz poliert
32 Zähne

Reversible ratchet heads
VARICAT *

Chrome-Vanadium
CPP = chromium plated,
fully polished, 32 teeth

Cliquet VARICAT
à emmanchement *

Chrome-Vanadium
CPP = chromées, entièrement polies
32 dents

Cabezal de carraca VARICAT *

Cromo Vanadio
CPP = cromado, enteramente pulido espejo
32 dientes

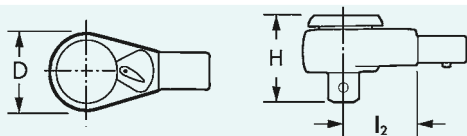

Code	No.	■	L ₂ mm	D	H	für/for No.	g	g	EAN	€
00792100083	792-10	3/8"	30,0	34	33	792	170	1	147230	90,35
00794100083	794-10	1/2"	40,0	45	45	795, 796	380	1	147247	96,50

792-21 794-21

Einsteckhalter mit ** durchsteckbarem Verbindungsvierkant

Chrom-Vanadium
C = verchromt

Adapter heads with
square, **
Push-thru type

Chrome-Vanadium
C = chromium plated

Embout à emmanchement
avec carré d'entraînement
traversant **

Chrome-Vanadium
C = chromées

Adaptador con **
cuadrado de conexión
pasante

Cromo Vanadio
C = cromado

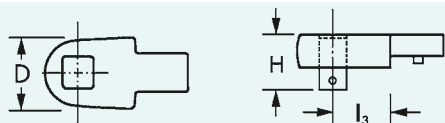

Code	No.	■	l ₃ mm	D	H	für/for No.	g	g	EAN	€
00792210080	792-21	3/8"	17,5	22	24	792	185	1	145489	47,40
00794210080	794-21	1/2"	25,0	30		795, 796	245	1	145502	55,70

792-31 794-31

Einsteckmaulschlüssel **

Chrom-Vanadium
C = verchromt

Open ended jaw wrench
insert tools **

Chrome-Vanadium
C = chromium plated

Clé à fourche
à emmanchement **

Chrome-Vanadium
C = chromées

Llave de boca abierta **

Cromo Vanadio
C = cromado

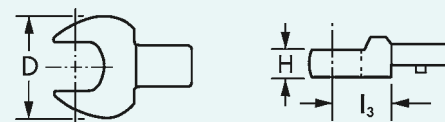

Code	No.	○MM	l ₃ mm	D	H	für/for No.	g	g	EAN	€
00792310880		8	17,5	21,5	5,5		35	1	145359	41,45
00792310980		9	17,5	23,0	5,5		39	1	145366	41,45
00792311080		10	17,5	24,5	5,5		40	1	145373	41,45
00792311180		11	17,5	26,0	5,5		38	1	145380	41,45
00792311280		12	17,5	27,5	5,5		44	1	145397	41,45
00792311380	792-31	13	17,5	29,0	5,5	792	45	1	145403	41,45
00792311480		14	20,0	31,0	7,5		49	1	145410	41,45
00792311580		15	20,0	33,0	7,5		47	1	145427	41,45
00792311680		16	20,0	35,0	7,5		61	1	145434	41,45
00792311780		17	20,0	37,0	7,5		59	1	145441	41,45
00792311980		19	20,0	41,0	7,5		72	1	145465	41,45

792-31 794-31

Einsteckmaulschlüssel **

Chrom-Vanadium
C = verchromt

Open ended jaw wrench
insert tools **

Chrome-Vanadium
C = chromium plated

Clé à fourche
à emmanchement **

Chrome-Vanadium
C = chromées

Llave de boca abierta **

Cromo Vanadio
C = cromado

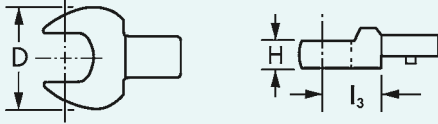

Code	No.	ØMM	I ₃ mm	D	H	für/for No.	g		EAN	€
00794311380	794-31	13	25,0	30,0	7,0	795 + 796	125	1	145236	47,90
00794311480		14	25,0	32,0	7,0		130	1	143256	47,90
00794311580		15	25,0	34,0	7,0		130	1	145243	47,90
00794311680		16	25,0	35,5	9,0		135	1	145250	47,90
00794311780		17	25,0	37,0	9,0		130	1	143249	47,90
00794311880		18	25,0	39,0	9,0		145	1	145267	47,90
00794311980		19	25,0	41,0	9,0		145	1	143232	47,90
00794312180		21	25,0	45,0	11,0		165	1	145274	57,50
00794312280		22	25,0	47,0	11,0		165	1	145281	57,50
00794312480		24	25,0	51,0	11,0		170	1	145298	57,50
00794312780		27	32,5	58,5	13,0		215	1	145304	64,50
00794313080		30	32,5	63,0	13,0		245	1	145311	64,50
00794313280		32	32,5	65,0	13,0		235	1	145328	64,50
00794313480		34	32,5	68,5	13,0		240	1	145335	64,50

792-41 794-41

Einsteckringschlüssel **

Chrom-Vanadium
C = verchromt

Ring wrench
insert tools **

Chrome-Vanadium
C = chromium plated

Clé polygonale
à emmanchement **

Chrome-Vanadium
C = chromées

Llave de boca estrella **

Cromo Vanadio
C = cromado

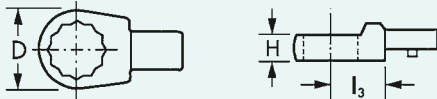

Code	No.	ØMM	I ₃ mm	D	H	für/for No.	g		EAN	€
00792410880	792-41	8	17,5	20,0	8,0	792	35	1	144970	43,75
00792411080		10	17,5	20,0	8,0		39	1	147254	43,75
00792411180		11	17,5	20,0	8,0		40	1	144987	43,75
00792411280		12	17,5	22,0	12,0		48	1	144994	43,75
00792411380		13	17,5	22,0	12,0		50	1	145007	43,75
00792411480		14	17,5	23,0	12,0		50	1	145014	43,75
00792411580		15	17,5	24,0	12,0		51	1	145021	43,75
00792411680		16	17,5	26,0	13,0		55	1	145038	43,75
00792411780		17	17,5	27,0	13,0		54	1	145045	43,75
00792411880		18	17,5	28,5	13,0		60	1	145052	43,75
00792411980		19	17,5	30,5	13,0		60	1	145069	43,75
00792412180		21	17,5	33,0	15,0		70	1	145076	43,75
00792412280		22	17,5	34,5	15,0		68	1	145083	43,75

Code	No.	ØMM	I ₃ mm	D	H	für/for No.	g		EAN	€
00794411380	794-41	13	25,0	30,0	12,0	795 + 796	120	1	145090	48,80
00794411480		14	25,0	30,0	12,0		121	1	145106	48,80
00794411580		15	25,0	30,0	12,0		124	1	145113	48,80
00794411680		16	25,0	30,0	12,0		135	1	145120	48,80
00794411780		17	25,0	30,0	12,0		131	1	145137	48,80
00794411880		18	25,0	30,5	12,0		134	1	145144	48,80
00794411980		19	25,0	30,0	12,0		140	1	145151	48,80
00794412180		21	25,0	33,0	15,0		141	1	145168	57,80
00794412280		22	25,0	34,5	15,0		143	1	145175	57,80
00794412480		24	25,0	37,5	15,0		150	1	145182	57,80
00794412780		27	31,0	41,5	17,5		161	1	145199	57,80
00794413080		30	31,0	45,0	17,5		179	1	145205	57,80
00794413280		32	31,0	47,5	17,5		178	1	145212	57,80
00794413480		34	31,0	50,5	19,0		210	1	145229	65,45

792-51

Einsteckringschlüssel,
offen **

Chrom-Vanadium
C = verchromt

Open ring wrench
insert tools **

Chrome-Vanadium
C = chromium plated

Clé polygonale ouverte
à emmanchement **

Chrome-Vanadium
C = chromées

Llave de boca estrella,
abierta **

Cromo Vanadio
C = cromado

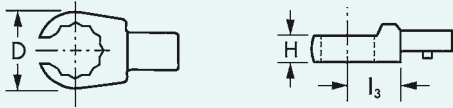
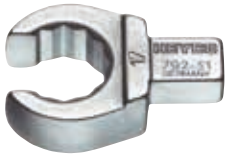

Code	No.	MM	I ₃ mm	D	H	für/for No.	g		EAN	€
00792511080		10	17,5	22,0	9,0		54	1	144963	46,55
00792511180		11	17,5	22,5	9,0		53	1	144956	46,55
00792511280		12	17,5	24,0	12,0		53	1	144949	46,55
00792511380		13	17,5	25,0	12,0		54	1	144932	46,55
00792511480		14	17,5	27,0	12,0		58	1	144925	46,55
00792511680	792-51	16	17,5	30,0	13,0	792	60	1	144918	46,55
00792511780		17	17,5	31,5	13,0		61	1	144901	46,55
00792511880		18	17,5	33,0	13,0		72	1	144895	46,55
00792511980		19	17,5	34,5	13,0		74	1	144888	46,55
00792512180		21	17,5	37,5	15,0		82	1	144871	46,55
00792512280		22	17,5	39,0	15,0		90	1	144864	46,55

** Die Drehmomentschlüssel für Einsteckwerkzeuge 792 – 796 sind werkseitig auf das Maß I₁ mit dem Abstandsmaß I₂ der Einsteckwerkzeuge 792-10 bzw. 794-10 justiert.

** The torque wrenches for insert tools 792 to 796 are adjusted to dimension I₁ with the dimensions I₂ of the insert tools 792-10 respectively 794-10.

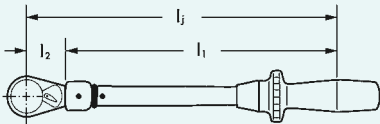

** Bei Verwendung dieser Einsteckwerkzeuge in den vorgenannten Drehmomentschlüsseln muß der einzustellende Drehmomentwert (MdE), bedingt durch die unterschiedlichen Maße I₃, gemäß der nachstehenden Formel berechnet werden.

** When using other insert tools the torque value to be set (MdE) due to different dimensions I₃ must be calculated using the following formula.

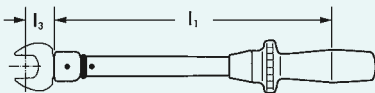

MdE = einzustellendes Drehmoment
torque to be set

MdV = vorgeschriebenes Drehmoment
torque laid down

I₁ = Standardjustierlänge mit Justierwerkzeug
standard length adjustment with adjusting device

I₂ = Wirklänge des Drehmomentschlüssels
effective length of torque wrench

I₃ = Wirklänge des Justierwerkzeuges (Einsteckknarre)
gauge dimension of adjusting device (ratchet)

I₃ = Wirklänge des Einsteckwerkzeuges
gauge dimension of extended insert tool

$$MdE = \frac{(I_1 + I_2) \times MdV}{I_1 + I_3}$$

Umrechnung/conversion lbf-ft in Nm

Umrechnungsfaktor/conversion factor 1 lbf-ft = 1,3558 Nm

Beispiel/example: 55 lbf-ft x 1,3558 = 74,6 Nm

Das Rekalibrieren sowie eventuell anfallende Reparaturarbeiten an HEYCO Drehmomentschlüsseln müssen werkseitig durchgeführt werden.
Re-calibration or eventual repairs to HEYCO torque wrenches are to be carried out at HEYCO-WERK.

792-18 795-20

Drehmoment-Werkzeug-Garnituren

in Metallkästen 515 x 220 x 84 mm

Torque wrench sets

Metal case 515 x 220 x 84 mm

Compositions de clés dynamométriques et embouts

Coffret métallique 515 x 220 x 84 mm

Llave dinamométrica con juego de herramientas intercambiables

En caja metálica 515 x 220 x 84 mm



795-20

Code	No.	tlg./pcs.			EAN	€
00792180080	792-18	18	3000	1	161014	1.074,70

enthaltend/containing

Stck./pcs.	Artikel/article	No.	Maße/dimensions
1		792	10–60 Nm
1		792-10	32 Zähne/teeth, Einsteckvierkant/plug 9 x 12
9		792-31	MM 10 11 12 13 14 15 16 17
9		792-41	MM 10 11 12 13 14 15 16 17

Code	No.	tlg./pcs.			EAN	€
00795200080	795-20	20	6300	1	145526	1.361,80

enthaltend/containing

Stck./pcs.	Artikel/article	No.	Maße/dimensions
1		795	40–200 Nm
1		794-10	32 Zähne/teeth, Einsteckvierkant/plug 14 x 18
9		794-31	MM 13 14 15 16 17 18 19 21 22
9		794-41	MM 13 14 15 16 17 18 19 21 22

776

Drehmomentschlüssel mit 3/4"-Durchstecknarre, mit Griffverlängerung

DIN ISO 6789, Typ II, Klasse A
ST = standardmäßig
Metallkästen 875 x 115 x 95 mm

↔
ohne Griffverlängerung 850 mm
mit Griffverlängerung 1340 mm

Torque wrenches with built-in 3/4" push-through ratchet

DIN ISO 6789, Type II, Class A
ST = standard
Metal case 875 x 115 x 95 mm

↔
without extension handle 850 mm
with extension handle 1340 mm

Clé dynamométrique à cliquet de 3/4" à carré traversant

DIN ISO 6789, type II, classe A
ST = standard
Coffret métallique 875 x 115 x 95 mm

↔
sans poignée de rallonge 850 mm
avec poignée de rallonge 1340 mm

Llaves dinamométricas con carraca de cuadradillo pasante de 3/4"

DIN ISO 6789, tipo II, clase A
ST = estándar
En caja metálica 875 x 115 x 95 mm

↔
sin extensión 850 mm
con extensión 1340 mm



Code	■	Nm	lbf-ft			EAN	€
00776000000	3/4"	110-550	80-400	8200	1	131154	1.886,40

778

Drehmomentschlüssel mit 3/4"-Durchstecknarre, mit Griffverlängerung

DIN ISO 6789, Typ II, Klasse A
ST = standardmäßig
Kunststoffbox 1300 x 230 x 100 mm

↔
ohne Griffverlängerung 1250 mm
mit Griffverlängerung 1740 mm

Torque wrenches with built-in 3/4" push-through ratchet

DIN ISO 6789, Type II, Class A
ST = standard
Plastic box 1300 x 230 x 100 mm

↔
without extension handle 1250 mm
with extension handle 1740 mm

Clé dynamométrique à cliquet de 3/4" à carré traversant

DIN ISO 6789, type II, classe A
ST = standard
En boîte plastique 1300 x 230 x 100 mm

↔
sans poignée de rallonge 1250 mm
avec poignée de rallonge 1740 mm

Llaves dinamométricas con carraca de cuadradillo pasante de 3/4"

DIN ISO 6789, tipo II, clase A
ST = estándar
En caja de plástico 1300 x 230 x 100 mm

↔
sin extensión 1250 mm
con extensión 1740 mm



Code	■	Nm	lbf-ft			EAN	€
00778000000	3/4"	300-1000	220-750	15000	1	145557	2.093,10



Drehmomentschlüssel mit 3/4"-Durchsteckknarre, mit Griffverlängerung

- Höchste Präzision und Zuverlässigkeit
- Über die Seriennummer zugeordnetes Kalibrierzertifikat
- Genauigkeitsgrad $\pm 3\%$
- Niedrige Betätigungskraft durch zum Lieferumfang gehörende Griffverlängerung
- Durchsteckknarre mit 3/4" Vierkant und 60 Zähnen
- Die verschleißbeanspruchten Teile sind aus legierten Stählen präzise gefertigt und gehärtet
- Skala = Nm + lbf - ft
- Arretiernebel zur Feststellung des eingestellten Drehmomentes
- Drehverriegelung zur festen Verbindung der Griffverlängerung mit dem Drehmomentschlüssel

776



Torque wrenches with built-in 3/4"-push-through ratchet with extension handle

- Highest precision and reliability
- With individual calibration certificate and serial-number
- Accuracy $\pm 3\%$
- Complete with extension handle for low-operating force
- Push-through type ratchet with 3/4" square drive and 60 teeth
- Parts exposed to wear are accurately manufactured from alloyed steels and are hardened
- Scale = Nm + lbf - ft
- Locking device for torque value set
- Turn lock fastener for firm connection of extension handle to torque wrench

778



Clé dynamométrique à cliquet réversible de 3/4" à carré traversant, avec rallonge de poignée livrée d'origine

- Hautes précision et fiabilité
- Certificat de calibrage attribué au numéro de série
- Degré de précision: $\pm 3\%$
- Faible force de mise en oeuvre grâce à la rallonge de poignée livrée d'origine
- Cliquet réversible de 3/4" à carré traversant et 60 dents
- Les pièces d'usure sont en acier allié, usinées avec précision et trempées
- Echelle = Nm + lbf - ft
- Bouton d'arrêt pour le blocage du couple sélectionné
- Dispositif de verrouillage rotatif pour assurer la bonne fixation de la poignée de rallonge à la clé dynamométrique



Llaves dinamométricas con carraca de cuadradillo pasante de 3/4"

- Óptima precisión y fiabilidad
- Certificado de calibrado individual para cada llave
- Grado de precisión $\pm 3\%$
- Reducido esfuerzo gracias a la extensión (incluida en la pieza)
- Carraca de cuadradillo de conexión pasante de 3/4", 60 dientes
- Todos los elementos sujetos a desgaste se fabrican de aceros aleados, mecanizados con precisión y templados
- Escala = Nm + lbf - ft
- Botón para fijar el par de apriete seleccionado
- Dispositivo giratorio para conectar y fijar la extensión a la llave dinamométrica



779

Drehmomentvervielfältiger

Chrom-Vanadium
C = verchromt

In hochwertiger 2-K Schaumstoff-
einlage
Metallkasten 350 x 250 x 130 mm

Übersetzungsverhältnis 5:1
Schwere Ausführung für höchste An-
sprüche mit 2 Abstützvorrichtungen



Torque multiplrier

Chrome-Vanadium
C = chromium plated

high quality 2-K-foam insert
Metal case 350 x 250 x 130 mm

Transmission ratio 5:1
Heavy duty version for maximum
demands

Multiplicateur de couple

Chrome-Vanadium
C = chromées

insert en mousse de haute qualité
en 2 composants
Coffret métallique 350 x 250 x 130 mm

Ratio de 5:1
Version lourde pour les hautes performan-
ces à 2 stabilisateurs

Multiplicador del par de torsión

Cromo Vanadio
C = cromado

En bandeja de polispam de 2 componentes
Caja metálica 350 x 250 x 130 mm

Ratio de multiplicación 5:1
Modelo extrafuerte para elevados esfuerzos
con 2 dispositivos de apuntalamiento

Code	Nm			EAN	€
00779100000	max. 2700	4175	1	365986	934,50

695-1

Digitaler Drehmoment-
adapter und Drehwinkel-
meßgerät Drehmoment-
adapter für 40 - 200 Nm

- Im hochwertigen Metallkasten mit 2-K Schaumstoffeinlage
- Ermöglicht das Messen eines Drehmoments und eines Drehwinkels mit jeder 1/2" Knarre
- Voreinstellen von bis zu 10 Messwerten möglich
- Speicherplatz für bis zu 50 Messwerte
- Drehwinkelmessbereich größer als >360°
- Messwerte können durch mitgelieferte Software zur weiteren Bearbeitung in Excel exportiert werden
- Akustische und optische Signalisierung beim Annähern und Erreichen des voreingestellten Wertes
- Präzise Messgenauigkeit ±2%
- Einstellbare Drehmomenteinheiten: Nm, in/lb, ft/lb, kg/cm
- Schaltet bei Nichtgebrauch nach 5 min. automatisch ab um Strom zu sparen
- In Metallkasten 250 x 130 x 90 mm

Digital torque angle
aplicator
for 40 - 200 Nm

- In high quality metal case with foam insert
- Allows the measurement of a torque and a rotation angle with any 1/2" ratchet
- Presetting for up to 10 measured values
- Memory for up to 50 measured values
- Torque Angle Measurement 360° and more
- Measured values can be exported for further processing in excel via supplied software
- Audible and visual signaling when approaching and reaching the preset value
- Accuracy ±2%
- Adjustable Torque Units: Nm, in/lb, ft/lb, kg/cm
- Automatic turn off after 5 min when it's not in use, to save power
- Metal case 250 x 130 x 90 mm

Adaptateur dynamométrique
Digital et Dispositif de serrage
angulaire, Adaptateur de
couple pour 40 à 200 Nm

- En boîtier métallique de haute qualité avec insert en mousse
- Permet la mesure du couple et de l'angle de rotation à chaque 1/2" à cliquet
- Préréglage jusqu'à 10 lectures possibles
- Mémorise jusqu'à 50 lectures
- Zone angulaire de rotation supérieur à >360°
- Les valeurs mesurées peuvent être exporté vers excel par logiciel inclus pour traitement
- Signalisation sonore et visuelle à l'approche de la valeur définie
- Précision de la mesure précise de ±2%
- Unités de couple réglables: Nm, in/lb, ft/lb, kg/cm
- S'éteint automatiquement après 5 minutes de non utilisation, pour économiser l'énergie
- Coffret métallique 250 x 130 x 90 mm

Adaptador dinamométrico
digital y goniómetro
Adaptador dinamométrico para
40 - 200 Nm

- En caja metálica con bandeja de polispam de 2 componentes
- Permite la medición del par y del ángulo de torsión con cualquier tipo de carraca de 1/2"
- Posibilidad de preajuste de 10 valores de medición
- Capacidad de memoria de hasta 50 valores de medición
- Posibilidad de ángulos de medición superiores a 360°
- Mediante un software incluido, se pueden trasvasar las mediciones a Excel para su procesamiento posterior
- Señales acústicas y visuales al aproximar o alcanzar el valor preajustado
- Precisión de medición de ±2%
- Unidades de par variables: Nm, in/lb, ft/lb, kg/cm
- Desconexión automática a los 5 minutos de terminar su uso
- Caja metálica 250 x 130 x 90 mm



24-Stunden
Kalibrierungsservice
Austauschservice - - 24-hours
- calibration
- exchange service

Code	°				EAN	€
00695101000	0-360	82	260	1	371673	290,00





114-115



116-120



121



122-125



126-138



139-145



146-158

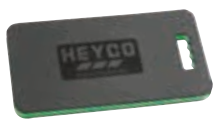

159



160-166



167-169



Radmuttern- und Kreuzschlüssel für PKW und leichte Nutzfahrzeuge

Wheel nut and four way rim wrenches for motor cars and light duty commercial vehicles

Clés à écrous de roues et clés en croix pour voitures et véhicules utilitaires légers

Llaves para ruedas y llaves en cruz para automóviles y vehículos ligeros

Radmuttern- und Kreuzschlüssel für LKW und schwere Nutzfahrzeuge

Wheel nut and four way rim wrenches for trucks and heavy duty commercial vehicles

Clés à écrous de roues et clés en croix pour camions et véhicules utilitaires lourds

Llaves para ruedas y llaves en cruz para camiones y vehículos pesados

501

Radmutternschlüssel

PH = phosphatiert
zu verwenden mit Drehstange
HEYCO 900-18

Wheel nut wrenches

PH = phosphated
to be used with tommy bar
HEYCO 900-18

Clés à écrous de roues

PH = phosphatées
à utiliser avec la broche
HEYCO 900-18

Llaves para ruedas

PH = fosfatado
para utilizar con bandeador
HEYCO 900-18

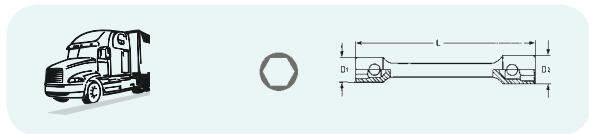

Code	MM	L mm	D ₁ mm	D ₂ mm	g		EAN	€
00501242736	MM 24 x 27	380	36,0	40,0	1200	1	013962	41,95
00501273236	MM 27 x 32	380	40,0	46,0	1320	1	013979	47,00
00501242736	AF 15/16 x 1.1/16	380	36,0	40,0	1200	1	013962	41,95
00501273236	AF 1.1/16 x 1.1/4	380	40,0	46,0	1320	1	013979	47,00

503

Radmutternschlüssel

PH = phosphatiert
zu verwenden mit Drehstange
HEYCO 900-18

Wheel nut wrenches

PH = phosphated
to be used with tommy bar
HEYCO 900-18

Clés à écrous de roues

PH = phosphatées
à utiliser avec la broche
HEYCO 900-18

Llaves para ruedas

PH = fosfatado
para utilizar con bandeador
HEYCO 900-18

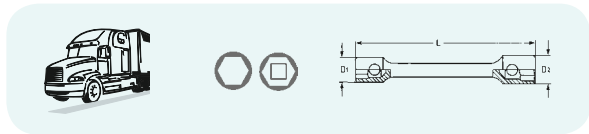

Code	AF	L mm	D ₁ mm	D ₂ mm	g		EAN	€
00503665636	AF 1.1/8 x 13/16 □ x 1.1/2	400	44,0	52,0	1450	1	014020	50,65
00503666436	AF 1.5/16 x 13/16 □ x 1.1/2	400	46,0	52,0	1460	1	014037	50,65

510

Montage-Steckschlüssel

DIN 3112
Chrom-Vanadium
PHS = phosphatiert, Kopf geschliffen
Betätigung mit Drehstange
HEYCO 900

Socket wrenches

DIN 3112
Chrom-Vanadium
PHS = phosphated, ground head
sliding spring tension handle
HEYCO 900

Clés à bécquille fixe

DIN 3112
Chrom-Vanadium
PHS = phosphatées, tête meulée
broche coulissante avec ressort de tension
HEYCO 900

Llaves en T

DIN 3112
Cromo Vanadio
PHS = fosfatado, cabeza amolada
para utilizar con bandeador
HEYCO 900

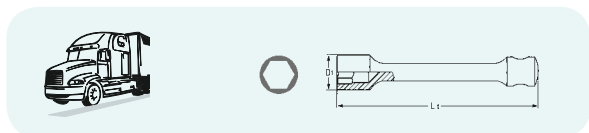

Code	MM	L ₁ mm	L ₂ mm	D ₁ mm	Drehstange Tommy Bar Ø mm	g		EAN	€
00510101237	12	250	200	17,8	10	205	5	014204	28,15
00510101437	14	250	200	20,5	10	265	5	014228	30,80
00510101937	19	315	250	27,5	12	455	5	014259	31,15
00510102437	24	355	320	34,5	14	690	2	014273	37,80
00510103237	32	450	400	45,0	16	1370	2	014303	63,95
00510103637	36	500	500	50,0	18	2060	1	014310	81,30

600-10

Kreuzschlüssel

DIN 3191 / ISO 6788
Chrom-Vanadium
CP = verchromt, Köpfe poliert

Four way rim wrench

DIN 3191 / ISO 6788
Chrome-Vanadium
CP = chromium plated,
polished heads

Clés en croix

DIN 3191 / ISO 6788
Chrome-Vanadium
CP = chromées, têtes polies

Llaves en cruz

DIN 3191 / ISO 6788
Cromo Vanadio
CP = cromado, cabeza pulida espejo



Code	MM	←L→ mm	g	g	EAN	€
00600001082	MM 17 x 19 x 22 x AF 13/16	380	1170	1	015188	59,65



610

Kreuzschlüssel

DIN 3191 / ISO 6788
CL = chromfarbig
● mit zusätzlichem Innenvierkant
AF 13/16
* Chrom-Vanadium

Four way rim wrenches

DIN 3191 / ISO 6788
CL = chrome coloured
● with additional square socket
AF 13/16
* Chrome-Vanadium

Clés en croix

DIN 3191 / ISO 6788
CL = couleur de chrome
● avec carré intérieur additionnel
AF 13/16
* Chrome-Vanadium

Llaves en cruz

DIN 3191 / ISO 6788
CL = cromatizado
● adicionalmente con cuadradillo hembra
de AF 13/16
* Cromo Vanadio



Code	No.	MM	←L→ mm	g	g	EAN	€
00610001070	● 610-1	MM 24 x 27 x 30 x 32	700	4650	1	015409	113,85
00610002070	● 610-2	MM 24 x 27 x 32 x 38	700	4800	1	015416	113,85
00610003170	* 610-31	MM 19 x 22 x 24 x 27	600	2380	1	015423	69,05
00610002070	● 610-4	AF 15/16 x 1.1/16 x 1.1/4 x 1.1/2	700	4800	1	015416	113,85
00610003170	● 610-8	AF 3/4 x 7/8 x 15/16 x 1.1/16	500	2380	1	015423	69,05
00610010070	● 610-10	MM 24 x 27 x 32 x 3/4"	700	4800	1	323528	113,85
00610003070	● 610-30	MM 27 x 30 x 32 x 3/4"	700	4800	1	386196	171,35



530

Doppelsteckschlüssel

Chrom-Vanadium
C = verchromt
massiv geschmiedet,
mit Sechskantschaft

Double ended socket
wrenches

Chrome-Vanadium
C = chromium plated
solid wrought,
with hexagon shaft

Clés en tube

Chrome-Vanadium
C = chromées
forgées dans la masse avec corps
6 pans et possibilité de broche

Llaves de tubo

Cromo Vanadio
C = cromado, cabezas pulidas espejo
forjadas, cuerpo hexagonal

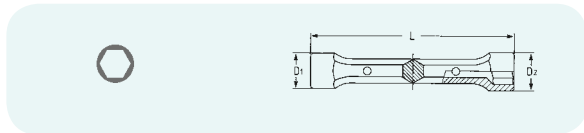

Code	MM	L mm	D ₁ mm	D ₂ mm	passende Drehstange to be used with tommy bar	g		EAN	€
00530060780	6 x 7	103	10,0	11,0	900-3	30	10	310689	12,75
00530080980	8 x 9	108	12,5	13,5	900-3	55	10	310696	13,70
00530101180	10 x 11	120	15,0	16,0	900-4	80	10	310702	14,15
00530121380	12 x 13	138	17,3	18,8	900-5	125	10	310726	17,05
00530141580	14 x 15	143	19,8	21,1	900-6	145	5	310733	20,00
00530161780	16 x 17	153	22,4	23,9	900-6	150	5	310740	21,85
00530181980	18 x 19	163	25,2	26,2	900-8	240	5	310757	27,05
00530202280	20 x 22	173	27,6	30,1	900-8	300	5	310764	28,95
00530212380	21 x 23	183	28,8	30,8	900-10	370	5	310771	33,90
00530242680	24 x 26	193	32,5	34,7	900-10	420	5	310788	37,95
00530242780	24 x 27	193	32,6	36,6	900-12	455	5	310795	37,95
00530252880	25 x 28	203	34,0	37,0	900-12	535	5	310818	40,85

B 530

Doppelsteckschlüssel- Sätze

mit Drehstange,
in Metallkästen
B 530-8-M = 318 x 119 x 49 mm

Double ended socket
wrench sets

with tommy bar,
in metal cases
B 530-8-M = 318 x 119 x 49 mm

Jeux de clés en tube

avec broche,
en coffret métallique
B 530-8-M = 318 x 119 x 49 mm

Juegos de llaves de tubo

con bandeador,
en cajas metálicas
B 530-8-M = 318 x 119 x 49 mm



Code	No.	MM		g	EAN	€
00530644080	B 530-8-M	6 x 7 8 x 9 10 x 11 12 x 13 14 x 15 16 x 17 18 x 19 20 x 22 + No. 1360	 = 1	2350	310863	195,45

K 530

Doppelsteckschlüssel- Sätze



Double ended socket
wrench sets

Jeux de clés en tube

Juegos de llaves de tubo

Code	No.	MM		g	EAN	€
00530944080	K 530-8-M	6 x 7 8 x 9 10 x 11 12 x 13 14 x 15 16 x 17 18 x 19 20 x 22	 = 1	1145	310894	155,40



HEYCO



Neuheit
Novelty
exklusiv aus dem Hause
exclusively by
HEYCO

Spezialrohrschlüssel zum Entlüften und Entnahme der Bremsflüssigkeit mit integriertem Tropfstopp.

Special pipe wrench for venting and removal of brake fluid with integrated drip stop.

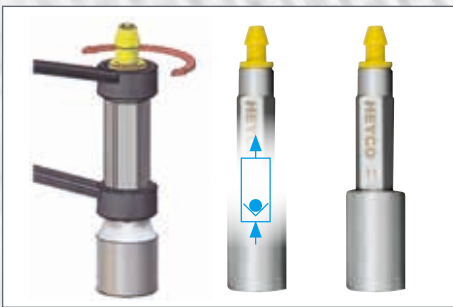

Ermöglicht das Öffnen und Schließen des Entnahmenippels an der Radbremse auf engstem Raum.

Der integrierte Tropfstopp verhindert das Auslaufen der Bremsflüssigkeit nach dem Abziehen des Rohrschlüssels.

Die Betätigung erfolgt über einen Ringschlüssel, der auch bei aufgestecktem Entnahmeschlauch/Rohrschlüssel problemlos umgesetzt werden kann.

Das im Spezialrohrschlüssel und im Entnahmebehälter integrierte Rückschlagventil verhindert bei geöffneter Leitung den ungewollten Rücklauf und das Eindringen von Luft.

Erhebliche Zeiteinsparung beim Wechsel der Bremsflüssigkeit und dem Entlüften des Bremssystems. Lästiges, ständiges Öffnen und Schließen der Bremsanlage am Rad entfällt. Zusätzlich verhindert das geschlossene System das unbeabsichtigte Auslaufen von Bremsflüssigkeit.

Werkzeugsatz mit 5 Schlüsselweiten von 7 - 11 mm in einer kurzen und langen Version (48 mm + 124 mm) deckt sämtliche Einsatzbereiche an allen gängigen Fahrzeugtypen ab.

Allows for opening and shutting of the drain nipple on the wheel brake in confined spaces.

The integrated drip stop prevents leakage of brake fluid after removal of the pipe wrench.

The actuation is effected by a ring wrench. Its position can be altered without difficulty even with the drain tube/pipe wrench attached.

The special pipe wrench as well as the container have integrated check valves preventing unwanted reflux and air intrusion even with the pipe opened.

Considerable saving of time when changing brake fluid or venting the braking system. No permanent and cumbersome opening and shutting of the wheel braking system. Additionally, the closed system prevents leakage of brake fluid.

Tool set with 5 wrench sizes (7 - 11 mm) including a short and a long version (48 mm + 124 mm) covers all applications on all common types of cars.

Gebrauchsmusterschutz
utility model protection



YouTube



531

Werkzeugsatz für die Bremsflüssigkeitsentnahme

- Ermöglicht das Öffnen und Schließen des Entnahmenippels an der Radbremse auf engstem Raum
- Der integrierte Tropfstopp verhindert das Auslaufen der Bremsflüssigkeit nach dem Abziehen des Rohrschlüssels
- Erhebliche Zeitersparnis beim Wechsel der Bremsflüssigkeit und Entlüften des Bremssystems

Tool set for brake fluid extraction

- Allows for opening and shutting of the drain nipple on the wheel brake in confined spaces
- The integrated drip stop prevents leakage of brake fluid after removal of the pipe wrench
- Considerable saving of time when changing brake fluid or venting the brake system

Assortiment d'outils pour extraction de liquide de frein

- Permet d'ouvrir et de fermer l'embout d'évacuation de liquide sur la roue de frein dans des espaces restreints
- L'arrêt d'égouttement intégré empêche les fuites après le retrait de la clé à pipe
- Permet un gain de temps significatif lors du changement de liquide de frein ou la purge du système de freinage.

Juego de herramientas para extracción del líquido de freno

- Facilita la apertura y cierre de la válvula en la rueda, en espacio muy reducido
- El tope integrado de goteo evita que el líquido se escape una vez quitada la llave de tubo
- Gran ahorro de tiempo en la operación de cambio de líquido de freno y aireado del sistema de frenado



Code	No.	tlg. pcs.	g	g	EAN	€
00531010080	531	10	1200	1	395273	245,00

enthaltend /containing			
Stck. pcs.	Artikel article	←L→ mm	MM
1		48	MM 7 8 9 10 11
1		124	MM 7 8 9 10 11



531-19

Bremsenentlüftungsschlüssel

Länge 48 mm
Chrom-Vanadium
verchromt

Brake venting wrenches

Length 48 mm
Chrome-Vanadium
chromium plated

Clé pour la purge des freins

Longueur 48 mm
Chrome-Vanadium
chromées

Llave para airear sistema de freno

Longitud 48 mm
Cromo Vanadio
cromada



Code	AF	←L→ mm	g	g	EAN	€
00531700080	7	48	340	10	393088	24,00
00531800080	8	48	340	10	393095	24,00
00531900080	9	48	340	10	393101	24,00
00531100080	10	48	340	10	393118	24,00
00531110080	11	48	340	10	393125	24,00

531-19

Bremsenentlüftungsschlüssel

Länge 124 mm
Chrom-Vanadium
verchromt

Brake venting wrenches

Length 124 mm
Chrome-Vanadium
chromium plated

Clé pour la purge des freins

Longueur 124 mm
Chrome-Vanadium
chromées

Llave para airear sistema de freno

Longitud 124 mm
Cromo Vanadio
cromada



Code	AF	←L→ mm	g	g	EAN	€
00531907080	7	124	380	10	393187	26,00
00531908080	8	124	380	10	393194	26,00
00531909080	9	124	380	10	393200	26,00
00531910080	10	124	380	10	393217	26,00
00531911080	11	124	380	10	393224	26,00

531-5-1

Entnahmebehälter für Bremsflüssigkeit

1 Schlauch

- Glasfaserverstärkter Kunststoff
- Schlagfest
- 1,3 L Fassungsvermögen
- Eingebautes Rückschlagventil
- Transparenter Silikonschlauch, hochflexibel
- Temperaturunempfindlich
- Aufhängemöglichkeit am Fahrzeug
- Eingebaute Zugentlastung
- Korrosionsbeständige Verschraubungen
- Verschlußkappe
- Durchsichtiger Behälter mit Füllstandsanzeige in ml
- Geschlossenes 1-Schlauch-System zur Entnahme an einem Rad

Draining container for brake fluid

1 Tube

- Glass-Fibre reinforced plastic
- Impact-Proof
- Capacity 1.3 l
- Built-In check valve
- Transparent silicon tube, highly flexible
- Temperature-Immune
- Hanger for use on vehicles
- Built-In strain relief
- Corrosion-Proof fittings
- Closing cap
- Transparent container with level indicator (ml)
- Closed 1-Tube-System for fluid abstraction on one wheel

Récipient pour vidange liquide de freins

1 Tube

- Plastique renforcé de fibre de verre
- Résistant aux chocs
- Capacité 1,3L
- Clapet anti-retour intégré
- Tube silicone transparent, très flexible
- Température insensible
- suspension pour utilisation sur les voitures
- Décharge de traction intégrée
- Raccords résistant à la corrosion
- Bouchon de fermeture
- Récipient transparent avec indicateur de niveau (ml)
- Système avec 1 tube fermé pour enlèvement de liquide sur une roue

Recipiente para líquido de freno

1 Tubo

- Plástico reforzado por fibra
- Resistente
- Capacidad de 1,3L
- Válvula de cierre integrado
- Tubo de silicona transparente, flexible
- Inmune a la temperatura
- Con gancho para colgar en el vehículo
- Resistencia integrada a la tracción
- Atornillados anticorrosivos
- Tapa de cierre
- Recipiente transparente con indicación de relleno en mm
- Sistema cerrado de un tubo para el vaciado de una rueda

1,3L

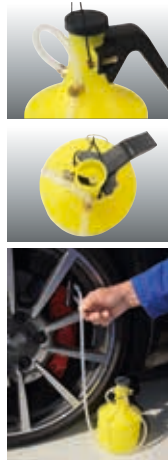

Code	L			EAN	€
00531511300	1,3	300	1	393798	79,00

531-5-2

Entnahmebehälter für Bremsflüssigkeit

2 Schläuche

- Geschlossenes 2-Schlauch-System zur Entnahme an 2 Rädern gleichzeitig

Draining container for brake fluid

2 Tubes

- Closed 2-Tubes-System for fluid abstraction on 2 wheels simultaneously

Récipient pour vidange liquide de freins

2 Tubes

- Système avec 2 tubes fermés pour enlèvement de liquide sur deux roues à la fois

Recipiente para líquido de freno

2 Tubos

- Sistema integral de 2 tubos para drenaje de 2 ruedas a la vez

1,3L

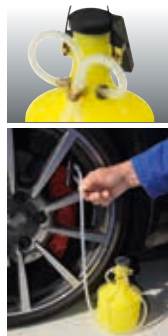

Code	L			EAN	€
00531521300	1,3	400	1	393804	89,00

896

Rohrsteckschlüssel

DIN 896 B
C = verchromt
Betätigung mit Drehstange
HEYCO 900

Double ended tubular
socket wrenches

DIN 896 B
C = chromium plated
to be used with tommy bar
HEYCO 900

Clés en tube

DIN 896 B
C = chromées
à utiliser avec la broche
HEYCO 900

Llaves de tubo

DIN 896 B
C = cromado
a usar con bandeador
HEYCO 900



Code	MM	←L→ mm	passende Drehstange to be used with tommy bar	g		EAN	€
00896060780	6 x 7	100	900-5	25	10	099201	4,25
00896080980	8 x 9	100	900-6	30	10	099218	4,60
00896081080	8 x 10	120	900-6	45	10	099225	4,95
00896101180	10 x 11	120	900-6	45	10	020458	4,95
00896121380	12 x 13	140	900-8	65	10	099249	5,60
00896141580	14 x 15	140	900-8	80	10	099263	6,10
00896161780	16 x 17	150	900-10	130	5	099287	7,20
00896171980	17 x 19	160	900-12	150	5	099294	9,20
00896181980	18 x 19	160	900-12	150	5	099300	9,20
00896202280	20 x 22	170	900-12	220	5	099317	9,90
00896212380	21 x 23	170	900-14	265	5	099324	10,40
00896242680	24 x 26	185	900-14	300	5	099348	11,75
00896242780	24 x 27	185	900-14	300	5	099355	11,75
00896252880	25 x 28	205	900-16	370	5	099362	13,85
00896303280	30 x 32	205	900-16	410	5	099393	15,30
00896323680	32 x 36	225	900-18	540	1	099416	18,20
00896364180	36 x 41	225	900-18	590	1	099423	21,05
00896414680	41 x 46	245	900-20	835	1	099430	24,90
00896465080	46 x 50	245	900-20	1340	1	099447	58,95
00896505580	50 x 55	245	900-20	1815	1	099454	77,10
00896556080	55 x 60	280	900-20	2130	1	099461	85,90

K 896

Rohrsteckschlüssel-Sätze

DIN 896 B

Double ended tubular
socket wrench sets

DIN 896 B

Jeux de clés en tube

DIN 896 B

Juegos de llaves de tubo

DIN 896 B

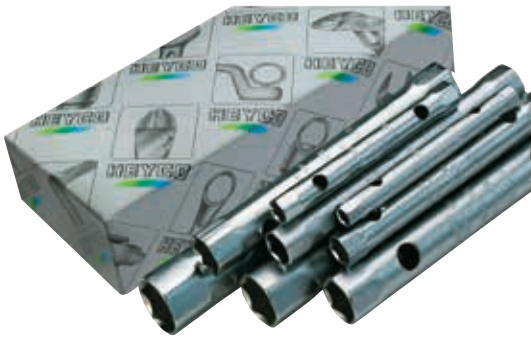

Code	No.	MM	= 1	g	EAN	€		
00896944080	K 896-8-M	6 x 7	8 x 9	10 x 11	12 x 13	835	099782	51,65
		14 x 15	16 x 17	18 x 19	20 x 22			
00896947080	K 896-12-M	6 x 7	8 x 9	10 x 11	12 x 13	2075	099799	102,90
		14 x 15	16 x 17	18 x 19	20 x 22			
		21 x 23	24 x 27	25 x 28	30 x 32			

R 896-9

Rohrsteckschlüssel-Sätze, 9-tlg.

DIN 896 B

Double ended tubular
socket wrench sets, 9 pcs.

DIN 896 B

Jeux de clés en tube,
9 pces.

DIN 896 B

Juegos de llaves de tubo,
9 pzas.

DIN 896 B



Code	No.	MM	= 1	g	EAN	€		
00896744080	R-896-9-M	6 x 7	8 x 9	10 x 11	12 x 13	1071	356274	60,50
		14 x 15	16 x 17	18 x 19	20 x 22			

900

Drehstangen

DIN 900
G = gesandstrahlt

Tommy bars

DIN 900
G = sand blasted

Broches

DIN 900
G = sablées

Bandeadores

DIN 900
G = granallado



Code	No.	←L→ mm	∅ mm	g		EAN	€
0090000305	900-3	80	3,2	8	10	020502	2,75
0090000405	900-4	100	4,0	10	10	020519	2,80
0090000505	900-5	125	5,0	20	10	020526	2,80
0090000605	900-6	160	6,0	35	10	020540	2,25
0090000805	900-8	180	8,0	75	10	020564	2,35
00900001005	900-10	200	10,0	125	10	020588	2,90
00900001205	900-12	250	12,0	225	10	020601	4,60
00900001405	900-14	320	14,0	390	5	020625	6,55
00900001605	900-16	400	16,0	630	5	020656	8,00
00900001805	900-18	500	18,0	1000	5	020670	14,25
00900002005	900-20	630	20,0	1560	5	020694	23,80

1360

Drehstange

Chrom-Vanadium
C = verchromt
abgestuft

Tommy bar

Chrome-Vanadium
C = chromium plated
in steps

Broches

Chrome-Vanadium
C = chromées
étagées

Bandeadores

Cromo Vanadio
C = cromado
escalonados



Code	←L→ mm	∅ mm	g		EAN	€
01360028080	280	3,2 5 6 8 10 12	185	10	028010	9,90

541

Steckschlüssel

DIN 312
Chrom-Vanadium
CPP = verchromt, ganz poliert
mit schlagfestem Kunststoff-Heft

Nut spinners

DIN 312
Chrom-Vanadium
CPP = chromium plated,
fully polished with shockproof
plastic handle

Clés à douilles emmanchées

DIN 312
Chrom-Vanadium
CPP = chromées entièrement polies
manche en matière plastique incassable

Llaves de vaso con mango

DIN 312
Cromo Vanadio
CPP = cromado, enteramente pulido
espejo con mango de plástico antichoque

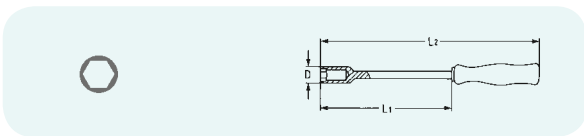

Code	∅MM	L ₁ mm	L ₂ mm	D mm	g		EAN	€
00541000583	5	120	220	8,0	85	10	014617	9,90
00541005583	5,5	120	220	8,0	85	10	014761	9,90
00541000683	6	120	220	9,0	90	10	014624	9,90
00541000783	7	120	220	11,0	95	10	014631	10,55
00541000883	8	120	225	12,0	120	10	014648	11,15
00541001083	10	125	230	14,0	170	10	014662	13,55

545

Steckschlüssel

Chrom-Vanadium
ST = standardmäßig
flexibler Schaft, mit Kunststoffheft

Nut spinners

Chrome-Vanadium
ST = standard
flexible shaft, with shockproof
plastic handle

Clés à douilles emmanchées

Chrome-Vanadium
ST = standard
avec tige flexible et manche plastique

Llaves de vaso con mango

Cromo Vanadio
ST = standard
varilla flexible, mango de plástico

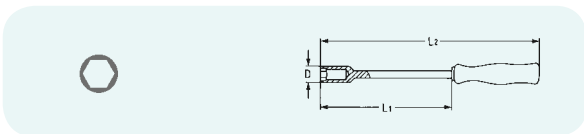

Code	∅MM	L ₁ mm	L ₂ mm	D mm	g		EAN	€
00545000600	6	150	250	11	140	10	099133	21,45
00545000700	7	150	250	11	140	10	099744	21,45

HEYCO-Werkzeugsortimente: Durchdacht bis ins Detail

Branchengerecht zusammengestellte Sortimente für die verschiedensten Anwendungsbereiche und Berufszweige.

Übersichtstabelle der Kombinationsmöglichkeiten – Sortimente/Behältnisse	122
Leere Kästen, Schränke, Truhen	124 – 125
Leere Werkstattwagen	139 – 144

Module für Werkstattwagen

Fachgerecht zusammengestellte Module zur Ordnung 148 – 158
und besseren Übersicht im Werkstattwagen 1128

Kfz-Werkstatt und Wartung

Kundendienst-Sortiment HEYCO 910	127 – 128
Werkstatt-Wartung HEYCO 1000-914 – 1000-915	137 – 138
Leerer Werkstattschrank HEYCO 1101	125
Werkstattschrank HEYCO 1101 mit Sortiment 911	129 – 130

LKW, Landmaschinen

LKW-Reparatur und Wartung HEYCO 933
 131 – 132 |

Mechanik, Industrie und Wartung

Großes Sortiment Mechanik HEYCO 942	133 – 134
Industrie und Wartung HEYCO 943	135 – 136

Ausstellungswände, Verkaufshilfen

Lochplatten-Verkaufswand HEYCO 1170 – 1174	162 – 164
Zubehör 1170-8-1 – 1179-1-2	165 – 169

Die nachfolgenden Tabellen geben Ihnen einen Überblick über die empfohlene Kombinationsmöglichkeiten von Sortimenten und Behältnissen.

Die erste Senkrechtspalte beinhaltet Sortiments-Nummer sowie Bestell-Code-Nummer, die Sie bitte verwenden wollen, wenn das Sortiment lediglich im Karton geliefert werden soll. Wünschen Sie eine Kombination von Sortiment und Behältnis wie Truhe, Wagen, Schrank usw., dann finden Artikelnummer und Bestell-Code-Nummer in der Spalte unter der Abbildung Verwendung.

HEYCO-tool assortments: designed to the last detail

Trade-orientated assortments have been selected for numerous different fields of application, trades and professions.

Tabular summary of alternative combinations – assortments/receptacles	122
Empty cases, wallets, cabinets	124 – 125
Empty workshop trolleys	139 – 144

Modules for workshop trolleys

Well selected modules in workshop trolley 1128 148 – 158
for ease of identification and handling

Motor mechanic workshop and maintenance

Service assortment HEYCO 910	127 – 128
Workshop-maintenance HEYCO 1000-914 – 1000-915	137 – 138
Empty workshop wall cabine HEYCO 1101	125
Workshop wall cabine HEYCO 1101 assortment 911	129 – 130

Trucks, building and agricultural equipment

Truck repair and maintenance HEYCO 933
 131 – 132 |

Mechanics, industry and maintenance

Comprehensive mechanics' set HEYCO 942	133 – 134
Industry and maintenance HEYCO 943	135 – 136

Exhibition boards, tool bars, selling aids

Perforated tool bar HEYCO 1170 – 1174	162 – 164
Accessories 1170-8-1 – 1179-1-2	165 – 169

The tabular summary provides at first glance the recommended alternative combinations of assortments with receptacles.

The first column down contains article number as well as ordering code number which should be used when assortment is to be supplied in cardboard carton only. Should a combination of assortment and receptacle such as chest, trolley, cabinet etc. be required, then article number and ordering code number, in column below corresponding illustration of receptacle, is applicable.

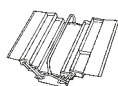

1000

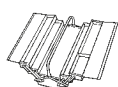

1002-100

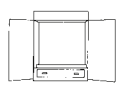

1101*

Kfz-Werkstatt und Wartung / Motor Mechanic Workshop and Maintenance / Réparation et entretien d'automobile / Reparación y mantenimiento del automóvil

	1000	1002-100	1101*
910-M 00910000282	1000-914-M 01000091482	1002-910-M 01002910282	
910-AF 00910000382	1000-915-M 01000091582	1002-910-AF 01002910382	
911-M 00911000282			1101-911-M 01101911282
911-AF 00911000382			1101-911-AF 01101911382

* Der Werkstattschrank HEYCO 1101 ist nur mit dem vorgegebenen Sortiment HEYCO 911 bestückbar.

* The workshop wall cabinet HEYCO 1101 can only be equipped with assortment HEYCO 911.

* L'armoire murale HEYCO 1101 ne peut être équipée qu'avec la sélection HEYCO 911.

* El armario HEYCO 1101 sólo se suministra con el conjunto HEYCO 911.

HEYCO-sélections d'outillage: étudiées jusqu'au moindre détail

Nombreuses compositions d'outillage par profession,
pour les différents domaines d'utilisation et de métiers.

Tableau synoptique des possibilités de combinaisons – sélections/contenants 122	
Boîtes vides, trousse, armoires..... 124 – 125	
Boîtes vides, servantes..... 139 – 144	

Modules pour servantes d'atelier

Modules composés par spécialités professionnelles pour le rangement 148 – 158
et une meilleure vue d'ensemble dans la servante d'atelier 1128

Réparation et entretien d'automobile

Sélection d'entretien HEYCO 910 127 – 128	
Atelier entretien HEYCO 1000-914 – 1000-915 137 – 138	
Armoires murales d'outillage, vides HEYCO 1101 125	
Armoires murales d'outillage HEYCO 1101 avec sélections 911 129 – 130	

Engins de chantier, camions, machines agricoles

Sélection pour réparation et entretien de camions HEYCO 933 131 – 132

Mécanique, industrie et entretien

Sélection complète pour mécanicien HEYCO 942 133 – 134
Sélection pour industrie et entretien HEYCO 943 135 – 136

Présentoirs d'exposition, aides de vente

Présentoirs perforés en tôle d'acier HEYCO 1170 – 1174 162 – 164
Crochets et supports à outils 1170-8-1 – 1179-1-2 165 – 169

Les tableaux suivants donnent un aperçu des combinaisons des ensembles et assortiments

La première colonne verticale indique la référence et le code de la sélection, que vous voudrez bien spécifier dans votre commande si vous désirez recevoir la sélection en boîte carton. Si vous désirez une combinaison de sélections et contenants, comme coffre, servante, armoire etc., vous trouverez la référence et le code dans la colonne en-dessous de l'illustration.



1128



1135

Baustelle, LKW, Landmaschinen /
Trucks, Building and Agricultural Equipment /
Engins de chantier, camions, machines agricoles /
Maquinaria de construcción, camiones,
maquinaria agrícola

	1128	1135
933-M	1128-933-M	1135-933-M
00933000282	01128933282	01135933282
933-AF	1128-933-AF	1135-933-AF
00933000382	01128933382	01135933382

Conjuntos de herramientas HEYCO: bien estudiados hasta en su más mínimo detalle

Numerosos conjuntos, diseñados para satisfacer los
requerimientos de cada gremio, para las aplicaciones
y profesiones más diversas.

Cuadro sinóptico de las posibilidades de combinar – conjuntos/contenedores..... 122	
Cajas, maletas, armarios vacíos 124 – 125	
Carros vacíos 139 – 144	

Módulos para carros de taller

Módulos compuestos adecuadamente, para facilitar un mejor orden 148 – 158
y mayor facilidad de acceso en carros de taller 1128

Reparación y mantenimiento del automóvil

Conjunto para mantenimiento HEYCO 910..... 127 – 128	
Mantenimiento en taller HEYCO 1000-914 – 1000-915 137 – 138	
Armario de herramientas de taller HEYCO 1101 125	
Armarios de herramientas HEYCO 1101 con conjunto 911 129 – 130	

Maquinaria de construcción, camiones, maquinaria agrícola

Conjunto para reparación y mantenimiento de camiones HEYCO 933 131 – 132

Taller mecánico, industria y mantenimiento

Conjunto grande para taller mecánico HEYCO 942 133 – 134
Conjunto para industria y mantenimiento HEYCO 943 135 – 136

Expositores

Expositor de chapa perforada HEYCO 1170 – 1174 162 – 164
Accesorios 1170-8-1 – 1179-1-2 165 – 169

Las siguientes tablas le facilitan una idea sobre las posibles y recomendadas
combinaciones de complementos y contenedores

La primera columna vertical indica la referencia del conjunto y su número de
código, que se debe reseñar en el pedido si desea recibir el conjunto en caja de
cartón. Si Vd. quiere combinar el conjunto con algún tipo de contenedor, como
p.e. un cofre, un carro, un armario etc., entonces encontrará la referencia y el
correspondiente código en la columna debajo de la reproducción del contenedor.

Mechanik, Industrie und Wartung /
Mechanics, Industry and Maintenance /
Mécanique, industrie et entretien /
Taller mecánico, industria y mantenimiento

	1128
942-M	1128-942-M
00942000282	01128942282
942-AF	1128-942-AF
00942000382	01128942382
943-M	
00943000282	
943-AF	
00943000382	

1000 1002

Werkzeugkästen

L = lackiert
aus Stahlblech,
mit Vorhängeschloß verschließbar
* bitte gesondert bestellen:
Vorhängeschloß HEYCO 2199

Tool boxes



L = lacquered
sheet steel,
lockable with padlock
* please order separately:
Padlocks HEYCO 2199

Boîtes d'outillage, vides

L = laquées
en tôle d'acier, cadenassable
* a commander séparément:
Cadenas HEYCO 2199

Cajas de herramientas

L = barnizado
de chapa de acero, cierre por candado
* les rogamos lo pidan por separado:
Candado HEYCO 2199

Code	No.	Maße dimensions	 g	Fächer trays		EAN	€
01000010020	1000	530 x 200 x 200 mm	6500	5	1	021240	105,85
01002010020	1002	420 x 200 x 200 mm	5440	5	1	021332	91,80

1000

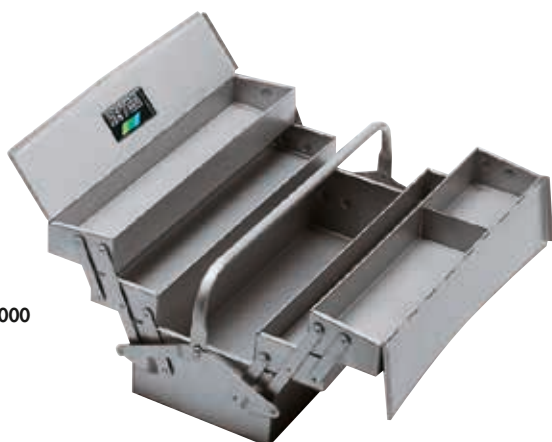

1002

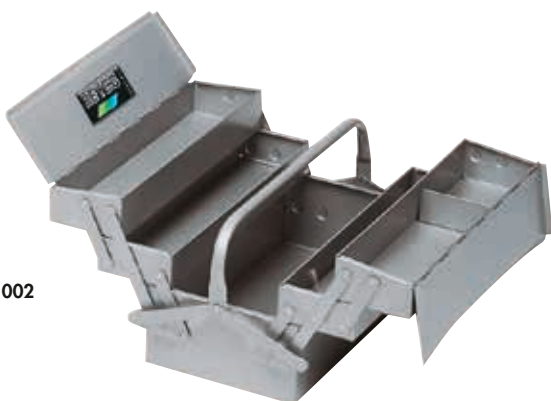

2199

Vorhängeschloß

MS = Messing
mit gehärtetem Stahlbügel,
mit 2 Schlüsseln
spez. für Werkzeugkästen
1000 + 1002

Padlocks

MS = brass
with hardened steel shackle,
2 keys
specially for tool boxes
1000 + 1002

Cadenas

MS = laiton
avec anneau en acier trempé
et 2 clés
pour boîtes d'outillage
1000 + 1002

Candados

MS = latón
arco de acero templado,
con 2 llaves
para cajas de herramientas
1000 + 1002

Code	spez. für HEYCO spec. for HEYCO	 g		EAN	€
02199004045	1000 + 1002	170	1	113990	11,20



1101

Werkzeugschrank

L = lackiert
mit 1 Schublade und Halterungen
für Werkzeuge sowie Schale
für Steckschlüssel-Garnitur,
2-flügelige Tür mit Treibstangen,
Knopfgriff und Sicherheitschloß
aus Stahlblech

Wall cabinet

L = lacquered
with 1 drawer and mountings for
tools as well as tray for socket set,
2-winged door with locking bars,
knob handle and security lock,
sheet steel



Armoires murales d'outillage, vides

L = laquées
avec 1 tiroir et fixations pour outils
ainsi qu'un plateau pour composition
de douilles, porte à 2 battants avec serrure
à clé et blocage instantané par crémone
à accrochage central, en tôle d'acier

Armarios de herramientas

L = barnizado
con un cajón y ganchos de sujeción para
herramientas, así como una bandeja
para colocar un juego de llaves de vaso,
puerta de 2 hojas con cierre por varilla
y manilla de seguridad, de chapa de
acero



Code	Maße dimensions			EAN	€
01101010020	650 x 200 x 780 mm	21000	1	021769	auf Anfrage on request

1135

Werkzeugtruhe

L = lackiert
mit 4 Schubladen,
Arbeitsplatte aus Kunststoff,
Zentralverschluss durch
Zylinderschloß,
2 ausklappbare Haltegriffe

geeignet als Aufsatz für
Werkstattswagen HEYCO No. 1129
(Seite 144)

Tool chest

L = lacquered
with 4 drawers,
Plastic working top,
locking mechanism through
cylinder lock,
2 handles on side face

suitable as attachment for
workshop trolley HEYCO NO 1129
(page 144)

Coffres d'outillage, vides

L = laquées
avec 4 tiroirs,
Plan de travail en plastique,
Verrouillage central par serrure à cylindre,
2 poignées latérale



peuvent être utilisées comme fixation pour
servante d'atelier HEYCO N°1129
(page 144)

Cofres de herramientas

L = barnizado
con 4 bandejas,
placa de trabajo de plástico,
cierre central mediante cerradura
cilíndrica,
2 mangos abatibles laterales

adecuado como suplemento al carro de
herramientas HEYCO nr. 1129
(página 144)



Code	Maße dimensions			EAN	€
01135010020	600 x 440 x 450 mm	3100	1	022308	593,20





910 - 943

Werkzeugsortimente
in Kartonagen

Tool assortments
(in cardboard cartons only)

Sélections d'outillage en Carton

Conjuntos de herramientas
en cartones

Code	No.	tlg. pcs.				EAN	€
00910000282	910-M	89	127/128	8380	1	020762	678,20
00910000382	910-AF	89	127/128	9910	1	020779	774,30
00911000282	911-M	113	129/130	16900	1	020786	1.223,90
00911000382	911-AF	113	129/130	17480	1	020793	1.304,00
00933000282	933-M	110	131/132	25310	1	021028	1.688,80
00933000382	933-AF	108	131/132	26550	1	021035	1.783,15
00942000282	942-M	140	133/134	20140	1	021134	1.771,85
00942000382	942-AF	135	133/134	20200	1	021141	1.809,30
00943000282	943-M	165	135/136	30350	1	021158	2.399,70
00943000382	943-AF	156	135/136	33290	1	021165	2.592,75

1002-910 - 1140-943



Werkzeugsortimente in
Behältnissen

Tool assortments
(in receptacles)

Sélections d'outillage
avec contenants

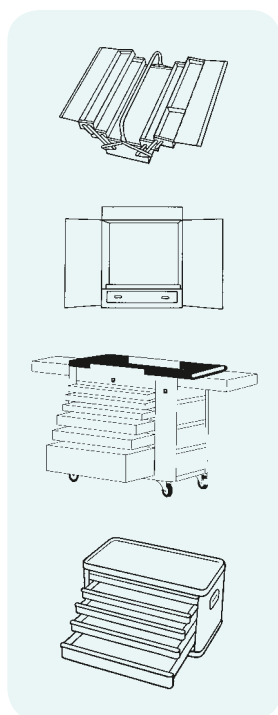
Conjuntos de herramientas en
contenedores



Code	No.	tlg. pcs.				EAN	€
in Kästen/in tool boxes							
01002910282	1002-910-M	90	127/128		1	021349	770,05
01002910382	1002-910-AF	90	127/128		1	021356	866,00
01000091482	1000-914-M	100	137		1	392777	1.179,75
01000091582	1000-915-M	100	138		1	392791	1.181,50
in Schränken/in wall cabinets							
01101911282	1101-911-M	114	129/130		1	021776	auf Anfrage
01101911382	1101-911-AF	114	129/130		1	021783	on request
in Werkstattwagen/in workshop trolleys							
01128933282	1128-933-M	111	131/132		1	142570	2.714,90
01128933382	1128-933-AF	109	131/132		1	142587	2.805,10
01128942282	1128-942-M	141	133/134		1	142648	2.793,75
01128942382	1128-942-AF	136	133/134		1	142631	2.831,05
01128943282	1128-943-M	166	135/136		1	346985	3.421,55
01128943382	1128-943-AF	157	135/136		1	346992	3.614,65
in Truhen/in tool chests							
01135933282	1135-933-M	111	131/132		1	022360	2.259,10
01135933382	1135-933-AF	109	131/132		1	022377	2.371,00

910

Kfz-Werkstatt
und Wartung

HEYCO-Werkzeugsortimente

Kundendienst-Sortiment

Motor mechanic
workshop and
maintenance

HEYCO-Tool assortments

Service assortment

Réparation et entretien
d'automobile

HEYCO-Sélection d'outillage

Sélection d'entretien

Reparación y mantenimiento
del automóvil

HEYCO Conjuntos de herramientas

Conjunto para mantenimiento



Code	No.	Stck. pcs.	g	Box	EAN	€
00910000282	910-M	89	8380	1	020762	678,20
00910000382	910-AF	89	9910	1	020779	774,30

Code	No.	Stck. pcs.	Behältnis receptacle	g	Box	EAN	€
01002910282	1002-910-M	90	1002-100	13820	1	021349	770,05
01002910382	1002-910-AF	90	1002-100	15350	1	021356	866,00

enthaltend / containing		★ = 910-M ☆ = 910-AF				
Stck. pcs.	Artikel article	No.	M	AF	Maße sizes	
8		350 CP	★	☆	MM 6 x 7 8 x 9 10 x 11 12 x 13 14 x 15 16 x 17 18 x 19 20 x 22 AF 1/4 x 5/16 3/8 x 7/16 1/2 x 9/16 5/8 x 11/16 3/4 x 25/32 13/16 x 7/8 15/16 x 1 1.1/16 x 1.1/4	
1 (11)		370 N	★	☆	MM 4 4,5 5 5,5 6 6,5 7 7,5 AF 3/16 7/32 1/4 9/32 5/16 11/32 3/8 7/16	
8		475 CP	★	☆	MM 6 x 7 8 x 9 10 x 11 12 x 13 14 x 15 16 x 17 18 x 19 20 x 22 AF 1/4 x 5/16 3/8 x 7/16 1/2 x 9/16 5/8 x 11/16 3/4 x 25/32 13/16 x 7/8 15/16 x 1 1.1/16 x 1.1/4	
18		50-12 CPP	★	☆	MM 12 13 14 15 16 17 18 19 20 21 22 23 24 26 27 28 30 32	
18			☆	★	AF 3/8 7/16 1/2 9/16 19/32 5/8 11/16 3/4 25/32 13/16 7/8 15/16 31/32 1 1.1/16 1.1/8 1.3/16 1.1/4	
1		50-00-1 CP	★	☆	270 mm	
1		50-03 CPP	★	☆	300 mm	
1		50-19-3 CP	★	☆	MM 16 AF 5/8	
1		50-05 CPP	★	☆	250 mm	
1		300 CP	★	☆	240 mm	
1		1200 CPD	★	☆	180 mm	
1		1208 CPD	★	☆	200 mm	
1		1212 CPD	★	☆	160 mm	
1 (8)		K 1340-8 B	★	☆	MM 2 2,5 3 4 5 6 8 10 AF 1/16 5/64 3/32 1/8 5/32 3/16 7/32 1/4	

910

Kfz-Werkstatt
und Wartung

Motor mechanic
workshop and
maintenance

Réparation et entretien
d'automobile

Reparación y mantenimiento
del automóvil



enthaltend / containing					★ = 910-M	☆ = 910-AF
Stück. pcs.	Artikel article	No.	M	AF	Maße sizes	
2		1411 C	★	☆	PH No. 1 2	
1		1435 C	★	☆	100 x 3 mm	
1		1445 C	★	☆	25 x 6,5 mm	
2		1437 C	★	☆	100 x 5,5 150 x 8	
1		1483 N	★	☆	125 x 5,5 mm	
1		1520 LS	★		300 g	
1		1522 AS		☆	3/4 lb.	
1		1555 LS	★	☆	150 x 18 mm	
1		1560 LS	★	☆	150 x 6 mm	
1		1570 LS	★	☆	120 x 3 mm	
1		1575 LS	★	☆	120 x 4 mm	
1		1675 ST + 1681-5 ST	★	☆	250 mm	
1		1679 ST + 1681-3 ST	★	☆	200 mm	
6		1686-1 B	★	☆	150 mm	
1 (6)		1689 B	★	☆	150 mm • ▲ ■ □	
1		1759 ST	★	☆	150 mm	
1		1814-2 P/N	★		13 Blatt/blades 0,05 – 1,0 mm	
		1814-12 P/N	☆		13 Blatt/blades .002 – .035"	

911

Kfz-Werkstatt und Wartung

Werkstattschrank

Der Werkzeugschrank HEYCO 1101 ist nur mit dem vorgegebenen Sortiment HEYCO 911 bestückbar.

Motor mechanic
workshop and
maintenance

Workshop wall cabinet

The workshop wall cabinet HEYCO 1101 can only be equipped with assortment HEYCO 911.

Réparation et entretien
d'automobile

Armoire murale

L'armoire murale HEYCO 1101 ne peut être équipée qu'avec la sélection HEYCO 911.

Reparación y mantenimiento
del automóvil



Armario de herramientas de taller

El armario HEYCO 1101 sólo se suministra con el conjunto HEYCO 911.













1101-911



Code	No.	Stck. pcs.	g	g	EAN	€
00911000282	911-M	113	16900	1	020786	1.223,90
00911000382	911-AF	113	17480	1	020793	1.304,00

Code	No.	Stck. pcs.	Behältnis receptacle	g	g	EAN	€
01101911282	1101-911-M	114	 1101	37900	1	021776	auf Anfrage on request
01101911382	1101-911-AF	114	 1101	38480	1	021783	auf Anfrage on request

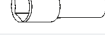

enthaltend / containing				★ = 911-M ☆ = 911-AF	
Stck. pcs.	Artikel article	No.	M	AF	Maße sizes
12		350 CP	★		MM 6 x 7 8 x 9 10 x 11 12 x 13 14 x 15 16 x 17 18 x 19 20 x 22 21 x 23 24 x 27 25 x 28 30 x 32 ☆ AF 1/4 x 5/16 3/8 x 7/16 1/2 x 9/16 19/32 x 11/16 5/8 x 11/16 5/8 x 3/4 3/4 x 25/32 13/16 x 7/8 7/8 x 15/16 15/16 x 1 1 x 1.1/8 1.1/16 x 1.1/4
1 (11)		370 N	★		MM 4 4,5 5 5,5 6 6,5 7 7,5 ☆ AF 3/16 7/32 1/4 9/32 5/16 11/32 3/8 7/16
12		475 CP	★		MM 6 x 7 8 x 9 10 x 11 12 x 13 14 x 15 16 x 17 18 x 19 20 x 22 21 x 23 24 x 27 25 x 28 30 x 32 ☆ AF 1/4 x 5/16 3/8 x 7/16 1/2 x 9/16 5/8 x 11/16 5/8 x 3/4 3/4 x 25/32 3/4 x 7/8 13/16 x 7/8 7/8 x 15/16 15/16 x 1 1 x 1.1/8 1.1/16 x 1.1/4
2		390 CP			160 mm 205 mm
18		50-12 CPP	★		MM 12 13 14 15 16 17 18 19 20 21 22 23 24 26 27 28 30 32 ☆ AF 3/8 7/16 1/2 9/16 19/32 5/8 11/16 3/4 25/32 13/16 15/16 31/32 1 1.1/16 1.1/8 1.3/16 1.1/4
1		50-00-1 CP	★	☆	270 mm
1		50-03 CPP	★	☆	300 mm
1		50-04 CPP	★	☆	125 mm
1		50-05 CPP	★	☆	250 mm
1		50-06 CPP	★	☆	80 mm
1		50-19-3 CP	★		MM 16 ☆ AF 5/8
1		600-10 CP	★	☆	MM/AF 17 x 13/16 x 19 x 22 mm

911

Kfz-Werkstatt
und Wartung

Werkstattschrank

Motor mechanic
workshop and
maintenance

Workshop wall cabinet

Réparation et entretien
d'automobile

Armoire murale

Reparación y mantenimiento
del automóvil

Armario de herramientas de taller



enthaltend / containing				★ = 911-M ☆ = 911-AF	
Stck. pcs.	Artikel article	No.	M	AF	Maße sizes
1		300 CP	★	☆	240 mm
1		320 CP	★	☆	200 mm
1		1200 CPD	★	☆	180 mm
1		1208 CPD	★	☆	200 mm
1		1212 CPD	★	☆	160 mm
1		1215 CPD	★	☆	160 mm
1		1280 N	★	☆	250 mm
1 (8)		K 1340-8 B	★	☆	MM 2 2,5 3 4 5 6 8 10 AF 1/16 5/64 3/32 1/8 5/32 3/16 7/32 1/4
3		1411 C	★	☆	PH No. 1 2 3
1		1435 C	★	☆	100 x 3 mm
1		1445 C	★	☆	25 x 6,5 mm
3		1437 C	★	☆	100 x 5,5 150 x 8 200 x 12 mm
1		1483 N	★	☆	125 x 5,5 mm
2		1500 C	★	☆	500 mm
1		1520 LS	★		300 g
1		1522 AS		☆	3/4 lb.
1		2165 ST	★	☆	∅ 32 mm
1		1555 LS	★	☆	150 x 18 mm
1		1560 LS	★	☆	150 x 6 mm
1		1570 LS	★	☆	120 x 3 mm
1		1575 LS	★	☆	120 x 4 mm
1		1675 ST + 1681-5 ST	★	☆	250 mm
1		1676 ST + 1681-5 ST	★	☆	250 mm
1		1677 ST + 1681-3 ST	★	☆	200 mm
1		1679 ST + 1681-3 ST	★	☆	200 mm
6		1686-1 B	★	☆	150 mm
1 (6)		1689 B	★	☆	150 mm ● ▲ ■ □
1		1759 ST	★	☆	150 mm
1		1782-2 ST	★	☆	250 ccm
1		1814-2 P/N	★		13 Blatt/blades 0,05 – 1,0 mm
		1814-12 P/N	☆		13 Blatt/blades .002 – .035"

933

Baustelle, LKW,
Landmaschinen

LKW-Reparatur + Wartung

Trucks, building and
agricultural equipment

Truck repair and maintenance

Engins de chantier, camions,
machines agricoles

Sélection pour réparation et entretien de
camions

Maquinaria de construcción,
camiones, maquinaria agrícola

Conjunto para reparación
mantenimiento de camiones



Code	No.	Stck. pcs.	g	g	EAN	€
00933000282	933-M	110	25310	1	021028	1.688,80
00933000382	933-AF	108	26550	1	021035	1.783,15

Code	No.	Stck. pcs.	Behältnis receptacle	g	g	EAN	€
01128933282	1128-933-M	111		80300	1	142570	2.714,90
01128933382	1128-933-AF	109		81550	1	142587	2.805,10
			1128				
01135933282	1135-933-M	111		46310	1	022360	2.259,10
01135933382	1135-933-AF	109		47550	1	022377	2.371,00
			1135				

enthaltend / containing

★ = 933-M ☆ = 933-AF

Stck. pcs.	Artikel article	No.	M	AF	Maße sizes
7		350 CP	★	☆	MM 6 x 7 8 x 9 10 x 11 12 x 13 14 x 15 16 x 17 18 x 19 AF 1/4 x 5/16 3/8 x 7/16 1/2 x 9/16 5/8 x 11/16 3/4 x 25/32 13/16 x 7/8 15/16 x 1
10		400 CP	★	☆	MM 8 9 10 11 12 13 14 17 19 22 AF 5/16 3/8 7/16 1/2 9/16 5/8 11/16 3/4 13/16 7/8
11		475 CP	★	☆	MM 6 x 7 8 x 9 10 x 11 12 x 13 14 x 15 16 x 17 18 x 19 21 x 23 22 x 24 25 x 28 27x30 mm AF 1/4 x 5/16 3/8 x 7/16 1/2 x 9/16 5/8 x 11/16 5/8 x 3/4 3/4 x 25/32 3/4 x 7/8 13/16 x 7/8 7/8 x 15/16 15/16 x 1 1 x 1.1/8
18		50-12 CPP	★	☆	MM 8 9 10 11 12 13 14 15 16 17 18 19 21 22 23 24 26 27
16			★	☆	AF 3/8 7/16 1/2 9/16 19/32 5/8 11/16 3/4 25/32 13/16 7/8 15/16 1 1.1/16 1.1/8 1.1/4
1		50-00-7 CP	★	☆	270 mm
1		50-03 CPP	★	☆	300 mm
1		50-04 CPP	★	☆	125 mm
1		50-05 CPP	★	☆	250 mm
1		50-06 CPP	★	☆	80 mm
9		100-12 C	★	☆	MM 30 32 33 36 38 41 46 50 55 AF 1.1/4 1.5/16 1.7/16 1.1/2 1.5/8 1.11/16 1.3/4 1.7/8 2
1		100-00-5 C	★	☆	165 mm
1		100-03-5 C	★	☆	59 mm

933

Baustelle, LKW,
Landmaschinen

LKW-Reparatur + Wartung

Trucks, building and
agricultural equipment

Truck repair and maintenance

Engins de chantier, camions,
machines agricoles

Sélection pour réparation et entretien de
camions

Maquinaria de construcción,
camiones, maquinaria agrícola

Conjunto para reparación
mantenimiento de camiones



enthaltend / containing		★ = 933-M ☆ = 933-AF			
Stck. pcs.	Artikel article	No.	M	AF	Maße sizes
1		100-03-6 C	★	☆	470 mm
1		100-04 C	★	☆	200 mm
1		315 CP	★	☆	240 mm
1		50-19-3 CP	★	☆	MM 16 AF 5/8
1		1200 CPD	★	☆	180 mm
1		1208 CPD	★	☆	200 mm
1		1212 CPD	★	☆	160 mm
1		1231 N	★	☆	340 mm
1		1250 CPD	★	☆	175 mm
1		1255 CPD	★	☆	180 mm
1		1280 N	★	☆	250 mm
1		1327 C	★	☆	für/for Ø bis/up to 240 mm 280 mm
9		1340 B	★	☆	MM 6 7 8 9 10 12 14 17 19 AF 1/4 9/32 5/16 3/8 7/16 1/2 9/16 5/8 3/4
3		1411 C	★	☆	PH No. 1 2 3
1		1419 MS	★	☆	6 – 24 V
1		1436 CI	★	☆	75 x 3 mm
3		1437 C	★	☆	100 x 5,5 150 x 8 200 x 12 mm
2		1500 C	★	☆	500 mm
2		1520 LS	★	☆	300 g 1000 g
2		1522 AS	★	☆	3/4 lb. 2 lbs.
1		2165 ST	★	☆	Ø 35 mm
2		1555 LS	★	☆	125 x 16 200 x 25 mm
3		1565 LS	★	☆	150 x 4 150 x 6 150 x 8 mm
1		1575 LS	★	☆	150 x 5 mm
1		1610 C/CL	★	☆	450 mm
1		1662 LS	★	☆	200 mm
1		1675 ST + 1681-5	★	☆	250 mm
1		1679 ST + 1681-3	★	☆	200 mm
1		1755 ST	★	☆	295 mm – 4 Reihen/rows
1		1782-2 ST	★	☆	250 ccm
1		1814-3 P/N 1814-12 P/N	★	☆	18 Blatt/blades 0,05 – 1,0 mm 13 Blatt/blades .002 – .035"
1		1920 ST	★	☆	10 m

942

Mechanik, Industrie und Wartung

Großes Mechanik-Sortiment

Mechanics, industry and
maintenance

Comprehensive mechanics' set

Mécanique, industrie et
entretien

Sélection complète pour mécanicien

Taller mecánico, industria y
mantenimiento

Conjunto grande para taller mecánico



Code	No.	Stck. / pcs.	g		EAN	€
00942000282	942-M	140	20140	1	021134	1.771,85
00942000382	942-AF	135	20200	1	021141	1.809,30

Code	No.	Stck. pcs.	Behältnis receptacle	g		EAN	€
01128942282	1128-942-M	141		75150	1	142648	2.793,75
01128942382	1128-942-AF	136		75200	1	142631	2.831,05
			1128				

enthaltend / containing		★ = 942-M ☆ = 942-AF		Maße sizes	
Stck. pcs.	Artikel article	No.	M	AF	
12		350 CP	★	☆	MM 6 x 7 8 x 9 10 x 11 12 x 13 14 x 15 16 x 17 18 x 19 20 x 22 21 x 23 24 x 27 25 x 28 30 x 32 AF 1/4 x 5/16 3/8 x 7/16 1/2 x 9/16 19/32 x 11/16 5/8 x 11/16 5/8 x 3/4 3/4 x 25/32 13/16 x 7/8 7/8 x 15/16 15/16 x 1 1 x 1.1/8 1.1/16 x 1.1/4
12		475 CP	★	☆	MM 6 x 7 8 x 9 10 x 11 12 x 13 14 x 15 16 x 17 18 x 19 20 x 22 21 x 23 24 x 27 25 x 28 30 x 32 AF 1/4 x 5/16 3/8 x 7/16 1/2 x 9/16 5/8 x 11/16 5/8 x 3/4 3/4 x 25/32 3/4 x 7/8 13/16 x 7/8 7/8 x 15/16 15/16 x 1 1 x 1.1/8 1.1/16 x 1.1/4
1		390 CP	★	☆	205 mm
1		27-3010-M CPP			1/4" □ Steckschlüssel-Garnitur / Socket set
(17)		27-4010-AF CPP			MM 4-13
23		50-12 CPP	★		MM 8 9 10 11 12 13 14 15 16 17 18 19 20 21 22 23 24 26 27 28 29 30 32
18			☆		AF 3/8 7/16 1/2 9/16 19/32 5/8 11/16 3/4 25/32 13/16 7/8 15/16 31/32 1 1.1/16 1.1/8 1.3/16 1.1/4
1		50-00-7 CP	★	☆	270 mm
1		50-02 CPP	★	☆	405 mm
1		50-03 CPP	★	☆	300 mm
1		50-04 CPP	★	☆	125 mm
1		50-05 CPP	★	☆	250 mm
1		50-06 CPP	★	☆	80 mm
1		50-08 CPP	★	☆	375 mm
1		50-19-1 CP	★		MM 20,8
			☆		AF 13/16
1		300 CPI	★	☆	240 mm
1		1200 CPI	★	☆	180 mm
1		1206 CPI	★	☆	160 mm
1		1207 CPI	★	☆	160 mm
1		1212 CPI	★	☆	160 mm
1		1280 N	★	☆	250 mm
1		1250 CPD	★	☆	175 mm



enthaltend / containing		★ = 942-M ☆ = 942AF			
Stck. pcs.	Artikel article	No.	M	AF	Maße sizes
1		1255 CPD	★	☆	180 mm
1 (8)		K 1340-8 B	★	☆	MM 2 2,5 3 4 5 6 8 10 AF 1/16 5/64 3/32 1/8 5/32 3/16 7/32 1/4
2		1411 C	★	☆	PH No. 1 2
2		1412 C	★	☆	PZ No. 1 2
3		1436 CI	★	☆	75 x 3 100 x 3 125 x 4 mm
4		1437 C	★	☆	100 x 5,5 125 x 6,5 150 x 8 200 x 12 mm
1 (5)		1491 ST	★	☆	M 3 – 18 1/8 – 3/4"
1		1494-2 CPP	★	☆	1800 g
1		1520 LS	★		300 g
1		1522 AS		☆	1/2 lb.
1		2165 ST	★	☆	∅ 32 mm
2		1555 LS	★	☆	150 x 18 200 x 25 mm
4		1565 LS	★	☆	150 x 2 150 x 4 150 x 6 150 x 8 mm
3		1570 LS	★	☆	120 x 4 120 x 6 120 x 8 mm
1		1575 LS	★	☆	120 x 4 mm
1		1610 C/CL	★	☆	450 mm
1		1656 Z	★	☆	145 mm
1		1668 ST	★	☆	90/200 mm
1		1670 ZCG	★	☆	M 5 – 27 5/16 – 1.1/2" UNF (NF)
1		1675 ST + 1681-5	★	☆	250 mm
1		1676 ST + 1681-5 ST	★	☆	250 mm
1		1677 ST + 1681-3 ST	★	☆	200 mm
1		1678 ST + 1681-3	★	☆	200 mm
1		1679 ST + 1681-3	★	☆	200 mm
2		1686-1 B	★	☆	150 mm
1		1754 ST	★	☆	260 mm
1		1755 ST	★	☆	290 mm – 3 Reihen/rows
1		1782-2 ST	★	☆	125 ccm
1		1806 C	★	☆	140 mm / 5.1/2"
1		1814-3 P/N 1814-12 P/N	★	☆	18 Blatt/blades 0,05 – 1,0 mm 13 Blatt/blades .002 – .035"
1		1836 ST	★	☆	300 mm / 12"
1		1839-2 ST	★	☆	3 m / 118"
1		1920 ST	★	☆	10 m
1		HEYNEN No.103	★	☆	400 mm

943

Mechanik, Industrie und Wartung

Industrie + Wartung

Mechanics, industry and maintenance

Industry and maintenance

Mécanique, industrie et entretien

Sélection pour industrie et entretien

Taller mecánico, industria y mantenimiento

Conjunto para industria y
mantenimiento



Code	No.	Stck. pcs.	g		EAN	€
00943000282	943-M	165	30350	1	021158	2.399,70
00943000382	943-AF	156	33290	1	021165	2.592,75

Code	No.	Stck. pcs.	Behältnis receptacle	g		EAN	€
01128943282	1128-943-M	166		85827	1	346985	3.421,55
01128943382	1128-943-AF	157		88688	1	346992	3.614,65
			1128				

enthaltend / containing		★ = 943-M ☆ = 943-AF		
Stck. pcs.	Artikel article	No.	M AF	Maße sizes
7		350 CP	★	MM 6 x 7 8 x 9 10 x 11 12 x 13 14 x 15 16 x 17 18 x 19 ☆ AF 1/4 x 5/16 3/8 x 7/16 1/2 x 9/16 5/8 x 11/16 3/4 x 25/32 13/16 x 7/8 15/16 x 1
24		400 CP	★	MM 6 7 8 9 10 11 12 13 14 15 16 17 18 19 21 22 23 24 26 27 28 29 30 32 ☆ AF 1/4 5/16 3/8 7/16 1/2 9/16 5/8 11/16 3/4 13/16 7/8 15/16 1 1.1/16 1.1/8 1.1/4 1.5/16 1.3/8 1.1/2 1.5/8
20		475 CP	★	MM 6 x 7 8 x 9 10 x 11 12 x 13 14 x 15 16 x 17 18 x 19 ☆ AF 1/4 x 5/16 3/8 x 7/16 1/2 x 9/16 5/8 x 11/16 3/4 x 25/32 13/16 x 7/8 15/16 x 1
7		390 CP	★ ☆	205 mm
1		27-3010-M CPP		1/4" □ Steckschlüssel-Garnitur/ Socket set MM 4-13
1		27-4010-AF CPP		1/4" □ Steckschlüssel-Garnitur/ Socket set AF 1/8-9/16
17				
23		50-12 CPP	★	MM 8 9 10 11 12 13 14 15 16 17 18 19 20 21 22 23 24 26 27 28 29 30 32 ☆ AF 3/8 7/16 1/2 9/16 19/32 5/8 11/16 3/4 25/32 13/16 7/8 15/16 31/32 1 1.1/16 1.1/8 1.3/16 1.1/4
18			★ ☆	
1		50-19-1 CP	★ ☆	MM 20,8 AF 13/16
1		50-00-7 CP	★ ☆	270 mm
1		50-02 CPP	★ ☆	405 mm
1		50-03 CPP	★ ☆	300 mm
1		50-04 CPP	★ ☆	125 mm
1		50-05 CPP	★ ☆	250 mm
1		50-06 CPP	★ ☆	80 mm
1		50-08 CPP	★ ☆	375 mm
11		100-12 C	★	MM 27 29 30 32 33 36 38 41 46 50 55 ☆ AF 1.1/16 1.1/8 1.1/4 1.5/16 1.7/16 1.1/2 1.5/8 1.11/16 1.3/4 1.7/8 2
1		100-00-5 C	★ ☆	165 mm
1		100-03-5 C	★ ☆	59 mm

943

Mechanik, Industrie und
Wartung

Mechanics, industry and
maintenance

Mécanique, industrie et
entretien

Taller mecánico, industria y
mantenimiento



enthaltend / containing			★ = 943-M ☆ = 943-AF		
Stück. pcs.	Artikel article	No.	M	AF	Maße sizes
1		100-03-6 C	★	☆	470 mm
1		100-04 C	★	☆	200 mm
1		100-05 C	★	☆	400 mm
1		100-06 C	★	☆	110 mm
1		300 CPI	★	☆	240 mm
1		1200 CPI	★	☆	180 mm
1		1206 CPI	★	☆	160 mm
1		1207 CPI	★	☆	160 mm
1		1212 CPI	★	☆	160 mm
1		1280 N	★	☆	250 mm
1		K 1340-8 B	★		MM 2 2,5 3 4 5 6 8 10
(8)				☆	AF 1/16 5/64 3/32 1/8 5/32 3/16 7/32 1/4
4		1411 C	★	☆	PH No. 1 2 3 4
2		1412 C	★	☆	PZ No. 1 2
2		1436 CI	★	☆	75 x 3 125 x 4 mm
3		1437 C	★	☆	100 x 5,5 150 x 8 200 x 12 mm
1		1491 ST	★		M 3 – 18
(5)				☆	1/8 – 3/4"
1		1494-2 CPP	★	☆	1800 g
2		1520 LS	★		300 g 800 g
2		1522 AS		☆	1/2 lb. 1.1/2 lbs.
1		2165 ST	★	☆	∅ 32 mm
1		1555 LS	★	☆	200 x 25 mm
1		1560 LS	★	☆	200 x 8 mm
4		1565 LS	★	☆	150 x 2 150 x 4 150 x 6 150 x 8 mm
1		1575 LS	★	☆	150 x 5 mm
1		1610 C/CL	★	☆	450 mm
1		1656 Z	★	☆	145 mm
1		1668 ST	★	☆	90/200 mm
1		1670 ZCG	★		M 5 – 27
				☆	5/16 – 1.1/2" UNF (NF)
1		1675 ST + 1681-5	★	☆	250 mm
1		1676 ST + 1681-5 ST	★	☆	250 mm
1		1677 ST + 1681-3 ST	★	☆	200 mm
1		1679 ST + 1681-3	★	☆	200 mm
2		1686-1 B	★	☆	150 mm
1		1754 ST	★	☆	260 mm
1		1755 ST	★	☆	290 mm – 3 Reihen/rows
1		1782-2 ST	★	☆	250 ccm
1		1806 C	★	☆	140 mm / 5.1/2"
1		1814-3 P/N 1814-12 P/N	★		18 Blatt/blades 0,05 – 1,0 mm
				☆	13 Blatt/blades .002 – .035"
1		1836 ST	★	☆	300 mm / 12"
1		1839-2 ST	★	☆	3 m / 118"
1		1842 B	★	☆	250 mm
1		1920 ST	★	☆	10 m

1000-914-M

Werkzeugsortiment im Werkzeugkasten

100-teilig
Kfz Werkstatt und Wartung

Mechanic' tool set

100 pcs.
Workshop and maintenance

Assortiment d'outils -
boîte à outils

100 pièces
Atelier et entretien

Surtido de herramientas
en caja

100 pzas
Talleres y mantenimiento de automoción



Code	No.	tlg. pcs.	Behälter receptacle	g	Box	EAN	€
01000091482	1000-914-M	100		14000	1	392777	1.179,75

enthaltend / containing

Stck. pcs.	Artikel article	No.	Maße sizes
12		350 CP	MM 6 x 7 8 x 9 10 x 11 12 x 13 14 x 15 16 x 17 18 x 19 20 x 22 21 x 23 24 x 26 25 x 28 27 x 32
12		475 CP	MM 6 x 7 8 x 9 10 x 11 12 x 13 14 x 15 16 x 17 18 x 19 20 x 22 21 x 23 24 x 26 25 x 28 27 x 32
1		390 CP	8" / 205 mm
1 (11)		370 N	MM 4 4,5 5 5,5 6 6,5 7 7,5
1		1500 C	500 mm
1		1555 LS	200 x 25 mm
1		1560 LS	150 x 6 mm
1		1570 LS	120 / 2 mm
1		1575-4 LS	120 / 4 mm
1		1280 N	250 mm
1		50-19-1	20,8 mm
1		1445 C	25 x 4 mm
1		1430 C	150 x 8 mm 200 x 10 mm
3		1411 C	No. 01 / 1 / 2 "Phillips"
22		50-12 CPP	1/2" 10 11 12 13 14 15 16 17 18 19 20 21 22 23 24 25 26 27 28 29 30 32
1		50-02 CPP	1/2" 405 mm
1		50-08 CPP	1/2" 385 mm
1		50-03 CPP	1/2" 300 mm
1		50-00-10 CPP	1/2" 275 mm
1		50-04 CPP	1/2" 125 mm
1		50-05 CPP	1/2" 250 mm
1		50-06 CPP	1/2"
1		1213 CPT	160 mm
1		1200 CPT	180 mm
1		2165 ST	Ø 35 mm
1 (8)		K 1340-8 B	MM 2 2,5 3 4 5 6 8 10
1		1675 ST	200 mm
1		1679 ST	200 mm
1		1677 ST	200 mm
1		1686-1-8	150 mm
1		1755 ST	4 Reihen/rows
1		1520 LS	500 gr.
1		1814-2 P/N	13 Blatt/blades 0,05 – 1,0 mm
1		1840 ST	5 m
1		1782-2 ST	250 ccm
1		2199 ST	40 mm
1		1610 ST	verstellbar/adjustable
1		300 CP	240 mm

1000-915-M

Werkzeugsortiment im
Werkzeugkasten

100-teilig
Kfz Werkstatt und Wartung

Mechanic' tool set

100 pcs.
Workshop and maintenance

Assortiment d'outils -
boîte à outils

100 pièces
Atelier et entretien

Juego de herramientas en caja

100 pzas
Talleres y mantenimiento de automoción



Code	No.	tlg. pcs.	Behältnis receptacle	g		EAN	€
01000091582	1000-915-M	100		14000	1	392791	1.181,50

enthaltend / containing

Stück. pcs.	Artikel article	No.	Maße sizes
24		400 CP	MM 6 7 8 9 10 11 12 13 14 15 16 17 18 19 20 21 22 23 24 25 26 27 28 32
1		390 CP	8" / 205 mm
1 (11)		370 N	MM 4 4,5 5 5,5 6 6,5 7 7,5
1		1500 C	500 mm
1		1555 LS	200 x 25 mm
1		1560 LS	150 x 6 mm
1		1570 LS	120 / 2 mm
1		1575-4 LS	120 / 4 mm
1		1280 N	250 mm
1		50-19-1	20,8 mm
1		1445 C	25 x 4 mm
1		1430 C	150 x 8 mm 200 x 10 mm
3		1411 C	No. 01 / 1 / 2 "Phillips"
22		50-12 CPP	1/2" 10 11 12 13 14 15 16 17 18 19 20 21 22 23 24 25 26 27 28 29 30 32
1		50-02 CPP	1/2" 405 mm
1		50-08 CPP	1/2" 385 mm
1		50-03 CPP	1/2" 300 mm
1		50-00-10 CPP	1/2" 275 mm
1		50-04 CPP	1/2" 125 mm
1		50-05 CPP	1/2" 250 mm
1		50-06 CPP	1/2"
1		1213 CPT	160 mm
1		1200 CPT	180 mm
1		2165 ST	Ø 35 mm
1 (8)		K 1340-8 B	MM 2 2,5 3 4 5 6 8 10
1		1675 ST	200 mm
1		1679 ST	200 mm
1		1677 ST	200 mm
1		1686-1-8	150 mm
1		1755 ST	4 Reihen/rows
1		1520 LS	500 gr.
1		1814-2 P/N	13 Blatt/blades 0,05 – 1,0 mm
1		1840 ST	5 m
1		1782-2 ST	250 ccm
1		2199 ST	40 mm
1		1610 ST	verstellbar/adjustable
1		300 CP	240 mm



Die Synthese aus Raum, Sicherheit und Ergonomie.

Der weltweit erste Werkstattwagen mit automatischem Softeinzug und Sicherheits-Zwei-Rad-Bremssystem mit Start/Stop Automatik.

Abmessungen: ca. 1170 x 1020 x 660 mm aus Stahlblech, Korpus schwarz - Schubladen schwarz
Ablagefläche aus Holz. Maße: ca. 900 x 520 x 30 mm
getrennte Verriegelungen der Front- und Seitenschubfächer durch zwei Zylinderschlösser

- | | | | |
|----------------|------------------------|----------------|------------------------|
| 11 Schubladen | | | |
| ❶ 6 Schubladen | ca. 565 x 415 x 50 mm | ❸ 1 Schubfach | ca. 440 x 150 x 420 mm |
| ❷ 1 Schubfach | ca. 565 x 415 x 110 mm | ❹ 1 Schubfach | ca. 540 x 360 x 50 mm |
| ❸ 1 Schubfach | ca. 565 x 415 x 170 mm | ❺ 1 Ablagefach | ca. 700 x 390 x 65 mm |
| ❹ 1 Schubfach | ca. 440 x 150 x 255 mm | | |

2 Lenkrollen, 2 Festrollen, Tragfähigkeit max. 600 kg,
ca. 30 kg Belastbarkeit pro Schubfach, Leergewicht ca. 110 kg

The synthesis of space, security and ergonomics.

The world-wide first workshop trolley with automatic drawers soft close and security-2-wheels braking system with automatic start/stop mechanism.

Dimensions: approx. 1170 x 1020 x 660 mm from sheet steel, body black - drawers black
Working top of wood. Dimensions: approx. 900 x 520 x 30 mm
separate locking mechanism for front- and side drawers with two cylinder locks

- | | | | |
|-------------|----------------------------|----------------------------|----------------------------|
| 11 drawers | | | |
| ❶ 6 drawers | approx. 565 x 415 x 50 mm | ❸ 1 drawer | approx. 440 x 150 x 420 mm |
| ❷ 1 drawer | approx. 565 x 415 x 110 mm | ❹ 1 drawer | approx. 540 x 360 x 50 mm |
| ❸ 1 drawer | approx. 565 x 415 x 170 mm | ❺ 1 additional compartment | approx. 700 x 390 x 65 mm |
| ❹ 1 drawer | approx. 440 x 150 x 255 mm | | |

2 steering rollers, 2 castors, total carrying capacity max. 600 kg,
approx. 30 kg loading capacity for each drawer, weight empty approx. 110 kg

La synthèse de l'espace, de sécurité et d'ergonomie.

Première servante d'atelier avec fermeture automatique et système de freinage sécurité à deux roues et démarrage/arrêt automatique.

Dimensions: environ 1170 x 1020 x 660 mm en tôle d'acier, corps noir - tiroirs noir
Tablette en bois. Taille: environ 900 x 520 x 30 mm
verrous séparés sur les tiroirs frontaux et latéraux par deux serrures cylindriques

- | | | | |
|-------------|-------------------------|--------------|-------------------------|
| 11 tiroirs | | | |
| ❶ 6 tiroirs | env. 565 x 415 x 50 mm | ❸ 1 tiroir | env. 440 x 150 x 420 mm |
| ❷ 1 tiroir | env. 565 x 415 x 110 mm | ❹ 1 tiroir | env. 540 x 360 x 50 mm |
| ❸ 1 tiroir | env. 565 x 415 x 170 mm | ❺ 1 tablette | env. 700 x 390 x 65 mm |
| ❹ 1 tiroir | env. 440 x 150 x 255 mm | | |

2 roues pivotantes, 2 fixes, capacité de charge de 600 kg maxi,
capacité de charge par tiroir est de 30 kg, poids vide env. 110 kg

La síntesis de espacio, seguridad y ergonomía.

El primer carro de taller a nivel mundial con cierre amortiguado de los cajones y sistema de frenos de seguridad en 2 ruedas con automatismo Start/Stop.

Medidas aprox. 1170 x 1020 x 660 mm de chapa de acero, cuerpo y cajones de color negro
Tabla de trabajo de madera, medidas aprox. 900 x 520 x 30 mm
cerraduras separadas para los cajones frontales y laterales

- | | | | |
|-------------|------------------------------|-------------|------------------------------|
| 11 cajones | | | |
| ❶ 6 cajones | de aprox. 565 x 415 x 50 mm | ❸ 1 cajón | de aprox. 440 x 150 x 420 mm |
| ❷ 1 cajón | de aprox. 565 x 415 x 110 mm | ❹ 1 cajón | de aprox. 540 x 360 x 50 mm |
| ❸ 1 cajón | de aprox. 565 x 415 x 170 mm | ❺ 1 bandeja | de aprox. 700 x 390 x 65 mm |
| ❹ 1 cajón | de aprox. 440 x 150 x 255 mm | | |

2 ruedas giratorias, 2 ruedas fijas, 600 kg de carga total máxima,
carga admisible por cajón aprox. 30 kg, peso en vacío aprox. 110 kg

Abbildung kann von der Serie abweichen - Serienänderungen vorbehalten!

Photos peuvent varier - sous réserve de changement de série.

Illustration can differ from series, which is subject to change without prior notice!

La foto puede diferir del producto en serie. Nos reservamos el derecho de modificar el producto en serie.





- A+E** Kugelgelagerte Teleskopschienen voll ausziehbar und belastbar mit gedämpftem Softeinzug.
- B** Optimale Raumaussnutzung durch senkrecht angeordnete Schubladen für Verbrauchsmaterial und Werkzeuge. Ideal für Dosen und Flaschen.
- C** Alufelgen mit Niederquerschnittreifen und Sicherheits-Zwei-Rad-Bremssystem. Die automatische Betätigung garantiert einen sicheren Stand auch bei unebenen Bodenverhältnissen.
- D** Griffleiste aus hochwertigem Luftfahrtaluminium.
- C+G** Stabiler Griff mit integrierter **Start/Stop** Automatik zum einfachen Lösen der Feststellbremse. Beim Loslassen des Griffes wird die Feststellbremse automatisch betätigt.
- H** Zwei separat abschließbare Staufächer, zur sicheren Aufbewahrung von hochwertigen Meß- und Prüfgeräten.

- A+E** Telescopic slides with ball bearings fully extendable, with high load capacity and damped soft close mechanism.
- B** Optimal utilization of space by vertically arranged drawers for consumables and tools. Ideal for cans and bottles.
- C** Alloy wheels with low profile tyres and safety 2-wheels braking system. The automatic operation ensure a safe stand, also on uneven ground conditions.
- D** Handle made of aeronautical aluminium.
- C+G** Stable handle with integrated **Start/Stop** automatic for easy release of the brake. When releasing the handle the brake is automatically actuated.
- H** Two separately lockable storage compartments, for safe storage of high value testing equipment.

- A+E** Glissières à boule télescopiques robustes avec soft close amortie.
- B** Utilisation optimale de l'espace à l'aide de tiroirs verticaux pour la fourniture des outils. Idéal pour canettes et bouteilles.
- C** Jantes en alliage avec pneus à profil bas, système de freinage sur deux roues. Le fonctionnement automatique assure une position stable même sur un sol inégal.
- D** Poignée en aluminium de qualité aéronautique.
- C+G** Poignée robuste intégrant **marche/arrêt** automatique pour un démouillage facile du frein de stationnement. Après avoir relâché le frein de stationnement est automatiquement activé.
- H** Deux compartiments de rangement séparés fermant à clé pour stockage sûr des mesures de haute.

- A+E** Guías telescópicas con rodamientos de bolas, de extracción total, resistentes con cierre amortiguado.
- B** Aprovechamiento óptimo gracias a cajones verticales para material auxiliar y herramientas. Idóneo para botes y botellas.
- C** Llantas de aluminio con neumáticos de bajo perfil y sistema de frenos de seguridad a dos ruedas. El accionamiento automático garantiza un apoyo firme incluso en suelos desiguales.
- D** Listón de aluminio aeronáutico.
- C+G** Asa robusta con automatismo **Start/Stop** integrado para soltar el freno. Al soltar el asa, el freno se acciona automáticamente.
- H** 2 cajones con cerradura para almacenar instrumentos de valor.



1127-1

Werkstattwagen „INTELLIGENT TOOLS“, leer

- Automatisches Bremssystem
- Automatischer Softeinzug der Schubladen
- Hochwertige Arbeitsplatte aus Holz

Workshop trolley „INTELLIGENT TOOLS“, empty

- Automatic braking system
- Automatic drawers soft close
- High-quality wooden worktop

Servante d'atelier „INTELLIGENT TOOLS“, vides

- Autofreinage
- Fermeture automatique des tiroirs
- Plan de travail en bois de qualité

Carros de taller „INTELLIGENT TOOLS“, vacío

- Sistema de frenado automático
- Cierre automático amortiguado de los cajones
- Tabla de trabajo de madera de alta calidad

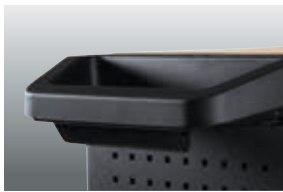

Code	Maße dimensions			EAN	€
01127010020	1170 x 1020 x 660 mm	110000	1	373004	2.150,00

1127-2

Werkstattwagen „PROFESSIONAL“, leer

- 2 Lenkrollen mit Feststellbremse
- Automatischer Softeinzug der Schubladen
- Hochwertige Arbeitsplatte aus Holz

Workshop trolley „PROFESSIONAL“, empty

- 2 steering rollers with parking brake
- Automatic drawers soft close
- High-quality wooden worktop

Servante d'atelier „PROFESSIONAL“, vides

- 2 roues pivotantes à frein
- Fermeture automatique des tiroirs
- Plan de travail en bois de qualité

Carros de taller „PROFESSIONAL“, vacío

- 2 ruedas giratorias con freno
- Cierre automático amortiguado de los cajones
- Tabla de trabajo de madera de alta calidad



Code	Maße dimensions			EAN	€
01127020020	1170 x 1020 x 660 mm	105000	1	375893	1.750,00



1127-3

Werkstattwagen „BASIC“, leer

- 2 Lenkrollen mit Feststellbremse
- Mit ABS-Arbeitsplatte

Workshop trolley „BASIC“, empty

- 2 steering rollers with parking brake
- With ABS worktop

Servante d'atelier „BASIC“, vides

- 2 roues pivotantes à frein
- Avec plan de travail ABS

Carros de taller „BASIC“, vacío

- 2 ruedas giratorias con freno
- Tabla de trabajo de plástico ABS



Code	Maße dimensions	g	g	EAN	€
01127030020	1170 x 1020 x 660 mm	98000	1	375886	1.545,00



1128

Werkstattwagen, leer

- 2 Lenkrollen mit 2 Feststellbremsen
- Mit ABS-Arbeitsplatte

Workshop trolley, empty

- 2 steering rollers with 2 castors
- With ABS worktop

Servantes d'outillage, vides

- 2 roues pivotantes avec 2 freins de stationnement
- Plan de travail en ABS

Carros de taller, vacío

- 2 ruedas articuladas con 2 frenos
- Con placa de ABS

HEYCO
FORMEL plus



Code	Maße dimensions	g	g	EAN	€
01128010020	886 x 511 x 850 mm	57000	1	129373	985,00





HEYCO



FORMEL plus



Werkstattwagen

Verbessertes Modell

Abmessungen: ca. 886 x 511 x 850 mm aus Stahlblech
Korpus grau - Schubladen schwarz, Verriegelung durch Zylinderschloss mit ABS-Arbeitsplatte

- 7 Schubladen
- ❶ 3 Schubladen ca. 565 x 415 x 54 mm
- ❷ 2 Schubfächer ca. 565 x 415 x 72 mm
- ❸ 1 Schubfach ca. 565 x 415 x 176 mm
- ❹ 1 Schubfach ca. 310 x 435 x 75 mm

2 Lenkrollen, 2 Feststellrollen, ca. 30 kg Belastbarkeit pro Schubfach, Leergewicht ca. 55 kg

Workshop trolley

Modified model

Dimensions: approx. 886 x 511 x 850 mm from sheet steel
Body grey - drawers black, locking by cylinder lock with ABS work top

- 7 drawers
- ❶ 3 drawers approx. 565 x 415 x 54 mm
- ❷ 2 drawers approx. 565 x 415 x 72 mm
- ❸ 1 drawer approx. 565 x 415 x 176 mm
- ❹ 1 drawer approx. 310 x 435 x 75 mm

2 steering rollers, 2 castors, approx. 30 kg loading capacity for each drawer, weight empty approx. 55 kg



Servante d'outillage

Modèle modifié

Dimensions: environ 886 x 511 x 850 mm en tôle d'acier
Corps gris - tiroirs noir-verrouillage par serrure à cylindre - plan de travail en ABS

- 7 tiroirs
- ❶ 3 tiroirs env. 565 x 415 x 54 mm
- ❷ 2 tiroirs env. 565 x 415 x 72 mm
- ❸ 1 tiroir env. 565 x 415 x 176 mm
- ❹ 1 tiroir env. 310 x 435 x 75 mm

2 rouleaux de guidage, 2 roulettes, approx. 30 kg capacité de charge pour chaque tiroir, poids vide approx. 55 kg

Carro de herramientas

Modelo mejorado

Dimensiones: aprox. 886 x 511 x 850 mm de chapa de acero
Cuerpo de color gris, cajones de color negro, con cierre

- 7 cajones
- ❶ 3 cajones de aprox. 565 x 415 x 54 mm
- ❷ 2 cajón de aprox. 565 x 415 x 72 mm
- ❸ 1 cajón de aprox. 565 x 415 x 176 mm
- ❹ 1 cajón de aprox. 310 x 435 x 75 mm

2 ruedas giratorias, 2 ruedas fijas, carga admisible por cajón aprox. 30 kg
Peso en vacío aprox. 55 kg



1129

Werkstattwagen „ECONOMY“, leer

L = lackiert
7 Schubladen mit Kugelführungen, die 2 unteren Schubladen mit großem Staufach, mit 4 Rollen, davon 2 Lenkrollen, feststellbar, aus Stahlblech

Workshop trolley „ECONOMY“, empty

L = lacquered
7 drawers with ball bearings, the 2 lower drawers with large storage compartment, 2 steering roller with brake and 2 castors, from sheet steel

Servantes d'outillage „ECONOMY“, vides

L = laquées
7 tiroirs sur glissières à billes, les 2 tiroirs basses à grand compartiment de rangement, avec 4 roues dont 2 pivotantes, verrouillables, acier

Carros de taller „ECONOMY“, vacío

L = barnizado
7 cajones de chapa de acero, con guías sobre rodamientos de bolas, los 2 inferiores con amplia bandeja, con 4 ruedas, de las cuales 2 giratorias, con freno



Code	Maße dimensions	g		EAN	€
01129010020	600 x 440 x 950 mm	58000	1	326611	724,50

1128/1129-8-15

Schutzhülle

für Werkstattwagen
HEYCO 1128/1129

Protection cover

for workshop trolley
HEYCO 1128/1129

Couvrir

pour servantes d'outillage
HEYCO 1128/1129

Funda protectora

para carros de taller
HEYCO 1128/1129



Code	Maße dimensions	für/for HEYCO No.		EAN	€
01128801500	940 x 500 x 730 mm	1128	1	342017	16,30
01129801500	730 x 500 x 840 mm	1129	1	342000	15,90

1129-8-1 - 1129-8-12

Zubehör für HEYCO
No. 1129

Accessories for HEYCO
No. 1129

Accessoires pour HEYCO
No. 1129

Accesorios para HEYCO
No. 1129

1129-8-1
Papierkorb
Waste-paper basket
Corbeille
Papelera



1129-8-2
Papierrollenhalter
Paper roll holder
Porte-rouleau
Sujeción para rollo de papel



1129-8-3
(1129-8-4)
Trennblech/Satz
Divider set for drawers
Baffle/set
Juego de chapas separadoras



1129-8-5
Fachteiler/Satz
Slotted divider set for drawers
Diviseurs/set
Juego de divisiones



1129-8-6
(1129-8-7)
Ablageschale
Storage box
plateau
Bandeja



1129-8-8
Dosenhalter
Tin holder
Porte canette
Sujeción para botes



1129-8-12
Papier-Satz
Set of paper basket
Set papier
Juego de papel



Code	No.	Maße dimensions		EAN	€
91129800120	1129-8-1	300 x 250 x 300 mm	1	328943	61,05
91129800220	1129-8-2	300 x 200 x 250 mm	1	328936	55,70
91129800360	1129-8-3	348 x 60 mm	1	327274	10,20
91129800460	1129-8-4	348 x 100 mm	1	328912	15,00
91129800560	1129-8-5	348 x 100 x 60 mm	1	328882	65,30
91129800620	1129-8-6	220 x 60 x 80 mm	1	328929	9,65
91129800720	1129-8-7	300 x 60 x 80 mm	1	328899	13,90
91129800820	1129-8-8	160 x 300 x 10 mm	1	328905	70,65
91129801220	1129-8-12	1129-8-1+1129-8-2	1	330533	98,55

Variable Bestückung der großen Schubfächer im Werkstattwagen 1128 mit Modulen

Beispiele

Variable assembly alternatives of large drawers of workshop trolley 1128

Examples

Exemples d'assortiment des grands tiroirs de la servante d'atelier 1128

Exemple

Dotación variable de los cajones grandes en carro de taller ref. 1128

Ejemplos



Modul aus ABS-Kunststoff für Werkstattwagen und Verkaufsverpackung

345 x 175 x 35 mm

- Module und Boden ohne Deckel, in Folien-Schrumpfverpackung

Module made of ABS-plastic for workshop trolleys and sales packaging

345 x 175 x 35 mm

- Modules and bottom parts without cover but with shrink wrapping

Modules en plastique – ABS pour servantes d'atelier et comme coffret de présentation

345 x 175 x 35 mm

- Modules and bottom parts without cover but with shrink wrapping

Módulo de plástico tipo ABS para carros de taller y como envase de autoventa

345 x 175 x 35 mm

- Solo módulos y fondo plastificados



Deckel
Cover
Couvercle
Tapa

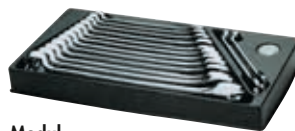

Modul
Module
Module
Módulos



Boden
Bottom
Fond
Fondo

1128-8-5 1128-8-9

Zubehör

1128-8-9*
Gummimatte

1128-8-5**
Trennleisten

Accessories

1128-8-9*
Rubber mat

1128-8-5**
Divider set

Accessoires

1128-8-9*
Tapis en caoutchouc

1128-8-5**
Sectionneurs

Accesorios

1128-8-9*
Alfombra de goma

1128-8-5**
Listones separadores

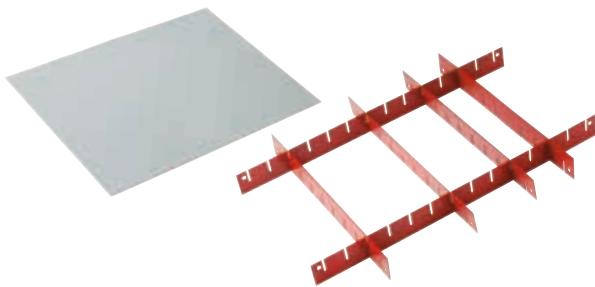

Code	Maße dimensions	für/for HEYCO No.		EAN	€
01128110100*	562 x 416 x 2 mm	1128	1	157307	13,80
01128110200**	45 mm hoch/high	1128	1	172041	34,30

E 970-3

Freifach-Module

ABS-Kunststoff
ST = standardmäßig

Spacing modules

ABS-plastic
ST = standard

Module à compartiment libre

ABS-Plastique
ST = standard

Modulo vacío

Plástico tipo ABS
ST = estándar

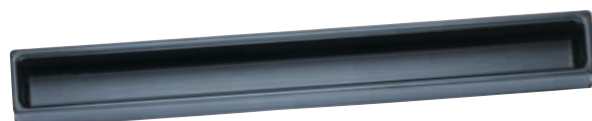

Code	Maße dimensions			EAN	€
00970000300	560 x 65 x 36 mm	85	1	129434	7,15

1128-8

Werkzeugsortiment in Werkstattwagen

Tool assortment in workshop trolley

Composition d'outillage en servantes d'atelier

Surtidos de herramientas para carro de taller

HEYCO
FORMEL plus



Code	tlg. pcs.	Module modules			EAN	€
01128000800	58	8	64000	1	130027	1.768,50

enthaltend /containing						
Stck. pcs.						
6	Modul No. module No.	968-8 990-4	973-8 991-8	985-0010 992-4		
2	Modul No. module No.	E 970-3				
1	 Art. No.	1128				

Inhalt / content



968-8



973-8



990-4



985-0010



992-4



991-8



E 970-3



E 970-3

1128-3

Werkzeugsortiment in Werkstattwagen

Tool assortment in workshop trolley

Composition d'outillage en servantes d'atelier

Surtidos de herramientas para carro de taller

HEYCO
FORMEL plus



Code	tlg. pcs.	Module modules			EAN	€
01128000300	190	3	76000	1	357851	2.798,00

enthaltend /containing						
Stck. pcs.						
3	Modul No. module No.	1128-21	1128-22	1128-23		
1	 Art. No.	1128				

Inhalt / content



1128-21



1128-22



1128-23

960-7 - 995-8

Module

Modules

Modules

Módulos

960-7

Winkelschraubendreher-Satz

für Innensechskantschrauben

Chrom-Vanadium
C = verchromt

Hexagonal head wrench set

for hexagon socket screws

Chrome-Vanadium
C = chromium plated

Jeux de clés mâles coudées

pour vis 6 pans creux

Chrome-Vanadium
C = chromées

Juegos de llave Allen, acodadas

para tornillos Allen

Cromo Vanadio
C = cromado



Code	tlg. pcs.			EAN	€
00960001080	7	810	1	141337	51,90

enthaltend /containing

Stck. pcs.	Artikel article	No.	Maße dimensions
7		1337	MM 2,5 3 4 5 6 8 10

961-7

Winkelschraubendreher-Satz

für Innen-Torx®-Schrauben

Chrom-Vanadium
C = verchromt

Wrench set, "L"-shaped

for Torx®-socket screws

Chrome-Vanadium
C = chromium plated

Jeux de clés mâles coudées

pour vis Torx® intérieures

Chrome-Vanadium
C = chromées

Llaves macho, acodadas

para tornillos Torx® interiores

Cromo Vanadio
C = cromado



Code	tlg. pcs.			EAN	€
00961001080	7	590	1	141351	85,00

enthaltend /containing

Stck. pcs.	Artikel article	No.	Maße dimensions
7		1347	T 10 15 20 25 27 30 40

965-9

Doppelsteckschlüssel-Satz

Chrom-Vanadium
CP = verchromt,
Köpfe poliert

Double ended socket wrench set

Chrome-Vanadium
CP = chromium plated,
polished heads

Jeux de clés de douilles

Chrome-Vanadium
CP = chromées,
têtes polies

Juegos de llaves de tubo

Cromo Vanadio
CP = cromado,
cabezas pulidas espejo



Code	tlg. pcs.			EAN	€
00965000280	9	1580	1	158939	175,00

enthaltend /containing

Stck. pcs.	Artikel article	No.	Maße dimensions
9		530	MM 6 x 7 8 x 9 10 x 11 12 x 13 14 x 15 16 x 17 18 x 19 20 x 22
1		1360	Ø 3,2 – 12 mm x 280 mm

968-8

Doppelmaulschlüssel-Satz

Chrom-Vanadium
CP = verchromt,
Köpfe poliert

Double ended open jaw
wrench set

Chrome-Vanadium
CP = chromium plated,
polished heads

Jeux de clés à fourche

Chrome-Vanadium
CP = chromées,
têtes polies

Juegos de llaves fijas
de dos bocas abiertas

Cromo Vanadio
CP = cromado,
cabezas pulidas espejo



Code	tlg. pcs.			EAN	€
00968000282	8	950	1	141320	57,90

enthaltend /containing

Stck. pcs.	Artikel article	No.	Maße dimensions
8		350	MM 6 x 7 8 x 9 10 x 11 12 x 13 14 x 15 16 x 17 18 x 19 20 x 22

969-10

Doppelmaulschlüssel-Satz

Chrom-Vanadium
CP = verchromt,
Köpfe poliert

Double ended open jaw
wrench set

Chrome-Vanadium
CP = chromium plated,
polished heads

Jeux de clés à fourche

Chrome-Vanadium
CP = chromées,
têtes polies

Juegos de llaves fijas
de dos bocas abiertas

Cromo Vanadio
CP = cromado,
cabezas pulidas espejo



Code	tlg. pcs.			EAN	€
00969000282	10	1560	1	141313	86,50

enthaltend /containing

Stck. pcs.	Artikel article	No.	Maße dimensions
10		350	MM 6 x 7 8 x 9 10 x 11 12 x 13 14 x 15 16 x 17 18 x 19 20 x 22 21 x 24 27 x 30

970-10

Doppelmaulschlüssel-Satz

Chrom-Vanadium
CP = verchromt,
Köpfe poliert

Double ended open jaw
wrench set

Chrome-Vanadium
CP = chromium plated,
polished heads

Jeux de clés à fourche

Chrome-Vanadium
CP = chromées,
têtes polies

Juegos de llaves fijas
de dos bocas abiertas

Cromo Vanadio
CP = cromado,
cabezas pulidas espejo



Code	tlg. pcs.			EAN	€
00970000282	10	1785	1	120738	87,15

enthaltend /containing

Stck. pcs.	Artikel article	No.	Maße dimensions
10		350	MM 6 x 7 8 x 9 10 x 11 12 x 13 14 x 15 16 x 17 18 x 19 20 x 22 24 x 26 30 x 32

971-17

Ringmaulschlüssel-Satz

Chrom-Vanadium
CP = verchromt,
Kopf und Ring poliert
• Module ohne Deckel,
in Folien-Schrumpferpackung

Combination wrench set

Chrome-Vanadium
CP = chromium-plated,
polished head and ring
• Modules and bottom parts
without cover but with shrink
wrapping

Jeux de clés mixtes

Chrome-Vanadium
CP = chromées,
têtes polies
• Module et base seuls sous film
retractable

Juegos de llaves combinadas

Cromo Vanadio
CP = cromado,
cabezas pulidas espejo
• Solo módulos y fondo plastificados



Code	tlg. pcs.			EAN	€
00971000282	17	1940	1	120745	169,05

enthaltend /containing

Stck. pcs.	Artikel article	No.	Maße dimensions
14		400	MM 6 7 8 9 10 11 12 13 14 15 16 17 18 19 21 22 24

972-14

Ringmaulschlüssel-Satz

Chrom-Vanadium
CPP = verchromt,
ganz poliert
• Module ohne Deckel, in Folien-
Schrumpferpackung

Combination wrench set

Chrome-Vanadium
CPP = chromium plated,
fully polished
• Modules and bottom parts
without cover
but with shrink wrapping

Jeux de clés mixtes

Chrome-Vanadium
CPP = chromées,
entièrement polies
• Module et base seuls sous film
retractable

Juegos de llaves combinadas

Cromo Vanadio
CPP = cromado,
enteramente pulido espejo
• Solo módulos y fondo plastificados



HEYCO
maxline



Code	tlg. pcs.			EAN	€
00972000283	14	2680	1	120752	203,10

enthaltend /containing

Stck. pcs.	Artikel article	No.	Maße dimensions
14		410	MM 10 11 12 13 14 15 16 17 18 19 20 21 22 24

973-8

Doppelringschlüssel-Satz

Chrom-Vanadium
CP = verchromt,
Ringe poliert

Double ended ring wrench set

Chrome-Vanadium
CP = chromium-plated,
polished rings

Jeux de clés polygonales

Chrome-Vanadium
CP = chromées,
têtes polies

Juegos de llaves de estrella acodadas, de dos bocas

Cromo Vanadio
CP = cromado,
cabezas pulidas espejo



Code	tlg. pcs.			EAN	€
00973000282	8	1460	1	120769	102,00

enthaltend /containing

Stck. pcs.	Artikel article	No.	Maße dimensions
8		475	MM 6 x 7 8 x 9 10 x 11 12 x 13 14 x 15 16 x 17 18 x 19 20 x 22

975-3010

Steckschlüssel-Garnitur

Chrom-Vanadium
CPP = verchromt,
ganz poliert

Socket set

Chrome-Vanadium
CPP = chromium plated,
fully polished

Composition de douilles

Chrom-Vanadium
CPP = chromées,
entièrement polies

Juegos de llaves de vaso

Cromo Vanadio
CPP = cromado,
enteramente pulido espejo

1/4 HEYCO
VARICAT



Code	tlg. pcs.			EAN	€
00975301083	38	1120	1	120776	208,40

enthaltend /containing

Stck. pcs.	Artikel article	No.	Maße dimensions
13		25-6	MM 4 4,5 5 5,5 6 7 8 9 10 11 12 13 14
1		25-00-15	140 mm
1		25-03	114 mm
1		25-04	55 mm
1		25-05-1	150 mm
1		25-06	35 mm
1		25-08	145 mm
3		25-30	4 x 0,8 5,5 x 1,0 8 x 1,2 mm
5		25-31	MM 3 4 5 6 8
2		25-32	PH No. 1 2
9		HP 1340-9	MM 1,5 2 2,5 3 4 5 6 8 10

980-14

Satz mit Schraubendreher-Einsätzen

Körper = Chrom-Vanadium
CPP = verchromt, ganz poliert
Bits = Sonderstahl
Ph = phosphatiert

Set with screwdriver sockets

Socket bodies = Chrome-Vanadium
CPP = chromium plated,
fully polished
Bits = special steel
Ph = phosphated

Jeux de douilles tournevis

Douilles = Chrome-Vanadium
CPP = chromées, entièrement polies
Embouts = Acier Spécial
Ph = phosphaté

Juegos de llaves de vaso con destornillador

Cuerpo = Cromo Vanadio
CPP = cromado,
enteramente pulido espejo
Puntas = Acero aleado
Ph = fosfatado

1/2



Code	tlg. pcs.			EAN	€
00980000083	14	1385	1	141344	164,10

enthaltend /containing

Stck. pcs.	Artikel article	No.	Maße dimensions
5		50-31	MM 4 x 52 mm 5 x 52 mm 6 x 52 mm 8 x 52 mm 10 x 52 mm
4		50-33	M6 x 52 mm M8 x 100 mm M10 x 120 mm M12 x 100 mm
5		50-36	T 25 x 55 mm T 27 x 55 mm T 30 x 55 mm T 40 x 55 mm T 45 x 55 mm

984-3800

Universal-Steckschlüssel-Garnitur

Chrom-Molybdän (42 Cr Mo4)
extra dünnwandig
PH = phosphatiert

Universal socket set

Chrome molybdenum (42 Cr Mo4)
extra thin walls
PH = phosphated

Composition de douilles universelles

Chrome molybdène (42 Cr Mo4)
parois extra-minces
PH = phosphatées

Juegos de llaves de vaso universal

Cromo molibdeno (42 Cr Mo4)
paredes extra-delgadas
PH = fosfatado



Code	tlg. pcs.			EAN	€
00984380036	23	3035	1	129694	402,95

enthaltend /containing

Stck. pcs.	Artikel article	No.	Maße dimensions
15		3800	MM 10 11 12 13 14 15 16 17 18 19 20 21 22 23 24
4		3800-19	MM 17 19 21 22
		3804-25	
		3804-50	
		3805-50	
		3806-10	

985-0010 985-3010

Steckschlüssel-Garnituren

Chrom-Vanadium
CPP = verchromt,
ganz poliert

Socket sets

Chrome-Vanadium
CPP = chromium plated,
fully polished

Composition de douilles

Chrome-Vanadium
CPP = chromées,
entièrement polies

Juegos de llaves de vaso

Cromo Vanadio
CPP = cromado,
enteramente pulido espejo



Code	No.	tlg. pcs.			EAN	€
00985001083	985-0010	23	3460	1	120783	292,20

enthaltend /containing

Stck. pcs.	Artikel article	No.	Maße dimensions
17		50-12	MM 10 11 12 13 14 15 16 17 18 19 21 22 23 24 27 30 32
1		50-00-10	275 mm
1		50-03	300 mm
1		50-04-1	75 mm
1		50-04	125 mm
1		50-05	250 mm
1		50-06	80 mm

Code	No.	tlg. pcs.			EAN	€
00985301083	985-3010	23	3520	1	120790	292,20

wie 985-0010, jedoch / as 985-0010, but

Stck. pcs.	Artikel article	No.	Maße dimensions
1		50-6	MM 10 11 12 13 14 15 16 17 18 19 21 22 23 24 27 30 32

990-4

Zangen-Satz

CPI = verchromt, Kopf poliert,
FORMEL plus Kunststoffgriffe mit
Abgleitschutz

Set of pliers

CPI = chromium plated,
polished head, **FORMEL plus**
plastic handles with slip guard

Jeux de pinces

CPI = chromées, têtes polies,
branches **FORMEL plus** gainées plastique,
antiglissant





Juegos de alicates

CPI = cromado, cabeza pulida,
fundas de plástico **FORMEL plus**
con tope salvamanos



Code	tlg. pcs.			EAN	€
00990001086	4	1180	1	120806	130,25

enthaltend /containing

Stck. pcs.	Artikel article	No.	Maße dimensions
1		1200 CPI	180 mm
1		1208 CPI	200 mm
1		1213 CPI	160 mm
1		1220 CPI	160 mm

990-4-1

VDE Zangen-Satz

CPV = verchromt, Kopf poliert,
Isoliergriffhüllen
IEC 900/DIN EN 60900/VDE 0682
Teil 201

Set of pliers VDE

CPV = chromium plated, polished
head, VDE insulated handles
IEC 900/DIN EN 60900/VDE 0682
part 201

VDE Jeux de pinces

CPV = chromées, tête polie,
branches isolés, antiglissant
IEC 900/DIN EN 60900/VDE 0682
paragraphe 201

VDE Juegos de alicates

CPV = cromado, cabeza pulida,
fundas aislantes
IEC 900/DIN EN 60900/VDE 0682
apartado 201



Code	tlg. pcs.			EAN	€
00990002088	4	1200	1	120813	179,40

enthaltend /containing

Stck. pcs.	Artikel article	No.	Maße dimensions
1		1200 VDE	180 mm
1		1208 VDE	200 mm
1		1213 VDE	160 mm
1		1220 VDE	160 mm

991-7

2 K-Schraubendreher-Satz

Chrom-Vanadium
C = verchromt

2 K-Screwdriver set

Chrome-Vanadium
C = chromium plated

2 K-Jeux de tournevis

Chrome-Vanadium
C = chromées



Juegos de destornilladores-2K

Cromo Vanadio
C = cromado



Code	tlg. pcs.			EAN	€
00991001580	7	885	1	167535	56,80

enthaltend /containing

Stck. pcs.	Artikel article	No.	Maße dimensions
2		4511 C	PH No. 1 2
3		4530 C	5,5 x 100 mm 6,5 x 125 mm 8 x 150 mm
2		4535 C	3 x 75 mm 4 x 125 mm

991-8

Schraubendreher-Satz

Chrom-Vanadium
C = verchromt

Screwdriver set

Chrome-Vanadium
C = chromium plated

Jeux de tournevis

Chrome-Vanadium
C = chromées

Juegos de destornilladores

Cromo Vanadio
C = cromado



Code	tlg. pcs.			EAN	€
00991001080	8	820	1	120820	60,30

enthaltend /containing

Stck. pcs.	Artikel article	No.	Maße dimensions
4		1411 CP	PH No. 0 1 2 3
3		1430 CP	5,5 x 100 mm 6,5 x 125 mm 8 x 150 mm
1		1435 CP	3 x 75 mm

991-8-1

VDE Schraubendreher-Satz

Chrom-Vanadium
BV = brüniert,
IEC 900/DIN EN 60900/VDE 0682
Teil 201

VDE Screwdriver set

Chrome-Vanadium
BV = gun-metal finish,
VDE 1000 volt insulated

VDE Jeux de tournevis

Chrom-Vanadium
BV = bruni, isolé,
IEC 900/DIN EN 60900/VDE 0682
paragraphe 201

VDE Juegos de destornilladores

Cromo Vanadio
BV = pavonado, mangos con funda de
plástico, protección cumple EN 60900,
aislamiento de la varilla inyectado,
mango de plástico antichoque



Code	tlg. pcs.			EAN	€
00991002033	8	660	1	120837	69,05

enthaltend /containing

Stck. pcs.	Artikel article	No.	Maße dimensions
4		1411 VDE	PH No. 0 1 2 3
4		1436 VDE	2,5 x 75 mm 4 x 100 mm 5,5 x 125 mm 6,5 x 150 mm

992-4

Zangen-Satz für Sicherungsringe

Chrom-Vanadium
CPD = verchromt, Kopf poliert,
Griffe kunststoffbeschichtet

Set of circlip pliers

Chrome-Vanadium
CPD = chromium plated,
polished head,
plastic coated handles

Jeux de pinces pour circlips

Chrom-Vanadium
CPD = chromées, articulation polie,
branches gainées plastique

Juegos de alicates para arandelas

Cromo Vanadio
CPD = cromado, unión pulida,
mangos plastificados



Code	tlg. pcs.			EAN	€
00992000087	4	820	1	147452	124,85

enthaltend /containing

Stck. pcs.	Artikel article	No.	Maße dimensions
1		1250 CPD	175 mm gerade für Außensicherung 175 mm for external circlips, straight
1		1252 CPD	165 mm gebogen für Außensicherung 165 mm for external circlips, bent
1		1255 CPD	180 mm gerade für Innensicherung 180 mm for external circlips, straight
1		1256 CPD	170 mm gebogen für Innensicherung 170 mm for external circlips, bent

995-8

Werkzeug-Satz

Chrom-Vanadium
LS = lackiert, teilweise geschliffen

Tool set

Chrome-Vanadium
LS = lacquered, partly ground

Jeu d'outils

Chrome-Vanadium
LS = laquées, partiellement meulé

Conjunto de herramientas

Cromo Vanadio
LS = barnizado, parcialmente pulido



Code	tlg. pcs.			EAN	€
00995000021	8	1730	1	141306	80,35

enthaltend /containing			
Stk. pcs.	Artikel article	No.	Maße dimensions
2		1555	150 mm 200 mm
4		1565	Ø 3 4 5 6 x 150 mm
1		1575	Ø 4 x 120 mm
1		1520	500 g

1128-3

Werkzeugsortiment im Werkstattwagen mit 190 Werkzeugen in 3 Modulen

L = lackiert

190 Werkzeuge in 3 hochwertigen 2-K Schaumstoffeinlagen ohne Dekoration

Tool assortment in workshop trolley 190 tools in 3 moduls

L = lacquered

190 tools in 3 high quality 2-K foam inserts without decoration

Jeu d'outils en servante d'atelier avec 190 outils en 3 modules

L = laquées

190 outils 3 inserts de haute qualité en mousse à 2 composants sans décoration

Surtido de herramientas con 190 piezas en 3 módulos

L = barnizado

190 herramientas en 3 módulos de plástico de 2 componentes Sin decoración

HEYGO
FORMEL plus

Code	Maße dimensions			EAN	€
01128000300	886 x 511 x 850 mm	76000	1	136593	2.798,00



1128-21

Modul 1

bestehend aus 55 Werkzeugen

Module 1

containing 55 tools

Module 1

comprenant 55 outils

Módulo 1

compuesto de 55 herramientas



Code	Maße dimensions			EAN	€
01128812100	565 x 415 x 50 mm	5490	1	357868	545,70

17-tlg. Ringmaulschlüsselsatz / 17 pcs. combination wrench set

6 · 7 · 8 · 9 · 10 · 11 · 12 · 13 · 14 · 15 · 16 · 17 · 18 · 19 · 21 · 22 · 24

8-tlg. Doppelmaulschlüsselsatz / 8 pcs. double ended open jaw wrench set

6 x 7 · 8 x 9 · 10 x 11 · 12 x 13 · 14 x 15 · 16 x 17 · 18 x 19 · 20 x 22

verstellbarer Einmaulschlüssel / Adjustable wrench 310 mm

Magnetschlüsselsatz / Ignition wrench 4 - 7,5 mm

9-tlg. Winkelschraubendrehersatz mit Kugelkopf / 9 pcs. ball head hexagonal wrench set

1,5 · 2 · 2,5 · 3 · 4 · 5 · 6 · 8 · 10

8-tlg. Winkelschraubendrehersatz / 8 pcs. ball head TORX®-wrench set

TORX® T9 · T10 · T15 · T20 · T25 · T27 · T30 · T40

Präzisions-Schieblehre / Precision vernier calipers

13 tlg. Fühlerlehre / 13 pcs. feeler gauge 0,05 - 1,0 mm

Profi-Bandmass, Zink-Guss, Länge 5 m, mit Gürtelclip / Measuring tape, 5 m

Cutter-Messer, 18 mm Klingenbreite, mit 5 Klingen / Utility knife, 18 mm

Sicherheits-Rettungsmesser / Rescue knife

LED-Teleskop-Taschenlampe / LED Torch light

VDE-Flachrundzange, gerade, 160 mm / VDE Snip nose plier, straight, 160 mm

VDE-Abisolierzange 160 mm / VDE Wire stripping plier, 160 mm

VDE Spannungsprüfer 60 x 3 mm / VDE Voltage tester 60 x 3 mm

VDE-Kreuzschlitz-Schraubenreher Gr. 1 / VDE Cross slot screwdriver, PH 1

VDE-Elektriker-Schraubendreher 100 x 3,5 mm / VDE Electricians screwdriver 100 x 3,5 mm

1128-22

Modul 2

bestehend aus 110 Werkzeugen

Module 2

containing 110 tools

Module 2

comprenant 110 outils

Módulo 2

compuesto de 110 herramientas



Code	Maße dimensions			EAN	€
01128812200	565 x 415 x 50 mm	8530	1	357875	796,60



Hebel-Umschaltknarre / Reversible ratchet

Verlängerungen 50, 105 mm / Extension bar 50, 105 mm

Kardangeln, Steckgriff / Universal joint, spinner handle

Steckschlüssel-Einsätze / Sockets

4 · 5 · 6 · 7 · 8 · 9 · 10 · 11 · 12 · 13

Steckschlüssel-Einsätze TORX® / Sockets for TORX® head screws

E4 · E5 · E6 · E7 · E8 · E10

Schraubendreher-Einsätze Schlitz / Screwdriver sockets for plain slot screws

0,8 x 4 · 1,0 x 5,5 · 1,2 x 8 mm

Schraubendreher-Einsätze 6-kt / Screwdriver sockets for hexagon socket screws

3 · 4 · 5 · 6 · 8 mm

Schraubendreher-Einsätze Kreuzschlitz / Screwdriver sockets for cross slot screws

PH 1, PH 2, PZ 1, PZ 2

Schraubendreher-Einsätze TORX® / Screwdriver sockets for TORX® socket screws

T6 · T7 · T8 · T9 · T10 · T15 · T20 · T25 · T27 · T30 · T40

Adapter für 1/4" Bits / Adapter for bits 1/4"

1128-22

Modul 2

bestehend aus 110 Werkzeugen

Module 2

containing 110 tools

Module 2

comprenant 110 outils

Módulo 2

compuesto de 110 herramientas



Code	Maße dimensions			EAN	€
01128812200	565 x 415 x 50 mm	8530	1	357875	796,60



Hebel-Umschaltknarre / Reversible ratchet

Verlängerungen / Extension bar 75, 125, 250 mm

Verlängerung, schwenkbar / Wobble extension 50 mm

Kardangeln, Griff mit Gleitstück / Universal joint, sliding T-Handle

Zündkerzen-Einsätze / Spark plug socket 20,8 mm, 5/8"

Steckschlüssel-Einsätze / Sockets hexagon

13 · 14 · 15 · 16 · 17 · 19 · 21 · 22 · 24 · 27 · 30 · 32

Steckschlüssel-Einsätze TORX® / Sockets for TORX® head screws

E11 · E12 · E14 · E16 · E18 · E20 · E24

Schraubendreher-Einsätze Schlitz / Screwdriver sockets for plain slot screws

10 x 1,6 · 12 x 2,0

Schraubendreher-Einsätze 6-kt., Länge / Screwdriver sockets for hexagon socket screws,

lg 52 mm, 7 · 10 · 12 · 14 · 17 mm

Schraubendreher-Einsätze 6-kt., Länge / Screwdriver sockets for hexagon socket screws,

lg 100 mm / 8 mm, Länge 140 mm / 10 mm

Schraubendreher-Einsätze Kreuzschlitz / Screwdriver sockets for cross slot screws

PH 3, PH 4, PZ 3, PZ 4

Schraubendreher-Einsätze TORX®, Länge / Screwdriver sockets for TORX® socket screws,

lg 55 mm, T45 · T50 · T55 · T60

Schraubendreher-Einsätze TORX®, Länge / Screwdriver sockets for TORX® socket screws,

lg 120 mm, T40 · T45

Schraubendreher-Einsätze XZN, Länge / Screwdriver sockets for multi-splin socket screws XZN,

lg 52 mm, M5 · M6 · M8 · M10

Schraubendreher-Einsätze XZN, Länge / Screwdriver sockets for multi-splin socket screws XZN,

lg 100 mm / M8, Länge/lg 120 mm / M10

Schraubendreher Schlitz / Screwdriver sockets eng. screwdriver for plain slot screws

100 x 5,5 · 125 x 6,5 · 150 x 8 mm

Schraubendreher Kreuzschlitz / Screwdriver sockets cross slot screwdriver

PH 02 x 25 · PH 0 x 60 · PH 1 x 75 · PH 2 x 100 · PH 3 x 150

Schraubendreher Kreuzschlitz / Screwdriver sockets cross slot screwdriver

PZ 1 x 75 · PZ 2 x 100

Elektriker-Schraubendreher / Electricians screwdriver 75 x 3 · 125 x 4 mm

Vergaser-Schraubendreher / Stubby screwdriver 25 x 4 mm

1128-23

Modul 3

bestehend aus 25 Werkzeugen

Module 3

containing 25 tools



Module 3

comprenant 25 outils

Módulo 3

compuesto de 25 herramientas



Code	Maße dimensions	 g		EAN	€
01128812300	565 x 415 x 50 mm	4791	1	357882	387,50

Kombinationszange / Combination plier 180 mm
Seitenschneider / Diagonal side nipper 160 mm
Flachrundzange, gerade / Snipe nose plier, straight 200 mm
Rohr- und Wasserpumpenzange / Multigrip plier 240 mm
Montagezange, aussen, gebogen / Circlip plier, ext, bent 165 mm
Montagezange, innen, gerade / Circlip plier, int, straight 180 mm
Lochscherer / Hole cutting snip 250 mm
Dreikant-Hohlschaber / Triangular hollow scraper 200 mm
Flachscherer / Square scraper 200 mm
Stahl-Drahtbürste, 3-reihig / Wire brush 3 rows
Zündkerzenbürste 150 mm / Spark plug brush 150 mm
Werkstattfeile, flachstumpf / Eng file, flat 200 mm
Werkstattfeile, rund / Eng file, round 200 mm
Montiereisen / Tyre lever 400 mm
Isolierband, Länge / Insulated tape, lg 10 m
Kreuzmeißel / Cross cut chisel 150 x 6 mm
Flachmeißel / Flat cold chisel 150 x 18 mm
Durchtreiber / Taper pin punch 3 mm
Körner / Centre Ppunch 120 mm
Splinttreiber / Parallel pin punch 150 mm, Gr. 3 · 4 · 5 · 6 mm
Schlosserhammer / Engineers' hammer 300 gr.
Kunststoff-Hammer / Plastic hammer 32 mm Ø

1090

Kofflügelsschoner

Aus Nylon und selbsthaftendem Non-slip-Material, schwarz mit grüner Einfassung

- Haftet auf allen Materialien und Untergründen
- Unbedenklich für alle Lacke
- Ölabweisend
- Voll waschbar
- Schützt zuverlässig vor Beschädigungen

Auch für moderne Karosserien aus Aluminium und Kunststoff geeignet

Fender cover

Made from high-strength nylon and self-adhesive non-slip material

- Adheres to all materials and backings
- Convenient for all points
- Repellent to oil
- Fully washable
- Reliable protection against damages

Also suitable for modern car bodies from aluminium and synthetic materials

Couverture garde-boue

En nylon et matériau auto-adhésif antidérapant, noir avec ruban vert

- Adhère à tous les matériaux et supports
- Sans danger pour toutes les peintures
- Oléophobe
- Entièrement lavable
- Protège contre les dégâts

Approprié pour carrosseries modernes en aluminium et en plastique

Cubrealetas

De nylon antideslizante, color negro con ribete verde

- Se adhiere a todo tipo de material
- No daña la pintura
- Repele el aceite
- Totalmente lavable
- Protección contra raspaduras

Igualmente apto para carrocerías de aluminio y plástico



Code	Maße dimensions	 g		EAN	€
01090000000	880 x 500 mm	315	1	334371	29,00

1090-1

Kniebrett

- Feuchtigkeits- und schmutzabweisend
- Mit integriertem Tragegriff
- Resistent gegen: Öl, Benzin und Chemikalien
- Individuell einsetzbar
- Kleidung, sowie Knie bleiben sauber und trocken

Kneeling mat

- Repellent to moisture and dirt
- With integrated carrying handle
- Resistant against: oil, petrol and chemicals
- Multiple use
- Clothing and knees remain clean and dry

Planchette pour les genoux

- Résistant à l'humidité et aux taches
- Avec poignée intégrée
- Résistant à l'huile, l'essence et les produits chimiques
- Peuvent être utilisés individuellement
- Les vêtements et les genoux restent propres et secs

Plancha para trabajar de rodillas

- Repele humedad y suciedad
- Con asa integrada
- Resistente a aceites, carburantes y productos químicos
- De uso individual
- Mantiene limpios y secos vestimenta y rodillas

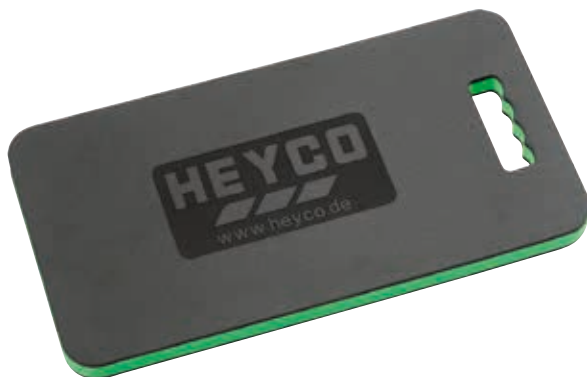

Code	Maße dimensions	 g		EAN	€
01090000100	480 x 250 x 30 mm	130	1	336702	17,85



Präsentationssysteme

Einfache Montage • beeindruckende Warenpräsentation

HEYCO-Verkaufswände sind auch ohne Aufbauanleitung einfach zu montieren.

Sie stehen selbst bei größter Belastung frei und kippsicher. Eventuelle Bodenunebenheiten können durch die einstellbaren Füße ausgeglichen werden. Die Verkaufswände lassen sich in beliebiger Anzahl aneinanderfügen und bieten somit eine beeindruckende Warenpräsentation.

Für kundenbezogene Gestaltung als Verkaufs- oder Ausstellungswände sind wir gerne bereit, Kundenwunsch entsprechende Sortimente zusammenzustellen und auf den Wänden dekorativ anzubringen.

HEYCO-Verkaufswände System „Tegometall“ entsprechen weitestgehend den handelsüblichen Wänden in Baumärkten ect. und können auf Wunsch auch in Schlüssellochung (SL) geliefert werden.

Presentation systems

Easy installation • impressive presentation of merchandise

HEYCO tool bars can easily be assembled without instructions.

Even with highest loads they stand free and firmly without risk of tilting. Eventual unevenness of floors can be levelled with adjustable pedestal. The tool bars can be assembled in any number and therefore provide an impressive presentation of merchandise.

For customer-orientated presentation of the tool bars we would be pleased to compile assortments to your specific requirements and to arrange for a decorative presentation.

HEYCO-Tool bars system „Tegometall“ correspond extensively the commonly used display stands in builders markets and cash-and-carry places and on request also can be supplied with keyhole perforation.

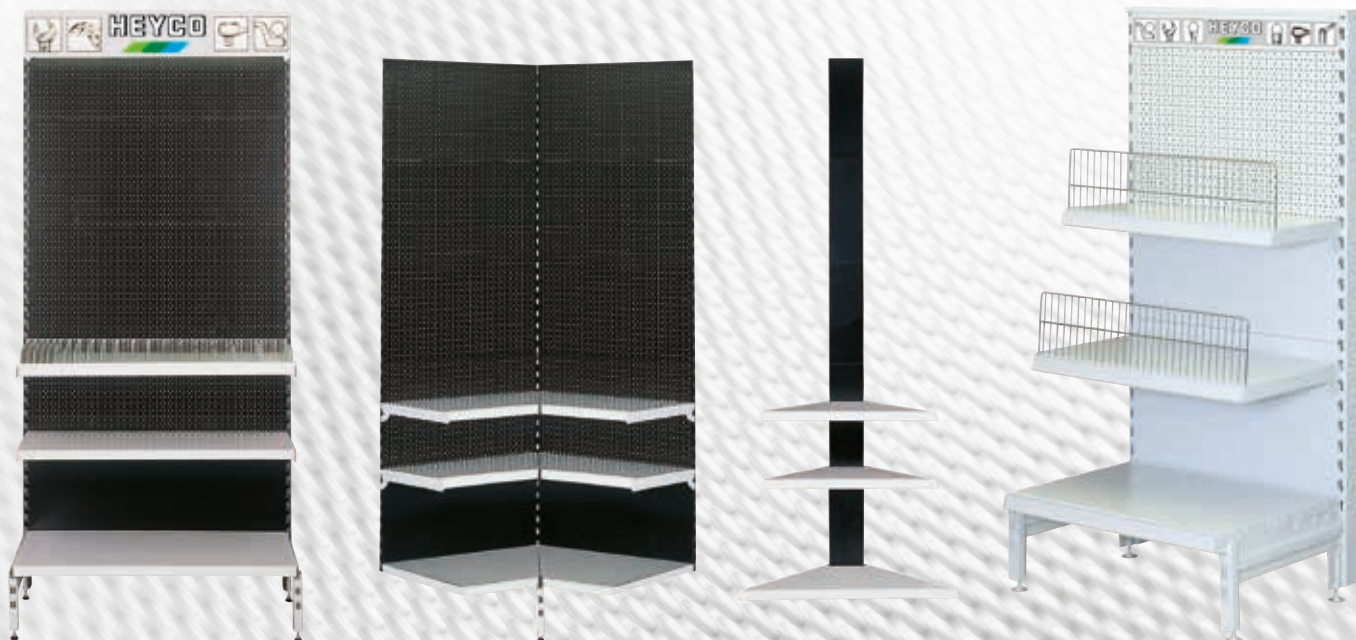

Systèmes de présentation

Montage facile • présentation du produit impressionnant

Les présentoirs d'exposition HEYCO sont faciles à assembler, même sans instruction.

Ils maintiennent leur stabilité et leur équilibre même avec un maximum de charge. L'inégalité du sol peut être nivelée par ajustage des pieds. Vous pouvez assembler autant de présentoirs que vous voulez afin d'obtenir de cette manière une présentation de marchandises impressionnante.

Nous sommes à la disposition de nos clients pour la composition des assortiments selon leurs propres idées ou suivant nos suggestions, afin d'équiper les présentoirs pour la vente ou l'exposition.

Les présentoirs HEYCO, système „Tegometall“ sont compatibles avec les présentoirs courants du commerce, utilisés dans la plupart des surfaces de vente et peuvent, sur demande, être fournis en perforation à serrure (SL).

Sistemas de exposición

Fácil montaje • Impresionante presentación

Los expositores HEYCO son de fácil montaje para el que no se requieren instrucciones.

No hace falta fijarlos a la pared, incluso plenamente cargados mantienen perfectamente su estabilidad y equilibrio. Los pies ajustables permiten compensar posibles desniveles del suelo. Los expositores se acoplan perfectamente para cubrir cualquier extensión de pared, formando de esta manera una impresionante presentación de la mercancía.

Sobre pedido, confeccionamos surtidos especiales y diseñamos su colocación decorativa en el expositor.

Los expositores HEYCO sistema „Tegometall“ se corresponden en gran medida con los modelos generalmente usados en el comercio. Están disponibles también con agujeros alargados (SL).

1170

Lochplatten-Verkaufswand System „Tegometall“

L = lackiert (schlag- und kratzfest durch Kunststoff-Pulverbeschichtung) aus 1,25 mm starkem Stahlblech, Rundlochung (RL), 5 einhängbare Tafeln 1000 x 400 mm, davon 4 Tafeln gelocht, 3 glatte Ablageböden, 1 Einteilungs-Satz mit vorderer und hinterer Abteilschiene und 20 Trennbleche sowie Preis-schiene für mittleren oder oberen Ablageboden, mittlerer und oberer Ablageboden schrägstellbar, mit Bodenausgleichsfüßen und Beleuchtungseinheit.

Perforated tool bar system „Tegometall“

L = lacquered (scratch- and shock resistant plastic coating) made of 1,25 mm thick sheet steel, round hole perforation, 5 individual hang on boards 1000 x 400 mm for easy assembly, 4 of which are perforated, 3 plain shelves, 1 set of sub-divisions consisting of front- and rear division rails, 20 partitions and rail for price tags for middle or upper shelf, middle and upper shelf can be tilted, with adjustable pedestal and illumination.

Présentoirs perforés en tôle d'acier système „Tegometall“

L = laquées (revêtement polymérisé, résistant aux chocs et éraflures), forte tôle d'acier de 1,25 mm, perforées de trous ronds (RL), 5 plateaux à suspendre de 1000 x 400 mm, dont 4 perforés, 3 plateaux pleins, 1 jeu de séparation avec rails avant et arrière pour compartiments et 20 plaquettes de séparation ainsi que des rainures pour étiquetage des prix destinées aux plateaux centraux et supérieurs, plateaux centraux et supérieurs inclinables, pieds ajustables et enseigne lumineuse.

Expositores de chapa perforada Sistema „Tegometall“

L = pintado (mediante recubrimiento con epoxy, resistente a golpes y raspados); de chapa de acero de 1,25 mm de grosor; agujeros redondos (RL); con 5 tableros de 1.000 x 400 mm, de ellos 4 con agujeros; 3 estantes lisos, un juego de separadores con listón delantero y trasero y 20 separadores, además de listón para precios para los estantes medio y superior, ambos inclinables; con pies compensadores y cabezal de iluminación.

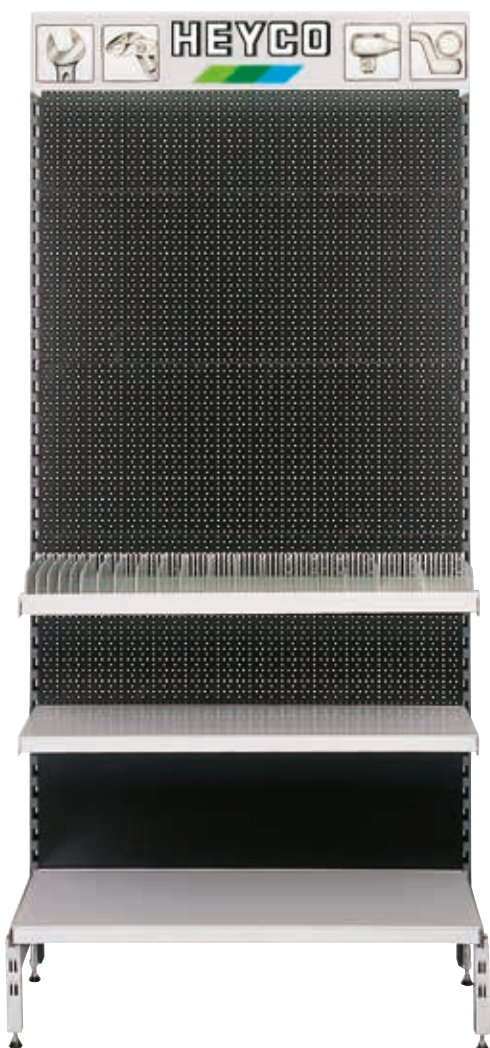

Code	tlg. pcs.			EAN	€
01170010020	40	68000	1	133837	auf Anfrage on request

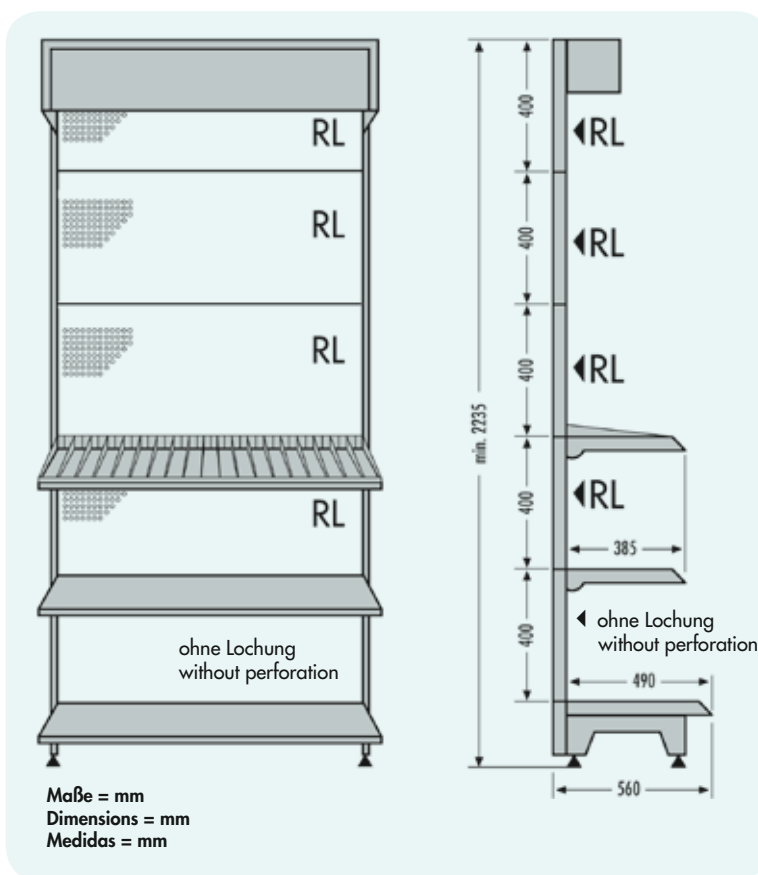

1171

Lochplatten-Verkaufswand System „Tegometall“ Innenecke 2 x 45° *

6 Fachböden, 8 Tafeln RL, 2 Tafeln glatt, 8 Konsolen, 1 Stütze, 1 Fußteil

Beschreibung siehe HEYCO No. 1170
* als Anbaueinheit an bestehende Verkaufswände HEYCO No. 1170

Perforated tool bar system „Tegometall“
Inner corner 2 x 45° *

6 shelves, 8 boards with round hole perforation, 2 plain boards, 1 support, 1 pedestal

Description see HEYCO No. 1170
* as additional unit for existing display stands HEYCO No. 1170

Présentoirs perforés en tôle d'acier
système „Tegometall“
Coins intérieurs 2 x 45° *

6 supports de tablettes, 8 panneaux perforés RL, 2 panneaux pleins, 1 support, 1 socle

Voir HEYCO N° 1170 pour description
* pour adaptation aux présentoirs existants HEYCO No. 1170

Expositores de chapa perforada
Sistema „Tegometall“
Rincón 2 x 45° *

6 estantes, 8 tableros RL, 2 tableros lisos, 1 apoyo, 1 pie

Véase descripción en ref. HEYCO 1170
* como complemento para expositores ref. HEYCO No. 1170



Code	tlg. pcs.			EAN	€
01171010020	18	15000	1	144475	auf Anfrage on request

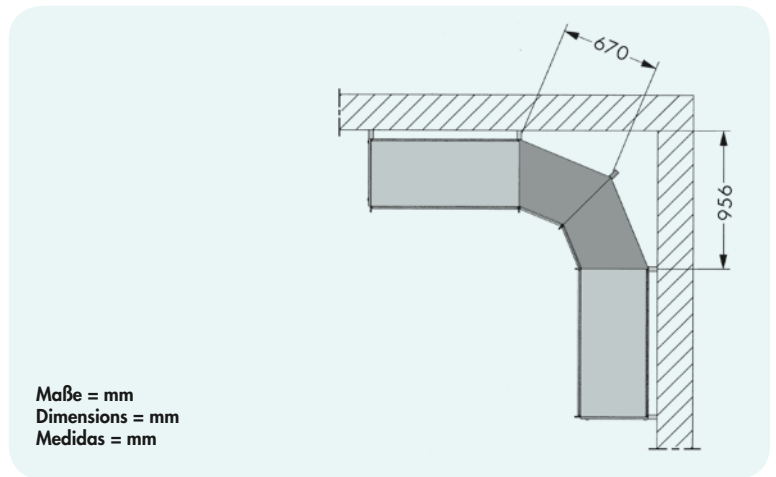

1172

Lochplatten-Verkaufswand System „Tegometall“ Außenecke 90° *

3 Fachböden, 5 Tafeln glatt

Beschreibung siehe HEYCO No. 1170
* als Anbaueinheit an bestehende Verkaufswände HEYCO No. 1170

Perforated tool bar system „Tegometall“
Outer corner 90° *

3 shelves, 5 plain boards

Description see HEYCO No. 1170
* as additional unit for existing display stands HEYCO No. 1170

Présentoirs perforés en tôle d'acier
système „Tegometall“
Coins extérieurs 90° *

3 supports de tablette, 5 panneaux pleins

Voir HEYCO N° 1170 pour description
* pour adaptation aux présentoirs existants HEYCO No. 1170

Expositores de chapa perforada
Sistema „Tegometall“
Esquina 90° *

3 estantes, 5 tableros lisos

Véase descripción en ref. HEYCO 1170
* como complemento para expositores ref. HEYCO No. 1170



Code	tlg. pcs.			EAN	€
01172010020	8	8000	1	144437	auf Anfrage on request

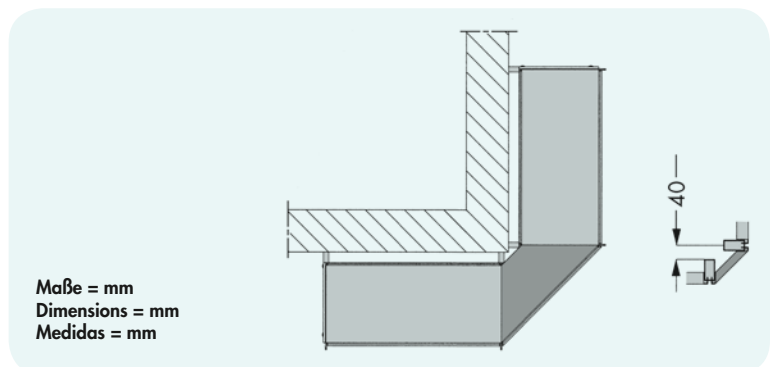

1174

Lochplatten-
Verkaufsständer
System „Tegometall“
(Beschreibung siehe
HEYCO No. 1170)

3 Fachböden, 2 Tafeln glatt,
1 Tafel RL, 1 Logotafel, 2 Fußsteile,
2 Stützen, 2 Sicherungsgitter,
4 Konsolen, Kopfabdeckungen

Perforated tool bar
system „Tegometall“
(Description-see
HEYCO No. 1170)

3 shelves, 2 plain hangon boards,
1 hong on board with round hole
perforation, 1 board with logo
2 pedestals, 2 supports,
2 protection trellis, 4 consoles,
covers

Présentoirs de vente perforés en
tôle d'acier
System „Tegometall“
(Voir HEYCO No. 1170 pour
description)

3 plateaux à casiers, 2 plateaux pleins,
1 planneau perforé RL, 1 tableau de logos
2 pieds, 2 supports, 2 grilles de sécurité
4 consoles, bandeau supérieur

Expositor con paneles
perforados
Sistema „Tegometall“
(Véase descripción en HEYCO 1170)

3 bandejas, 2 paneles lisos, 1 panel RL
1 panel con logotipo, 2 pies
2 apoyos, 2 rejillas protectoras
4 cónsolas, topes



Code	tlg. pcs.	Maße dimensions			EAN	€
01174010020	21	1450 x 700 x 560 mm	30000	1	310474	auf Anfrage on request



1186

Verkaufsdisplay
Hebelumschaltknarren

Chrom-Vanadium
CPP = verchromt,
ganz poliert

Sales display for
reversible ratchets

Chrome-Vanadium
CPP = chromium plated,
fully polished

Display cliquets réversibles

Chrome-Vanadium
CPP = chromées,
entièrement polies

Display de autoventa para
carracas reversibles

Cromo Vanadio
CPP = cromado,
enteramente pulido espejo

HEYCO
VARICAT



Code	tlg. pcs.	Maße dimensions			EAN	€
01186001083	26	355 x 280 x 420 mm	10225	1	311464	1.460,85

enthaltend /containing			
Stck. pcs.	Artikel article	No.	
10	1/4	25-00-10	
9	3/8	40-00-10	
7	1/2	50-00-10	

1187

Verkaufsddisplay Hebelumschaltknarren

Chrom-Vanadium
CPP = verchromt,
ganz poliert

Sales display for reversible ratchets

Chrome-Vanadium
CPP = chromium plated,
fully polished

Display cliquets réversibles

Chrome-Vanadium
CPP = chromées,
entièrement polies

Display de autoventa para carracas reversibles

Cromo Vanadio
CPP = cromado,
enteramente pulido espejo

talenta®



Code	tlg. pcs.	Maße dimensions	g		EAN	€
01187541083	12	205 x 205 x 350 mm	4362	1	325546	683,05

enthaltend /containing		
Stck. pcs.	Artikel article	No.
12	 1/2"	50-40-10

Zubehör

für Lochplattenwände
HEYCO 1170, 1171, 1172, 1174

Accessories

for perforated tool bars
HEYCO 1170, 1171, 1172, 1174

Accessoires

pour panneaux perforés
HEYCO 1170, 1171, 1172, 1174

Accesorios

para expositores
HEYCO 1170, 1171, 1172, 1174

1170-8-1 / 1170-8-2

Sockelblenden Frontabdeckung / Sockelblenden Seitenabdeckung

für Lochplattenwand 1170

L = lackiert
Stahlblech mit Gummileiste

Pedestal panel – front cover / Pedestal panel – side cover

for perforated tool bar 1170

L = lacquered
Sheet steel with rubber lip

Cache-socle de devant / Cache-socle de latéral

pour panneau perforé 1170

L = laquées
Tôle d'acier avec rebord en caoutchouc

zócalos frontales / zócalos laterales

para expositor 1170

L = barnizado
Chapa de acero con remate de caucho

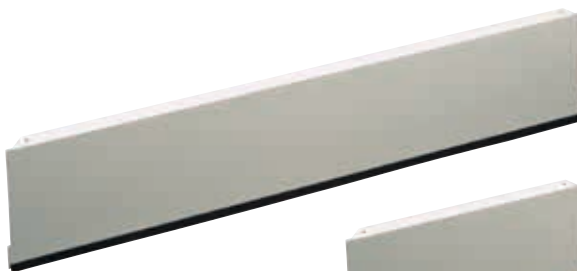

1170-8-1

1170-8-2

Code	No.	Maße dimensions	g		EAN	€
01170800120	1170-8-1	1000 x 260 mm	2000	1	144604	auf Anfrage on request
01170800220	1170-8-2	55 x 260 mm	910	2	144598	

1171-8-1

Sockelblenden Frontabdeckung

für Lochplattenwand 1171

L = lackiert
Stahlblech mit Gummileiste

Pedestal panel –
front cover
for perforated tool bar 1171

L = lacquered
Sheet steel with rubber lip



Cache-socle de devant



pour panneau perforé 1171

L = laquées
Tôle d'acier avec rebord en caoutchouc

zócalos frontales

para expositor 1171

L = barnizado
Chapa de acero con remate de caucho

Code	Maße dimensions	 g		EAN	€
01171800120	320 x 260 mm	600	2	144574	auf Anfrage on request

1172-8-1

Sockelblenden Frontabdeckung

für Lochplattenwand 1172

L = lackiert
Stahlblech mit Gummileiste

Pedestal panel –
front cover
for perforated tool bar 1172

L = lacquered
Sheet steel with rubber lip



Cache-socle de devant



pour panneau perforé 1172

L = laquées
Tôle d'acier avec rebord en caoutchouc

zócalos frontales

para expositor 1172

L = barnizado
Chapa de acero con remate de caucho

Code	Maße dimensions	 g		EAN	€
01172800120	760 x 260 mm	1590	1	144567	auf Anfrage on request

1170-11 1174-11

Fußteilschubladen

für Lochplattenwände
1170 und 1174

L = lackiert
Stahlblech, mit Rollen,
für max. Belastung
120 kg (1170-11),
80 kg (1174-11)

Drawer for pedestal
for perforated tool bars
1170 and 1174

L = lacquered
Sheet steel with rollers,
for loads of max.
120 kg (1170-11),
80 kg (1174-11)

Tiroir de socle

pour panneaux perforés
1170 et 1174



L = laquées
Tôle d'acier, avec roulettes,
pour charge de
120 kg (1170-11),
80 kg (1174-11)

Cajón para parte inferior

para expositor
1170 y 1174

L = barnizado
Chapa de acero, con ruedas,
carga máxima admisible
120 kg (1170-11),
80 kg (1174-11)



Code	No.	Maße dimensions	 g		EAN	€
01170110020	1170-11	1000 x 180 x 470 mm	7125	1	144581	auf Anfrage on request
01174110020	1174-11	630 x 180 x 470 mm	4750	1	310719	auf Anfrage on request

Lochtafelhaken

für Lochplattenwände
HEYCO 1170, 1171, 1174

Hooks

for perforated tool bars
HEYCO 1170, 1171, 1174

Crochets

de tablettes perforées
HEYCO 1170, 1171, 1174

Ganchos

para expositor
HEYCO 1170, 1171, 1174



1176-1

Standard-Hakensortimente • Ausstellung

Standard hook-assortment
for exhibition

Assortiment de crochets
standards pour l'exposition

Surtidos de ganchos standard
para exposición

Code		tlg. pcs.			EAN	€
01176000160	85 – 1177-1-1	115	4515	1	143102	auf Anfrage on request
	30 – 1179-1-1					



1176-2

Standard-Hakensortimente • Verkauf I

Standard hook-assortment
for selling I

Assortiment de crochets
standards pour la vente I

Surtidos de ganchos standard
para autoventa I

Code		tlg. pcs.			EAN	€
01176000260	70 – 1177-1-2	175	7805	1	143119	auf Anfrage on request
	25 – 1177-1-5					
	20 – 1178-1-2					
	20 – 1178-1-5					
	40 – 1179-1-2					



1176-3

Standard-Hakensortimente • Verkauf II

Standard hook-assortment
for selling II

Assortiment de crochets
standards pour la vente II

Surtidos de ganchos standard
para autoventa II

Code		tlg. pcs.			EAN	€
01176000360	20 – 1177-1-3	180	8500	1	143126	auf Anfrage on request
	20 – 1177-1-5					
	70 – 1178-1-3					
	70 – 1178-1-5					

1177-1-1 – 1177-2-4

Einfachklapphaken

Z = verzinkt Stahldraht

Single folding hooks

Z = zinc plated steel wire

Crochets rabattables simples

Z = galvanisé, bleu passivé. Fil d'acier

Ganchos plegables simples



Z = cincado, cromatizado azul
Alambre de acero



1177-1-1



1177-2-3

Code	No.	$\leftarrow L \rightarrow$ mm	\emptyset mm			EAN	€
01177100160	1177-1-1	50	4,8	39	10	143010	auf Anfrage on request
01177100260	1177-1-2	120	4,8	49	10	143027	
01177100360	1177-1-3	200	4,8	61	10	143034	
01177200360	1177-2-3	200	5,9	115	10	310801	
01177200460	1177-2-4	250	5,9	125	10	310832	

1177-1-5

Preisfahnen

St = standardmäßig
Kunststoff weiß, mit Metallschild
für Einfachklapphaken

Price tags

St = standard
plastic, white, with metalplate
for single folding hooks

Porte-étiquettes de prix

St = standard
Plastique blanc, avec plaquette métallique
pour crochets rabattables simples

Etiquetas de precios

St = estándar
Plástico blanco, con escudo metálico,
para ganchos plegables simples



Code	Beschriftungsfläche marking area mm	Ø mm			EAN	€
01177100500	27 x 42	4,8	7	10	143089	auf Anfrage on request

1178-1-2 - 1178-1-4

Doppelklapphaken

Z = verzinkt
Stahldraht

Double folding hooks

Z = zinc plated
steel wire

Crochets rabattables doubles

Z = galvanisé, bleu passivé.
Fil d'acier

Ganchos plegables dobles

Z = cincado, cromatizado azul
Alambre de acero



Code	No.	←L→ mm	Ø mm			EAN	€
01178100260	1178-1-2	120	4,8	78	10	143041	auf Anfrage on request
01178100360	1178-1-3	200	4,8	100	10	143058	
01178100460	1178-1-4	300	4,8	128	10	310849	

1178-1-5

Preisfahnen

St = standardmäßig
Kunststoff transparent
für Einfachklapphaken
1177-2-3 + 4
für Doppelklapphaken
1178-1-2 + 3 + 4

Price tags

St = standard
Plastic, transparent
for single folding hooks
1177-2-3 + 4
for double folding hooks
1178-1-2 + 3 + 4

Porte-étiquettes de prix

St = standard
Plastique transparent
pour crochets rabattables simples
1177-2-3 + 4
pour crochets rabattables doubles
1178-1-2 + 3 + 4

Etiquetas de precios

St = estándar
Plástico transparente
para ganchos plegables simples
1177-2-3 + 4
para ganchos plegables dobles
1178-1-2 + 3 + 4



Code	Beschriftungsfläche marking area mm	Ø mm			EAN	€
01178100500	27 x 42	4,8	2	10	143096	auf Anfrage on request

1179-1-1

Spezialhaken für Doppelmaulschlüssel

Z = verzinkt
Einzelhalter
(Verwendung paarweise horizontal)

Special hooks for
double ended open
jaw wrenches

Z = zinc plated
Single holder
(To be used horizontally in pairs)

Crochets spéciaux
pour clés à fourche

Z = galvanisé, bleu passivé
Support à outils simple
(Utilisation horizontale par paire)

Ganchos especiales
para llaves abiertas
de dos bocas

Z = cincado, cromatizado azul
Sujeción individual
(Uso por pares, horizontal)



Code	←L→ mm	∅ mm	g		EAN	€
01179100160	40	4,8	40	20	143065	auf Anfrage on request

1179-1-2

Spezialhaken für Doppelmaulschlüssel

Z = verzinkt
10-fach Halter
(Verwendung paarweise horizontal)

Special hooks for
double ended open
jaw wrenches

Z = zinc plated
10-fold holder
(To be used horizontally in pairs)

Crochets spéciaux
pour clés à fourche

Z = galvanisé, bleu passivé
Support pour 10 outils
(Utilisation horizontale par paire)

Ganchos especiales
para llaves abiertas
de dos bocas

Z = cincado, cromatizado azul
Sujeción para 10 piezas
(Uso por pares, horizontal)



Code	←L→ mm	∅ mm	g		EAN	€
01179100260	130	4,8	65	20	143072	auf Anfrage on request

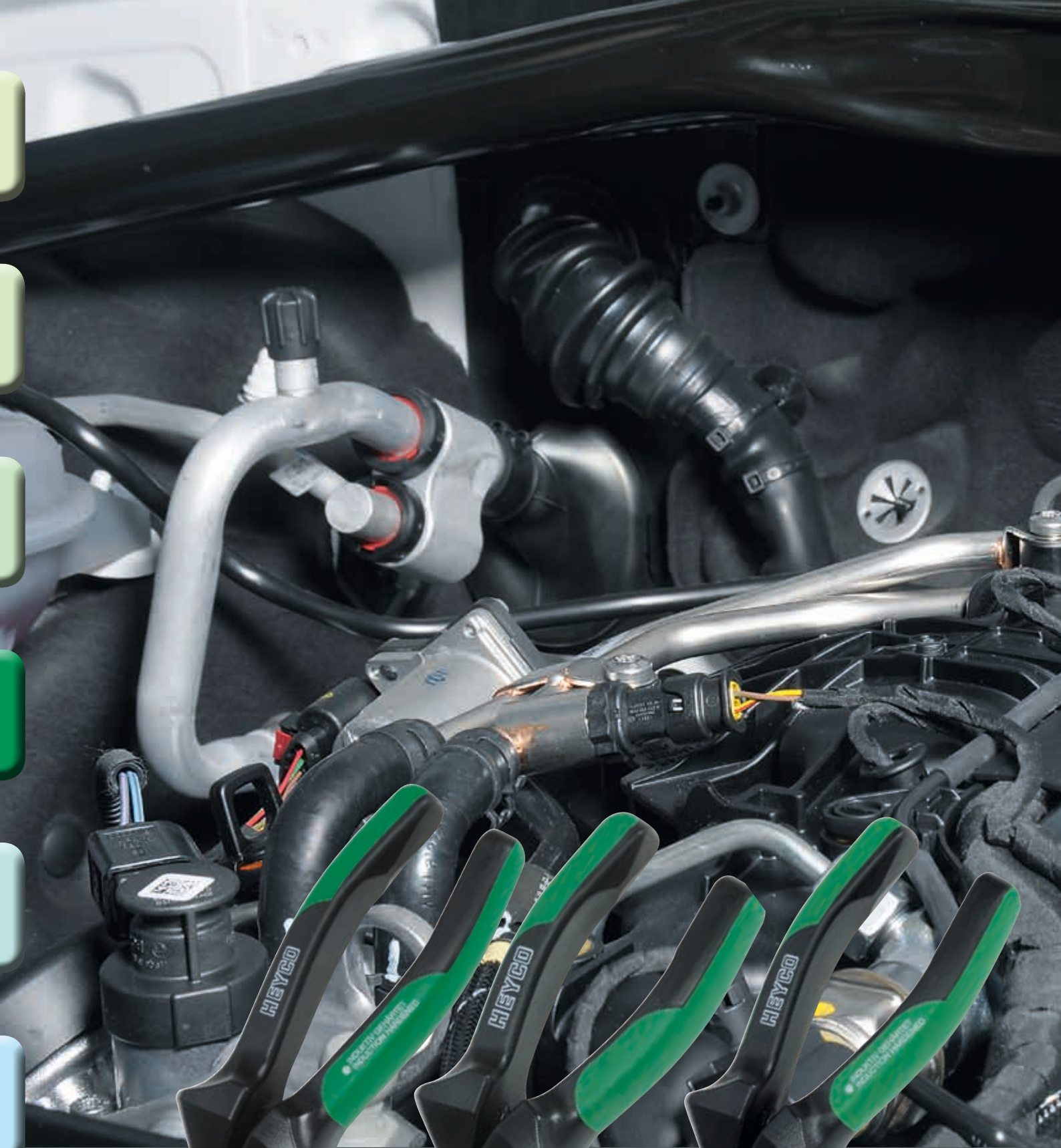



172-175



176-179



179



180



181-182



183-186



186-190



190-191



191

300

Greifzangen

DIN ISO 8976
Chrom-Vanadium
CP = verchromt, Kopf poliert
CPI = verchromt, Kopf poliert,
FORMEL plus Kunststoffgriffe mit
Abgleitschutz mit aufgelegtem
Gleitgelenk

Multigrip pliers

DIN ISO 8976
Chrome-Vanadium
CP = chromium plated, polished
head
CPI = chromium plated, polished
head, **FORMEL plus** plastic handle
with slip guard, with slip joint

Pincès multiprises

DIN ISO 8976
Chrome-Vanadium
CP = chromées, tête polie
CPI = chromées, tête polie, branches
FORMEL plus gainées plastique, antiglissant
charnière glissière

Tenazas de abertura múltiple

DIN ISO 8976
Cromo Vanadio
CP = cromado, cabeza pulida espejo
CPI = cromado, cabeza pulida espejo,
fundas de plástico **FORMEL plus** con tope
salvamanos unión simple



CP



CPI

Code	Ausf./finish	mm	←L→ "	g		EAN	€
00300024082	CP	240	9.1/2	275	1	008029	21,45
00300024086	CPI	240	9.1/2	350	1	008036	25,60

313

Greifzangen

DIN ISO 8976
Chrom-Vanadium
LS = lackiert, Kopf geschliffen
mit durchgestecktem Gleitgelenk

Multigrip pliers

DIN ISO 8976
Chrome-Vanadium
LS = lacquered, ground head
with box joint

Pincès multiprises

DIN ISO 8976
Chrome-Vanadium
LS = laquées, tête meulée
charnière entrepassée et glissière

Tenazas de abertura múltiple

DIN ISO 8976
Cromo Vanadio
LS = barnizado, cabeza amolada
unión machihembrada



Code	mm	←L→ "	g		EAN	€
00313017521	175	7	160	1	008142	24,75
00313024021	240	9.1/2	285	1	008166	29,15

315

Greifzangen

DIN ISO 8976
Chrom-Vanadium
CP = verchromt, Kopf poliert
CPI = verchromt, Kopf poliert,
FORMEL plus Kunststoffgriffe mit
Abgleitschutz, mit aufgelegtem
Doppelrillen-Gleitgelenk

Multigrip pliers

DIN ISO 8976
Chrome-Vanadium
CP = chromium plated, polished
head
CPI = chromium plated, polished
head, **FORMEL plus** plastic handle
with slip guard, with double
groove joint

Pincès multiprises

DIN ISO 8976
Chrome-Vanadium
CP = chromées, tête polie
CPI = chromées, tête polie, branches
FORMEL plus gainées plastique, antiglissant
charnière avec rainures de guidage
(double)

Tenazas de abertura múltiple

DIN ISO 8976
Cromo Vanadio
CP = cromado, cabeza pulida espejo
CPI = cromado, cabeza pulida espejo,
fundas de plástico **FORMEL plus** con tope
salvamanos, unión de cremallera doble



CP



CPI

Code	Ausf./finish	mm	←L→ "	g		EAN	€
00315024082	CP	240	9.1/2	374	1	008173	27,25
00315024086	CPI	240	9.1/2	453	1	008180	29,00

1200

Kombinationszangen

DIN ISO 5746

CPD = verchromt, Kopf poliert,
Griffe kunststoffbeschichtet
CPI = verchromt, Kopf poliert
formel plus Kunststoffgriffe mit
Abgleitschutz, mit Facetten, mit
zusätzlich induktiv gehärteten
Schneiden, für mittelharten Draht

Combination pliers

DIN ISO 5746

CPD = chromium plated, polished
head, plastic coated handles
CPI = chromium plated, polished
head, **formel plus** plastic handle
with slip guard, with facets, cutting
edges additionally induction
hardened, for middlehard wire

Pincés universelles, type «mécanicien»

DIN ISO 5746

CPD = chromées, tête polie,
branches gainées plastique
CPI = chromées, tête polie, branches
formel plus gainées plastique, antiglissant
avec facettes en biseau, trempage
complémentaire des tranchants par
induction pour fil de dureté moyenne

Alicates universales

DIN ISO 5746

CPD = cromado, cabeza pulida espejo,
mangos plastificados
CPI = cromado, cabeza pulida espejo,
fundas de plástico **formel plus** con tope
salvamanos, grafilados, cortantes
templados por inducción, para alambre
semi-duro



Code	Ausf. finish	←L→		∅ mm	g	mm	EAN	€
		mm	"					
01200016087	CPD	160	6.1/4	1,8	165	1	146899	25,10
01200018087	CPD	180	7	2,5	230	1	146882	27,80
01200020087	CPD	200	8	2,5	275	1	146875	30,90
01200016086	CPI	160	6.1/4	1,8	195	1	146844	26,50
01200018086	CPI	180	7	2,5	265	1	146851	29,20
01200020086	CPI	200	8	2,5	310	1	146868	32,55

1206

Flachzangen

DIN ISO 5745

CPD = verchromt, Kopf poliert,
Griffe kunststoffbeschichtet
CPI = verchromt, Kopf poliert,
formel plus Kunststoffgriffe mit
Abgleitschutz, mit langen Backen
und gezahnten Greifflächen

Flat nose pliers

DIN ISO 5745

CPD = chromium plated, polished
head, plastic coated handles
CPI = chromium plated, polished
head, **formel plus** plastic handle
with slip guard, with long serrated
jaws

Pincés à becs plats

DIN ISO 5745

CPD = chromées, tête polie,
branches gainées plastique
CPI = chromées, tête polie, branches
formel plus gainées plastique, antiglissant
à becs longs et surfaces de prise striées

Alicates boca plana larga

DIN ISO 5745

CPD = cromado, cabeza pulida espejo,
mangos plastificados
CPI = cromado, cabeza pulida espejo,
fundas de plástico **formel plus** con tope
salvamanos, bocas largas con dentado



Code	Ausf./finish	←L→		g	mm	EAN	€
		mm	"				
01206016087	CPD	160	6.1/4	120	1	146561	23,90
01206016086	CPI	160	6.1/4	135	1	023411	25,10

1207

Rundzangen

DIN ISO 5745

CPD = verchromt, Gelenk poliert,
Griffe kunststoffbeschichtet
CPI = verchromt, Gelenk poliert
formel plus Kunststoffgriffe mit
Abgleitschutz, mit langen Backen

Round nose pliers

DIN ISO 5745

CPD = chromium plated, joint area
polished, plastic coated handles
CPI = chromium plated, joint
area polished, **formel plus** plastic
handle, with slip guard, with long
jaws

Pincés à becs ronds

DIN ISO 5745

CPD = chromées, articulation meulée,
branches gainées plastique
CPI = chromées, articulation meulée,
branches **formel plus** gainées plastique,
antiglissant, avec becs longs

Alicates boca redonda larga

DIN ISO 5745

CPD = cromado, cabeza pulida espejo,
mangos plastificados
CPI = cromado, cabeza pulida espejo,
fundas de plástico **formel plus** con tope
salvamanos, bocas largas



Code	Ausf./finish	←L→		g	mm	EAN	€
		mm	"				
01207016087	CPD	160	6.1/4	105	1	146585	23,90
01207016086	CPI	160	6.1/4	130	1	023459	25,10

1208

Flachrundzangen, gerade

DIN ISO 5745

CPD = verchromt, Kopf poliert, Griffe kunststoffbeschichtet
CPI = verchromt, Kopf poliert, **FORMEL plus** Kunststoffgriffe mit Abgleitschutz, mit zusätzlich induktiv gehärteten Schneiden, mit langen Backen und gezahnten Greifflächen, mit gezahnter Aussparung, für mittelharten Draht

Snipe nose pliers, straight

DIN ISO 5745

CPD = chromium plated, polished head, plastic coated handles
CPI = chromium plated, polished head, **FORMEL plus** plastic handle with slip guard, with cutting edges additionally induction hardened, with long serrated jaws, with serrated pipe grip



Pincès à becs demi-ronds, droits



DIN ISO 5745

CPD = chromées, tête polie, branches gainées plastique
CPI = chromées, tête polie, branches **FORMEL plus** gainées plastique, antiglissant avec trempage complémentaire des tranchants par induction, avec becs longs et surfaces de prise striées, avec serre-tube, code présentation Ø pour fil de dureté moyenne

Alicates boca semirredonda, recta

DIN ISO 5745

CPD = cromado, cabeza pulida espejo, mangos plastificados
CPI = cromado, cabeza pulida espejo, fundas de plástico **FORMEL plus** con tope salvamanos, cortantes templados por inducción, para alambre semi-duro, bocas largas con dentado

Code	Ausf. finish	←L→		 Ø mm	 g		EAN	€
		mm	"					
01208014087	CPD	140	5.1/2	1,6	100	1	146707	27,60
01208016087	CPD	160	6.1/4	1,6	110	1	146691	29,25
01208020087	CPD	200	8	1,8	160	1	146684	32,55
01208014086	CPI	140	5.1/2	1,6	120	1	146738	29,10
01208016086	CPI	160	6.1/4	1,6	135	1	146721	30,90
01208020086	CPI	200	8	1,8	190	1	023565	34,10

1209

Flachrundzangen, 45° abgewinkelt

DIN ISO 5745

CPD = verchromt, Kopf poliert, Griffe kunststoffbeschichtet
CPI = verchromt, Kopf poliert, **FORMEL plus** Kunststoffgriffe mit Abgleitschutz, mit zusätzlich induktiv gehärteten Schneiden, mit langen Backen und gezahnten Greifflächen, mit gezahnter Aussparung, für mittelharten Draht

Snipe nose pliers, 45° angle

DIN ISO 5745

CPD = chromium plated, polished head, plastic coated handles
CPI = chromium plated, polished head, **FORMEL plus** plastic handle with slip guard, with cutting edges additionally induction hardened, with long serrated jaws, with serrated pipe grip



Pincès à becs demi-ronds, coudés à 45°



DIN ISO 5745

CPD = chromées, tête polie, branches gainées plastique
CPI = chromées, tête polie, branches **FORMEL plus** gainées plastique, antiglissant avec trempage complémentaire des tranchants par induction, avec becs longs et surfaces de prise striées, avec serre-tube, pour fil de dureté moyenne

Alicates boca semirredonda, curva a 45°

DIN ISO 5745

CPD = cromado, cabeza pulida espejo, mangos plastificados
CPI = cromado, cabeza pulida espejo, fundas de plástico **FORMEL plus** con tope salvamanos, cortantes templados por inducción, para alambre semi-duro, bocas largas con dentado

Code	Ausf. finish	←L→		 Ø mm	 g		EAN	€
		mm	"					
01209020087	CPD	200	8	1,8	160	1	146806	34,55
01209020086	CPI	200	8	1,8	190	1	023619	36,20

1212

Kraftseitenschneider

DIN ISO 5749

CPD = verchromt, Kopf poliert, Griffe kunststoffbeschichtet
CPI = verchromt, Kopf poliert, **FORMEL plus** Kunststoffgriffe mit Abgleitschutz, Schneiden zusätzlich induktiv gehärtet, für harten Draht (Piano-Draht)

Diagonal cutting nippers

DIN ISO 5749

Special steel
CPD = chromium plated, polished head, plastic coated handles
CPI = chromium plated, polished head, **FORMEL plus** plastic handle with slip guard, cutting edges additionally induction hardened, for piano wire



Pincès coupantes diagonales



DIN ISO 5749

Acier spécial
CPD = chromées, tête polie, branches gainées plastique
CPI = chromées, tête polie, branches **FORMEL plus** gainées plastique, antiglissant avec trempage complémentaire des tranchants par induction, pour fil dur (corde à piano)

Alicates cortalambres, corte diagonal, modelo reforzado

DIN ISO 5749

Acero especial
CPD = cromado, cabeza pulida espejo, mangos plastificados
CPI = cromado, cabeza pulida espejo, fundas de plástico **FORMEL plus** con tope salvamanos, cortantes templados por inducción, para alambre duro (cuerda de piano)

Code	Ausf. finish	←L→		 Ø mm	 g		EAN	€
		mm	"					
01212014087	CPD	140	5.1/2	1,8	115	1	146769	30,75
01212016087	CPD	160	6.1/4	2,0	160	1	146752	33,05
01212020087	CPD	200	8	2,5	295	1	146745	41,15
01212014086	CPI	140	5.1/2	1,8	140	1	146776	32,40
01212016086	CPI	160	6.1/4	2,0	195	1	146783	34,85
01212020086	CPI	200	8	2,5	345	1	023831	43,20

1213

Seitenschneider, schwedische Form

DIN ISO 5749

CPD = verchromt, Kopf poliert, Griffe kunststoffbeschichtet

CPI = verchromt, Kopf poliert, **formel plus** Kunststoffgriffe mit Abgleitschutz, Schneiden zusätzlich induktiv gehärtet, für mittelharten Draht

Diagonal cutting nippers,
swedish pattern

DIN ISO 5749

CPD = chromium plated, polished head, plastic coated handles

CPI = chromium plated, polished head, **formel plus** plastic handle with slip guard, cutting edges additionally induction hardened, for middlehard wire

Pinces coupantes diagonales,
modèle suédois

DIN ISO 5749

CPD = chromées, tête polie, branches gainées plastique

CPI = chromées, tête polie, branches **formel plus** gainées plastique, antiglissant, avec trempage complémentaire des tranchants par induction, pour fil dur

Alicates cortalambres, corte
diagonal, modelo sueco

DIN ISO 5749

CPD = cromado, cabeza pulida espejo, mangos plastificados



CPI = cromado, cabeza pulida espejo, fundas de plástico **formel plus** con tope salvamanos, cortantes templados por inducción, para alambre semi-duro



CPD



CPI

Code	Ausf. finish	←L→			∅ mm			EAN	€
		mm	"						
01213012587	CPD	125	5		1,5	90	1	146660	29,35
01213014087	CPD	140	5.1/2		1,8	120	1	146653	31,75
01213016087	CPD	160	6.1/4		2,0	165	1	146646	33,80
01213012586	CPI	125	5		1,5	110	1	146639	30,95
01213014086	CPI	140	5.1/2		1,8	150	1	146622	33,50
01213016086	CPI	160	6.1/4		2,0	205	1	023930	35,65

1215

Kraftvorschneider

DIN ISO 5748

Spezialstahl
CPD = verchromt, Kopf poliert, Griffe kunststoffbeschichtet

CPI = verchromt, Kopf poliert, **formel plus** Kunststoffgriffe mit Abgleitschutz, Schneiden zusätzlich induktiv gehärtet, für harten Draht (Piano-Draht)

End cutting nippers

DIN ISO 5748

Special steel
CPD = chromium plated, polished head, plastic coated handles

CPI = chromium plated, polished head, **formel plus** plastic handle with slip guard, cutting edges additionally induction hardened, for piano wire

Pinces coupantes devant

DIN ISO 5748

Acier spécial
CPD = chromées, tête polie, branches gainées plastique

CPI = chromées, tête polie, branches **formel plus** gainées plastique, antiglissant avec trempage complémentaire des tranchants par induction, pour fil dur (corde à piano)

Alicates cortalambres,
corte frontal

DIN ISO 5748

Acero especial
CPD = cromado, cabeza pulida espejo, mangos plastificados



CPI = cromado, cabeza pulida espejo, fundas de plásticos **formel plus** con tope salvamanos, cortantes templados por inducción, para alambre duro (cuerda de piano)



CPD



CPI

Code	Ausf. finish	←L→			∅ mm			EAN	€
		mm	"						
01215016087	CPD	160	6.1/4		2,2	170	1	146790	37,00
01215016086	CPI	160	6.1/4		2,2	205	1	023985	39,00

1220

Abisolierzange

CPI = verchromt, Kopf poliert,

formel plus Kunststoffhüllen mit Abgleitschutz, mit Stellschraube und Öffnungsfeder

Wire stripping plier

CPI = chromium plated, polished head,

formel plus plastic handle with slip guard, with adjusting screw and spring

Pinces à dénuder

CPI = chromées, tête polie, branches



formel plus gainées plastique, antiglissant avec vis de réglage de butée et ressort d'ouverture

Alicates pelacables

CPI = cromado, cabeza pulida espejo,

fundas de plástico **formel plus** con tope salvamanos, con tornillo de ajuste y muelle de apertura



Code	mm	←L→			∅ mm			EAN	€
		mm	"						
01220016086	160		6.1/4		1,1 - 4,8	180	1	024081	24,40



Sicherheitswerkzeuge

Insulated safety tools

Outils de sécurité

Herramientas de seguridad

1000 Volt/IEC 900/DIN EN 60900/VDE 0682 Teil 201

1000 Volt/IEC 900/DIN EN 60900/VDE 0682 part 201

1000 Volt/IEC 900/DIN EN 60900/VDE 0682 paragraphe 201

1000 Volt/IEC 900/DIN EN 60900/VDE 0682 apartado 201

1200

VDE Kombinationszangen

VDE Combination pliers

VDE Pincers universelles, type «mécanicien»

VDE Alicates universales

DIN ISO 5746
CPV = verchromt, Kopf poliert, **formel plus** Isoliergriffhüllen IEC 900/DIN EN 60900/VDE 0682 Teil 201, Schneiden zusätzlich induktiv gehärtet, für mittelharten Draht

DIN ISO 5746
CPV = chromium plated, polished head, **formel plus** VDE insulated handles IEC 900/DIN EN 60900/VDE 0682 part 201, Cutting edges additionally induction hardened, for middlehard wire

DIN ISO 5746
CPV = chromées, tête polie, branches **formel plus** gaines isolées IEC 900/DIN EN 60900/VDE 0682 paragraphe 201, avec trempage complémentaire des franchants par induction, pour fil dur

DIN ISO 5746
CPV = cromado, cabeza pulida espejo, fundas aislantes **formel plus** según IEC 900/DIN EN 60900/VDE 0682 apartado 201, cortantes templados por inducción, para alambre semi-duro



Code	←L→		∅	g	g	EAN	€
	mm	"	mm				
01200016088	160	6.1/4	1,8	200	1	146837	36,35
01200018088	180	7	2,5	275	1	146820	41,70
01200020088	200	8	2,5	320	1	146813	47,10

1206

VDE Flachzange

VDE Long flat nose plier

VDE Pincers à becs plats

VDE Alicates boca plana larga

DIN ISO 5745
CPV = verchromt, Kopf poliert, **formel plus** Isoliergriffhüllen IEC 900/DIN EN 60900/VDE 0682 Teil 201, mit langen Backen und gezahnten Greifflächen

DIN ISO 5745
CPV = chromium plated, polished head, **formel plus** VDE insulated handles IEC 900/DIN EN 60900/VDE 0682 part 201 with long serrated jaws

DIN ISO 5745
CPV = chromées, tête polie, branches **formel plus** gaines isolées IEC 900/DIN EN 60900/VDE 0682 paragraphe 201, à becs longs et surfaces de prise striées

DIN ISO 5745
CPV = cromado, cabeza pulida espejo, fundas aislantes **formel plus** según IEC 900/DIN EN 60900/VDE 0682 apartado 201, bocas largas con dentado



Code	mm	←L→	"	g	g	EAN	€
01206016088	160		6.1/4	140	1	146554	39,10

1207

VDE Rundzangen

VDE Long round nose plier

VDE Pincers à becs plats

VDE Alicates boca redonda larga

DIN ISO 5745
CPV = verchromt, Kopf poliert, **formel plus** Isoliergriffhüllen IEC 900/DIN EN 60900/VDE 0682 Teil 201, mit langen Backen

DIN ISO 5745
CPV = chromium plated, polished head, **formel plus** VDE insulated handles IEC 900/DIN EN 60900/VDE 0682 part 201, with long jaws

DIN ISO 5745
CPV = chromées, tête polie, branches **formel plus** gaines isolées IEC 900/DIN EN 60900/VDE 0682 paragraphe 201 avec becs longs

DIN ISO 5745
CPV = cromado, cabeza pulida espejo, fundas aislantes **formel plus** según IEC 900/DIN EN 60900/VDE 0682 apartado 201 bocas largas



Code	mm	←L→	"	g	g	EAN	€
01207016088	160		6.1/4	135	1	146578	39,30

1208

VDE Flachrundzangen, gerade

DIN ISO 5745
CPV = verchromt, Kopf poliert,
formel plus Isoliergriffhüllen
IEC 900/DIN EN 60900/VDE 0682
Teil 201, mit zusätzlich induktiv
gehärteten Schneiden, mit langen
Backen und gezahnten Greifflächen,
mit gezahnter Aussparung, für
mittelharten Draht

VDE Snipe nose pliers,
straight

DIN ISO 5745
CPV = chromium plated, polished
head, **formel plus** VDE insulated
handles, IEC 900/DIN EN
60900/VDE 0682 part 201
with cutting edges additionally
induction hardened
with long serrated jaws, with
serrated pipe grip



VDE Pincès à becs demi-ronds,
droits

DIN ISO 5745
CPV = chromées, tête polie, branches
formel plus gaines isolées, IEC 900/DIN
EN 60900/VDE 0682 paragraphe 201
avec trempage complémentaire des
tranchants par induction, avec becs longs et
surfaces de prise striées, avec serre-tube,
pour fil de dureté moyenne

VDE Alicates boca
semirredonda, recta

DIN ISO 5745
CPV = cromado, cabeza pulida espejo,
fundas aislantes **formel plus**
según IEC 900/DIN EN 60900/
VDE 0682 apartado 201
cortantes templados por inducción, para
alambre semi-duro
bocas largas con dentado



Code	←L→			Ø mm			EAN	€
	mm	"						
01208016088	160	6.1/4		1,6	140	1	146714	43,10
01208020088	200	8		1,8	200	1	023572	47,30



1209

VDE Flachrundzange, 45° abgewinkelt

DIN ISO 5745
CPV = verchromt, Kopf poliert,
formel plus Isoliergriffhüllen
IEC 900/DIN EN 60900/VDE 0682
Teil 201
mit zusätzlich induktiv gehärteten
Schneiden, mit langen Backen
und gezahnten Greifflächen,
mit gezahnter Aussparung, für
mittelharten Draht

VDE Snipe nose plier,
45° angle

DIN ISO 5745
CPV = chromium plated, polished
head, **formel plus** VDE insulated
handles
IEC 900/DIN EN 60900/
VDE 0682 part 201
with cutting edges additionally
induction hardened
with long serrated jaws, with
serrated pipe grip



VDE Pincès à becs demi-ronds,
coudés à 45°

DIN ISO 5745
CPV = chromées, tête polie, branches
formel plus gaines isolées
IEC 900/DIN EN 60900/VDE 0682
paragraphe 201
avec trempage complémentaire des
tranchants par induction, avec becs longs et
surfaces de prise striées, avec serre-tube,
pour fil de dureté moyenne

VDE Alicates boca
semirredonda,
curva a 45° cortante

DIN ISO 5745
CPV = cromado, cabeza pulida espejo,
fundas aislantes **formel plus**
según IEC 900/DIN EN 60900/
VDE 0682 apartado 201
cortantes templados por inducción, para
alambre semi-duro
bocas largas con dentado



Code	←L→			Ø mm			EAN	€
	mm	"						
01209020088	200	8		1,8	200	1	023626	49,35



1213

VDE Seitenschneider, schwedische Form

DIN ISO 5749
CPV = verchromt, Kopf poliert,
formel plus Isoliergriffhüllen
IEC 900/DIN EN 60900/
VDE 0682 Teil 201, Schneiden
zusätzlich induktiv gehärtet, für
mittelharten Draht

VDE Diagonal cutting
nippers, swedish pattern

DIN ISO 5749
CPV = chromium plated, polished
head, **formel plus** VDE insulated
handles, IEC 900/DIN EN 60900/
VDE 0682 part 201, Cutting edges
additionally induction hardened, for
middlehard wire



VDE Pincès coupantes
diagonales, modèle suédois

DIN ISO 5749
CPV = chromées, tête polie, branches
formel plus gaines isolées
IEC 900/DIN EN 60900/VDE 0682
paragraphe 201, avec trempage
complémentaire des franchants par
induction, pour fil dur

VDE Alicates cortalambres,
corte diagonal, modelo sueco

DIN ISO 5749
CPV = cromado, cabeza pulida espejo,
fundas aislantes **formel plus**
según IEC 900/DIN EN 60900/
VDE 0682 apartado 201, cortantes
templados por inducción, para alambre
semi-duro



Code	←L→			Ø mm			EAN	€
	mm	"						
01213014088	140	5.1/2		1,8	155	1	146615	40,95
01213016088	160	6.1/4		2,0	215	1	146608	44,35
01213018088	180	7		2,5	280	1	146592	47,45



1220

VDE Abisolierzange

CPV = verchromt, Kopf poliert,
formel plus Isoliergriffhüllen
IEC 900/DIN EN 60900/VDE 0682
Teil 201
mit Stellschraube und Öffnungsfeder

VDE Wire stripping plier

CPV = chromium plated, polished
head, **formel plus** VDE insulated
handles
IEC 900/DIN EN 60900/
VDE 0682 part 201
with adjusting screw and spring



VDE Pincès à dénuder

CPV = chromées, tête polie, branches
formel plus gaines isolées
IEC 900/DIN EN 60900/VDE 0682
paragraphe 201
avec vis de réglage de butée et ressort
d'ouverture

VDE Alicates pelacables

CPV = cromado, cabeza pulida espejo,
fundas aislantes **formel plus**
según IEC 900/DIN EN 60900/
VDE 0682 apartado 201
con tornillo de ajuste y muelle de apertura

Code	←L→ mm	"	 mm	∅ mm	 g	 1	EAN	€
01220016088	160	6.1/4	1,1 – 4,8	185	1	024098	41,25	

49-5

VDE-Elektriker Werkzeug-Garnitur

Modern as Design, klein der Raum,
groß der Inhalt.
Die kompakt und modern
gestaltete Box aus Polypropylen
ist stoßunempfindlich, schlagfest,
temperatur-, öl-, säure- und
benzinbeständig.
Inhalt nach IEC 900/DIN EN
60900/VDE 0682 Teil 201.
Kunststoffbox 370 x 270 x 56 mm

VDE Electricians tool-set

Modern in design, space-saving,
with a large assortment of first class
quality tools.
The compact and modern styled
box, which is manufactured from
polypropylene is shock-proof,
resistant to impact, temperature,
oil, acid and petrol.
Contents with IEC 900/DIN
EN 60900/VDE 0682 part
201 certification.
Plastic box 370 x 270 x 56 mm

VDE Composition d'outils VDE pour électricien

Moderne par son design, modeste par son
encombrement, large et complet
par sa composition. Ce coffret compact et
moderne, en polypropylène, est insensible
aux chocs, résistant aux variations de
température, aux huiles, aux acides et à
l'essence. Contenu conforme aux tests EN.
Coffret en matière plastique
370 x 270 x 56 mm

Conjunto de herramientas para electricista VDE

Diseno moderno, volumen reducido,
contenido amplio.
El maletín compacto y moderno resiste
golpes, calor, aceite,
ácido y gasolina.
Contenido según norma IEC 900/DIN EN
60900/VDE 0682 apartado 201.
Maletín de plástico 370 x 270 x 56 mm



Code	tfg. pcs.	Maße dimensions	 g	 1	EAN	€
00049000500	9	370 x 270 x 56 mm	1520	1	002188	209,50

enthaltend/containing

Stk. pcs.	Artikel/article	No.	Maße/dimensions
1		1208 VDE CPV	160 mm
1		1213 VDE CPV	140 mm
1		1220 VDE CPV	160 mm
2		1411 VDE BV	PH No. 1 2
1		1427 VDE ST	65 x 3 mm
3		1436 VDE BV	75 x 2,5 100 x 4 125 x 5,5 mm



1052

VDE Elektriker Rucksack

- Breite Trageriemen und Rücken gepolstert
- Übersichtliches Ordnungssystem
- Kunststoffbox für Kleinteile

VDE Electricians backpack

- Wide straps and padded back
- Well organization system
- Plastic box for parts

Sac à dos électricien VDE

- Large bretelles et dos rembourré
- Organisation clair
- Boîtier plastique pour les petites pièces

Mochila para electricistas VDE

- Anchas correas, espalda acolchada
- Sistema de ordenamiento racional
- Caja de plástico para piecero



Code	tlg./pcs.			EAN	€
01052001000	14	3005	1	362213	351,55

enthaltend/containing

Stck. pcs.	Artikel/article	No.	Maße/size
1		1208 VDE CPV	200 mm
1		1200 VDE CPV	180 mm
1		1213 VDE CPV	160 mm
1		1220 VDE CPV	160 mm
2		1427 VDE BV	PH No. 2
4		1436 VDE BV	75 x 2,5 100 x 4 125 x 5,5 150 x 6,5mm
1		1427 VDE	60 x 3 150-250V
1		1920	10 m
1		1426 VDE	12-750V

Rucksack, leer/Backpack, empty:

Code	tlg./pcs.			EAN	€
01052000000	1	1300	1	362121	96,95

1230

Bremsfederzange

Chrom-Vanadium
N = vernickelt
speziell für aufgenietete Bremsbeläge

Brake spring plier

Chrome-Vanadium
N = nickel plated
particularly for riveted brake linings

Pincès à ressorts de freins

Chrome-Vanadium
N = nickelées
spéciales pour garnitures de freins rivetées

Tenazas para muelles de frenos

Cromo Vanadio
N = niquelado
especial para ferodos remachados

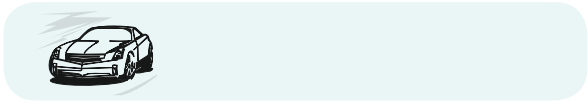

Code	mm				EAN	€
01230021550	215	8.1/2	242	1	024159	24,80

1231

Bremsfederzange

Chrom-Vanadium
NI = vernickelt, mit Kunststoffhüllen
mit beweglichem Stützkopf, speziell für geklebte Bremsbeläge

Brake spring plier

Chrome-Vanadium
NI = nickel plated, insulated
with swivel head, particularly for bonded brake linings

Pincès à ressorts de freins

Chrome-Vanadium
NI = nickelées, branches gainées plastique
avec coupelle à rotule, spéciales pour garnitures de freins encollées

Tenazas para muelles de frenos

Cromo Vanadio
NI = niquelado, con fundas de plástico
con rótula, especial para ferodos pegados



Code	mm				EAN	€
01231034055	340	13.1/4	480	1	145847	59,30

1232

Spannzange für Achsmanschetten und Schlauchklemmen

zum Verkleben von Spannbändern für Achsmanschetten und Schläuche passend für Stahl und Edelstahl-schellen, Gewichtsoptimiert durch hochfestes Luftfahrtaluminium gehärtete Spannbacken, einfaches Einstellen des vorgeschriebenen Drehmoments über den 3/8" - Antrieb mit Hilfe eines Drehmomentschlüssels, Griff aus leicht abwaschbarem Kunststoff max. Öffnungsweite: 45 mm

Tongs for axle collars and hose clamps

for clamping of fastener straps of axle collars and hoses, suitable for steel- and stainless steel-clamps optimized weight through high-tensile aircraft aluminium hardened clamping jaws simple setting of the required torque through the 3/8" - drive by means of torque wrench handle made of easily washable plastic max. opening width: 45 mm

Pince pour durites et colliers de serrage de l'axe de transmission

pour fixer les colliers de serrage, les axes et les flexibles, appropriés pour les colliers de serrage en acier et inox, Réduction du poids grâce à l'aluminium aéronautique à haute résistance, mâchoires trempées Réglage facile du couple de serrage conseillé au moyen du carré d'entraînement de 3/8" Poignée en plastique facilement lavable Ouverture max.: 45 mm

Pinzas tensoras para manguitos axiales y presillas para tubos flexibles

para aprisionar cintas de sujeción para los manguitos axiales y tubos flexibles adecuadas para abrazaderas de acero y acero inoxidable, Optimizadas en peso gracias al aluminio aeronáutico de alta resistencia, mordaza tensora endurecida Ajuste sencillo del par prescrito gracias a la transmisión 3/8" con ayuda de una llave dinamométrica de par Empuñadura de plástico fácilmente lavable máx. abertura 45 mm



Code	mm	←L→ "	Nm			EAN	€
01232027500	280	11	max. 30	596	1	374667	64,00

1233

Auswuchtgewichtzange

Chrom-Vanadium
C = verchromt
zum Befestigen, Lösen,
Verschieben und Zuschneiden von
Auswuchtgewichten,
zum Anpassen der Haltefedern

Balancing weight plier

Chrome-Vanadium
C = chromium plated
for fixing, loosening, shifting and
cutting of balancing weights,
for adjusting the clamping springs

Pince pour plombs d'équilibrage de roues

Chrome-Vanadium
C = chromées
pour monter, desserrer, déplacer et couper
des masses d'équilibrage aux pinces à
ressort

Tenaza para pesos de compensación

Cromo Vanadio
C = cromado
para fijar, aflojar, desplazar y recortar
pesos de compensación,
para ajustar los muelles de sujeción



Code	mm	←L→ "			EAN	€
01233025080	260	10.1/4	419	1	375671	24,50



1250

Zangen für Sicherungsringe, gerade

DIN 5254 A
Chrom-Vanadium
ASD = schwarz, Gelenk geschliffen, Griffe kunststoffbeschichtet
CPD = verchromt, Gelenk poliert, Griffe kunststoffbeschichtet mit geraden Backen, Spitzen schwarz, für Außen-Sicherungsringe (Wellen) nach DIN 471 + 983

Circlip pliers, straight

DIN 5254 A
Chrome-Vanadium
ASD = black, joint area polished, plastic coated handles
CPD = chromium plated, joint area polished, plastic coated handles with straight jaws, black points for external circlips (shafts) to DIN 471 + 983

Pinces pour circlips, droites

DIN 5254 A
Chrome-Vanadium
ASD = bruni, articulation meulée, branches gainées plastique
CPD = chromées, articulation polie, branches gainées plastique à bords droits, pointes brunies pour circlips extérieurs selon DIN 471 + 983

Tenaza para pesos de compensación

DIN 5254 A
Cromo Vanadio
ASD = fosfatados, unión amolada, mangos plastificados
CPD = cromados, unión pulida, mangos plastificados bocas rectas, puntas negras para arandelas exteriores según DIN 471 + 983

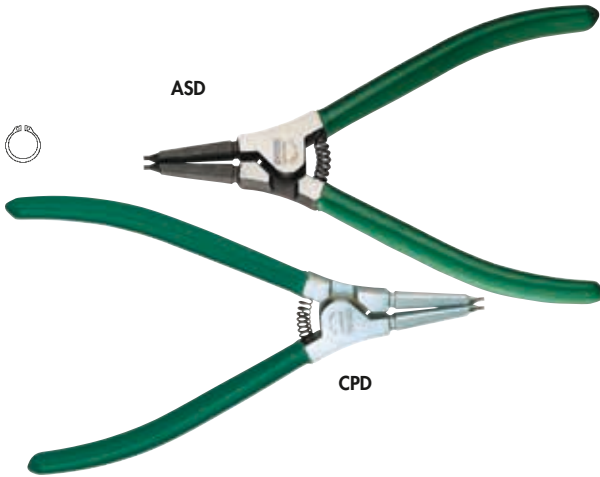

Code	Ausf. finish	Größe size	←L→ mm "		für for mm	g		EAN	€
01250114013	ASD	A3	140	5.1/2	3 – 10	90	1	147094	24,55
01250214013	ASD	A10	140	5.1/2	10 – 25	90	1	147087	22,00
01250017513	ASD	A19	175	7	19 – 60	175	1	147070	26,80
01250022013	ASD	A40	220	8.3/4	40 – 100	260	1	147063	32,30
01250030013	ASD	A85	300	11.3/4	85 – 140	490	1	147056	50,30
01250214087	CPD	A10	140	5.1/2	10 – 25	90	1	147131	26,25
01250017587	CPD	A19	175	7	19 – 60	175	1	147124	29,00
01250022087	CPD	A40	220	8.3/4	40 – 100	260	1	147117	35,60
01250030087	CPD	A85	300	11.3/4	85 – 140	490	1	147100	57,85

1252

Zangen für Sicherungsringe, gewinkelt

DIN 5254 B
Chrom-Vanadium
ASD = schwarz, Gelenk geschliffen, Griffe kunststoffbeschichtet
CPD = verchromt, Gelenk poliert, Griffe kunststoffbeschichtet mit gewinkelten Backen, Spitzen schwarz, für Außen-Sicherungsringe (Wellen) nach DIN 471 + 983

Circlip pliers, bent

DIN 5254 B
Chrome-Vanadium
ASD = black, joint area polished, plastic coated handles
CPD = chromium plated, joint area polished, plastic coated handles with bent jaws, black points for external circlips (shafts) to DIN 471 + 983

Pinces pour circlips, coudées

DIN 5254 B
Chrome-Vanadium
ASD = bruni, articulation meulée, branches gainées plastique
CPD = chromées, articulation polie, branches gainées plastique à bords coudés, pointes brunies pour circlips extérieurs selon DIN 471 + 983

Alicates para arandelas, curvos

DIN 5254 B
Cromo-Vanadio
ASD = fosfatados, unión amolada, mangos plastificados
CPD = cromados, unión pulida, mangos plastificados bocas curvas, puntas negras para arandelas exteriores según DIN 471 + 983

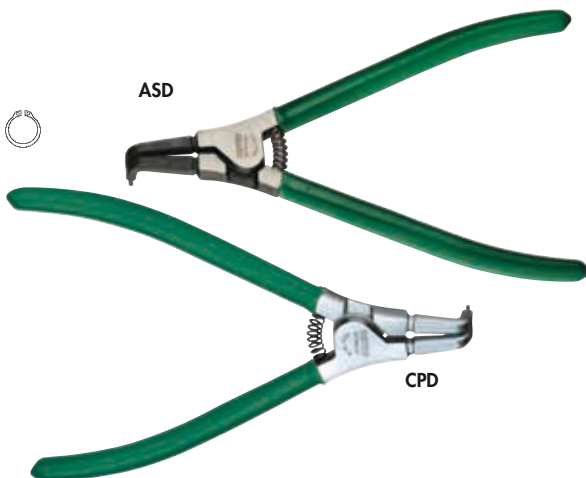

Code	Ausf. finish	Größe size	←L→ mm "		für for mm	g		EAN	€
01252113013	ASD	B3	130	5.1/4	3 – 10	90	1	147223	26,85
01252213013	ASD	B10	130	5.1/4	10 – 25	90	1	147216	24,25
01252016513	ASD	B19	165	6.1/2	19 – 60	175	1	147209	26,80
01252020513	ASD	B40	205	8	40 – 100	260	1	147193	32,30
01252027513	ASD	B85	275	10.3/4	85 – 140	490	1	147186	54,25
01252213087	CPD	B10	130	5.1/4	10 – 25	90	1	147179	28,30
01252016587	CPD	B19	165	6.1/2	19 – 60	175	1	147162	31,30
01252020587	CPD	B40	205	8	40 – 100	260	1	147155	38,25
01252027587	CPD	B85	275	10.3/4	85 – 140	490	1	147148	61,45

1255

Zangen für Sicherungsringe, gerade

DIN 5256 C
Chrom-Vanadium
ASD = schwarz, Gelenk geschliffen, Griffe kunststoffbeschichtet
CPD = verchromt, Gelenk poliert, Griffe kunststoffbeschichtet mit geraden Backen, Spitzen schwarz, für Innen-Sicherungsringe (Bohrungen) nach DIN 472 + 984

Circlip pliers, straight

DIN 5256 C
Chrome-Vanadium
ASD = black, joint area polished, plastic coated handles
CPD = chromium plated, joint area polished, plastic coated handles with straight jaws, black points for internal circlips (bore holes) to DIN 472 + 984

Pincès pour circlips, droites

DIN 5256 C
Chrom-Vanadium
ASD = bruni, articulation meulée, branches gainées plastique
CPD = chromées, articulation polie, branches gainées plastique à bords droits, pointes brunies pour circlips intérieurs selon DIN 472 + 984

Alicates para arandelas, rectos

DIN 5256 C
Cromo-Vanadio
ASD = fosfatados, unión amolada, mangos plastificados
CPD = cromados, unión pulida, mangos plastificados bocas rectas, puntas negras para arandelas interiores según DIN 472 + 984



Code	Ausf. finish	Größe size	←L→		für for	mm	g	mm	EAN	€
			mm	"						
01255114513	ASD	C8	145	5.3/4	8 - 13	90	1	147353	20,25	
01255214513	ASD	C12	145	5.3/4	12 - 25	90	1	147346	20,25	
01255018013	ASD	C19	180	7	19 - 60	175	1	147339	23,80	
01255023013	ASD	C40	230	9	40 - 100	260	1	147322	30,65	
01255031013	ASD	C85	310	12.1/4	85 - 140	490	1	147315	49,30	
01255214587	CPD	C12	145	5.3/4	12 - 25	90	1	147308	24,80	
01255018087	CPD	C19	180	7	19 - 60	175	1	147292	28,30	
01255023087	CPD	C40	230	9	40 - 100	260	1	147285	36,00	
01255031087	CPD	C85	310	12.1/4	85 - 140	490	1	147278	55,95	

1256

Zangen für Sicherungsringe, gewinkelt

DIN 5256 D
Chrom-Vanadium
ASD = schwarz, Gelenk geschliffen, Griffe kunststoffbeschichtet
CPD = verchromt, Gelenk poliert, Griffe kunststoffbeschichtet mit gewinkelten Backen, Spitzen schwarz, für Innen-Sicherungsringe (Bohrungen) nach DIN 472 + 984

Circlip pliers, bent

DIN 5256 D
Chrome-Vanadium
ASD = black, joint area polished, plastic coated handles
CPD = chromium plated, joint area polished, plastic coated handles with bent jaws, black points for internal circlips (bore holes) to DIN 472 + 984

Pincès pour circlips, coudées

DIN 5256 D
Chrom-Vanadium
ASD = bruni, articulation meulée, branches gainées plastique
CPD = chromées, articulation polie, branches gainées plastique à bords coudés, pointes brunies pour circlips intérieurs selon DIN 472 + 984

Alicates para arandelas, curvos

DIN 5256 D
Cromo-Vanadio
ASD = fosfatados, unión amolada, mangos plastificados
CPD = cromados, unión pulida, mangos plastificados bocas curvas, puntas negras para arandelas interiores según DIN 472 + 984

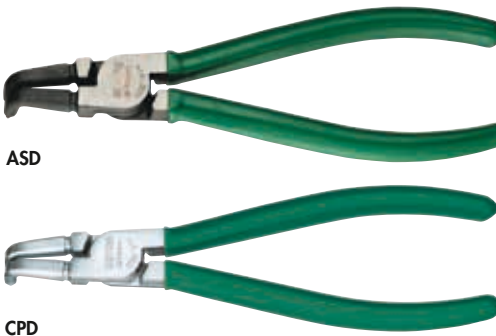

Code	Ausf. finish	Größe size	←L→		für for	mm	g	mm	EAN	€
			mm	"						
01256113513	ASD	D8	135	5.1/4	8 - 13	90	1	147445	22,00	
01256213513	ASD	D12	135	5.1/4	12 - 25	90	1	147438	22,00	
01256017013	ASD	D19	170	6.3/4	19 - 60	175	1	147421	23,80	
01256021513	ASD	D40	215	8.1/2	40 - 100	260	1	147414	30,65	
01256029013	ASD	D85	290	11.1/2	85 - 140	490	1	147407	49,30	
01256213587	CPD	D12	135	5.1/4	12 - 25	90	1	147391	24,85	
01256017087	CPD	D19	170	6.3/4	19 - 60	175	1	147384	28,35	
01256021587	CPD	D40	215	8.1/2	40 - 100	260	1	147377	36,00	
01256029087	CPD	D85	290	11.1/2	85 - 140	490	1	147360	55,95	

1257

Spezialzange für Sicherungsringe, gerade

Chrom-Vanadium
C = verchromt
für hufeisenförmige Sprengringe und Sicherungsringe ohne Greifbohrungen an Wellen

Retaining ring pliers, straight

Chrome-Vanadium
C = chromium plated
for horseshoe lock- and snap rings without grip holes (shafts)

Pincès à joncs extérieurs

Chrom-Vanadium
C = chromées
pour la manoeuvre des joncs et circlips sans perçage de têtes

Alicates para arandelas, tipo herradura

Cromo Vanadio
C = cromado
para arandelas exteriores tipo herradura y arandelas exteriores sin agujeros

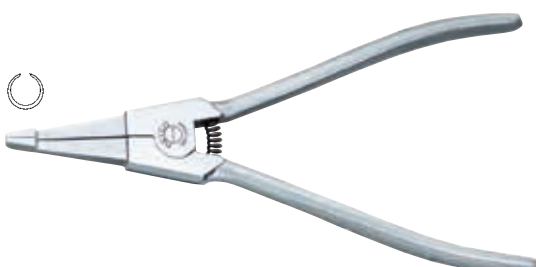

Code	mm	←L→	"	g	mm	EAN	€
01257017580	175		7	158	1	024708	39,75

1258

Drahtwirbelzange mit Ratschenfunktion

Zum Verwirbeln und Schneiden von Sicherungsdrähten. Gleichmäßige Verwirbelung durch Ratschenfunktion. Rechts- und Linksdrehung ermöglicht die Öffnung von verwirbelten Drähten ohne mechanische Beschädigung des Sicherungsdrahtes. Automatische Rückführung. Spezial gehärtete Backen, auch für dünne Edelstahldrähte geeignet.

Wire swivelling pliers with ratchet function

For swivelling and cutting of locking wires. Consistent swivelling through ratchet function. Clockwise and counterclockwise rotation allows opening of swivelled wires without damaging the locking wire. Automatic feedback. Special hardened jaws also suitable for stainless steel.

Pince de torsion à cliquet

Pour tordre et couper le fil de verrouillage. Torsion constant grâce au cliquet. La rotation à gauche et à droite permet l'ouverture des fils tordu sans endommager le fil. Rétroaction automatique. Mâchoires durcies qui conviennent aussi pour l'acier inoxydable.

Alicate para trenzado de alambre función de carraca

Para trenzar y cortar alambres de seguridad trenzado uniforme mediante la función de carraca. El giro a la derecha y a la izquierda posibilita el destrenzado de alambres trenzados sin daño mecánico del alambre de seguridad, retroceso automático, bocas especialmente templadas, aptas también para alambres inoxidables delgados.

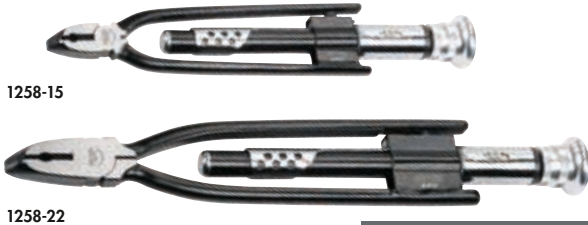

1258-15

1258-22



Code	No.	mm	←L→	"	g		EAN	€
01258015000	1258-15	230		9	300	1	380101	109,00
01258022500	1258-22	290		11	400	1	380125	119,00

1261-1

Gewindenietzangensatz in Metallkasten

Hand rivet nut tool kit in metal case

Pince à écrous aveugles en boîtier métallique

Set de tenazas para remaches roscados en caja metálica



Code	No.	mm	←L→	"	g		EAN	€
01261000100	1261-1	250		10	2511	1	376609	199,00

enthaltend/containing

Code	Artikel	article
01261025000	Gewindenietzange	hand rivet nut tool
01261001000	Gewindenietzangensatz in Kunststoffbox	rivet nut set in plastic box
01261310000	Gewindedorn M3 x 0,5	threaded mandrel M3 x 0,5
01261410000	Gewindedorn M4 x 0,7	threaded mandrel M4 x 0,7
01261510000	Gewindedorn M5 x 0,8	threaded mandrel M5 x 0,8
01261610000	Gewindedorn M6 x 1,0	threaded mandrel M6 x 1,0

1261

Gewindenietzange, handbetätigt

ST = standardmäßig
Gehäuse aus Aludruckguß und stahlgeschmiedeten Betätigungshebel
4 auswechselbare Mundstücke (M3, M4, M5, M6)
selbstöffnend durch integrierte Feder
stufenlos verstellbarer Anschlag
Ergonomischer Softgriff

Hand rivet nut tool

ST = standard
Housing made of aluminium and die cast - steel forged actuating lever
4 exchangeable nosepieces (M3, M4, M5, M6)
continuously adjustable
ergonomic soft grip

Pince à écrous aveugles manuel

ST = standard
Boîtier en aluminium moulé sous pression et levier en acier forgé
4 embouts interchangeables (M3, M4, M5, M6)
ouverture automatique par ressort intégré
butée réglable en continu
Poignée ergonomique souple

Tenaza para remaches roscados, manual

ST = estándar
Carcasa de aluminio fundido a presión y palanca de accionamiento de acero forjado
4 boquillas intercambiables (M3, M4, M5, M6)
Se abre automáticamente gracias a un muelle integrado
Tope ajustable en cualquier punto
Empuñadura blanda ergonómica



Code	No.	mm	←L→	"	g		EAN	€
01261025000	1261	250		10	620	1	376555	79,00

1261-10

Gewindenietensatz in Kunststoffbox

Bestehend aus vier verschiedenen
Gewindenieten.
Gewindenieten aus Alu-Legierung.

Rivet nut set
in plastic box

Consisting of four different rivet
nuts.
Rivet nuts made of aluminium alloy.

Ecrous aveugles
en coffret plastique

Comprenant quatre différents écrous
aveugles.
Ecrous aveugles en aluminium.

Set de remaches roscados
en caja de plástico

Que consta de 4 remaches roscados
diferentes.
Remaches roscados de aluminio aleado.



Code	No.				EAN	€
01261001000	1261-10		150	1	376562	37,00

enthaltend/containing

Stck./pcs.	Maße/dimensions
50	M3 x 0,5
60	M4 x 0,7
60	M5 x 0,8
30	M6 x 1,0

1261-30 - 1261-60

Gewindenietensatz in Blisterverpackung

Verpackungseinheit: 20 Stück
Gewindenieten aus Alu-Legierung.

Rivet nut set
in blister packing

Packing unit: 20 pcs.
Rivet nuts made of aluminium alloy.

Ecrous aveugles
sous blister

Emballage : 20 pièces
Ecrous aveugles en aluminium.

Set de remaches roscados
en pack de plástico

En un pack: 20 unidades
Remaches roscados de aluminio aleado.



Code	No.	Maße/dimensions			EAN	€
01261300000	1261-30	M3 x 0,5	150	1	376081	5,00
01261400000	1261-40	M4 x 0,7	150	1	376098	5,20
01261500000	1261-50	M5 x 0,8	150	1	376104	5,40
01261600000	1261-60	M6 x 1,0	150	1	376111	5,90

1261-31 - 1261-61

Gewindedorn

Verpackungseinheit: 1 Stück

Threaded mandrel

Packing unit: 1 pcs.

Mandrin

Emballage : 1 pièce

Mandril roscado

En un pack: 1 unidad



Code	No.	Maße/dimensions			EAN	€
01261310000	1261-31	M3 x 0,5	25	1	376159	9,95
01261410000	1261-41	M4 x 0,7	25	1	376166	9,95
01261510000	1261-51	M5 x 0,8	25	1	376173	9,95
01261610000	1261-61	M6 x 1,0	25	1	376180	9,95

1261-32 - 1261-62

Gewindenietsatz in Karton

Verpackungseinheit: 500 Stück
Gewindeniets aus Alu-Legierung.



Rivet nut set
in carton box

Packing unit: 500 pcs.
Rivet nuts made of aluminium alloy.

Ecrous aveugles
en carton

Emballage : 500 pièces
Ecrous aveugles en aluminium.

Set de remaches roscados
en pack de cartón

En un pack: 500 unidades
Remaches roscados de aluminio aleado.

Code	No.	Maße/dimensions			EAN	€
01261300200	1261-32	M3 x 0,5	350	1	376067	58,00
01261400200	1261-42	M4 x 0,7	350	1	376128	63,00
01261500200	1261-52	M5 x 0,8	350	1	376135	67,00
01261600200	1261-62	M6 x 1,0	350	1	376142	82,00

1262-1

Blindnietzangensatz in Metallkasten



Blind rivet tool set
in metal case

Assortiment pince à écrous
aveugles et écrous en boîtier
métallique

Set de tenazas para remaches
ciegos en caja metálica

Code	No.	mm	$\leftarrow L \rightarrow$	"			EAN	€
01262000100	1262-1	250		10	1200	1	376333	99,00

enthaltend/containing

Code	No.	Artikel	article
01262025000	1262	Blindnietzange	blind rivet tool
01262001000	1262-10	Blindnietensatz in Kunststoffbox	blind rivet set in plastic box

1262

Blindnietzange, handbetätigt

ST = standardmäßig
Gehäuse aus Aludruckguß und
stahlgeschmiedeten Betätigungshebel
4 auswechselbare Mundstücke
(2,4; 3,2; 4,0; 4,8 mm •
3/32"; 1/8"; 5/32"; 3/16")
Haltefunktion der Blindniete über
integrierte Federschließung
Kunststoffschlagkappe zum
Positionieren/Fixieren der Niete
Ergonomischer Softgriff

Blind rivet tool, hand-
operated

ST = standard
Housing made of aluminium and die
cast - steel forged actuating lever
4 exchangeable nosepieces
(2,4; 3,2; 4,0; 4,8 mm •
3/32"; 1/8"; 5/32"; 3/16")
retaining function of the blind rivet
through spring closure
plastic stroke cap for positioning/
fixation of the rivet
ergonomic soft grip

Pince à écrous aveugle
manuelle

ST = standard
Corps en aluminium moulé sous pression et
levier en acier forgé
4 embouts interchangeables
(2,4; 3,2; 4,0; 4,8 mm •
3/32"; 1/8"; 5/32"; 3/16")
Fonction d'arrêt des rivets grace au ressort
intégré
Bouchon en plastique pour positionner et
fixer les rivets
Poignée ergonomique souple

Tenazas para remaches ciegos,
manual

ST = estándar
Carcasa de aluminio fundido a presión
y palanca de accionamiento de acero
forjado
4 boquillas intercambiables
(2,4; 3,2; 4,0; 4,8 mm •
3/32"; 1/8"; 5/32"; 3/16")
Función de sujeción de los remaches ciegos
con cierre por muelle integrado
Cabeza de golpeo de plástico para
posicionar/fijar los remaches
Empuñadura blanda ergonómica



Code	No.	mm	$\leftarrow L \rightarrow$	"			EAN	€
01262025000	1262	250		10	620	1	376302	50,00

1262-10

Blindnietensatz in Kunststoffbox

Bestehend aus vier verschiedenen Blindnieten.
Blindnieten aus Alu-Legierung.

Blind rivet set in plastic box

Consisting of four different blind rivets.
Blind rivets made of aluminium alloy.

Rivets en coffret plastique

Comprenant 4 differents rivets.
Rivets en aluminium.

Set de remaches ciegos en caja de plástico

Que consta de 4 tipos de remaches ciegos diferentes.
Remaches ciegos de aluminio aleado.



Code	No.			EAN	€
01262001000	1262-10	400	1	376319	21,00

enthaltend/containing

Stck.	Ø mm
50	2,4
60	3,2
60	4,0
30	4,8

1262-24-1 - 1262-48-1

Blindnietensatz in Blisterverpackung

Verpackungseinheit: 30 Stück
Blindnieten aus Alu-Legierung.

Blind rivet set in blister packing

Packing unit: 30 pcs.
Blind rivets made of aluminium alloy.

Rivets sous blister

Emballage : 30 pièces
Rivets en aluminium.

Set de remaches ciegos en pack de plástico

En un pack: 30 unidades
Remaches ciegos de aluminio aleado.



Code	No.	Maße/dimensions			EAN	€
01262240100	1262-24-1	2,4	150	1	376296	3,60
01262320100	1262-32-1	3,2	150	1	376289	3,60
01262400100	1262-40-1	4,0	150	1	376272	3,80
01262480100	1262-48-1	4,8	150	1	376265	4,20

1262-24-2 - 1262-48-2

Blindnietensatz in Karton

Verpackungseinheit: 500 Stück
Gewindenieten aus Alu-Legierung.

Blind rivet set in carton box

Packing unit: 500 pcs.
Rivet nuts made of aluminium alloy.

Rivets en carton

Emballage : 500 pièces
Rivets en aluminium.

Set de remaches ciegos en pack de cartón

En un pack: 500 unidades
Remaches roscados de aluminio aleado.



Code	No.	Maße/dimensions			EAN	€
01262240200	1262-24-2	2,4	350	1	376258	19,00
01262320200	1262-32-2	3,2	350	1	376241	19,00
01262400200	1262-40-2	4,0	350	1	376234	22,00
01262480200	1262-48-2	4,8	350	1	376227	34,00

1280-N

Universal-Gripzangen

Chrom-Vanadium (Greifbacken)
N = vernickelt
mit halbrunden Backen,
mit Drahtschneider

Universal grip pliers

Chrome-Vanadium (jaws)
N = nickel plated
with half-round jaws,
with wire cutter

Pincés-étaux universelles

Chrome-Vanadium (mors)
N = nickelées
avec mors concaves
et coupe-fil

Tenazas grip universales

Cromo Vanadio (bocas)
N = niquelado
con bocas curvas,
con cortante



Code	mm	↔	mm			EAN	€
01280017550	175	7	35	353	1	024937	26,25
01280025050	250	10	50	534	1	024944	28,55
01280030050	300	12	65	900	1	024951	50,15

1280-L

Universal-Gripzangen

Chrom-Vanadium (Greifbacken)
L = lackiert
mit halbrunden Backen

Verbesserter Korrosionsschutz durch
Spezialbeschichtung

Universal grip pliers

Chrome-Vanadium (jaws)
L = lacquered
with half-round jaws

Improved corrosion protection
through special coating



Pinces-étaux universelles



Chrom-Vanadium (mors)
N = nickelées
avec mors concaves

Amélioration de la protection contre la
corrosion grâce à un revêtement spécial

Tenazas grip universales

Cromo Vanadio (bocas)
L = barnizado
con bocas curvas

Mejor protección contra la corrosión
gracias a su revestimiento especial

Code	←L→		:  mm	 g		EAN	€
	mm	"					
01280017520	175	7	35	350	1	371550	25,95
01280025020	250	10	50	520	1	371567	28,10
01280030020	300	12	65	910	1	371574	49,75

1281

Universal-Gripzangen

Chrom-Vanadium (Greifbacken)
N = vernickelt
universell einsetzbar durch spezielle
Formgebung der Backen

Universal grip pliers

Chrome-Vanadium (jaws)
N = nickel plated
V-shaped jaws permit
universal application





Pinces-étaux universelles

Chrom-Vanadium (mors)
N = nickelées
mors forme «V» pour une
application universelle

Tenazas grip universales

Cromo Vanadio (bocas)
N = niquelado
de uso universal gracias al diseño especial
de las bocas

Code	←L→		:  mm	 g		EAN	€
	mm	"					
01281017550	175	7	45	370	1	024968	26,80
01281025050	250	10	50	580	1	024982	29,15

1282

Universal-Gripzange

Chrom-Vanadium (Greifbacken)
N = vernickelt
mit geraden Backen

Universal grip plier

Chrome-Vanadium (jaws)
N = nickel plated
with straight jaws





Pinces-étaux universelles

Chrom-Vanadium (mors)
N = nickelées
avec mors droits

Tenazas grip universales

Cromo Vanadio (bocas)
N = niquelado
con bocas rectas

Code	←L→		:  mm	 g		EAN	€
	mm	"					
01282025050	250	10	40	512	1	024999	28,40

1285

Schweiß-Gripzange

Chrom-Vanadium (Greifbacken)
N = vernickelt
speziell für Profil- und Flachmaterial

Welding grip plier

Chrome-Vanadium (jaws)
N = nickel plated
particularly for profiled and flat
material



Pinces-étaux pour soudure

Chrom-Vanadium (mâchoires)
N = nickelées
spéciales pour matériaux profilés et plats

Tenazas grip para soldadores

Chromo Vanadio (bocas)
N = niquelado
horquilla para perfiles y material plano



Code	←L→		:  mm	 g		EAN	€
	mm	"					
01285028050	280	11	55	792	1	025026	40,25



2 Gripzangen mit Klemmvorrichtung in praktischer Tragetasche
 Improved corrosion protection through intelligent surface coating
 2 pinces grip avec dispositif de serrage dans un sac de transport pratique
 2 tenazas de agarre con sargentas en un práctico maletín-bolsa

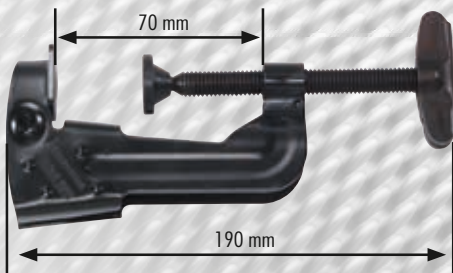

Mobiles Grip-System Die Synthese aus Zange, Schraubzwinde und Flexibilität

- Flexibel einsetzbar für sicheres Arbeiten an unterschiedlichen Arbeitsplätzen
- Sicherer Halt von verschiedensten Formen durch intelligente Backengeometrie

Mobile grip-system The synthesis of pliers, vice and flexibility

- Flexible use for safe work at different workplaces
- Secured maintaining of various forms through intelligent jaw geometry

Système grip mobile La synthèse de pince, étau et flexibilité

- Installation facile pour un travail en toute sécurité à différents postes
- Maintient en toute sécurité des pièces différentes, grâce à une excellente forme des mâchoires

Sistema de agarre móvil La síntesis de tenazas sargenta y flexibilidad

- De utilización flexible para trabajar con seguridad en distintos espacios de trabajo
- Sujeción firme para formas de lo más variadas gracias a una geometría de las mordazas inteligente



Verbesserter Korrosionsschutz durch intelligente Oberflächenbeschichtung

Improved corrosion protection through intelligent surface coating

Amélioration de la protection contre la corrosion par revêtement de surface intelligente

Protección contra la corrosión mejorada gracias a su revestimiento superficial inteligente



1286

Gripzange für mobiles Grip-System

Chrom-Vanadium
L = lackiert
Verbesserter Korrosionsschutz durch Spezialbeschichtung

Grip plier for mobile grip-system

Chrome-Vanadium
L = lacquered
Improved corrosion protection through special coating

Pince Grip pour système grip mobile

Chrome-Vanadium
L = laquées
Amélioration de la protection contre la corrosion grâce à un revêtement spécial

Tenaza de agarre del sistema de agarre móvil

Cromo Vanadio
L = barnizado
Mejor protección contra la corrosión gracias a su revestimiento especial



Code	mm	←L→ "	 mm	 g		EAN	€
01286023520	235	10	0 - 60	660	1	371604	32,25

1286-ST

Halterung für mobiles Grip-System

Chrom-Vanadium
L = lackiert

Holder for mobile grip-system

Chrome-Vanadium
L = lacquered

Prise en charge de système de poignée mobile

Chrome-Vanadium
L = laquées

Sujeción del sistema de agarre móvil

Cromo Vanadio
L = barnizado



Code	←L→ mm	 g		EAN	€
01286113520	140	270	1	371628	14,05

1286-4

Mobiles Grip-System

L = lackiert
bestehend aus:
2 x 1286
2 x 1286-ST
2 Gripzangen mit Klemmvorrichtung in praktischer Tasche.
Flexibel einsetzbar für sicheres Arbeiten an unterschiedlichen Arbeitsplätzen.
Sicherer Halt von verschiedensten Formen durch intelligente Backengeometrie.
Verbesserter Korrosionsschutz durch intelligente Oberflächenbeschichtung.

Mobile grip-system

L = lacquered
containing:
2 x 1286
2 x 1286-ST
2 locking pliers with clamps in plastic carrier bag.
Flexible use for safe work at different workplaces.
Secured maintaining of various forms through intelligent jaw geometry.
Improved corrosion protection through intelligent surface coating.

Système Grip mobile

L = laquées
comprenant:
2 x 1286
2 x 1286-ST
2 pinces Grip avec dispositif de serrage dans un sac de transport pratique.
Utilisation flexible pour un travail en toute sécurité sur différentes postes de travail.
Formes diverses d'arrêt de sécurité de la géométrie mâchoire intelligente.
Amélioration de la protection contre la corrosion par revêtement de surface intelligente.

Sistema de agarre móvil

L = barnizado
que consta de:
2 x 1286
2 x 1286-ST
2 tenazas de agarre con sargentas en un práctico maletín-bolsa.
De utilización flexible para trabajar con seguridad en distintos espacios de trabajo.
Sujeción firme para formas de lo más variadas gracias a la geometría inteligente de las mordazas.
Protección contra la corrosión mejorada gracias a su revestimiento superficial inteligente.



Code	mm	←L→ "	 mm	 g		EAN	€
01286000420	235	10	0 - 60	2050	1	371611	100,95



1287

Mini-Gripzange

- Das weltweit kleinste Spannwerkzeug
- Kann im rechten Winkel angesetzt werden und ist somit in engsten Bauräumen einsetzbar
- Das neuartige Hebelsystem in Verbindung mit erstklassigem Material ermöglicht eine Spannkraft von einer halben Tonne ohne sich zu verformen
- Die Gesamtlänge des Werkzeugs bleibt unabhängig von der Spannweite stets gleich
- Einhandbedienung möglich
- Hochwertige Ausführung aus Luftfahrtaluminium Chrom-Vanadium, L = lackiert, techn. Eloxal

Mini grip plier

- The world's smallest locking tool
- Always perpendicular positioning of tool enabling clamping in awkward to reach spots
- Innovative leverage system combined with prime materials allow the exertion of up to half ton force without deformation
- The length of the tool remains unchanged whatever the jaw opening
- One hand operation possible
- Heat treated aluminium alloy Chrome-Vanadium, L = lacquered, anodized

Pince-grip mini

- L'outil de serrage le plus petit au monde
- Peut être réglé à angle droit et est donc utilisable dans les espaces les plus serrés
- Le système de levier nouveau en liaison de matière de haute qualité permet une force de serrage d'une demi-tonne sans déformation
- La longueur totale de l'outil reste égale quelle que soit le serrage
- Utilisation de la main possible
- Conception de haute qualité en Aluminium aéronautique Chrome-Vanadium, L = laquées, techn. anodisation

Minitenaza de agarre

- La herramienta tensora más pequeña del mundo
- Se puede colocar con un ángulo recto y por tanto se puede usar en los espacios más estrechos
- El novedoso sistema de palanca junto con el material de primera clase permiten una fuerza tensora de 0,5 Tm sin deformarse
- La longitud total de la herramienta se mantiene siempre igual independientemente de la abertura
- Se puede manejar con una mano
- Fabricado en aluminio aeronáutico de alta calidad Cromo Vanadio, L = barnizado, Eloxal tecn.



Code	←L→ mm	mm	g	1	EAN	€
01287009220	92	12	123	1	371581	22,30

1287-24

Mini-Gripzangen im Verkaufsdisplay

- 24 Stück im Display
Chrom-Vanadium
L = lackiert
techn. Eloxal

Mini grip pliers in sales display

- 24 pieces in display
Chrome-Vanadium
L = lacquered
anodized

Pinces mini-grip en présentoir

- 24 pièces en présentoir
Chrome-Vanadium
L = laquées
techn. anodisation

Minitenaza de agarre en caja promocional

- 24 unidades en la caja promocional
Cromo Vanadio
L = barnizado
Eloxal tecn.



Code	←L→ mm	mm	g	24	EAN	€
01287002420	92	12	2940	24	371598	522,75

1327

Bandschlüssel

- Chrom-Vanadium (280 mm)
ND = vernickelt,
Griff PVC-überzogen,
C = verchromt
mit rutschfestem Gummigewebeband
speziell für Ölfilter und sonstige
empfindliche Verschraubungen

Strap wrenches

- Chrome-Vanadium (280 mm)
ND = nickel plated,
plastic coated handle
C = chromium plated
with non-skid fabric rubber strap
particularly for oil filters and other
sensitive screwed connections

Clés à sangle

- Chrome-Vanadium (280 mm)
ND = nickelées,
branche gainée plastique
C = chromées
avec ruban engommé antidérapant
spéciale pour filtres à huile et autres
vissages délicats

Llaves de correa

- Cromo Vanadio (280 mm)
ND = niquelado,
mangos plastificados con PVC,
C = cromado
con correa de tejido engomado de bueno
adherencia, especial para filtros de aceite y
otros objetos delicados



Code	No.	Ausf. finsh	←L→ mm	"	für Ø bis for Ø up to mm	g	1	EAN	€
01327023054	1327-1	ND	230	9	160	6.1/4	283	025644	32,25
01327028080	1327-2	C	280	11	240	9.1/2	504	025651	44,75

1328

Ersatzbänder für Bandschlüssel HEYCO 1327

ST = standardmäßig
aus 3-lagigem Gummigewebeband

Spare straps
for strap wrenches
HEYCO 1327



ST = standard
fabric rubber strap of 3 layers

Sangles de rechange
pour clés à sangle
HEYCO 1327

ST = standard
ruban engommé à trois couches

Correas de recambio
para llaves de correa
HEYCO 1327

ST = estándar
de tejido engomado de 3 capas

Code	No.	für/for	L x B			EAN	€
01328100000	1328-1	1327-1	615 x 22,5	57	10	025668	12,00
01328200000	1328-2	1327-2	810 x 25,0	90	10	025675	15,60

1329-3 1329-4

Ölfilterschlüssel

ND = vernickelt
Griff PVC-überzogen
mit verstellbarem Stahlband
mit Hebelgriff

Oil filter wrenches

ND = nickel plated
plastic coated handle
with adjustable steel tape
with levering handle



Clés pour filtres à huile

ND = nickelées
branche gainée plastique
avec sangle métallique ajustable
et manche de levier

Llaves para filtros de aceite

ND = niquelado
mangos plastificados con PVC
con cinta de acero ajustable
con mango palanca



Code	No.	$\leftarrow L \rightarrow$ mm	"	für/for mm	Ø "			EAN	€
01329000354	1329-3	205	8	60 – 80	2,3/8 – 3,1/8	280	1	025705	35,95
01329000454	1329-4	215	8,1/2	80 – 110	3,1/8 – 4,1/4	320	1	025712	36,35

1330

Eck-Rohrzangen

DIN 5234 B
Chrom-Vanadium
L = lackiert
schwedisches Modell

Elbow pipe wrenches

DIN 5234 B
Chrome-Vanadium
L = lacquered
swedish pattern



Serre-tubes

DIN 5234 B
Chrom-Vanadium
L = laquées
modèle suédois

Llaves para tubos

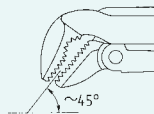
DIN 5234 B
Cromo Vanadio
L = barnizado
modelo sueco



Code	mm	$\leftarrow L \rightarrow$ "	für/for Ø "			EAN	€
01330001020	315	12.1/2	1	732	1	025729	45,95
01330001520	420	16.1/2	1.1/2	1490	1	025736	58,10
01330002020	535	22	2	2523	1	025743	97,15
01330003020	705	28	3	4067	1	025750	185,75

1333

Rohrzangen

DIN 5234 A
Chrom-Vanadium
L = lackiert
schwedisches Modell

Pipe wrenches

DIN 5234 A
Chrome-Vanadium
L = lacquered
swedish pattern



Serre-tubes

DIN 5234 A
Chrom-Vanadium
L = laquées
modèle suédois

Llaves para tubos

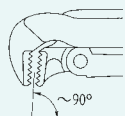
DIN 5234 A
Cromo Vanadio
L = barnizado
modelo sueco



Code	mm	$\leftarrow L \rightarrow$ "	für/for Ø "			EAN	€
01333001020	315	12.1/2	1	787	1	025767	45,95
01333001520	420	16.1/2	1.1/2	1468	1	025774	58,10
01333002020	560	22	2	2544	1	025781	97,15
01333003020	685	27	3	4166	1	025798	192,35



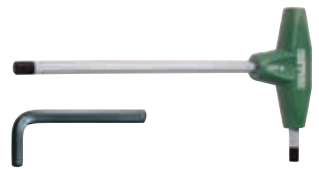

194 – 202



202 – 206

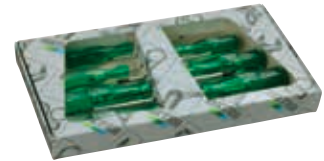

206 – 207



208 – 209



210 – 211



211 – 213

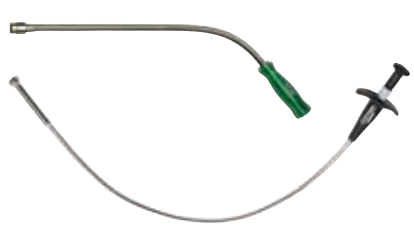

213



214 – 218



219 – 220



221



1335

Kugelkopf-Winkelschraubendreher für Innensechskantschrauben

Chrom-Vanadium
C = verchromt
(mit schwarzer Spitze) mit schlagfestem Kunststoffheft zum Schrauben von schwer zugänglich liegenden Innensechskantschrauben in einem Arbeitswinkel von bis zu 20°

Ball head hexagonal wrenches for hexagon socket screws

Chrome-Vanadium
C = chromium plated
(with black tip) with shockproof plastic handle, spherical head permits usage on hexagon socket screws located in confined or hard to reach areas off-axis operation up to 20°

Clés mâles coudées emmanchées à tête sphérique pour vis 6 pans creux

Chrome-Vanadium
C = chromées
(extrémité noire) manche en matière plastique incassable, grâce à leur tête sphérique, ces clés permettent, d'intervenir sur des vis 6 pans creux peu accessibles dont l'inclinaison va jusqu'à 20°

Cabeza esférica
Juegos de llaves Allen, acodadas para tornillos Allen

Cromo Vanadio
C = cromado
(con punta negra) mango de plástico antichoque para el atornillado de tornillos en sitios de difícil acceso ángulo de trabajo de hasta 20°



Code	MM	L ₁ mm	L ₂ mm	g	g	EAN	€
01335002580	2,5	125	15	14	10	113174	4,45
01335003080	3,0	125	15	17	10	113167	4,45
01335004080	4,0	125	15	26	10	113150	5,25
01335005080	5,0	150	20	53	10	113143	5,80
01335006080	6,0	150	20	59	10	113136	6,55
01335008080	8,0	175	25	150	10	113129	9,20
01335010080	10,0	200	25	230	10	113112	10,65

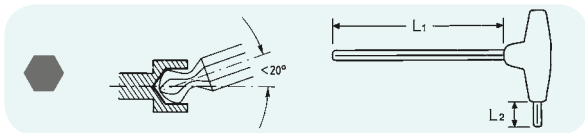

R 1335-6

Winkelschraubendreher-Satz für Innensechskantschrauben

in Kunststofftasche

Hexagonal head wrench set for hexagon socket screws

in plastic wallets

Jeux de clés mâles coudées pour vis 6 pans creux

en trousse plastique

Juegos de llaves Allen, acodadas para tornillos Allen

en bolsas, de plástico



Code	tlg./pcs.	g	g	EAN	€
01335727280	6	420	1	347296	47,55

enthaltend/containing
MM 2,5 3 4 5 6 8

1337

Winkelschraubendreher für Innensechskantschrauben

Chrom-Vanadium
C = verchromt
(mit schwarzer Spitze) mit schlagfestem Kunststoffheft

Hexagonal head wrenches for hexagon socket screws

Chrome-Vanadium
C = chromium plated
(with black tip) with shockproof plastic handle

Clés mâles coudées pour vis 6 pans creux

Chrome-Vanadium
C = chromées
(extrémité noire) avec manche en matière plastique incassable

Llaves Allen, acodadas para tornillos Allen

Cromo Vanadio
C = cromado
(con punta negra) mango de plástico antichoque



Code	MM	L ₁ mm	L ₂ mm	g	pcs.	EAN	€
01337002580	2,5	125	15	14	10	100242	4,60
01337003080	3,0	125	15	17	10	100259	4,50
01337003580	3,5	125	15	21	10	100266	4,90
01337004080	4,0	125	15	26	10	100273	5,40
01337004580	4,5	150	20	45	10	100280	5,45
01337005080	5,0	150	20	53	10	100297	5,70
01337006080	6,0	150	20	69	10	100303	6,00
01337007080	7,0	175	25	125	10	100310	6,45
01337008080	8,0	175	25	150	10	100327	7,00
01337010080	10,0	200	25	230	10	100334	8,95

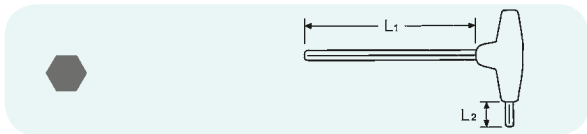

R 1337-6

Winkelschraubendreher-Satz für Innensechskantschrauben

in Kunststofftasche

Hexagonal head wrench set for hexagon socket screws

in plastic wallets

Jeux de clés mâles coudées pour vis 6 pans creux

en trousse plastique

Juegos de llaves Allen, acodadas para tornillos Allen

en bolsas, de plástico



Code	tlg./pcs.	g	pcs.	EAN	€
01337722080	6	452	1	110722	45,00
enthaltend/containing MM 2,5 3 4 5 6 8					

1340

Winkelschraubendreher für Innensechskant- schrauben

DIN/ISO 2936
Chrom-Vanadium
B = brüniert

Hexagonal head
wrenches for hexagon
socket screws

DIN/ISO 2936
Chrome-Vanadium
B = gun-metal finish

Clés mâles coudées
pour vis 6 pans creux

DIN/ISO 2936
Chrome-Vanadium
B = brunies

Llaves Allen, acodadas
para tornillos Allen

DIN/ISO 2936
Cromo Vanadio
B = pavonado

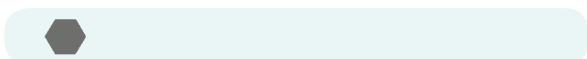

Code	MM	mm	g		EAN	€
01340001030	1	45 x 10	1	10	025873	0,25
01340001530	1,5	45 x 14	1	10	025880	0,25
01340002030	2	50 x 16	2	10	025903	0,25
01340002530	2,5	56 x 18	3	10	025927	0,25
01340003030	3	63 x 20	5	10	025941	0,40
01340003530	3,5	68 x 22	7	10	025965	0,45
01340004030	4	70 x 25	10	10	025989	0,50
01340004530	4,5	75 x 27	14	10	026016	0,85
01340005030	5	80 x 28	19	10	026030	0,90
01340006030	6	90 x 32	29	10	026061	1,15
01340007030	7	95 x 34	42	10	026092	1,70
01340008030	8	100 x 36	60	10	026122	2,20
01340009030	9	105 x 38	80	10	026153	2,55
01340010030	10	112 x 40	105	10	026177	3,00
01340012030	12	125 x 45	165	10	026207	4,10
01340013030	13	132 x 50	210	10	026238	4,95
01340014030	14	140 x 56	255	5	026252	6,40
01340017030	17	160 x 63	440	5	026283	10,80
01340019030	19	180 x 70	615	5	026313	12,60
01340022030	22	200 x 80	935	5	026337	20,70
01340024030	24	224 x 90	1250	1	026351	29,75
01340027030	27	250 x 100	1770	1	026375	43,15
01340030030	30	280 x 112	2460	1	026399	65,05
01340032030	32	315 x 125	3140	1	026412	90,30
01340036030	36	355 x 140	4400	1	026436	124,00

Code	AF	mm	g		EAN	€
01340630130	3/64	44 x 14	1	10	026511	0,40
01340630230	1/16	45 x 15	1	10	026535	0,40
01340630330	5/64	48 x 16	2	10	026559	0,40
01340630430	3/32	51 x 17	3	10	026573	0,40
01340630530	1/8	57 x 22	6	10	026580	0,65
01340630730	5/32	65 x 25	10	10	026603	0,85
01340630830	3/16	70 x 29	15	10	026627	0,85
01340631030	7/32	80 x 32	23	10	026641	0,95
01340631230	1/4	87 x 32	32	10	026665	1,15
01340631430	9/32	95 x 35	45	10	026689	1,50
01340631630	5/16	98 x 40	58	10	026702	2,20
01340631930	3/8	110 x 45	96	10	026726	3,00
01340632130	7/16	124 x 48	145	10	026740	3,45
01340632330	1/2	133 x 50	195	10	026764	4,70
01340632530	9/16	152 x 57	285	5	026788	6,40
01340632730	5/8	160 x 59	375	5	026801	10,55
01340633130	3/4	178 x 70	615	5	026825	12,60

H 1340

Winkelschraubendreher-Sätze für Innensechskantschrauben

in Handklapphaltern
(Halter vernickelt)

Hexagonal head wrench sets for hexagon socket screws

in metal holders
(holder nickel plated)

Jeux de clés mâles coudées pour vis 6 pans creux

sur monture
(monture nickelée)

Juegos de llaves Allen, acodadas para tornillos Allen en monturas niqueladas



Code	No.	MM	= 5				g	EAN	€
01340622030	H 1340-6-M	2,5 6	3 8	4	5	240	026498	18,20	
01340623030	H 1340-7-M	2,5 6	3 8 10	4	5	370	026504	26,55	

Code	No.	AF	= 5				g	EAN	€
01340637030	H 1340-5-AF	5/32 5/16	3/16	7/32	1/4	255	026849	20,95	
01340638030	H 1340-6-AF	5/64 3/16	3/32 7/32	1/8	5/32	165	026856	19,00	

HP 1340-9

Winkelschraubendreher-Satz für Innensechskantschrauben

in Kunststoffhaltern

Hexagonal head wrench set for hexagon socket screws

in plastic holders

Jeux de clés mâles coudées pour vis 6 pans creux

sur monture plastique

Juegos de llaves Allen, acodadas para tornillos Allen sobre soporte-expositor de plástico



Code	tlg./pcs.	g		EAN	€
01340825030	9	250	1	099720	15,70

enthaltend/containing

MM 1,5 2 2,5 3 4 5 6 8 10

K 1340

Winkelschraubendreher-Sätze für Innensechskantschrauben

auf Ringen

Hexagonal head wrench sets for hexagon socket screws

on rings

Jeux de clés mâles coudées pour vis 6 pans creux

sur anneau

Juegos de llaves Allen, acodadas para tornillos Allen en anillos



Code	No.	MM	= 5				g	EAN	€
01340524030	K 1340-8-M	2 5	2,5 6	3 8	4 10	245	026474	15,20	

Code	No.	AF	= 5				g	EAN	€
01340534030	K 1340-8-AF	1/16 5/32	5/64 3/16	3/32 7/32	1/8 1/4	100	026481	13,05	

R 1340

Winkelschraubendreher-Sätze für Innensechskantschrauben

in Rolltaschen, Kunststoff, mit Band

Hexagonal head wrench sets for hexagon socket screws

in plastic wallets, with strap

Jeux de clés mâles coudées pour vis à pans creux

en trousse plastique, avec lanière

Juegos de llaves Allen, acodadas para tornillos Allen

en bolsas enrollables, de plástico, con correa



Code	No.	MM	= 1	g	EAN	€
01340725530	R 1340-10-M	2 2,5 3 4 5 6 7 8 9 10		410	026863	21,50
01340727030	R 1340-12-M	2 2,5 3 3,5 4 5 6 7 8 9 10 12		580	026870	26,40

Code	No.	AF	= 1	g	EAN	€
01340735530	R 1340-10-AF	1/16 5/64 3/32 1/8 5/32 3/16 7/32 1/4 5/16 3/8		300	026894	19,70
01340737030	R 1340-12-AF	1/16 5/64 3/32 1/8 5/32 3/16 7/32 1/4 5/16 3/8 7/16 1/2		645	026900	28,25

1341

Winkelschraubendreher, lang für Innensechskantschrauben

DIN/ISO 2936
Chrom-Vanadium
B = brüniert

Hexagonal head wrenches, long series for hexagon socket screws

DIN/ISO 2936
Chrome-Vanadium
B = gun-metal finish

Clés mâles coudées, série longue pour vis à pans creux

DIN/ISO 2936
Chrome-Vanadium
B = brunies

Llaves Allen, acodadas, serie larga para tornillos Allen

DIN/ISO 2936
Cromo Vanadio
B = pavonado

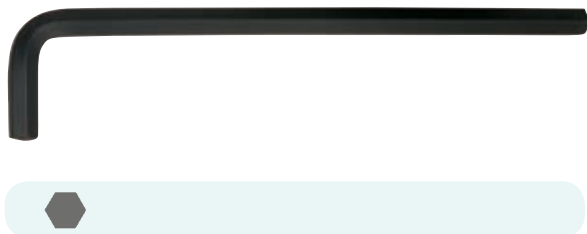

Code	MM	mm	g		EAN	€
01341002030	2	100 x 16	3	10	027051	0,65
01341002530	2,5	112 x 18	6	10	027068	0,80
01341003030	3	126 x 20	9	10	027075	0,90
01341004030	4	140 x 25	18	10	027082	1,20
01341005030	5	160 x 28	31	10	027099	1,75
01341006030	6	180 x 32	50	10	027105	1,95
01341007030	7	190 x 34	74	10	027112	2,95
01341008030	8	200 x 36	105	10	027129	3,35
01341009030	9	210 x 38	135	10	027136	4,30
01341010030	10	224 x 40	180	10	027143	4,90
01341012030	12	250 x 45	290	10	027150	6,20
01341014030	14	280 x 56	450	5	027167	9,40
01341017030	17	320 x 63	750	5	027174	17,20
01341019030	19	360 x 70	1050	5	027181	23,10

HP 1343-9

Kugelpopf- Winkelschraubendreher- Satz

Chrom-Vanadium
B = brüniert
in Kunststoffhaltern
zum Schrauben von schwer
zugänglich liegenden
Innensechskantschrauben in einem
Arbeitswinkel von bis zu 20°

Ball head hexagonal
wrench set

Chrome-Vanadium
B = gun-metal finish
in plastic holders
spherical head permits usage on
hexagon socket screws located in
confined, or hard to reach areas,
off-axis operation up to 20°

Jeux de clés mâles coudées
emmanchées à tête sphérique

Chrome-Vanadium
B = brunies
en monture plastiques
grâce à leur tête sphérique, ces clés
permettent d'intervenir sur des vis à
creux, peu accessibles dont l'inclinaison va
jusqu'à 20°

Cabeza esférica
Juegos de llaves
Allen, acodadas

Cromo Vanadio
B = pavonado
sobre soporte-expositor de plástico
para el atornillado de tornillos en sitios
de difícil acceso ángulo de trabajo de
hasta 20°

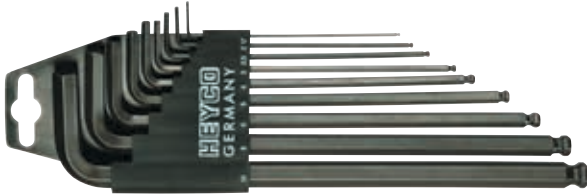

Code	tlg./pcs.			EAN	€
01343825030	9	405	1	099768	31,75

enthaltend/containing

MM 1,5 2 2,5 3 4 5 6 8 10

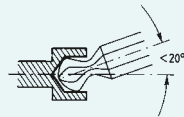

1345

Winkelschraubendreher für Innenvielzahn- Schrauben XZN

Chrom-Vanadium
B = brüniert

Multi-spline wrenches,
"L"-shaped
for multi-spline socket
screws XZN

Chrome-Vanadium
B = gun-metal finish

Clés mâles coudées
pour vis denture multiple XZN

Chrome-Vanadium
B = brunies

Llaves macho, acodadas,
con dentado
para tornillos XZN

Cromo Vanadio
B = pavonado



Code	für Schrauben for screws	 mm			EAN	€
01345000530	M 5	75 x 25	15	10	027303	4,35
01345000630	M 6	80 x 28	25	10	027310	5,05
01345000830	M 8	90 x 32	43	10	027327	6,45
01345001030	M 10	100 x 36	82	10	027334	8,85
01345001230	M 12	112 x 40	125	10	027341	10,60
01345001430	M 14	125 x 45	190	5	027358	14,50
01345001630	M 16	140 x 55	305	5	027365	19,35

R 1345-7

Winkelschraubendreher- Satz für Innenvielzahn- Schrauben XZN

in Kunststofftasche

Multi-spline wrench set,
"L"-shaped for multi-spline
socket screws XZN

in plastic wallet

Jeux de clés mâles coudées
pour vis denture multiple XZN

en trousse plastique

Juegos de llaves macho,
acodadas,
con dentado para tornillos XZN

en bolsas de plástico



Code	für Schrauben for screws			EAN	€
01345723030	M 5 6 8 10 12 14 16	850	1	027396	78,10

1347

Winkelschraubendreher für Innen-TORX®-Schrauben

Chrom-Vanadium
C = verchromt
(mit schwarzer Spitze)
mit schlagfestem Kunststoffheft

TORX®-Wrenches,
"L"-shaped
for TORX®-Socket screws

Chrome-Vanadium
C = chromium plated
(with black tip)
with shockproof plastic handle

Clés mâles coudées
pour vis TORX® intérieures

Chrome-Vanadium
C = chromées
(extrémité noire)
manche en matière plastique incassable

Llaves macho, acodadas
para tornillos TORX® interiores

Cromo Vanadio
C = cromado
(con punta negra)
mango de plástico antichoque

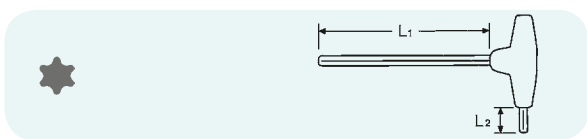

Code	Größe size	★ mm	L ₁ mm	L ₂ mm	g		EAN	€
01347000680	T 6	1,67	125	15	16	10	110333	8,05
01347000780	T 7	1,99	125	15	16	10	110340	8,05
01347000880	T 8	2,31	125	15	16	10	110357	8,05
01347000980	T 9	2,50	125	15	17	10	110364	8,05
01347001080	T 10	2,74	125	15	18	10	110371	8,20
01347001580	T 15	3,27	125	15	20	10	110388	9,25
01347002080	T 20	3,86	125	15	24	10	110395	9,95
01347002580	T 25	4,43	150	20	43	10	110401	10,35
01347002780	T 27	4,99	150	20	56	10	110418	10,85
01347003080	T 30	5,52	150	20	63	10	110425	13,05
01347004080	T 40	6,65	175	25	113	10	110432	13,60

R 1347-6

Winkelschraubendreher-Satz für Innen-TORX®-Schrauben

in Kunststofftaschen

Hexagonal head wrench set
for TORX®-Socket screws
in plastic wallets

Jeux de clés mâles coudées
pour vis TORX® intérieures
en trousse plastique

Juegos de llaves Allen,
acodadas
para tornillos TORX® interiores
en bolsas, de plástico



Code	tlg./pcs.	g		EAN	€
01347722080	6	397	1	347302	76,25

enthaltend/containing
T10 T15 T20 T25 T30 T40

1348

Winkelschraubendreher für Innen-TORX®- Schrauben

Chrom-Vanadium
B = brüniert

TORX®-Wrenches,
"L"-shaped
for TORX®-Socket screws

Chrome-Vanadium
B = gun-metal finish

Clés mâles coudées
pour vis TORX® intérieures

Chrome-Vanadium
B = brunies

Llaves macho, acodadas
para tornillos TORX® interiores

Cromo Vanadio
B = pavonado



Code	Größe size	★ mm	mm	g		EAN	€
0134800630	T 6	1,67	42 x 16	3	10	027532	3,75
0134800730	T 7	1,99	48 x 16	3	10	027549	3,75
0134800830	T 8	2,31	48 x 16	3	10	027556	3,75
0134800930	T 9	2,50	48 x 16	3	10	027563	4,30
01348001030	T 10	2,74	51 x 17	4	10	027570	4,35
01348001530	T 15	3,27	54 x 18	5	10	027587	4,40
01348002030	T 20	3,86	57 x 19	8	10	027594	4,80
01348002530	T 25	4,43	60 x 20	12	10	027600	5,00
01348002730	T 27	4,99	64 x 21	13	10	027617	5,15
01348003030	T 30	5,52	70 x 24	20	10	027624	5,40
01348004030	T 40	6,65	76 x 26	30	10	027631	6,10
01348004530	T 45	7,82	83 x 29	43	10	027648	6,80
01348005030	T 50	8,83	95 x 32	62	10	027655	8,15
01348005530	T 55	11,22	110 x 35	115	10	027662	10,35
01348006030	T 60	13,25	115 x 43	175	10	027679	13,60

H 1348-8

Winkelschraubendreher- Satz für Innen-TORX®- Schrauben

in Handklapphaltern
(Halter vernickelt)

TORX®-Wrench set
for TORX®-Socket screws

in metal holders
(holder nickel plated)

Jeux de clés mâles coudées
pour vis TORX® intérieures

sur monture
(monture niquelée)

Juegos de llaves macho,
acodadas
para tornillos TORX® interiores
en monturas niqueladas



Code	Größe size	g		EAN	€
01348624030	T9 T10 T15 T20 T25 T27 T30 T40	235	5	027686	42,25

R 1348-10

Winkelschraubendreher- Satz für Innen-TORX®- Schrauben

in Rolltaschen, Kunststoff, mit Band

Hexagonal head wrench
set
for TORX®-Socket screws

in plastic wallets, with strap

Jeux de clés mâles coudées
pour vis TORX® intérieures

en trousse plastique, avec lanière

Juegos de llaves macho,
acodadas
para tornillos TORX® interiores
en bolsas enrollables, de plástico, con
correa



Code	Größe size	g		EAN	€
01348725530	T8 T10 T15 T20 T25 T27 T30 T40 T45 T50	260	1	027693	60,80

HP 1349-8

Kugelpopf- Winkelschraubendreher- Satz für Innen-TORX®- Schrauben

Chrom-Vanadium
B = brüniert
in Kunststoffhaltern
zum Schrauben von schwer
zugänglich liegenden
Innen-TORX®-Schrauben in einem
Arbeitswinkel von bis zu 20°

Ball head TORX®-Wrench
set, "L"-shaped
for TORX®-Socket screws

Chrome-Vanadium
B = gun-metal finish
in plastic holders
spherical head permits usage on
TORX®-socket screws located in
confined
or hard to reach areas, off-axis
operation up to 20°

Jeux de clés mâles coudées
emmanchées à tête sphérique
pour vis TORX® intérieures

Chrome-Vanadium
B = brunies
en monture plastique
grâce à leur tête sphérique, ces clés
permettent d'intervenir sur des vis à pans
creux
peu accessibles dont l'inclinaison va
jusqu'à 20°

Cabeza esférica
Juegos de llaves macho,
acodadas
para tornillos TORX® interiores

Cromo Vanadio
B = pavonado
sobre soporte-expositor de plástico para el
atornillado de tornillos TORX® interiores
en sitios
de difícil acceso ángulo de trabajo de
hasta 20°



Code	tlg./pcs.			EAN	€
01349824030	8	164	1	099751	44,35

enthaltend/containing

T 9 T 10 T 15 T 20 T 25 T 27 T 30 T 40

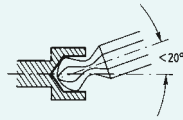

1405

Kreuzschlitz- Schraubendreher für PHILLIPS-RECESS- Schrauben

Chrom-Vanadium
C = verchromt (mit schwarzer Spitze)
mit durchgehender Klinge und
Hartholzheft mit Lederkappe
Klinge mit Sechskant

Cross slot screwdrivers
for cross slot screws
PHILLIPS-RECESS

Chrome-Vanadium
C = chromium plated (with black tip)
with blade through handle and
hardwood handle with leather cap
blade with hexagon bolster



Tournevis cruciforme
pour vis PHILLIPS-RECESS

Chrome-Vanadium
C = chromées (extrémité noire)
lame traversante et manche en bois dur
avec une bague en cuir
lame avec un six pans

Destornilladores
para tornillos PHILLIPS-RECESS

Cromo Vanadio
C = cromado (con punta negra)
varilla pasante y mango de
madera con remate de cuero, varilla con
hexágono



Code	No.	L ₁ mm	L ₂ mm				EAN	€
01405001080	1	80	175	6	52	10	028065	7,55
01405002080	2	100	210	10	94	10	028072	9,00
01405003080	3	150	270	12	160	10	028089	11,80
01405004080	4	200	340	17	310	10	028096	15,80

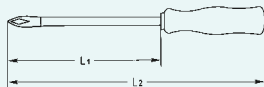

1411

Kreuzschlitz-Schraubendreher für PHILLIPS-RECESS-Schrauben

DIN/ISO 8764-2
Chrom-Vanadium
C = verchromt (mit schwarzer Spitze)
mit schlagfestem Kunststoffheft
No. 3 + 4 = Klinge mit Sechskant

Cross slot screwdrivers for cross slot screws PHILLIPS-RECESS

DIN/ISO 8764-2
Chrome-Vanadium
C = chromium plated (with black tip), with shockproof plastic handle
No. 3 + 4 = blade with hexagon bolster

Tournevis cruciforme pour vis PHILLIPS-RECESS

DIN/ISO 8764-2
Chrome-Vanadium
C = chromées (extrémité noire)
manche en matière plastique incassable
No. 3 + 4 = lame avec six pans

Destornilladores para tornillos PHILLIPS-RECESS

DIN/ISO 8764-2
Cromo Vanadio
C = cromado (con punta negra)
mango de plástico antichoque
No. 3 + 4 = varilla con hexágono

1411-01 + 02



1411-0 + 1 + 2



1411-3 + 4

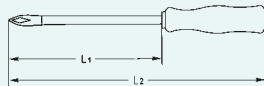

Code	No.	L ₁ mm	L ₂ mm	mm	g	mm	EAN	€
01411000180	01	25	85		44	10	028126	4,35
01411000280	02	25	85		48	10	028133	4,70
01411000080	0	60	135		25	10	028119	4,20
01411001080	1	80	170		48	10	028157	5,10
01411002080	2	100	200		81	10	028171	6,75
01411003080	3	150	260	13	170	10	028195	11,00
01411004080	4	200	325	16	275	5	028201	14,10

1412

Kreuzschlitz-Schraubendreher für POZIDRIV®-Schrauben

DIN/ISO 8764-2
Chrom-Vanadium
C = verchromt (mit schwarzer Spitze)
mit schlagfestem Kunststoffheft
No. 3 + 4 = Klinge mit Sechskant

Cross slot screwdrivers for cross slot screws POZIDRIV®

DIN/ISO 8764-2
Chrome-Vanadium
C = chromium plated (with black tip)
with shockproof plastic handle
No. 3 + 4 = blade with hexagon bolster

Tournevis cruciforme pour vis POZIDRIV®

DIN/ISO 8764-2
Chrome-Vanadium
C = chromées (extrémité noire)
manche en matière plastique incassable
No. 3 + 4 = lame avec un six pans

Destornilladores para tornillos POZIDRIV®

DIN/ISO 8764-2
Cromo Vanadio
C = cromado (con punta negra)
mango de plástico antichoque
No. 3 + 4 = varilla con hexágono

1412-01 + 02



1412-0 + 1 + 2



1412-3 + 4

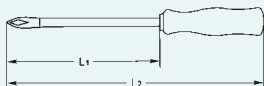

Code	No.	L ₁ mm	L ₂ mm	mm	g	mm	EAN	€
01412000180	01	25	85		44	10	028225	5,65
01412000280	02	25	85		48	10	028232	5,80
01412000080	0	60	135		25	10	028218	4,85
01412001080	1	80	170		48	10	028249	5,75
01412002080	2	100	200		81	10	028256	7,95
01412003080	3	150	260	13	150	10	028263	11,35
01412004080	4	200	325	17	275	5	028270	19,20

1415

Schraubendreher für Innen-TORX®-Schrauben

Chrom-Vanadium
C = verchromt (mit schwarzer Spitze)
mit schlagfestem Kunststoffheft

TORX®-Screwdrivers for TORX®-Socket screws

Chrome-Vanadium
C = chromium plated (with black tip)
with shockproof plastic handle

Tournevis TORX® pour vis TORX® intérieures

Chrome-Vanadium
C = chromées (extrémité noire)
manche en matière plastique incassable

Destornilladores para tornillos TORX® interiores

Cromo Vanadio
C = cromado (con punta negra)
mango de plástico antichoque

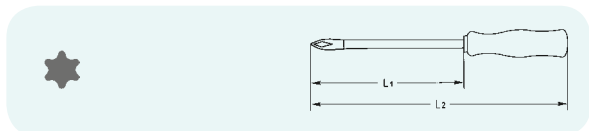

Code	Größe size	★ mm	L ₁ mm	L ₂ mm	g	g	EAN	€
01415000680	T 6	1,67	50	130	23	10	028287	5,10
01415000780	T 7	1,99	50	130	23	10	028294	5,10
01415000880	T 8	2,31	60	140	23	10	028300	5,10
01415000980	T 9	2,50	60	140	23	10	028317	5,10
01415001080	T 10	2,74	68	155	25	10	028324	5,45
01415001580	T 15	3,27	68	155	28	10	028331	5,65
01415002080	T 20	3,86	90	190	44	10	028348	5,90
01415002580	T 25	4,43	100	190	48	10	028355	6,15
01415002780	T 27	4,99	100	200	69	10	028362	6,30
01415003080	T 30	5,52	100	200	79	10	028379	7,05
01415004080	T 40	6,65	100	200	88	10	028386	7,55
01415004580	T 45	7,82	115	225	150	10	028393	9,40

1417

Aufreiber

N = vernickelt
Kunststoffheft, konische Vierkantspitze

Bradawls

N = nickel plated
with shockproof plastic handle,
conical square point

Pointes carrées

N = nickelées
manche en matière plastique incassable,
pointe carrée conique

Punzones

N = niquelado
mango de plástico antichoque, punta
cónica cuadrada

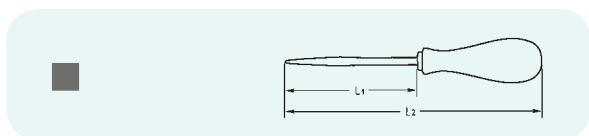

Code	Klingen-Ø blade-Ø mm	L ₁ mm	L ₂ mm	g	g	EAN	€
01417011050	6,0	100	190	82	10	100846	6,75

1430

Werkstatt-Schraubendreher für Schlitzschrauben

DIN 5625 / ISO 2380-2
Chrom-Vanadium
C = verchromt (mit schwarzer Spitze)
mit schlagfestem Kunststoffheft

Engineers' screwdrivers for plain slot screws

DIN 5625 / ISO 2380-2
Chrom-Vanadium
C = chromium plated (with black tip)
with shockproof plastic handle

Tournevis mécanicien pour vis à fente

DIN 5625 / ISO 2380-2
Chrom-Vanadium
C = chromées (extrémité noire)
manche en matière plastique incassable

Destornilladores para tornillos ranurados

DIN 5625 / ISO 2380-2
Cromo Vanadio
C = cromado (con punta negra)
mango de plástico antichoque

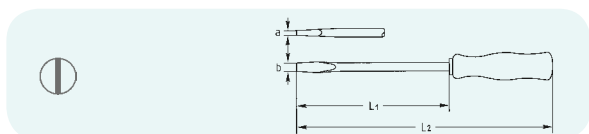

Code	a mm	b mm	L ₁ mm	L ₂ mm	g	g	EAN	€
01430010080	1,0	5,5	100	190	50	10	028539	4,70
01430012580	1,2	6,5	125	225	84	10	028546	6,40
01430015080	1,2	8	150	260	120	10	028553	9,40
01430020080	1,6	10	200	315	215	5	028560	11,55
01430025080	2,0	12	250	375	295	5	028577	14,80
01430030080	2,5	14	300	430	375	5	028584	17,10

1435

Elektriker- Schraubendreher für Schlitzschrauben

Chrom-Vanadium
C = verchromt (mit schwarzer Spitze)
mit schlagfestem Kunststoffheft

Electricians' screwdrivers
for plain slot screws

Chrome-Vanadium
C = chromium plated (with black
tip) with shockproof plastic handle

Tournevis électricien
pour vis à fente

Chrome-Vanadium
C = chromées (extrémité noire)
manche en matière plastique incassable

Destornilladores para
electricistas
para tornillos ranurados

Cromo Vanadio
C = cromado (con punta negra)
mango de plástico antichoque

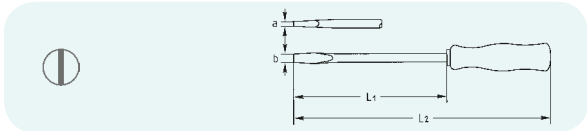

Code	a mm	b mm	L ₁ mm	L ₂ mm			EAN	€
01435006080	0,4	2,5	60	135	23	10	028591	3,55
01435007580	0,5	3	75	150	25	10	028607	3,45
01435010080	0,5	3	100	175	26	10	028614	4,30
01435012580	0,8	4	125	215	47	10	028621	4,30
01435015080	0,8	5	150	250	73	10	028638	5,40
01435017580	0,8	5	175	275	75	10	028645	6,75
01435020080	0,8	5	200	295	82	10	028652	7,45

1436

Elektriker- Schraubendreher für Schlitzschrauben

Chrom-Vanadium
CI = verchromt,
Klinge mit Kunststoff überzogen
(mit schwarzer Spitze) mit
schlagfestem Kunststoffheft

Electricians' screwdrivers
for plain slot screws

Chrome-Vanadium
CI = chromium plated,
blade with insulation (with black
tip) with shockproof plastic handle

Tournevis électricien
pour vis à fente

Chrome-Vanadium
CI = chromées,
lame gainée plastique (extrémité noire)
manche en matière plastique incassable

Destornilladores para
electricistas
para tornillos ranurados

Cromo Vanadio
CI = cromado, varilla plastificada
(con punta negra)
mango de plástico antichoque

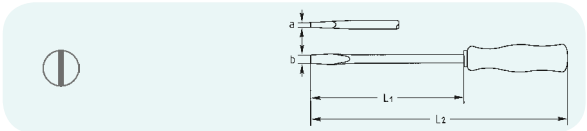

Code	a mm	b mm	L ₁ mm	L ₂ mm			EAN	€
01436006085	0,4	2,5	60	135	24	10	028669	4,25
01436007585	0,5	3	75	150	27	10	028683	4,25
01436010085	0,5	3,5	100	190	44	10	028706	5,15
01436012585	0,8	4	125	215	50	10	028737	5,65
01436015085	0,8	5	150	245	76	10	028751	6,80
01436017585	0,8	5	175	270	81	10	028775	7,20
01436020085	0,8	5	195	300	86	10	028782	8,10

1437

Werkstatt- Schraubendreher für Schlitzschrauben

DIN 5265 D / ISO 2380-2
Chrom-Vanadium
C = verchromt (mit schwarzer Spitze)
Klinge mit Sechskant, mit
schlagfestem Kunststoffheft

Engineers' screwdrivers
for plain slot screws

DIN 5265 D / ISO 2380-2
Chrom-Vanadium
C = chromium plated (with black tip)
blade with hexagon bolster with
shockproof plastic handle

Tournevis mécanicien
pour vis à fente

DIN 5265 D / ISO 2380-2
Chrom-Vanadium
C = chromées (extrémité noire)
lame avec un six pans manche en matière
plastique incassable

Destornilladores
para tornillos ranurados

DIN 5265 D / ISO 2380-2
Cromo Vanadio
C = cromado (con punta negra)
varilla con hexágono, mango de plástico
antichoque

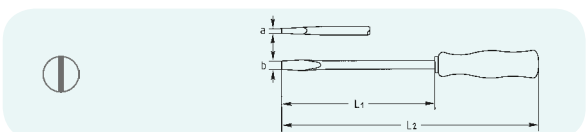

Code	a mm	b mm	L ₁ mm	L ₂ mm				EAN	€
01437010080	1,0	5,5	100	200	8	68	10	028799	6,95
01437012580	1,2	6,5	125	235	10	100	10	028805	8,15
01437015080	1,2	8	150	260	13	130	10	028812	10,65
01437017580	1,6	10	175	295	13	185	10	028829	13,05
01437020080	2,0	12	200	325	16	240	5	028836	15,00
01437025080	2,5	14	250	380	16	300	5	028843	20,05

1445

Vergaser-Schraubendreher für Schlitzschrauben

Chrom-Vanadium
C = verchromt (mit schwarzer Spitze)
mit schlagfestem Kunststoffheft

Stubby screwdrivers for plain slot screws

Chrome-Vanadium
C = chromium plated (with black tip)
with shockproof plastic handle



Tournevis boule à lame courte pour vis à fente

Chrome-Vanadium
C = chromées (extrémité noire)
manche en matière plastique incassable

Destornilladores modelo extracorto para tornillos ranurados

Cromo Vanadio
C = cromado (con punta negra)
mango de plástico antichoque

Code	a mm	b mm	L ₁ mm	L ₂ mm	g	mm	EAN	€
01445004080	0,8	4	25	85	40	10	028881	4,80
01445006080	1,2	6,5	25	85	46	10	028898	4,95

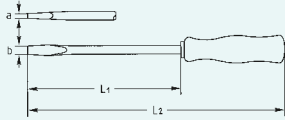

1470

Werkstatt-Schraubendreher für Schlitzschrauben

Chrom-Vanadium
C = verchromt (mit schwarzer Spitze)
mit durchgehender Klinge und
Hartholzheft mit Lederkappe
Klinge mit Sechskant

Engineers' screwdrivers for plain slot screws

Chrome-Vanadium
C = chromium plated (with black tip)
with blade through handle and
hardwood handle with leather cap
blade with hexagon bolster

Tournevis mécanicien pour vis à fente

Chrome-Vanadium
C = chromées (extrémité noire)
lame traversante et manche en
bois dur avec une bague en cuir
lame avec un six pans

Destornilladores para tornillos ranurados

Cromo Vanadio
C = cromado (con punta negra)
varilla pasante y mango de madera
con remate de cuero, varilla con hexágono

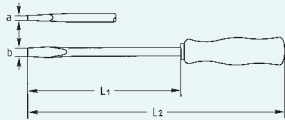

Code	a mm	b mm	L ₁ mm	L ₂ mm	mm	g	mm	EAN	€
01470007580	0,6	3,5	75	170	6	47	10	029017	5,65
01470009080	0,8	4,5	90	185	6	50	10	029024	5,65
01470010080	1,0	5,5	100	200	8	66	10	029031	5,80
01470012580	1,2	7	125	235	10	105	10	029048	7,60
01470015080	1,2	8	150	270	12	160	10	029055	10,10
01470017580	1,6	10	175	300	12	180	10	029062	11,65
01470020080	2,0	12	200	330	13	230	5	029079	14,20
01470025080	2,5	14	250	390	16	325	5	029086	17,60

1452 - 1454

Schraubendreher-Sätze

Chrom-Vanadium
N = vernickelt, C = verchromt,
CI = verchromt, Klinge isoliert

Screwdriver sets

Chrome-Vanadium
N = nickel plated, C = chromium
plated, CI = chromium plated,
blade insulated

Jeux de tournevis

Chrome-Vanadium
N = nickelées, C = chromées,
CI = chromées, lame

Juegos de destornilladores

Cromo Vanadio
N = niquelado, C = cromado,
CI = cromado, varilla plastificada



Code	No.	tlg./pcs.	g	mm	EAN	€
01452000080	1452	7	470	1	028928	42,80

enthaltend/containing

Stck. pcs.	Artikel/article	No.	Maße/size
je 1 each		1430 C	5,5 x 100 6,5 x 125 8 x 150 mm
1		1424 N	3 x 65 mm
1		1436 CI	3 x 75 mm
je 1 each		1411 C	No. 1 2

Code	No.	tlg./pcs.	g	mm	EAN	€
01454000080	1454	7	470	1	028935	44,65

wie 1452, jedoch/as 1456, but

Stck. pcs.	Artikel	No.	Maße/size
je 1 each		1412 C	No. 1 2

1456 – 1458

Schraubendreher-Sätze

Chrom-Vanadium
C = verchromt

Screwdriver sets

Chrome-Vanadium
C = chromium plated



Jeux de tournevis

Chrome-Vanadium
C = chromées

Juegos de destornilladores

Cromo Vanadio
C = cromado

Code	No.	tlg./pcs.			EAN	€
01456000080	1456	7	460	1	028942	42,55

enthaltend/containing

Stck. pcs.	Artikel/article		No.	Maße/size
je 1 each			1430 C	1430 C 6,5 x 125 8 x 150 mm
je 1 each			1435 C	2,5 x 60 3 x 75 3,5 x 100 mm
je 1 each			1411 C	No. 1 2

Code	No.	tlg./pcs.			EAN	€
01458000080	1458	7	460	1	028959	44,45

wie 1456, jedoch/as 1456, but

Stck. pcs.	Artikel		No.	Maße/size
je 1 each			1412 C	No. 1 2

1460

Schraubendreher-Satz für Innen-TORX®-Schrauben

Chrom-Vanadium
C = verchromt

Screwdriver set for TORX®-Socket screws

Chrome-Vanadium
C = chromium plated



Jeux de tournevis pour vis TORX® intérieures

Chrome-Vanadium
C = chromées

Juegos de destornilladores para tornillos TORX® interiores

Cromo Vanadio
C = cromado

Code	No.	tlg./pcs.			EAN	€
01460000080	1460	8	455	1	028966	50,50

enthaltend/containing

Stck. pcs.	Artikel/article		No.	Maße/size
je 1 each			1415 C	T8 T9 T10 T15 T20 T25 T27 T30



Sicherheitswerkzeuge
1000 Volt / DIN EN 60900

Insulated safety tools
1000 Volt / DIN EN 60900

Outils de sécurité
1000 Volt / DIN EN 60900

Herramientas de seguridad
1000 voltios / DIN EN 60900

1411

VDE Kreuzschlitz-Schraubendreher für PHILLIPS-RECESS-Schrauben

DIN 7438
Chrom-Vanadium
BV = brüniert
schutzisoliert gemäß DIN EN 60900
mit eingespritzt ummantelter Klinge
mit schlagfestem Kunststoffheft

VDE Cross slot screwdrivers for cross slot screws PHILLIPS-RECESS

DIN 7438
Chrome-Vanadium
BV = gun-metal finish, VDE 1000 volt insulated, complying with DIN EN 60900, insulation of blade and handle injection moulded as one unit, with shockproof plastic handle

VDE Tournevis cruciforme pour vis PHILLIPS-RECESS

DIN 7438
Chrome-Vanadium
BV = brunis, isolés VDE 1000 volt conforme aux spécifications VDE 0680/2, isolation de la lame par injection manche en matière plastique incassable

VDE Destornilladores para tornillos PHILLIPS-RECESS

DIN 7438
Cromo Vanadio
BV = pavonado, mangos con funda de plástico, protección cumple DIN EN 60900, aislamiento de la varilla inyectado, mango de plástico antichoque

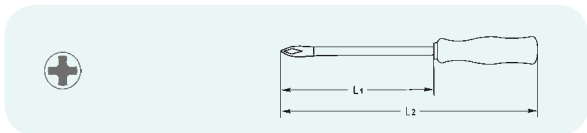

Code	No.	L ₁ mm	L ₂ mm	g	g	EAN	€
01411000033	0	60	140	24	10	028102	5,75
01411001033	1	80	170	42	10	028140	6,75
01411002033	2	100	200	70	10	028164	8,30
01411003033	3	150	260	130	10	028188	10,25

1436

VDE Elektriker-Schraubendreher für Schlitzschrauben

DIN 7437
Chrom-Vanadium
BV = brüniert
schutzisoliert gemäß DIN EN 60900
mit eingespritzt ummantelter Klinge
mit schlagfestem Kunststoffheft

VDE Electricians' screwdrivers for plain slot screws

DIN 7437
Chrome-Vanadium
BV = gun-metal finish, VDE 1000 volt insulated, complying with DIN EN 60900, insulation, of blade and handle injection moulded as, one unit with shockproof plastic handle

VDE Tournevis électricien pour vis à fente

DIN 7437
Chrome-Vanadium
BV = brunis, isolés VDE 1000 volt conforme aux spécifications VDE 0680/2, isolation de la lame par injection manche en matière plastique incassable

VDE Destornilladores para electricistas para tornillos ranurados

DIN 7437
Cromo Vanadio
BV = pavonado, mangos con funda de plástico, protección cumple DIN EN 60900, aislamiento de la varilla inyectado, mango de plástico antichoque

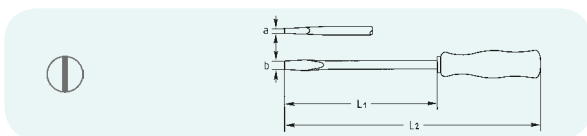

Code	a mm	b mm	L ₁ mm	L ₂ mm	g	g	EAN	€
01436007533	0,4	2,5	75	155	21	10	028676	5,45
01436010033	0,5	3,5	100	180	28	10	028690	6,40
01436010133	0,8	4,0	100	185	40	10	028713	6,85
01436012533	1,0	5,5	125	225	70	10	028720	7,70
01436015033	1,2	6,5	150	255	105	10	028744	8,20
01436017533	1,2	8,0	175	280	145	10	028768	11,05

1450

VDE Schraubendreher-Satz

Chrom-Vanadium
BV = brüniert, schutzisoliert gemäß DIN EN 60900

VDE Screwdriver set

Chrome-Vanadium
BV = gun-metal finish, insulated complying with DIN EN 60900

VDE Jeux de tournevis

Chrome-Vanadium
BV = brunis, isolés VDE 1000 volt

VDE Juegos de destornilladores

Cromo Vanadio
BV = pavonado, protección cumple DIN EN 60.900



Code	tlg./pcs.	g	g	EAN	€
01450000033	7	475	1	028911	49,60

enthaltend/containing					
Stck. pcs.	Artikel/article		No.	Maße/size	
je 1 each			1436 VDE	2,5 x 75 4 x 100 5,5 x 125 6,5 x 150 mm	
1			1424 N	3 x 65 mm	
je 1 each			1411 VDE	No. 1 2	

49-5

VDE-Elektriker Werkzeug-Garnitur

Modern das Design, klein der Raum, groß der Inhalt. Die kompakt und modern gestaltete Box aus Polypropylen ist stoßempfindlich, schlagfest, temperatur-, öl-, säure- und benzinbeständig. Inhalt nach IEC 900/DIN EN 60900/VDE 0682 Teil 201. Kunststoffbox 370 x 270 x 56 mm

VDE Electricians tool-set

Modern in design, space-saving, with a large assortment of first class quality tools. The compact and modern styled box, which is manufactured from polypropylene is shock-proof, resistant to impact, temperature, oil, acid and petrol. Contents with IEC 900/DIN EN 60900/VDE 0682 part 201 certification. Plastic box 370 x 270 x 56 mm

VDE Composition d'outils VDE pour électricien

Moderne par son design, modeste par son encombrement, large et complet par sa composition. Ce coffret compact et moderne, en polypropylène, est insensible aux chocs, résistant aux variations de température, aux huiles, aux acides et à l'essence. Contenu conforme aux tests EN. Coffret en matière plastique 370 x 270 x 56 mm

Conjunto de herramientas para electricista VDE

Diseño moderno, volumen reducido, contenido amplio. El maletín compacto y moderno resiste golpes, calor, aceite, ácido y gasolina. Contenido según norma IEC 900/DIN EN 60900/VDE 0682 apartado 201. Maletín de plástico 370 x 270 x 56 mm



Code	tlg. pcs.	Maße dimensions			EAN	€
00049000500	9	370 x 270 x 56 mm	1520	1	002188	209,50

enthaltend/containing

Stck. pcs.	Artikel/article	No.	Maße/size
1		1208 VDE CPV	160 mm
1		1213 VDE CPV	140 mm
1		1220 VDE CPV	160 mm
2		1411 VDE BV	PH No. 1 2
1		1427 VDE ST	65 x 3 mm
3		1436 VDE BV	75 x 2,5 100 x 4 125 x 5,5 mm

1052

VDE Elektriker Rucksack

- Breite Trageriemen und Rücken gepolstert
- Übersichtliches Ordnungssystem
- Kunststoffbox für Kleinteile

VDE Electricians backpack

- Wide straps and padded back
- Well organization system
- Plastic box for parts

Sac à dos électricien VDE

- Larges bretelles et dos rembourré
- Organisation clair
- Boîtier plastique pour les petites pièces

Mochila para electricistas VDE

- Anchas correas, espalda acolchada
- Sistema de ordenamiento racional
- Caja de plástico para picerío



Code	tlg./pcs.			EAN	€
01052001000	14	3005	1	362213	351,55

enthaltend/containing

Stck. pcs.	Artikel/article	No.	Maße/size
1		1208 VDE CPV	200 mm
1		1200 VDE CPV	180 mm
1		1213 VDE CPV	160 mm
1		1220 VDE CPV	160 mm
2		1427 VDE BV	PH No. 1 2
4		1436 VDE BV	75 x 2,5 100 x 4 125 x 5,5 150 x 6,5mm
1		1427 VDE	60 x 3 150-250V
1		1920	10 m
1		1426 VDE	12-750V

Rucksack, leer/Backpack, empty:

Code	tlg./pcs.			EAN	€
01052000000	1	1300	1	362121	96,95

1419

Auto-Lichtprüfer 6 – 24 Volt

MS = Messing
Messingkörper, mit Prüfspitze,
Schutzkappe und festem Kabel mit
Masseklemme,
zur Kontrolle von Licht- und
Zündanlagen an Kraftfahrzeugen

Car light tester 6 – 24 Volt

MS = brass
brass body, with contact point,
protective screw cap and fixed
cable, with alligator clip, for
checking electric circuits on motor
cars



Contrôleurs de tension 6 – 24 Volt

MS = laiton
corps en laiton, avec pointe-déectrice,
capuchon et câble fixe avec pince
crocodile,
pour contrôler l'installation d'éclairage et
d'allumage des véhicules

Buscapolos para automóvil 6 – 24 voltios

MS = latón
cuerpo de latón, con punta de contacto,
caperuza protectora y cable fijo, con
pinza,
para comprobar alumbrado y encendido
en automóviles



Code	←L→ mm	 g		EAN	€
01419000045	120	67	10	028423	9,70

1420

Auto-Lichtprüfer 6 – 24 Volt

N = vernickelt
60 cm langes Kabel mit Masse-
klemme zur Kontrolle von Licht- und
Zündanlagen an Kraftfahrzeugen

Car light tester 6 – 24 Volt

N = nickel plated
60 cm long cable with earthing
clip, for checking electric circuits
on motor cars



Contrôleurs de tension 6 – 24 Volt

N = nickelées
Cordon de 60 cm avec pince de masse,
pour le contrôle des installations
d'éclairage et d'allumage des véhicules

Buscapolos para automóvil 6 – 24 voltios

N = niquelado
Cable de 60 cm de largo, con pinza de
conexión de masa, para comprobar
instalaciones de alumbrado y encendido
de automóviles



Code	a mm	b mm	L ₁ mm	L ₂ mm	 g		EAN	€
01420000050	0,7	3	44	120	22	10	028430	6,20

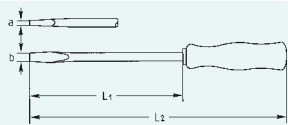

1424

Spannungsprüfer für 220 – 250 Volt

N = vernickelt
mit Metall-Clip

Voltage tester for 220 – 250 Volt

N = nickel plated
with pocket clipp

Tournevis détecteurs de tension pour 220 – 250 Volt

N = nickelées
avec agrafe

Destornilladores buscapolos para 220 – 250 voltios

N = niquelado
con clip metálico



Code	a mm	b mm	L ₁ mm	L ₂ mm	 g		EAN	€
01424000050	0,5	3	65	140	18	10	028461	2,75

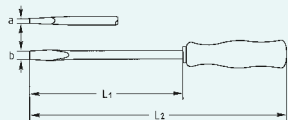

1425

Spannungsprüfer für 220 – 250 Volt

N = vernickelt

Voltage tester for 220 – 250 Volt

N = nickel plated



Tournevis détecteurs de tension pour 220 – 250 Volt

N = nickelées

Destornilladores buscapolos para 220 – 250 voltios

N = niquelado



Code	a mm	b mm	L ₁ mm	L ₂ mm	 g		EAN	€
01425000050	0,5	3,5	100	195	36	10	028485	3,60

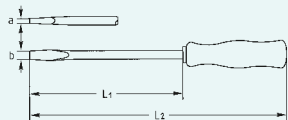

1426

VDE Spannungsprüfer für 12 – 750 Volt

ST = standardmäßig gemäß VDE 0680 T.5 DIN 57105 elektronische Spannungsanzeige mit 3 voneinander unabhängigen Anzeigesystemen; zweepolig

VDE Voltage tester for 12 – 750 Volt

ST = standard complying with VDE 0680 T.5 DIN 57105 electronic voltage indication with 3 independent reading systems, bipolar

VDE Tournevis détecteurs de tension, pour 12 – 750 Volt

ST = standard conforme aux spécifications VDE 0680 T.5 DIN 57105 indication de tension électronique avec 3 affichages indépendants, bipolaire

VDE Buscapolos para 12 – 750 voltios

ST = estándar cumple norma VDE 0680 T.5 indicador electrónico del voltaje mediante 3 sistemas independientes; bipolar



Code			EAN	€
0142600000	185	1	028492	109,10

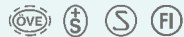

1427

VDE Spannungsprüfer für 150 – 250 Volt

ST = standardmäßig mit Metall-Clip

VDE Voltage tester for 150 – 250 Volt

ST = standard with pocket clip

VDE Tournevis détecteurs de tension, pour 150 – 250 Volt

ST = standard avec agrafe

VDE Buscapolos para 150 – 250 voltios

ST = estándar con clip metálico



Code	a mm	b mm	L ₁ mm	L ₂ mm			EAN	€
0142700000	0,6	3	65	152	27	10	028508	10,45

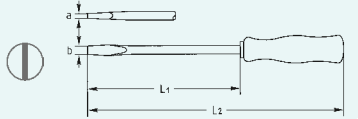

1479

Umsteck-Schraubendreher für Schlitz- und Kreuzschlitzschrauben

Chrom-Vanadium C = verchromt mit schlagfestem Kunststoffheft

Reversible screwdriver for plain slot and cross slot screws

Chrome-Vanadium C = chromium plated with shockproof plastic handle

Tournevis lame réversible pour vis à fente et cruciformes

Chrome-Vanadium C = chromées manche en plastique incassable

Destornilladores intercambiables punta plana y punta cruciforme

Cromo Vanadio C = cromado mango de plástico antichoque



Code	No.						EAN	€
0147900080	2	6 mm	140 mm	90 mm	62	10	029116	4,10



1480

Universal-Schalterschrankschlüssel

Durch einen doppelten Drehmechanismus können vier verschiedene Schließungen in Position gebracht werden. Universell einsetzbar für fast alle gängigen Schließsysteme in der: Elektrotechnik Gas- und Wasserversorgung Heizung, Klima- und Sanitärbereich. Eine 1/4" Bitaufnahme ermöglicht den Einsatz aller handelsüblichen Bits. Ein Neodym Dauermagnet hält den Bit sicher in der Aufnahme.

Universal control cabinet key

Four different locking positions can be selected by a double rotary-mechanism. All-purpose device for prevalent locking systems in the field of Electro-technics Gas and water supply Heating, air conditioning and sanitary installations The 1/4" bit adaptor allows the utilisation of all standard bits. A Neodym permanent magnet securely keeps the bit in its position.

Clé universelle pour armoires de commande

Grâce à une double mécanisme de rotation 4 différentes fermetures peuvent se faire. Pour installations techniques dans les batiments telles que climatisation et ventilation, chauffage et installations sanitaires. Avec adaptateur pour embouts 1/4" Un aimant néodyme tient l'embout dans son position.

Llave universal para armarios

Mediante un mecanismo de giro doble, se pueden poner en posición 4 cierres diferentes. Uso universal para la práctica totalidad de los sistemas de cierre en electrotécnica, suministro de gas y de agua, y en el ámbito de calefacción, climatización y sanitario. Un acoplamiento para bits de 1/4" facilita el uso de toda clase de bits que se encuentran en el mercado. Un imán permanente Neodym sujeta el bit de manera segura.



Code	für/for	 g		EAN	€
0148000060	1/4"	130	1	362114	28,10

1483

Winkelschraubendreher für Schlitzschrauben

DIN 5200
Chrom-Vanadium
N = vernickelt

Offset screwdrivers for plain slot screws

DIN 5200
Chrome-Vanadium
N = nickel plated





Tournevis coudés pour vis à fente

DIN 5200
Chrome-Vanadium
N = nickelées

Destornilladores acodados punta plana

DIN 5200
Cromo Vanadio
N = niquelado



Code	 mm	\leftarrow L \rightarrow mm	 mm	 g		EAN	€
01483010050	4	100	0,8	13	10	113860	5,65
01483012550	5,5	125	1,0	30	10	114133	6,00
01483015050	8	150	1,2	50	10	113877	8,65
01483017550	10	175	1,6	78	10	113884	10,70
01483020050	12	200	2,0	135	10	113891	15,25

1484

Winkelschraubendreher für Kreuzschlitzschrauben

DIN 5208
Chrom-Vanadium
N = vernickelt

Offset screwdrivers for cross slot screws

DIN 5208
Chrome-Vanadium
N = nickel plated



Tournevis coudés pour vis cruciformes

DIN 5208
Chrome-Vanadium
N = nickelées

Destornilladores acodados punta cruciforme

DIN 5208
Cromo Vanadio
N = niquelado



Code	No.	\leftarrow L \rightarrow mm	 g		EAN	€
01484010250	1 + 2	100	27	10	113907	7,15
01484030450	3 + 4	200	155	10	113914	12,85

1491

Schraubenausdreher-Sätze

Chrom-Vanadium
ST = standardmäßig
zum Entfernen von abgebrochenen
Schrauben und Gewindebolzen mit
Rechtsgewinde, in Kunststoffbox

Screw extractor sets

Chrome-Vanadium
ST = standard
for removing broken screws and
studs with right hand thread,
in plastic boxes

Jeux d'extracteurs de goujons
cassés

Chrome-Vanadium
ST = standard
pour extraction des goujons cassés
et des boulons filetés à droite,
en boîte plastique

Juegos de extractores de
tornillos

Cromo Vanadio
ST = estándar
para extraer tornillos y bulones rotos,
con rosca a la derecha,
en caja de plástico



Code	tlg./pcs.	für Schrauben/for screws M				EAN	€
01491000500	5	3 – 18	1/8 – 3/4	115	1	029192	22,85
01491000600	6	3 – 24	1/8 – 1	220	1	029208	33,05
01491000800	8	3 – 45	1/8 – 1.3/4	700	1	029215	68,55

1494

Magnetheber

CPP = verchromt, ganz poliert
mit flexiblem Schaft und Kunststoffheft

Magnetic pick-up tools

CPP = chromium plated, fully
polished, with flexible shaft and
plastic handle

Doigts magnétiques

CPP = chromées, entièrement polis
avec tige flexible et manche en plastique

Extractores magnéticos flexibles

CPP = cromado, enteramente pulido
espejo, mango de plástico



Code	No.	Zugkraft lifting capacity g	Magnet magnet Ø-mm	←L→ mm			EAN	€
01494000183	1494-1	500	6	470	89	5	029307	29,20
01494000283	1494-2	1800	12	535	265	5	029314	37,00
01494000383	1494-3	3000	16	550	305	5	029321	53,65

1495-3

Krallengreifer

Greiffunktion

- Über Magnetheber
- Über 3-Arm Krallengreifer
- Zum Greifen von Kleinteilen an schwer zugänglichen Stellen mit flexiblem Schaft
- Helle LED zum Ausleuchten von dunklen Stellen

C = verchromt
mit LED und Magnet

3-Claw pick-up tool

Grip function

- By magnetic pick-up tool or
- 3-claw pick-up tool
- For retrieving small parts from confined or hard to reach areas with flexible shaft
- Bright LED illuminate dark areas

C = chromium plated
with LED and magnet

Doigts magnétiques

Fonction de préhension

- Par l'intermédiaire de levage magnétique
- Par griffe de préhension 3 bras
- Avec tige flexible et manche en plastique
- LED lumineux pour éclairer les zones sombres

C = chromées
avec LED et aimant

Pinza de extracción

Función de agarre

- Por imán
- Por garra de 3 uñas
- Para extraer piezas pequeñas de sitios de difícil acceso con varilla flexible
- Potente LED para alumbrar sitios oscuros

C = cromado
con LED y imán

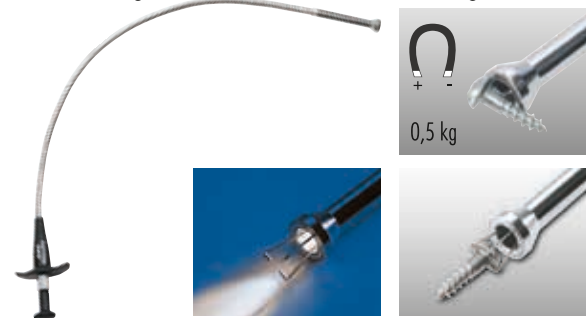

Code	←L→ mm	Greif-Ø gripping-Ø max. mm			EAN	€
01495000380	650	7	263	1	371444	37,85

1496-2 1497

Teleskop-Spiegel

N = vernickelt
vielfache Verstellmöglichkeiten durch
Teleskop-Schaft und Spiegelkopf-
Gelenk, mit Kunststoffheft
1496-2 runde Spiegelform, Ø 60 mm
1497 rechteckige Spiegelform,
68 x 38 mm

Telescopic inspection
mirrors

N = nickel plated
numerous adjustment alternatives
with telescopic shaft and joint on
mirror head, with plastic handle
1496-2 round mirror, Ø 60 mm
1497 rectangular mirror,
68 x 38 mm

Miroirs orientables

N = nickelées
ajustabilité multiple par tige télescopique et
miroir articulé
avec manche en plastique
1496-2 miroir rond, Ø 60 mm
1497 miroir rectangulaire, 68 x 38 mm

Espejos de inspección
telescopicos

N = niquelado
ajuste variable mediante varilla telescópica
y articulación mango de plástico
1496-2 espejo redondo, Ø 60 mm
1497 espejo rectangular, 68 x 38 mm

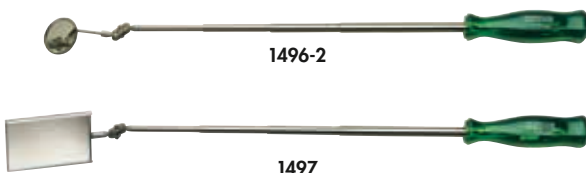

Code	No.	Spiegelmaße dimensions of mirror mm	←L→ mm			EAN	€
01496000250	1496-2	Ø 60	280 – 750	90	1	029369	62,65
01497000050	1497	68 x 38	280 – 750	94	1	029376	52,00

Schraubendreher Screwdrivers Tournevis Destornilladores

Hartkomponente mit nahtfreier Kappe zum Aufbringen der Axialkraft bei minimaler Reibung.

Hard component with seamless cap for maximum comfort and transmission of axial force.

Extrémité en matière dure, lisse, sans joint, pour obtenir confort et force dans l'axe.

Componente de plástico duro, extremo sin rebarba, para aplicar la fuerza axial con un mínimo de fricción.

Flansch gegen axiale Verdrehung (speziell für runde Klingen).

Flange to prevent axial torsion (in particular with round blades).

Ergot pour résister à la torsion axiale (Particulièrement pour lames rondes).

Saliente para evitar que la varilla gire en el mango (especialmente en el caso de varillas redondas).

Zwei Flächen als Rollschutz.

Two flattened areas as anti-roll feature.

Deux plats de stabilité.

Dos chaffanes para que el mango no pueda rodar.



Optimal ergonomisch ausgearbeiteter Sechskantgriff mit abgeflachten Kanten und angenehm griffiger Weichkomponente.

Most ergonomically designed handle with flattened edges and non-slip soft grip outer material.

Ergonomie optimale du manche hexagonal avec des arêtes aplanies et en matière souple et antidérapante

Mango ergonómico de perfil hexagonal con cantos redondeados y un componente de plástico blando de tacto agradable y firme.

Querbohrung zum Aufhängen des Werkzeugs und zum Einstecken eines Drehstiftes zur Erhöhung der Drehkraft.

Hanging hole for easy storage or inserting lever for additional torque.

Trou transversal pour pendre l'outil et pour pouvoir introduire une broche afin d'augmenter la force de rotation.

Agujero transversal para colgar la herramienta e introducir un bandeador para aumentar el par de giro.

Weichmantel für maximalen Reibschluss und Aufbringung höchster Drehmomente.

Soft grip outer material for maximum friction and highest torque.

Surface tendre antidérapante pour une meilleure transmission du couple de serrage.

Recubrimiento blando para un agarre firme y una óptima transmisión del par de giro.

Abrutschbremse und Schnelldrehzone.

Slip guard with spinning characteristic.

Proteccion antidérapante et zone de vissage rapide.

Tope para evitar que la mano resbale y zona de giro rápido.

Bei Sechskantklingen zusätzlicher Aussensechskant zum Aufsetzen eines Schraubenschlüssels.

Additional hexagonal bolster on hexagonal blades for assistance of spanner.

Lames hexagonales équipées d'un épaulement hexagonal complémentaire pour adapter une clé de serrage.

En el caso de varillas exagonales, exágono exterior para aplicar una llave de tuerca.

Klingen aus Spezialstählen präzise gefertigt, vernickelt und matt verchromt.

Blades manufactured from selected special steels, nickel and mat chromium plated.

Lames en aciers spéciaux fabriquées avec précision, nickelées et chromées mat.

Varillas de aceros especiales, de gran precisión, niqueladas y cromadas mate.

Brünierte Spitze für Präzision und Passgenauigkeit.

Black tip for precision fit.

Extrémité brunie pour un ajustage de précision.

Punta pavonada con exactitud de medida.



4500 - 4502

Verkaufsständer mit
2K Schraubendreher,
55-tlg.,
für Schlitz-, Kreuzschlitz-,
und TORX®-Schrauben

ST = standardmäßig
Metallständer 470 x 210 x 360 mm

2K Screwdrivers
display stands, 55 pcs.,
for plain slot, cross slot
and TORX®-Screws

ST = standard
Metal display 470 x 210 x 360 mm

Présentoirs de tournevis 2K,
55 pcs.,
pour vis à fente, cruciforme et
TORX®

ST = standard
Présentoirs en métal 470 x 210 x 360 mm

Expositor de destornilladores 2K
de 55 piezas,
para tornillos de punta plana,
cruciforme y TORX®

ST = standard
Soporte metálico 470 x 210 x 360 mm



4500

Code	No.	tlg./pcs.			EAN	€
04500000000	4500	55	7420	1	166446	527,80

enthaltend/containing

Stck. pcs.	Artikel/article	No.	Maße/size
je 5 each		4512 C	No. 1 2
je 5 each		4530 C	5,5 x 100 6,5 x 125 8 x 150 mm
je 5 each		4535 C	3 x 75 3,5 x 100 mm
je 5 each		4537 C	5,5 x 100 6,5 x 125 8 x 150 10 x 175 mm

Code	No.	tlg./pcs.			EAN	€
04501000000	4501	55	6140	1	166453	428,65

enthaltend/containing

Stck. pcs.	Artikel/article	No.	Maße/size
je 5 each		4511 C	No. 1 2
je 5 each		4530 C	5,5 x 100 6,5 x 125 8 x 150 mm
je 5 each		4535 C	3 x 75 3,5 x 100 4 x 125 mm
je 5 each		4515 C	T20 T25 T30

Code	No.	tlg./pcs.			EAN	€
04502000000	4502	55	4835	1	166460	423,75

enthaltend/containing

Stck. pcs.	Artikel/article	No.	Maße/size
je 5 each		4515 C	T6 T7 T8 T9 T10 T15 T20 T25 T27 T30 T40

4500-100

Verkaufsständer für
2K Schraubendreher, leer

Display stands for
2K Screwdriver, empty

Présentoirs pour tournevis 2K,
vide

Expositor de destornilladores 2K,
vacío

Code	No.	für/for			EAN	€
04500010000	4500-100	4500 4501 4502	1510	1	166408	auf Anfrage on request

4511

Kreuzschlitz-Schraubendreher für PHILLIPS-RECESS-Schrauben

DIN 5262 / ISO 8764-2
Molybdän-Vanadium/
• Chrom-Vanadium
C = verchromt (mit schwarzer Spitze)
mit 2K Kunststoffheft
No. 3+4 = Sechskantklinge mit Schlüsselhilfe

Cross slot screwdrivers for cross slot screws PHILLIPS-RECESS

DIN 5262 / ISO 8764-2
Molybdenum-Vanadium /
• Chrome-Vanadium
C = chromium plated (with black tip)
with 2K plastic handle
No. 3+4 = hexagon blade and additional bolster

Tournevis cruciforme pour vis PHILLIPS-RECESS

DIN 5262 / ISO 8764-2
Molybdène-Vanadium /
• Chrome-Vanadium
C = chromées (avec extrémité brunie)
avec manche en plastique 2K
No. 3+4 = lame hexagonale avec adaptateur de clé de serrage

Destornillador de punta cruciforme para tornillos PHILLIPS-RECESS

DIN 5262 / ISO 8764-2
Molibdeno Vanadio /
• Cromo Vanadio
C = varilla cromada con punta pavonada, mango de plástico 2K
No. 3+4 = varilla exagonal con exágono forjado

4511-01 + 02



4511-0 + 1 + 2



4511-3 + 4

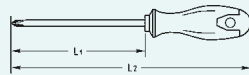

Code	No.	L ₁ mm	L ₂ mm	mm	g	mm	EAN	€
04511000180	01	25	85	—	35	10	165586	7,10
04511000280	02	25	85	—	38	10	165579	7,10
04511000080	0	60	140	—	45	10	165562	4,70
04511001080	1	75	165	—	50	10	165555	5,80
04511002080	2	100	200	—	80	10	165548	7,60
04511003080	• 3	150	260	8/13	160	5	165531	12,70
04511004080	• 4	200	310	10/16	210	5	165593	16,15

4512

Kreuzschlitz-Schraubendreher für POZIDRIV®-Schrauben

DIN 5262 / ISO 8764-2
Molybdän-Vanadium/
• Chrom-Vanadium
C = verchromt (mit schwarzer Spitze)
mit 2K Kunststoffheft
No. 3 = Sechskantklinge mit Schlüsselhilfe

Cross slot screwdrivers for cross slot screws POZIDRIV®

DIN 5262 / ISO 8764-2
Molybdenum-Vanadium /
• Chrome-Vanadium
C = chromium plated (with black tip)
with 2K plastic handle
No. 3 = hexagon blade and additional bolster

Tournevis cruciforme pour vis POZIDRIV®

DIN 5262 / ISO 8764-2
Molybdène-Vanadium /
• Chrome-Vanadium
C = chromées (avec extrémité brunie)
avec manche en plastique 2K
No. 3 = lame hexagonale avec adaptateur de clé de serrage

Destornillador de punta cruiforme para tornillos POZIDRIV®

DIN 5262 / ISO 8764-2
Molibdeno Vanadio/
• Cromo Vanadio
C = varilla cromada con punta pavonada, mango de plástico 2K
No. 3 = varilla exagonal con exágono forjado

4512-01 + 02



4512-0 + 1 + 2



4512-3

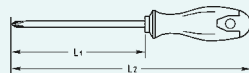

Code	No.	L ₁ mm	L ₂ mm	mm	g	mm	EAN	€
04512000180	01	25	85	—	35	10	165821	6,60
04512000280	02	25	85	—	38	10	165814	6,60
04512000080	0	60	140	—	45	10	165807	5,40
04512001080	1	75	165	—	50	10	165791	6,55
04512002080	2	100	200	—	80	10	165784	9,00
04512003080	• 3	150	260	8/13	160	5	165777	13,15

4515

Schraubendreher für Innen-TORX®-Schrauben

Molybdän-Vanadium
C = verchromt (mit schwarzer Spitze)
mit 2K Kunststoffheft

TORX®-Screwdrivers
für TORX®-Socket screws

Molybdenum-Vanadium
C = chromium plated (with black tip)
with 2K plastic handle

Tournevis
pour vis TORX® intérieures

Molybdène-Vanadium
C = chromées (avec extrémité brunie)
avec manche en plastique 2K

Destornillador
para tornillos TORX®

Molibdeno Vanadio
C = varilla cromada con punta pavonada,
mango de plástico 2K

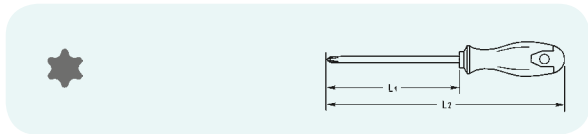

Code	Größe size	★ mm	L ₁ mm	L ₂ mm	g	g	EAN	€
04515000680	T 6	1,67	60	130	27	10	165760	5,80
04515000780	T 7	1,99	60	140	27	10	165753	5,80
04515000880	T 8	2,31	60	140	29	10	165746	5,80
04515000980	T 9	2,50	60	140	29	10	165739	5,80
04515001080	T 10	2,74	100	180	45	10	165722	6,30
04515001580	T 15	3,27	100	190	45	10	165715	6,40
04515002080	T 20	3,86	100	200	70	10	165708	6,80
04515002580	T 25	4,43	100	200	70	10	165692	7,15
04515002780	T 27	4,99	100	200	70	10	165685	7,35
04515003080	T 30	5,52	115	225	100	5	165678	8,05
04515004080	T 40	6,65	125	235	145	5	165661	8,60

4530

Werkstatt-Schraubendreher für Schlitzschrauben

DIN 5265 / ISO 2380-2
Chrom-Vanadium
C = verchromt (mit schwarzer Spitze)
mit 2K Kunststoffheft

Engineers' screwdrivers
for plain slot screws

DIN 5265 / ISO 2380-2
Chrome-Vanadium
C = chromium plated (with black tip)
with 2K plastic handle

Tournevis d'atelier
pour vis à fente

DIN 5265 / ISO 2380-2
Chrome-Vanadium
C = chromées (avec extrémité brunie)
avec manche en plastique 2K

Destornillador de mecánico
de punta plana

DIN 5265 / ISO 2380-2
Cromo Vanadio
C = varilla cromada con punta pavonada
mango de plástico 2K

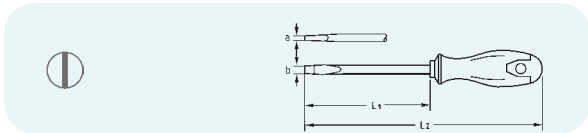

Code	a mm	b mm	L ₁ mm	L ₂ mm	g	g	EAN	€
04530010080	1,0	5,5	100	200	100	10	165470	7,15
04530012580	1,2	6,5	125	225	125	10	165463	7,65
04530015080	1,2	8,0	150	260	190	10	165456	10,60
04530020080	1,6	10,0	200	310	200	5	165449	13,30
04530025080	2,0	12,0	250	360	280	5	165432	17,00
04530030080	2,5	14,0	300	410	300	5	165425	19,65

4535

Elektriker-Schraubendreher für Schlitzschrauben

Chrom-Vanadium
C = verchromt (mit schwarzer Spitze)
mit 2K Kunststoffheft

Electricians' screwdrivers
for plain slot screws

Chrome-Vanadium
C = chromium plated (with black tip)
with 2K plastic handle

Tournevis d'électricien
pour vis à fente

Chrome-Vanadium
C = chromées (avec extrémité brunie)
avec manche en plastique 2K

Destornillador de electricista
punta plana

Cromo Vanadio
C = varilla cromada con punta pavonada
mango de plástico 2K

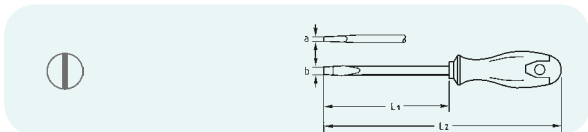

Code	a mm	b mm	L ₁ mm	L ₂ mm	g	g	EAN	€
04535006080	0,4	2,5	60	130	27	10	165302	4,60
04535007580	0,5	3,0	75	155	30	10	165319	4,10
04535010080	0,5	3,5	100	180	45	10	165326	5,25
04535012580	0,8	4,0	125	215	58	10	165333	4,90
04535015080	0,8	5,0	150	250	76	10	165340	6,25
04535020080	0,8	5,0	200	300	85	10	165357	8,55

4537

Werkstatt-Schraubendreher für Schlitzschrauben

Chrom-Vanadium
C = verchromt (mit schwarzer Spitze) mit Sechskantklinge und Schlüsselhilfe und 2K Kunststoffheft

Engineers' screwdrivers for plain slot screws

Chrome-Vanadium
C = chromium plated (with black tip) with hexagon blade and additional bolster and 2K plastic handle

Tournevis d'atelier pour vis à fente

Chrome-Vanadium
C = chromées (avec extrémité brunie) avec lame hexagonal et adaptateur de clé de serrage et manche en plastique 2K

Destornillador de mecánico de punta plana

Cromo Vanadio
C = varilla cromada con punta pavonada, perfil exagonal con exágono forjado, mango de plástico 2K

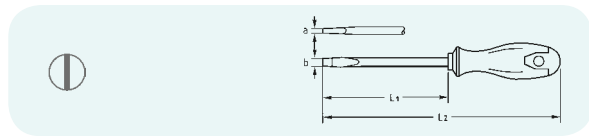

Code	a mm	b mm	L ₁ mm	L ₂ mm	Hex mm	g	mm	EAN	€
04537010080	1,0	5,5	100	200	5/8	74	10	165371	7,95
04537012580	1,2	6,5	125	225	6,35/10	100	10	165388	9,35
04537015080	1,2	8,0	150	260	8/13	160	10	165395	12,25
04537017580	1,6	10,0	175	285	10/16	220	10	165401	15,00
04537020080	2,0	12,0	200	310	10/16	250	5	165418	17,20
04537025080	2,5	14,0	250	360	10/16	285	5	165364	22,90

4545

Vergaser-Schraubendreher für Schlitzschrauben

Chrom-Vanadium
C = verchromt (mit schwarzer Spitze) mit 2K Kunststoffheft

Stubby screwdrivers for plain slot screws

Chrome-Vanadium
C = chromium plated (with black tip) with 2K plastic handle

Tournevis boule pour vis à fente

Chrome-Vanadium
C = chromées (avec extrémité brunie) avec manche en plastique 2K

Destornillador corto punta plana

Cromo Vanadio
C = varilla cromada con punta pavonada mango de plástico 2K

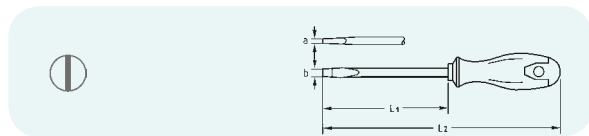

Code	a mm	b mm	L ₁ mm	L ₂ mm	g	mm	EAN	€
04545004080	0,8	4,0	25	85	35	10	165494	5,75
04545006080	1,2	6,5	25	85	38	10	165487	5,95

3301-1

Magnet Bithalter

Zur Aufnahme von Bits mit Außensechskant 1/4", Klinge verchromt, mit 2-K Kunststoffheft

Magnetic bitholder

For bits 1/4"-drive, chromium plated with 2K plastic handle

Adaptateur magnétique

Pour embots 1/4", couteau chromatisé, avec manche à 2 composantes

Adaptador imantado para puntas de destornillador

Para acoplamiento de puntas con exágono exterior de 1/4", hoja cromada, mango de plástico de dos componentes



Code	No.	←L→ mm	g	mm	EAN	€
03301010080	3301-1	200	102	10	366204	15,40

4560

Schraubendreher-Satz
für Innen-TORX®-
Schrauben

Screwdriver set
for TORX®-Socket screws

Jeux de tournevis
pour vis TORX® intérieures

Conjunto de destornilladores
para tornillos TORX®



Code	tlg./pcs.			EAN	€
04560000080	6	600	1	167702	48,30

enthaltend/containing

Stck. pcs.	Artikel/article	No.	Maße/size
je 1 each		4515 C	T10 T15 T20 T25 T30 T40



4561 - 4563

Schraubendreher-Sätze
für Schlitzschrauben

Screwdriver sets
for plain slot screws

Jeux de tournevis
pour vis à fente

Conjunto de destornilladores
para tornillos ranurados



Code	No.	tlg./pcs.			EAN	€
04561000080	4561	7	383	1	359107	40,70

enthaltend/containing

Stck. pcs.	Artikel/article	No.	Maße/size
je 1 each		4535 C	60 x 2,5 x 0,4 75 x 3 x 0,5 100 x 3,5 x 0,5 125 x 4 x 0,8 150 x 5 x 0,8 mm
je 1 each		4545 C	25 x 4 25 x 6,5 mm



Code	No.	tlg./pcs.			EAN	€
04562000080	4562	6	689	1	359114	59,60

enthaltend/containing

Stck. pcs.	Artikel/article	No.	Maße/size
je 1 each		4537 C	100 x 5,5 x 1 125 x 6,5 x 1,2 150 x 8 x 1,2 175 x 10 x 1,6 mm
je 1 each		4545 C	25 x 4 25 x 6,5 mm

Code	No.	tlg./pcs.			EAN	€
04563000080	4563	6	482	1	359121	44,95

enthaltend/containing

Stck. pcs.	Artikel/article	No.	Maße/size
je 1 each		4530 C	100 x 5,5 x 1 125 x 6,5 x 1,2 150 x 8 x 1,2 mm
je 1 each		4535 C	75 x 3 x 0,5 mm
je 1 each		4545 C	25 x 4 25 x 6,5 mm

4564 - 4567

Schraubendreher-Sätze | Screwdriver sets



4564



Jeux de tournevis

Conjuntos de destornilladores

Code	No.	tlg./pcs.			EAN	€
04564000080	4564	7	700	1	166507	53,65

enthaltend/containing

Stck. pcs.	Artikel/article	No.	Maße/size
je 1 each		4530 C	6,5 x 125 8 x 150 mm
je 1 each		4535 C	2,5 x 60 3 x 75 5 x 150 mm
je 1 each		4512 C	PZ No. 1 2

Code	No.	tlg./pcs.			EAN	€
04565000080	4565	7	700	1	166514	51,45

wie 4564, jedoch/as 4564, but

Stck. pcs.	Artikel/article	No.	Maße/size
je 1 each		4511 C	PH No. 1 2

Code	No.	tlg./pcs.			EAN	€
04566000080	4566	6	510	1	359138	48,55

enthaltend/containing

Stck. pcs.	Artikel/article	No.	Maße/size
je 1 each		4511 C	PH No. 01 02 0 1 2 3

Code	No.	tlg./pcs.			EAN	€
04567000080	4567	5	615	1	166491	51,05

enthaltend/containing

Stck. pcs.	Artikel/article	No.	Maße/size
je 1 each		4537 C	5,5 x 100 6,5 x 125 8 x 150 mm
1		4512 C	PZ No. 2
1		4511 C	PH No. 2



Sicherheitswerkzeuge

1000 Volt / DIN EN 60900
(VDE 0682, Teil 201)

Insulated safety tools

1000 Volt / DIN EN 60900
(VDE 0682, part 201)

Outils de sécurité

1000 Volt / DIN EN 60900
(VDE 0682, part 201)

Herramientas de seguridad

1000 voltios / DIN EN 60900
(VDE 0682, apartado 201)

4511

VDE Kreuzschlitz-Schraubendreher für PHILLIPS-RECESS-Schrauben

DIN 7438
Molybdän-Vanadium
BV = brüniert
schutzisoliert gemäß DIN EN 60900
mit eingespritzt ummantelter Klinge,
mit 2K Kunststoffheft

VDE Cross slot screwdrivers for cross slot screws PHILLIPS-RECESS

DIN 7438
Molybdenum-Vanadium
BV = gun-metal finish, VDE 1000
volt insulated, complying with
DIN EN 60900, insulation of blade
and handle injection moulded as
one unit, with 2K plastic handle

VDE Tournevis cruciforme pour vis PHILLIPS-RECESS

DIN 7438
Molybdène-Vanadium
BV = brunis
isolés conformément aux spécifications
DIN EN 60900
isolation de la lame par injection,
avec manche en plastique 2K

VDE Destornillador cruciforme para tornillos PHILLIPS-RECESS

DIN 7438
Molibdeno Vanadio
BV = varilla pavonada
aislamiento de seguridad según
DIN EN 60900
varilla con aislamiento inyectado,
mango de plástico 2K



Code	No.	L ₁ mm	L ₂ mm	g	pcs	EAN	€
04511001033	1	80	170	50	10	165524	7,65
04511002033	2	100	200	80	10	165517	9,50
04511003033	3	150	260	145	10	165500	11,60

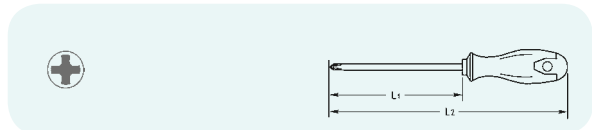

4536

VDE Elektriker-Schraubendreher für Schlitzschrauben

DIN 7437
Chrom-Vanadium
BV = brüniert
schutzisoliert gemäß DIN EN 60900
mit eingespritzt ummantelter Klinge
mit 2K Kunststoffheft

VDE Electricians' screwdrivers for plain slot screws

DIN 7437
Chrome-Vanadium
BV = gun-metal finish,
VDE 1000 volt insulated
complying with DIN EN 60900,
insulation of blade and handle
injection moulded as one unit
with 2K plastic handle

VDE Tournevis d'électricien pour vis à fente

DIN 7437
Chrome-Vanadium
BV = brunis
isolés conformément aux spécifications
DIN EN 60900
isolation de la lame par injection
avec manche en plastique 2K

VDE Destornillador de electricista punta plana

DIN 7437
Cromo Vanadio
BV = varilla pavonada
aislamiento de seguridad según
DIN EN 60900
varilla con aislamiento inyectado
mango de plástico 2K



Code	a mm	b mm	L ₁ mm	L ₂ mm	g	pcs	EAN	€
04536007533	0,4	2,5	75	145	23	10	165289	7,15
04536010033	0,5	3,5	100	180	31	10	165272	8,25
04536010133	0,8	4,0	100	180	44	10	165265	8,85
04536012533	1,0	5,5	125	215	70	5	165258	8,85
04536015033	1,2	6,5	150	250	85	5	165241	9,40

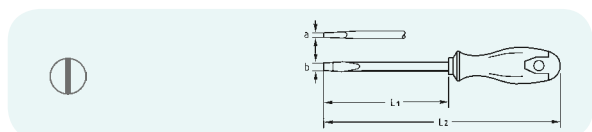

4550

VDE Schraubendreher-Satz

VDE Screwdriver set

VDE Jeux de tournevis

VDE Conjunto de destornilladores



Code	No.	tlg./pcs.	g	pcs	EAN	€
04550000033	4550 VDE	7	630	1	166521	66,15

enthaltend/containing

Stck. pcs.	Artikel/article	No.	Maße/size
je 1 each		4536 VDE	2,5 x 75 4 x 100 5,5 x 125 6,5 x 150 mm
1		1427 VDE	3 x 65 mm
je 1 each		4511 VDE	PH No. 1 2

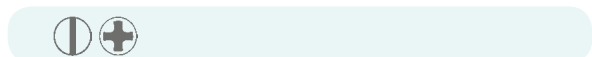





	224 – 225
	226 – 227
	228 – 233
	233
	234
	235 – 236
	237
	237 – 239
	238 – 239
	
	240 – 242
	242
	243 – 244
	
	244 – 245
	245 – 246
	247 – 251
	251 – 253
	
	254
	255 – 261
	

1500

Reifen- und Montageheber

Tyre levers

Chrom-Vanadium
C = verchromt
profiliert gesenkgeschmiedet

Chrome-Vanadium
C = chromium plated
profiled drop forged, straight



Démonte-pneus

Chrome-Vanadium
C = chromées
acier profilé forgé, forme droite

Desmontables

Cromo Vanadio
C = cromado
perfil forjado, rectos

Code	←L→		mm	g	mm	EAN	€
	mm	"					
01500030080	300	12	22 x 7,0	195	10	029383	13,90
01500040080	400	16	25 x 7,5	380	10	029406	18,90
01500050080	500	20	27 x 9,0	645	10	029413	25,00
01500060080	600	24	27 x 11,0	920	10	029420	33,80

1505

Reifen- und Montageheber

Tyre levers

Chrom-Vanadium
C = verchromt
profiliert gesenkgeschmiedet

Chrome-Vanadium
C = chromium plated
profiled drop forged, straight



Démonte-pneus

Chrome-Vanadium
C = chromées
acier profilé forgé, forme droite

Desmontables

Cromo Vanadio
C = cromado
perfil forjado, rectos

Code	←L→		mm	g	mm	EAN	€
	mm	"					
01505040080	400	16	25 x 7,5	350	10	029437	23,50
01505050080	500	20	28 x 8,6	520	10	029444	32,60
01505060080	600	24	28 x 8,6	730	10	029451	38,85

1509

Reifen- und Montageheber

Tyre levers

L = lackiert

L = lacquered



Démonte-pneus

L = laquées

Desmontables

L = barnizado

Code	Mercedes-Benz No.	←L→		g	mm	EAN	€
		mm	"				
01509045020	0005811758	450	18	760	5	029468	32,55
01509060020	0005812158	600	24	1530	1	029475	52,90

1577

Zimmermanns-Nageleisen

Goose neck ripping bars

L = lackiert

L = lacquered



Pince à décoffrer

L = laquées

Palanca para albañiles

L = barnizado

Code	No.	←L→		mm	g	mm	EAN	€
		mm	"					
01577040000	1577-400	400	17	860	5	387001	11,55	
01577050000	1577-500	500	17	1080	5	387018	12,60	
01577060000	1577-600	600	17	1300	5	387025	13,65	
01577080000	1577-800	800	19	2120	5	387032	19,00	
01577100000	1577-1000	1000	19	2600	5	387049	23,20	

103

Spezial-Hebeleisen

Special pry bars

Chrom-Vanadium
C = verchromt
profiliert gesenkgeschmiedet

Chrome-Vanadium
C = chromium plated
profiled drop forged



Barres de levier spéciales

Chrome-Vanadium
C = chromées
forgée profilée

Palanca especial

Cromo Vanadio
C = cromado
perfil forjado

Code	No.	←L→		mm	g	mm	EAN	€
		mm	"					
50210340800	103	400	14	480	5	056532	33,30	

113

Hebeleisen

Chrom-Vanadium
C = verchromt
profiliert gesenkgeschmiedet

Pry bars

Chrome-Vanadium
C = chromium plated
profiled drop forged

Barres de levier

Chrome-Vanadium
C = chromées
forgée profilée

Palanca

Cromo Vanadio
C = cromado
perfil forjado



Code	No.	←L→ mm	● mm	⚖ g	📦	EAN	€
50211340800	113	400	14	500	5	056624	33,30

1512

Kunststoffschaber

Glasfaserverstärkt

Plastic scraper

Glass fibre reinforced

Grattoir plastique

Renforcé fibre de verre

Rascador de plástico

Reforzado con fibra de vidrio



Code	←L→ mm	⚖ g	📦	EAN	€
91512028000	280	110	5	327120	21,40

1513

Reifen-Montierwerkzeug

- Hergestellt aus Polyamide, glasfaserverstärkt
- Das hochwertige Material verspricht absoluten Schutz vor Beschädigungen an Aluminium und lackierten Felgen
- Mehr Kontaktfläche an Felge und Reifen
- Optimale Handhabung durch Handgriff

Tyre change presser

- Polyamide, fiberglass-reinforced
- The high grade material grants full protection against damages of aluminium and coated rims
- More contact surface to the rim and tire
- Optimum handling through handle

Outil montage de pneu

- Le matériel de haute qualité
- Le matériel de haute qualité promet une protection absolue contre les dégâts à l'aluminium et les jantes peintes
- Plus de contact sur la jante et le pneu
- Prise en main optimale du manche

Herramienta para montar neumáticos

- De poliamida reforzada por fibra de vidrio
- El material de alta calidad otorga una perfecta protección contra daños en llantas de aluminio o pintadas
- Mayor superficie de contacto en llanta y neumático
- Manejo óptimo gracias a su asa



Code	←L→ mm	⚖ g	📦	EAN	€
01513000000	290 x 150	110	1	375732	26,00



YouTube



1520

Schlosserhämmer

DIN 1041
LS = lackiert, Bahn und Pinne
geschliffen
deutsche Form, doppelt-geschweifert
Eschenstiel nach DIN 5111
kunststoffversiegelt

Engineers' hammers

DIN 1041
LS = lacquered, polished face and
pein
German pattern, with curved ash
handle to DIN 5111
sealed with plastic



Marteaux de mécanicien

DIN 1041
LS = laquées, panne et face meulées
modèle allemand, manche en frêne selon
DIN 5111
scellement plastique

Martillos de peña

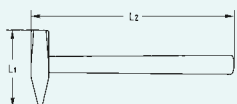
DIN 1041
LS = barnizado, cara y peña amoladas
modelo alemán, mango de madera de
fresno según DIN 5111,
enmangado con remate de plástico



Code	 g	L ₁ mm	L ₂ mm	 g		EAN	€
01520020021	200	95	280	265	6	029499	9,80
01520030021	300	105	300	380	6	029505	11,75
01520040021	400	105	310	490	6	029512	13,35
01520050021	500	118	320	585	6	029529	13,90
01520080021	800	130	350	930	6	029536	19,70
01520100021	1000	135	360	1135	6	029543	22,15
01520200021	2000	155	400	2190	1	029567	38,85

1522

Schlosserhämmer

AS = schwarz, Bahn und Pinne
geschliffen
englische Form, Kugelpinne,
Eschenstiel

Engineers' ball pein hammers

AS = black, polished face and pein
English pattern, ball pein,
ash handle



Marteaux de mécanicien

AS = noirs, panne et face meulées
modèle anglais, panne bombée,
manche en frêne

Martillos de bola

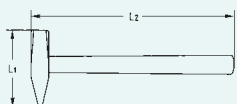
AS = barnizado en negro,
frente y bola amoladas
modelo inglés,
mango de madera de fresno



Code	 lbs.	L ₁ mm	L ₂ mm	 g		EAN	€
01522050011	1/2	80	300	315	6	029581	20,40
01522075011	3/4	88	330	420	6	029598	20,55
01522100011	1	100	355	550	6	029604	21,80
01522150011	1.1/2	112	380	815	6	029628	28,60
01522200011	2	121	400	1135	6	029635	34,90

1523

Kupferhammer

mit Eschenstiel

Copper hammer

with ash handle



Marteau cuivre

manche fêne

Martillo de cobre

con mango de madera de fresno



Code	 g	 g		EAN	€
01523075000	750	780	1	385939	45,80

1530

Rückschlagfreie Nylonhämmer

ST = standardmäßig
Gehäuse mit Stahlschrot gefüllt – durch Gewichtsverlagerung beim Auftreffen optimale, rückprallfreie Schlagwirkung
auswechselbare Nylonköpfe, Hickory-Stiel

“Dead Blow” nylon hammers

ST = standard
Housing is partially filled with steel shot, which adds to the weight, prevents rebound and provides “dead blows” of maximum impact
replaceable nylon heads, hickory handle

Massettes à embouts nylon, sans rebond

ST = standard
Le corps est rempli par de la grenaille – lors du choc, le mouvement de cette grenaille dans la cavité du corps élimine le rebond des marteaux
embouts de nylon interchangeables, manche hickory

Martillos con bocas de nylon, sin rebote

ST = estándar
Cabeza con relleno de granalla, cuyo desplazamiento al golpear amortigua el rebote, bocas de nylon intercambiables, mango de madera de hickory

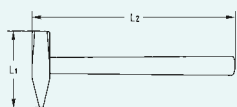

Code	Ø mm	L ₁ mm	L ₂ mm	g	g	EAN	€
01530002500	25	105	305	295	2	029680	49,30
01530003000	30	110	330	440	2	029697	53,35
01530003500	35	110	330	545	2	029703	58,05
01530004000	40	115	355	745	2	029710	66,70
01530005000	50	120	365	1030	2	029734	83,75

1531

Nylon-Ersatzköpfe

ST = standardmäßig
für rückschlagfreie Hämmer
HEYCO 1530

Spare nylon heads

ST = standard
for “dead blow” hammers
HEYCO 1530

Embouts de nylon interchangeables

ST = standard
pour massettes sans rebond
HEYCO 1530

Bocas de nylon, de recambio

ST = estándar
para martillos sin rebote
HEYCO 1530



Code	Ø mm	g	g	EAN	€
01531002500	25	11	10	029758	6,80
01531003000	30	17	10	029765	7,85
01531003500	35	23	10	029772	9,35
01531004000	40	33	10	029789	10,95
01531005000	50	55	10	029802	14,65

Weitere Kunststoffhämmer und entsprechende Ersatzköpfe finden Sie unter HEYCO 2165 – 2166

Further plastic hammers and spare heads can be found under HEYCO 2165 – 2166

Pour d'autres modèles et embouts de recharge: voir les références HEYCO 2165 – 2166

Para otros modelos de martillos con bocas de plástico y sus recambios, véase HEYCO 2165 – 2166.

1540-1

Gummihämmer

DIN 5128 A
ST = standardmäßig
zwei gerade Flächen
Eschenstiel

Rubber mallets

DIN 5128 A
ST = standard
two flat faces
ash handle

Maillets caoutchouc

DIN 5128 A
ST = standard
deux faces plates
manche en frêne

Mazos de goma

DIN 5128 A
ST = estándar
dos bocas planas
mango de madera de fresno

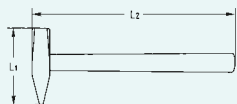

Code	Ø mm	L ₁ mm	L ₂ mm	g	g	EAN	€
01540000100	54	90	320	330	1	029833	8,80
01540000400	90	140	380	1200	1	382693	16,65

Chrom-Vanadium mit
Sicherheitsschlagkopf

Chrome-Vanadium with
non-spreading safety head

Chrome-Vanadium
avec tête de sécurité

Cromo Vanadio
con cabezal de golpe de seguridad

1550 – 1551

**Werkzeugsätze mit
Meißeln, Körnern,
Splint- und Durchtreibern**

6-tlg.
Chrom-Vanadium
LS = lackiert, Spitzen und Schneiden
geschliffen
achtkantige Form, Lufthärtestahl,
Sicherheitsschlagköpfe

1550 im Holzständer
1551 in klappbarer Metallkassette

Chisel and punch sets

6 pcs.
Chrome-Vanadium
LS = lacquered, ground points and
blades
octagonal shape, air hardening
steel, non-spreading safety heads

1550 in wooden bench stand
1551 in hinged metal box

**Compositions de burins,
bédanes et chasse-clous**

6 pcs.
Chrome-Vanadium
LS = laquées, tiges et tranchants/taillants
meulés
modèle octogonal, acier autotremplant, tête
traînée pour éviter le champignonage

1550 en présentoir de bois
1551 en boîte métallique, repliable

**Conjuntos de herramientas
compuestos de cortafíos,
buriles, granetes y punzones
cónicos**



6 pzs.
Cromo Vanadio
LS = barnizado, puntas y cortantes
amolados
mango octogonal, acero autotemplante,
cabezas con revenido especial

1550 en expositor de madera
1551 en caja metálica plegable



1550

1551

Code	No.	enthaltend/containing					EAN	€
		Stck./pcs.	No.	Maße/dimensions				
0155000021	1550	1	1555 spezial/special	125 x 10	585	2	029888	48,30
		1	1555 spezial/special	150 x 15				
		1	1560 spezial/special	125 x 4				
		1	1570	120 x 3				
		1	1570	150 x 4				
		1	1575	120 x 4				
0155100021	1551	Inhalt wie vor/contents as above			845	1	029895	51,85

1555 – 1555-1

**Flachmeißel mit
Sicherheitsschlagkopf**

DIN 6453
Chrom-Vanadium
1555
LS = lackiert, Blatt und Schneide
geschliffen
1555-1
ST = standardmäßig mit
Handschutzgriff (Meißel – lackiert,
Blatt und Schneide geschliffen
Handschutzgriff – Kunststoff,
schwarz)
flach-ovale Form, Lufthärtestahl,
Sicherheitsschlagköpfe

**Flat cold chisel with non-
spreading safety head**

DIN 6453
Chrome-Vanadium
1555
LS = lacquered, ground blade and
cutting edge
1555-1
ST = standard, with hand guard
(chisel – lacquered, ground blade
and cutting edge, hand guard –
plastic, black)
flat-oval shape, air-hardening steel,
non-spreading safety head

**Burins de mécanicien avec
tête de sécurité**

DIN 6453
Chrome-Vanadium
1555
LS = laquées, tranchant et taillant meulés
1555-1
ST = standard avec protecteur
(burin – laqué, tranchant et taillant meulés,
protecteur – plastique noir)
modèle plat-oval, acier autotremplant, tête
traînée pour éviter le champignonage

**Cortafíos con
cabeza de seguridad**



DIN 6453
Cromo Vanadio
1555
LS = barnizado, boca y cortante amolados
1555-1
ST = estándar, con salvamanos
(mango – barnizado, boca y cortante
amolados salvamanos – plástico negro)
mango ovalado-plano, acero
autotemplante, cabezas con revenido
especial

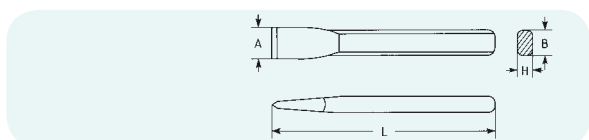

1555

1555-1



Code	No.	←L→		A	B	C			EAN	€
		mm	"							
01555012521	1555	125	5	16	14	9	105	5	029932	5,20
01555015021	1555	150	6	18	17	11	180	5	029949	6,20
01555017521	1555	175	7	22	20	12	270	5	029963	7,80
01555020021	1555	200	8	25	23	13	385	5	029970	9,40
01555025021	1555	250	10	25	23	13	495	5	029987	10,40
01555030021	1555	300	12	26	23	13	610	5	029994	12,00
*01555125000	1555-1	250	10	25	23	13	595	5	030006	13,00

*1555-1 mit Handschutz / with hand guard

1556

Steinmeißel mit Sicherheitsschlagkopf

DIN 7254
Chrom Vanadium
LS = lackiert, Blatt und Schneide geschliffen

Stone chisel with non-spreading safety head

DIN 7254
Chrome-Vanadium
LS = lacquered, ground blade and cutting edge

Burin avec tête de sécurité

DIN 7254
Chrome-Vanadium
LS = laquées, tranchant et taillant meulés

Cinzel para canteros con cabeza de seguridad

DIN 7254
Cromo Vanadio
LS = barnizado, boca y cortante amolados



Code	←L→ mm	mm	mm	g	mm	EAN	€
01556012521	125	10	12	80	10	386677	4,40
01556015021	150	12	16	120	10	386714	5,20
01556017521	175	14	20	260	10	386721	7,30
01556020021	200	16	22	300	10	386738	8,30

1557 - 1557-1

Schlitzmeißel mit Sicherheitsschlagkopf

Chrom Vanadium
LS = lackiert, Blatt und Schneide geschliffen

Joining chisel with non-spreading safety head

Chrome-Vanadium
LS = lacquered, ground blade and cutting edge

Burin à fendre avec tête de sécurité

Chrom-Vanadium
LS = laquées, tranchant et taillant meulés

Cinzel extraplano con cabeza de seguridad

Cromo Vanadio
LS = barnizado, boca y cortante amolados



1557

1557-1

Code	←L→ mm	mm	mm	g	mm	EAN	€
01557023021	230	26 x 7	26	300	10	030020	9,90
*01557123000	230	26 x 7	26	420	5	030037	12,50

*1557-1 mit Handschutz / with hand guard

1558 - 1558-1

Fugenmeißel mit Sicherheitsschlagkopf

Chrom Vanadium
LS = lackiert, Blatt und Schneide geschliffen

Grooving chisel with non-spreading safety head

Chrome-Vanadium
LS = lacquered, ground blade and cutting edge

Burin plat avec tête de sécurité

Chrom-Vanadium
LS = laquées, tranchant et taillant meulés

Cinzel para juntas con cabeza de seguridad

Cromo Vanadio
LS = barnizado, boca y cortante amolados



1558

1558-1

Code	←L→ mm	mm	mm	g	mm	EAN	€
01558250021	250	23 x 13	50	500	5	386844	13,50
*01558125000	250	23 x 13	50	600	5	030051	16,10

*1558-1 mit Handschutz / with hand guard

1560 - 1560-1

Kreuzmeißel mit Sicherheitsschlagkopf

DIN 6451
Chrom-Vanadium
LS = lackiert, Blatt und Schneide geschliffen, flach-ovale Form, Lufthärtetestahl, Sicherheits-Schlagkopf

Cross cut chisels with non-spreading safety head

DIN 6451
Chrome-Vanadium
LS = lacquered, ground blade and cutting edge, flat-oval shape, air-hardening steel, non-spreading safety head

Burin en croix avec tête de sécurité

DIN 6451
Chrom-Vanadium
LS = laquées, tranchant et taillant meulés, modèle plat-ovale, acier autotremant, tête traitée pour éviter le champignonage

Buril con cabeza de seguridad

DIN 6451
Cromo Vanadio
LS = barnizado, boca y cortante amolados, mango ovalado-plano, acero autotemplante, cabezas con revenido especial



1560

1560-1

Code	No.	mm	←L→ "	g	mm	EAN	€
01560012521	1556	125	6	80	5	030075	5,70
01560015021	1556	150	6	160	5	030082	6,80
01560017521	1556	175	7	240	5	030099	7,80
01560020021	1556	200	8	330	5	030105	9,40
01560025021	1556	250	6	360	5	030112	10,40
*01560125000	1556-1	250	6	560	5	386660	13,00

*1560-1 mit Handschutz / with hand guard

1561

Kreuzmeißel mit Sicherheitsschlagkopf

DIN 6451
Chrom-Vanadium
LS = lackiert, Blatt und Schneide geschliffen

Cross cut chisels with non-spreading safety head

DIN 6451
Chrome-Vanadium
LS = lacquered, ground blade and cutting edge

Burin en croix avec tête de sécurité

DIN 6451
Chrome-Vanadium
LS = laquées, tranchant et taillant meulés

Buril con cabeza de seguridad

DIN 6451
Cromo Vanadio
LS = barnizado, boca y cortante amolados

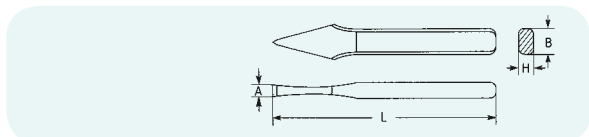

Code	←L→ mm	● mm	↖ mm	g	📦	EAN	€
01561012521	125	10	5	80	10	386745	4,40
01561015021	150	12	6	120	10	030082	5,20
01561017521	175	16	8	220	10	030099	7,30
01561020021	200	16	9	260	10	030105	8,30

1563 – 1563-1

Steinmeißel mit Sicherheitsschlagkopf

DIN 7254
Chrom Vanadium
LS = lackiert, Blatt und Schneide geschliffen

Stone chisel with non-spreading safety head

DIN 7254
Chrome-Vanadium
LS = lacquered, ground blade and cutting edge

Burin de maçon avec tête de sécurité

DIN 7254
Chrome-Vanadium
LS = laquées, tranchant et taillant meulés

Cinzel de canteros con cabeza de seguridad

DIN 7254
Cromo Vanadio
LS = barnizado, boca y cortante amolados



Code	←L→ mm	● mm	↖ mm	g	📦	EAN	€
01563020021	200	20 x 12	26	320	10	386783	7,80
01563025021	250	20 x 12	26	480	10	386790	9,40
01563030021	300	23 x 13	32	600	10	386806	10,40
01563040021	400	23 x 13	32	780	5	386813	13,50
*01563130000	300	20 x 12	26	720	10	386820	13,00
*01563140000	400	23 x 13	32	900	5	386837	16,10

*1563-1 mit Handschutz / with hand guard

1562-1

Handschutz

ST = standardmäßig (Kunststoff, schwarz) für Meißel HEYCO 1555 ab 250 mm Länge

Hand guards

ST = standard (plastic, black) for chisels HEYCO 1555 as from 250 mm

Protecteurs

ST = standard (plastique noir) pour HEYCO 1555, à partir d'une longueur de 250 mm

Salvamanos

ST = estándar (plástico negro) para cotaríos y buriles HEYCO 1555, a partir de 250 mm de largo



Code	für Meißel/for chisel			g	📦	EAN	€
	No.	mm	Schaft/shaft-mm				
01562000100	1555	250	23 x 13	100	10	030150	2,35
	1555	300	23 x 13				

1564

Splinttreiber mit Zapfen

DIN 6450 C
Chrom-Vanadium

Parallel pin punch with pin

DIN 6450 C
Chrome-Vanadium

Chasse-goupilles

DIN 6450 C
Chrome-Vanadium

Punzones con pistón

DIN 6450 C
Cromo Vanadio



Code	mm	∅ "	←L→ mm	MM	g	📦	EAN	€
01564000621	6	15/64	175	10	64	12	387254	5,20

1565

Splinttreiber

DIN 6450 C
Chrom-Vanadium
LS = lackiert, Spitze geschliffen
achtkantige Form, Lufthärtestahl,
Sicherheits-Schlagkopf

Parallel pin punches

DIN 6450 C
Chrome-Vanadium
LS = lacquered, ground point
octagonal shape, air-hardening
steel, non-spreading safety head

Chasse-goupilles

DIN 6450 C
Chrome-Vanadium
LS = laquées, tige meulée
modèle octogonal, acier autotremplant, tête
traitée pour éviter le champignonage

Punzones cilíndricos

DIN 6450 C
Cromo Vanadio
LS = barnizado, punta amolada
mango octogonal, acero autotemplante,
cabeza con revenido especial



Code	mm	Ø "	←L→ mm	MM	g	10	EAN	€
01565000221	2	5/64	150	10	64	10	030174	4,20
01565000321	3	1/8	150	10	66	10	030181	4,20
01565000421	4	5/32	150	10	68	10	030198	4,20
01565000521	5	3/16	150	10	70	10	030211	4,20
01565000621	6	15/64	150	10	72	10	030228	4,20
01565000821	8	5/16	150	12	105	10	030235	4,70
01565001021	10	25/64	150	12	120	10	030242	4,70
01565001221	12	15/32	150	12	160	10	387247	5,20

1565-41

Splinttreiber

Chrom-Vanadium
LS = lackiert, Spitze geschliffen
achtkantige Form, Lufthärtestahl,
Sicherheits-Schlagköpfe
lange Ausführung speziell
für Sicherungsstifte der
Scheibenbremsbeläge

Parallel pin punch

Chrome-Vanadium
LS = lacquered, ground point
octagonal shape, air-hardening
steel, non-spreading safety head
long type particularly for locking
pins for pads of disc brakes

Chasse-goupilles

Chrome-Vanadium
LS = laquées, tige meulée
tête traitée pour éviter le champignonage,
modèle extra-long
speciaux pour les goupilles de sécurité de
plaquettes de frein à disque

Punzones cilíndricos

Cromo Vanadio
LS = barnizado, punta amolada
mango octogonal, acero autotemplante,
cabeza con revenido especial,
modelo largo, especial para bulones de
ferodos de freno



Code	Ø mm	←L→ mm	MM	g	10	EAN	€
01565100421	4,0	175	10	75	10	030259	5,20

1566 - 1567

Werkzeugsätze mit Splinttreibern

6-tlg.
Chrom-Vanadium
LS = lackiert, Spitzen geschliffen
achtkantige Form, Lufthärtestahl,
Sicherheits-Schlagköpfe

1566 im Holzständer
1567 in klappbarer Metallkassette

Parallel pin punch sets

6 pcs.
Chrome-Vanadium
LS = lacquered, ground points
octagonal shape, air-hardening
steel, non-spreading safety heads

1566 in wooden bench stand
1567 in hinged metal box

Compositions de chasse-goupilles

6 pcs.
Chrome-Vanadium
LS = laquées, tige meulée
modèle octogonal, acier autotremplant, tête
traitée pour éviter le champignonage

1566 en présentoir bois
1567 en boîte métallique, repliable

Juegos de punzones cilíndricos

6 pzs.
Cromo Vanadio
LS = barnizado, punta amolada
mango octogonal, acero autotemplante,
cabeza con revenido especial

1566 en expositor de madera
1567 en caja metálica plegable



1566



1567

Code	No.	enthaltend/containing		g	10	EAN	€	
		Stck./pcs.	No. Maße/dimensions					
01566000021	1566	je 1 each	1565	150 x 10 x 3	565	2	030273	37,55
				150 x 10 x 4				
				150 x 10 x 5				
				150 x 10 x 6				
				150 x 12 x 7				
				150 x 12 x 8				
01567000021	1567	Inhalt wie vor/contents as above		800	1	030280	44,20	

1570

Durchschläger mit Sicherheitsschlagkopf

DIN 6458 D
Chrom-Vanadium
LS = lackiert, Spitze geschliffen
achtkantige Form, Lufthärtestahl,
Sicherheits-Schlagkopf

Taper pin punch with non-spreading safety head

DIN 6458 D
Chrome-Vanadium
LS = lacquered, ground point
octagonal shape, air-hardening
steel, non-spreading safety head

Chasse-clous avec tête de sécurité

DIN 6458 D
Chrome-Vanadium
LS = laquées, tige meulée
modèle octogonal, acier autotremant, tête
traînée pour éviter le champignonage

Punzones cónicos con cabeza de seguridad

DIN 6458 D
Cromo Vanadio
LS = barnizado, punta amolada
mango octogonal, acero autotemplante,
cabeza con revenido especial



Code	mm	Ø "	←L→ mm	MM	g	mm	EAN	€
01570000221	2	5/64	120	12	88	10	030310	2,60
01570000321	3	1/8	120	12	89	10	030327	2,60
01570000421	4	5/32	120	12	91	10	030334	2,60
01570000521	5	3/16	120	12	92	10	030341	2,60
01570000621	6	15/64	120	12	94	10	030358	2,60
01570000821	8	5/16	120	12	100	10	030365	2,60
01570001021	10	25/64	150	12	130	10	030372	2,80
01570001221	14	15/32	150	12	180	10	387216	3,60
01570001421	16	9/16	175	12	280	10	387223	5,20
01570001621	18	5/8	175	12	360	10	387230	8,30

1575

Körner mit Sicherheitsschlagkopf

DIN 7250
Chrom-Vanadium
LS = lackiert, Spitze geschliffen
achtkantige Form, Lufthärtestahl,
Sicherheits-Schlagkopf

Center punch with non-spreading safety head

DIN 7250
Chrome-Vanadium
LS = lacquered, ground point
octagonal shape, air-hardening
steel, non-spreading safety head

Pointeaux avec tête de sécurité

DIN 7250
Chrome-Vanadium
LS = laquées, tige meulée
modèle octogonal, acier autotremant, tête
traînée pour éviter le champignonage

Granetes

DIN 7250
Cromo Vanadio
LS = barnizado, punta amolada
mango octogonal, acero autotemplante,
cabeza con revenido especial



Code	mm	Ø "	←L→ mm	MM	g	mm	EAN	€
01575000421	4	5/32	120	10	64	10	030389	2,60
01575000521	5	3/16	150	12	120	10	030396	3,60

1576

Automatischer Körner

Chrom-Vanadium
C = verchromt

Stufenlos einstellbar, Schlagkraft wird durch einfaches Herunterdrücken des Kopfes freigesetzt.
Gerändelte Oberfläche sorgt für sicheren Halt (Abrutschsicher).

Adjustable center punch

Chrome-Vanadium
C = chromium plated

Continuously adjustable, punch will be released by pressing the button.
Knurled surface for a secure fit (prevents slipping).

Pointeau automatique

Chrome-Vanadium
C = chromées

Réglable en continu, la force d'impact est relâchée par simple pression de la tête.
Surface moletée permet une bonne prise en main (antidérapant).

Granete automático

Cromo Vanadio
C = cromado

Graduable sin escalones, la potencia de golpeo se activa por simple apriete del cabezal. Superficie grafilada para una firme sujeción (no resbala).



Code	mm	Ø "	←L→ mm	g	mm	EAN	€
01576013080	2	5/64	135	81	1	372519	22,00

1577

Nietzieher mit Sicherheitsschlagkopf

DIN 6434
Chrom-Vanadium

Rivet-set with non-spreading safety head

DIN 6434
Chrome-Vanadium





Jeu de chasse-rivets tête de sécurité

DIN 6434
Chrome-Vanadium

Sacaremaches con cabeza de seguridad

DIN 6434
Cromo Vanadio



Code			$\leftarrow L \rightarrow$ mm	 mm	 g		EAN	€
01577010200	2	2,5	100	10	60	10	387117	3,60
01577010300	3	3,5	100	10	60	10	387124	3,60
01577010400	4	4,5	100	12	70	10	387131	4,20
01577011500	5	6,0	110	12	100	10	387148	5,20
01577011600	6	7,0	110	14	120	10	387155	5,70

1578

Nietkopfmacher mit Sicherheitsschlagkopf

DIN 6435
Chrom-Vanadium

Rivet-header with non-spreading safety head

DIN 6435
Chrome-Vanadium





Chasse-clous avec tête de sécurité

DIN 6435
Chrome-Vanadium

Buterola con cabeza de seguridad

DIN 6435
Cromo Vanadio



Code			$\leftarrow L \rightarrow$ mm	 mm	 g		EAN	€
01578010200	2	3,5	100	10	60	10	387162	3,60
01578010300	3	5,2	100	10	60	10	387179	3,60
01578010400	4	7,0	100	12	80	10	387186	4,20
01578011500	5	8,8	110	14	140	10	387193	5,20
01578011600	6	10,5	110	16	180	10	387209	5,70

1610

Metallsägebogen, verstellbar

DIN 6473 B
C/CL = verchromt (Bügel) / chromfarbig (Griff) mit Metallsägeblatt HEYCO 1617 (einseitig gezahnt, Schnellstahl)

Adjustable hacksaw frames

DIN 6473 B
C/CL = chromium plated (frame) / chrome coloured (handle) with hacksaw blade HEYCO 1617 (single edge, high speed steel)



Montures de scie, ajustables

DIN 6473 B
C/CL = chromées (archet) / couleur de chrome (manche) avec lame de scie HEYCO 1617 (denture simple, acier rapide)

Arcos de sierra para metales, ajustables

DIN 6473 B
C/CL = cromado (arco) / cromatizado (mango) con hoja de sierra para metales HEYCO 1617 (dientes por un lado, de acero rápido)



Code	$\leftarrow L \rightarrow$ mm	für Blätter/for blades mm	 g		EAN	€
01610000080	450	250 + 300	380	1	030433	20,75

1615 - 1617

Metallsägeblätter

DIN 6494
ST = standardmäßig
24 Zähne per Zoll
1615 einseitig gezahnt, 2% wolframlegiert
1616 doppelseitig gezahnt, 2% wolframlegiert
1617 einseitig gezahnt, Schnellstahl

Hacksaw blades

DIN 6494
ST = standard
24 teeth per inch
1615 single edge, 2% tungsten
1616 double edge, 2% tungsten
1617 single edge, high speed steel

Lames de scie à métaux

DIN 6494
ST = standard
24 dents au pouce
1615 denture simple, 2% tungstène
1616 denture double, 2% tungstène
1617 denture simple, acier rapide

Hojas de sierra para metales

DIN 6494
ST = estándar
24 dientes por pulgada
1615 dientes por un lado, aleación al 2% de wolframio
1616 dientes por los dos lados, aleación al 2% de wolframio
1617 dientes por un lado, acero rápido





1615



1616



1617

Code	No.	Maße/dimensions mm	 g		EAN	€
01615030000	1615	300 x 13 x 0,63	20	50	030457	2,15
01616030000	1616	300 x 25 x 0,80	38	50	030464	2,95
01617030000	1617	300 x 13 x 0,65	20	50	030471	5,25

1621

Hebelblehscheren

Chrom-Molybdän-Stahl,
phosphatiert, HRC 60-62
Schneidekapazität:
Metall bis zu 1,5 mm
Edelstahl bis zu 0,9 mm

Compound action snips

Chrome molybdenum steel,
phosphated, HRC 60-62
Cutting capacity:
Metal up to 1,5 mm
Stainless steel up to zu 0,9 mm

Cisailles à tôle démultipliées

Acier chrome de molybdène
phosphaté, HRC 60-62
Capacité de coupe:
Métal jusqu'à 1,5 mm
Acier inoxydable jusqu'à 0,9 mm

Tijeras para chapa, articuladas

Acero al cromo molibdeno,
fosfatada, HRC 60-62
Capacidad de corte:
Metal hasta 1,5 mm
Acero inox. Hasta 0,9 mm



1621-1 rechtsschneidend/
right hand cutting/coupe droite/
corta a la derecha



1621-2 linksschneidend/
left hand cutting/coupe gauche/
corta a la izquierda



1621-3 gerade/
straight/droite/corta derecho

Code	No.	←L→		g	g	EAN	€
		mm	"				
01621000132	1621-1	260	10.3/8	520	1	030488	38,75
01621000232	1621-2	260	10.3/8	520	1	030495	38,75
01621000332	1621-3	260	10.3/8	480	1	371888	38,75

1622

Hebelblehscheren 90° abgewinkelt

Chrom-Molybdän-Stahl, gesandstrahlt
Geschmiedete Klingen für eine höhere
Festigkeit und längere Lebensdauer,
HRC 60-62
Schneidekapazität:
Metall bis zu 1,2 mm
Edelstahl bis zu 0,7 mm

Universal tinmen's snips 90° bent

Chrome molybdenum steel,
sandblasted
Forged blades for greater strength
and longer durability, HRC 60-62
Cutting capacity:
Metal up to 1,2 mm
Stainless steel up to zu 0,7 mm

Cisailles à tôle démultipliées

Acier chrome de molybdène, sablé
Lame forgées pour une meilleure force
et une plus grande durabilité, HRC 60-62
Capacité de coupe:
Métal jusqu'à 1,2 mm
Acier inoxydable jusqu'à 0,7 mm

Tijeras para chapa, dobladas a 90°

Acero al cromo molibdeno granalladas
Hojas forjadas para una mayor dureza y
duración, HRC 60-62
Capacidad de corte:
Metal hasta 1,2 mm
Acero inox hasta 0,7 mm



1622-1 rechtsschneidend/right hand cutting/coupe droite/corta a la derecha
90° abgewinkelt/bent



1622-2 linksschneidend/left hand cutting/coupe gauche/corta a la izquierda
90° abgewinkelt/bent

Code	No.	←L→		g	g	EAN	€
		mm	"				
01622000132	1622-1	260	10.3/8	520	1	371871	42,85
01622000232	1622-2	260	10.3/8	520	1	371864	42,85

1626

Lochscherer

LG = lackiert, Kopf gesandstrahlt
rechtsschneidend

Hole cutting snip

LG = lacquered, sand blasted head
right hand cutting

Cisailles coupe-trou

LG = laquées, tête sablée
chantourneuse à droite

Tijeras para chapa – de carrocero

LG = barnizado, cabeza granallada
corte a derecha



Code	mm	←L→		g	g	EAN	€
			"				
01626025025	250		10	455	1	030563	29,60



Rohrabschneider / Tube Cutters / Coupe-tube / Cortatubos



1640
Ø 25 mm



1641
Ø 35 mm



1642
Ø 40 mm



1643
Ø 75 mm

* Ersatz-Schneidrad
Replacement cutting wheel
Roulette de rechange
Rueda cortante de repuesto

Hochwertige Ausführung: Zink Druckguß
Schneidräder Titanbeschichtet, für höchste Ansprüche.

Top quality: zinc-die cast
Cutting wheels made of titanium coated for maximum demands.

Exécution de haute qualité: Zingué sous pression
Roues de découpage enrobé de titane, convient pour les hautes performances.

De gran calidad: Fundición inyectada
Ruedas cortantes cubiertas de titanio, para elevadas exigencias.

Extrem runder Lauf durch Federausgleich
Extremely smooth operation by spring compensation
Course circulaire idéale grâce au ressort de compensation
Giro extremadamente redondo gracias a la compensación por muelles

Stufenlose Schneidkrafteinstellung
Variable cutting force adjustment
Ajustement de force de coupe progressif
Ajuste sin escalones de la fuerza de corte

Schneidet selbst ovale Rohre
Even cuts oval tubes
Coupe même les tubes ovales
Incluso corta tubos de sección ovalada



Einfacher Austausch des Schneidrades, ohne Werkzeug
Simple replacement of cutting wheel, without tools
remplacement facile de la roulette de coupe, sans outils
Fácil recambio de la rueda cortante, sin necesidad de herramientas

Exakter Schnitt durch Rollenführung
Precise cut by roller guide
Coupe précise par galet de guidage
Corte preciso gracias a la guía de rodillos



Teleskoparm mit Schnellverstellung
Telescopic arm with quick adjustment
Bras télescopique à réglage rapide
Brazo telescópico de ajuste rápido



1640

Mini-Rohrabschneider

L = lackiert
*Ersatz-Schneiderad



Mini-tube-cutter

L = lacquered
*Replacement cuttingwheel

Mini coupe-tube

L = laquées
*Roulette de rechange

Mini-cortatubos

L = barnizado
*Rueda cortante de repuesto

Code	No.	←L→ mm				EAN	€
0164000020	1640	72	25	145	1	371956	27,05
*01640100000	1640-1			5	1	371925	8,80

1641

Rohrabschneider

L = lackiert
*Ersatz-Schneiderad



Tube-cutter

L = lacquered
*Replacement cuttingwheel

Coupe-tube

L = laquées
*Roulette de rechange

Cortatubos

L = barnizado
*Rueda cortante de repuesto

Code	No.	←L→ mm				EAN	€
0164100020	1641	135	35	250	1	371949	43,70
*01641100000	1641-1			5	1	371918	8,80



1642

Rohrabschneider

L = lackiert, schwere Ausführung
*Ersatz-Schneiderad



Tube-cutter

L = lacquered, heavy version
*Replacement cuttingwheel

Coupe-tube

L = laquées, exécution lourde
*Roulette de rechange

Cortatubos

L = barnizado, modelo fuerte
*Rueda cortante de repuesto

Code	No.	←L→ mm				EAN	€
0164200020	1642	195	40	490	1	371963	88,45
*01642100000	1642-1			5	1	371901	17,70



1643

Rohrabschneider

L = lackiert
*Ersatz-Schneiderad



Tube-cutter

L = lacquered
*Replacement cuttingwheel

Coupe-tube

L = laquées
*Roulette de rechange

Cortatubos

L = barnizado
*Rueda cortante de repuesto

Code	No.	←L→ mm				EAN	€
0164300020	1643	210	75	1010	1	371932	109,25
*01643100000	1643-1			5	1	371895	17,70



1656

Handfeilkloben

Z = verzinkt
geschmiedet, Prisma in den Backen,
Flügelmutter

Hand vices

Z = galvanized
drop forged, jaws with prism,
wing-nut

Etaux à main

Z = galvanisés
corps en acier forgé, mâchoires avec
encoche prismatique, écrou à oreilles

Entenallas

Z = zincado
forjadas, mordazas con perfil prismático,
tuerca mariposa

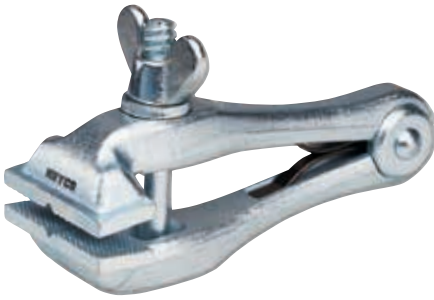

Code	←L→ mm	Backenbreite width of jaws mm	Spannweite opening mm			EAN	€
01656014560	145	48	28	675	1	031157	41,90

1659

Hartmetallschaber mit Radius

mit Inbusschlüssel
* Hartmetall-Schaberplatte mit Radius

Square scraper with replaceable carbide tip

with Allen Key
* Carbide scraper tip ready ground
and lapped for square scraper

Raclette carré avec lame carbure remplaçable

avec clé allen
* Plaque de raclage carbide

Rascador de metal duro con radio

con llave Allen
* Placa de metal duro con radio



Code	 mm	 mm	 mm			EAN	€
01659030000	300	20	2	380	1	387056	84,25
01659035000	350	25	2	600	1	387063	92,05
01659035100	350	30	2	680	1	387070	97,25
*01659120200	25	20	2	15	3	387087	45,25
*01659125200	25	25	2	20	3	387094	49,20
*01659130200	25	30	2	25	3	387100	57,20

1660

Löffelschaber

LS = lackiert, Spitzen geschliffen

Curved bearing scrapers

LS = lacquered, ground tip

Grattoirs à cuillère

LS = laquées, pointes meulées

Rasqueteadores tipo cuchara

LS = barnizado, puntas amoladas

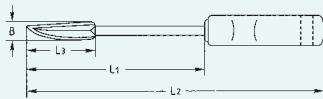

Code	mm	L ₁ "	L ₂ mm	L ₃ mm	B mm			EAN	€
01660020021	200	8	310	85	14	150	10	031188	14,15
01660025021	250	10	370	92	17	215	10	031195	16,35

1661

Dreikant-Löffelschaber

LS = lackiert, Spitzen geschliffen

Triangular bearing scrapers

LS = lacquered, ground tip

Grattoirs incurvés triangulaires

LS = laquées, pointes meulées

Rasqueteadores tipo cuchara - triangulares

LS = barnizado, puntas amoladas

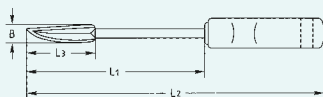

Code	mm	L ₁ "	L ₂ mm	L ₃ mm	B mm			EAN	€
01661020021	200	8	310	77	16	150	10	031225	14,15
01661025021	250	10	370	97	17	200	10	031232	16,35

1662

Dreikant-Hohlschaber

LS = lackiert, Spitzen geschliffen

Triangular hollow scrapers

LS = lacquered, ground tip

Grattoirs évidés triangulaires

LS = laquées, pointes meulées

Rasqueteadores tipo gubia - triangulares

LS = barnizado, puntas amoladas

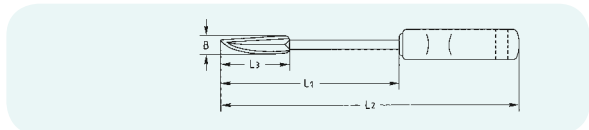

Code	mm	L ₁	"	L ₂	B	g	mm	EAN	€
01662020021	200	8		310	15	150	10	031263	14,15
01662025021	250	10		370	15	205	10	031270	16,35

1663

Flachscher

LS = lackiert, Spitzen geschliffen

Square scrapers

LS = lacquered, ground tip

Grattoirs droits

LS = laquées, pointes meulées

Rasqueteadores planos

LS = barnizado, puntas amoladas

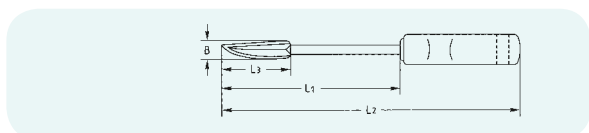

Code	mm	L ₁	"	L ₂	B	g	mm	EAN	€
01663020021	200	8		310	19	220	10	031300	14,15
01663025021	250	10		370	24	305	10	031317	16,35

1664

PROFI-Cuttermesser

- 5 integrierte Klingen, selbstladend
- Schwere Ausführung - Zink-Druckguss, automatische Klingenarretierung
- Zusätzlicher Klingenfeststeller
- Automatischer Klingenwechsel
- Magazinbefüllung
- Verkaufsdisplay mit 12 Stück
- Ersatzklingen 10 Stück

PROFI Cutter knives

- 5 integrated self loading blades
- Heavy version - zinc-die cast, automatic blade auto lock
- Additional locking of blade
- Automatic change of blade whatever the jaw opening
- Refilling of magazine
- Sales display with 12 pcs.
- Spare blade 10 pcs.

Couteau cutter PROF

- 5 lames intégrées, chargement auto-matique
- Exécution lourde - zingué sous pression, verrouillage automatique
- Supplémentaire Système de verouillage des lames
- Changement des lames automatique
- Remplissage du réservoir
- Affichage de vente avec 12 unités
- Lames de rechange 10 pièces

Cutter profesional

- 5 hojas integradas, de recarga automática
- Modelo fuerte, de fundición inyectada, fijación automática de la hoja
- Mecanismo adicional de fijación de la hoja
- Recambio automático de la hoja
- Recarga de la recámara
- Expositor de autoventa con 12 unidades
- Hojas de repuesto 10 piezas



9 mm



18 mm



Code	No.	Klingenbreite/ blade width	g	mm	EAN	€
01664000200	SB 1664-2	9 mm	124	1	334654	8,65
01664000000	SB 1664	18 mm	250	1	329018	12,15



Verkaufsdisplay/Sales display:

Code	No.	Klingenbreite/ blade width	g	mm	EAN	€
01664021200	SB 1664-12-2	9 mm	1500	12	334647	90,80
01664001200	SB 1664-12	18 mm	3000	12	331554	131,60

Ersatzklingen/Spare blades:

Code	No.	Klingenbreite/ blade width	g	mm	EAN	€
01664201000	SB 1664-10-2	9 mm	30	10	334661	1,85
01664101000	SB 1664-10	18 mm	80	10	329025	2,80



1664-4

Sicherheits-Cuttermesser

- Automatischer Klingeneinzug bei Nichtbenutzung
- Aluminium-Druckgussgehäuse mit ergonomischem 2-K Softgrip
- Einfacher Klingenswechsel
- Kompakte, ausfahrbare Bauform
- Verkaufsdiskret mit 12 Stück

Safety cutter knife

- Automatic blade feed when not in use
- Diecast aluminium housing with ergonomic 2K Softgrip
- Easy blade change
- Compact, retractable construction
- Sales display with 12 pcs.

Couteau cutter de sécurité

- Collecte automatique de la lame en cas de non-utilisation
- Boîtier en alu avec softgrip ergonomique
- Changement simple de la lame
- Modèle compact retractable
- Affichage de vente avec 12 unités

Cutter de seguridad

- Retroceso automático de la hoja al no ser utilizada
- Cuerpo de aluminio fundido con mango ergonómico de 2 componentes
- Fácil cambio de hoja
- Diseño compacto retráctil
- Expositor de autoventa con 12 unidades

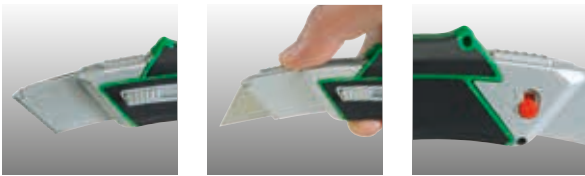

Code	No.	Klingenbreite/ blade width			EAN	€
01664000400	SB 1664-4	18 mm	158	1	402445	11,85

Verkaufsdiskret/Sales display:

Code	No.	Klingenbreite/ blade width			EAN	€
01664041200	SB 1664-12-4	18 mm	2050	12	402452	129,00

Ersatzklingen/Spare blades:

Code	No.	Klingenbreite/ blade width			EAN	€
01664301000	SB 1664-10-3	18 mm	50	10	367560	2,95

1665

Dichtungsschaber

Z = verzinkt
speziell geeignet für problemlose
und rückstandsfreie Beseitigung von
Dichtungsresten

Gasket scraper

Z = galvanized
particularly suitable for removing
residues of gaskets

Grattoirs plats

Z = galvanisés
pour enlever les restes de joints
sans problème

Rasqueteadores para limpiar juntas

Z = zincado
especial para eliminar
restos de juntas

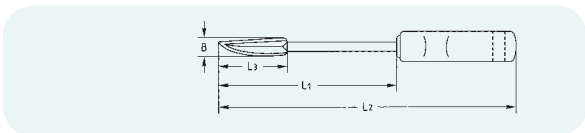

Code	mm	L ₁ "	L ₂ mm	B mm			EAN	€
01665028060	170	6.3/4	280	23	120	10	031324	16,25

1667

Türverkleidungs-Lösehebel

Z = verzinkt
zur Demontage von geklammerten
Türverkleidungen

Door trim panel remover

Z = galvanized
for removing clipped doortrim
panels

Levier de dégarnissage

Z = galvanisés
pour démonter les garnitures de portes
fixées par clips

Palancas para soltar revestimientos de puertas

Z = zincado
para soltar revestimientos grapados de
puertas



Code	mm	$\leftarrow L \rightarrow$ "			EAN	€
01667028060	280	11	140	10	031362	17,10

1668

Kabel-Klappmesser

ST = standardmäßig
rostfreie Klinge

Cable-folding knife

ST = standard
blade of stainless steel

Couteaux d'électricien avec dénudeur

ST = standard
lame d'acier inoxydable

Navajas de electricista

ST = estándar
hoja de acero inoxidable

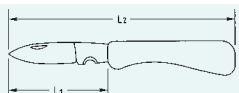

Code	mm	L ₁	"	L ₂ mm	g	g	EAN	€
01668000000	85		3.1/2	195	75	10	031379	14,00

1669

Sicherheits-Rettungsmesser

- Hochwertiger Messerstahl
- Gürtelclip
- Gurtschneider
- Scheibenzentrümmer
- Wellenschliff mit Sägeverzahnung
- Genarbte Kunststoffeinlagen, Edelstahlsschrauben

Safety folding survival knife

- High grade cutlery steel
- Belt clip
- Seatbelt cutter
- Window pane breaker
- Serrated blade with saw teeth
- Grained plastic inlays; screws made of stainless steel

Couteau de sauvetage

- Couteau en acier de haute qualité
- Clip ceinture
- Coupe ceinture
- Brise vitre
- Lame crantée avec dents de scie
- Inserts en plastique à grains fins, vis en acier inoxydable

Navaja de salvamento de seguridad

- Acero para cuchillas de alta calidad
- Clip de cintura
- Cortante para cinturón de seguridad del coche
- Rompedor de lunas
- Corte de perlado con dientes de sierra
- Injertos de plástico, tubos de acero inoxidable

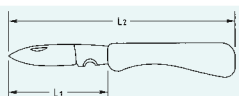

Code	mm	L ₁	"	L ₂ mm	g	g	EAN	€
01669000000	85		3.1/2	200	260	1	031379	18,35



1670

Gewindefeilen

ZCG = verzinkt, gelbchromatiert
zur Reparatur beschädigter Innen-
und Außengewinde

Thread restorers

ZCG = galvanized, yellow
chromatized
for restoring damaged inside and
outside threads

Outils à restaurer les filets

ZCG = galvanisés, jaune passivés
pour restaurer les filets abîmés intérieurs et
extérieurs

Limas para restaurar roscas

ZCG = zincado, cromatizado amarillo
para restaurar roscas dañadas, interiores
y exteriores



Code	No.	←L→ mm	g	g	EAN	€
01670000161	1670-M	230	125	10	031393	51,25

Gewindesteigung thread pitch	mm	0,80	1,00	1,25	1,50	1,75	2,00	2,50	3,00
metrisches Gewinde metric thread	mm	5	6	8	10	12	14	18	24
			7	9	11		16	20	27
								22	

Code	No.	←L→ mm	g	g	EAN	€
01670000261	1670-UNF (NF)	230	125	10	031409	51,25

Gänge auf 1 Zoll threads per 1 inch		24	20	18	16	14	13	12	11
UNF (NF)-Gewinde UNF (NF)-thread		5/16	7/16	9/16	3/4	7/8	–	1.1/8	–
		3/8	1/2	5/8		1		1.1/4	
								1.1/2	
UNC (NC)-Gewinde UNC (NC)-thread		–	1/4	5/16	3/8	7/16	1/2	9/16	5/8

1675 - 1679

Werkstattfeilen

DIN 7261/ISO 234/1

ST = standardmäßig

Hieb 2 – halbschlicht, Kreuzhieb

- ▬ 1675 Flachstumpf-Feilen
- ◐ 1676 Halbbrund-Feilen
- ▲ 1677 Dreikant-Feilen
- 1678 Vierkant-Feilen
- 1679 Rund-Feilen

Engineers' files

DIN 7261/ISO 234/1

ST = standard

second cut, cross-cut

- ▬ 1675 Hand files
- ◐ 1676 Halfround files
- ▲ 1677 Threesquare files
- 1678 Square files
- 1679 Round files

Limes d'atelier

DIN 7261/ISO 234/1

ST = standard

demi-douce, à taille double

- ▬ 1675 plate à main
- ◐ 1676 demi-ronde
- ▲ 1677 triangulaire
- 1678 carrée
- 1679 ronde

Limas de taller

DIN 7261/ISO 234/1

ST = estándar

talla 2 – entrefina, talla doble

- ▬ 1675 planas paralelas
- ◐ 1676 mediacaña
- ▲ 1677 triangulares
- 1678 cuadradas
- 1679 redondas



Code	No.	Form	mm	L ₁	"	passendes Heft suitable handle	g	g	EAN	€
01675020000	1675	▬	200	8		1681-30	175	10	031454	10,30
01675025000			250	10		1681-40	310	5	031461	13,15
01676020000	1676	◐	200	8		1681-30	125	10	031492	15,90
01676025000			250	10		1681-40	215	5	031508	22,35
01677020000	1677	▲	200	8		1681-30	145	10	031539	12,95
01677025000			250	10		1681-40	290	5	031546	17,05
01678020000	1678	■	200	8		1681-10	85	10	031577	10,10
01678025000			250	10		1681-20	150	5	031584	13,30
01679020000	1679	●	200	8		1681-10	70	10	031614	9,05
01679025000			250	10		1681-20	140	5	031621	12,25

1681

Feilenhefte

ST = standardmäßig

für Werkstattfeilen

HEYCO 1675-1679

File handles

ST = standard

for engineers' files

HEYCO 1675-1679



Poignées pour fichiers

ST = standard

pour limes d'atelier

HEYCO 1675-1679

Los mangos de archivos

ST = estándar

para limas de taller

HEYCO 1675-1679

Code	No.	←L→ mm	Innen/inside Ø mm	g	g	EAN	€
01681001000	1681-10	100	5	27	10	410532	1,70
01681002000	1681-20	120	6	40	10	410556	2,25
01681003000	1681-30	100	7	27	10	410563	1,70
01681004000	1681-40	120	8	40	10	410570	2,25

1686 - 1686-1

Kontaktfeilen

B = brüniert

1686 Sätze à 6 Stück in Abreißaschen

1686-1 lose

Contact files

B = gun-metal finish

1686 sets of 6 pcs. in tear-off bags

1686-1 loose

Limes à contacts

B = brunies

1686 jeux de 6 pcs. en trousse

1686-1 en vrac

Limas para platinos

B = pavonado

1686 juegos de 6 piezas en bolsa de

plástico con bolsillos arrancables

1686-1 sueltas



Code	No.	mm	←L→ "	g	g	EAN	€
01686000030	1686	150	6	61	10	031782	16,20
01686000130	1686-1	150	6	7	5	031799	2,25

1686-1



1689

Schlüsselfeilen

DIN 7283
B = brüniert
Hieb 2 – halbschlicht, Kreuzhieb
Sätze à 6 Stück in Plastiktaschen

Warding files

DIN 7283
B = gun-metal finish
second cut, cross-cut
sets of 6 pcs. in plastic wallets

Limes à clés

DIN 7283
B = brunies
demi-douce, à taille double
jeux de 6 pcs. en trousse

Limas para cerrajero

DIN 7283
B = pavonado
talla 2 – entrefina, talla doble
juegos de 6 piezas, en bolsa de plástico



Code	←L→		je 1 Stück 1 pcs. each			EAN	€
	mm	"					
01689000030	150	6		115	10	031805	22,35

1702

Kolbenring-Spannbänder

ST = standardmäßig
stufenlose Einstellung durch
Spannschlüssel

Piston ring compressors

ST = standard
infinitely variable adjustment with
ratchet key

Colliers à segments

ST = standard
blocage progressif par clé de serrage

Ceñidores para segmentos de pistón

ST = estándar
ajuste sin escalones mediante tensor



Code	No.	Spannbreite/capacity		Höhe/depth				EAN	€
		mm	"	mm	"				
01702000100	1702-1	57-125	2.1/4-5	80	3.1/4	250	1	031829	29,55
01702000200	1702-2	90-175	3.1/2-7	80	3.1/4	295	1	031836	34,85
01702000300	1702-3	90-175	3.1/2-7	165	6.1/2	550	1	031843	65,45

1706

Kolbenringzangen

NI = vernickelt,
Griffe mit Kunststoffhüllen
zum Abnehmen und Auflegen von
Kolbenringen

Piston ring spreaders

NI = nickel plated,
handles with PVC-insulation
for removing and installing piston
rings

Pincas à segments

NI = nickelées,
manches gainés plastique
pour démontage et montage des segments
de piston

Tenazas para segmentos de pistón

NI = niquelado,
mangos con funda de plástico
para extraer y colocar segmentos de
pistón



Code	No.	für Kolbenringe for piston rings		←L→				EAN	€
		mm	"	mm	"				
01706010055	1706-1	50-100	2-4	200	8	240	1	031874	31,55
01706015055	1706-3	90-150	3.1/2-6	240	9.1/2	345	1	031881	42,30

1721

3W-LED-Taschenlampe

Hergestellt aus Lufffahrtaluminium, schwarz eloxiert, absolut korrosionsbeständig, spritzwassergeschützt, inkl. Batterien und Gürteltasche

3W-LED Torchlight

Body made of aeronautical aluminium, black anodised, absolutely corrosion-resistant, splashproof, incl. batteries and belt loop

Lampe torche 3W-LED

Fabriqu  en aluminium aviation, anodis  noir, absolument r sistant   la corrosion, anti- claboussures, batteries et  tui de ceinture inclus

Linterna LED de 3 vatios

Fabricada de aluminio aeron utico, anodizado color negro, resistente a la corrosi n, protegida contra la humedad, con pilas y bolsa para el cintur n



Code	←L→ mm	g	1	EAN	€
01721000000	300	700	1	399879	39,00



1721-1

1W-LED-Taschenlampe

Hergestellt aus Lufffahrtaluminium, schwarz eloxiert, absolut korrosionsbest ndig, spritzwassergesch tzt, inkl. Batterien und G rteltasche

1W-LED Torchlight

Body made of aeronautical aluminium, black anodised, absolutely corrosion-resistant, splashproof, incl. batteries and belt loop

Lampe torche 1W-LED

Fabriqu  en aluminium aviation, anodis  noir, absolument r sistant   la corrosion, anti- claboussures, batteries et  tui de ceinture inclus

Linterna LED de 1 vatio

Fabricada de aluminio aeron utico, anodizado color negro, resistente a la corrosi n, protegida contra la humedad, con pilas y bolsa para el cintur n



Code	←L→ mm	g	1	EAN	€
01721000100	110	110	1	367089	13,75



1721-2

High Power LED Light

- Ultra hell/1.000 LM/10 W/200 m
- Hohe Energieeffizienz
- Extra lange Leuchtdauer
- 3 verschiedene Leuchtmodi:
 - Powermodus 100 % / 1.000 LM
 - Sparmodus 25 % / 250 LM
 - Stroboskopmodus 480 / min.
- Zoomfunktion
- Spritzwassergesch tzt
- Oberfl che Schwarz eloxiert
- L nge ca. 250 mm, Ø ca. 53 mm
- Gewicht inkl. Batterien: ca. 835 g
- Inkl. 3 Batterien (D-Zelle)
- Inkl. G rteltasche

High power LED light

- Ultra bright/1.000 LM/10 W/200 m
- High energy efficiency
- Extra long durability
- 3-Functions:
 - Power mode 100 % / 1.000 LM
 - Safe mode 25 % / 250 LM
 - Strobe mode 480 / min.
- Zoom function
- Splashproof
- Finish black anodized
- LG approx. 250 mm, Ø approx. 53 mm
- Weight incl. battery: approx. 835 g
- Powered by 3 D-Batteries - (Mustang alkaline battery) - included
- Incl. belt holder

LED haute puissance

- Ultra bright/1.000 LM/10 W/200 m
- Haute efficacit   nerg tique
- Tr s longue dur e de vie
- 3 fonctions:
 - Mode d'alimentation 100 % / 1.000 LM
 - Mode sans  chec de 25 % / 250 LM
 - Strobe 480 / min.
- Fonction zoom
- Splashproof
- Anodis  noir
- LG env. 250 mm, Ø env. 53 mm
- Poids incl. batterie: env. 835 g
- Aliment  par 3 piles D- (Pile alcaline Mustang) - inclus
- Incl. support de ceinture

Linterna LED de gran potencia

- Ultra luminoso/1.000 LM/10 W/200 m
- Alta eficiencia de consumo de energ a
- Extra larga duraci n de la iluminaci n
- 3 modos diferentes de iluminaci n:
 - Powermodus 100 % / 1.000 LM
 - Modo econ mico 25 % / 250 LM
 - Modo trobosc oicio 480 / min.
- Funci n zoom
- Impermeable
- Superficie en epoxy negro
- Largura aprox. de 250 mm, Ø aprox. 53 mm
- Pila incluida aprox. 835 g
- Incluye 3 pilas alcalinas
- Incluye bolsa para fijar en el cintur n



Code	←L→ mm	g	1	EAN	€
01721000200	250	835	1	401950	56,10



1731

Schutzbrille „Sport“ mit Sehglasaufnahme

CE EN 166 / ANSI Z87.1

- Zertifizierte Produktion
- Integrierter, herausnehmbarer Brillenrahmen zur Aufnahme Ihrer individuellen Sehgläser
- Angenehmer Tragekomfort durch 2-K Weichkomponente an den Bügeln
- Auch ohne Sehglasaufnahme als Schutzbrille nutzbar

Protective glasses „Sport“ with eyeglass-holder

CE EN 166 / ANSI Z87.1

- Certified production
- Integrated, removeable spectacle frame as holder for your individual glasses
- 2-K soft component on the temple arms for high wearing comfort
- Can be used as protective glasses without eyeglass-holder

Lunette de protection „Sport“ avec support pour lunettes

CE EN 166 / ANSI Z87.1



- Production certifiée
- Cadre démontable comme support pour vos propres lunettes
- Composant 2-K sur les branches pour le confort élevé
- Peut être utilisé comme des lunettes de protection sans porte-lunettes

Gafas de protección „Sport“ con recipiente para cristales

CE EN 166 / ANSI Z87.1

- Producción certificada
- Montura para acoplar los cristales individuales
- Comportable utilización gracias a 2 componentes blandos en las patillas
- Utilizable también como gafas de protección sin el recipiente de cristales



Code	Modell	 g		EAN	€
01731000000	Sport	40	1	394009	16,30

1731-1

Schutzbrille „Konventionell“ mit Sehglasaufnahme

CE EN 166 / ANSI Z87.1

Beschreibung siehe Artikel 1731

Protective glasses „Konventionell“ with eyeglass-holder

CE EN 166 / ANSI Z87.1

For the description, see article 1731

Lunette de protection „Konventionell“ avec support pour lunettes

CE EN 166 / ANSI Z87.1

Description voir article 1731

Gafas de protección „Konventionell“ con recipiente para cristales

CE EN 166 / ANSI Z87.1

Descripción, véase artículo 1731



Code	Modell	 g		EAN	€
01731000100	Konventionell	40	1	394016	16,30

1754

Feilenbürste

ST = standardmäßig

Buchenholz mit Kratzenband besetzt

File card brush

ST = standard

beech wood with card brush

Brosses à limes

ST = standard

bois d'hêtre avec ruban à raclettes

Cepillos para rascar limas

ST = estándar

mango de madera de haya con banda rascadora

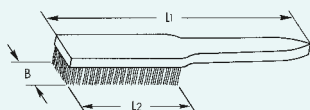

Code	L ₁ mm	L ₂ mm	B mm	 g		EAN	€
01754000000	260	115	40	70	5	032031	5,80

1755

Stahl-Drahtbürsten

ST = standardmäßig
glatter Stahldraht Ø 0,35 mm

Wire brushes

ST = standard
with plain steel bristles Ø 0,35 mm

Brosses métalliques

ST = standard
fils d'acier lisses Ø 0,35 mm

Cepillos de alambre de acero

ST = estándar
alambre liso de Ø 0,35 mm

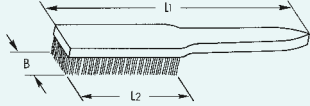

Code	Reihen rows	L ₁ mm	L ₂ mm	B mm	g	g	EAN	€
01755000300	3	290	130	30	125	5	032048	3,70
01755000400	4	290	130	35	130	5	032055	4,60

1757

Edelstahl-Drahtbürste

ST = standardmäßig
Edelstahl, Ø 0,35 mm,
mit integriertem Schaber

Stainless steel wire brush

ST = standard
Stainless steel, Ø 0,35 mm,
with integrated scraper

Brosse métallique en acier inoxydable

ST = standard
Acier inoxydable, Ø 0,35 mm,
avec grattoir intégré

Cepillo de alambre inoxidable

ST = estándar
Acero inoxidable, Ø 0,35 mm,
con arrascador integrado

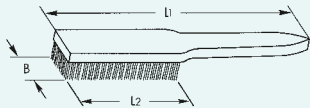

Code	Reihen rows	L ₁ mm	L ₂ mm	B mm	g	g	EAN	€
01757000300	3	350	160	25	186	1	403398	12,00

1759

Zündkerzenbürste

ST = standardmäßig
gewellter Messingdraht Ø 0,15 mm

Spark plug brush

ST = standard
wavy brass bristles Ø 0,15 mm

Brosses à bougies

ST = standard
fils de laiton striés Ø 0,15 mm

Cepillos para limpiar bujías

ST = estándar
alambre ondulado de latón Ø 0,15 mm

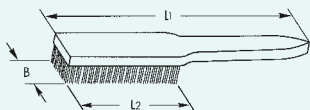

Code	Reihen rows	L ₁ mm	L ₂ mm	B mm	g	g	EAN	€
01759000300	3	150	32	15	18	10	032093	2,55

1781 - 1782-2

Ölspritzkannen

ST = standardmäßig
aus Kunststoff
1781 Feinöler
1782 mit herausziehbarem Spritzrohr

Oil cans

ST = standard
made from plastic
1781 fine nozzle oilers
1782 with adjustable brass spout

Burettes à huile

ST = standard
en plastique
1781 burettes plates avec embout fin
1782 avec bec amovible

Aceiteras

ST = estándar
de plástico
1781 boquilla fina
1782 con boquilla extraíble



Code	No.	Volumen/volume ccm		g	g	EAN	€
01781002500	1781	25	1/16	10	10	032116	2,30
01782025000	1782-2	250	1/2	55	20	032130	8,65

1783

Ölspritzkanne

L = lackiert
Metall, Deckelteil aus Kunststoff
mit Messingdruckpumpe,
1 flexibles 1 starres Spritzrohr



Oil can

L = lacquered
Steel body, flexible reinforced
plastic spout, rigid brass spout,
brass pump

Burettes à huile

L = laquées
Métal, couvercle en plastique avec pompe
en laiton, un bec flexible et un bec rigide

Aceiteras

L = barnizado
Metal, tapa de plástico con bomba de
presión de latón con un tubo de inyección
flexible y otro rígido

Code	Volumen/volume				EAN	€
	ccm	pint				
01783030020	300	5/8	240	12	162745	24,75

1790-1

Handhebel-Fettpresse

DIN 1283
L = lackiert
Kopf aus Zinkdruckguß, robuster
Stahlrohrkörper mit Rändelung für
rutschsichere Handhabung; zur
Füllung mit Kartuschen, lose Fett und
durch Füllgeräte, mit 300 mm langem
Gummipanzerschlauch Ø 12 mm
und 4-Backen-Hydraulikmundstück;
Anschlußgewinde M 10 x 1



High pressure grease gun

DIN 1283
L = lacquered
head of zinc die-casting, robust
steel body with knurling for non-
slip handling, for loading with
cartridges, bulk grease or by filler
pumps, with high pressure rubber
tube of 300 mm length, 12 mm
Ø and 4-jaw hydraulic connector,
connecting thread M 10x1

Pompes à graisse à levier

DIN 1283
L = laquées
tête en zinc injecté, corps robuste en tôle
d'acier avec rainures antidérapantes;
prévues pour la graisse en vrac,
cartouches et appareils de remplissage;
équipées d'un bec flexible
(Ø 12 mm, longueur 300 mm)
et d'un embout hydraulique

Aceiteras

DIN 1283
L = barnizado
cabeza de fundición inyectada, cuerpo de
tubo de acero con grafilado para evitar
que resbale en la mano; recargable
con cartuchos o grasa a granel y mediante
aparatos de rellenado, con manguera de
goma reforzada de 300 mm,
Ø 12 mm y boquilla hidráulica de 4
mordazas; rosca de conexión M 10x1

Code	Inhalt/capacity ccm					EAN	€
	lose bulk	Kartuschen cartridges					
01790000120	500	400	380/690	1220	1	032161	39,35

1805

Lochkreis-Messschieber

- Für Lochkreis-Messungen an Stahl-
und Alufelgen
- Einfaches Ermitteln des Lochkreises
- Geeignet für 3-, 4-, 5-, 6-Loch Felgen
- Messwerte-Ermittlung in mm
- Feststellschraube zum Fixieren des
Messwertes
- Hochwertige Aluminium-Ausführung



Bolt circle measuring gauge

- For taking measurements on bolt
circles of steel- and aluminium rims
- Easy determination of the bolt
circle
- Suitable for 3-, 4-, 5-, 6-hole rims
- Value indication in mm
- Locking screw for fixation of the
value
- High grade aluminium version

Pied à coulisse

- Pour les mesures des trous d'alésage sur
l'acier et les jantes en aluminium
- Simple détermination du trou d'alésage
- Approprié pour jantes à 3-, 4-, 5-, 6-trous
- Détermination de la valeur de
mesure en mm
- Vis de fixation pour fixer la valeur de
mesure
- Aluminium de haute qualité

Pie de rey para diámetros de agujeros

- Para medir diámetros de agujeros en
llantas de acero y aluminio
- Determinación sencilla del diámetro del
agujero
- Adecuado para llantas de 3, 4, 5, 6
agujeros
- Determinación del valor de medida en mm
- Tornillo de fijación para que el valor
de medida una vez obtenido no se vea
alterado
- Fabricado en aluminio de alta calidad

Code				EAN	€
	mm				
01805024000	84	240	1	378375	28,00

1806

Präzisions-Schieblehre

DIN 862
C = verchromt
rostfreier Stahl,
Ablese Teile matt verchromt
Rückseite mit Gewindetabelle,
in Kunstledertasche

Precision vernier caliper

DIN 862
C = chromium plated
stainless steel,
scale markings satin chrome finish
back with thread table,
in imitation leather bag

Pieds à coulisse de précision

DIN 862
C = chromées
acier inoxydable,
vernier et règle chromées mat
revers avec tableau de filet,
en trousse simili-cuir

Calibres pie de rey, de precisión

DIN 862
C = cromado
acero inoxidable,
escala y nonios cromados mate,
tabla de roscas al dorso,
en funda de imitación cuero



Code	mm		Nonius/vernier mm				EAN	€
01806015080	150	6	1/20	1/128	185	5	032192	32,25

1807

Digitale Präzisionsschieblehre

Material: Edelstahl
Messbereich: 0 - 150 mm / 6"
Resolution: 0.01 mm / 0.0005"
Genauigkeit: ± 0,03 mm

- Hochwertiges Metallgehäuse
- Umschaltbar metrisch/inch
- Mit Umrechnungstabelle
- In stabiler Kunststoffbox
- Inkl. Batterie

Digital precision vernier caliper

Material: Stainless steel
Measuring range: 0 - 150 mm / 6"
Resolution: 0.01 mm / 0.0005"
Accuracy: ± 0,03 mm

- High grade metal housing
- Switchable metric/inch
- With conversion table
- In strong plastic box
- Incl. Battery

Pieds à coulisse digital

Matériau: Acier inoxydable
Mesure: 0 - 150 mm / 6"
Résolution: 0.01 mm / 0.0005"
Précision: ± 0,03 mm

- Boîtier métallique de haute qualité
- Interchangeable métrique / pouce
- Avec tableau de conversion
- En plastique solide
- Avec batteries

Calibre pie de rey digital, de precisión

Material: Acero inoxidable
Capacidad: 0 - 150 mm / 6"
Resolución: 0.01 mm / 0.0005"
Limite de error: ± 0,03 mm

- Cuerpo metálico
- Cambio métrico / pulgadas
- Con tabla de conversión
- En robusta caja de plástico
- Inclusive pila

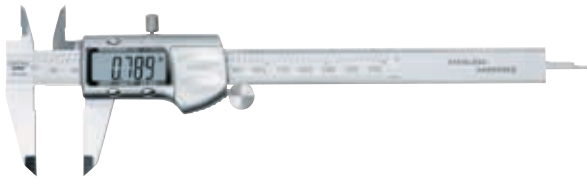

Code	No.	mm		Nonius/vernier mm				EAN	€
01807015080	1807	150	6	1/20	1/128	380	1	359954	43,85

1814

Fühlerlehren

P/N = poliert (Blätter) /
vernickelt (Scheiden)
konische Blattform,
Blätter verschraubt

Feeler gauges

P/N = polished (blades) /
nickel plated (sheaths)
tapered blades,
blades screwed into sheath

Jauges d'épaisseur

P/N = polies (lames) /
amature nickelée
lames à bout pointu,
lames fixées par un axe vissé

Galgas de espesores

P/N = pulido (hojas) /
niquelado (monturas)
hojas de forma cónica,
unidas por tornillo



Code	No.	tlg. pcs.	Meßbereich measuring range	$\leftarrow L \rightarrow$ mm			EAN	€
01814000240	1814-2	13	0,05 - 1,0 mm	100	66	10	032215	7,00
01814000340	1814-3	18	0,05 - 1,0 mm	100	72	10	032222	11,05
01814000440	1814-4	20	0,05 - 1,0 mm	100	105	10	032239	11,30
01814001240	1814-12	13	.002 - .035"	100	55	10	032253	7,00
01814001340	1814-13	22	.004 - .025"	100	80	10	032260	13,05

1815

2 in 1 Bremsscheiben-Messschieber und Reifenprofil-Messlehre

- Zum Messen der Brems Scheibenstärke bei PKW + Motorrädern im eingebauten Zustand
- Aus rostfreiem Stahl
- Mit Feststellschraube und zusätzlicher Reifenprofil-Messlehre
- Meßbereich: 0-60 mm

2 in 1 Brake- and tyre profile-caliper

- For measuring the thickness of built-in braking discs of passenger cars and motorbikes
- Made of stainless steel
- With locking screw and additional tyre profile-caliper
- Measuring range: 0-60 mm

Pied à coulisse 2 en 1 pour contrôler l'épaisseur des disques de frein

- Permet une mesure roue en place des voitures ou les motos
- Acier inoxydable
- Avec vis de blocage et jauge supplémentaire
- Capacité : 0-60 mm

Calibre de freno 2 en 1 y calibre para perfil de neumático

- Para medir el grosor del disco de freno en coches y motos sin tener que desmontar las piezas
- Hecho de acero inoxidable
- Con tornillos de fijación y un calibre adicional del neumático
- Alcande de medida de 0-60 mm



Code	Meßbereich measuring range			EAN	€
01815007500	0-60 mm	60	1	380392	18,50

1836

Präzisions-Stahlmaßstab

Typ Chesterman
ST = standardmäßig
rostfreier Stahl
Teilung – obere Kante 0,5 + 1,0 mm,
untere Kante 1/16, 1/32, 1/64"

Precision steel rule

Chesterman Type
ST = standard
stainless steel
graduation – top edge 0,5 + 1,0 mm,
bottom edge 1/16, 1/32, 1/64"

Règlets de précision

Modèle Chesterman
ST = standard
acier inoxydable
graduation – bord supérieur 0,5 + 1,0 mm,
bord inférieur 1/16, 1/32, 1/64"

Reglas de precisión, de acero

Tipo Chesterman
ST = estándar
acero inoxidable
divisiones: canto superior 0,5 + 1,0 mm,
canto inferior 1/16, 1/32, 1/64"



Code	mm		Querschnitt section mm			EAN	€
01836030000	300	12	30 x 1,0	77	10	032604	11,05

1837

Holzgliedermaßstab, 2 m

Genauigkeitsklasse EG III, aus
Buchenholz, Gliederstärke 3,0 mm,
Gliederhöhe 16 mm, Gliederzahl
10, durchgenietete Gelenke und
vermessingte Stahlfedern, 2 m Länge

Beechwood folding rule, 2 m

EC accuracy class III, beechwood,
section thickness 3,0 mm, section
height 16 mm, no of sections 10,
riveted and brass-plated, spring
joints, 2 m length

Mètre pliant, 2 m

CE classe de précision III, hêtre, épaisseur
de 3,0 mm, hauteur de section 16 mm,
10 compartiments, jointures rivetées et
laiton chromé à ressort, longueur 2 m

Metro plegable de madera, 2 m

Clase de precisión CE III, de madera de
haya, grosor de hoja 3,0 mm, anchura
de hoja 16 mm, número de hojas 10,
articulaciones con remaches ocultos y
muelles de acero latonado



Code	Meßbereich measuring range			EAN	€
01837020000	200 mm	120	1	377569	4,90

1840-5

Bandmaß 5 m

- Metrisch
- Soft-Grip
- Metallgehäuse
- Stopfunktion
- Nylon beschichtet
- Magnete
- Gürtelclip
- Verkaufsdisplay mit 12 Stück.

Measuring tape 5 m

- Metric
- Soft-grip
- Stainless steel case
- Stop function
- Nylon coated
- Magnets
- Belt clip
- Sales display with 12 pcs.

Mesure de poche 5 m

- Métrique
- Soft-Grip
- Boîtier métallique
- Fonction d'arrêt
- Gainé de nylon
- Aimants
- Clip de ceinture
- Affichage de vente avec 12 unités.

Flexómetros 5 m

- Métricos
- Soft-Grip
- Carcasa metálica
- Botón de freno
- Cinta recubierta de nylon
- Imanes
- Clip para el cinturón
- Expositor de autoventa de 12 unidades.



Code	←L→ mm	Bandbreite/width of tape mm	g	g	EAN	€
01840500000	5	18	325	1	329032	8,15
01840051200	5	18 Display	3900	12	331561	87,70

1840-8

Bandmaß 8 m

- Metrisch/inch
- Soft-Grip
- Metallgehäuse
- Stopfunktion
- Nylon beschichtet
- Magnete
- Gürtelclip
- Verkaufsdisplay mit 12 Stück.

Measuring tape 8 m

- Metric/inch
- Soft-grip
- Stainless steel case
- Stop function
- Nylon coated
- Magnets
- Belt clip
- Sales display with 12 pcs.

Mesure de poche 8 m

- Métrique/inch
- Soft-Grip
- Boîtier métallique
- Fonction d'arrêt
- Gainé de nylon
- Aimants
- Clip de ceinture
- Affichage de vente avec 12 unités.

Flexómetros 8 m

- Métricos/inch
- Soft-Grip
- Carcasa metálica
- Botón de freno
- Cinta recubierta de nylon
- Imanes
- Clip para el cinturón
- Expositor de autoventa de 12 unidades.



Code	←L→ mm	Bandbreite/width of tape mm	g	g	EAN	€
01840800000	8	15	470	1	367263	14,30
01840081200	8	15 Display	5800	12	367256	152,00

1842

Reißnadel

Chrom-Vanadium
B = brüniert

Scriber

Chrome-Vanadium
B = gun-metal finish

Pointes à tracer

Chrome-Vanadium
B = brunies

Puntas de trazar

Cromo Vanadio
B = pavonado



Code	mm	"	g		EAN	€
01842025030	250	10	45	10	032635	8,25

1856

Reifendruckprüfer

CPP = verchromt, ganz poliert
mit Taschenclip

Tyre pressure gauges

CPP = chromium plated,
fully polished
with pocket clip

Contrôleurs de pression de gonflage

CPP = chromées, entièrement polis
avec agrafe métallique

Manómetros para neumáticos

CPP = cromado,
enteramente pulido espejo
con clip



Code	No.	Meßbereich/measuring range bar	lbs./sq. in	g		EAN	€
01856000383	1856-3	0,5 – 3,5	6 – 50	45	10	032734	16,20
01856000483	1856-4	0,8 – 8,2	10 – 120	55	10	032741	16,20

1857

Digitaler Reifenprüfer mit 3 Funktionen im Verkaufsdisplay

mit 3 Funktionen:
Profiltiefe-Messung:
0,22 mm / 8"
Reifendruck-Messung:
0-7,0 Bar / 0-100 PSI / 0-7,0 kg/cm
Licht

Inkl. Batterie
Genauigkeit: ± 1%
Verkaufsdisplay mit 12 Stück

Digital tyre gauge with 3 function in sales display

with 3 functions:
Measuring tread depth:
0,22 mm / 8"
Measuring pressure:
0-7,0 Bar / 0-100 PSI / 0-7,0 kg/cm
Light

Incl. battery
Accuracy: ± 1%
Sales display with 12 pcs.

Contrôleurs de pression de gonflage

à 3 fonctions:
Jauge de profondeur des pneus:
0,22 mm / 8"
Mesure de pression des pneus:
0-7,0 Bar / 0-100 PSI / 0-7,0 kg/cm
Lumière

Batteries inclus
Précision: ± 1%
Affichage de vente avec 12 unités

Comprobador de la presión de neumáticos de 3 funciones, en display de autoventa

con 3 funciones:
Medición de la profundidad del perfil:
0,22 mm / 8"
Medición de la presión del neumático:
0-7,0 Bar / 0-100 PSI / 0-7,0 kg/cm
Luz

Con pila
Exactitud: ± 1%
Expositor de autoventa con 12 unidades



Code	No.	Meßbereich/measuring range bar	psi	kg/cm	g		EAN	€
01857000000	1857	0,0 – 7,0	0 – 100	0,0 - 7,0	70	12	358667	14,00



1905

Stethoskop

ST = standardmäßig
Abhörgerät zur Feststellung und Lokalisierung von defekten Lagern, Ventilen, Kolben, Stirnrädern usw. übertragungsstarke Membrane

Mechanics' stethoscope

ST = standard
sound detector for locating defective bearings, valves, pistons, spur pinions etc. with sound amplifying diaphragm

Stéthoscope

ST = standard
permet la localisation aisée des défauts des roulements, soupapes, pistons, engrenages etc. membrane de transmission puissante

Estetoscopio

ST = estándar
para detectar y localizar defectos en cojinetes, válvulas, émbolos, engranes etc. con membrana potente



Code	Spitze/probe tip mm	←L→ mm	g	1	EAN	€
01905000000	150	1055	180	1	032758	59,00

1920

Isolierband

ST = standardmäßig (schwarz)

Insulating tape

ST = standard (black)

Rouleaux de ruban adhésif

ST = standard (noir)

Cintas aislantes

ST = estándar (color negro)

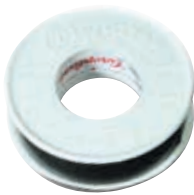

Code	←L→ mm	g	10	EAN	€
01920100000	10	31	10	032819	3,15

2010-3

Achsölwanne, 3 L

- 3 l Fassungsvermögen
- Sicheres Auffangen und Transportieren von flüssigen Medien
- Öl- und Chemikalienbeständig
- Mit praktischen Tragegriffen
- Optimale Passform, angepasst auf Radnabe / Felgenbett
- Praktische Ausgießöffnung zum einfachen Umfüllen

Drain pan for axle oil, 3 L

- 3 l capacity
- Secure collection and transport of fluids
- Oil- and chemicals-resistant
- With practical handles
- Perfect fit for the wheel hub and the rim well
- Practical pouring spout for easy decanting

Recupérateur d'huile, 3 L

- Capacité 3 litres
- Collecte et transport sécurisé des liquides
- Résistant aux huiles et produits chimiques
- Avec poignées de transport pratique
- Ajustement parfait à la roue/jante
- Bec verseur pratique

Recipiente de aceite de eje 3L

- Capacidad de 3 litros
- Segura colección y transporte de fluidos
- Resistente al aceite y a productos químicos
- Con prácticos asideros
- Perfecto acomplamiento al eje y a la cama de la llanta
- Práctico diseño de la boca para facilitar la transmisión del líquido



L: 315 mm
B: 245 mm
H: 160 mm



Code	Liter	g	1	EAN	€
02010000300	3	400	1	381764	18,35

2010-8

Auffangwanne für flüssige Medien, 8 L

- 8 l Fassungsvermögen
- Flach, Öl- und Chemikalien-beständig
- Mit praktischer Ausgießstülle
- Polyethylen
- Rundumlaufender Überlauftrand

Drain pan, 8 L

- 8 l capacity
- Flat, oil- and chemicals-resistant
- With practical handle
- Polyethylene
- Overflow channel around



L: 520 mm
H: 140 mm
Ø: 320 mm





Puisards pour liquides, 8 L

- Capacité 8 litres
- Plat, résistant aux huiles et aux produits chimiques
- Avec bec verseur pratique
- Polyéthylène
- Bord de débordement au tour

Recipiente para recoger líquidos, 8 L

- Capacidad 8 litros
- Plano, resistente a aceites y productos químicos
- Con boquilla para el vaciado
- Polietileno
- Borde integral para evitar que se desborde el líquido

Code	Liter			EAN	€
02010000800	8	650	1	372014	21,40

2010-10

Auffangwanne für flüssige Medien, 10 L mit Kanister

- 10 l Fassungsvermögen
- Flach, Öl- und Chemikalien-beständig
- Mit praktischem Tragegriff
- Polyethylen
- Sicherer Transport von Öl
- Flache Ausführung

Drain pan, 10 L with canister

- 10 l capacity
- Flat, oil- and chemicals-resistant
- With practical handle
- Polyethylene
- Secure transport of oil
- Flat design



L: 567 mm
B: 321 mm
H: 126 mm



Puisards pour liquides, 10 L avec réservoir

- Capacité 10 litres
- Plat, résistant aux huiles et aux produits chimiques
- Avec poignée
- Polyéthylène
- Transport en toute sécurité de pétrole
- Forme plate

Recipiente para recoger líquidos, 10 L con bidón

- Capacidad 10 litros
- Plano, resistente a aceites y productos químicos
- Con asa
- Polietileno
- Para el transporte seguro de aceites
- Modelo plano

Code	Liter			EAN	€
02010001000	10	1050	1	372007	33,65

2011

Multifunktionstrichter 2 in 1

- Trichter aus Polypropylen
- 1,2 L Fassungsvermögen
- Flexibler Ausgießer, 340 mm
- Transparenter Schlauch für Wasser, Bremsflüssigkeit etc., 600 mm Länge
- Edelstahlsieb zum Schutz vor Verunreinigung

Multifunction funnel 2 in 1

- Funnel made of polypropylene
- Capacity 1,2 L
- Flexible spout, 340 mm
- Transparent hose for water, brake fluid etc., 600 mm length
- Stainless steel sieve to protect against pollution

Entonnoir multifonction 2 en 1

- Entonnoir en polypropylène
- Capacité de 1,2 L
- Bec verseur souple, 340 mm
- Tuyau transparent pour eau
- Liquide de frein, etc, longueur 600 mm
- Écran en acier inoxydable à protéger contre la contamination

Embudo multifuncional 2 en 1

- Embudo de polipropileno
- Capacidad 1,2 litros
- Boquilla flexible, 340 mm
- Manguera transparente para agua, líquido de frenos etc., largo 600 mm
- Tamiz de acero inoxidable para evitar suciedades



Code	Liter			EAN	€
02011000000	1,2	471	1	372496	14,30

2012

Magnethaftschale

Haftmagnet rückseitig für die flexible Montage

- Magnethaftschale für Schrauben, Bolzen, Kleinteile etc.
- Hochwertige Ausführung
- Aus rostfreiem Edelstahl
- 150 mm Durchmesser
- Gummischutzplatte verhindert Kratzer auf Karosserieteilen

Magnetic shell

Adhesive magnet on the rear side for flexible mounting

- Magnetic shell for screws, bolts, small parts etc.
- Top quality
- Made of stainless steel
- Diameter 150 mm
- Rubber protection plate prevents scratches on auto body parts

Bol magnétique

Dos magnétique pour montage flexible

- Bac magnétique pour vis, boulons, etc quincaillerie
- Exécution de haute qualité
- Acier inoxydable
- 150 mm de diamètre
- Plaque de protection en caoutchouc empêche les rayures sur les parties de carrosserie

Bandeja imantada

Imán al dorso para un montaje flexible

- Bandeja imantada para tornillos, pasadores, piecero metálico etc.
- Acabado de calidad
- De acero inoxidable
- Diámetro 150 mm
- La placa protectora de goma evita raspaduras en la carrocería



Code				EAN	€
02012000000	3 kg	402	1	327502	17,35

2013

Bremsflüssigkeitstester

- Ermittelt die Qualität der Bremsflüssigkeit
- Zeigt an, wie groß der Wasseranteil in der Bremsflüssigkeit ist und dementsprechend, wann die Bremsflüssigkeit gewechselt werden soll
- Inkl. Batterie 1,5 V AAA

Brake fluid tester

- Can be used as a digital brake fluid tester suitable for determining brake fluid quality
- Tested and indicated on five LEDs in terms of „per cent of water in the brake fluid“
- Incl. battery 1,5 V AAA

Testeur de liquide de frein

- Détermine la qualité de liquide de frein,
- Indique le pourcentage d'eau dans le liquide de frein et indique lorsque le liquide de frein doit être changé
- Batteries inclus 1,5 V AAA

Comprobador del líquido de frenos

- Verifica la calidad del líquido de frenos
- Indica el contenido de agua en el líquido de frenos y determina cuándo hay que cambiarlo
- Inclusive pila 1,5 V AAA



Code	No.	←L→ mm	g	1	EAN	€
02013000000	2013	145	80	1	375169	36,00

2013-1

Bremsflüssigkeitstester 8 in 1

Für alle Bremsflüssigkeitsarten: DOT 3, DOT 4, DOT 5.1, ACD elco DOT 3, Pennzoil DOT 3, Prestone DOT 3, Motorcraft DOT 3, Toyota DOT 3

Dieser Tester ist dafür bestimmt, den Zustand der Bremsflüssigkeit zu ermitteln. Er wird durch 5 LED angezeigt. Mit LED-Leuchte. Für alle Bremsflüssigkeitsarten.

Brake fluid tester 8 in 1

For all kinds of brake fluids: DOT 3, DOT 4, DOT 5.1, ACD elco DOT 3, Pennzoil DOT 3, Prestone DOT 3, Motorcraft DOT 3, Toyota DOT 3

The purpose of this tester is to examine the quality of the brake fluid. The quality of the brake fluid will be indicated by 5 LED. With LED illumination. For all kinds of brake fluids.

Testeur liquide de frein 8 en 1

Pour tous les types de liquide de frein: DOT 3, DOT 4, DOT 5.1, ACD Elco DOT 3, Pennzoil DOT 3, Prestone DOT 3, DOT 3 Motorcraft, Toyota DOT 3

Cet appareil est destiné à déterminer l'état du liquide de frein. La qualité du liquide de frein sera indiqué par 5 LED. Avec illumination à LED. Pour tous les types de liquides à frein.

Comprobador de líquido de freno 8 en 1

Para todo tipo de líquidos de freno DOT 3, DOT 4, DOT 5.1, ACD elco DOT 3, Pennzoil DOT 3, Prestone DOT 3, Motorcraft DOT 3, Toyota DOT 3

Este comprobador se usa para comprobar la consistencia del líquido de freno. Se señala por 5 LED con lámpara LED. Con iluminación LED. Para todo tipo de líquidos de freno



Code	No.	←L→ mm	g	1	EAN	€
02013000100	2013-1	155	85	1	398519	59,00

2014

Lambdasonde-Spezialwerkzeug

Chrom-Vanadium
C = verchromt

Spezialwerkzeug für Lambdasonden an VW, Audi, BMW, Mercedes, Ford, Opel, Vauxhall, Peugeot, Citroen, Renault, Seat, Skoda etc.

Lambda sensor-special tool

Chrome-Vanadium
C = chromium plated

Special tool for lambda-sensors for VW, Audi, BMW, Mercedes, Ford, Opel, Vauxhall, Peugeot, Citroen, Renault, Seat, Skoda ...

Outil spécial pour sonde Lambda

Chrome-Vanadium
C = chromées

Outil spécial pour sonde Lambda pour VW, Audi, BMW, Mercedes, Ford, Opel, Vauxhall, Peugeot, Citroen, Renault, Seat, Skoda...

Herramienta especial - sonda Lambda

Cromo Vanadio
C = cromado

Herramienta especial para sondas Lambda para VW, Audi, BMW, Mercedes, Ford, Opel, Vauxhall, Peugeot, Citroen, Renault, Seat, Skoda ...



Code	←L→ mm	⊘MM	g	⊠	EAN	€
02014002280	250	22	480	1	380095	38,00

2015

Universal Keil- und Zahnriemenschlüsselsatz

Chrom-Vanadium
C = verchromt

- Zum Entspannen der automatischen Spannvorrichtung
- Einfaches Wechseln des Riemens
- Auch für schwer zugängliche Stellen geeignet
- Große Hebelübersetzung ermöglicht geringen Kraftaufwand
- Form- und Kraftschlüssige Verriegelung für sicheren Halt des Einsteckwerkzeuges
- Einsteckwerkzeuge in Metrisch und Torx Schlüsselweiten für vielfältige Anwendungen
- Ergonomischer Kunststoffgriff
- Hochwertige Schaumstoffeinlage im Metallkasten

Universal V-Belt and cam belt-wrench set

Chrome-Vanadium
C = chromium plated

- For releasing the automatic tensioning device
- Easy replacement of the belt
- Also suitable for places with difficult access
- High lever transmission for low effort
- Form and force-fitting locking device for secure maintaining of the tool
- Tools with metric- and Torx-wrench sizes for multiple applications
- Ergonomic plastic handle
- High quality foam insert in metal case

Jeu clés universelle pour écrous courroie tendeurs et courroie de distribution

Chrome-Vanadium
C = chromées

- Pour décrocher les écrous poulies
- Changement facile de la courroie de distribution
- Utilisable pour les éléments en position difficile
- Petite force pour grand levier
- Un verrouillage par vis permet de maintenir l'outil en toute sécurité
- Outils avec tailles métrique et Torx pour de multiples applications
- Poignée ergonomique en plastique
- Rembourrage en mousse dans la boîte métallique

Juego de llaves universal para correas en cuña y dentadas

Cromo Vanadio
C = cromado

- Para destensar el dispositivo automático de tensión
- Fácil cambio de la correa
- Apto también para sitios de difícil acceso
- Gran transmisión por palanca, reduce el esfuerzo
- Cierre ajustado para seguro mantenimiento de la herramienta
- Herramientas intercambiables en métrica y torx, apertura para múltiples aplicaciones
- Mango ergonómico de plástico
- Cama de alta calidad en poliespam, insertada en caja metálica



Code	enthaltend containing	tlg. pcs.	g	⊠	EAN	€
02015000080	2015-500 2015-20 2015-30	10	2770	1	382075	195,00

2015-500

Universal Keil- und Zahnriemenschlüssel

Chrom-Vanadium
C = verchromt



Universal V-Belt and cam belt-wrench

Chrome-Vanadium
C = chromium plated

Clé universelle pour écrous courroie tendeurs et courroie de distribution

Chrome-Vanadium
C = chromées

Llave universal para correas en V y dentadas

Cromo Vanadio
C = cromado

Code	←L→ mm	g	⊠	EAN	€
02015050080	500	500	1	381481	30,00

2015-20

Torx®-Einsteckschlüssel für Universal Keil- und Zahnriemenschlüssel

Chrom-Vanadium
C = verchromt

Torx® wrench insert tool for universal V-belt and cam belt-wrench

Chrome-Vanadium
C = chromium plated

Attache Torx® pour clé universelle pour tendeurs et courroie de distribution

Chrome-Vanadium
C = chromées

Torx® bits para llaves universales para correas en V y dentadas

Cromo Vanadio
C = cromado



Code	MM	g	mm	EAN	€
02015201080	E 10	30	1	381375	12,50
02015201280	E 12	30	1	381382	12,50
02015201480	E 14	40	1	381399	13,00
02015201680	E 16	40	1	381405	13,00
02015201880	E 18	50	1	381412	13,00

2015-30

Einsteckringschlüssel für Keil- und Zahnriemenschlüssel

Chrom-Vanadium
C = verchromt

Ring wrench insert tool for universal V-belt and cam belt-wrench

Chrome-Vanadium
C = chromium plated

Attache polygonale mâle pour clé universelle pour tendeurs et courroie de distribution

Chrome-Vanadium
C = chromées

Bits para llaves universales para correas en V y dentadas

Cromo Vanadio
C = cromado



Code	MM	g	mm	EAN	€
02015301280	12 x 14	60	1	381443	12,75
02015301380	13 x 15	60	1	381450	12,75
02015301680	16 x 17	80	1	381467	13,25
02015301880	18 x 19	80	1	381474	14,80

2145

Saugheber

ST = standardmäßig
2 bewegliche Saugköpfe, speziell geeignet für gebogene Autoscheiben, Ansaugmechanik und Sicherheitsverriegelung, ideal zum Transportieren, Ein- und Ausheben von Windschutzscheiben, Türen, Blechen usw.
(Empfehlung: paarweise verwenden)

Suction lifters

ST = standard with 2 suction cups, suction mechanism with safety locking, ideal for lifting and transporting sheet metal, plastic sheets, glass panels, installation of windscreens, doors etc. (recommendation: to be used in pairs)
movable suction cups particularly suitable for curved windscreens

Ventouses doubles

ST = standard avec 2 ventouses, système mécanique d'aspiration et blocage de sécurité idéal pour transporter, monter et démonter des pare-brises, portes, tôles etc. (recommandation: à utiliser par paires)

Asas con ventosas

ST = estándar 2 ventosas, mecanismo de vacío y cierre de seguridad, ideal para transportar, montar y desmontar cristales, parabrisas, puertas, chapas, etc. (recomendamos su uso por parejas)



Code	←L→ mm	Saugkopf suction cup Ø mm	Tragkraft capacity kg	g	mm	EAN	€
0214500000	390	120	80	615	1	033021	171,65

2165

Kunststoff-Hämmer

ST = standardmäßig
Eschen-Stiel, auswechselbare
Köpfe aus transparentem Kunststoff
(Celluloseacetat)

Plastic hammers

ST = standard
Ash handle, exchangeable heads
made of transparent plastic
(cellulose acetate)

Massettes avec embouts en
plastique

ST = standard
Manche en bois tropical (Amazonas)
embouts interchangeables en plastique
transparent (acétocellulose)

Martillos con bocas de plástico

ST = estándar
Mango de madera de fresno, bocas
intercambiables de plástico transparente
(acetato de celulosa)

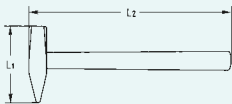

Code	Kopf/head-Ø mm	L ₁ mm	L ₂ mm	g	g	EAN	€
02165003200	32	90	285	305	2	033236	14,95
02165003500	35	100	300	390	2	033243	18,00
02165004000	40	105	320	545	2	033250	21,90
02165005000	50	115	340	865	2	033267	31,70

2166

Ersatzköpfe

ST = standardmäßig
aus transparentem Kunststoff
(Celluloseacetat)
für Kunststoff-Hämmer HEYCO 2165

Spare heads

ST = standard
made of transparent plastic
(cellulose acetate)
for plastic hammers HEYCO 2165

Embouts de rechange

ST = standard
en plastique transparent (acétocellulose)
pour massettes HEYCO 2165

Bocas de recambio

ST = estándar
de plástico transparente (acetato de
celulosa)
para martillos con bocas de plástico
HEYCO 2165



Code	Kopf/head-Ø mm	g	g	EAN	€
02166003200	32	21	10	033304	2,15
02166003500	35	23	10	033311	2,80
02166004000	40	37	10	033328	3,70
02166005000	50	67	10	033335	5,95

2240

Universal-Abzieher

zweiarmig
Z = verzinkt
durch Umstecken der Haken
als Außen- und Innenabzieher
verwendbar

Universal twin leg pullers

twin leg pullers
Z = galvanized
reversible legs for internal or
external applications

Extracteurs universels

à deux griffes réversibles
Z = galvanisés
à utiliser comme extracteur à prise extérieure
et intérieure en tournant les griffes

Extractores exteriores e
interiores

de dos brazos
Z = zincado
cambiando los brazos de posición, este
extractor es convertible en exterior e
interior

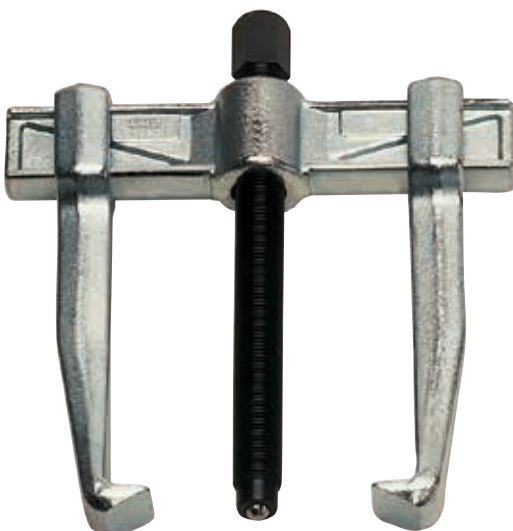

Code	No.	mm	mm	g	g	EAN	€
02240001060	2240-10	80	100	900	1	033779	91,90
02240002060	2240-20	120	100	1030	1	033786	96,15
02240003060	2240-30	160	150	2640	1	033793	173,70
02240004060	2240-40	200	150	3000	1	033809	191,70
02240005060	2240-50	250	200	6500	1	033816	316,40
02240006060	2240-60	350	200	7700	1	033823	367,15

2243

Universal-Abzieher

zweiarmig
Z = verzinkt (2243-10 – 2243-60)
CL = chromfarbig (2243-70)
durch Umstecken der Haken
als Außen- und Innenabzieher
verwendbar

Universal twin leg pullers

twin leg pullers
Z = galvanized
(2243-10 – 2243-60)
CL = chrome coloured (2243-70)
reversible legs for internal or
external applications





Extracteurs universels

à deux griffes réversibles
Z = galvanisés (2243-10 – 2243-60)
CL = couleur de chrome (2243-70)
à utiliser comme extracteur à prise extérieure
et intérieure en tournant les griffes

Extractores exteriores e interiores

de dos brazos
Z = zincado (2243-10 – 2243-60)
CL = cromatizado (2243-70)
cambiando los brazos de posición, este
extractor es convertible en exterior e interior



Code	No.	 mm	 mm	 g		EAN	€
02243001060	2243-10	80	90	900	1	033915	97,15
02243002060	2243-20	130	90	1200	1	033922	104,85
02243003060	2243-30	160	150	2900	1	033939	171,90
02243004060	2243-40	200	150	3200	1	033946	184,00
02243005060	2243-50	250	200	7000	1	033953	303,50
02243006060	2243-60	350	200	8000	1	033960	343,20
02243007070	2243-70	520	200	14000	1	033977	518,50

2246

Verkaufsständer, 5-tlg.

Z = verzinkt
mit Universal-Abziehern
HEYCO 2243

Display stands, 5 pcs.

Z = galvanized
with universal twin leg pullers
HEYCO 2243



Présentoirs, 5 pièces

Z = galvanisés
avec extracteurs universels
HEYCO 2243

Expositores, de 5 piezas

Z = zincado
con extractores exteriores e interiores
HEYCO 2243



Code	enthaltend/containing	 g		EAN	€
02246000060	2243-10, 2243-20, 2243-30 2243-40, 2243-50	16860	1	034073	877,20

2252 – 2253

Abzieher

2252-1	Abzieher, zweiarmig
2253-1	Abzieher, dreiarmig
2252-2	Abzieher, zweiarmig
2253-2	Abzieher, dreiarmig

Z = verzinkt
Abzugsarme zweiseitig verwendbar

Pullers

2252-1	Twin leg pullers
2253-1	Triple leg pullers
2252-2	Twin leg pullers
2253-2	Triple leg pullers

Z = galvanised
Reversible legs for internal or external applications

Extracteurs

2252-1	Extracteurs à deux griffes
2253-1	Extracteurs à trois griffes
2252-2	Extracteurs à deux griffes
2253-2	Extracteurs à trois griffes





Z = galvanisés
Griffes fendues à leur extrémités et réversibles pour une prise extérieure et intérieure

Extractores

2252-1	Extractor de 2 brazos
2253-1	Extractor de 3 brazos
2252-2	Extractor de 2 brazos
2253-2	Extractor de 3 brazos

Z = zincado
Brazos oscilantes utilizables por ambos extremos



Code	No.	 mm	 mm	 g		EAN	€
02252000160	2252-1	150	80	800	1	034080	71,45
02252000260	2252-2	200	130	2000	1	034097	122,10
02253000160	2253-1	150	80	1100	1	034103	96,15
02253000260	2253-2	200	130	2700	1	034110	153,90

2255 – 2256

Abzieher

2255-0 – 2255-31
Abzieher, zweiarmig

2256-0 – 2256-31
Abzieher, dreiarmig

Z = verzinkt
besonders starke Ausführung für extreme Beanspruchung
bestens geeignet zum Abziehen von Kugellagern, Zahnrädern, Riemenscheiben usw.

Pullers

2255-0 – 2255-31
Twin leg pullers

2256-0 – 2256-31
Triple leg pullers

Z = galvanised
heavy duty pattern particularly suitable for removing ball bearings, gears, pulleys etc.

Extracteurs

2255-0 – 2255-31
Extracteurs à deux griffes

2256-0 – 2256-31
Extracteurs à trois griffes

Z = galvanisés
modèles robustes pour très gros effort
spéciaux pour l'extraction des roulements à billes, pignons, poulies, etc.





Extractores

2255-0 – 2255-31
Extractor de 2 brazos

2256-0 – 2256-31
Extractor de 3 brazos

Z = zincado
modelo reforzado para trabajos fuertes especialmente adecuado para extraer rodamientos, engranes, poleas, etc.



Code	No.	 mm	 mm	 g		EAN	€
02255000060	2255-0	100	85	290	1	034127	53,50
02255000160	2255-1	200	150	920	1	034134	73,20
02255000260	2255-2	250	220	2080	1	034141	116,15
02255000360	2255-3	300	240	5000	1	034158	182,35
02256000060	2256-0	100	85	420	1	034202	73,80
02256000160	2256-1	200	150	1260	1	034219	89,35
02256000260	2256-2	250	220	2940	1	034226	152,25
02256000360	2256-3	300	240	7000	1	034233	239,15
022560003160	2256-31	350	350	8670	1	034271	288,20
022560000460	2256-4	400	400	8780	1	034240	314,70
022560000560	2256-5	500	500	9960	1	034257	350,10



Abzieher

**besonders starke Ausführung
für extreme Beanspruchung**

bestens geeignet zum Abziehen von
Kugellagern, Zahnrädern, Riemscheiben usw.

Pullers

**particularly strong model
for extreme use**

best suited for the removal
of bearings, gears, pulleys, etc.

Extracteur

**exécution lourde
pour conditions extrêmes**

idéal pour l'élimination des roulements,
engrenages, poulies, etc.

Extractor

**Modelo extra-fuerte
para usos extremos**

muy adecuado para extraer
rodamientos, ruedas dentadas,
poleas, etc.



2257-4 - 7

Abzieher

- Stufenlos einstellbarer Schwenkbereich durch Federdruck
- Verwendung als 2- und 3- armige Außen- und Innenabzieher durch einfaches Umstecken der Haken

Pullers

- Continuously adjustable swivelling range by spring pressure
- Reversible legs for internal and external applications





Extracteurs

- Angle de rotation continuellement réglable par pression de ressort
- Utilisé comme extracteur intérieur et extérieur à 2 et 3 bras en inversant les crochets

Extractores

- Capacidad de apertura ajustable sin escalones por presión de muelle
- Uso como extractor de 2 y 3 patas reversible para exterior o interior mediante simple cambio de las patas



Code	No.	 mm	 mm	 g		EAN	€
02257000480	2257-4	102	76	810	1	371987	89,00
02257000780	2257-7	178	76	1100	1	371970	129,00

2270-21

Stehbolzenausdreher

- Z = verzinkt
- Für Stehbolzen mit Rechts- und Linksgewinde
 - Tiefe Anordnung des Rändelrades gewährleistet auch das Fassen kurzer Stehbolzenenden

Stud setters and extractors

- Z = galvanized
- For studs with right- and left-hand thread
 - Lowered eccentric knurled wheel allows powerful grip even on stubborn studs



Dégoujonneuses

- Z = galvanisées
- Pour goujons avec filet à droite et à gauche
 - La position basse de la molette permet même de saisir des goujons courts

Extractores de pernos

- Z = zincado
- Para pernos con rosca a derecha
 - E izquierda la posición de la rueda grafilada permite la sujeción de pernos cortos



Code	für Bolzen/for stud-Ø mm	 MM	 g		EAN	€
02270002160	4-20	22	400	1	034561	116,15

2276

Universal-Kugelgelenk-Abzieher

- Z = verzinkt
- zum Ausdrücken der Kugelgelenkzapfen an Spurstangen, Stabilisatoren usw., optimale Anpassungsfähigkeit durch stufenlose Höhenverstellung

Universal ball joint separators

- Z = galvanized
- for pressing ball pivots from ball and socket joints on track rods, stabilizers etc., maximum versatility due to stepless height adjustment



Extracteurs de rotules universels

- Z = galvanisées
- pour démontage des rotules de direction, de suspension etc., adaption optimale par le réglage continu de la hauteur

Extractores universales de articulaciones de bola

- Z = zincado
- para desmontar articulaciones de bola en barras de dirección estabilizadores, etc., adaptación óptima mediante ajuste de altura sin escalones



Code	A mm	C mm	 g		EAN	€
02276000060	18-22	15-50	705	1	034622	97,15

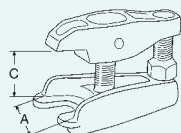





DIN ISO

○MM

○AF

●W

●BA

264 – 267

AF"



MM

268

administrative

HEYCO
No.

269

HEYCO
No.
25

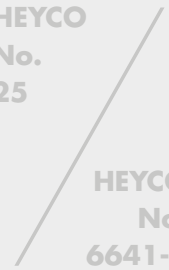

HEYCO
No.
6641-1

270 – 271

A



Z

272 – 275

§



Notizen
Notes

276 – 282

Vergleichstabelle metrischer, amerikanischer und britischer Maße für Schlüsselweiten und Gewindedurchmesser (Nennmaß = Bestellmaß)

Metrische Maße									
Nennmaß Ø MM	Schlüsselweiten				Ø-Gewinde				
	Kleinmaß - mm nach DIN 475/2	Größmaß - mm nach DIN 475/2, Reihe 1	Größmaß - mm nach DIN 475/2, Reihe 2		metrische Maße nach DIN			ISO R272 1968	
					normaler Sechskant	kleiner Sechskant	großer Sechskant	normaler Sechskant	kleiner Sechskant
3	3,02	3,08			1,2	1,4			
3,2	3,22	3,28			1,6			1,6	
3,5	3,52	3,60			1,7				
4	4,02	4,12			2			2	
4,5	4,52	4,62			2,3				
5	5,02	5,12			2,5	2,6		2,5	
5,5	5,52	5,62			3			3	
6	6,03	6,15			3,5				
7	7,03	7,15			4			4	
8	8,03	8,15	8,18		5	6		5	
9	9,03	9,15	9,18						
10	10,04	10,19	10,24		6	8		6	
11	11,04	11,19	11,24		7			7	
12	12,04	12,24	12,30						8
13	13,04	13,24	13,30		8	10		8	
14	14,05	14,27	14,35						10
15	15,05	15,27	15,35		10				
16	16,05	16,27	16,35		(KFZ)				
17	17,05	17,30	17,40		10	12		10	12
18	18,05	18,30	18,40						
19	19,06	19,36	19,46		12	16		12	14
20	20,06	20,36	20,46						
20,8	20,86	21,16	21,26						
21	21,06	21,36	21,46						
22	22,06	22,36	22,46		14			12	14
23	23,06	23,36	23,46						16
24	24,06	24,36	24,46		16	20		16	18
25	25,06	25,36	25,46						
26	26,08	26,48	26,58						
27	27,08	27,48	27,58		18			16	20
28	28,08	28,48	28,58						
29	29,08	29,48	29,58						
30	30,08	30,48	30,58		20	24		20	22
32	32,08	32,48	32,58		22			20	24
33	33,08	33,48	33,58						
36	36,10	36,60	36,70		24	30		22	27
38	38,10	38,60	38,70						
41	41,10	41,60	41,70		27			24	27
42	42,10	42,60	42,70						30
46	46,10	46,60	46,70		30	36		27	30
50	50,10	50,60	50,70		33			33	36
54	54,10	54,60	54,70						
55	55,12	55,72	55,92		36	42		36	39
58	58,12	58,72	58,92						
60	60,12	60,72	60,92		39			39	
63	63,12	63,72	63,92						
65	65,12	65,72	65,92		42	48		42	
67	67,12	67,72	67,92						
70	70,12	70,72	70,92		45			45	
71	71,12	71,72	71,92						
75	75,15	75,85	76,15		48	56		48	
77	77,15	77,85	78,15						
80	80,15	80,85	81,15		52			52	
85	85,15	85,85	86,15		56			56	
90	90,15	90,85	91,15		60			60	
95	95,15	95,85	96,15		64			64	
100	100,15	100,85	101,15		68			68	

Amerikanische Maße												
Nennmaß Ø AF	Schlüsselweiten		Ø-Gewinde									
	decimal - Zoll	decimal - metrisch	ISO R 272 1962		Unified Standard		American Standard B 18.2 1972					
			Bolts	Nuts	normal series BS 1768	heavy series BS 1769	Nuts			Bolts+Screws		
							regular square series	heavy series	finished and regular bolt series, hex. head cap screws	finished and heavy bolt series		
1/8	.1250	3,18	No. 2									
5/32	.1563	3,97	No. 3, 4, 5	No. 0, 1								
3/16	.1875	4,76		No. 2, 3								
13/64	.2031	5,16										
7/32	.2188	5,56										
15/64	.2344	5,95										
1/4	.2500	6,35	No. 6, 8	No. 4								
17/64	.2656	6,75										
9/32	.2813	7,14										
5/16	.3125	7,94	No. 10, 12	No. 5, 6						No. 10		
11/32	.3438	8,73		No. 8								
3/8	.3750	9,52		No. 10								
13/32	.4062	10,32										
7/16	.4375	11,11	1/4	No. 12 1/4	1/4	1/4	1/4	1/4	1/4	1/4	1/4	1/4
1/2	.5000	12,70	5/16	5/16	5/16	5/16	5/16	5/16	5/16	5/16	5/16	5/16
17/32	.5313	13,49										
9/16	.5625	14,29	3/8	3/8	3/8	3/8	3/8	5/16	5/16	3/8	3/8	3/8
19/32	.5938	15,08										
5/8	.6250	15,87	7/16		7/16			3/8	7/16	7/16	1/2	1/2
21/32	.6563	16,67										
11/16	.6875	17,46	1/2	1/2	1/2			7/16	7/16	1/2	1/2	1/2
3/4	.7500	19,05										
25/32	.7813	19,84										
13/16	.8125	20,64	9/16		9/16			1/2	9/16	1/2	9/16	1/2
7/8	.8750	22,22										
15/16	.9375	23,81	5/8	5/8	5/8			5/8	9/16	5/8	5/8	5/8
31/32	.9688	24,61										
1	1.0000	25,40										
1.1/16	1.0625	26,99						5/8		5/8	5/8	5/8
1.1/8	1.1250	28,57	3/4	3/4	3/4			3/4	3/4	3/4	3/4	3/4
1.3/16	1.1875	30,16										
1.1/4	1.2500	31,75						3/4		3/4	3/4	3/4
1.5/16	1.3125	33,34	7/8	7/8	7/8			7/8	7/8	7/8	7/8	7/8
1.3/8	1.3750	34,92										
1.7/16	1.4375	36,51						7/8		7/8	7/8	7/8
1.1/2	1.5000	38,10	1	1	1			1	1	1	1	1
1.5/8	1.6250	41,28						1	1	1	1	1
1.11/16	1.6875	42,86	1 1/8	1 1/8	1 1/8			1 1/8	1 1/8	1 1/8	1 1/8	1 1/8
1.3/4	1.7500	44,45										
1.13/16	1.8125	46,04						1 1/8		1 1/8	1 1/8	1 1/8
1.7/8	1.8750	47,62	1 1/4	1 1/4	1 1/4			1 1/4	1 1/4	1 1/4	1 1/4	1 1/4
2	2.0000	50,80						1 1/4		1 1/4	1 1/4	1 1/4
2.1/16	2.0625	52,39	1 3/8	1 3/8	1 3/8			1 3/8	1 3/8	1 3/8	1 3/8	1 3/8
2.3/16	2.1875	55,56										
2.1/4	2.2500	57,15	1 1/2	1 1/2	1 1/2			1 1/2	1 1/2	1 1/2	1 1/2	1 1/2
2.3/8	2.3750	60,32										
2.7/16	2.4375	61,91						1 1/2	1 1/2	1 1/2	1 1/2	1 1/2
2.9/16	2.5625	65,09										
2.5/8	2.6250	66,67	1 3/4	1 3/4	1 3/4			1 3/4	1 3/4	1 3/4	1 3/4	1 3/4
2.3/4	2.7500	69,85						1 3/4	1 3/4	1 3/4	1 3/4	1 3/4
2.13/16	2.8125	71,44						1 3/4	1 3/4	1 3/4	1 3/4	1 3/4
2.15/16	2.9375	74,61										
3	3.0000	76,20	2	2	2			2	2	2	2	2
3.1/8	3.1250	79,37						2		2	2	2
3.3/8	3.3750	85,72						2 1/4	2 1/4	2 1/4	2 1/4	2 1/4
3.1/2	3.5000	88,90										
3.3/4	3.7500	95,25						2 1/2	2 1/2	2 1/2	2 1/2	2 1/2
3.7/8	3.8750	98,42										

Britische Maße				
Nennmaß Ø BA Ø BW	Ø-Gewinde		Schlüsselweiten	
	BS 916, BS 1083		decimal - Zoll	decimal - metrisch
10 BA		.117	2,97	
9 BA		.131	3,33	
8 BA		.152	3,86	
7 BA		.172	4,37	
6 BA		.193	4,90	
5 BA		.220	5,59	
4 BA		.248	6,30	
1/16	3/32	.256	6,50	
3 BA	1/8	.282	7,16	
3/32		.297	7,54	
2 BA		.324	8,23	
1/8	3/16	.340	8,64	
1 BA		.365	9,27	
0 BA		.413	10,49	
3/16	1/4	.445	11,30	
1/4	5/16	.525	13,33	
5/16	3/8	.600	15,24	
3/8	7/16	.710	18,03	
7/16	1/2	.820	20,83	
1/2	9/16	.920	23,37	
9/16	5/8	1.010	25,65	
5/8	1 1/16	1.100	27,94	
11/16	3/4	1.200	30,48	
3/4	7/8	1.300	33,02	
13/16	15/16	1.390	35,31	
7/8	1	1.480	37,59	
1	1 1/8	1.670	42,42	
1.1/8	1 1/4	1.860	47,24	
1.1/4	1 3/8	2.050	52,07	
1.3/8	1 1/2	2.220	56,39	
1.1/2	1 5/8	2.410	61,21	
1.5/8	1 3/4	2.580	65,53	
1.3/4	2	2.760	70,10	
2	2 1/4	3.150	80,01	
	2 1/2	3.550	90,17	
	2 3/4	3.890	98,80	

Umrechnungstabelle - Zoll in mm

1 Zoll = 25,3995 mm

Conversion Table - Inches to Millimetres

1 inch = 25,3995 mm

Zoll	1"	2"	3"	4"	5"	6"	7"	8"	9"	10"	11"	12"	13"	14"	15"	Zoll	
	mm	25,3995	50,7990	76,1986	101,598	126,998	152,397	177,797	203,196	228,596	253,995	279,395	304,794	330,194	355,594	380,994	
1/64	0,3968	25,7964	51,1959	76,5954	101,995	127,394	152,794	178,193	203,593	228,992	254,392	279,792	305,191	330,591	355,991	381,391	1/64
1/32	0,7937	26,1932	51,5928	76,9923	102,391	127,791	153,190	178,590	203,990	229,389	254,789	280,189	305,588	330,988	356,388	381,788	1/32
3/64	1,1906	26,5901	51,9896	77,3892	102,788	128,188	153,588	178,987	204,386	229,786	255,186	280,586	305,985	331,385	356,785	382,185	3/64
1/16	1,5874	26,9870	52,3865	77,7860	103,185	128,585	153,984	179,384	204,783	230,183	255,582	280,982	306,381	331,781	357,181	382,581	1/16
5/64	1,9843	27,3838	52,7834	78,1829	103,582	128,982	154,381	179,781	205,180	230,580	255,979	281,379	306,778	332,178	357,578	382,978	5/64
3/32	2,3812	27,7807	53,1802	78,5798	103,979	129,378	154,778	180,177	205,577	230,977	256,376	281,776	307,175	332,575	357,975	383,375	3/32
7/64	2,7780	28,1776	53,5771	78,9766	104,376	129,775	155,175	180,574	205,974	231,373	256,773	282,173	307,572	332,972	358,372	383,772	7/64
1/8	3,1749	28,5744	53,9740	79,3735	104,773	130,172	155,572	180,971	206,370	231,770	257,170	282,570	307,969	333,369	358,769	384,169	1/8
9/64	3,5718	28,9713	54,3708	79,7704	105,169	130,569	155,969	181,368	206,768	232,167	257,567	282,967	308,366	333,766	359,166	384,566	9/64
5/32	3,9686	29,3682	54,7677	80,1672	105,566	130,966	156,365	181,765	207,164	232,564	257,964	283,364	308,763	334,163	359,563	384,963	5/32
11/64	4,3655	29,7650	55,1646	80,5641	105,963	131,363	156,762	182,162	207,561	232,961	258,360	283,760	309,160	334,560	359,960	385,360	11/64
3/16	4,7624	30,1619	55,5614	80,9610	106,360	131,760	157,159	182,559	207,958	233,358	258,757	284,157	309,556	334,956	360,356	385,756	3/16
13/64	5,1592	30,5588	55,9583	81,3579	106,757	132,156	157,556	182,956	208,355	233,755	259,154	284,554	309,953	335,353	360,753	386,153	13/64
7/32	5,5561	30,9556	56,3552	81,7547	107,154	132,553	157,953	183,352	208,752	234,152	259,551	284,951	310,350	335,750	361,150	386,550	7/32
15/64	5,9530	31,3525	56,7520	82,1516	107,551	132,950	158,350	183,749	209,149	234,548	259,948	285,348	310,747	336,147	361,547	386,947	15/64
1/4	6,3498	31,7494	57,1489	82,5485	107,948	133,347	158,747	184,146	209,546	234,945	260,345	285,745	311,144	336,544	361,944	387,344	1/4
17/64	6,7467	32,1462	57,5458	82,9453	108,344	133,744	159,143	184,543	209,943	235,342	260,742	286,142	311,541	336,941	362,341	387,741	17/64
9/32	7,1436	32,5431	57,9426	83,3422	108,741	134,141	159,540	184,940	210,339	235,739	261,139	286,539	311,938	337,338	362,738	388,138	9/32
19/64	7,5404	32,9400	58,3395	83,7291	109,138	134,538	159,937	185,337	210,736	236,136	261,535	286,935	312,334	337,734	363,134	388,534	19/64
5/16	7,9373	33,3368	58,7364	84,1359	109,535	134,935	160,334	185,734	211,133	236,532	261,932	287,332	312,731	338,131	363,531	388,931	5/16
21/64	8,3342	33,7337	59,1333	84,5328	109,932	135,331	160,731	186,131	211,530	236,930	262,329	287,729	313,128	338,528	363,928	389,328	21/64
11/32	8,7310	34,1306	59,5301	84,9297	110,329	135,728	161,128	186,527	211,927	237,326	262,726	288,126	313,525	339,225	364,325	389,725	11/32
23/64	9,1279	34,5274	59,9270	85,3265	110,726	136,125	161,525	186,924	212,324	237,723	263,123	288,523	313,922	339,322	364,722	390,122	23/64
3/8	9,5248	34,9243	60,3239	85,7234	111,122	136,522	161,925	187,321	212,721	238,120	263,520	288,920	314,319	339,719	365,119	390,519	3/8
25/64	9,9217	35,3212	60,7207	86,1203	111,529	136,919	162,318	187,718	213,118	238,517	263,917	289,317	314,716	340,116	365,516	390,916	25/64
13/32	10,3185	35,7180	61,1176	86,5171	111,916	137,316	162,715	188,115	213,514	238,914	264,313	289,712	315,113	340,513	365,913	391,313	13/32
27/64	10,7154	36,1149	61,5145	86,9140	112,313	137,713	163,112	188,512	213,911	239,311	264,710	290,110	315,509	340,909	366,309	391,709	27/64
7/16	11,1122	36,5118	61,9113	87,3109	112,710	138,109	163,509	188,909	214,308	239,708	265,107	290,507	315,906	341,306	366,706	392,106	7/16
29/64	11,5091	36,9087	62,3082	87,7077	113,107	138,506	163,906	189,305	214,705	240,105	265,504	290,904	316,303	341,703	367,103	392,503	29/64
15/32	11,9060	37,3055	62,7051	88,1046	113,504	138,903	164,303	189,702	215,102	240,501	265,901	291,301	316,700	342,100	367,500	392,900	15/32
31/64	12,3029	37,7024	63,1019	88,5015	113,901	139,300	164,700	190,099	215,499	240,898	266,298	291,698	317,097	342,497	367,897	393,297	31/64
1/2	12,6997	38,0993	63,4988	88,8983	114,297	139,697	165,097	190,496	215,896	241,295	266,695	292,095	317,494	342,894	368,294	393,694	1/2
33/64	13,0966	38,4951	63,8957	89,2952	114,694	140,094	165,493	190,893	216,292	241,692	267,092	292,492	317,891	343,291	368,691	394,091	33/64
17/32	13,4934	38,8930	64,2925	89,6921	115,091	140,491	165,890	191,290	216,689	242,089	267,488	292,888	318,287	343,687	369,087	394,487	17/32
35/64	13,8903	39,2899	64,6894	90,0989	115,489	140,888	166,287	191,687	217,086	242,486	267,885	293,285	318,684	344,084	369,484	394,884	35/64
9/16	14,2872	39,6867	65,0863	90,4858	115,885	141,284	166,684	192,084	217,483	242,883	268,282	293,682	319,081	344,481	369,881	395,281	9/16
37/64	14,6841	40,0836	65,4831	90,8827	116,282	141,681	167,081	192,480	217,880	243,279	268,679	294,079	319,478	344,878	370,278	395,678	37/64
19/32	15,0809	40,4805	65,8800	91,2795	116,679	142,078	167,478	192,877	218,277	243,676	269,076	294,476	319,875	345,275	370,675	396,075	19/32
39/64	15,4778	40,8773	66,2769	91,6764	117,075	142,475	167,875	193,274	218,674	244,073	269,473	294,873	320,272	345,672	371,072	396,472	39/64
5/8	15,8747	41,2742	66,6739	92,0733	117,472	142,872	168,271	193,671	219,071	244,470	269,870	295,270	320,669	346,069	371,469	396,869	5/8
41/64	16,2715	41,6711	67,0706	92,4701	117,869	143,269	168,668	194,068	219,467	244,867	270,266	295,666	321,066	346,466	371,866	397,266	41/64
21/32	16,6684	42,0679	67,4675	92,8670	118,266	143,666	169,065	194,464	219,864	245,263	270,663	296,063	321,462	346,862	372,262	397,662	21/32
43/64	17,0653	42,4648	67,8643	93,2639	118,663	144,063	169,462	194,862	220,261	245,661	271,060	296,460	321,859	347,259	372,659	398,059	43/64
11/16	17,4621	42,8617	68,2612	93,6608	119,060	144,459	169,859	195,258	220,658	246,058	271,457	296,857	322,256	347,656	373,056	398,456	11/16
45/64	17,8590	43,2585	68,6581	94,0576	119,457	144,856	170,256	195,655	221,055	246,454	271,854	297,254	322,653	348,053	373,453	398,853	45/64
23/32	18,2559	43,6554	69,0549	94,4545	119,854	145,253	170,653	196,052	221,452	246,851	272,251	297,651	323,050	348,450	373,850	399,250	23/32
47/64	18,6527	44,0523	69,4518	94,8513	120,250	145,650	171,050	196,449	221,849	247,248	272,648	298,048	323,447	348,847	374,247	399,647	47/64
3/4	19,0496	44,4491	69,8487	95,2482	120,647	146,047	171,446	196,846	222,245	247,645	273,045	298,445	323,844	349,244	374,644	400,044	3/4
49/64	19,4465	44,8460	70,2455	95,6451	121,044	146,444	171,843	197,243	222,642	248,042	273,441	298,841	324,241	349,641	375,041	400,441	49/64
25/32	19,8433	45,2429	70,6424	96,0419	121,441	146,841	172,240	197,640	223,039	248,439	273,838	299,238	324,637	350,037	375,437	400,837	25/32
51/64	20,2402	45															

HEYCO



**HEYCO-WERK
REMSCHEID
BIRGDEN III**
Bergisches Land

**HEYCO-WERK
REMSCHEID/
BERGISCH-BORN**
Bergisches Land



**HEYCO-WERK
SÜD**
Bayerischer Wald

**HEYCO-WERK
IRELAND Ltd.**
Irland



**HEYCO-WERK
CR s.r.o.**
Tschechien

Administrative HEYCO-Ident-Nummern/Administrative HEYCO-Identification-Numbers

HEYCO Qualitätswerkzeuge GmbH & Co. KG:

UST.-IdNr./VAT Reg. Number : DE 3076 04891

BIC : COBADEFFXXX

IBAN : DE 84 3404 0049 0762 0560 00

DUNS-Nr.	: HEYCO-WERK Remscheid Birgden	315941872
	: HEYCO-WERK Remscheid Bergisch Born	333601545
	: HEYCO-WERK SÜD Tittling, Werkzeuge/Tools	498994722
	: HEYCO-WERK SÜD Tittling, Kunststoff/Plastic	314327891
	: HEYCO-WERK Ireland Ltd.	219662723
	: HEYCO-WERK CR s.r.o.	366947856

Nummernverzeichnis / Numerical Index

HEYCO-No.		HEYCO-No.		HEYCO-No.		HEYCO-No.		HEYCO-No.		HEYCO-No.	
25-00-10	38	40-70	51	50-58	64	79-0310	79	497	28	961-7	148
25-01-1	38	40-71	51	50-65	66	79-3010	79	501	114	965-9	148
25-03	38	40-75	52	50-75	66	79-3310	79	503	114	968-8	149
25-04	38	40-76	52	50-76	67	84-0010	80	510	114	969-10	149
25-05	38	40-85	52	50-77	67	84-3010	80	530	116	E 970-3	146
25-05-1	38	40-88	52	50-78	65	94-2550	81	B 530	116	970-10	149
25-05-5	38	41-0010	53	50-79	65	100-00-5	82	K 530	116	971-17	150
25-06	38	41-50	53	50-80	68	100-00-6	82	531	118	972-14	150
25-07	38	41-80	53	50-80-1	68	100-01-1	82	531-19	118	973-8	150
25-08	38	41-1010	53	50-80-2	68	100-03-1	82	531-5	119	975-3010	151
25-6	39	41-3010	53	50-80-3	68	100-04	82	541	121	980-14	151
25-11	38	43-0010	55	50-80-4	68	100-05	82	545	121	984-3800	152
25-15	38	43-50	55	50-80-10	68	100-06	82	600-10	115	985-0010	152
25-16	38	43-80	55	50-80-20	68	100-07	82	610	115	985-3010	152
25-19	39	43-1010	55	50-80-30	68	100-6	83	664	102	987	42/51/65
25-20	40	43-3010	55	50-80-40	68	100-12	83	665	102	990-4	153
25-30	40	44-0010	56	50-85	68	100-14	82	666	102	990-4-1 VDE	153
25-31	40	44-50	56	50-86	68	100-15	82	695-1	111	991-7	153
25-32	41	44-80	56	50-87	69	100-16	82	762	104	991-8	154
25-35	41	44-3010	56	50-90	69	101-0	84	764	104	991-8-1 VDE	154
25-36	41	45-0010	57	50-95	69	101-10	84	765	104	992-4	154
25-50	41	45-50	57	50-96	69	101-30	84	766	104	995-8	155
25-70	42	45-80	57	50-97	69	101-50	84	776	109	1000	124
27-80	43	45-3010	57	50-100	69	101-60	84	778	109	1000-914	126/137
27-90	43	47-0010	56	57-0010	70	101-80	84	779	111	1000-915	126/138
27-3010	43	49-5 VDE	178/209	67-50	70	103	224	782	104	1002	124
27-4010	43	50-00-1	58	67-52	72	105-00-6	85	784	104	1002-910	126/127
29-3010	44	50-00-7	58	67-80	72	105-03	85	785	104	1052	179/209
30-3010	45	50-00-10	58	70-0	72	105-04	85	786	104	1090	159
31-1910	45	50-00-15	58	70-0010	72	105-05	85	792	104	1090-1	159
40-00-1	46	50-00-18	58	70-30	73	105-12	85	792-10	106	1101	125
40-00-7	46	50-00-27	58	70-50	72	105-14	85	792-18	109	1101-911	126/129
40-00-10	46	50-02	58	70-80	73	106-0	85	792-21	106	1127-1	141
40-00-15	46	50-03	58	70-1010	73	113	225	792-31	106	1127-2	141
40-00-27	46	50-04	58	70-3010	73	300	172	792-41	107	1127-3	142
40-02	46	50-04-1	58	72-4010	73	313	172	792-51	108	1128	142/143
40-03	46	50-04-5	58	72-4310	73	315	172	794-10	106	1128-3	147/155
40-04	46	50-04-25	58	73-03	74	350	10	794-21	106	1128-8	145/147
40-04-1	46	50-05	58	73-33	74	B 350	11	794-31	107	1128-21	147/156
40-04-15	46	50-05-5	58	73-0310	74	HP 350	11	794-41	107	1128-22	147/156
40-04-25	46	50-06	58	73-3310	74	K 350	11	795	104	1128-23	147/158
40-05	46	50-08	58	75-0	75	R 350	12	795-20	109	1128-933	126/131
40-05-5	46	50-09	58	75-0010	75	370	15	796	104	1128-942	126/133
40-06	46	50-6	59	75-0110	76	380	15	800	28	1128-943	126/135
40-07	46	50-10	58	75-0310	77	390	15/16	808	29	1129	144
40-6	47	50-12	59/60	75-10	76	392	16	810	29/30	1129-8-1/2	145
40-12	47	50-14-1	58	75-30	75	400	17/18	820	31/32	1135	125
40-14	46	50-15	58	75-50	75	B 400	18	840	33	1135-933	126/131
40-15	46	50-16	58	75-60	76	HP 400	19	845	33	1170	162
40-16	46	50-19	61	75-80	75	K 400	19	894	12	1170-8-1	165
40-17	48	50-19-1	61	75-1010	76	R 400	22	895	13	1170-8-2	165
40-18	48	50-19-3	61	75-3010	75	410	22	K 895	14	1170-11	166
40-19-1	48	50-20	62	75-3110	76	K 410	23	896	120	1171	163
40-19-2	48	50-30	62	75-3310	77	430	23	K 896	120	1171-8-1	166
40-19-3	48	50-31	62	76-0010	77	450	23	R 896-9	120	1172	163
40-20	49	50-32	63	77-0	78	K 450	24	900	121	1172-8-1	166
40-30	49	50-33	63	77-30	78	475	24/25	910	122/126/127	1174	164
40-31	49	50-34	63	78-0	78	K 475	26	911	126/129	1174-11	166
40-32	50	50-35	63	78-0010	78	R 475	26	933	126/131	1176-1	167
40-35	50	50-36	63	78-30	79	493	27	942	126/133	1176-2	167
40-36	50	50-50	64	78-3010	78	R 493	27	943	126/135	1176-3	167
40-50	50	50-55-2	64	79-0010	79	495	27	960-7	148	1177-1-1	167

Nummernverzeichnis / Numerical Index

HEYCO-No.		HEYCO-No.		HEYCO-No.		HEYCO-No.		HEYCO-No.		HEYCO-No.	
1177-1-2	167	1262-32-2	186	1460	207	1664	238	2012	253	4515	217
1177-1-3	167	1262-40-2	186	1470	206	1664-2	238	2013	254	4530	217
1177-1-5	168	1262-48-2	186	1479	211	1664-10	238	2014	255	4535	217
1177-2-3	167	1280	186	1480	212	1664-10-2	238	2015	255/256	4536 VDE	221
1177-2-4	167	1280-L	187	1483	212	1664-12	238	2145	256	4537	218
1178-1-2	168	1281	187	1484	212	1664-12-2	238	2165	257	4545	218
1178-1-3	168	1282	187	1491	213	1664-4	239	2166	257	4550 VDE	221
1178-1-4	168	1285	187	1494	213	1664-12-4	239	2199	125	4560	219
1178-1-5	168	1286	188/189	1495-3	213	1665	239	2240-10	257	4561	219
1179-1-1	169	1286-ST	189	1496-2	213	1667	239	2240-20	257	4562	219
1179-1-2	169	1286-4	189	1497	213	1668	240	2240-30	257	4563	219
1186	81/164	1287	190	1500	224	1669	240	2240-40	257	4564	220
1187	81/165	1287-24	190	1505	224	1670	240	2240-50	257	4565	220
1200	173	1327	190	1509	224	1675	241	2240-60	257	4566	220
1200 VDE	176	1328	191	1512	225	1676	241	2243-10	258	4567	220
1206	173	1329-3	191	1513	225	1677	241	2243-20	258	6300	91
1206 VDE	176	1329-4	191	1520	226	1678	241	2243-30	258	6300-18	92
1207	173	1330	191	1522	226	1679	241	2243-40	258	6300-19	92
1207 VDE	176	1333	191	1523	226	1681	241	2243-50	258	6300-20	93
1208	174	1335	194	1530	227	1686	241	2243-60	258	6300-31	92
1208 VDE	177	R 1335-6	194	1531	227	1686-1	241	2243-70	258	6300-36	93
1209	174	1337	195	1540-1	227	1689	242	2246	258	6300-50	93
1209 VDE	177	R 1337-6	195	1550	228	1702-1	242	2252-1	259	6300-55	94
1212	174	1340	196	1551	228	1702-2	242	2252-2	259	6300-58	94
1213	175	H 1340	197	1555	228	1702-3	242	2253-1	259	6301-2	99
1213 VDE	177	K 1340	197	1555-1	228	1706-1	242	2253-2	259	6301-4	99
1215	175	HP 1340-9	197	1556	229	1706-3	242	2255-0	259	6301-10	99
1220	175	R 1340	198	1557	229	1721	243	2255-1	259	6301-22	100
1220 VDE	178	1341	198	1558	229	1721-1	243	2255-2	259	6301-40-1	100
1230	179	HP 1343-9	199	1560	229	1721-2	243	2255-3	259	6301-40-2	100
1231	179	1345	199	1561	230	1731	244	2256-0	259	6301-41-1	100
1232	180	R 1345-7	199	1562-1	230	1754	245	2256-1	259	6301-41-2	100
1233	180	1347	200	1563	230	1755	245	2256-2	259	6500	95
1250	181	R 1347-6	200	1564	230	1757	245	2256-3	259	6500-19	96
1252	181	1348	201	1565	231	1759	245	2256-31	259	6500-31	97
1255	182	H 1348-8	201	1565-41	231	1781	245	2256-4	259	6501-3	99
1256	182	R 1348-10	201	1566	231	1782-2	245	2256-5	259	6501-4	99
1257	182	HP 1349-8	202	1567	231	1783	246	2257-4	261	6501-5	99
1258	183	1360	121	1570	232	1790-1	246	2257-7	261	6501-10	99
1261	183	1405	202	1575	232	1805	246	2270-21	261	6501-20	100
1261-1	183	1411	203	1576	232	1806	247	2276	261	6501-22	100
1261-10	184	1411 VDE	208	1577	224/233	1807	247	3301-1	86	6501-40	100
1261-30	184	1412	203	1578	233	1814-2	247	3305	86	6501-41	100
1261-40	184	1415	204	1610	233	1814-3	247	3310	86	6600	97
1261-50	184	1417	204	1615	233	1814-4	247	3700	88	6600-19	98
1261-60	184	1419	210	1616	233	1814-12	247	3700-19	88	6601-3	99
1261-31	184	1420	210	1617	233	1814-13	247	3704-15	89	6601-4	99
1261-41	184	1424	210	1621-1	234	1815	248	3704-25	89	6601-5	99
1261-51	184	1425	210	1621-2	234	1836	248	3705-50	89	6601-10	99
1261-61	184	1426 VDE	211	1621-3	234	1837	248	3706-10	90	6601-20	100
1261-32	185	1427 VDE	211	1622-1	234	1840-5	249	3800	89	6600-31	98
1261-42	185	1430	204	1622-2	234	1840-8	249	3800-19	89	6601-40	100
1261-52	185	1435	205	1626	234	1842	250	3804-25	90	6601-41	100
1261-62	185	1436	205	1640	236	1856-3	250	3804-50	90	6700	101
1262	185	1436 VDE	208	1641	236	1856-4	250	3805-50	90		
1262-1	185	1437	205	1642	236	1857	250	3806-10	90		
1262-10	186	1445	206	1643	236	1905	251	4500	215		
1262-24-1	186	1450 VDE	208	1656	237	1920	251	4500-100	215		
1262-32-1	186	1452	206	1660	237	2010-3	251	4501	215		
1262-40-1	186	1454	206	1661	237	2010-8	252	4502	215		
1262-48-1	186	1456	207	1662	238	2010-10	252	4511 VDE	221		
1262-24-2	186	1458	207	1663	238	2011	253	4512	216		

Inhaltsverzeichnis

Artikel	
A	
Abhorchgeräte	251
Abisolierzangen	175
Abzieher	257-261
Achsmannschetten-Spannzange	180
Adapter	38/46/58/82/85
Aluminium-Klemmleisten, leer	42/51/65
Antriebs- und Verbindungsteile - 1/4" □	38
Antriebs- und Verbindungsteile - 3/8" □	46
Antriebs- und Verbindungsteile - 1/2" □	58
Antriebs- und Verbindungsteile - 3/4" □	82
Antriebs- und Verbindungsteile - 1" □	85
Auffangwannen für flüssige Medien	251/252
Aufreiber	204
Aufsteckrohre	33
Aufsteck- Umschaltknarren	46/58
Ausstellungswände	160-164
Auswuchtgewichtzange	180
Auto- Lichtprüfer	210
Automatischer Körner	232
B	
Bandmaße	249
Bandschlüssel	190/191
Behältnisse	124,125/141-145
Betätigungswerkzeuge - 1/4" □	38
Betätigungswerkzeuge - 3/8" □	46
Betätigungswerkzeuge - 1/2" □	58
Betätigungswerkzeuge - 3/4" □	82
Betätigungswerkzeuge - 1" □	85
Biegsame Verlängerungen	38
Bithalter	86
Blindnietzangen	185/186
Bremsenentlüftungsschlüssel	117/119
Bremsfederzangen	179
Bremsflüssigkeitstester	254
Brillen	244
Bürsten	244/245
C	
Compact- Werkzeug-Garnituren	209
Cuttermesser	238
D	
Dichtungsschaber	239
Digitale Drehmomentschlüssel	103/104
Digitale Drehwinkelmeßgeräte	111
Doppel-Gelenkschlüssel	27
Doppel-Gelenkschlüssel-Sätze	27
Doppelmaulschlüssel	10-14
Doppelmaulschlüssel-Sätze	11-14
Doppelringschlüssel	23-26
Doppelringschlüssel, offen	28
Doppelringschlüssel-Sätze	24/26
Doppelsteckschlüssel	116
Doppelsteckschlüssel-Sätze	116
Drahtbürsten	245
Drahtwirbelzange	183
Drehmomentschlüssel	102/104/109
Drehmomentvervielfältiger	111
Drehmomentschlüssel Varitorque	104
Drehmoment-Werkzeug-Garnituren	109
Drehstangen	121
Drehwinkel-Meßgeräte	111
Dreikant-Hohlschaber	238
Dreikant-Löffelschaber	237
Durchsteckknarren	38/46/58
Durchreiber	230-232

Artikel	
E	
Eck-Rohrzangen	191
Edelstahl-Drahtbürste	245
Einmaulschlüssel	12/13
Einmaulschlüssel, verstellbar	15/16
Einringsschlüssel	29
Einsätze	39/47-50/59-64/83/85
Einsätze, IMPACT	87-98
Einsatzspender, leer	68/69
Einsatzspender mit Steckschlüssel-Einsätzen	52/66-69
Einsteckwerkzeuge für Drehmomentschlüssel	106-108
Elektriker-Rucksack, leer	179/209
Elektriker Rucksack	179/209
Elektriker-Schraubendreher	208/209/221
Elektriker-Zangen	176-178
Entnahmebehälter	119
Ersatzbänder für Bandschlüssel	191
Ersatzköpfe für Hämmer	227
Expert-Werkzeug-Garnituren	70-72
F	
Feilen	240-242
Feilenbürsten	244
Feilenhefte	241
Feilkloben	237
Fettpressen	246
Flachmeißel	228/229/230
Flachrundzangen	174/177
Flachscharer	238
Flachzangen	173/176
Flexible Steckschlüssel	121
Formel Plus Werkstattwagen	142/143/147
Freifach-Modul	146
Fugenmeißel	229
Fühlerlehren	247
Fußteilschubblende für Verkaufswände	166
G	
Gabelringschlüssel	17-23
Gabelringschlüssel-Sätze	18-23
Gabelschlüssel	10-14
Gelenkgriffe	38/46/58/82
Gelenkknarren	58
Gelenksteckschlüssel	27
Gelenksteckschlüssel-Sätze	27
Gewindefeilen	240
Gewindenietzangen	183-185
Glühkerzeneinsatz	48
Greifer	213
Greifzangen	172
Griffe mit Gleitstück	38/46/58/82/85
Gripzangen	186-190
Gummihämmer	227
Gummiringe	100
H	
Hämmer	226/227
Haken für Verkaufswände	167-169
Hakenschlüssel	28
Handfeilkloben	237
Handhebel-Fettpressen	246
Handnietzangen	183-185
Handschutzgriffe für Meißel	230
Hebelblechscheren	234
Hebeleisen	224/225
Hebel-Umschaltknarren	38/46/58
Holzgliedermaßstab	248

Artikel	
I	
IMPACT-Kardangelenke	99
IMPACT-Schraubendreher Einsätze	92-98
IMPACT-Steckschlüssel-Einsätze	87-98
IMPACT-Steckschlüssel-Garnituren	93-94/98-101
IMPACT-Verbindungsstücke	89/90/99
IMPACT-Verlängerungen	89/90/99
IMPACT-Werkzeuggarnitur	101
Inbusschlüssel	194-199
Innensechskant-Schraubendreher-Einsätze	40/49/63
Innenvielzahn-Schraubendreher-Einsätze	63
Isolierband	251
K	
Kabel-Klappmesser	240
Kardangelenke	38/46/58/82
Keil- und Zahnriemenschlüssel	255
Klauenschlüssel	15
Knarren	38/46/58/82/85
Kniebrett	159
Körner	232
Kolbenring-Spannbänder	242
Kolbenring-Zangen	242
Kombinationsschlüssel	17-19
Kombinationsschlüssel-Sätze	18/19
Kombinationszangen	173/176
Kombinierte Steckschlüssel-Garnituren	78/80/81
Kombinierte Steckschlüssel- und Schraubendreher-Einsatz- Garnituren	44/45/56/70/78/79
Kombinierte Steckschlüssel- und Schraubenschlüssel-Garnituren	72
Kombi-Spender, leer	68
Kombi-Spender mit Steckschlüssel- und Schraubendreher-Einsätzen	52/66/67/68/69
Koflügelochner	159
Kontaktfeilen	241
Kraftseitenschneider	172
Krallengreifer	213
Kreuzmeißel	229/230
Kreuzschlitz-Schraubendreher	202/203
Kreuzschlitz-Schraubendreher-Einsätze	41/50/63
Kreuzschlüssel	115
Kugelgelenke	90/99
Kugelgelenk-Abzieher	261
Kugelkopf-Winkelschraubendreher	194/199
Kugelkopf-Winkelschraubendreher-Sätze	194
Kunststoff-Feilenhefte	241
Kunststoff-Hämmer	257
Kunststoff Schaber	225
Kupferhammer	226
Kurbeln	46/58
L	
Lambdasonde Spezialwerkzeug	255
Lampen	243
Langbeckzangen	173/174/176/177
Lochkreis-Messschieber	246
Lochplatten-Verkaufswände	160-164
Lochscheren	234
Löffelschaber	237
M	
Magnetbithalter	86
Magnethaftschale	253
Magnetheber	213
Magnetschlüssel-Sätze	15
Maßstäbe	248
Maulschlüssel	10-14/29/30
Maxline Ringmaulschlüssel	20-23
Maxline Ringmaulschlüssel-Sätze	22-23

Inhaltsverzeichnis

Artikel		Artikel		Artikel	
Meißel	228-230	Sicherheitswerkzeuge	208/209/221	U	
Messer	238-240	Sicherungs-Gummiringe	100	Umschaltknarren	38/46/58/82/85
Messschieber	246-248	Sicherungsanzgen	181-182	Umsteck-Schraubendreher	211
Metallsägeblätter	233	Sockelblenden für Verkaufswände	165/166	Universal-Abzieher	257-261
Metallsägebogen	233	Spannungsprüfer	210/211	Universal-Gripzangen	186/187
Mini-Gripzange	190	Spender, leer	68	Universal-Kugelgelenke	90
Mobiles Grip-System	188/189	Spender mit Steckschlüssel-Einsätzen	52/66-69	Universal-Kugelgelenke-Abzieher	261
Montagehebel	224/225	Spender mit Steckschlüssel- und Schraubendreher-Einsätzen	52/66/67	Universal-Steckschlüssel-Einsätze	88/89
Module	148-158	Spezial-Montageanzgen	179-182	Universal-Verlängerungen	90
Module in Werkstattwagen Formel Plus	147-158	Spiegel	213	Universal-Zangen	186-190
Montage-Steckschlüssel	114	Sch		V	
Montageanzgen	179/180	Schaber	225/237-239/245	VARICAT Knarren	36-38/46/58
Multifunktionstrichter	253	Schaltchrankschlüssel	212	VARITORQUE-Drehmomentschlüssel	104/105
N		Schieblehren	247	VDE Elektriker Rucksack	179
Nageleisen	224	Schlagdreher	86	VDE-Schraubendreher	208/209/221
Nietanzgen	183/185	Schlag-Maulschlüssel	29-30	VDE-Schraubendreher-Sätze	208/221
Nietzieher	233	Schlag-Ringschlüssel	31/32	VDE-Spannungsprüfer	211
Nylon-Ersatzköpfe	227	Schlagschraubendreher-Sätze	86	VDE-Zangen	176-179
Nylon-Hämmer	227	Schlitz-Schraubendreher-Einsätze	40/49/62	Verbindungsstifte	100
ö/o		Schlitzmeißel	229	Verbindungsstücke	40/48/60/84/87
Öldienstschlüssel	29	Schlosserhämmer	226	Verbindungsriekante	40/48/60/84/87
Ölfilterschlüssel	191	Schlüsselfeilen	242	Vergaser-Schraubendreher	206/216
Ölkannen	245/246	Schränke	125	Verkaufsdisplay mit Hebelumschaltknarren TALENTA	81/165
Ölwannen	251/252	Schraubenausdreher-Sätze	213	Verkaufsdisplay mit Hebelumschaltknarren VARICAT	81/164
Offene Doppelringschlüssel	28	Schraubendreher	202-212/214-221	Verkaufsspender, leer	69
P		Schraubendreher-Einsätze	40/41/49/50/62-64	Verkaufsspender mit Steckschlüssel- und Schraubendreher-Einsätzen	52/66/67
PHILLIPS-Schraubendreher	202/203	Schraubendreher-Einsatz-Sortimente	41/50/64	Verkaufsständer	160-164/215
PHILIPS-Schraubendreher-Einsätze	41/50/63	Schraubendreher-Sätze	204-206/217-219	Verkaufswände	160-163
Plastikhämmer	257	Schraubendreher-Verkaufsständer	215	Verlängerungen	38/46/58/82/85
POZIDRIV®-Schraubendreher	203/216	Schweiß-Gripzangen	187	Verlängerungen, schwenkbar	38/46/58
POZIDRIV®-Schraubendreher-Einsätze	41/50/63	Schwenkbare Verlängerungen	38/46/58/89/90	Verstellbare Einmaulschlüssel	15/16
Präsentationssysteme	160-169	ST		Verstellbare Rohrzangen	191
Präzisionsschieblehren	247	Stahl-Drahtbürsten	245	W	
Präzisions-Stahlmaßstäbe	248	Stahlmaßstäbe	248	Wasserpumpenzangen	172
Preisfahnen	168	Stahlrollbandmaße	249	Werkstattfeilen	241
R		Starter- und Blockschlüssel	23	Werkstatt-Schraubendreher	205/217
Radmutternschlüssel	114	Steckgriffe	38	Werkstattwagen, leer	139-144
Reifendruckprüfer	250	Steckschlüssel	116/121	Werkzeug-Garnituren	71/72
Reifen-Montierwerkzeug	225	Steckschlüssel-Einsätze auf Aluminium Klemmleiste	42/51/65	Werkzeugsatz für Bremsflüssigkeitsentnahme	117-119
Reifen- und Montagehebel	224	Steckschlüssel-Einsätze	39/40/47-49/59-62/83/85	Werkzeughalterungen für Verkaufswände	167-169
Reißnadeln	250	Steckschlüssel, flexibel	121	Werkzeugkästen, leer	124
RIBE CV-Schraubendreher-Einsätze	63	Steckschlüssel-Garnituren	43/44/45/53-57/70-80/84/85	Werkzeugsätze in Modulen	148-155
Ringmaulschlüssel	17-19	Steckschlüssel-Sätze	41/50/64	Werkzeugsätze mit Meißeln, Körnern, Splint- und Durchtreibern	228/231
Ringmaulschlüssel Maxline	20-23	Stehbolzenausdreher	261	Werkzeugsätze mit Splinttreibern	231
Ringmaulschlüssel-Sätze Maxline	23	Steinmeißel	229/230	Werkzeugschränke, leer	125
Ringschlüssel	23-26	Stethoskope	251	Werkzeug-Sortimente	126-138
Ringschlüssel-Sätze	24/26	Stifte	100	Werkzeugtruhen, leer	125
Rohrschneider	235/236	Stiftschlüssel	194/195	Winkelgriffe	58
Rohrsteckschlüssel	120	Stiftschlüssel-Sätze	194/195	Winkelschraubendreher	194-202/212
Rohrsteckschlüssel-Sätze	120	Stufendrehstangen	121	Winkelschraubendreher-Sätze	194-202
Rohr- und Wasserpumpenzangen	172	T		X	
Rohrzangen	191	Talenta-Knarren	58	XZN-Schraubendreher-Einsätze	63
Rollbandmaße	249	Taschenlampen	243	Z	
Rückschlagfreie Nylonhämmer	227	Teleskop-Spiegel	213	Zangen	170-191
Rundanzgen	173/174/176/177	T-Gleitgriffe	38/46/58/82	Zollstöcke	248
S		TORX®-Kugelkopf-Winkelschraubendreher-Sätze	202	Zubehör für Verkaufswände	165-169
Sägeblätter	233	TORX®-Schraubendreher	204/217	Zündkerzenbürsten	245
Sägebogen	233	TORX®-Schraubendreher-Sätze	207/219	Zündkerzen-Einsätze	48
Sätze mit Schraubendreher-Einsätzen	41/50/64	TORX®-Schraubendreher-Einsätze	41/50/63	Zug-Ringschlüssel	33
Sätze mit Schraubendreher- und Steckschlüssel-Einsätzen	44/56/77/78/79	TORX®-Steckschlüssel-Einsätze	40/49/62		
Saugheber	256	TORX®-Winkelschraubendreher	200-202		
Sechskant-Stiftschlüssel	194-199	TORX®-Winkelschraubendreher-Sätze	200-202		
Sechskant-Stiftschlüssel-Sätze	194/195/198	Trichter	253		
Seitenschneider	174/175/177	Türverkleidungs-Lösehebel	239		

Alphabetical Index

Article	
A	
Accessories 1/4" □	38
Accessories 3/8" □	46
Accessories 1/2" □	58
Accessories 3/4" □	82
Accessories 1" □	85
Accessories for trolley	145/146
Accessories for perforated tool bars	165-169
Adapters	38/46/58/82/85
Adapter head with square	106
Adjustable centre punch	232
Adjustable wrenches	15/16
Aluminium socket rail, empty	41/51/65
B	
Balancing weight pliers	180
Ball head hexagonal wrenches	194
Ball joint Sseparators	261
Ball pein hammers	226
Bitholder	86/218
Blind rivet tool	185/186
Bolt circle measuring gauge	246
Braces	46/58
Bradawls	204
Brake fluid tester	254
Brake spring pliers	179
Brake venting wrench	118
Brushes	244/245
Cabinets	125
C	
Cable-Folding knives	240
Calipers	247
Car light testers	210
Centre punches	232
Chisel and punch sets	228
Chisels	228-230
Circlip pliers	181/182
Combination pliers	173/176
Combination wrench sets	19/22
Combination wrench sets Maxline	22
Combination wrenches	17-19
Combination wrenches Maxline	22-23
Combined sets of sockets	57
Combined sets of sockets and Screwdriver sockets	44/56/64/70/77/78/79/93
Combinet set of tools	81
Compact-Tool-Sets	209
Compartments	124/125/139-144
Contact files	241
Control cabinet key	212
Converter	38/46/58/82/85
Copper hammer	226
Cross cut chisels	229/230
Cross slot screwdriver sockets	40/41/50/63
Cross Sslot screwdrivers	203/216
Crowfoot wrenches	15
Curved bearing scrapers	237
Cutter knives	238-240
Cutting nippers	174/175/177

Article	
D	
"Dead Blow" nylon hammers	227
Diagonal cutting nippers	174/175/177
Digital vernier calipers	247
Digital torque angle applicator	111
Digital torque wrenches	103/104
Dispensers with sockets	52/68/69
Dispensers with sockets and screwdriver sockets	52/66/67
Dispensers, empty	68/215
Door trim panel removers	239
Double ended open jaw wrench sets	11/12/14
Double ended open jaw wrenches	10-14
Double ended ring wrench sets	24/26
Double ended ring wrenches	23-26
Double ended socket wrench sets	116
Double ended socket wrenches	116
Double ended swivel wrench sets	27
Double ended swivel wrenches	27
Double ended tubular socket wrench sets	120
Double ended tubular socket wrenches	120
Drain pan	251/252
Drain plug wrenches	27
Draining container	119
E	
Elbow pipe wrenches	191
Electricians backpack	179/209
Electricians backpack, empty	179
Electricians pliers	176-178
Electricians screwdrivers	205/217
End Cutting pliers	175
Engineers' files	241/242
Engineers' hammers	226
Engineers' screwdrivers	202-206/218
Expert „75 Years Edition" tool Sset	70-72
Extensions	38/46/58/82/85/99
Extensions, wobble	38/46/58
F	
Feeler gauges	247
Fender cover	159
File card brushes	244
File handles	241
Files	241/242
Flare nut ring wrenches	28
Flat cold chisels	228-230
Flat nose pliers	173
Flex. head reversible ratchet	58
Flexible extension	38/46/58
Flexible nut spinners	121
Folding hooks	167-169
Folding rules	248
Formel plus workshop trolley	142/143/147
Four way rim wrenches	115
Funnel	253
G	
Gasket scrapers	239
Glasses	244

Article	
H	
Glow plug socket	49
Goose neck ripping bars	224
Grease guns	246
Grip pliers	186-190
Grooving chisel	229
H	
Hacksaw blades	233
Hacksaw frame	233
Hammers	226/227/257
Hand guards	230
Hand rivet nut tool	183-186
Hand vices	237
Hexagonal head screwdriver sockets	40/49/63
Hexagonal head wrench sets	195/197-202
Hexagonal head wrenches	194/195-202
High pressure grease guns	246
Hole cutting snips	234
Hook wrenches	28
Hooks for display stands	167-169
I	
Ignition wrench sets	15
IMPACT-Converters	100
IMPACT Driver sets	86
IMPACT Drivers	86
IMPACT Extension bars	99
IMPACT Screwdriver sockets	92/93/97/98
IMPACT Socket sets	98
IMPACT Sockets	91-98
IMPACT Screwdriver socket sets	94
IMPACT Tool set	101
IMPACT-Universal joints	99
Insert tools for torque wrenches	106-108
Insulating tapes	251
J	
Jointing chisel	229
K	
Kneeling mat	159
Knives	238-240
L	
Lambda sensor-special tool	255
LED Lights	243
Levers	234
Long flat nose pliers	176
M	
Magnetic bitholder	86/218
Magnetic pick-up tools	213
Magnetic shell	253
Maxline combination wrench set	22
Maxline combination wrenches	22-23
Measuring tapes	249
Mechanics' stethoscopes	251
Mini grip plier	190
Mirrors	213
Mobile grip-system	188-189
Modules	148-158
Modules in workshop trolley Formel Plus	147-158

Alphabetical Index

Article	
Multifunction funnel	253
Multigrip pliers	172
Multi-Spline screwdriver sockets	63

N

Nut spinners	121
Nut spinners, flexible	121
Nylon hammers	227

O

Offset handle	58
Offset screwdrivers	212
Oil cans	245/246
Oil filter wrenches	191

P

Padlocks	124
Parallel pin punch sets	231
Parallel pin punches	231/232
Pedestal panel for perforated tool bar	165/166
Perforated tool bars	161-164
PHILLIPS-Screwdriver sockets	41/50/63
PHILLIPS-Screwdrivers	202/203/216
Pick-up tools	213
Pipe wrenches	191
Piston ring compressors	242
Piston ring spreaders	242
Plastic scraper	225
Plastic hammers	257
Pliers	172-182
POZIDRIV®-Screwdriver sockets	41/50/63
POZIDRIV®-Screwdrivers	203/216
Precision steel rules	248
Precision vernier calipers	247
Presentation systems	160-161
Price tags	168
Pry bar	224/225
Pullers	257-259
Push-Thru ratchets	38/46/58

R

Ratchets	38/46/58/82/85
Retaining pins for IMPACT-Sockets	100
Retaining ring pliers	182
Retaining rings	100
Reversible ratchet head	106
Reversible ratchet unit	58
Reversible ratchets	38/46/58/82/85
Reversible screwdrivers	211
RIBE CV-Screwdriver sockets	63
Rim wrenches	114
Ring wrench sets	24/26
Ring wrenches	23-26
Riveters	184/185/186/233
Round nose pliers	173
Rubber mallets	227
Rules	248

S

Sales display	164/165
Sales display for reversible ratchets Talenta	81/165
Sales display for reversible ratchets Varicat	81/164

Article	
Scraper	225/237-239
Screw extractor sets	213
Screwdriver sets	206-208/215/219-221
Screwdriver sockets	40/41/49/50/62/63/94
Screwdrivers	202-208/212/215-221
Screwdrivers display stands	215
Scribers	250
Sets with screwdriver sockets	41/50/64
Single ended open jaw wrenches	12/13
Single ended ring wrenches	29/31-33
Sliding T-handle	38/46/58/82/85
Slogging open jaw wrenches	29/30
Slogging ring wrenches	31/32
Snipe nose pliers	174/177
Snips	234
Socket dispensers	52/68/69
Socket dispensers, empty	68
Socket sets	43/44/45/53-57/72-80/84/85
Socket wrenches	114
Sockets	39/40/47-49/59-62/83/85/89
Sockets on aluminium socket rail	42/51/65
Spacing modules	146
Spare heads for hammers	227/257
Spare nylon heads	227
Spare straps for strap wrenches	191
Spark plug brushes	245
Spark plug sockets	48
Speed braces	46/58
Spinner handle	38
Square coupler	38/46/58/82
Square scrapers	237/238
Stainless steel wire brush	245
Starter and manifold wrenches	23
Steel rules	248
Stethoscopes	250
Stone chisel	229/230
Strap wrenches	190
Stubby screwdrivers	206/218
Stud setters and extractors	261
Suction lifters	256
Swivel handle	38/46/58/82
Swivel universal joints	90
Swivel wrench sets	27
Swivel wrenches	27

Talenta reversible ratchet	58
Taper pin punches	232
Telescopic inspection mirrors	213
Thread restorers	240
Tinmens' snips	234
Tommy bars	121
Tongs for axle collars and hose clamps	180
Tool boxes	124
Tool chests, empty	125
Tool set Expert „75 Years Edition“	70-72
Tool set for brake fluid extraction	118
Tool sets	122/123/126-138
Tool sets in modules	148-155
Tool set in workshop trolley	147
Torchlights	243
Torque angle applicators	111
Torque multiplier	111
Torque wrench sets	109

T

Torque wrenches	102/103/104/109
Torque wrenches VARITORQUE	104
TORX®-Ball head wrench sets, "L"-shaped	202
TORX®-Screwdriver sets	207/219
TORX®-Screwdriver sockets	41/50/63/93
TORX®-Screwdrivers	204/217
TORX®-Sockets	40/49/62
TORX®-Wrench sets, "L"-shaped	200-202
TORX®-Wrenches, "L"-shaped	200/201
Triangular bearing scrapers	237
Triangular hollow scrapers	238
Tube cutters	236
Tubular handles	33
Tubular socket wrenches	120
Tubular socket wrenches sets	120
Tyre change presser	225
Tyre levers	224
Tyre pressure gauges	250
Tyre profile caliper	248

Article	
Universal ball joint separators	261
Universal extensions	89
Universal grip pliers	186-190
Universal joints	38/46/58/82/99
Universal sockets	88/89
Universal twin leg pullers	257/258

U

Universal ball joint separators	261
Universal extensions	89
Universal grip pliers	186-190
Universal joints	38/46/58/82/99
Universal sockets	88/89
Universal twin leg pullers	257/258

V

VARICAT reversible ratchets	38/46/58
VARITORQUE Torque wrenches	104
VDE Electricians tool sets	178/209
VDE Electricians backpack	179/209
V-Belt and cam belt wrench	255/256
VDE Screwdrivers	208/221
VDE Screwdriver-sets	208/221
VDE Voltage testers	211
VDE Pliers	176-179
Vernier calipers	247
Vices	237
Voltage testers	210

W

Wall cabinets	126
Wall cabinets, empty	125
Warding files	242
Welding grip pliers	187
Wheel nut wrenches	114
Wire brushes	245
Wire stripping pliers	175/178
Wire swivelling plier	183
Wobble extension	38/46/58/90
Workshop trolleys	139-144

X

XZN-Screwdriver sockets	63
-------------------------	----

Verkaufs-, Lieferungs- und Zahlungsbedingungen

1. Anerkennung der Verkaufs-, Lieferungs- und Zahlungsbedingungen

Unsere Verkäufe basieren auf den nachstehenden Bedingungen, wobei jeweils nur die neuesten Verkaufsunterlagen Gültigkeit besitzen. Abweichungen oder mündlich getroffene Nebenabsprachen bedürfen unserer schriftlichen Bestätigung.

Bedingungen der Besteller können wir nicht anerkennen, auch dann nicht, wenn von uns nicht ausdrücklich widersprochen wird. Der Besteller erkennt durch die Erteilung seines Auftrages unsere Bedingungen an.

Vertragsgültigkeit wird erst durch unsere schriftliche Auftragsbestätigung erreicht.

2. Angebote

Unsere Angebote sind freibleibend, Katalog und Preisliste sind Bestandteil unserer Angebote.

Maß- und Gewichtsangaben sowie Abbildungen, Leistungsbeschreibungen, technische Zeichnungen und Daten sind unverbindlich, sofern sie nicht ausdrücklich als verbindlich bestätigt werden; sie können jederzeit und ohne besondere Anzeige geändert werden.

3. Schutzrechte

Werkseigene Zeichnungen, Abbildungen, Photos und sonstige Unterlagen bleiben auch nach Weitergabe an den Besteller oder an Dritte unser Eigentum und unterliegen dem Urheberrecht. Ohne unsere Erlaubnis dürfen diese weder vervielfältigt noch anderen zugänglich gemacht werden; sie sind an einem sicheren Ort aufzubewahren und auf Verlangen an uns zurückzugeben.

Werden bei der Anfertigung von Waren nach Zeichnungen, Mustern bzw. sonstigen Angaben des Bestellers Schutzrechte Dritter verletzt, so stellt dieser uns von sämtlichen Ansprüchen frei.

4. Sonderanfertigungen

Bei Sonderanfertigungen behalten wir uns das Recht einer Mehr- bzw. Minderlieferung bis zu 10% vor. Hierzu zählen ebenfalls Serienteile, die auf ausdrücklichen Wunsch des Bestellers besonders zu zeichnen sind. Der Besteller kann nicht vom Auftrag zurücktreten; besonders hergestellte oder gezeichnete Ware wird von uns nicht zurückgenommen.

Im Falle von Zahlungsunfähigkeit bzw. Konkurs des Bestellers behalten wir uns das Recht vor, die Ware direkt zu verkaufen.

Bei Herstellung nach Unterlagen des Bestellers haftet dieser für die Richtigkeit seiner Zeichnungen, Muster, Lehren usw.

Muster werden grundsätzlich nur gegen Berechnung geliefert.

5. Preise

Unsere Preise sind freibleibend und als unverbindliche Preisempfehlung anzusehen. Sie verstehen sich ausschließlich Mehrwertsteuer, wobei der am Tage der Lieferung gültige Mehrwertsteuersatz Anwendung findet.

Eine Berichtigung unserer Preise behalten wir uns vor, sofern bis zum Tage der Lieferung Änderungen in den Grundkosten, wie Rohmaterial, Energie, Löhne usw. eintreten.

Lieferungen erfolgen grundsätzlich in den im Katalog genannten Verpackungseinheiten. Kleinere oder durch die Verpackungseinheiten nicht teilbare Mengen werden lose in Papier verpackt und mit einem Aufschlag von 25% belastet, sofern in unseren Verkaufsunterlagen kein anderweitiger Vermerk gemacht wird.

6. Zahlungsbedingungen

Unsere Rechnungen sind zahlbar

Inland:

10 Tage nach Rechnungsdatum, abzüglich 2% Skonto oder 30 Tage nach Rechnungsdatum netto, falls keine anderen Vereinbarungen getroffen wurden.

Ausland:

Nach besonderen Vereinbarungen; maßgebend ist der Zahlungsvermerk auf dem jeweiligen Angebot, der Proforma-Rechnung bzw. der Rechnung.

Beträge unter EUR 25,- netto sind grundsätzlich nicht skontoberechtigt.

Wechsel werden nur nach vorheriger Vereinbarung hereingenommen. Die Kosten der Diskontierung und Einziehung trägt grundsätzlich der Besteller.

Bei Zahlungsverzug oder Stundung belasten wir Zinsen in Höhe von 2% über dem zu diesem Zeitpunkt gültigen Diskontsatz der Deutschen Bundesbank.

Die Wertstellung eingegangener Schecks und Wechsel erfolgt zu dem Tag, an dem wir über den Gegenwert verfügen können.

Sollten uns nach Vertragsabschluss Umstände bekannt werden, welche die Kreditwürdigkeit des Kunden beeinträchtigen, sind wir berechtigt, Vorauszahlung oder andere Sicherheitsleistungen zu verlangen.

Eine Zurückhaltung der Zahlung wegen Minderungs-, Wandlungs- oder eventueller anderer Gegenansprüche sowie die Aufrechnung mit solchen, ist nicht zulässig.

7. Lieferung und Versand

Wenn nicht anders vereinbart, liefern wir grundsätzlich ab Werk, ausschließlich Verpackung, wobei Lieferung und Versand der Ware auf Gefahr des Bestellers erfolgen. Versicherungen gegen Diebstahl, Transportschäden usw. erfolgen nur auf Wunsch und Kosten des Bestellers. Falls keine besondere Vorschrift gegeben wird, wählen wir den nach unserem Ermessen günstigsten Versandweg.

Waren, die zu einem vereinbarten Termin versandbereit gemeldet werden, müssen umgehend abgerufen werden, da wir andernfalls berechtigt sind, diese auf Kosten und Gefahr des Bestellers zu lagern und als geliefert zu berechnen.

Für Verladungen setzen wir Netto-Mindestauftragswerte wie folgt voraus:

Inland – EUR 100,- Ausland – EUR 500,-

sofern in unseren Verkaufsunterlagen kein anderweitiger Vermerk gemacht wird.

Wir behalten uns vor, Aufträge unter dieser Grenze entweder bis zum Erreichen des Mindestauftragswertes zurückzustellen oder mit einer Bearbeitungsgebühr von EUR 10,- zu belasten.

8. Eigentumsvorbehalt

Die gelieferte Ware bleibt bis zur endgültigen Bezahlung, ohne Rücksicht auf den Rechtsgrund, unser Eigentum. Für den Fall der Bezahlung auf Scheck-Wechselbasis bleibt der Eigentumsvorbehalt bis zur Einlösung des Wechsels durch den Besteller bestehen.

Der Besteller ist, so lange er sich nicht in Verzug oder in Zahlungsschwierigkeiten befindet, zur Veräußerung der Ware im ordnungsgemäßen Geschäftsverkehr berechtigt. Veräußert der Besteller die in unserem Vorbehaltsrecht stehende Ware, werden die durch die Veräußerung entstehenden Forderungen schon jetzt an uns abgetreten, ohne daß es im Falle der Veräußerung einer ausdrücklichen Bestätigung bedarf. Er ist nicht berechtigt, die Vorbehaltswaren zu verpfänden oder zur Sicherheit an Dritte zu übereignen.

Bis zur endgültigen und vollständigen Bezahlung der Ware steht uns das Recht zu, auch ohne Ausübung des Rücktritts und ohne Nachfristsetzung auf Kosten des Bestellers, die einstweilige Herausgabe der Vorbehaltsware zu verlangen, die Räumlichkeiten des Bestellers zu betreten und die Ware nötigenfalls wieder an uns zu nehmen.

Wird eine Be- oder Verarbeitung bzw. untrennbare Vermischung der Vorbehaltsware mit anderen, nicht dem Lieferer gehörenden Gegenständen, vorgenommen, so erwerben wir das Miteigentum an der

neuen Sache im Verhältnis des Rechnungswertes der Vorbehaltswaren zu den anderen verarbeiteten oder vermischten Gegenständen zum Zeitpunkt der Verarbeitung oder Vermischung. Wird die gelieferte Ware vom Besteller oder dessen Beauftragten verändert oder als Teil größerer Einheiten verwendet, so geht unser Eigentum anteilmäßig automatisch auf die veränderte Ware oder die entstandenen größeren Einheiten über. Der Besteller verwahrt das Eigentum oder Miteigentum für den Lieferer und ist verpflichtet, dieses gegen Feuer, Diebstahl und Wasser zu versichern. Etwaige Entschädigungsansprüche, die aus Schäden vorgenannter Art gegen Versicherungsgesellschaften oder sonstige Ersatzverpflichtete entstehen, werden in Höhe unserer Forderungen an uns abgetreten.

Pfändungen oder andere Beeinträchtigungen unseres Eigentums, sind uns unverzüglich mitzuteilen.

Ohne die bisher dargelegten Bedingungen einzuschränken, geht das Risiko für die gelieferte Ware vom Tage der Lieferung auf den Besteller über.

9. Lieferzeit, Liefermöglichkeit

Lieferfristangaben sind annähernd und ohne Verbindlichkeit für uns. Verzugszinsen und Schadensersatzansprüche bei Lieferverzögerungen können gegen uns in keinem Fall geltend gemacht werden. Die Lieferzeit beginnt nach Klärung sämtlicher kaufmännischer und technischer Einzelheiten. Wir sind berechtigt, Teillieferungen durchzuführen.

10. Höhere Gewalt

Streik und Aussperrung, Katastrophen, Betriebsstörungen, Materialmängel, Verkehrsmängel oder andere Ereignisse höherer Gewalt, ganz gleich, ob sie bei uns oder bei unseren Vorlieferanten eintreten, entbinden uns von allen Verpflichtungen.

11. Mangelrügen

Beanstandungen werden nur entgegengenommen, wenn sie schriftlich und umgehend, d. h. sofort nach Erhalt der Sendung, angezeigt werden. Ein Recht auf Wandlung oder Minderung steht dem Besteller nicht zu. Über den Warenwert hinausgehende Ansprüche können nicht gestellt werden. Transportschäden sind stets beim Frachtführer zu reklamieren.

12. Garantie, Gewährleistung

Alle HEYCO-Werkzeuge werden in unseren Werken sorgfältig überprüft und unterliegen voll der Garantie.

Wir ersetzen jedes Werkzeug kostenlos, das Material- oder Fertigungsfehler aufweist. Eine weitere Haftung ist ausgeschlossen. Kostenloser Ersatz erfolgt nicht, wenn die Untersuchung in unserem Werk ergibt, daß das Werkzeug unsachgemäß behandelt worden ist oder ein natürlicher Verschleiß vorliegt.

13. Haftung

Schadenersatzansprüche aus Fehlen zugesicherter Eigenschaften, Verzug, Unmöglichkeit der Leistung, schuldhafter Verletzung vertraglicher Nebenpflichten sowie aus Verschulden bei Vertragsabschluß und aus unerlaubter Handlung, werden ausgeschlossen, es sei denn, sie beruhen auf Vorsatz oder grober Fahrlässigkeit unserer gesetzlichen oder sonstigen uns zuzurechnenden Vertreter.

Die Haftung wird auch für grob fahrlässige Verletzungen auf den Ersatz des zum Zeitpunkt des Vertragsabschlusses voraussehbaren Schadens begrenzt.

14. Erfüllungsort und Gerichtsstand

Erfüllungsort der Lieferung und Zahlung ist Remscheid. Gerichtsstand ist Remscheid. Es gilt das Recht der Bundesrepublik Deutschland.

15. Export und Re-Export

HEYCO-Ware darf nur mit unserer schriftlichen Genehmigung exportiert oder re-exportiert werden.

Terms of Sale, Delivery and Payment

1. Acceptance of terms of sale, delivery and payment

Our sales are based on the following terms and conditions whereby only the latest issue of our sales literature is valid. Any variations to these and verbal arrangements require our confirmation in writing. Conditions of the buyer shall not be binding to us, also if not expressly objected by us. The placing of an order/contract with us implies acceptance of our conditions. Validity of contract is only reached with our written order confirmation.

2. Quotations

Our offers are without obligation. Catalogue and price list form part of our offers. Weights and dimensions, illustrations, performance details, technical drawings and data are subject to change without prior notice, unless contracted and confirmed otherwise.

3. Copyright

All drawings, illustrations, photographs and other documents supplied by us to customers or third parties remain our property and are subject to copyright. They are not to be reproduced or made available to others without our written consent; they are to be stored in a safe place and must be returned to us on demand. Should production of merchandise to drawings, samples or other customer's specification involve an infringement of third party copyrights the customer indemnifies us from and against all claims.

4. Special manufacture

We reserve the right to modify the quantities ordered for special production by plus or minus 10%, also normal production items, which are marked or finished to buyer's special requirements. Such orders cannot be cancelled once accepted by us. We are unable to accept the return of such items for credit or allowance. If the customer becomes insolvent or bankrupt we reserve the right to sell this merchandise directly. For production to customers documents the customer shall be solely responsible for the accuracy of drawings, samples, gauges etc. On principle samples are only supplied against invoice.

5. Prices

We reserve the right to adjust prices in case there should be changes in basic production costs, such as raw material, power, wages etc. up to the date of delivery. Parts ordered will only be shipped in packing units identified in our sales literature. Smaller quantities or quantities, which are not divisible by packing units will be packed in paper only and levied with an increase of 25% provided no other information has been given in our sales literature.

6. Terms of payment

Our invoices are payable

Home market:

10 days after date of invoice less 2% cash discount or 30 days after date of invoice net, provided no other arrangements have been agreed.

Export markets:

According to special arrangements, which are stated on our quotations, pro-forma-invoices, order confirmations and/or invoices.

On principle invoice values below Eur 25.- net do not qualify for cash discount. Drafts will only be accepted after prior arrangements and all charges are to buyer's account.

In the event of delayed payments or respites we shall charge interests at a rate of 2% above the bank rate of the Deutsche Bundesbank being in force at the relevant time.

The credit values of cheques and drafts received are entered for that day, when countervalue is at our disposal.

In case we should learn about circumstances restricting the creditworthiness of the customer after a contract has been concluded, we are permitted to ask for payment in advance or other satisfactory securities. Retention of payment due to claims of diminution, transformation or other eventual counter-claims as well as settling of accounts incorporating the above is not permissible.

7. Dispatch and delivery

Unless arranged and confirmed to the contrary delivery is effected ex works, packing excluded. Goods are delivered at buyer's risk. Insurance against theft, damages in transit etc. can be arranged on specific request and to customer's account. We reserve the right to choose the most economic method of transport unless particular instructions are given. Goods, which have been packed to be ready for dispatch for an agreed date must be called off immediately, as otherwise we are entitled to store same at buyer's risk and cost and to invoice shipment as delivered.

For shipments our minimum net order values are

Home market: Eur 100.- Export markets: Eur 500.-

unless no other terms are quoted in our sales literature. For orders with smaller values we reserve the right to postpone shipment until minimum order value is reached or to charge a handling fee amounting to Eur 10.-

8. Title to the goods

Goods delivered remain our property until payment is received in full. It is expressly reserved that any law contradicting this clause shall not impair our rights concerning our goods.

The buyer may dispose of the goods in the usual businesslike manner provided he is not insolvent or in default.

Should the customer sell goods, which are still our property respective credit is due to our account automatically without express confirmation. The buyer is not entitled to distrain or, as security to third parties, assign goods which are still our property.

Until paid for in full we are entitled to demand the release of goods and to enter buyer's premises with the object of re-taking possession of the goods. We are not obliged to execute withdrawal and to award postponement at customer's costs.

In case processing, further treatment or inseparable blending of provisogoods is effected with other merchandise or parts not belonging to us, we automatically gain partial ownership on the processed goods to such value as it is in relation to the processed or blended merchandise at the moment of processing or blending. Should supplied goods through buyer or on behalf of buyer be subjected to alterations or be used as part of larger units, then automatically partial ownership is transferred to the changed merchandise or the produced larger units. The buyer storing seller's property or partial property is obliged to secure same against fire, theft and water. Eventual claims for damages against insurance companies resulting from damages mentioned before are to be assigned to us representing the amount of our claim.

Distraints and/or any other limitation, which might be imposed on our property despite the reservations outlined in the proceeding sentences must be reported immediately.

Notwithstanding the conditions outlined above, goods are at the entire risk of the buyer from the date of delivery.

9. Time of delivery and delays

All information given in respect of delivery period is approximate and without obligation. Liability in case of delay in delivery, interest for delay and/or damages cannot be accepted. The time of delivery begins only after clarification of all clerical and technical details. We are permitted to effect part shipments.

10. Force majeure

Force majeure, such as strike and lock-out, catastrophes of any kind, break-down in supply of any kind, delivery of faulty material or other restrictions through force majeure shall release us from our liabilities, no matter if occurred with us or our sub-suppliers.

11. Claims

Claims must be made immediately on receipt of the goods and in writing, as otherwise such claims will not be accepted by us. Amendments to or deductions from invoices will not be accepted. The customer is not entitled to make claims above the nominal value of the goods involved. Damages in transit are to be claimed with the carrier.

12. Guarantee, warranty

All HEYCO tools are carefully tested before leaving our works and are fully guaranteed. We shall replace free of charge any tool indicating faults of material and workmanship. Any further liability is excluded. Tools returned as faulty, which on inspection/ test prove to have failed due to abuse, incorrect use or fair wear and tear are excluded from this guarantee and replacement will be charged.

13. Liability

Claims for compensation due to missing of promised features, delays, impossibility of performance, guilty violation of contractual secondary obligations, faults with conclusion of contract as well as unauthorized action are excluded save where our legal representatives are shown to have acted on purpose or negligently.

Liability even for careless violation is limited to compensation, which is foreseeable at the moment of conclusion of contract.

14. Settling place and place of competency

Remscheid is the settling place for delivery, payment and competency of justice in case of dispute. Only the law of the Federal Republic of Germany shall govern.

15. Export and re-export

Only with our written approval HEYCO goods may be exported or re-exported.

Conditions de vente, de livraison et de paiement

1. Commandes

L'acceptation de nos offres entraîne l'acceptation, sans exception ni réserve, des présentes conditions qui régiront toutes nos ventes et prévaudront nonobstant toutes stipulations contraires pouvant figurer sur les bons de commandes de l'acheteur, ses conditions générales d'achat ou tout autre document émanant de lui. Tous les ordres, même ceux pris par nos agents commerciaux ou nos importateurs étrangers, ne nous engageant qu'après acceptation écrite de notre part. Les caractéristiques et cotes portées sur nos catalogues figurent à titre indicatif.

Elles ne nous engagent en aucun cas. Toutefois, l'acheteur conserve la possibilité de spécifier les caractéristiques auxquelles il subordonne sa commande. Les études et documents de toute nature que nous remettons à nos clients restent notre propriété et doivent nous être rendus sur demande quand bien même il aurait été facturé une participation aux frais d'étude. Ils ne peuvent en aucun cas être communiqués ou exécutés sans notre accord formel écrit.

2. Offres

Nos offres sont stipulées sans engagement de notre part.

Notre catalogue et notre tarif font partie intégrante de ces offres. Les indications de dimensions et de poids, ainsi que les illustrations, détails de performance, dessins techniques et caractéristiques ne sont pas contractuels, sauf en cas de confirmation formelle et peuvent être modifiés à tout moment sans préavis.

3. Droit de propriété

Les dessins techniques, illustrations, représentations photographiques et autres documents remis à nos clients ou à des tiers, restent notre propriété et sont soumis au droit de propriété. Ces documents ne doivent pas être reproduits ou mis à la disposition d'autres personnes sans notre autorisation expresse; ils sont à conserver en sécurité et à nous retourner sur demande de notre part.

Si la fabrication des marchandises, d'après les dessins techniques, échantillons ou spécifications de l'acheteur, implique une cession des droits de propriété à des tiers, l'acheteur nous libère de toutes revendications.

4. Fabrications spéciales

Pour les articles faisant l'objet d'une fabrication spéciale, nous nous réservons le droit d'augmenter ou de diminuer l'importance de la livraison à concurrence de 10%. Cela s'applique également aux articles fabriqués en série mais avec marquage spécial, conforme à la demande de l'acheteur. Le client n'a pas le droit de résilier le contrat; la marchandise faisant l'objet d'une fabrication spéciale ou d'un marquage spécial ne sera pas reprise.

En cas d'insolvabilité de l'acheteur ou de faillite, nous nous réservons le droit de revendre directement la marchandise. Dans le cas d'une fabrication d'après la documentation de l'acheteur, celui-ci est responsable de l'exactitude de ses dessins, échantillons, jauges de contrôle, etc.

Les échantillons ne sont livrés que contre paiement.

5. Prix

Nos prix sont indiqués hors taxe et sont sans engagement de notre part. Nos prix sont réputés fermes pour une durée de validité précisée sur nos devis ou nos tarifs.

Cependant, nous nous réservons le droit de modifier nos prix en cas de changement dans la structure des coûts de production, des coûts des matières premières, de l'énergie, des salaires, etc. et ceci jusqu'à la date de livraison.

En principe, nos livraisons sont effectuées selon les unités d'emballage indiquées dans notre catalogue. Les commandes de quantités inférieures ne bénéficieront pas de l'emballage prévu d'origine (telle que boîtes carton, pochettes, étuis...) et seront majorées de 25%, sauf indication contraire dans notre documentation.

6. Conditions de paiement

Toutes nos ventes sont considérées comme traitées et payables à REMSCHEID, l'acceptation de traites ne

dérage pas à cette clause, quels que soient le mode de paiement et le lieu de livraison. Nos factures sont payables:

Marché intérieur:

10 jours date de facture moins 2% d'escompte ou 30 jours nets date de facture, à moins que des conditions particulières ne soient accordées.

Marché étranger:

suivant conditions particulières qui sont indiquées dans nos offres, factures proforma, confirmations de commandes et factures.

Si le montant de la facture est inférieur à 25 EUR, aucun escompte ne sera accordé. En cas de paiement par traite, les frais d'escompte ou d'encaissement seront à la charge de l'acheteur.

Le non-paiement d'une facture à son échéance entraîne le paiement de pénalités au taux mensuel excédant le taux d'escompte actuel de la Deutsche Bundesbank de 2%, calculé au prorata du nombre de jours de retard. Cette pénalité étant convenue formelle entre les parties ne nécessitera aucune mise en demeure préalable. Le nonpaiement d'une échéance quelconque entraînera d'autre part automatiquement l'exigibilité de la totalité du solde restant dû et la suspension des livraisons. Nous nous réservons le droit d'exiger le paiement comptant avant la livraison si la situation financière de l'acheteur le justifie.

En cas de litige, tant avec nos fournisseurs qu'avec nos clients, attribution de compétence est faite aux Tribunaux de REMSCHEID, suivant la législation s'appliquant en Allemagne.

7. Livraison et expéditions

Nos prix s'entendent départ usine, emballage non compris, sauf stipulation écrite spéciale. La facturation du coût de transport est à la charge de l'acheteur et dépend de la nature du matériel et du lieu de livraison. Les marchandises voyagent aux risques et périls du destinataire. En cas d'avaries survenues au cours du transport, il incombe au destinataire d'exercer tous recours contre le transporteur.

En cas de retraiton, si l'acheteur n'enlève pas le matériel à la date de livraison, nous pourrions, aux frais, risques et périls exclusifs de l'acheteur, pourvoir au déplacement, au stockage et à l'assurance du matériel dans nos locaux ou en tout autre lieu, l'acheteur restant intégralement tenu de l'ensemble de ses obligations.

Sauf stipulation contraire, les expéditions sont effectuées si la valeur nette de la commande est au moins de:

- marché intérieur: 100 EUR

- marché étranger: 500 EUR

Nous nous réservons le droit d'ajourner la livraison des commandes jusqu'à ce que cette valeur minimum soit atteinte ou de facturer des frais de rémunération d'un montant de 10 EUR.

8. Clause de réserve de propriété

Conformément à la loi no 80-335 du 12 mai 1980 et à la loi du 25 janvier 1985, nous nous réservons l'entière propriété du matériel livré jusqu'au complet paiement du prix facturé. Nous pourrions en exiger la restitution immédiate en cas de défaut de paiement.

L'acheteur s'oblige personnellement à l'égard du vendeur à ne pas disposer par quelque moyen que ce soit, ni en pleine propriété, ni par constitution de gages, des marchandises achetées avant le paiement intégral du prix. En cas d'opposition de l'acheteur à la restitution des marchandises impayées, une simple ordonnance de référé vaudra résolution de la vente et autorisation de reprendre les marchandises. Les acomptes versés nous resteront à titre de dommages-intérêts.

Malgré l'application de la présente réserve de propriété, l'acheteur supportera la charge des risques en cas de détérioration des marchandises. Il supportera également les charges de l'assurance.

9. Délais

Les délais de livraison sont donnés à titre indicatif. Les retards ne peuvent donner lieu à des dommages-intérêts.

Nous sommes autorisés à effectuer des livraisons partielles.

Nos délais de livraison commencent après la mise au point de tous les détails d'ordre commercial et/ou technique.

10. Force majeure

Nos obligations contractuelles sont suspendues de plein droit en cas de survenance de toute circonstance indépendante de notre volonté et celle de nos fournisseurs, intervenant après la conclusion du contrat et en empêchant l'exécution dans des conditions normales (grèves, défaut ou difficultés d'approvisionnement en matières premières, retard dans les transports de marchandises, réduction autoritaire des importations...).

11. Réclamations pour défauts

Pour être valable, les réclamations doivent être faites par écrit immédiatement après réception de la marchandise.

L'acheteur n'a pas le droit à une transformation ou à une réduction et ne peut faire valoir aucun droit allant au-delà de la valeur de la marchandise. Les avaries de transport doivent toujours être exprimées et réclamées aux transporteurs.

Les réclamations concernant la qualité de la marchandise, à l'exclusion de tout litige de transport, devront être faites immédiatement lors de la livraison ou de la retraiton en notre usine lorsqu'il s'agit d'un défaut apparent et dans les 48 heures concernant ladite livraison ou la retraiton, lorsqu'il s'agit d'un défaut non apparent au premier abord.

12. Garantie

Tous les outils HEYCO font l'objet d'un contrôle minutieux en notre usine et bénéficient d'une pleine garantie. Nous remplaçons gratuitement chaque outil qui présenterait un défaut de matière ou un vice de fabrication. La garantie comprend l'échange de la pièce mais ne s'applique pas aux remplacements ou réparations qui résulteraient de l'usure normale du matériel, de détériorations ou d'accidents provenant de négligences, de défaut de surveillance ou d'entretien, d'installation défectueuse ou de tout autre motif échappant à notre contrôle. La garantie HEYCO ne peut être appliquée si le matériel fourni à été modifié ou réparé sans notre accord. Nous n'acceptons aucun retour de matériel sans accord préalable de notre part. En cas de retour à notre entrepôt, les frais de transport et d'emballage sont à notre charge. La non-conformité des marchandises devra être constatée à la livraison ou à la réception. Nous nous engageons à procéder à l'échange, au remplacement ou à la modification de la marchandise non conforme dans les plus brefs délais; l'acheteur renonce à tous recours contre le vendeur pour les dommages qu'il supporte du fait de la non-conformité. En tout état de cause, notre garantie contractuelle ne se substitue pas à la garantie légale qui nous oblige à garantir l'acheteur contre tous les défauts et vices cachés de la chose vendue. Cependant, la garantie contractuelle n'implique en aucun la possibilité d'une demande de dommages-intérêts ou d'indemnités. Nous ne sommes pas responsables en cas de destination particulière du matériel ou sujétion non déclarée par l'acheteur dans le bon de commande.

13. Responsabilité

Les demandes d'indemnisation par suite d'un manque de précision des caractéristiques, retard, impossibilité de performance, lésion fautive par obligations contractuelles marginales, ainsi que toutes fautes consécutives à la conclusion du contrat ou les actions d'utilisation non autorisées, sont exclues, à moins qu'il ne s'agisse d'une grave négligence intentionnelle de la part de nos mandataires légaux.

14. Exportation et réexportations

La marchandise HEYCO ne peut être exportée ou réexportée que sur notre autorisation expresse.

15. Litiges

En cas de différends portant sur l'interprétation ou l'exécution du contrat de vente, la législation allemande s'applique et les Tribunaux de REMSCHEID sont seuls compétents, même en cas d'appel en garantie, de pluralité de défendeurs et nonobstant toute clause contraire.

Condiciones de venta, entrega y pago

1º – Aceptación de las condiciones de venta, entrega y pago

Nuestras ventas se basan en las condiciones que se detallan a continuación, teniendo validez solamente la documentación de venta más reciente. Cualquier modificación o acuerdos verbales, requieren nuestra confirmación por escrito.

No podemos aceptar condiciones puestas por nuestros clientes, ni siquiera en el caso de que nosotros no manifestemos de manera expresa nuestro rechazo de las mismas. El cliente, por el mero hecho de pasar el pedido, acepta nuestras condiciones. El contrato de venta adquiere su validez mediante nuestra confirmación de pedido por escrito.

2º – Ofertas

Nuestras ofertas se entienden salvo modificación posterior. Catálogo y tarifa de precio forman parte de nuestra oferta. Indicaciones de medidas y peso, reproducciones, descripciones de prestaciones, planos técnicos y demás datos se entienden como no vinculantes, salvo indicación expresa de nuestra parte que confirme lo contrario. Dichas especificaciones podrán ser modificadas en cualquier momento y sin previo aviso.

3º – Propiedad industrial

Planos, reproducciones, fotos y demás documentos seguirán siendo propiedad nuestra, incluso una vez remitidos a clientes o terceros y están sujetos a los derechos de autor. Dichos documentos no podrán ser copiados o facilitados a terceros sin nuestra autorización expresa. El receptor debe comprometerse a guardarlos en sitio seguro y devolvérselos a requerimiento nuestro.

Caso de que al fabricar artículos en base a planos, muestras u otras especificaciones facilitados por el cliente se lesionen derechos de propiedad industrial de terceros, la responsabilidad será exclusivamente del cliente.

4º – Fabricaciones especiales

En el caso de fabricaciones especiales, nos reservamos el derecho de desviarnos de la cantidad pedida en un más/menos 10%. Esto se aplica también a piezas de fabricación normal que lleven un marcado especial por encargo expreso del cliente.

En este caso no se admitirá ninguna cancelación del pedido. Tampoco se aceptará devolución alguna de mercancía especial o con marca del cliente.

Caso de producirse la suspensión de pagos o la quiebra del cliente, nos reservamos el derecho de vender tal mercancía directamente.

En el caso de una fabricación basada en documentos facilitados por el cliente, será éste el que se responsabilice de la exactitud de planos, muestras, calibres, etc.

Muestras se facilitarán siempre con cargo.

5º – Precios

Nos reservamos el derecho de modificar nuestros precios si hasta la fecha de expedición de la mercancía se hubieran producido cambios de nuestros costos, como p.e. de la materia prima, energía, salarios, etc.

El suministro se efectuará siempre en base a las unidades de envase indicadas en catálogo. Cantidades inferiores o no coincidentes con las unidades de envase se enviarán sueltas, simplemente envueltas en papel, y se cargarán con un aumento de precio del 25 %, salvo indicación contraria constatada en nuestra oferta.

6º – Condiciones de pago

Nuestras facturas son pagaderas:

En el mercado interior:

10 días fecha factura con el 2% de descuento por pronto pago o 30 días fecha factura, neto, salvo convenio específico de condiciones diferentes.

En exportación:

Según convenio específico. Será vinculante la condición de pago indicada en nuestra oferta, factura proforma o factura.

En el caso de facturas por un valor inferior a EUR 25,-, no se admite descuento por pronto pago.

El pago contra letra de cambio se admitirá sólo previo acuerdo. Los gastos de descuento y presentación al cobro serán por cuenta del cliente.

En el caso de producirse retrasos en el pago o un aplazamiento del mismo, cargaremos un tipo de interés equivalente al tipo de descuento fijado por el Deutsche Bundesbank (Banco Federal alemán) + un 2% adicional.

Talones y letras se valorarán a la fecha en que nosotros podamos disponer de su contravalor.

Si no llegase información que pusiera en duda el crédito de un determinado cliente, nos reservamos el derecho de exigir el pago por adelantado u otras garantías, incluso una vez perfeccionado el contrato de venta.

No se admitirá demora en el pago debido a reclamaciones exigiendo minoración, cancelación u otras compensaciones, ni descuentos por tales conceptos.

7º – Entrega y envío

Salvo acuerdo en sentido diferente, nuestras condiciones de entrega son siempre ex fábrica, excluido el embalaje, siendo la entrega y el envío de la mercancía por cuenta y riesgo del cliente. Seguros contra hurto, daños en el transporte, etc. se contratarán sólo previo encargo expreso del cliente y por cuenta del mismo. De no recibir instrucciones concretas, nosotros elegiremos el modo de transporte más conveniente.

Mercancía que esté disponible en la fecha de entrega convenida, ha de ser aceptada de inmediato. En caso contrario, la mercancía será almacenada por cuenta y riesgo del cliente y facturada en la fecha de entrega convenida.

Los importes netos mínimos por envío, salvo indicación contraria en nuestra oferta, son:
Mercado interior EUR 100,-
Exportación EUR 500,-

Nos reservamos el derecho de retener pedidos de valor inferior hasta acumular el importe mínimo o expedirlos con un recargo de EUR 10,-.

8º – Reserva de propiedad

La mercancía seguirá siendo de nuestra propiedad hasta su total pago, independientemente de la causa legal del impago.

Mientras no se haya producido una demora del pago o un impago, el cliente tiene el derecho de revender la mercancía por procedimientos comerciales normales. Si la reventa se produce de mercancía sobre la que aún pesa la servidumbre de reserva de propiedad, el cliente cede automáticamente los derechos de cobro a nosotros, sin que para ello se requiera un convenio expreso.

El cliente no está autorizado a ceder tales derechos de cobro a terceros u ofrecerlos como garantía. Hasta el total y definitivo pago de la mercancía, nosotros tenemos el derecho de exigir la devolución de la misma, acceder a las instalaciones del cliente y llevarnos la mercancía, sin siquiera ejercer el derecho de cancelación del contrato de venta o de concesión de un plazo adicional.

En el caso de que la mercancía suministrada por nosotros haya sido objeto de una transformación o elaboración o incluso de una incorporación inseparable en otro objeto de la propiedad del cliente, entonces nosotros nos convertimos en copropietarios de tal objeto, en la proporción del valor en factura de la mercancía en reserva de propiedad con los demás objetos transformados o incorporados en la fecha de su transformación o incorporación.

Si la mercancía suministrada se transforma o se utiliza por el cliente o por encargo del mismo, como parte de una unidad mayor, nuestra propiedad

pasará a ser parte de la mercancía transformada o de la unidad mayor en la proporción correspondiente. El cliente custodiará la propiedad o copropiedad del suministrador y se compromete a asegurarla contra incendio, hurto y daños por agua. Cualquier tipo de indemnización resultante de un siniestro de este tipo será transferido a nosotros a cuenta de nuestros cobros pendientes.

Embargos o cualquier otro tipo de acciones que afecten a nuestra propiedad, han de sernos notificados de inmediato.

Sin que ello limite las condiciones detalladas arriba, el cliente correrá con el riesgo de la mercancía entregada a partir de la fecha de su expedición.

9º – Plazo de entrega, disponibilidad

Indicaciones de plazo de entrega son aproximadas y no vinculantes para nosotros. No se podrán reclamar gastos por demora o daños y perjuicios por retrasos en la entrega. El plazo de entrega empieza a contar a partir de la fecha en la que hayan quedado definitivamente concertados todos los detalles comerciales y técnicos.

Tenemos el derecho de efectuar entregas parciales.

10º – Fuerza mayor

Huelgas, cierres patronales, catástrofes naturales, interrupciones de la producción, falta de material o de medios de transporte u otros eventos de fuerza mayor, independientemente de si se producen en nuestra empresa o en nuestros suministradores, nos liberan de toda obligación.

11º – Reclamaciones por defectos

Reclamaciones por defectos se aceptarán solamente por escrito y si se presentan de inmediato, es decir, a la recepción de la mercancía. El cliente no tiene derecho a anular el pedido ni de disminuir el importe de la factura.

Reclamaciones que sobrepasen el valor de la mercancía, no serán admitidas. Daños producidos durante el transporte han de reclamarse al transportista.

12º – Garantías

Todos los fabricados de HEYCO se someten a exhaustivos controles de calidad y por consiguiente están plenamente garantizados.

Toda herramienta que tenga un defecto de material y/o de fabricación, será repuesta sin cargo. Queda excluida cualquier garantía que sobrepase este límite. No se procederá a la reposición gratuita si se comprueba que la herramienta ha sido usada indebidamente o si se trata de un desgaste normal.

13º – Daños y perjuicios

Se excluyen expresamente indemnizaciones por daños y perjuicios derivados de la falta de propiedades prometidas, demoras, imposibilidad de cumplimiento, lesión culpable de obligaciones marginales del contrato, culpabilidad al cerrar el contrato o actos ilegales, salvo en el caso de que quede demostrado que se haya actuado con premeditación o con grave negligencia por parte de nuestros representantes legales o demás representantes. También en el caso de graves negligencias, la indemnización se limita al daño previsible en la fecha de producirse el contrato de venta.

14º – Lugar de cumplimiento y competencia judicial

El lugar de cumplimiento para entrega y pago es Remscheid. El juzgado competente es el de Remscheid.

Se aplica la legislación de la República Federal de Alemania.

15º – Exportación y re-exportación

Mercancía procedente de HEYCO no podrá ser exportada o re-exportada sin nuestra previa autorización por escrito.



HEYCO
Qualitätswerkzeuge
GmbH & Co. KG
Birgden III/1
42855 Remscheid
Germany

Telefon +49 (0) 2191 205-0
Telefax +49 (0) 2191 205-266
E-Mail info@heyco.de
www.heyco-tools.de



Ваш поставщик:
ООО "КОМПАНИЯ
ОПТУЛС"
Москва, ул.Иловайская, д.3
Тел.: +7 (495) 646-00-96
sale@opttools.ru
www.opttools.ru