



**Tools for Telecom, Fiber Optics  
CATV, Satellite, Security & Alarm,  
Wireless and Electronics Industries**

Catalogue No. 114





## WE ARE JONARD TOOLS



jonard.com

Just scan the link to see the new more user friendly Jonard Website. Notice our new name – JONARD TOOLS. This isn't simply a cosmetic change, this is a dramatic metamorphosis of our business and how user friendly our new website is to use. Find what you're looking for with our new and improved search options. Get greater details including tool specifications, helpful videos, enhanced quality photos, complementary products and more. And best of all you still get the GREAT QUALITY you've grown to expect from Jonard. Find out for yourself why our tools are MADE FOR LIFE®.

**WHAT'S NEW?** Since 2007 Jonard Industries has introduced well over 250 new tools. Follow us on Facebook, Twitter and sign up for our newsletter for exciting events and new product announcements.

**BLOG THIS!** Yes, Jonard Tools now has a blog with interesting and entertaining news, happenings and other pertinent information. Just go to our website and click the blog icon for the latest blog as well as our previous postings.

### WARRANTY

Lifetime warranty – see details on our website [www.jonard.com](http://www.jonard.com)

### CUSTOMER SERVICE

Our distribution network is present in all 50 states and over 100 countries. Check the "Where to Buy" section of our website to locate a dealer near you. Jonard Industries maintains stock in depth, provides technical support and we will meet your individual service requirements.



JonardTools



[www.facebook.com/JonardTools](http://www.facebook.com/JonardTools)



Jonard Industries

134 Marbledale Road, Tuckahoe, New York 10707 • email: [sales@jonard.com](mailto:sales@jonard.com)  
Phone: (914) 793-0700 • Fax: (914) 793-4527  
Website: [www.jonard.com](http://www.jonard.com)

# TABLE OF CONTENTS

Pliers	4-10
Fiber Optic Tools	11-15
Wrenches	16-19
CATV/Satellite Tools & Kits	16-28
Scissors	29-30
Punchdown Tools	31-32
Screwdrivers	33-34
Insulated Tools	35
Electrical Tools	33-37
Wire Fishing & Sewing	37-39
Wire & Cable Strippers	40-43
Kynar Wire	44
Connector Tools	45
Burnishers	46
Alignment Tools	47-48
Force Gauges	49
Wire Wrapping	50-57
IC Insertion Extraction Tools	58
Fume Absorbers & Desolder Pumps	59

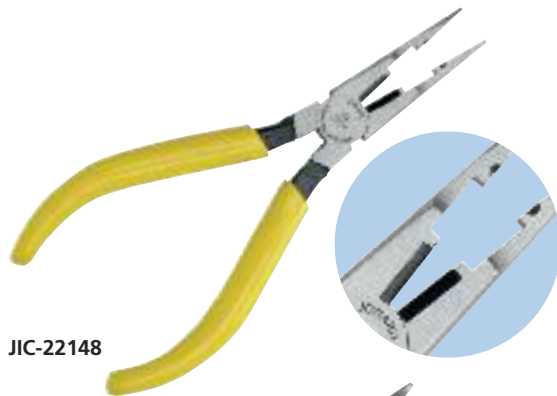

JIC-22148

**COMBO CRIMPER LONG NOSE PLIERS**

Five tools in one, combines crimper for UR/UY/UG, AMP tel splice connectors, 709 series connectors, crimping "B" type connectors and a long nose pliers. With a crusher, cutter, .030" stripping hole, and yellow plastic handle. Made of chrome vanadium steel.

JONARD PART NO.	LENGTH	JAW LENGTH	JAW WIDTH	JAW THICKNESS	CUTTER LENGTH	WEIGHT
JIC-22148	6 7/8"	1 7/8"	13/16"	3/8"	13/32"	5.4 oz



JIC-891

**CONNECTOR-CRIMPING PLIERS WITH SIDE CUTTERS**

Connector-Crimping Pliers with Side Cutters designed to press UG, UR, UY, 709 series connectors, crimping "B" type connectors, and AMP tel splice connectors.

A special stop behind cut out prevents damage to connectors. Utilized on combinations of plastic and pulp insulated 19, 22, 24 and 26 gauge copper conductors as well as 20 gauge plastic insulated copper steel wire. Comes with side cutter and yellow plastic handle.

JONARD PART NO.	LENGTH	JAW LENGTH	JAW WIDTH	JAW THICKNESS	CUTTER LENGTH	WEIGHT
JIC-891	5 3/16"	1"	13/16"	3/8"	1/2"	5.9 oz



JIC-725

**COAX CABLE CUTTER STEEL**

A plier designed specifically for coax cables with a steel center conductor. This plier has been tested (over 25,000 cuts) on cables with steel centers, and specifically CCSC (copper clad steel center) conductor cables without degradation to the cutting blades. Made from chrome vanadium steel. Plier will also cut many other cable types.

JONARD PART NO.	LENGTH	JAW THICKNESS	JAW WIDTH	WEIGHT
JIC-725	6 1/4"	1/4"	1.0"	6.5 oz



JIC-750

**3/ 4" COAX CABLE CUTTER**

Also known as a Banana Cutter, this cutter is designed to cut 3/ 4" coaxial cable. Tool cuts cleanly without compressed or frayed ends. Functions like a tube cutter – eliminates cable distortion during cable prep. NOT designed to cut steel cable. Yellow plastic handles. Made of chrome vanadium steel.

JONARD PART NO.	LENGTH	JAW LENGTH	JAW WIDTH	JAW THICKNESS	WEIGHT
JIC-750	8 3/4"	1 1/4"	5/8"	1/4"	12.6 oz



PLS-5

**HEAT COIL PLIERS**

Designed for installing and extracting heat coils, fuses from line amplifiers and other cylindrical shaped components. The thin nosed jaw allows easy access to tight restricted areas. Yellow plastic handle.

JONARD PART NO.	LENGTH	JAW LENGTH	JAW WIDTH	JAW THICKNESS	WEIGHT
PLS-5	5"	1 13/16"	1/2"	5/16"	3.4 oz

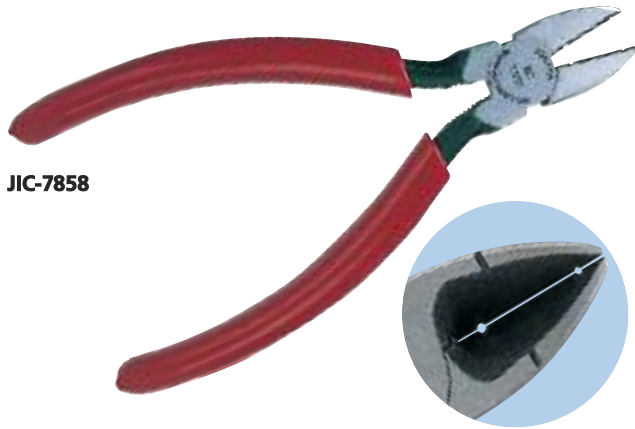

JIC-7858

**TELECOM DIAGONAL CUTTER PLIERS**

Tapered nose diagonal cutting pliers with standard-bevel knives with .030" and .045" skinning holes, with crusher used for multi-purpose wire work, with two V-shaped stripping notches. Red plastic handle. Made of chrome vanadium steel.

JONARD PART NO.	LENGTH	JAW LENGTH	JAW WIDTH	JAW THICKNESS	WEIGHT
JIC-7858	6 1/2"	7/8"	3/4"	3/8"	6.4 oz



DIABVNOTCH

**DIAGONAL PLIERS – CRUSHING & SLITTING**

Used for cutting soft copper conductors. Has a "V" shaped notch between jaws, near the joint, for crushing the flameproof type of insulation on distributing frame wire. Also provides a "W" shaped notch on the plier jaws for slitting textile insulation. Red plastic handle. Made of chrome vanadium steel.

JONARD PART NO.	LENGTH	JAW LENGTH	JAW WIDTH	JAW THICKNESS	WEIGHT
DIABVNOTCH	6 3/16"	13/16"	1/2"	11/32"	4.3 oz



DIAGB5

**DIAGONAL GENERAL USE PLIERS**

These are plain diagonal pliers for general use, for cutting soft copper conductors. Red plastic handle. Made of chrome vanadium steel.

JONARD PART NO.	LENGTH	JAW LENGTH	JAW WIDTH	JAW THICKNESS	WEIGHT
DIAGB5	5 1/8"	13/16"	1/2"	11/32"	4.3 oz

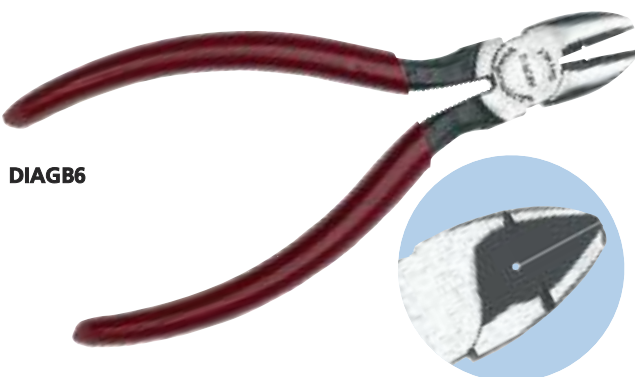

DIAGB6

**DIAGONAL PLIERS – SKINNING & STRIPPING**

Tapered nose diagonal cutting pliers with standard-bevel knives with one .045" skinning hole, crusher used for multipurpose wire work, and two V shaped stripping notches. Red plastic handle. Made of chrome vanadium steel.

JONARD PART NO.	LENGTH	JAW LENGTH	JAW WIDTH	JAW THICKNESS	WEIGHT
DIAGB6	6 1/2"	7/8"	3/4"	3/8"	6.4 oz



JIC-2488

**HIGH LEVERAGE DIAGONAL CUTTER ANGLED HEAD**

13° angled head for heavy-duty wire cutting and crafted for heavy duty wire cutting. Made from chrome vanadium steel. with improved heat treatment to the cutting edges for increased strength. Use for the most demanding applications, precision machined cutting edges provide exceptionally smooth action.

JONARD PART NO.	LENGTH	JAW LENGTH	JAW WIDTH	JAW THICKNESS	WEIGHT
JIC-2488	8 5/8"	13/16"	1 3/16"	3/8"	13.8 oz



JIC-2288

**HIGH LEVERAGE DIAGONAL CUTTER**

Crafted for heavy duty wire cutting. Made from chrome vanadium steel. with improved heat treatment to the cutting edges for increased strength. Use for the most demanding applications, precision machined cutting edges provide exceptionally smooth action.

JONARD PART NO.	LENGTH	JAW LENGTH	JAW WIDTH	JAW THICKNESS	WEIGHT
JIC-2288	8 1/4"	7/8"	1 3/16"	7/16"	13.8 oz



JIC-683

**LINEMAN'S B SIDE CUT PLIERS**

Designed for heavy duty use in construction and maintenance work. These pliers are high leverage for cutting bolts, nails, and many gauges of wire including high-strength wire. Induction hardened cutting edges cut clean and remain sharp. Precision machined handles and hot riveted joint provide smooth movement with no side play. The cushioned-grip, comfortable handles are red plastic to approximately .007". Made of chrome vanadium steel.

JONARD PART NO.	LENGTH	JAW LENGTH	JAW WIDTH	JAW THICKNESS	CUTTER LENGTH	WEIGHT
JIC-683	9 1/2"	1 19/32"	1 1/4"	5/8"	13/16"	14.4 oz

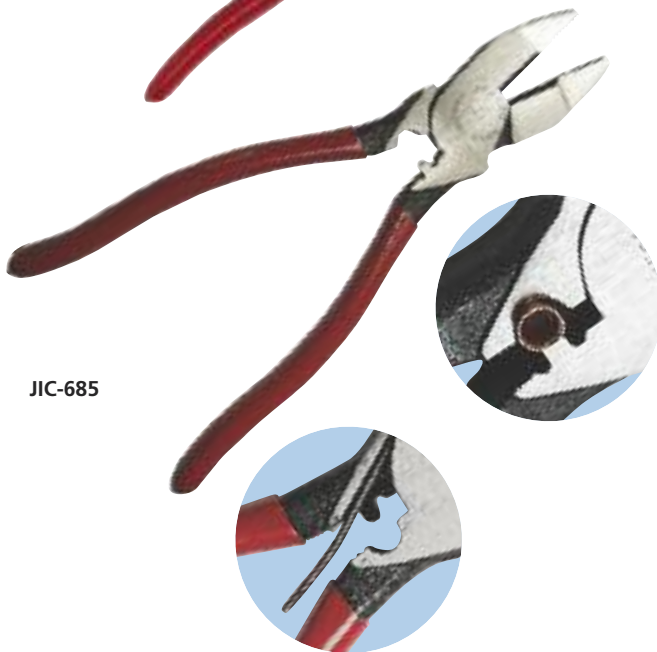

JIC-685

**LINEMAN PLIER WITH CRIMPER & FISH TAPE PULLER**

Designed for heavy duty use in construction and maintenance work. These pliers are high leverage for cutting bolts, nails, and many gauges of wire including high-strength wire. Cutting edges cut clean and remain sharp. Fish tape pulling feature easily pulls 1/8" or 1/4" steel fish tape without damaging the tape. Built in crimper feature works best on non-insulated connectors, lugs and terminals. Cushioned grip, comfortable handles are yellow plastic coated to approximately .007". Made of chrome vanadium steel.

JONARD PART NO.	LENGTH	JAW LENGTH	JAW WIDTH	JAW THICKNESS	CUTTER LENGTH	WEIGHT
JIC-685	9 1/2"	1 19/32"	1 1/4"	5/8"	3/4"	14.4 oz



**HIGH LEVERAGE CABLE CUTTERS**

High leverage design for superior cutting ability. Designed with a shear-type jaw for cutting aluminum and soft copper. Not for use on steel or ACSR type cables. Cuts up to 100-pair cables. Red plastic handle. Made of chrome vanadium steel.



JIC-63050

JONARD PART NO.	LENGTH	JAW WIDTH	JAW THICKNESS	JAW LENGTH	WEIGHT
JIC-63050	9 1/4"	13/16"	1/2"	1 3/8"	15.8 oz

**RATCHETING CABLE CUTTER**

Cuts up to 600 mcm stranded copper cable, 750 mcm stranded aluminum cable. Maximum capacity is 1 3/4" (45mm) diameter. Cleanly cut copper or aluminum & multi-conductor cable up to 600 mcm. Unique design to hold and cut cable quickly, easily with minimum effort. Spring design to hold cutter in the open position when needed. Quick release for easy opening. Large ergonomic handle design (Not designed for cutting ACSR or steel)



RC-600

JONARD PART NO.	LENGTH	DESCRIPTION	WEIGHT
RC-600	12"	Ratcheting Cable Cutter	34.0 oz

**TABBING SHEAR**

Also known as a cable sheath shear. Designed for making longitudinal cuts in the cable sheath and the metallic shield for placement of inner sheath bond clamps. Made of chrome vanadium steel with a special hardening process for durability, with a precision ground blade for superior cutting. Plastic formed ergonomic handles for safety and comfort and a latch to keep the handles closed when not in use. The volute spring allows for easy opening and closing.



TS-850

JONARD PART NO.	LENGTH	DESCRIPTION	WEIGHT
TS-850	8 1/2"	Tabbing Shear	10.5 oz

**SLIP JOINT SIDE CUT PLIERS**

For heavy-duty use. Polished head, red plastic handles and flush bolt. Machined gripping teeth and 3/8" hardened wire cutter.



BCOMB

JONARD PART NO.	LENGTH	JAW LENGTH	JAW WIDTH	JAW THICKNESS	CUTTER LENGTH	WEIGHT
BCOMB	7 5/8"	1 3/4"	1 1/4"	3/8"	3/8"	9.8 oz



JIC-842

**TELECOM LONG NOSE D PLIERS**

Pliers are for general use looping, bending and cutting. Grips small wires and parts and reaches into tight spaces. Jaws are knurled, serrated and have side cutting blades. Cushion gripped yellow plastic handle.

JONARD PART NO.	LENGTH	JAW LENGTH	JAW WIDTH	JAW THICKNESS	CUTTER LENGTH	WEIGHT
JIC-842	6 3/4"	1 7/8"	11/16"	3/8"	1/2"	6.5 oz



JIC-203

**LONG NOSE SWITCHBOARD PLIER**

Pliers are for general use looping, bending and cutting. Grips small wires and parts and reaches into tight spaces. Jaws are knurled, serrated and have side cutting blades. Two stripping holes for 19 & 22 AWG wire. Cushion gripped yellow plastic handle. Made of chrome vanadium steel.

JONARD PART NO.	STRIP HOLES AWG	LENGTH	WEIGHT
JIC-203	19 & 22	6 7/8"	6.5 oz



JIC-21257

**TELECOM LONG NOSE PLIERS**

Long nose have side cutting blades, a crushing slot, one .030" stripping hole, and a thin knurled nose to facilitate handling of the wire at the terminals. Cushion gripped yellow plastic handle. Made of chrome vanadium steel.

JONARD PART NO.	LENGTH	JAW LENGTH	JAW WIDTH	JAW THICKNESS	CUTTER LENGTH	WEIGHT
JIC-21257	6 7/8"	1 7/8"	13/16"	3/8"	1/2"	6.6 oz

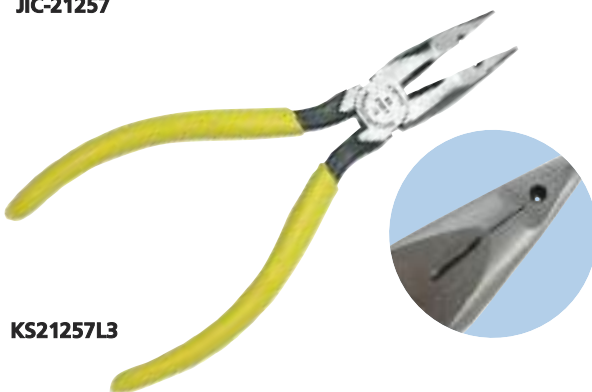

KS21257L3

**LONG NOSE CUT CRUSH STRIP L3 PLIERS**

Long nose with side cutter, crushing slot, one .030" stripping hole and a thin knurled nose to facilitate handling wire at the terminals. Cushion gripped yellow plastic handle.

JONARD PART NO.	LENGTH	JAW LENGTH	JAW WIDTH	JAW THICKNESS	CUTTER LENGTH	WEIGHT
KS21257L3	6 1/2"	1 1/2"	3/4"	3/8"	7/16"	6.1 oz





JIC-3026

**CURVED LONG NOSE PLIER**

Nose is bent 70° for maximum visibility. Used in confined areas. Design includes knurled jaws for sure wrapping and looping. Comfortable ergonomic yellow plastic handles.

JONARD PART NO.	LENGTH	JAW LENGTH	JAW WIDTH	JAW THICKNESS	WEIGHT
JIC-3026	6 7/8"	2"	11/16"	3/8"	7.2 oz



JIC-3385

**CURVED NEEDLE NOSE PLIER**

Nose is bent 60° for maximum visibility. Used in confined areas for bending and forming fine wire. Inside jaws and jaw edges are polished to prevent nicking the wire. Plier has a spring loaded ergonomic design. With a dark blue plastic handle.

JONARD PART NO.	LENGTH	JAW LENGTH	JAW WIDTH	JAW THICKNESS	WEIGHT
JIC-3385	5 1/2"	1 1/2"	1/2"	1/4"	3.2 oz



BLONGNOSE

**LONG NOSE GENERAL USE PLIERS**

Chain nose pliers for general use. Inner surface of the jaws are knurled near the end to facilitate gripping wire, binding post nuts etc. Orange plastic handle.

JONARD PART NO.	LENGTH	JAW LENGTH	JAW WIDTH	JAW THICKNESS	WEIGHT
BLONGNOSE	6 7/8"	1 1/2"	3/4"	3/8"	6.1 oz



ELONGNOSE

**LONG NOSE GRIPPING PRESSING PLIERS**

Long nose pliers for gripping and pressing. Inner surface of the jaws are knurled near the end to facilitate gripping wire, binding post nuts etc. Aluminum oxide insulation coating on the outside nose surface. The inside gripping jaws are provided with mated grooves near the joint for use in pressing .032/.035" brass sleeves. One stripping hole .054" diameter Orange plastic handle.

JONARD PART NO.	LENGTH	JAW LENGTH	JAW WIDTH	JAW THICKNESS	WEIGHT
ELONGNOSE	6 7/8"	1 7/8"	11/16"	3/8"	6.1 oz



BSHORTNOSE

**SHORTNOSE PLIERS**

Intended for use in skinning 22-24 AWG wire and crushing insulation in nose slot. The front portion of the jaws are narrowed, and a portion of the inner face of one jaw is relieved to skin insulation from wire. The inner surface of the jaws are serrated to facilitate gripping wire. Orange plastic handle.

JONARD PART NO.	LENGTH	JAW LENGTH	JAW WIDTH	JAW THICKNESS	WEIGHT
BSHORTNOSE	6 1/2"	1 1/2"	3/4"	3/8"	6.1 oz



JIC-5026

JIC-50210

JIC-50212

**PUMP PLIERS**

Manufactured with a secure tongue and groove design for a non-slip grip (even under heavy pressure). The jaws provide a wide range of openings with a smooth, positive interlock between halves. Handles are plastic coated, but are not insulated and do not protect against electric shock.

JONARD PART NO.	LENGTH	MAX. JAW OPENING	NUMBER POSITIONS	WEIGHT
JIC-5026	6"	1"	4	7.8 oz
JIC-50210	10"	1 3/4"	6	14.4 oz
JIC-50212	12"	2 1/4"	7	24.0 oz



JIC-453

**SEMI-FLUSH CUT PLIERS**

A close cutting plier used to trim conductors from the 710 connector modules without leaving exposed conductors. Ideal for close trimming of gates and sprue on injection molded plastic parts. Jaw design aids in use in confined areas. Turquoise color handle. Plier made from chrome vanadium steel.

JONARD PART NO.	LENGTH	JAW LENGTH	JAW WIDTH	JAW THICKNESS	WEIGHT
JIC-453	4 1/2"	5/8"	7/16"	1/4"	2.4 oz



JIC-2755

**FLUSH CUT PLIER**

Made of high carbon steel, this lightweight flush cutter can be used on wire up to 18 AWG while minimizing fly-off. Cantilevered spring automatically opens the plier, and the head fits easily in confined work areas.

JONARD PART NO.	LENGTH	JAW LENGTH	JAW WIDTH	JAW THICKNESS	WEIGHT
JIC-2755	5"	1/2"	1/2"	1/16"	2.2 oz

All Jonard Industries Pliers come with a **LIFETIME WARRANTY**. For complete details see our website



**FIBER OPTIC DROP CABLE SLITTER**

The FOD-2000 Fiber Optic Drop Cable Slitter is a Patented tool that simplifies the slitting of drop cable jackets at the end of the cable or mid-span. Designed for .250" flat drop cable. The FOD-2000 puts a slit on both sides of the jacket allowing easy access to the fiber or strength member. The ease of use makes this tool truly unique. To use just position the tool around the cable, pull and slit. A simple solution for a vital task. The FOD-2000 comes completely assembled with two blades, which can be reversed once the blades are worn.

**ROUND CABLE STRIPPER**

The CST-1900 is designed for fast and precise jacket removal of PVC, rubber, PE and other jacket materials, and works well on round cables with diameters ranging from 3/16" to 1-1/8" (4.5-29 mm). This is a Triple Action Tool, cutting longitudinally for end stripping, spiral for end stripping and mid-span cuts, and circular for jacket removal. A simple versatile easy to use tool your customers will love. The Replaceable Cutting Blade is spring loaded, adjustable for various cable diameters, provides a 90° blade rotation and is designed for long life.

JONARD P/N	DESCRIPTION
FOD-2000	Fiber Optic Drop Cable Slitter
FOD-RB25	Replacement Blades 25/pk

JONARD P/N	DESCRIPTION
CST-1900	Round Cable Stripper
CST-7915	Replaceable Cutting Blade



**FIBER JACKET STRIPPER**

The Wire Stripper and Cutter is designed to strip and cut the most commonly used stranded and solid wire gauges 10 to 22 AWG and 1.6-3 mm fiber jackets.

JONARD P/N	DESCRIPTION
JIC-1022	Fiber Jacket Stripper

**OPTICAL FIBER CABLE SHEATH STRIPPER & RING TOOL**

This Cable Sheath Stripper is used to ring-cut many types of tight buffer, loose tube buffer, breakout cables and other types of jacketed fiber cables. A slitting blade is built into the tool and can be used to slit open the cable sheath if needed. Depth of the cut has two adjustments for .018" or .031" thick plastic, rubber or fabric insulation, and can handle cable diameters from 1/8" to 3/8". One spare blade of each style is included with the tool. Also known as CT2860.



**UNIVERSAL CRIMPER WITH FIBER OPTIC DIE**  
Fully ratcheted crimper designed for minimal closing force.

JONARD P/N	DESCRIPTION
UC-8039	Universal Crimper with Fiber Optic Die
UC-2685	Fiber Optic Crimping Die

JONARD P/N	DESCRIPTION
JIC-4366	Optical Fiber Sheath Stripper & Ring Tool
RB-2060/6	Pkg. of 6 Replacement Blades for ring feature of tool
RB-2878/6	Pkg. 6 replacement blades for stripper feature of tool



**JIC-375**

**FIBER OPTIC STRIPPER THREE HOLE**

Three hole Fiber Optic Stripper performs all common fiber stripping functions. Strips the 1.6-3 mm fiber jacket down to the 900 micron buffer coating. The second hole strips the 600-900 micron buffer coating down to the 250 micron coating and the third hole is used to strip the 250 micron cable down to the 125 micron glass fiber. JIC-375 is 6" long.

JONARD P/N	DESCRIPTION
JIC-375	Fiber Optic Stripper- 3 Hole



**JIC-175**

**ERGONOMIC FIBER OPTIC STRIPPER**

Used for stripping the 250 micron coating from the 125 micron optical fiber. Preset at the factory so no adjustments are necessary. Yellow plastic formed handles, tool is 6" long.

JONARD P/N	DESCRIPTION
JIC-175	Fiber Optic Stripper Ergonomic



**JIC-125**

**FIBER OPTIC STRIPPER**

For stripping 250 micron buffer coating from 125 micron optical fiber. Preset at the factory so no adjustments are necessary. Yellow plastic dipped handles 5 3/16" long

JONARD P/N	DESCRIPTION
JIC-125	Fiber Optic Stripper

**MS-6**



**MID SPAN SLITTER**

Designed to provide easy access to optical fibers in loose buffer tubes 1.2mm – 3.3mm diameter. With 6 precision grooves buffer tube slitting is done without damage to the fiber. The blades are replaceable.

**Easy to use:**

Select the correct groove for the cable being slit  
Place the cable in the proper channel, squeeze and pull.

JONARD P/N	DESCRIPTION
MS-6	Mid Span Slitter
MSB-1533	Replacement Blade 1.2 – 3.3 mm (pkg of 2)



JIC-375



H-35



ES-1964

**THREE PIECE FIBER OPTIC KIT**

Kit includes the JIC-375 Fiber Optic Stripper three hole, ES-1964 Electrician's Scissor, and convenient molded plastic pouch made of durable PVC material and will accommodate belts up to 2" in width.

JONARD P/N	DESCRIPTION
TK-375	3 Piece Fiber Optic Kit
H-35	Plastic Molded Pouch
JIC-375	Fiber Optic Stripper- 3 Hole
ES-1964	Electrician Scissor



JIC-375



H-60



JIC-186

**FIBER KIT WITH KEVLAR CUTTER**

Kit includes the JIC-375 Fiber Optic Stripper Three Hole, JIC-186 Ergonomic Fiber Optic Kevlar Cutter and the convenient H-60 molded plastic pouch with metal clip.

JONARD P/N	DESCRIPTION
TK-350	Fiber Kit with Kevlar Cutter
H-60	Plastic Moulded Pouch
JIC-375	Fiber Optic Stripper- 3 Hole
JIC-186	Ergonomic Fiber Optic Kevlar Cutter



VFL-25

VFL-25125

**VISUAL FAULT LOCATOR**

This pen style VFL is specially designed for field personnel who need a portable light source tool for fiber tracing, fiber routing, continuity testing, to locate breakpoints (bending or cracking in fiber optic cables), and poor connections.

The VFL works in an OTDR dead zone and is used for end-to-end visual fiber identification. Operates in either CW (continuous wave) or pulsed mode. Not recommended For use on dark colored or armored cables.

**TECHNICAL SPECIFICATIONS**

- Light Source: Class IIIA Laser Diode
- Wavelength: 650nm
- Battery Life: 60 Hours
- Connector: 2.5mm universal
- Working Temperature: -4F (-20C) to 140F (60C)
- Storage Temperature: -40F (-40C) to 185F (85C)
- Power: 2 AAA Batteries

JONARD P/N	DESCRIPTION
VFL-25	Visual Fault Locator and 2 AAA Batteries
VFL-150	Visual Fault Locator Kit - Includes: VFL-25, 2 AAA Batteries, VFL-25125 FC/LC Adapter
VFL-25125	FC/LC Adapter





**TSAB-40**

**THERMAL FIBER OPTIC STRIPPER FIXED BLADE**

Thermo-mechanically remove coatings from optical fibers. High strength thermal stripper supports standard 125µm optical fibers, including 250 µm, 400 µm, and 900 µm coated fibers. The heater is adjustable to 200°C and facilitates stripping difficult and baked-on coatings. Adjustable temperature and time settings to adapt to a variety of different coatings. Compact design, weighs less than a pound. Includes A/C power supply, cord and cleaning brush. Platforms supplied separately.



**TSPE-125**

**TSPF-125**

**TSUC-40**

**THERMAL FIBER OPTIC STRIPPER ADJUSTABLE BLADE**

Thermo-mechanically remove coatings from optical fibers. High strength thermal stripper with adjustable stripping blade, which supports cladding diameters 30µm to 1000 µm acrylate coated fibers with buffer diameters up to 1200 µm. The heater is adjustable to 200°C and facilitates stripping difficult and baked-on coatings. Adjustable temperature and time settings to adapt to a variety of different coatings. Compact design, weighs less than a pound. Includes A/C power supply, cord and cleaning brush. Platforms supplied separately.

For Fitel, Fujikura and Ericsson fiber holders use the corresponding platforms, for LDF and all others without fiber holders use the Jonard Universal Clamp.

JONARD P/N	DESCRIPTION
<b>TSPE-125</b>	Ericsson Style Platform
<b>TSPF-125</b>	Fitel/Fujikura Style Platform
<b>TSUC-40</b>	Universal Clamp

JONARD P/N	DESCRIPTION
<b>TSFB-125</b>	Thermal Stripper Fixed Blade
<b>TSAB-40</b>	Thermal Stripper Adjustable Blade



**TSUC-5000**



**TSUC-510**

**ULTRASONIC CLEANER**

The Jonard Industries TSUC-5000, compact, low maintenance Ultrasonic Cleaner is a purpose-built ultrasonic fiber cleaner that has been designed specifically for fiber splicing applications. The unit comes with a power supply, power cord, alcohol dispenser and user manual. Easy to use, an audible and visual indicator will signify when the fiber should be removed. Versatile settings allow user to adjust for cycle duration and intensity levels for maximum results. Options include a solid lid to reduce evaporation, and custom rails that can be adapted to the most popular fiber holders such as Fitel, Fujikura and Ericsson.

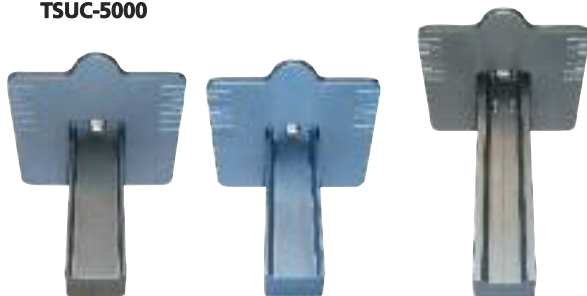

**TSUC-518**

**TSUC-516**

**TSUC-512**

JONARD P/N	DESCRIPTION
<b>TSUC-5000</b>	Ultrasonic Cleaner
<b>TSUC-510</b>	Ultrasonic Cleaner Cover
<b>TSUC-512</b>	Ultrasonic Cleaner 12mm Ericsson Rail
<b>TSUC-516</b>	Ultrasonic Cleaner 16mm Fitel Fujikura Rail
<b>TSUC-518</b>	Ultrasonic Cleaner 18mm Fitel Rail





JIC-186

**ERGONOMIC FIBER OPTIC KEVLAR® CUTTER**

High carbon stainless steel blades designed to cut Kevlar®, cabling insulation, tape, cable ties and other material. Ergonomic handles for user comfort and durability. Adjustable joint screw under protective cap, serrated blades grip material, sharp and durable 6" long.

JONARD P/N	DESCRIPTION
JIC-186	Wire & Kevlar Cutting Shears



JIC-195

**COMMUNICATION SCISSOR**

High carbon stainless steel blades, 1/4" notch for cutting & stripping, two stripping notches for 18 & 22 AWG wire, one serrated non-slip blade, dual component handle. High carbon stainless steel blades that are both sharp and durable with serrated blade that grips and holds the wire. Ergonomic dual component nylon & santoprene handles, for user comfort and durability. Designed with an adjustable joint screw under the protective cap.

JONARD P/N	DESCRIPTION
JIC-195	Communication Scissor

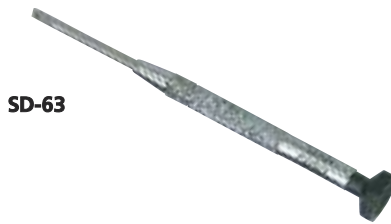

SD-63

**SCREWDRIVER, JEWELER'S TYPE**

Used to terminate the battery backup in the fiber ONT. Screwdriver has concave swivel knob to fit the finger and hexagonal shape to prevent rolling. Solid blade made of high quality hardened tool steel. .100" blade width. 4" long.

JONARD P/N	DESCRIPTION
SD-63	Jeweler's Screwdriver



ST-500

**ADJUSTABLE PRECISION FIBER STRIPPER**

This adjustable stripping tool is designed to strip 0.3mm–1.0mm diameter cable. It is capable of stripping the 900 micron buffer coating from optical fiber cables. Made with specially hardened blades (RC58) for long life. Easy to use, just squeeze and pull.

JONARD P/N	DESCRIPTION
ST-500	Adjustable Precision Fiber Stripper



CSR-1575

**CABLE SLIT AND RING TOOL**

The CSR-1575 is designed to slit and ring UTP, STP, Coax and other cables, buffer tubes and Jackets on fiber optic cables up to 7.5mm (0.3") in diameter. The tool features an easily adjustable slit blade and ring blade for nick-free strips. The removable/ reversible V block accommodates smaller and larger diameter cables.

JONARD P/N	DESCRIPTION
CSR-1575	Cable Slit and Ring Tool
CSR-2	Replacement Blades – set of 2



M-216C/EX



M-216C/REX

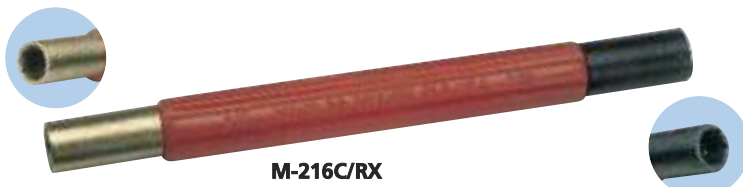

M-216C/RX



M-216CS22



M-216CKIT

SK-51632



BW-532



BW-532-3



BW-516

**CAN SOCKET WRENCH**

Double end can socket wrench, 3/8" and 7/16" hex, orange plastic handle in either our standard or ergonomic design. Used in placing fuses in cable terminals and connecting wires to fuses and binding posts. The walls on both sockets are thin enough so they can be used to work locking devices on most terminals and cabinets. 7" long.

JONARD P/N	DESCRIPTION
M-216C/EX	Ergonomic 1" Dia. Handle, Hex Outer Socket
M-216C/REX	Ergonomic 1" Dia. Handle, Round Outer Socket
M-216C/RX	Standard Handle, Round Outer Socket
M-216CS22	Ergonomic 1" Dia. Handle, Hex Outer Socket with 22 AWG Stripper Blade
M-216CKIT	Ergonomic 1" Dia. Handle, Hex Outer Socket with 22 AWG Stripper Blade Can Wrench and Security Key Insert

**SECURITY KEY INSERT**

Designed with a double-ended hex adapter for two sizes of pin-in-head security fasteners. Simply slip the key into the 3/8" side of a can wrench and you are ready for either a 5/16" or 5/32" hex security screw. This is a reversible insert tool. One end is for SLC Cabinets and the other is for most network interface boxes.

JONARD P/N	DESCRIPTION
SK-51632	Security Key Insert

**BOOTH WRENCH**

Tamperproof hex screwdriver, also known as a booth wrench or security wrench. It features a 1" diameter screwdriver handle, 5/32" hex shaft with a hole drilled in the tip for use with security tamperproof screws used for telephone and CATV applications. BW-532 Booth Wrench is 9" long and the BW-532-3 Booth Wrench is 6" long.

JONARD P/N	DESCRIPTION
BW-532	Booth Wrench -Ergonomic design 9"
BW-532-3	Booth Wrench -Ergonomic design 6"

**T HANDLE SECURITY WRENCH 5/16"**

T handle tamper proof 5/16" wrench for use on tamper-proof cross-connect cabinets, MESA and CATV closures. Recessed at both ends and they are 1/4" deep. Red plastic handle for user comfort

JONARD P/N	DESCRIPTION	HOLE DIA.	LENGTH	RECESS
BW-516	T Handle Security Wrench	0.15"	7.5"	1/4"

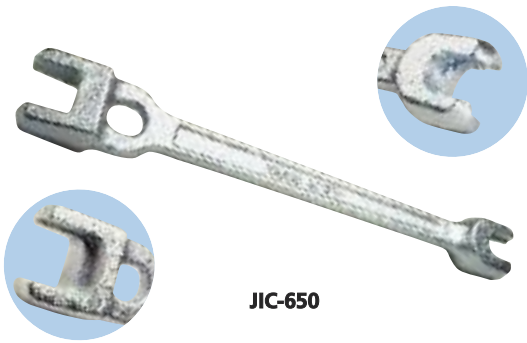

JIC-650

**LINEMAN'S B WRENCH**

Forged and heat treated, this wrench is used on pole line hardware. It is open-end double-end type with two sizes of openings at each end and an oval hole for turning pole steps. The end openings accommodate nuts for 3/8", 1/2", 5/8" and 3/4" bolts and the head of the 1/2" drive screw. The faces of the wrench openings are offset to provide handle clearance.

JONARD P/N	DESCRIPTION
JIC-650	Lineman's B Wrench

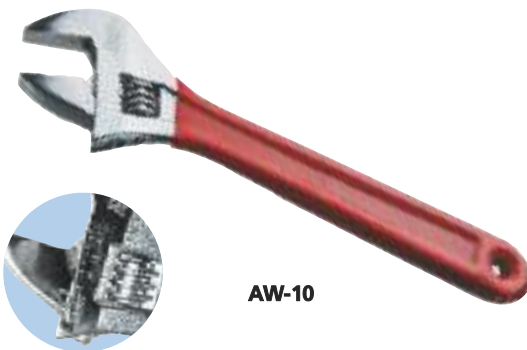

AW-10

**ADJUSTABLE WRENCHES WITH EXTRA WIDE JAW**

All wrenches are made of chrome vanadium steel with a chrome plated finish. Wrenches are forged and heat treated for greater strength. Handles are covered with a red transparent plastic for user comfort. The knurl is precision formed and the operation is smooth and trouble free. For accurate adjustments use the metric or English scales on either side of the jaws.

JONARD PART NO.	DESCRIPTION	LENGTH	JAW CAPACITY	WEIGHT
AW-6	Adjustable Wrench 6"	6" (152 mm)	15/16" (24mm)	5.2 oz
AW-8	Adjustable Wrench 8"	8" (203mm)	1 1/8" (29mm)	10.6 oz
AW-10	Adjustable Wrench 10"	10" (254mm)	1 5/16" (33mm)	14.6 oz
AW-12	Adjustable Wrench 12"	12" (305 mm)	1 1/2" (38mm)	24.0 oz
TK-6810	Wrench set-3 piece includes 6", 8" & 10"			

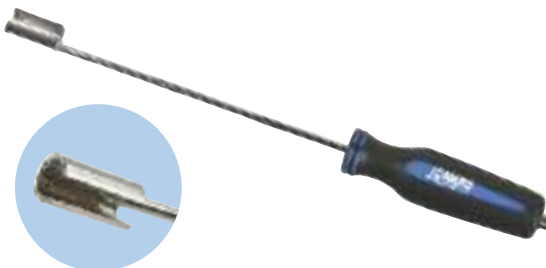

RF-12

**F CONNECTOR TOOL**

Designed to provide easy access to connectors in high-density locations. The head measures 7/16" and is used specifically for "F" connectors and BNC connectors. The socket extends 8" from the handle, the overall length is 12" and the back of the handle has an insertion device to aid in making connections. Will also work with BNC connectors.

JONARD P/N	DESCRIPTION
RF-12	F Connector Tool



RBNC-12

**BNC CONNECTOR TOOL**

Designed to provide easy access to connectors in high density locations. The head is formed specifically for a wide variety of BNC connectors. The socket extends 8" from the handle and the overall length is 12".

JONARD P/N	DESCRIPTION
RBNC-12	BNC Connector tool

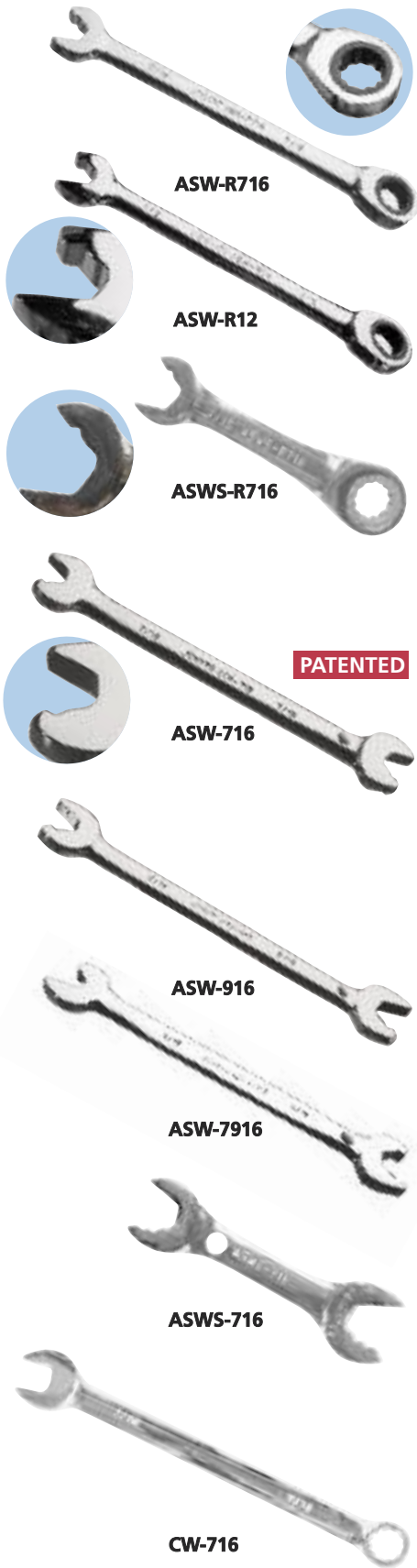

**RATCHETING SPEED WRENCH**

Speed head makes tightening and loosening quick and easy while the ratcheting box end offers 12 points of contact. Polished to a high gloss finish and made of chrome vanadium steel. ASW-R716 - Combination wrench measures 7/16" at both ends. This is the perfect tool for cable and satellite installers. Designed to work on F Connectors, on splitters, and all 7/16" connections. ASW-R12 Combination wrench measures 1/2" at both ends.

JONARD P/N	DESCRIPTION	LENGTH
ASW-R716	Ratcheting Speed Wrench 7/16" (works on F Connectors)	6 1/2"
ASW-R12	Ratcheting Speed Wrench 1/2"	6 1/2"
ASWS-R716	Ratcheting Speed Wrench 7/16" Stubby	4"

**SPEED WRENCH DOUBLE ENDED-PATENTED**

ASW-716 measures 7/16" at both ends. ASW-12 measures 1/2" at both ends and ASW-916 measures 9/16" at both ends. Speed head makes tightening and loosening quick and easy, plus head is angled (15°) to ease access. Speed wrenches are 6 1/2" long with a hole on the handle for a clip or other hanging device. High gloss chrome finish, and made of high carbon alloy steel.

JONARD P/N	DESCRIPTION	LENGTH
ASW-12	Speed Wrench double Ended 1/2"	6 1/2"
ASW-716	Speed Wrench double Ended 7/16"	6 1/2"
ASW-916	Speed Wrench double Ended 9/16"	7 1/2"
ASW-7916	Speed Wrench double Ended 7/16" + 9/16"	7 1/2"
ASWS-716	Speed Wrench Double Ended 7/16" Stubby	4"

**COMBINATION WRENCH**

Wrench measures 7/16" at both the open end and box end. Both ends have an angle offset (15°) to ease access in confined areas. The box end offers 12 points of contact. High gloss chrome finish and made of chrome vanadium steel.

JONARD P/N	DESCRIPTION	LENGTH	WEIGHT
CW-716	Combination Wrench	6 5/8"	2.88 oz



Full Head



Speed Head



TWAF-71620



TWAS-71620

### TORQUE WRENCH

Designed for "F" Connectors, these wrenches help prevent over tightening. An audible click tells you the connection has been properly achieved. These wrenches all have angle heads, and are designed with an ergonomic cushioned handle for user comfort and protection. The last two digits of the part number indicate the inch pounds of torque (either 20, 30 or 40 inch pounds) and the first four letters indicate whether the head is a speed head or a full head (TWAF is full and TWAS is speed). Note that these wrenches work in tightening mode only.

**Full Head** - is a full size open end wrench that behaves like a traditional open end wrench.

**Speed Head** - is designed to act like a ratcheting wrench. The tool skips over the corners of the bolt or nut being turned so no repositioning of the tool is required (allowing continuous turning).

### TORQUE WRENCHES 7/16"

JONARD P/N	DESCRIPTION	TORQUE IN INCH-LBS	TORQUE IN NEWTON METERS
TWAF-71620	Torque Wrench Full Head	20	2.26
TWAS-71620	Torque Wrench Speed Head	20	2.26
TWAF-71630	Torque Wrench Full Head	30	3.39
TWAS-71630	Torque Wrench Speed Head	30	3.39
TWAF-71640	Torque Wrench Full Head	40	4.52

### TORQUE WRENCHES 1/2" & 9/16"

JONARD P/N	DESCRIPTION	TORQUE IN INCH-LBS	TORQUE IN NEWTON METERS
TWAF-1220	Torque Wrench Full Head 1/2"	20	2.26
TWAF-91620	Torque Wrench Full Head 9/16"	20	2.26
TWAF-91630	Torque Wrench Full Head 9/16"	30	3.39



TWAFST-71630

### TORQUE WRENCH WITH SECURITY SHIELD ATTACHED

Torque wrench is set at 30 in./lb. with security shield attached. Security shield measures 4 3/4" (120mm), is permanently attached and pivots in 90 degree increments. Ideal for hard to reach shielded F connector fittings where a pre-set torque is required.

JONARD P/N	DESCRIPTION
TWAFST-71630	Torque Wrench with 7/16" Security Shield Attached

### TORQUE WRENCH SWIVEL HEAD

Used to properly torque cable shield bond connectors and other ground connections. Head swivels 90° in 2 directions and is factory set for 40 in./lb. Can be used with any 3/8" drive sockets. Audible click when proper torque is achieved.



TWSW-40

TWS-38

JONARD P/N	DESCRIPTION
TWSW-40	Torque Wrench Swivel Head 40 inch pounds
TWS-38/10	3/8" Socket for TWSW-40 (Pkg. of 10)



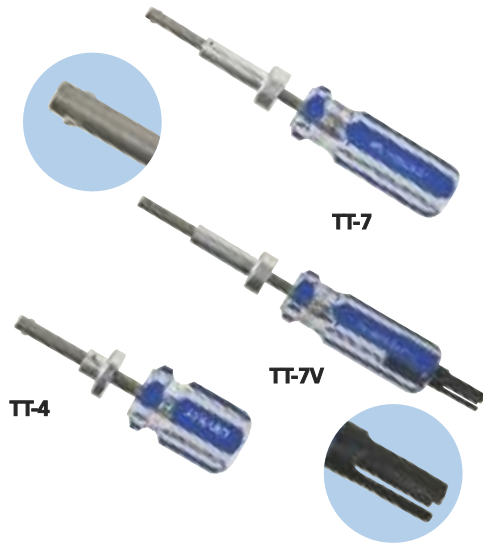

**TERMINATOR TOOLS**

Tool is used for various locking terminators including the Gilbert Engineering GTP (Morlock), PRC (Production Products Company), LFT, PCT (International Technology), TPG, TR 75 GTL (Viewsonics), and SV-LT & SV-LTA (Signal Vision) locking terminators. Ergonomic handle provides greater leverage and a superior grip. Available in three sizes 4 1/2", 8", and 9" Pronged locking terminators. Ergonomic handle provides greater leverage and a superior grip.

JONARD P/N	DESCRIPTION
TT-4	Terminator Tool 2 1/2" shaft, overall length 4 1/2"
TT-7	Terminator Tool 4" shaft, overall length 8"
TT-7V	Pronged Terminator Tool 4" shaft, overall length 9"



**CAM STYLE LOCKING TERMINATOR TOOL**

A Cam Style locking terminator tool for Corning Gilbert style terminators. Works on Gilbert NS-5762-3 (plus -9, -11, -13 & -15 terminators). High quality aluminum construction, blue color.

JONARD P/N	DESCRIPTION	LENGTH	WEIGHT
TTCG-6270-5	Locking Terminator Tool	5 inches	1.75 oz
TTCG-6270-9	Locking Terminator Tool	9 inches	7.50 oz



**BARREL LOCK PLUNGER KEY**

This barrel lock plunger key is compatible with several types of Highfield and Inertite barrel locks with inside diameters ranging from 0.176" to 0.196". Key is made of high carbon steel with smooth plunger and heavy duty spring for strength and durability. Serialized for added protection for authorized personnel only.

JONARD P/N	DESCRIPTION
TTB-6	Barrel Lock Plunger Key

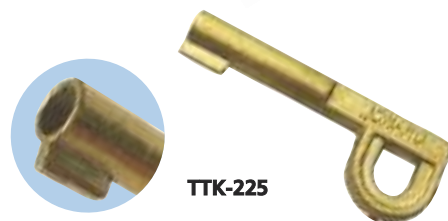

**P KEY FOR SELF LOCK PEDESTAL LOCK**

This P Key is designed to work with Channell Locks and other similar pedestal locks. This P key fits many popular pedestals and opens most heavy duty spring lock cabinets. Also referred to as a skeleton key, made of brass and fits easily on a key chain.

JONARD P/N	DESCRIPTION	LENGTH	WEIGHT
TTK-225	P Key for Self Lock Pedestal Locks	2.25"	0.75 oz





**SECURITY SHIELD TOOL 7/16"**

Used with 7/16" hex shielded F Connectors. Design includes extended 7/16" shank for ease of use with Torque Wrenches in security shield applications. Machined and heat-treated steel for maximum durability with black oxide finish. Knurled handle for secure gripping and includes a steel loop for turning leverage and carrying.

**Note:** SST-716AT is designed for use where security shield applications for PPC AquaTight® EX Series and Gilbert GF URS-6 connectors are used.

**SECURITY SHIELD TRAP TOOL 9/16"**

Used with 9/16" Hex shielded F connectors (RG11 connectors). Machined and heat treated high carbon steel for maximum durability with nickel plated finish. Loop attachment to allow for connecting to your key ring or carabiner for easy access. Shaft Length 1.625"

JONARD P/N	DESCRIPTION
SST-716	Security Shield Tool 7/16"
SST-716AT	Security Shield-Aqua Tight Tool
SST-916	Security Shield Tool 9/16"



**TRAP SECURITY COMBO TOOL**

Two tools in one - a trap wrench with a security wrench. The perfect tool for all standard traps and equally adaptable for all sizes of metal security shields (The security wrench fits all metal 7/16" hex fittings). Made of lightweight aluminum with a security socket made of hardened steel for longer life. Lightweight just 2 oz. (57g) and just 7 1/2" long

JONARD P/N	DESCRIPTION	LENGTH	WEIGHT
TTS-716	Trap Security Combo Tool	7.5"	2 oz

**FUSE PULLER PLIERS**

Designer for installing and extracting fuses from line amplifiers and other cylindrical shaped components including heat coils. The thin nosed jaw allows easy access to tight restricted areas. Handle is yellow colored plastic.

JONARD P/N	LENGTH	JAW LENGTH	JAW WIDTH	JAW THICKNESS	WEIGHT
FP-600	5"	1 13/16"	1/2"	5/16"	3.4 oz

**FLARING & INSERTION TOOL**

The flaring end of the tool facilitates the expansion of the cable providing easier insertion of "F" connectors. The insertion end makes "F" connector insertion fast and easy, even in cold weather. This tool is recommended for use on polyethylene jacketed cables and plenum cables, and is especially helpful when using tri-shield and quad-shield cables. 4 1/4" long



JONARD P/N	DESCRIPTION
FT-6	Flaring & Insertion Tool



**UST-500**



**UST-205**



**UST-215**



**UST-210**



**UST-225**



**UST-100**



**UST-150**



**UST-1596**



**UST-175**



**UST-220**

**UNIVERSAL CABLE STRIPPING TOOL**

Use for Coax, Round Network Cables and Flat Cables - This versatile tool is five tools in one. Simply reverse the blade for RG59/6 & 7/11 Coax Cables. Insert the Round Cable into the second hole (adjustable) for a fast and easy strip. Will strip CAT6 cables with outside diameter up to 0.250". The third hole is for cutting all styles of cable while the fourth hole is designed for Flat Cable and 4P/6P style cable. The perfect wire stripper for most stripping applications. Includes Velcro strip for holding back the braided shield of the cable.

JONARD P/N	DESCRIPTION	BLADE INCLUDED
<b>UST-500</b>	Coaxial Cable Stripper (RG59/6 & 7/11)	UST-205
<b>UST-525</b>	Coaxial Cable Stripper with cable stop	UST-225
<b>UST-596</b>	Universal Cable Stripping Tool (59/6)	UST-210
REPLACEMENT BLADES		
<b>UST-205</b>	Repl Blade for RG59/6 & 7/11	
<b>UST-210</b>	Repl Twin Blade RG59/6 with Cable Stop.	
<b>UST-215</b>	Repl Blade for RG59/6 with Cable Stop & Untwisted Pair	
<b>UST-220</b>	Repl Blade for UST-175 Mini-coax only	
<b>UST-225</b>	Repl Blade for RG59/6 & RG7/11 with Cable Stop	

**COAXIAL CABLE STRIPPER TOOL**

The UST 100 Series strips a multitude of cables. Virtually all the blades are interchangeable with the exception of the UST-220. This blade is matched exclusively to the UST-175 handle. For replacement blades or complete tools see table above. Includes Velcro strip for holding back the braided shield of the cable.

JONARD P/N	DESCRIPTION	BLADE INCLUDED
<b>UST-100</b>	Coaxial Cable Stripper (RG59/6 & 7/11)	UST-205
<b>UST-125</b>	Coaxial Cable Stripper with UST-225 Blade	UST-225
<b>UST-150</b>	Coaxial Cable Stripper with UST-215 Blade	UST-215
<b>UST-175</b>	Mini-Coaxial Cable Stripper	UST-220
<b>UST-1596</b>	Coaxial Cable Stripper (59/6) w/Twin Blade	UST-210

**MINI-COAX CABLE STRIPPER**

The UST-175 is a three level coax stripper for mini-coax cables (CommScope73508, Belden 735A1 and similar cables). The mini strips 0.625" of the outer jacket in the first level, the second level strips the braid exposing 0.156" of dielectric, and the third level strips the dielectric exposing 0.156" of the 26 AWG center conductor. Includes Velcro strip for holding back the braided shield of the cable.

JONARD P/N	DESCRIPTION
<b>UST-175</b>	Mini-Coax Cable Stripper
<b>UST-220</b>	Replacement Blade for the UST-175

CT-200



**UNIVERSAL COMPRESSION TOOL CT-200**

This universal compression tool is designed for use on F Connectors (RG59, RG6, & RG11), BNC Connectors (RG59 & RG6) and RCA Connectors (RG59 & RG6). BNC connectors must be over 1.5" in length. Tool is designed with a dual head and adjustment dial for each unique connector application. COMPATIBLE CONNECTORS: PPC - CMP6, CMP62, CMP59Q, CMP11, EX6XL, EX59XL, EX59XLHE, EX6XLW9, EX7, EX7N716, EX11, EX11N716, EX320QR, EX320N716. T & B - Snap -n-Seal Digicon - DS6, DS59, DS59Q, DS11, DS7 Gilbert UE - GF-UE-59, GF-UE-59Q, GF-UE-6, GF-UE-6Q, GF-UE-5.1, RCA-UE, BNC-UE *Plus many other brands and styles including F, RCA & BNC Types.*

CTF-200



**FIXED COMPRESSION TOOL CTF-200**

Compression tool with a fixed design for use on many manufacturers longer style F Connectors. Some compatible connectors are **Thomas & Betts:** Snap-N-Seal, **Digicon:** DS6, DS59, DS6Q, DS59Q, DS11, DS7, **Gilbert UltraEase:** GF-UE-59, GF-UE-59Q, GF-UE-6, GF-UE-6Q, GF-UE-5.1, **PPC:** CMP6, CMP6Q, CMP59, CMP59Q, CMP11, EX6XL, EX59XL, EX59XLHE, EX6XLWS, EX6LP, EX7, EX7N716, EX11, EX11N716, EX320QR, EX320N716

CTF-300



**FIXED COMPRESSION TOOL CTF-300**

Compression tool with a fixed design for use on the shorter style F connectors (Such as PPC® Aquatight Connector EX or shorter connectors and other similar length connectors). PPC: EX6/59, EX6W9, EX59HE, EX6P, EX7, EX7N716, EX11, EX11N716, EX320QR, EX320N716

JONARD P/N	DESCRIPTION
CT-200	Universal Compression Tool
CTF-200	Fixed Compression Tool - for longer style F connectors
CTF-300	Fixed Compression Tool - for shorter style F connectors

UC-864

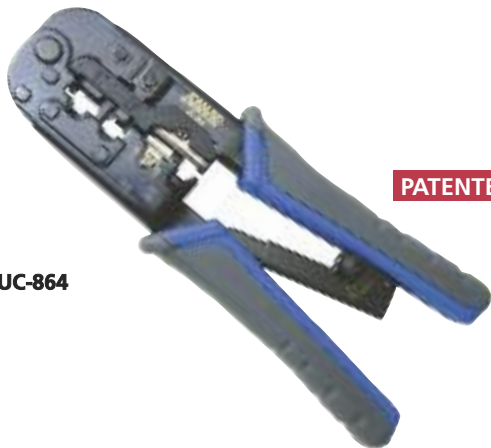

**MODULAR CRIMPING TOOL**

This modular crimping/stripping connector tool for voice and data applications. Designed to cut, strip and crimp paired conductor cables (round STP/UTP and flat satin phone cables). Crimps: 4, 6, 8, position modular connectors (RJ22, RJ11, RJ45)

JONARD P/N	DESCRIPTION
UC-864	Modular Crimping tool 6 in 1



**MCT-468**

**MCT-468 MODULAR CABLE TESTER**

The MCT-468 is designed to check and troubleshoot the pin connections of cables with RJ45, RJ11 and RJ12 connectors. It is also ideal for testing the continuity of these cables prior to installation.

**FEATURES INCLUDE:**

1. Can test RJ45 and RJ11 and RJ12 connected cables.
2. Tests for opens, shorts and miswiring.
3. Full LED indication lights on both main and remote unit
4. Auto tests when switched on. Move switch to S to slowdown auto test feature for greater visibility.
5. Small size and lightweight
6. Carrying case and 9V battery included

JONARD P/N	DESCRIPTION
<b>MCT-468</b>	Modular Cable Tester



**CM-8**

**CABLE MAPPER & TONER - CM-8**

**FIND & IDENTIFY MULTIPLE COAX CABLES IN MAIN CABLE BOXES** For use on Coax Cables for CATV, Satellite Installations, Audio Video Equipment, CCTV and Security & Alarm Installations. The CM-8 Coax Cable Mapper & Toner is designed to quickly find and identify multiple cables and easily map runs to and from a central cable bundle.

**FEATURES INCLUDE:**

1. Eight numbered & color coded cable identifiers.  
#1 White, #2 Red, #3 Black, #4 Blue, #5 Green, #6 Yellow, #7 Purple & #8 Brown.
2. Two Alligator clip sets  
1x F-Male coax adapter  
1x F-Female coax adapter
3. Built-in tone generator
4. Auto power off 30 minutes in "Tone" mode
5. Test for Opens and shorts
6. Auto power off 12 seconds after Pass/Fail results
7. Maximum cable length for testing 5,000 feet
8. Powered by two 3V CR2032 batteries
9. Low battery warning light
10. Maximum DC cable resistance 100 Ohms
11. Live Voltage detection

**CM-8 Kit contains:**  
Cable Mapper & Toner  
8 Cable Identifiers  
(Numbered & color coded)  
2 Alligator Clip Sets  
Cordura Case  
Instruction Sheet

**NOTE:** This Cable Mapper & Toner will not test cable runs with AC or DC voltage present, Power Amplifiers, Isolation Splitters, Attenuators, Directional Line Tap, Power Dividers or Matching Transformers & DC blocking devices



**CM1-SET8**

**CM-17 Kit contains:**  
Contents of the CM-8 kit  
9 RJ45 connectors



**CMI-RJ45**

JONARD P/N	DESCRIPTION
<b>CM-8</b>	Cable Mapper & Toner
<b>CM1-SET8</b>	8 Cable Identifiers (Numbered & Color Coded)
<b>CM-17</b>	Cable mapper and tower for Coax and LAN
<b>CMI-RJ45</b>	Nine RJ45 adapters





TETP-900

**MULTI-FUNCTION CABLE TESTER TONER & PROBE KIT**

Ideal for VDV (voice – data – video) professionals in telecommunications, network and digital communications. This is a multi-function cable tester for RJ45 LAN cable, BNC/F coaxial cable, 6P2C/4P2C jacks and provides tone generation.

Kit includes: cable tester, tone tracing probe, (2) BNC male to F female connectors, BNC cable terminator 50Ω, RJ45 jumper, two 9V batteries, nylon bag, belt clip, user’s manual

JONARD P/N	DESCRIPTION
TETP-900	Multi-Function Cable Tester Toner & Probe Kit
TET-700	Multi-Function Cable Tester & Toner
TEP-200	Tone Tracing Probe
TET-6	Accessory Kit for TET-700

**POCKET CONTINUITY TESTER AND TONER**

Drop cable continuity tester - accurate up to 5,000 feet (1,500 m). Identify cables in an MDU, and detect troublesome short circuits.

**FEATURES**

1. Loud tone identifies line carrying signal
2. LED light indicates splitters, DC shorts and other self grounding devices in cable
3. Right angle male push-on connector for working in confined areas
4. Accurate up to 5,000 feet (1,500 m)
5. Common AAA battery for operation
6. Voltage protected to 52V DC
7. Just 5" long, weighs 2 oz. (57 g)
8. Built in on/off switch



PT-300

PT-350

Comes complete with LED light indicator, detachable tone detector, female push-on connector and 1.5V AAA battery.

JONARD P/N	DESCRIPTION
PT-300	Pocket Continuity Tester and Toner
PT-350	Pocket Tester Replacement Speaker

**UNIVERSAL CRIMPER**

This fully ratcheted crimper is designed for minimal closing force (higher crimp force).

JONARD P/N	DESCRIPTION
UC-8012	Universal Crimper with COAX Die



UCD-2045

UC-8012

JONARD P/N	DIE SPECIFICATIONS		CABLE SIZE
UCD-2045	COAX	.068"/.1262"/.1324"/.1360" 1.73mm/6.65mm/8.23mm/9.14mm	CATV "F" Connectors RG59/RG6



**FIVE PIECE TELECOM INSTALLERS KIT**

The perfect kit for simple installations—includes the basic necessities. Kit includes the M-216CS22 Can Wrench, KN-7 Ergonomic Cable Splicing Knife, ES-1964 Electrician’s Scissors, JIC-22035 Spudger and the H-50 Pouch made of durable PVC material with metal clip.

JONARD P/N	DESCRIPTION
TK-50	Five Piece Telecom Installers Kit
H-50	Plastic Molded Pouch
KN-7	Ergonomic Cable splicing Knife
M-216CS22	Can Wrench with 22 AWG wire stripper
JIC-22035	Probe Pick Spudger
ES-1964	Electrician Scissor

TK-50

M-216CS22

JIC-22035



**TELEPHONE INSTALLER SPLICER KIT**

Designed for stripping, splicing and crimping. The perfect kit for telephone installers. Kit contains the ES-1964 Electrician’s Scissors, JIC-22148 Combo Crimper Long Nose Plier and the H-36 Pouch made of durable PVC material with metal clip.

JONARD P/N	DESCRIPTION
TK-22148	Telephone Installer Splicer Kit
H-36	Plastic Molded Pouch
JIC-22148	Combo Crimper Long Nose Plier
ES-1964	Electrician Scissor

TK-22148

H-36

JIC-22148

ES-1964



**SPLICER’S KIT**

This compact kit contains an ergonomic splicers knife, scissor and leather pouch. The knife features a 1 3/4” tough, cutlery-steel blade and a non-slip handle. The scissors are made of high carbon steel with scraper and file on one side and 2 stripping notches on the other. Both items fit securely in the leather pouch which can be mounted on belts up to 2” wide.

JONARD P/N	DESCRIPTION
TK-400	3 Piece Splicer’s Kit
H-40	Leather Pouch
KN-7	Ergonomic Cable Splicing Knife
ES-1964	Electrician Scissor

TK-400

ES-1964

KN-7

H-40



**FIBER KIT WITH KEVLAR CUTTER**

Kit includes the JIC-375 Fiber Optic Stripper Three Hole, JIC-186 Ergonomic Fiber Optic Kevlar Cutter and the convenient H-60 molded plastic pouch with metal clip.

JONARD P/N	DESCRIPTION
TK-350	Fiber Kit with Kevlar Cutter
H-60	Plastic Moulded Pouch
JIC-375	Fiber Optic Stripper- 3 Hole
JIC-186	Ergonomic Fiber Optic Kevlar Cutter

TK-350

JIC-375

H-60

JIC-186



**COAX TOOL KITS**

A CATV technician’s service kit designed for repair and maintenance of CATV cable networks



TK-82



TK-83



TK-85

JONARD PART NO.	DESCRIPTION
TK-82	Coax Tool Kit with CTF-200 Compression Tool – Long Style
TK-83	Coax Tool Kit with CTF-300 Compression Tool – short style
TK-85	Coax Tool Kit with CT-200 Compression Tool – Universal

**Each Kit Contains:**

JONARD PART NO.	DESCRIPTION	TK-82	TK-83	TK-85
FL-2000	Flashlight	X	X	X
JIC-2288	High Leverage Diagonal Cutter	X	X	X
SD-61	Screwdriver 6-in-1	X	X	X
PT-300	Pocket Continuity Tester & Toner	X	X	X
TWAF-71630	Torque Wrench 7/16" 30 in./lb.	X	X	X
UST-125	Cable Stripper RG59/6 cable stop	X	X	X
H-85	Pouch	X	X	X
CT-200	Universal Compression Tool			X
CTF-200	Compression Tool–Long Style	X		
CTF-300	Compression Tool–Short Style		X	



TWAF-71630

SD-61

JIC-2288

FL-2000

UST-125

PT-300

H-85



CT-200

(for kit TK-85)



CTF-200

(for kit TK-82)



CTF-300

(for kit TK-83)



TK-21



UST-500

**NETWORK INSTALLATION SERVICE KIT**

The affordable and reliable punchdown tool kit that features six tools performing over 21 functions to complete any installation or repair.

Kit contains: EPD-914116 punchdown tool with 66 & 110 blades, UST-500 multipurpose Universal Cable Stripping Tool, ES-1964ERG Ergonomic Electrician Scissor, JIC-22035 Spudger, M-216CS22 Can Wrench with 22 AWG Wire Stripper, JIC-22148 multipurpose needle nose crimping plier with cutter and the H-1000 Cordura Pouch.

JONARD P/N	DESCRIPTION
TK-21	Network Installation Service Kit



JIC-22035



EPD-914116



1964-ERG



M-216CS22



JIC-22148



H-1000



TK-450M

**CATV/TELECOM INSTALLERS KIT**

Assembled in a convenient, easy to carry Cordura case, this kit contains the basic service tools essential for equipment installation, repairs and cable preparations. Whether it's Fiber Optic, Coax, or Copper this versatile kit contains the perfect tools for today's demanding technician. The TK-450M Kit is perfect for the VOIP installer, Fiber Technician or Communications Specialist and comes with Jonard's lifetime warranty.

Each Kit contains: ASW-716, CT-200, UST-500, ES-1964, KN-7, JIC-683, JIC-22148, JIC-22035, JIC-1626, JIC-750, TWAFF-71630, M-216CS22, SK-51632, TT-7V, SST-716, PT-300 & secured in a convenient easy to carry Cordura case.



UST-500



CT-200



KN-7



JIC-683



ES-1964



JIC-1626



JIC-750



ASW-716



JIC-22035



M-216CS22



SK-51632



JIC-22148



TT-7V



SST-716



PT-300



TWAFF-71630

JONARD P/N	DESCRIPTION
TK-450M	CATV/Telecom Installers Kit

ES-1964DS



**FREE-FALL ELECTRICIAN'S SCISSOR**

A Free-Fall Electrician's Scissor, designed for heavy duty use and loose enough to allow fingertip operation. Drop forged High Quality steel for greater durability. Notched to strip 18-20 and 22-24 AWG wire and one blade is serrated. A scraper and file are on the back of the blade.

JONARD P/N	DESCRIPTION
ES-1964DS	Free-Fall Electrician's Scissor

ES-1964



**ELECTRICIAN SCISSOR**

The Electrician Scissors are designed for heavy duty use. Made of high carbon steel with a special hardening process for greater durability and nickel plated for that professional look. Notched to strip 18-20 and 22-24 AWG wire and one blade is serrated. A scraper and file are on the back of the blade.

JONARD P/N	DESCRIPTION
ES-1964	Electrician Scissor

ES-1964ERG



**ERGONOMIC ELECTRICIAN SCISSOR**

These Ergonomic Electrician scissors are designed for heavy duty use. Made of high carbon steel with a special hardening process for greater durability and nickel plated for that professional look. Notched to strip 18-20 and 22-24 AWG wire and one blade is serrated. A scraper and file are on the back of the blade.

JONARD P/N	DESCRIPTION
ES-1964ERG	Ergonomic Electrician Scissor

KSS-1



**KNIFE & SCISSOR SHARPENER**

Sharpen knives and scissors with one convenient sharpener. Made of high-grade tungsten-carbide steel and diamond polished. Will restore the edge on either scissors or knives with 3-4 simple strokes. Safety finger guard, lightweight compact design makes this the ideal tool for all your sharpening needs.

JONARD P/N	DESCRIPTION
KSS-1	Knife & Scissor Sharpener

TK-400



**SPLICER'S KIT**

This compact kit contains an ergonomic splicers knife, scissor and leather pouch. The knife features a 1 3/4" tough, cutlery-steel blade and a non-slip handle. The scissors are made of high carbon steel with scraper and file on one side and 2 stripping notches on the other. Both items fit securely in the leather pouch which can be mounted on belts up to 2" wide.

JONARD P/N	DESCRIPTION
TK-400	3 Piece Splicer's Kit
H-40	Leather Pouch
KN-7	Ergonomic Cable Splicing Knife
ES-1964	Electrician Scissor



**ERGONOMIC FIBER OPTIC KEVLAR® CUTTER**

High carbon stainless steel blades designed to cut Kevlar®, cabling insulation, tape, cable ties and other material. Ergonomic dual component handles polypropylene and TPR for user comfort and durability. Adjustable joint screw under protective cap, serrated blades grip material, sharp and durable 6" long.

JONARD P/N	DESCRIPTION
JIC-186	Wire & Kevlar Cutting Shears
TK-325	JIC-186 Scissor & Pouch with Belt Clip
H-25	Pouch Only for JIC-186 or JIC-195



**HEAVY DUTY SCISSOR WITH WIRE STRIPPER**

Heavy duty multi-function scissor designed to cut copper, aluminum, leather, plastic and other materials. Not designed to cut stainless steel or other hardened/heat treated metals. Three stripping holes for 18, 14 & 12 AWG wire. One blade serrated for a secure grip and handles are dual component polypropylene and TPR. Includes safety locking mechanism and adjustment screw.

JONARD P/N	DESCRIPTION
JIC-183	Heavy Duty Scissor with Wire Stripper



**COMMUNICATION SCISSOR**

High carbon stainless steel blades, 1/4" notch for cutting & stripping, two stripping notches for 18 & 22 AWG wire, one serrated non-slip blade, dual component handle. High carbon stainless steel blades that are both sharp and durable with serrated blade that grips and holds the wire. Ergonomic dual component nylon & santoprene handles, for user comfort and durability. Designed with an adjustable joint screw under the protective cap.

JONARD P/N	DESCRIPTION
JIC-195	Communication Scissor



**CABLE SPLICING KNIFE**

The tough cutlery steel blade is extremely sharp and cuts easily through many types of insulation. It holds its edge with repeated use and features a non-slip easy grip handle for better control and reduced hand fatigue. Blade length is 1 3/4" and overall length is 6 1/4".

JONARD P/N	DESCRIPTION
KN-7	Cable Splicing Knife



**EPD SERIES PUNCHDOWN TOOLS**

Sleek ergonomic design for easy effective wire termination. Tested up to 100,000 cycles at high-impact setting. Use to properly set, seat and terminate wire. Simply position the wire, push tool, and listen for confirming pop. Wire is properly seated.

**Features include:**

- Hi/Low impact setting
- Combination Hook/Spudger stored in the chassis
- Color coded yellow on the CUT side
- Enlarged blade storage compartment
- Lifetime Warranty (Essentially means unlimited impacts)



JONARD PART NO.	DESCRIPTION
EPD-914	Punchdown Tool
EPD-91466	Punchdown Tool with 66 Blade
EPD-914110	Punchdown Tool with 110 Blade
EPD-914KR	Punchdown Tool with Krone Blade
EPD-914116	Punchdown Tool with Combination Blade 66 & 110
EPD-91461	Punchdown Tool with two Blades 66 & 110
EPD-9Krone	Punchdown Tool with the EPB-Krone Blade
EPD-914630	Punchdown Tool with 630 Modified Jack Blade

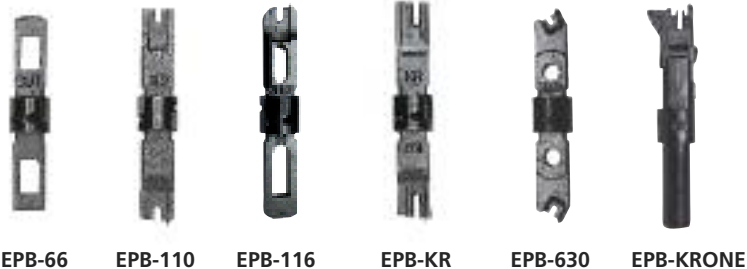

**EPB STANDARD DOUBLE-ENDED BLADES**

JONARD PART NO.	DESCRIPTION
EPB-66	66 Blade with & without cutter
EPB-110	110 Blade with & without cutter
EPB-116	Combination 66 & 110 blade
EPB-KR	Krone Blade with & without cutter
EPB-630	Blade for 630 Modified Jack
EPB-KRONE	Krone blade scissor style



**PUNCHDOWN TOOL KIT**

An ideal combination of tools for electrical technicians, main frame telecommunications professionals, security & alarm and datacom professionals. Kit includes: punchdown tool with 66 & 110 blades, Ergonomic Electrician scissor, LED Flashlight with zoom lens, spudger, multi-bit screwdriver, Cyclops wire & cable stripper, Combo crimper long nose plier and convenient pouch

**Kit contains:**

- CST-1i Cyclops UTP/STP Cable Stripper
- EPD-914 Punchdown Tool
- EPB-66 Punchdown 66 Blade with & without cutter
- EPB-110 Punchdown 110 Blade with & without cutter
- FL-2000 LED Flashlight with Zoom Lens
- JIC-22035 Probe Pick Spudger
- JIC-22148 Combo Crimper Long Nose Plier
- SD-61 6-In-1 Screwdriver
- H-75 Molded Pouch

JONARD P/N	DESCRIPTION
TK-17	Punchdown Tool Kit



EP-QTH38B

**TERMINATION & REMOVAL TOOL**

This tool is used for terminating, bridging, and removing wires from 2-beam or 3-beam, insulating-slicing, quick clip terminals found on QCM468 (MPC) and 391Q connectors and on Versablocks with quick-clip pins.

JONARD P/N	DESCRIPTION
EP-QTH38B	Termination & Removal Tool

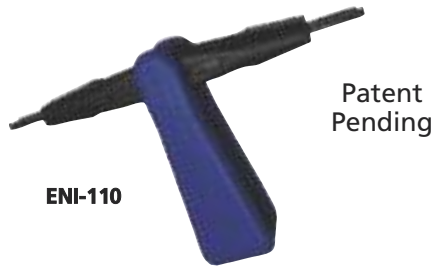

ENI-110

Patent Pending

**NON-IMPACT PUNCHDOWN TOOL**

A non-impact punchdown tool. Perfect for do-it-yourself small jobs on a 110 terminal block. Fits neatly in the palm of your hand. Quickly and easily switch from cutting and non-cutting blade side with one hand. Simple - Fast - Easy.

JONARD P/N	DESCRIPTION
ENI-110	Non-Impact Punchdown Tool

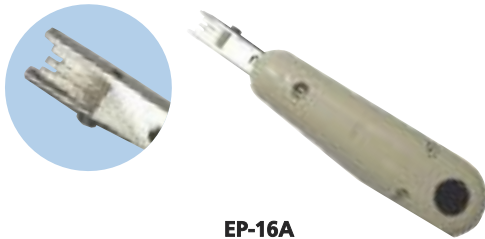

EP-16A

**BIX PUNCHDOWN TOOL**

This tool is designed to terminate cables, pigtailed, and jumper wires on all GigaBIX, BIX and UMOXS cross-connect system connectors. This single action, spring activated tool will terminate 22-26 AWG plastic insulated solid copper conductors. Button on the handle adjusts the tool for seating only, or for seating and cutting the conductors.

JONARD P/N	DESCRIPTION
EP-16A	BIX Punchdown Tool

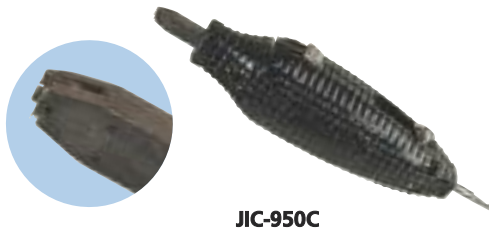

JIC-950C

**QUICK CLIP INSERTION TOOL**

This multipurpose wire insertion tool performs several vital functions. The wire cutter is designed to cut 22 & 24 gauge wire, the hook at the back of the tool is used for both jumper and back-tap removal, and the bit inserts 22 or 24 gauge (0.5 mm or 0.6 mm) wire into the terminal block. Ideal for wire insertion in 3-beam (112 type blocks) and 4 beam (78 type blocks) terminals in Cosmic and Cosmic II distributing frames.

JONARD P/N	DESCRIPTION
JIC-950C	Quick Clip Insertion Tool
JIC-955	JIC-950C Replacement Blade

**BATTERY PUNCHDOWN TOOL**



**PATENTED**

**Features:**

- Over 1,000 impacts between charges
- Dual action trigger for LED task lighting and impact
- Quick-easy blade lock and release
- 90° Blade orientation adjustment for any angled impact
- Hi/Low impact settings easily adjusted
- Powerful, lightweight 7.2V lithium ion battery
- Quick charge battery charger

**EPB-1000 ACCESSORIES**

JONARD PART NO.	DESCRIPTION
EPB-B	EPB-1000 Lithium Ion Battery
EPB-BC1	EPB-1000 115V Battery Charger
EPB-BC2	EPB-1000 230V Battery Charger

JONARD PART NO.	DESCRIPTION
EPB-1200	Punchdown Tool, Battery, 115V Charger (no blades included)
EPB-1066	Punchdown Tool, Battery, 115V Charger, 66 blade
EPB-1110	Punchdown Tool, Battery, 115V Charger, 110 blade
EPB-11066	Punchdown Tool, Battery, 115V Charger, 110 & 66 blades
EPB-1000KR	Punchdown Tool, Battery, 115V Charger, Krone blade
EPB-2200	Punchdown Tool, Battery, 230V Charger (no blades included)
EPB-2066	Punchdown Tool, Battery, 230V Charger, 66 blade
EPB-2110	Punchdown Tool, Battery, 230V Charger, 110 blade
EPB-211066	Punchdown Tool, Battery, 230V Charger, 110 & 66 blades
EPB-2000KR	Punchdown Tool, Battery, 230V Charger, Krone blade



Jonard Slotted, Phillips and Robertson Screwdrivers are made of special alloy steel for exceptional strength, long life and corrosion resistant. Soft rubber handles offer comfort and greater torque. The end of the handle is marked to identify the tool's size, and the tips are magnetic. Meets and exceeds applicable ASME/ANSI specifications.

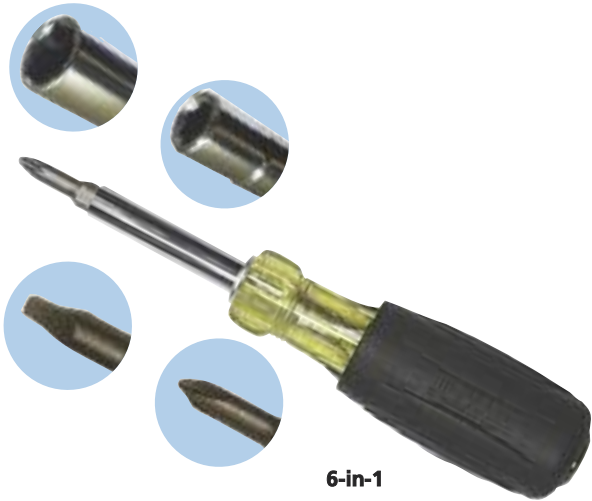

6-in-1

### 6-IN-1 SCREWDRIVER

The Jonard 6-in-1 Screwdrivers eliminate the need for multiple tools in your belt. This tool is configured to include: 2 bits with four heads and two nut drivers 5/16" & 1/4"

JONARD P/N	DESCRIPTION	BITS INCLUDE
SD-61	6-in-1 Screwdriver	SD-RB1, SD-RB2,
SD-1223	6-in-1 Robertson Screwdriver	SD-RB1, SD-RB3

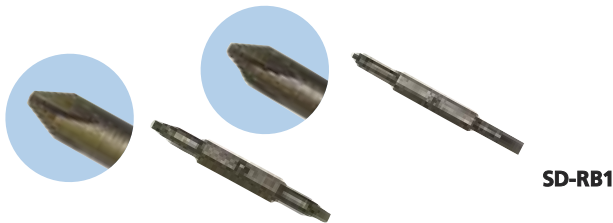

SD-RB1



SD-RB2

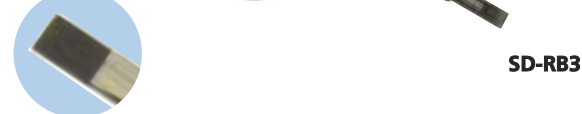

SD-RB3

### REPLACEMENT BITS

JONARD P/N	DESCRIPTION	OVERALL LENGTH	WEIGHT	SHAFT DIAMETER
SD-RB1	Replacement Bit Phillips #1 & Slot 3/16"	3"	0.42 oz	1/4" HEX
SD-RB2	Replacement Bit Phillips #2 & Slot 9/32"	3"	0.42 oz	5/16" HEX
SD-RB3	Replacement Bit Robertson S1 & S2	2 1/2"	0.78 oz	1/4" HEX



SDC-3136

### SLOTTED SCREWDRIVERS

SLOTTED P/N	DESCRIPTION	OVERALL LENGTH	WEIGHT
SDC-3163	Slotted 3/16" x 3"	6 3/4" (87mm)	1.6 oz
SDC-3166	Slotted 3/16" x 6"	9 3/4" (248mm)	2.4 oz
SDC-144	Slotted 1/4" x 4"	8 11/32" (212mm)	4.0 oz
SDC-3810	Slotted 3/8" x 10"	14 3/8" (365mm)	10.0 oz
SDC-5166	Slotted 5/16" x 6"	10 3/8" (264mm)	5.6 oz



SDP-1

### PHILLIPS

PHILLIPS P/N	DESCRIPTION	OVERALL LENGTH	WEIGHT
SDP-1	Phillips #1 x 3"	6 3/4" (171mm)	2.4 oz
SDP-2	Phillips #2 x 4"	8 5/16" (211mm)	4.0 oz
SDP-3	Phillips #3 x 6"	11" (279mm)	5.6 oz

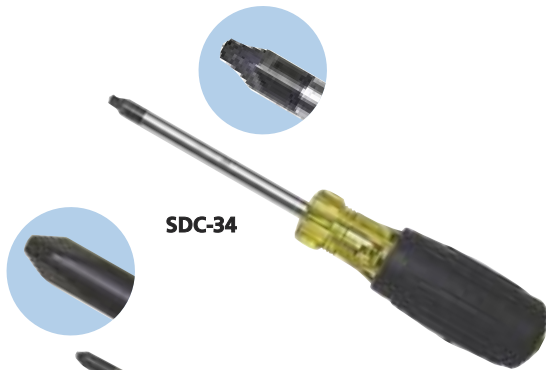

**SDC-34**



**SDSP-2**



**SDSC-14**



**SDK-8**

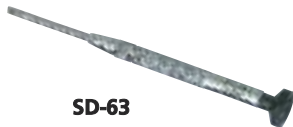

**SD-63**

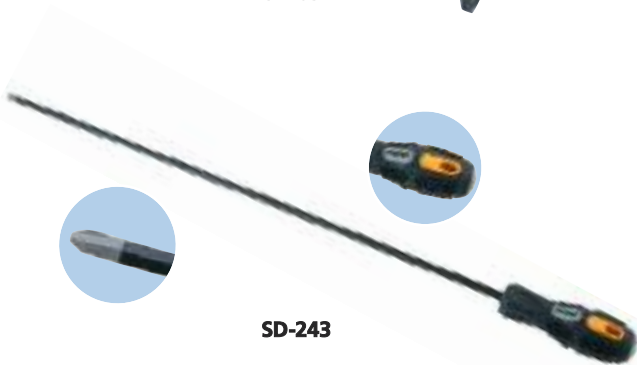

**SD-243**

**ROBERTSON SCREWDRIVERS**

JONARD P/N	DESCRIPTION	OVERALL LENGTH	WEIGHT
SDC-24	Robertson #2 x 4"	8 1/2" (216mm)	3.8 oz
SDC-34	Robertson #3 x 4"	8 1/2" (216mm)	3.8 oz

**STUBBY SCREWDRIVERS**

JONARD P/N	DESCRIPTION	OVERALL LENGTH	WEIGHT
SDSP-2	Phillips #2 Stubby	3 1/2" (89mm)	1.9 oz
SDSC-14	Slotted 1/4" Stubby	3 1/2" (89mm)	1.9 oz

**EIGHT PIECE SCREWDRIVER SET**

**KIT CONTAINS:**

- SDSP-2 Phillips #2 stubby
- SDP-1 Phillips #1 x 3"
- SDP-2 Phillips #2 x 4"
- SDP-3 Phillips #3 x 6"
- SDSC-14 Slotted 1/4" Stubby
- SDC-3163 Slotted 3/16" x 3"
- SDC-144 Slotted 1/4" x 4"
- SDC-5166 Slotted 5/16" x 6"

JONARD P/N	DESCRIPTION
SDK-8	8 Piece Screwdriver Set

**SCREWDRIVER, JEWELER'S TYPE**

Used to terminate the battery backup in the fiber ONT. Screwdriver has concaved swivel knob to fit the finger and hexagonal shape to prevent rolling. Solid blade made of high quality hardened tool steel. .100" blade width. 4" long.

JONARD P/N	DESCRIPTION
SD-63	Jeweler's Screwdriver

**24 INCH LONG #3 PHILLIPS HEAD SCREWDRIVER**

This 24" long #3 Phillips Head Screwdriver is designed for use when you need an extra long screwdriver to reach the diodes in back of the various rectifiers. Made of chrome vanadium steel with a matte finish and a custom ergonomic tri-color handle.

JONARD P/N	DESCRIPTION
SD-243	#3 Phillips Head Screwdriver 24" long

Jonard Insulated Tools are manufactured to IEC 60900 Standards for hazardous work environments. Our tools are tested to 10,000 VAC and rated for 1,000 VAC live use.



1000V  
IEC 60900



TK-70INS

JONARD P/N	DESCRIPTION
TK-70INS	7 Piece Insulated Screwdriver Set Screwdriver Set contains: 3 Philips, 4 Slotted as shown below

**INSULATED SCREWDRIVERS-  
SLOTTED HEAD**

JONARD P/N	DESCRIPTION
INS-475	3/32 X 3 Slotted Screwdriver
INS-4100	5/32 X 4 Slotted Screwdriver
INS-6150	1/4 X 6 Slotted Screwdriver
INS-8175	5/16 X 7 Slotted Screwdriver

**INSULATED SCREWDRIVERS-  
PHILLIPS HEAD**

JONARD P/N	DESCRIPTION
INS-180	#1 X 3 Phillips Screwdriver
INS-2100	#2 X 4 Phillips Screwdriver
INS-3150	#3 X 6 Phillips Screwdriver



TK-110INS

JONARD P/N	DESCRIPTION
TK-110INS	11 Piece Insulated Tool Kit Kit contains: 7 Screwdrivers in kit TK-70INS plus INP-1072, INP-2065, INP-3062 & INP- 4065

**INSULATED PLIERS**

JONARD P/N	DESCRIPTION
INP-2065	Long Nose Plier 6 1/2" Long
INP-3062	Diagonal Plier 6 1/4" Long
INP-1072	Lineman's Combo Plier 7 1/4" Long

**INSULATED WIRE STRIPPER**

JONARD P/N	DESCRIPTION
INP-4065	Wire Stripper 6 1/2" Long



TK-19

**SMARTPHONE & TABLET REPAIR TOOL KIT**

For opening and repairing all series of smartphones, tablets and many "i" series computers (iPhones & iPads). Kit contains all the tools you need to take apart these highly specialized electronic devices. Perfect for DIY repair jobs. Tools are neatly organized and labeled in a convenient storage case. This kit is also suitable for other repair work where fine tipped screwdrivers are required (this includes eyeglass repair).

**Kit contains:**

- Ergonomic Handle
- Thirteen 4mm bits:
- PH00, PH0, PH1
- SL1.5, SL2.0
- Torx: T4, T6, T8, T10
- Hex1.5, Hex2.0
- Pentalobe 0.8 & 1.2
- 2 Plastic Prying Tools
- Guitar Pick Opening Tool
- Suction Vacuum Opener
- SIM Eject Tool
- Tweezer

JONARD P/N	DESCRIPTION
TK-19	Smartphone & Tablet Repair Tool Kit

**ADJUSTABLE WRENCHES WITH EXTRA WIDE JAW**

All wrenches are made of chrome vanadium steel with a chrome plated finish. Wrenches are forged and heat treated for greater strength. Handles are covered with a red transparent plastic for user comfort. The knurl is precision formed and the operation is smooth and trouble free. For accurate adjustments use the metric or English scales on either side of the jaws.

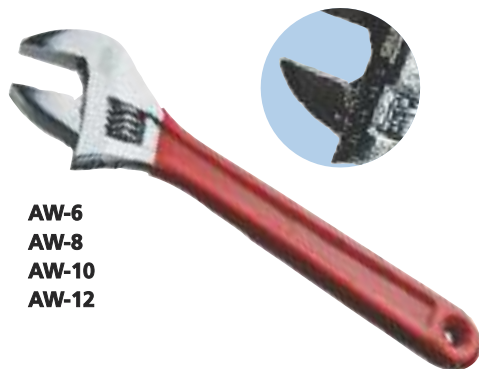

AW-6  
AW-8  
AW-10  
AW-12

JONARD PART NO.	DESCRIPTION	LENGTH	JAW CAPACITY	WEIGHT
AW-6	Adjustable Wrench 6"	6" (152 mm)	15/16" (24mm)	5.2 oz
AW-8	Adjustable Wrench 8"	8" (203mm)	1 1/8" (29mm)	10.6 oz
AW-10	Adjustable Wrench 10"	10" (254mm)	1 5/16" (33mm)	14.6 oz
AW-12	Adjustable Wrench 12"	12" (305 mm)	1 1/2" (38mm)	24.0 oz

**HOLLOW SHAFT NUT DRIVERS**

These are full length hollow shaft nut drivers intended for working with long bolts. They are designed with cushion gripped ergonomic color coded handles. Handles provide greater torque and user comfort. Overall length 7". ASME Standard/YR: B107.12-2004



ND-631

JONARD P/N	DESCRIPTION
ND-631	Nut Driver Set – 7 Piece 3/16", 1/4", 5/16", 11/32", 3/8", 7/16" & 1/2"
ND-630316	Nut Driver 3/16" (Black)
ND-63014	Nut Driver 1/4" (Red)
ND-630516	Nut Driver 5/16" (Yellow)
ND-6301132	Nut Driver 11/32" (Green)
ND-63038	Nut Driver 3/8" (Blue)
ND-630716	Nut Driver 7/16" (Brown)
ND-63012	Nut Driver 1/2" (Red)
ND-SET4	Nut Driver Set 4 piece, 1/2", 11/32", 3/8", 5/16"

**PANEL KNOCKOUT KIT—Patent Pending**

Remove panel knockouts without cutting holes in the drywall (For use on electrical, security, alarm, and datacom panels)



WBK-100

JONARD P/N	DESCRIPTION
WBK-100	Panel Knockout Kit





**PATENTED**

### MAGNETIC CABLE RETRIEVAL SYSTEM

A magnetic cable retrieval system which couples the cable with the pulling device through drywall, allowing the user complete control. Designed for both residential and commercial applications.

**MP-700 KIT INCLUDES:**

- Retriever Unit
- 3/4" Drop Magnet with pull line
- Jack Chain
- Convenient Carrying Case

**Magnepull by Jonard Industries**

JONARD P/N	DESCRIPTION
<b>MP-700</b>	Magnetic Cable Retrieval System
<b>MP-100</b>	1/2" Drop magnet with leader
<b>MP-210</b>	3/4" Drop Magnet with leader
<b>MP-220</b>	3/4" Drop Magnet without leader

**MP-700**



**MP-800**

### MAGNEPOT – Intelligent Reference Point Locator

Used to drill through exterior walls, drill from attics/basements into wall cavities, or drill on angles or corners. Also used to locate reference points in complicated construction and commercial buildings. Accurate to within 1/2" from 20" and within an inch up to 40". Kit includes: transmitter, receiver, two 9V batteries, tack adhesive, operating instructions and carrying case

JONARD P/N	DESCRIPTION
<b>MP-800</b>	Intelligent Reference Point Locator

### MAGNAMOLE MAGNETIC CABLE FISHING GUIDE

Wire Fishing Made Easy! Quickly threads wire and cable through cavity walls and void spaces. Threads at an angle and safely through other wire and cable obstacles. Saves time, saves money, and sharply reduces the risk of accidents.

- 44% TIME SAVINGS Six Sigma certified
- Dramatically reduces shock risk
- Easy to use- No experience required
- Diamond Award Winning Design

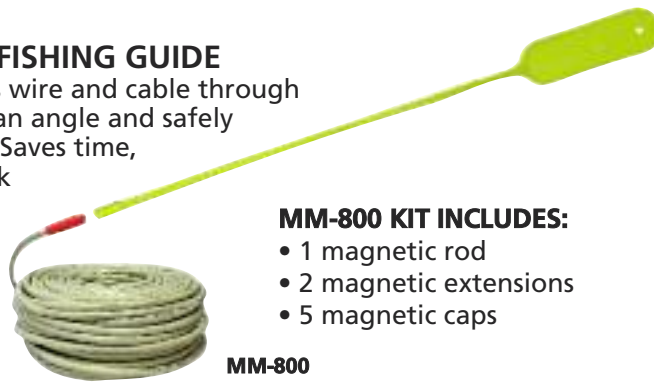

**MM-800**

**MM-800 KIT INCLUDES:**

- 1 magnetic rod
- 2 magnetic extensions
- 5 magnetic caps

**PATENTED**

JONARD P/N	DESCRIPTION	CAP COLOR & CABLE DIAMETER ACCOMMODATION	USED WITH THE FOLLOWING CABLE	QUANTITY
<b>MM-800</b>	Magnamole Magnetic Cable retrieval System			
<b>MM-110</b>	Replacement Magnets	(Red) .169" to .205" (Blue) .230" to .295	CAT5 RG6, RG6 TRI, RG6 QUAD	Includes 3 magnetic caps of each color
<b>MM-120</b>	Replacement Magnets	(White) .145" to .169" (Gray) .173" to .201" (Black) .205" to .232"	CAT3, 3.1mm Simplex fiber Optic Cable, CAT5, CAT5e RG59, 12AWG Romex	Includes 2 magnetic caps of each color





**TELESCOPIC POLE**

The RDT-18 is the perfect tool to install or retrieve a cable in drop ceilings or other hard to reach places. This Telescopic Pole is self-supporting, so it is perfectly suited for spanning ceilings and voids to route or retrieve cable.

The Jonard Industries RDT-18 Telescoping pole is constructed with a series of tapered tubes which interlock and extend a full 18 feet, collapsed length is only 33 inches. The pole is made from fiberglass with a polyester resin baked enamel coating for greater durability. The RDT-18 is considerably more rigid than rod or coil based products, and gives the installer far more control and greater accuracy over longer distances. The RDT-18 telescoping pole comes with two hooks. A conventional C type hook, an S hook to help grab and/or push cables, plus a special adapter for tight applications.

When not in use, the RDT-18 is compact and lightweight and is easily carried using the shoulder strap. Weights 2.44 lbs.

JONARD P/N	DESCRIPTION
<b>RDT-18</b>	Telescopic Pole



**MAGNETIC CABLE HOLDERS**

Made of neodymium (a rare earth magnet), these cable holders quickly and easily allow the technician to install cables without any drilling, screwing or nailing required. These powerful magnets can hold a substantial number of cables based on the size chosen. Hang wires in high places from the ground using a telescopic pole with the cable pole adapter. A Quick Easy Permanent installation that can easily be removed in seconds.

JONARD P/N	DESCRIPTION
<b>MF-1/25</b>	Magnetic Cable Holder 1" (pkg. of 25)
<b>MF-75/25</b>	Magnetic Cable Holder 3/4" (pkg. of 25)
<b>MF-5/25</b>	Magnetic Cable Holder 1/2" (pkg. of 25)
<b>MF-25/25</b>	Magnetic Cable Holder – for Zip ties & Velcro (pkg. of 25)
<b>MF-4</b>	Cable Pole Adapter



**GLOW ROD KIT**

Can extend a full 30 feet. These Rods glow in the dark to facilitate use in low lit areas. Designed to perform splinter free over the life of the product while also providing excellent flexibility. The luminescence of the rods is brighter and lasts longer than other similar products. The metal ends of the rods are glued and crimped to provide superior strength. The threads on the metal ends are standard 8-32 so the rods and accessories can be used with many other manufacturers glow rods.

The Jonard Industries RDG-30 Glow Rod Kit includes:

- Six 5 foot long Rods, 3/16" diameter, for greater flexibility
- Ball Chain attachment
- Eyelet
- Wisk
- Hook

The four piece replacement kit includes the eyelet, ball chain attachment, wisk & hook.

JONARD P/N	DESCRIPTION
<b>RDG-30</b>	Glow Rod Kit
<b>RDG-4</b>	Four Piece Replacement Kit





**CABLE SEWING NEEDLE-METAL**

Durable red anodized aluminum handle with curved notched sewing needle. Designed to harness or lace multiple lead bundles. 5 3/4" long. Replacement needles are also available.

JONARD P/N	DESCRIPTION
JIC-287	Cable Sewing Needle
RB-287/6	Pkg. of 6 Replacement Needles



**WIRE LOOP PULLER-METAL**

Durable red anodized aluminum handle facilitates pulling wire through terminal blocks, rings on main frame or fanning strip holes. JIC-2257M overall length is 8 1/2" and JIC-2257M-12 overall length is 15".

JONARD P/N	DESCRIPTION
JIC-2257M	Wire Loop Puller Overall Length 8 1/2" loop 4 1/2"
JIC-2257M-12	12" Wire Loop Puller Overall Length 15" loop 11"
RB-2257/6	Pkg. of 6 Replacement Loops for JIC-2257M only



**WIRE LOOP PULLER- INSULATED**

Xylan insulated wire loop puller facilitates pulling wire through terminal blocks, rings on main frame, or fanning strip holes. The yellow plastic lightweight handle fits snugly and is easy to hold in your hand. 8" long.

JONARD P/N	DESCRIPTION
JIC-2257	Wire Loop Puller



**CABLE SEWING NEEDLE-INSULATED**

Xylan insulated cable sewing needle has a yellow lightweight molded grip handle that will harness or lace multiple lead bundles. 5 1/2" long.

JONARD P/N	DESCRIPTION
JIC-3209	Cable Sewing Needle



**STRAIGHT METAL NEEDLE**

This "Chicago type" straight metal needle is designed for cable sewing. This tool, made of the finest steel is for anyone in the cable industry. Needle is .016" thick and 12" long.

JONARD P/N	DESCRIPTION
JIC-284	Straight Metal Needle



**COTTER PIN REMOVAL TOOL**

Used for removing cotter pins on automotive, materials handling, and all other types of mechanical equipment that employ cotter pin locking devices.

JONARD P/N	DESCRIPTION
CP-4284	Cotter Pin Removal Tool

**ADJUSTABLE PRECISION WIRE STRIPPERS OK-3907 SERIES**



The OK-3907 Series is the industry's leading cut-and-strip tool for copper interconnect applications. Installers and telecom technicians enjoy its rugged construction, ergonomic plastic grips, and high-leverage handle design, which allows time savings through the simultaneous cutting of multiple wires. Blades are made from specially tempered spring steel for clean, nick-free wire stripping.



JONARD P/N	Wire Size		Adjustable Strip-Off Length		Replacement Blade
	AWG	mm	Inches	mm	
OK-3907-2224	22-24	0.65-0.50	1-1/2" to 1-3/4"	38.10 to 44.45	SB-2224
OK-3907-2426	24-26	0.50-0.40	1-1/2" to 1-3/4"	38.10 to 44.45	SB-2426
OK-3907-2830	28-30	0.32-0.25	7/8" to 1 1/8"	22.22 to 28.57	SB-2830
JIC-4473*	22-24	0.65-0.50	1-1/2" to 1-3/4"	38.10 to 44.45	SB-2224

\* Supplied with 2 blades, SB-2224 and SB-2426

**WIRE CUT-AND-STRIP TOOLS ST-100 SERIES**



A revolutionary concept for easy and clean stripping of wires for wire wrapping, electronic and appliance applications. Biomechanically designed for maximum efficiency. Easy to operate... place wire (up to 4) in stripping slot with ends extending beyond cutter blades... press tool and pull... wire is cut and stripped to proper "wire wrapping" length. The hardened steel cutting blades and sturdy construction of the tool ensure long life. Strip length easily adjustable for your application. Blades are made from specially tempered spring steel for clean, nick-free wire stripping.

JONARD P/N	Wire Size		Adjustable Strip-Off Length		Replacement Blade
	AWG	mm	Inches	mm	
ST-100	22-24	0.65-0.50	1 5/16" to 1 9/16"	33.33 to 39.68	SB-2224
ST-100-2426	24-26	0.50-0.40	1 15/16" to 1 11/16"	39.68 to 42.86	SB-2426
ST-100-2830	28-30	0.32-0.25	7/8" to 1 1/8"	22.22 to 28.57	SB-2830



**CABLE RING TOOL**

This cable ring tool is designed to cut/strip the outer jacket (sheath) of many types of cables where the jackets are made from plastic, fabric or rubber. The tool accommodates cable diameters from 3/16" (3.1mm) to 1/2" (12.7mm) cables. It can also accommodate larger diameter cables with thinner wall jackets up to 1" (25.4mm) in diameter. Designed with a metal slide, which allows you to put more or less tension on the cable.

JONARD P/N	DESCRIPTION
JIC-2060	Cable Ring Tool
RB-2060/6	Pkg. of 6 Replacement Blades



**OPTICAL FIBER CABLE SHEATH STRIPPER & RING TOOL**

This Cable Sheath Stripper is used to ring-cut many types of tight buffer, loose tube buffer, breakout cables and other types of jacketed fiber cables. A slitting blade is built into the tool and can be used to slit open the cable sheath if needed. Depth of the cut has two adjustments for .018" or .031" thick plastic, rubber or fabric insulation, and can handle cable diameters from 1/8" to 3/8". One spare blade of each style is included with the tool. Also known as CT2860.

JONARD P/N	DESCRIPTION
JIC-4366	Optical Fiber Sheath Stripper & Ring Tool
RB-2060/6	Pkg. of 6 Replacement Blades for ring feature of tool
RB-2878/6	Pkg. 6 replacement blades for stripper feature of tool



CST-1i

**PATENTED**

**CYCLOPS UTP/STP CABLE STRIPPER**

Fast easy removal of outer insulation from all unshielded twisted pair, shielded twisted pair and multicore cables. The Cyclops features a self-adjusting blade and is perfect for PVC and plenum type insulation, plus other materials without damaging the inner braids, foils or conductors. Cable performance is not impacted using this cable stripper.

JONARD P/N	DESCRIPTION
CST-1i	Cyclops Cable Stripper



CST-1900

CST-7915

**PATENTED**

**ROUND CABLE STRIPPER**

The CST-1900 is designed for fast and precise jacket removal of PVC, rubber, PE and other jacket materials, and works well on round cables with diameters ranging from 3/16" to 1-1/8" (4.5-29 mm). This is a Triple Action Tool, cutting longitudinally for end stripping, spiral for end stripping and mid-span cuts, and circular for jacket removal. A simple versatile easy to use tool your customers will love. The Replaceable Cutting Blade is spring loaded, adjustable for various cable diameters, provides a 90° blade rotation and is designed for long life.

JONARD P/N	DESCRIPTION
CST-1900	Round Cable Stripper
CST-7915	Replaceable Cutting Blade



FOD-2000

**PATENTED**

**FIBER OPTIC DROP CABLE SLITTER**

The FOD-2000 Fiber Optic Drop Cable Slitter is a Patented tool that simplifies the slitting of drop cable jackets at the end of the cable or mid-span. Designed for .250" flat drop cable. The FOD-2000 puts a slit on both sides of the jacket allowing easy access to the fiber or strength member. The ease of use makes this tool truly unique. To use just position the tool around the cable, pull and slit. A simple solution for a vital task. The FOD-2000 comes completely assembled with two blades, which can be reversed once the blades are worn.

JONARD P/N	DESCRIPTION
FOD-2000	Fiber Optic Drop Cable Slitter
FOD-RB25	Replacement Blades 25/pk

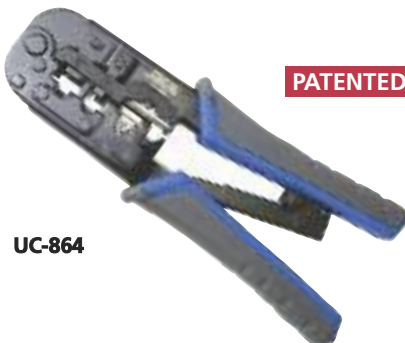

UC-864

**PATENTED**

**MODULAR CRIMPING TOOL**

This is a modular crimping/stripping connector tool for voice and data applications. Designed to cut, strip 6mm & 12 mm lengths and crimp paired conductor cables (round STP/UTP and flat satin phone cables). Crimps 4,6 & 8 position modular connectors (RJ22, RJ11, RJ12 & RJ45).

JONARD P/N	DESCRIPTION
UC-864	Modular Crimping tool 6 in 1





**CSR-1575**

**CABLE SLIT AND RING TOOL**

The CSR-1575 is designed to slit and ring UTP, STP, Coax and other cables, buffer tubes and Jackets on fiber optic cables up to 7.5mm (0.3”) in diameter. The tool features an easily adjustable slit blade and ring blade for nick-free strips. The removable/ reversible V block accommodates smaller and larger diameter cables.

JONARD P/N	DESCRIPTION
<b>CSR-1575</b>	Cable Slit and Ring Tool
<b>CSR-2</b>	Replacement Blades – set of 2

**WIRE STRIPPER AND CUTTER**



**JIC-1022**

The JIC-1022 Wire Stripper and Cutter is designed to strip and cut the most commonly used stranded and solid wire gauges 10 to 22 AWG and 1.6-3 mm fiber jackets. The JIC-1626 Wire Stripper and Cutter is designed for 16 to 26 AWG wire. The JIC-2030 Wire Stripper and Cutter is designed for 20-30 AWG wire. Other features include a coil spring opening to reduce fatigue, wire looping, bending holes conveniently located, black oxide finish, locking mechanism, and cutting surfaces that are hardened, tempered and ground for superior performance. 6 3/4” long and weighing just 4.5 ounces.

Part No.	Description
<b>JIC-1022</b>	Wire Stripper and Cutter 10-22 AWG
<b>JIC-1626</b>	Wire Stripper and Cutter 16-26 AWG
<b>JIC-2030</b>	Wire Stripper and Cutter 20-30 AWG

**ADJUSTABLE PRECISION WIRE STRIPPERS**

These Precision Wire Strippers feature an adjustment dial that allows the operator to select one of six different settings. A calibrated wire stop can then be adjusted for the desired insulation strip length. In a single motion, the operator squeezes and pulls the tool. This action engages four specially hardened blades to cleanly cut the wire insulation while the pulling motion breaks the insulation / conductor bond.



**ST-500**

**ST-500ESD**

- Adjustable to six wire gauges:  
ST-450 26 to 36 AWG (0.40 to 0.12mm)  
ST-500 20 to 30 AWG (0.80 to 0.25mm)  
ST-500ESD 20 to 30 AWG (0.80 to 0.25mm)  
ST-550 18 to 28 AWG (1.00 to 0.30mm)
- Calibrated Wire Stop adjustable to 2” (50.8mm)
- Clean, precise strip of any insulation type
- Lightweight-weighs 1 oz.
- Blade is hardened steel (RC58)
- Dimensions 3.9” x 1.6” x 0.6” (99 mm x 42 mm x 14 mm)

Part No.	ST-450	ST-500	ST-500ESD For ESD Use	ST-550
Wire Gauge	26-36 AWG 0.40 to 0.12mm	20-30 AWG 0.80 to 0.25mm	20-30 AWG 0.80 to 0.25mm	18-28 AWG 1.00 to 0.30mm
Housing Material	ABS	ABS	ESD Safe Polycarbonate	ABS





UST-500



UST-205



UST-215



UST-210



UST-225



UST-100



UST-150



UST-1596



UST-175



UST-220

**UNIVERSAL CABLE STRIPPING TOOL**

Use for Coax, Round Network Cables and Flat Cables - This versatile tool is five tools in one. Simply reverse the blade for RG59/6 & 7/11 Coax Cables. Insert the Round Cable into the second hole (adjustable) for a fast and easy strip. Will strip CAT6 cables with outside diameter up to 0.250". The third hole is for cutting all styles of cable while the fourth hole is designed for Flat Cable and 4P/6P style cable. The perfect wire stripper for most stripping applications. Includes Velcro strip for holding back the braided shield of the cable.

JONARD P/N	DESCRIPTION	BLADE INCLUDED
UST-500	Coaxial Cable Stripper (RG59/6 & 7/11)	UST-205
UST-525	Coaxial Cable Stripper with cable stop	UST-225
UST-596	Universal Cable Stripping Tool (59/6)	UST-210
<b>REPLACEMENT BLADES</b>		
UST-205	Repl Blade for RG59/6 & 7/11	
UST-210	Repl Twin Blade RG59/6 with Cable Stop.	
UST-215	Repl Blade for RG59/6 with Cable Stop & Untwisted Pair	
UST-220	Repl Blade for UST-175 Mini-coax only	
UST-225	Repl Blade for RG59/6 & RG7/11 with Cable Stop	

**COAXIAL CABLE STRIPPER TOOL**

The UST 100 Series strips a multitude of cables. Virtually all the blades are interchangeable with the exception of the UST-220. This blade is matched exclusively to the UST-175 handle. For replacement blades or complete tools see table above. Includes Velcro strip for holding back the braided shield of the cable.

JONARD P/N	DESCRIPTION	BLADE INCLUDED
UST-100	Coaxial Cable Stripper (RG59/6 & 7/11)	UST-205
UST-125	Coaxial Cable Stripper with UST-225 Blade	UST-225
UST-150	Coaxial Cable Stripper with UST-215 Blade	UST-215
UST-175	Mini-Coaxial Cable Stripper	UST-220
UST-1596	Coaxial Cable Stripper (59/6) w/Twin Blade	UST-210

**MINI-COAX CABLE STRIPPER**

The UST-175 is a three level coax stripper for mini-coax cables (CommScope73508, Belden 735A1 and similar cables). The mini strips 0.625" of the outer jacket in the first level, the second level strips the braid exposing 0.156" of dielectric, and the third level strips the dielectric exposing 0.156" of the 26 AWG center conductor. Includes Velcro strip for holding back the braided shield of the cable.

JONARD P/N	DESCRIPTION
UST-175	Mini-Coax Cable Stripper
UST-220	Replacement Blade for the UST-175



UL Listed

**KYNAR® Insulated, Silver Plated Copper Conductor**

Ideally suited for wire wrapping and many other applications. OFHC (oxygen free high conductivity) provides a flexible yet abrasion resistant wire

Wire Size		Insulation Dia.		Roll Size		Blue	Yellow	White	Black	Red	Green
AWG	mm	In.	mm	Feet	Meters						
24	0.50	.030	0.76	100	30.4	R24B-0100	R24Y-0100	R24W-0100	R24BLK-0100	R24R-0100	
26	0.40	.027	0.69	100	30.4	R26B-0100	R26Y-0100	R26W-0100	R26BLK-0100	R26R-0100	
28	0.32	.024	0.60	100	30.4	R28B-0100	R28Y-0100	R28W-0100	R28BLK-0100	R28R-0100	
30	0.25	.020	0.50	100	30.4	R30B-0100	R30Y-0100	R30W-0100	R30BLK-0100	R30R-0100	R30G-0100
				1000	304.4	R30B-1000	R30Y-1000	R30W-1000	R30BLK-1000	R30R-1000	R30G-1000

**KSW Wire Wrapping Wire Rolls for Cut/Strip/Wrap Applications**

Low strip force Kynar® insulated silver plated copper conductor wire is further processed to provide a low strip force for use with CSW bits and sleeves. Ideally suited for wire wrapping and many other applications. OFHC (oxygen free high conductivity) provides a flexible yet abrasion resistant wire

Wire Size		Insulation Dia.		Roll Size		Blue	Yellow	White	Black	Red	Green
AWG	mm	In.	mm	Feet	Meters						
24	0.50	.030	0.76	100	30.4	KSW 24B-0100	KSW 24Y-0100	KSW 24W-0100	KSW 24BLK-0100	KSW 24R-0100	
26	0.40	.027	0.69	100	30.4	KSW 26B-0100	KSW 26Y-0100	KSW 26W-0100	KSW 26BLK-0100	KSW 26R-0100	
28	0.32	.024	0.60	100	30.4	KSW 28B-0100	KSW 28Y-0100	KSW 28W-0100	KSW 28BLK-0100	KSW 28R-0100	
30	0.25	.020	0.50	100	30.4	KSW 30B-0100	KSW 30Y-0100	KSW 30W-0100	KSW 30BLK-0100	KSW 30R-0100	KSW-30G-0100
				1000	304.0	KSW 30B-1000	KSW 30Y-1000	KSW 30W-1000	KSW 30BLK-1000	KSW 30R-1000	KSW-30G-0000

**Wire Dispenser - WD-30 Series**

- With 50ft. (15.2m) Roll of 30 AWG (0.25mm) Kynar® wire-wrapping wire
- Built-in Plunger cuts wire to desired length
- Built-in Stripper strips 1" (25.4mm) of insulation
- Refillable



WD-30-B



R-30R-0050

**Replacement Rolls of Wire For WD-30 Series**

Wire for wire-wrapping. 30 AWG (0.25mm) Kynar® wire, 50ft. (15.2m) roll, silver plated, solid conductor easy stripping.

Part No.	Description
R-30B-0050	30 AWG (0.25mm) Blue 50ft. for WD-30-B
R-30Y-0050	30 AWG (0.25mm) Yellow 50ft. for WD-30-Y
R-30W-0050	30 AWG (0.25mm) White 50ft. for WD-30-W
R-30R-0050	30 AWG (0.25mm) Red 50ft. for WD-30-R
R-30-TRI	30 AWG (0.25mm) Red, White, Blue 50ft (15.2m) roll, each color for WD-30-TRI

Part No.	Description
WD-30-B	Dispenser with 50' of Blue wire
WD-30-Y	Dispenser with 50' of Yellow wire
WD-30-W	Dispenser with 50' of White wire
WD-30-R	Dispenser with 50' of Red wire
WD-30-TRI	Dispenser with 50' each Blue, White and Red wire

**Pre-Cut and Pre-Stripped Wire Wrapping Wire**

- 50 pieces per package
- Kynar® insulated
- Silver plated copper conductor
- UL listed
- 1" of stripped wire on either end
- Add 2" to the insulation length (see chart below) for total length of wire



**30 AWG (0.25mm) Pre-Cut/Pre-Stripped Wire 50 Pieces/Pkg.**

Insulation Length						
	In.	mm	White	Yellow	Blue	Red
1	25		30-W-50-010	30-Y-50-010	30-B-50-010	30-R-50-010
2	51		30-W-50-020	30-Y-50-020	30-B-50-020	30-R-50-020
3	76		30-W-50-030	30-Y-50-030	30-B-50-030	30-R-50-030
5	127		30-W-50-050	30-Y-50-050	30-B-50-050	30-R-50-050



KA-260

**CONNECTOR INSERTION AND EXTRACTION TOOLS**

These tools service virtually all connectors conforming to Mil-C-26482, Mil-C-26500 with front release contacts made by such manufacturers as Amp, Amphenol, Bendix, Burndy, Cannon, Cinch, Continental, Elco, Flight, Pyle National and Deutsch. These tools contain strong, durable, stainless steel probes & color coded handles.

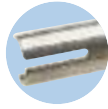

A-4598



A-4599



A-4600

JONARD P/N	MILITARY STANDARD (MS)	COLOR CODE	CONTACT SIZE	DIA
A-4598	MS24256-A20	RED	20	0.040"
A-4599	MS24256-A16	BLUE	16	0.063"
A-4600	MS24256-A12	YELLOW	12	0.093"
<b>KA-260 Insertion Tool Kit (contains above 3 tools) in leather case</b>				



KR-260



R-4601



R-4602



R-9461

JONARD P/N	MILITARY STANDARD (MS)	COLOR CODE	CONTACT SIZE	DIA
R-4601	MS24256-R20	RED	20	0.040"
R-4602	MS24256-R16	BLUE	16	0.063"
R-9461	MS24256-R12	YELLOW	12	0.093"
<b>KR-260 Removal Tool Kit (contains above 3 tools) in leather case</b>				



AR-910672

**CONTACT INSERTION-EXTRACTION TOOL**

A pin & socket insertion & extraction tool for contact size 20. Tool constructed of brass and ABS plastic with the red side for insertion and the white side for extraction. Mil standard M81969/1-02.

For use on TE Connectivity Amplimite series HDP-20 plugs and pins and other similar manufacturers products.

Use with:  
 215712-1 Plug 15 POS Crimp Snap  
 215711-1 Plug 9 POS Crimp Snap  
 1218266-1 Pin 18 AWG Gold Crimp  
 194081-1 Pin 1.04mm without Louver Band  
 205089-2 D-sub Pin 20-24 AWG Crimp

JONARD P/N	DESCRIPTION
AR-910672	Contact Insertion-Extraction Tool



R-5926

**PIN EXTRACTOR**

A plunger style pin extractor for pushing pins out from behind the connector blocks for contact sizes 16-20. 3" long.

JONARD P/N	DESCRIPTION
R-5926	Pin Extractor



S-339

**LAMP EXTRACTOR**

Mechanical type extractor used to remove or insert miniature lamps with bayonet type bases in panels and switchboards by firmly and gently grasping lamps. Grasp lever includes a return spring for fast lamp insertion and removal. Lamp grasp is limited to 5/16" to prevent shorts. Handle diameter 1/2". 4" long.

JONARD P/N	DESCRIPTION
S-339	Lamp Extractor

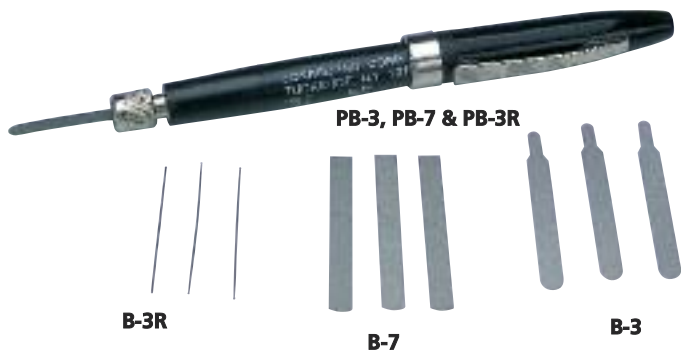

**PB-3, PB-7 & PB-3R**

**B-3R**

**B-7**

**B-3**

**POCKET TYPE BURNISHERS**

Adjustment of flexible blade-length and rigidity - is possible by varying depth in chuck. Supplied with replaceable blades stored in pen barrel at other end. Plastic barrel and cap made of sturdy plastic for dielectric work. Length 4 1/2", diameter 3/8". Blades are 3/16" Wide x 1 1/2" long. Rods are .020" diameter x 1 1/4" long.

JONARD P/N	DESCRIPTION
<b>PB-3</b>	Pen With 6 Blades .0035" Thick
<b>PB-3R</b>	PB-3 plus 6 abrasive rods .020"
<b>PB-7</b>	Pen With 6 Blades, .007" thick
<b>B-3/25</b>	Pkg. 25 Replacement Blades for PB-3 (.0035")
<b>B-3R/25</b>	Pkg. 25 Replacement Rods for PB-3R (.020")
<b>B-7/25</b>	Pkg. 25 Replacement Blades for PB-7 (.007")



**K-234**



**D-200, D-300, D-400**

**DIAMOND BURNISHERS**

These diamond contact burnishing spatulas consist of uniform abrasive diamond particles, set in a special metal for precise effective cleaning, polishing and burnishing with minimum pressure, so very little metal is removed. Diamond face 1" x 1/4". Total length 6".

- D-200 Coarse (grit for rapid cleaning),**  
.019" Thick, two diamond faces, green shaft.
- D-300 Medium (grit for intermediate size contacts),**  
.017" Thick, two diamond faces, red shaft.
- D-400 Fine (grit for small sensitive contacts),**  
.011" Thick, single diamond face, blue shaft.
- K-234,** Three assorted spatulas in a leather case.

JONARD P/N	DESCRIPTION
<b>D-200</b>	Diamond Burnisher Coarse
<b>D-300</b>	Diamond Burnisher Medium
<b>D-400</b>	Diamond Burnisher Fine
<b>K-234</b>	Diamond Burnisher Assortment Kit

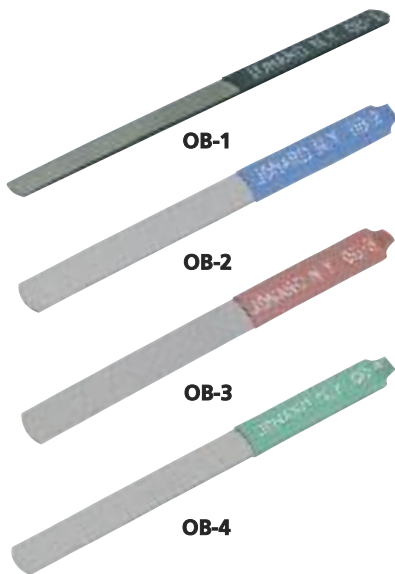

**OB-1**

**OB-2**

**OB-3**

**OB-4**

**CONTACT BURNISHERS**

Plastic insulated handles for working on live contacts. Available in four styles for fine, extra sensitive, general purpose and industrial use.

JONARD P/N	DESCRIPTION
<b>OB-1/3</b>	<b>For Fine Contacts.</b> Black handle 3/16" wide, .007" thick. 3" long, Package of 3
<b>OB-1/12</b>	<b>For Fine Contacts.</b> Black handle 3/16" wide, .007" thick. 3" long, Package of 12
<b>OB-2/12</b>	<b>For Extra Sensitive Points.</b> Blue handle. 1/4" wide, .007" thick. 3" long, Package of 12
<b>OB-3/12</b>	<b>For General Purpose Contacts.</b> Red handle. 1/4" wide, .010" thick. 3" long, Package of 12
<b>OB-4/12</b>	<b>For Industrial Use.</b> Green handle. 1/4" wide. .020" thick 3" long, Package of 12



Used for inserting, removing and adjusting fine springs and other small parts in tight areas. Indispensable for precision work in production and maintenance of precision products, electronics, electromechanics and even maintenance jobs. All spring hooks are tapered to a fine point. Produced of the finest quality high carbon steel with a nickel-plated finish. We will custom design Spring Hooks to meet your specific requirements.

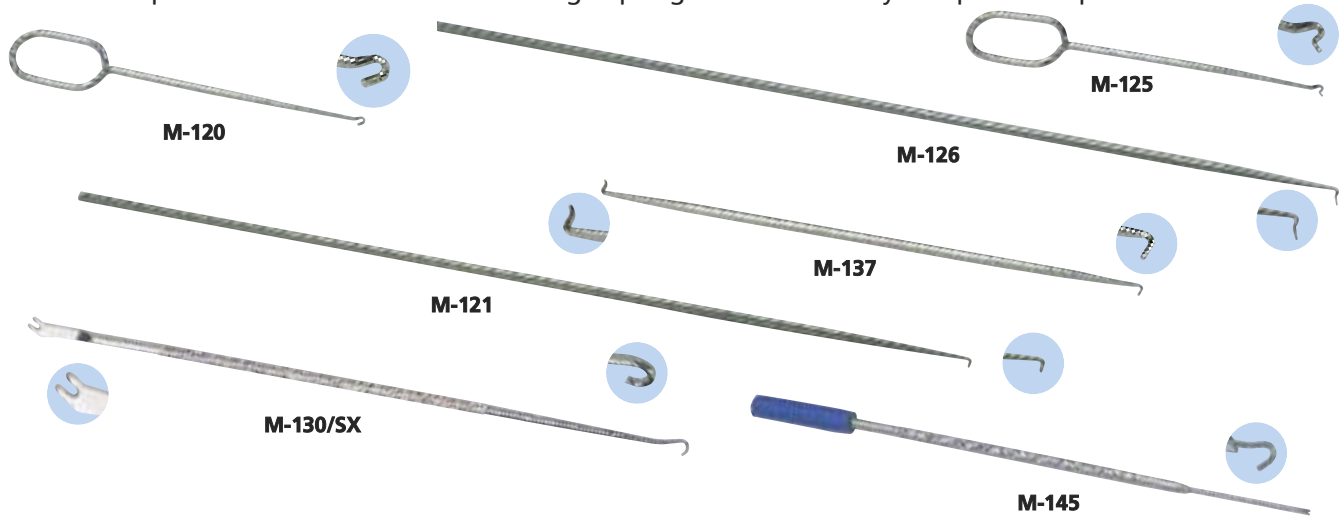

**M-120** Pull Hook with looped handle for maximum control 6" long.  
**M-121** Pull Hook for difficult to reach areas, 11" long.  
**M-125** Push Hook with looped handle for maximum control 6" long.

**M-126** Push Hook for difficult to reach areas, 11" long.  
**M-130/SX** Pull Hook and lifter. With a knurled grip. 8" long.  
**M-137** Push & Pull 2 sided Hook, 7" long.

**M-145** Captive Spring Hook. Spring loaded hook is exposed by depressing plunger on top of tool. Internal spring retracts hook automatically. This hook is ideal for capturing small wires, springs or parts and holding them. 7" long.

JONARD P/N	DESCRIPTION
M-120	Pull Hook
M-121	Pull Hook
M-125	Push Hook

JONARD P/N	DESCRIPTION
M-126	Push Hook
M-130/SX	Pull Hook

JONARD P/N	DESCRIPTION
M-137	Push & Pull Hook
M-145	Captive Spring Hook



**CLIP SETTER**  
 Clip Setter used for setting and withdrawing E and C clips with a inside diameter of .156" min. and thickness of .025" min. Max inside diameter of 3" and thickness of .093" One end of this tool has a hook with leaf spring tension for removing the clip. Other end of tool has leaf spring for holding clip in position to insert. Narrow shape allows access to confined places. This tool is 6 3/4" long .275" wide and 1/16" thick.

JONARD P/N	DESCRIPTION
CS-1022	Clip Setter



**T KEY TOOL**  
*Pay telephone Tool*  
 The key is used to release the housing and door locking mechanism of the no. 1A type coin telephone sets 2 1/2" long.

JONARD P/N	DESCRIPTION
JIC-719A	T Key Tool



**COIN LEVELING TOOL**  
*Pay telephone Tool*  
 Tool used for leveling coins in coin collectors when the coin receptacle becomes so full as to interfere with operation of the collector. May also be used to measure the degree of fullness by means of a calibrated scale and metal slider. 7" long.

JONARD P/N	DESCRIPTION
JIC-139B	Coin Leveling Tool



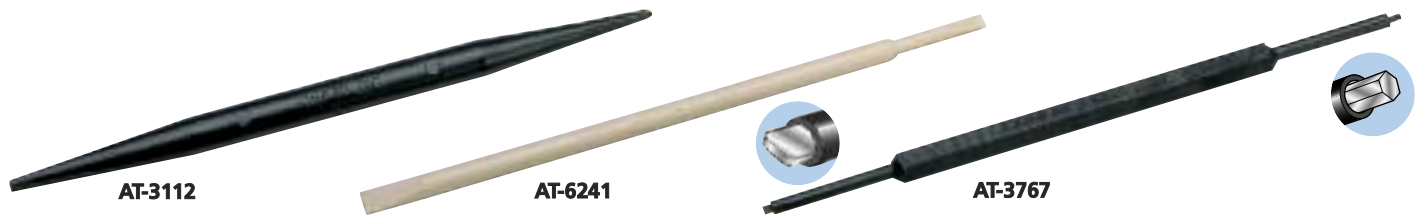

**SPUDGER**

Plastic pencil type tool tapered to a point on one end and screwdriver tip on other end. Used to form, shape, guide, spudge and separate fine computer wire terminals, telephone wires and cables. Also used for breaking solder bridges, probing or positioning loose components. Made of a high impact non-conductive thermoplastic material. 6" long double ended 5/16" diameter.

JONARD P/N	DESCRIPTION
AT-3112/10	Spudger

**ALIGNMENT TOOL**

2-in1 nonconductive Alignment Tool 1/4" in diameter, stepped down to 5/32" in diameter. Ideal for most variable capacitors, coils and resistors. Also used to harness and separate fine wire terminals in computers, telephones and cables. Made of non-conductive thermoplastic material. 7" long.

JONARD P/N	DESCRIPTION
AT-6241/10	Alignment Tool

**TRIMPOT**

Double ended Trimpot with a hex (allen) steel .050" and 3/32" long steel screwdriver tip. Ideal for aligning, adjusting, calibrating and fine tuning of electronic circuitry, potentiometers, oscilloscopes and electronic equipment. Made of a high impact non-conductive thermoplastic material. 5" long.

JONARD P/N	DESCRIPTION
AT-3767/10	Trimpot

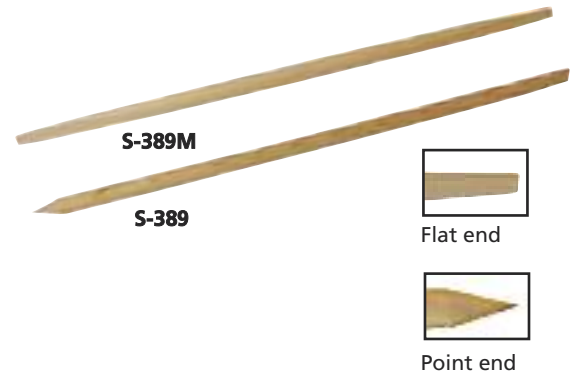
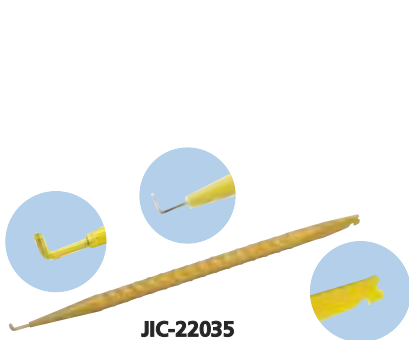

**PROBE PICK**

Tough resilient yellow nylon probe "spudger". One end is tapered to a 1/16" diameter point having an insulated "L" shaped wire hook extension. The other end tapers to a flat, 3/16" wide and 1/16" thick, with 2 small notches. Used in electrical contacts. 7" long.

JONARD P/N	DESCRIPTION
JIC-22035	Insulated Probe Pick
JIC-22035NT	Uninsulated Probe Pick

**ALIGNMENT TOOL KIT**

This 5 piece pocket kit contains a selection of the most popular non-conductive tools for aligning and adjusting components.

AT-3767 Trimpot, AT-6241 Alignment Tool, AT-3112 Spudger, S-389 Orange Stick, JIC-22035 Probe Pick

JONARD P/N	DESCRIPTION
TK-AT5	Alignment Tool Kit

**ORANGE STICKS**

Static free double ended economical tool made of birch wood. Used for cleaning electrical components and separating contact points, fine wires and other delicate components. 3/16" diameter x 7" long. The S-389 has one end tapered to a point and the other end to a flat screwdriver type tip. The S-389M has both ends tapered with a flat screwdriver type tip.

JONARD P/N	DESCRIPTION
S-389/10	Orange Sticks Point & Flat end Pk. of 10
S-389/100	Orange Sticks Point & Flat end Pk. of 100
S-389M/10	Orange Sticks 2 Flat ends Pk. of 10
S-389M/100	Orange Sticks 2 Flat ends Pk. of 100

Jonard force gauges are all ergonomically designed and have become the industry standard for measuring force. Our 3 different lines of force gauges are used by a multitude of industries and these gauges are being used in over 1000 different applications for measuring, calibrating, standardizing, testing and evaluating.

Measurement is extremely simple. Just place point of gauge arm perpendicular to the force to be measured. Reading can be taken in both directions - clockwise and counter-clockwise. Gauges offer extreme precision and durability. The measuring springs are made of hard tempered annealed beryllium copper. All gauges equipped with maximum reading pointer.



**Large Gauges**  
(Round Tip, Dial Diameter 2 1/2")

JONARD PART NO.	RANGE IN GRAMS	GRADUATION IN GRAMS	ACCURACY
GD-50	60-500	20.00	± 20
GD-100	150-1000	25.00	± 25
GD-200	300-2000	50.00	± 50
GD-400	700-4000	100.00	± 100



**Small Gauges**  
(Flat Tip, Dial Diameter 1 1/2")

JONARD PART NO.	RANGE IN GRAMS	GRADUATION IN GRAMS	ACCURACY
GD-1	0-10	.20	± .20
GD-3	5-35	1.00	± 1
GD-5	10-50	1.00	± 1
GD-10	20-100	2.00	± 2
GD-15	50-150	5.00	± 5
GD-25	50-250	10.00	± 10
GD-30	40-350	10.00	± 10

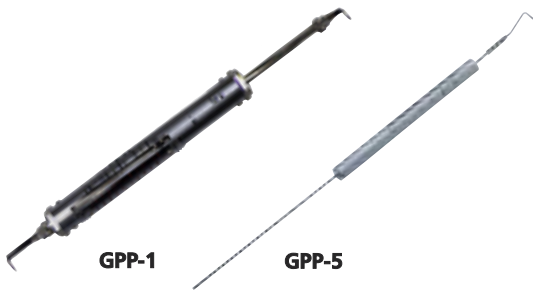

**PUSH-PULL PRECISION TENSION GAUGE**

Precision, compact tubular-type mechanical force gauge slender shape permits its use in confined areas. GPP-5 is graduated in two scales: grams and ounces, GPP-1 in grams only. Precision springs are individually calibrated. Full scale accuracy and factory calibration is held to ± 1 graduation. Construction is brass with satin chrome finish. Size: 1/2" diameter x 15" long.

JONARD P/N	AVOIRDUPOIS CAPACITY	METRIC CAPACITY
GPP-1	1000 g X 50 g	
GPP-5	1 lb X 1 oz.	500 g X 50 g

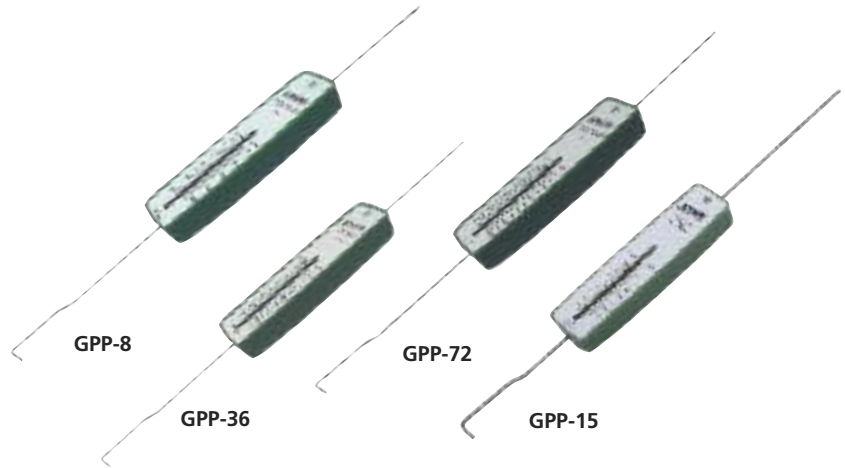

**ECONOMY PUSH-PULL TENSION GAUGES**

These high impact polystyrene cased instruments accurately measure push pull forces. Gauge is graduated in two scales: grams and ounces. Precision springs. Full scale accuracy is held to ± 1 graduation.

Size: 1 1/2" wide x 1" deep x 14" long.

JONARD P/N	AVOIRDUPOIS CAPACITY	METRIC CAPACITY
GPP-8	8 oz. x 0.25 oz.	220 g x 5 g
GPP-36	36 oz. x 0.5 oz.	1,020 g x 20 g
GPP-72	72 oz. x 1 oz.	2,025 g x 25 g
GPP-15	15 lb. x 4 oz.	6,804 x 100 g



In February 2003 Jonard Industries acquired OK Industries and merged their operation into the "Jonard Family of Companies". Established in 1946, OK Industries blossomed as a major force in the telecommunications and electronic industries with a special proficiency in the manufacture of Wire Wrapping Tools. These same tools have continuously been supplied by Jonard Tools.

Wire Wrapping is a method of making a wire connection by coiling the bare wire around the sharp corners of a terminal under mechanical tension. The technology was developed as an alternative to soldering, which presents various safety and reliability problems in many applications. A principal advantage of wire wrapping is that it provides a high-reliability connection that is also easily removed to correct or modify a wiring layout. Wire wrapping subjects the wire to tremendous tension and compression forces, causing the oxide layer on both wire and terminal to be crushed or sheared, resulting in a clean, oxide-free metal-to-metal contact. A standard wrap is generally used for 24 AWG and larger diameter wires; a modified wrap is typically used for 26 AWG and smaller wires, and is used almost exclusively for 28 to 30 AWG wires. In either case, the wrap style affects only the connection's mechanical stability; both styles provide suitable electrical connections.

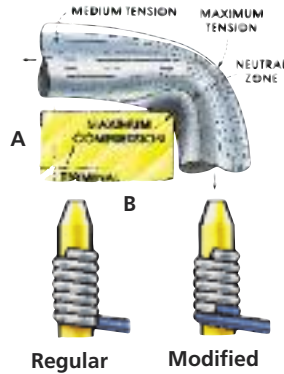

**METAL-TO-METAL CONTACT**

By bending the wire around the sharp corner of the terminal, the oxide layer on both wire and terminal is crushed or sheared, and a clean, oxide-free metal-to-metal contact is obtained.

**TYPES OF WRAP**

A "Regular" bit wraps the bare wire around the terminal. A "Modified" bit wraps a portion of insulation around the terminal in addition to the bare wire. This greatly increases the ability to withstand vibration.

**STRIP FORCE CHART\***

AWG	Wire Size		Min. number of turns (Bare Wire)	Min. strip force	
	Dia. inches	Dia. mm		lbs.	gms
16	.051	1.30	4	15	6800
18	.0403	1.00	4	15	6800
20	.032	0.80	5	8	3600
22	.0253	0.65	5	8	3600
24	.0201	0.50	6	7	3200
26	.0159	0.40	7	6	2700
28	.0126	0.32	7	5	2200
30	.0100	0.25	7	3.3	1500

\*Conforms to MIL-STD-1130B

**HOW TO MAKE WIRE WRAPPED CONNECTIONS**



**SOME HINTS ON MAKING WRAPPED CONNECTIONS**



**OVERWRAP**  
Do not press too hard. Let the OK tools do the work. Excessive pressure can lead to overwrapping. Backforce "BF" to prevent overwrapping is available on most power tools and is recommended for use with 26 through 30 AWG wire.

**INSUFFICIENT TURNS**  
It's easy to feed wire into the slot in the OK bit correctly. Be sure the stripped end of the wire is "pushed-in" all the way.



**OPEN WRAP & SPIRAL WRAP**  
Just keep the OK tool on the terminal until the wrap is complete. Early removal can result in spiral and open wraps.

**PIGTAIL**  
Wire wrapping is a precision technique and the wrong bit and sleeve just cannot do the job. Improper selection can cause problems ranging from "Pigtails" to loose wraps.

**TERMINAL DIAGONAL CHART**

		DIMENSION B																			
		.010	.015	.020	.025	.030	.035	.040	.045	.050	.055	.060	.065	.070	.075	.080	.085	.090	.095	.100	
		mm	0.25	0.38	0.51	0.64	0.76	0.89	1.02	1.14	1.27	1.40	1.52	1.65	1.78	1.91	2.03	2.16	2.29	2.41	2.54
DIMENSION A	.010	.014	.018	.022	.027	.032	.036	.041	.046	.051	.056	.061	.066	.071	.076	.081	.086	.091	.096	.101	
	.025	.036	.046	.056	.069	.081	.091	1.04	1.17	1.30	1.42	1.55	1.68	1.80	1.93	2.06	2.18	2.31	2.44	2.57	
	.015	.018	.021	.025	.029	.033	.038	.043	.047	.052	.057	.062	.067	.072	.077	.082	.087	.092	.097	.102	
	.038	.046	.053	.064	.074	.084	.097	1.09	1.19	1.32	1.45	1.58	1.70	1.83	1.96	2.08	2.21	2.34	2.46	2.59	
	.020	.022	.025	.028	.032	.036	.040	.045	.049	.053	.058	.063	.068	.073	.078	.083	.088	.093	.098	.103	
	.051	.056	.064	.071	.081	.091	1.02	1.14	1.25	1.35	1.47	1.60	1.73	1.85	1.98	2.11	2.24	2.36	2.49	2.62	
	.025	.027	.029	.032	.035	.039	.043	.047	.050	.056	.060	.065	.069	.074	.079	.084	.089	.094	.099	.104	
	.064	.069	.074	.081	.089	.099	1.09	1.19	1.27	1.42	1.52	1.65	1.75	1.88	2.01	2.13	2.26	2.39	2.52	2.64	
	.030	.032	.033	.036	.039	.042	.046	.050	.054	.058	.062	.067	.071	.076	.080	.085	.090	.095	.100	.105	
	.076	.081	.084	.091	.099	1.07	1.17	1.27	1.37	1.47	1.58	1.70	1.80	1.93	2.03	2.16	2.29	2.41	2.54	2.67	
.035	.036	.038	.040	.043	.046	.049	.052	.056	.060	.064	.069	.073	.078	.082	.087	.091	.096	.101	.106		
.089	.091	.097	1.02	1.09	1.17	1.25	1.32	1.42	1.52	1.63	1.75	1.85	1.98	2.08	2.21	2.31	2.44	2.57	2.69		
.040	.041	.043	.045	.047	.050	.052	.056	.060	.064	.068	.072	.076	.080	.084	.089	.092	.097	.102	.107		
1.02	1.04	1.09	1.14	1.19	1.27	1.32	1.42	1.52	1.63	1.73	1.83	1.93	2.03	2.13	2.26	2.34	2.46	2.59	2.72		
.045	.046	.047	.049	.050	.054	.056	.060	.063	.067	.071	.074	.078	.083	.087	.091	.096	.101	.105	.109		
1.14	1.17	1.19	1.25	1.27	1.37	1.42	1.52	1.60	1.70	1.80	1.88	1.98	2.11	2.21	2.31	2.44	2.57	2.67	2.77		
.050	.051	.052	.053	.056	.058	.060	.064	.067	.071	.074	.078	.082	.086	.090	.094	.098	.103	.107	.111		
1.27	1.30	1.32	1.35	1.42	1.47	1.52	1.63	1.70	1.80	1.88	1.98	2.08	2.18	2.29	2.39	2.49	2.62	2.72	2.82		

Example: If "A"=.020". "B"=.060". The terminal diagonal is .063" as shown on chart.



The ergonomic and patented PTX series wire wrap tools are the telecom industry standard for wire wrapping needs on main distribution frames as well as local and remote installations. Its rugged construction and high speed motor make the tool suitable for electronic assembly work and many other wire wrapping applications.



### PTX BATTERY POWERED WIRE WRAPPING TOOLS

Part No.	Description	Weight	Voltage	RPM
PTX	Battery Wrap/Unwrap Tool (Battery not included)	1.1 lb	3.6V*	3700
PTXFL	PTX plus Flashlight Attachment	1.1 lb	3.6V*	3700
PTX-KIT1	115V battery tool kit (tool, charger, (2) batteries)	3.5 lb	3.6V*	3700
PTX-KIT1FL	PTX Kit1 plus Flashlight Attachment	3.5 lb	3.6V*	3700
PTX-KIT1DH	PTX-KIT1 w/DFB224 and H-1000	3.6 lb	3.6V*	3700
PTX-KIT1DHFL	PTX-KIT1DH plus Flashlight Attachment	3.6 lb	3.6V*	3700
PTX-KIT2	230V battery tool kit (tool, charger, (2) batteries)	3.5 lb	3.6V*	4200
PTX-KIT2FL	PTX-KIT2 plus Flashlight Attachment	3.5 lb	3.6V*	4200
PTX-KIT2DH	PTX-KIT2 w/DFB224 and H-1000	3.6 lb	3.6V*	4200
PTX-KIT2DHFL	PTX-KIT2DH plus Flashlight Attachment	3.6 lb	3.6V*	4200

\*NiMH Battery

### PTX ELECTRIC POWERED WIRE WRAPPING TOOLS

Part No.	Description	Weight	Voltage	RPM
PTX-1	Electric Wrap/Unwrap Tool - 115V	2.0 lb	115V	3700
PTX-1FL	PTX-1 plus Flashlight Attachment	2.0 lb.	115V	3700
PTX-1BF	Electric Wrap/Unwrap Tool w/Backforce - 115V	2.0 lb	115V	3700
PTX-1BFFL	PTX-1BF plus Flashlight Attachment	2.0 lb.	115V	3700
PTX-2	Electric Wrap/Unwrap Tool - 230V	2.2 lb	230V	4200
PTX-2FL	PTX-2 plus Flashlight Attachment	2.2 lb.	230V	4200
PTX-2BF	Electric Wrap/Unwrap Tool w/Backforce - 230V	2.2 lb	230V	4200
PTX-2BFFL	PTX-2BF plus Flashlight Attachment	2.2 lb	230V	4200

### DFB SERIES WRAP & UNWRAP BIT & SLEEVE SETS

Part No.	Description	Wire Size AWG MM	Min. Terminal		Max. Terminal		Terminal		Terminal Hole		Effective	
			Diagonal IN.	MM	Diagonal IN.	MM	Hole Depth IN.	MM	Diameter IN.	MM	Radius IN.	MM
DFB224	Wrap/Unwrap Bit/Sleeve Set 22-24 AWG	22/24 .50/.65	.054	1.37	.073	1.85	0.50	12.70	.075	1.90	.111	2.82
DFB2426	Wrap/Unwrap Bit/Sleeve Set 24-26 AWG	24/26 .40/.50	.054	1.37	.065	1.65	0.50	12.70	.066	1.67	.098	2.48
DFB224	Consists of KB-DF224 bit, P-DF224 sleeve		DFB2426 Consists of KB-DF2426 bit, P-DF2426 sleeve									

#### ACCESSORIES

- PTX-B** PTX Battery, 3.6V
- PTX-BC1** 115V Battery Charger
- PTX-BC2** 230V Battery Charger
- H-1000** Cordura Tool Pouch
- PTX-FLA** Flashlight Attachment
- DFB224** Wrap/Unwrap Bit & Sleeve Set
- DFB2426** Wrap/Unwrap Bit & Sleeve Set



**MANUAL WIRE WRAPPING**



**G100/R3278 Aluminum**



**G200/R3278 Lexan™**



**G100/R3278FL**



**G100/R3278INS Insulated**

- G200/R3278 : Lexan™
- G100/R3278 : Aluminum
- G100/R3278INS : Aluminum insulated
- G100/R3278FL Aluminum Insulated with LED Flashlight
- Bits & Sleeves : see pages 53-54

Also available— bits and sleeves for old style chuckless wire wrapping tools

For precise reliable wraps, choose the tool you want. We offer durability with our rugged aluminum tool, G100/R3278, added protection with our insulated version, G100/R3278INS, providing 1000V of dielectric strength across most of the housing, and the same reliability, light weight plus a lower cost with our Lexan® model, G200/R3278. G100/R3278FL is the insulated version with an LED flashlight attached. These tools accommodate wire sizes from 18 AWG (1.00mm) thru 32 AWG (0.20mm).

**WIRE WRAPPING FLASHLIGHT KIT**



**G100-FL**



**G100-FLA**



**G100/R3394CT**

Part No.	Construction	For Use With
G100-FL	Metal	G100/R3278, G100/R3278INS,
G100-FLA	Plastic	Universal-for use with most manual wire wrapping guns

**MANUAL WIRE UNWRAPPING TOOL**

The combination of the G100/R3394CT unwrap tool and the PUW unwrap bit & sleeve set gives you the best tool for high speed wire unwrapping. High production, long life, low maintenance. Use Unwrap Set PUW2226 for wire AWG 20 thru 26 (0.80 thru 0.40mm).



- G100/R3394CT : Manual Wire Unwrapping Tool  
(See bit & sleeve listed below)

Unwrap Bit Part No.	Unwrap Sleeve Part No.	Bit and Sleeve Set Set No.	Wire Size		Terminal Hole Diameter	
			AWG	mm	Inches	mm
2026UB	SOK2230	PUW2226	20-26	0.80-0.40	.070	1.77



Fully compatible with any make or model wire wrapping tool. Modified bits provide 1 1/2-2 turns of insulation.



### 3" BITS AND SLEEVES CHART

Wire Gauge	Regular	Modified	Bit Part No.	Sleeve Part No.	Maximum Insulation Diameter	Minimum Terminal Diagonal	Maximum Terminal Diagonal	Terminal Hole Depth	Effective Radius	Terminal Diameter
18 AWG	●		KB18	P194LN		.060"	.073"	1.000"	.150"	.075"
1.00mm	●		KB18	P194LN		1.52mm	1.85mm	25.40mm	3.81mm	1.90mm
20 AWG		●	WB20M	P194LN	.059"	.042"	.073"	1.000"	.150"	.075"
0.80mm		●	WB20M	P194LN	1.50mm	1.07mm	1.85mm	25.40mm	3.81mm	1.90mm
20-22 AWG	●		KB2075	P2224		.042"	.073"	1.000"	.123"	.075"
0.65-0.80mm	●		KB2075	P2224		1.07mm	1.85mm	25.40mm	3.12mm	1.90mm
22 AWG	●		KB22	P2224		.054"	.073"	.750"	.117"	.075"
0.65mm	●		KB22	P2224		1.37mm	1.85mm	19.05mm	2.97mm	1.90mm
22 AWG		●	WB2275M	P2224	.052"	.049"	.074"	1.000"	.132"	.075"
0.65mm		●	WB2275M	P2224	1.32mm	1.24mm	1.87mm	25.40mm	3.35mm	1.90mm
22-24 AWG	●		KB224LH	P2224		.061"	.085"	1.000"	.117"	.086"
0.50-0.65mm	●		KB224LH	P2224		1.54mm	2.15mm	25.40mm	2.97mm	2.18mm
22-24 AWG	●		KB224-1	P2224		.054"	.073"	1.000"	.111"	.075"
0.50-0.65mm	●		KB224-1	P2224		1.37mm	1.85mm	25.40mm	2.82mm	1.90mm
22-24 AWG	●		KB224	P2224		.054"	.073"	.807"	.111"	.075"
0.50-0.65mm	●		KB224	P2224		1.37mm	1.85mm	20.50mm	2.82mm	1.90mm
22-24 AWG		●	WB224M	P2224	.050"	.049"	.074"	1.250"	.121"	.075"
0.50-0.65mm		●	WB224M	P2224	1.27mm	1.24mm	1.87mm	31.75mm	3.07mm	1.90mm
24 AWG		●	WB24DH	P2224	.046"	.054"	.073"	1.750"	.117"	.075"
0.50mm		●	WB24DH	P2224	1.17mm	1.37mm	1.85mm	44.50mm	2.97mm	1.90mm
24 AWG	●		KB24	P2426		.055"	.074"	.750"	.100"	.075"
0.50mm	●		KB24	P2426		1.39mm	1.87mm	19.05mm	2.54mm	1.90mm
24 AWG		●	WB245M*	P3032LN	.044"	.024"	.043"	.750"	.098"	.044"
0.50mm		●	WB245M*	P3032LN	1.11mm	0.60mm	1.09mm	19.05mm	2.48mm	1.11mm
24-26 AWG		●	WB2426M	P2224	.046"	.054"	.073"	.750"	.118"	.075"
0.40-0.50mm		●	WB2426M	P2224	1.17mm	1.37mm	1.85mm	19.05mm	2.99mm	1.90mm
24-26 AWG	●		KB2466	OK8519		.054"	.065"	1.000"	.098"	.066"
0.40-0.50mm	●		KB2466	OK8519		1.37mm	1.65mm	25.40mm	2.48mm	1.67mm
26 AWG	●		KB26	P2426		.058"	.073"	1.000"	.100"	.075"
0.40mm	●		KB26	P2426		1.47mm	1.85mm	25.40mm	2.54mm	1.90mm
26 AWG		●	WB265M*	P26LN	.031"	.023"	.038"	.750"	.075"	.040"
0.40mm		●	WB265M*	P26LN	0.79mm	0.58mm	0.96mm	19.05mm	1.90mm	1.02mm
26 AWG		●	WB26M	P2224	.046"	.054"	.073"	1.000"	.118"	.075"
0.40mm		●	WB26M	P2224	1.17mm	1.37mm	1.85mm	25.40mm	2.99mm	1.90mm
26 AWG		●	WB2644M*	P3032LN	.046"	.024"	.043"	.750"	.098"	.044"
0.40mm		●	WB2644M*	P3032LN	1.17mm	0.60mm	1.09mm	19.05mm	2.48mm	1.11mm
26 AWG		●	WB2669M	P2426	.041"	.053"	.068"	1.000"	.109"	.069"
0.40mm		●	WB2669M	P2426	1.04mm	1.34mm	1.72mm	25.40mm	2.77mm	1.75mm
28 AWG		●	WB28SHM	P3032	.030"	.031"	.035"	.750"	.066"	.036"
0.32mm		●	WB28SHM	P3032	0.76mm	0.79mm	0.89mm	19.05mm	1.67mm	0.91mm
30 AWG		●	SB30MSH-B*	P3032	.027"	.031"	.035"	.750"	.064"	.036"
0.25mm		●	SB30MSH-B*	P3032	0.69mm	0.79mm	0.89mm	19.05mm	1.62mm	0.91mm
30-32 AWG		●	WB3032M*	P3032	.027"	.034"	.038"	.750"	.064"	.040"
0.20-0.25mm		●	WB3032M*	P3032	0.69mm	0.86mm	0.96mm	19.05mm	1.62mm	1.02mm
30-32 AWG		●	WB3032MIL†	P3032	.027"	.034"	.038"	.750"	.064"	.040"
0.20-0.25mm		●	WB3032MIL†	P3032	0.69mm	0.86mm	0.96mm	19.05mm	1.62mm	1.02mm
30-32 AWG	●		KB3032	P3032		.034"	.038"	.750"	.064"	.040"
0.20-0.25mm	●		KB3032	P3032		0.86mm	0.96mm	19.05mm	1.62mm	1.02mm

\*These tools are recommended for .025" square terminals on .100" center to center of the pins † Provides 2.5 turns of insulation



P2224INS

### 3" BITS AND INSULATED SLEEVES



KB22

The insulated sleeves are covered with a material that provides 1000V dielectric strength which helps to prevent shorting between pins and enhances worker safety.

Bit Part No.	Sleeve Part No.	Wire Size		Regular	Minimum Terminal Diagonal		Maximum Terminal Diagonal		Terminal Hole Depth		Effective Radius		Terminal Hole Diameter	
		AWG	mm		In.	mm	In.	mm	In.	mm	In.	mm	In.	mm
KB22	P2224INS	22	0.65	●	.054	1.37	.073	1.85	.750	19.05	.117	2.97	.075	1.90
KB224	P2224INS	22-24	0.50-0.65	●	.054	1.37	.073	1.85	.807	20.50	.111	2.82	.075	1.90
KB24	P2426INS	26	0.50	●	.055	1.39	.074	1.87	.750	19.05	.100	2.54	.075	1.90
KB26	P2426INS	26	0.40	●	.058	1.47	.073	1.85	1.000	25.40	.100	2.54	.075	1.90
KB3032	P3032INS	30-32	0.32	●	.034	0.86	.038	0.96	0.750	19.05	.064	1.62	.040	1.02



P2426-5INS

### 5" BITS AND SLEEVES (EXTENDED LENGTH) INSULATED AND NON INSULATED SLEEVES



KB24-5

These bits and sleeves are designed for wire wrapping in areas requiring deep penetration. Their 5" (127mm) length ensures "true" connections in hard-to-get-at locations. Available with or without insulation.

Bit Part No.	Insulated Sleeve Part No.	Uninsulated Sleeve Part No.	Wire Size		Regular	Minimum Terminal Diagonal		Maximum Terminal Diagonal		Terminal Hole Depth		Effective Radius		Terminal Hole Diameter	
			AWG	mm		In.	mm	In.	mm	In.	mm	In.	mm	In.	mm
KB22-5	P2224-5INS	P2224-5	22	0.65	●	.054	1.37	.073	1.85	.750	19.05	.117	2.97	.075	1.90
KB24-5	P2426-5INS	P2426-5	24	0.50	●	.055	1.39	.073	1.85	.750	19.05	.100	2.54	.075	1.90
KB26-5	P2426-5INS	P2426-5	26	0.40	●	.058	1.47	.073	1.85	.750	19.05	.100	2.54	.075	1.90

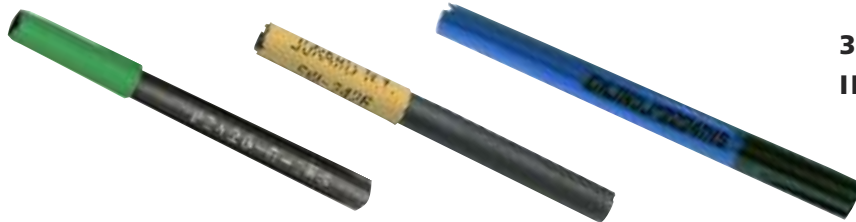

### 3" BIT & SLEEVE SETS WITH INSULATED COLOR CODED SLEEVES

Enjoy the convenience of pre-assembled sets with insulated color-coded sleeves for easy identification of wire sizes based on color.

Kit Number	Bit Part No.	Sleeve Part No. Color	Wire Size		Regular	Modified	Maximum Insulation Diameter		Minimum Terminal Diagonal		Maximum Terminal Diagonal		Terminal Hole Depth		Effective Radius		Terminal Hole Diameter	
			AWG	mm			In.	mm	In.	mm	In.	mm	In.	mm	In.	mm	In.	mm
KT22B	KB22	P2224INS Blue	22	0.65	●		-	-	.054	1.37	.073	1.85	.750	19.05	.117	2.97	.075	1.90
KT224B	KB224	P2224INS Blue	22-24	0.65-0.50	●		-	-	.054	1.37	.073	1.85	.807	20.05	.111	2.82	.075	1.90
KT24Y	KB24	SW-2426 Yellow	24	0.50	●		-	-	.055	1.39	.074	1.87	.750	19.05	.100	2.54	.075	1.90
KT26G	KB26	P2426-G-INS Green	26	0.40	●		-	-	.058	1.47	.073	1.85	1.000	25.40	.100	2.54	.075	1.90

### WIRE WRAPPING EXTENSION ATTACHMENT

Precision device which attaches easily to your manual or power wire wrapping tool for applications requiring extra "reach".



EXT-400

Part No.	Extension
EXT-400	Inches: 4.0    mm: 100



These are complete kits for technicians working at a Main Distributing Frame or for field service where wire wrapping is required.

**WWK-CO Insulated Wire Wrapping Kit- designed specifically for the Central Office.**



**WWK-CO**



**Kit Contains:** G100/R3278INS, Insulated Wire Wrapping Tool, KB224 bit, 22-24 AWG, P2224INS Insulated sleeve, 22-24 AWG, H-1000 Cordura Pouch, JIC-21257 Telecom long nose pliers, JIC-22035 Probe pick, UW4 Sleeved unwrapping tool, JIC-2257 Insulated wire loop puller

Part No.	Description
WWK-CO	Wire Wrapping Kit, Central Office



**WWK-1**



**Kit Contains:** G200/R3278 Wire Wrapping Tool, KB224 bit 22-24 AWG, P2224 sleeve 22-24 AWG, HW-UW-224 Wrap/unwrap tool, ST-100 wire stripper 22-24 AWG, H-1000 Cordura Pouch

Part No.	Description
WWK-1	Wire Wrapping Kit



**WWK-1INS**



**Kit Contains:** G100/R3278INS Insulated Wire Wrapping tool, KB224 bit 22-24 AWG, P2224INS Insulated sleeve 22-24 AWG, UW4 sleeved unwrapping tool 20-26 AWG, ST-100 Wire stripper 22-24 AWG, H-1000 Cordura Pouch

Part No.	Description
WWK-1INS	Insulated Wire Wrapping Kit



### HAND WRAPPING TOOLS

These Hand Wrapping Tools are carefully designed to produce perfect wire wrapped connections. Precision, long-lasting tools for use where occasional wraps are required or where power wire-wrapping tools are not practical. Compact and convenient.

Part No.	Reg.	Mod.	Type	Wire Size		Max. Insulation Diameter		Terminal Hole Diameter		Terminal Hole Depth		Outside Diameter	
				AWG	mm	Inches	mm	Inches	mm	Inches	mm	Inches	mm
HW-20	●		A	20	0.80	-	-	.075	1.90	1.000	25.40	.218	5.53
HW-224	●		A	22-24	0.65-0.50	-	-	.075	1.90	.807	20.50	.218	5.53
HW-26	●		A	26	0.40	-	-	.075	1.90	1.000	25.40	.218	5.53
HW-30*		●		30	0.25	.027	0.69	.036	0.91	.750	19.05	.125	3.17

\*This tool is recommended for .025" (0.63mm) square terminals on .100" (2.54mm) centers



### HAND UNWRAPPING TOOLS

These tools are used to remove wire connections made with 20 thru 32 gauge wire.

Part No.	Type	Wire Size		Type of Unwrap	Terminal Hole Diameter		Terminal Hole Depth		Outside Diameter	
		AWG	mm		Inches	mm	Inches	mm	Inches	mm
UW1	D	20-26	0.80-0.40	Left Hand	.070	1.77	1.000	25.40	.156	3.96
UW2	C	20-26	0.80-0.40	Left and Right Hand	.070	1.77	1.000	25.40	.156	3.96
UW4	B	20-26	0.80-0.40	Left Hand	.070	1.77	2.360	60.00	1.95	4.95
UW5	B	20-26	0.80-0.40	Left and Right Hand	.070	1.77	2.360	60.00	1.95	4.95
UW093R	D	24-32	0.50-0.20	Left Hand	.038	0.96	1.000	25.40	.093	2.36
UWD93-93	C	24-32	0.50-0.20	Left and Right Hand	.038	0.96	1.000	25.40	.093	2.36
UW2832C	B	28-32	0.32-0.20	Left and Right Hand	.038	0.96	.750	19.05	.156	3.96



**PATENTED**

### WRAP/STRIP/UNWRAP TOOLS

Each WSU tool wraps, unwraps and even strips the appropriate wire diameter with a unique built-in stripper blade. Ideal for bench use or tool kit in all service and repair applications. In addition to versatility, convenience, and reliability, the WSU Series offers exceptional value.

Part No.	Reg.	Mod.	Wire Size		Max. Insulation Diameter		Terminal Hole Diameter		Terminal Hole Depth		Outside Diameter		Square Post	
			AWG	mm	In.	mm	In.	mm	In.	mm	In.	mm	In.	mm
WSU-2224	●		22-24	0.65-0.50			.075	1.90	1.50	38.1	.213	5.4	.045	1.14
WSU-24M		●	24	0.50	.036	0.92	.075	1.90	1.50	38.1	.213	5.4	.045	1.14
WSU-26M		●	26	0.40	.034	0.86	.075	1.90	1.50	38.1	.213	5.4	.045	1.14
WSU-30	●		30	0.25			.036	0.91	1.50	38.1	.125	3.2	.025	0.63
WSU-30M		●	30	0.25	.021	0.53	.036	0.91	1.50	38.1	.125	3.2	.025	0.63

These tools are recommended for .025" (0.63mm) square terminals on .100" (2.54mm) centers



## HAND WRAPPING AND UNWRAPPING TOOLS

These Hand Wrapping and Unwrapping Tools are carefully designed to produce perfect wire wrapped connections. Precision, long-lasting tools for use where occasional wraps are required or where power wire-wrapping tools are not practical. Compact and convenient.



HW-UW-224INS

## HAND WRAPPING AND UNWRAPPING TOOLS

To switch from wire wrapping to unwrapping takes only seconds - just a quick change of the cap from one end to the other.

WRAPPING SIDE													UNWRAPPING SIDE							
JONARD Part No.	Reg	Mod	Wire Size		Max. Insulation Diameter		Terminal Hole Diameter		Terminal Hole Depth		Outside Diameter		Wire Size		Terminal Hole Diameter		Terminal Hole Depth		Outside Diameter	
			AWG	mm	In.	mm	In.	mm	In.	mm	In.	mm	AWG	mm	In.	mm	In.	mm	In.	mm
HW-UW-18-19	●		18-19	1.00-0.91	-	-	.075	1.90	1.000	25.40	.250	6.35	18-19	1.00-0.91	.075	1.90	1.000	25.40	.187	4.74
HW-UW-20	●		20	0.80	-	-	.075	1.90	1.000	25.40	.218	5.53	20-26	1.00-0.91	.070	1.77	1.000	25.40	.156	3.96
HW-UW-224	●		22-24	0.65-0.50	-	-	.075	1.90	.807	20.50	.218	5.53	20-26	0.80-0.40	.070	1.77	1.000	25.40	.156	3.96
HW-UW-224-1	●		22-24	0.65-0.50	-	-	.075	1.90	1.000	25.40	.218	5.53	20-26	0.80-0.40	.070	1.77	1.000	25.40	.156	3.96
HW-UW-2426	●		24-26	0.50-0.40	-	-	.075	1.90	.750	19.05	.218	5.53	20-26	0.80-0.40	.070	1.77	1.000	25.40	.156	3.96
HW-UW-26	●		26	0.40	-	-	.075	1.90	1.000	25.40	.218	5.53	20-26	0.80-0.40	.070	1.77	1.000	25.40	.156	3.96
HW-UW-26SM*		●	26	0.40	.031	0.79	.040	1.02	.750	19.05	.125	3.17	24-32	0.50-0.20	.038	0.96	1.000	25.40	.093	2.36
HW-UW-2829M*		●	28-29	0.32-0.29	.036	0.91	.040	1.02	.750	19.05	.156	3.96	24-32	0.50-0.20	.038	0.96	1.000	25.40	.093	2.36
HW-UW-30*		●	30	0.25	.027	0.69	.036	0.91	.750	19.05	.125	3.17	24-32	0.50-0.20	.038	0.96	1.000	25.40	.093	2.36
<b>INSULATED HAND WRAPPING AND UNWRAPPING TOOLS</b>																				
HW-UW-224INS†	●		22-24	0.65-0.60	-	-	.075	1.90	1.000	25.40	.218	5.53	20-26	0.80-0.40	.070	1.77	1.000	25.40	.156	3.96
WDUD-26DS†	●		26	0.40	-	-	.075	1.90	1.000	25.40	.218	5.53	20-26	0.80-0.40	.070	1.77	1.000	25.40	.156	3.96

\*These tools are recommended for .025" (0.63mm) square terminals on .100" (2.54mm) centers. A modified wrap provides 1.5 – 2 turns of insulation.

† Insulated handle for dielectric protection.

NOTE: WDUD-26DS and HW-UW-224INS have insulated handles to prevent shocks.





**UNIVERSAL PLCC EXTRACTION TOOL EX-5/EX-6**



EX-6

**Features**

- Extracts a range of PLCC sizes from 20 pins through 128 pins from any socket without damage to the chip.
- Spring loaded one-hand design requires no pulling, just squeeze handles and chip is lifted from the socket.
- ESD safe handles for use on all static safe components (EX-5).
- Machined stainless steel for long-life (EX-5).
- EX-6 - ABS handles and stamped steel.



STATIC SAFE



EX-5

Part No.	Description
EX-5	ESD safe PLCC extraction tool
EX-6	PLCC extraction tool

**INSERTION/EXTRACTION KIT WK-7**

WK-7 kit includes DIP IC extractors and inserters to accommodate all IC's from 8 to 40 pins. All tools are CMOS safe and include grounding lugs where appropriate except EX-1. The kit consists of extractors EX-1 for 8-24 pin devices, and EX-2 for 24-40 pin ICs, plus inserters MOS-1416, MOS-2428, and MOS-40 for 14-16, 24-28 and 36-40 pin IC's respectively.



S-340

**DIP/IC EXTRACTOR**

This is a one-piece insulated spring steel extractor used to extract LSI, MSI and SSI devices from 8 to 24 pins. Will remove all types of DIP/IC's without bending pins. 4" long.

Part No.	Description
S-340	DIP/IC Extractor



**WK-7 Kit Includes**

- EX-1 Extraction Tool (8-24 Pins).
- EX-2 Extraction Tool (24-40 Pins).
- MOS-1416 Insertion Tool (14-16 Pins).
- MOS-40 Insertion Tool (36-40 Pins).
- MOS-2428 Insertion Tool (24-28 Pins).

Part No.	Description
WK-7	5 piece insertion/extraction kit

Note: WK-7 items may be purchased individually.



## HIGH-VACUUM DESOLDERING PUMPS

A specially engineered desolder pump made to exacting specifications and providing precise repeatable operation. Fitted with a Teflon Tip with ID .125", OD .22" and included cleaning mechanism. DP-100 and DP-200. 13" long including tip, DP-140 8" long.



## Features

- Durable corrosion resistant plastic construction.
- Precision metal plunger.
- Corrosion treated springs.
- Insulated vacuum pulse.
- Regulated return (1 millisecond ±30%).
- Uniform reset pressure (11in. lbs. ±20%).
- Cushioned shock reduction (pulse release to minimize board damage).

Part No.	Description
DP-100	High Vacuum Desoldering Pump
DP-200	High Vacuum Desoldering Pump, ESD Safe
DPT-100	1 Replacement Tip, DP-100/DP-140
DPT-200	1 Replacement Tip, DP-200

Part No.	Description
DP-140	Desoldering Pump
DPT-100	1 Replacement Tip, DP-100/DP-140

## BENCHTOP FUME ABSORBERS



- Aerodynamic hood design effectively draws irritating soldering fumes away from the work area.
- Carbon-impregnated filters trap a limited portion of the flux fumes.
- Compact size, low profile and adjustable stand allows convenient placement 6" to 8" (152 to 203mm) from work area.
- SA-9-E-115 feature static-dissipative housings.
- Dimensions: 8 1/2" H x 8 1/4" W x 4" D
- Articulating arm allows optimized positioning and saves bench space.
- Bench mounting clamp and 3 filters come complete with unit.
- SA-91-E features a static-dissipative housing.

### Benchtop

Part No.	Description
SA-9-115	Benchtop fume absorber, 115V AC with 3 filters
SA-9-E-115	ESD-Safe benchtop fume absorber, 115V AC with 3 filters

### Articulating Arm

Part No.	Description
SA-91	SA-9-115 with Articulating Arm, & Bracket
SA-91-E	SA-9-E-115 with Articulating Arm, & Bracket
SAK-90	Arm Assembly Kit Retro-fits SA-9/9-E to SA-91/SA-91-E
SAF-1	Replacement Filter Set, 3pcs.

Specifications		
Part No.	SA-9-115 SA-9-E-115	SA-91 SA-91-E
Input Voltage	115V 60Hz	115V 60Hz
Maximum Air Volume	105 to 126 CFM	105 to 126 CFM
Activated Carbon Wt.	12g	12g
Unit Weight	2.2 lbs. (1 kg)	4 lbs. (1.8 kg)
Arm Length	-	24" (607mm)



MADE FOR LIFE®  
SINCE 1958

Ваш поставщик:  
**ООО "КОМПАНИЯ ОПТУЛС"**  
Москва, ул.Иловайская, д.3  
Тел.: +7 (495) 646-00-96  
sale@opttools.ru  
www.opttools.ru