

MASTECH®



CATALOGUE 2024

MEASURING INSTRUMENTS CATALOGUE

CONTENT INDEX

2	WHO IS MGL
3	ABOUT MASTECH
4	FAST SELECTION CHARTS
29	DIGITAL MULTIMETERS
97	DIGITAL CLAMP METERS
135	AC LINE SPLITTERS
139	ELECTRICAL TESTERS
149	CIRCUIT TESTERS
155	CIRCUIT ANALYZERS
160	WIRE & CABLE TESTERS
166	LCR METERS
172	EARTH RESISTANCE
178	INSULATION TESTERS
184	PAT TESTER
186	THERMOMETERS
198	ENVIRONMENTAL METERS
218	ACCESSORIES

WHO IS MGL

We are a global group of companies operating locally. We manufacture test and measurement products for the electrical and automotive industry, from the entry level through high tech products.

Our companies work globally, serving our customers worldwide. This global network delivers a deeper understanding of each individual market, with solutions tailored to the unique requirements of each customer.

With customers over 20 years old, our goal is to be a recognized, honest and fair company. We aim to be the most valued partner for our customers in the research, development, manufacture and supply of innovative, modern and customer-focused technologies.

We have a highly experienced team which is openminded, receptive to new ideas and adaptive to evolving market trends. This solid foundation guarantees that we are well informed and fully equipped to deliver excellent solutions to meet our customers' real needs.



BRANDING CHANNELS

We manufacture electrical test and measurement instruments under our own brands: Mastech, KPS, C-Logic and Power Probe, recognized brands and market leaders in the fields of electrical measurement and automotive. All of our products have a professional positioning based on advanced balanced technology and they are marketed through local distributors throughout the world. We maintain direct and close contact with our distributors, through our offices around the world, and we support them in their business by offering technical advice and an after-sales service for our products.

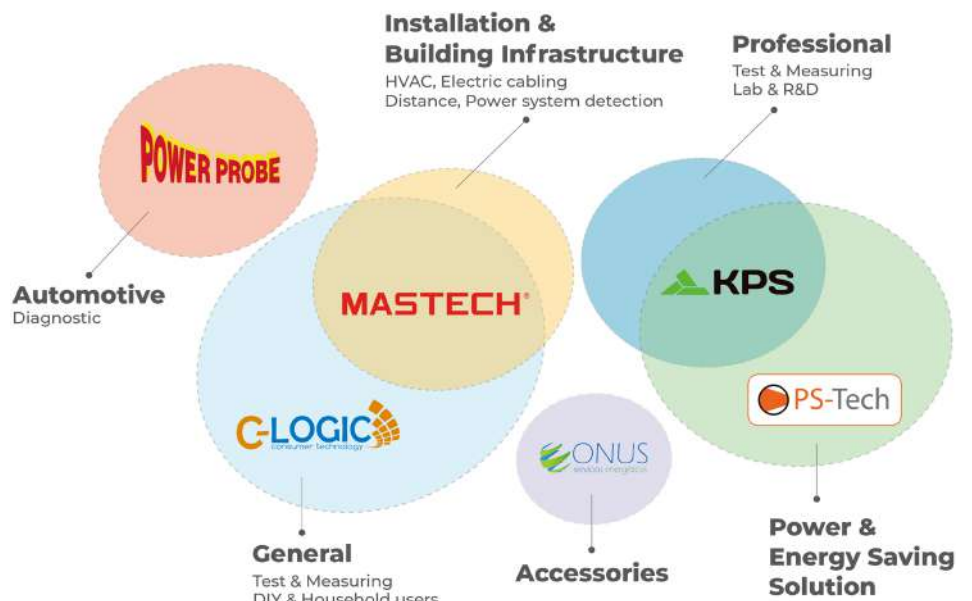

MASTECH®

At MASTECH we focus on providing the highest quality, innovative measuring instruments for the electrical market, along with the best service to our customers.

From digital multimeters and clamp meters to voltage testers, plug testers and all ranges of environmental testers, our product families have been developed to meet the requirements of the construction, DIY and industrial sectors.

Test and measurement equipment:

- I. For industrial environments: we develop a range of measuring instruments with specific features and high precision, ensuring reliability and accuracy.
- II. For the residential sector: MASTECH instruments meet all requirements relating to measuring and testing of electrical values, enabling safety checks on installations and appliances in homes and other buildings.
- III. For environmental measurement, MASTECH offers a wide range of solutions, with measuring instruments for temperature, moisture and wind speed to light, sound, gas and distance.



DIGITAL MULTIMETERS
MANUAL RANGING

								
CAT II CAT III CAT IV								
Model	M3900	M830B	M830BZ	M832	M838	MAS830	MAS830B	MAS830L
Page	30	31	32	33	34	35	36	37
Safety Rating	CAT II 1000V CAT III 600V	CAT II 600V	CAT II 600V	CAT II 600V	CAT II 600V	CAT III 600V	CAT III 600V	CAT III 600V
Display Counts	2000	2000	2000	2000	2000	2000	2000	2000
Auto Ranging								
Auto Power Off								
True RMS								
DC Voltage	1000V	600V	600V	600V	600V	600V	600V	600V
AC Voltage	750V	600V	600V	600V	600V	600V	600V	600V
DC Current	10A	10A	10A	10A	10A	10A	10A	10A
AC Current	10A							
Resistance	20MΩ	2MΩ	2MΩ	2MΩ	2MΩ	2MΩ	2MΩ	2MΩ
Capacitance								
Frequency								
Duty Cycle								
Type K Temperature								-20~1370°C
Battery Test								
Diode	•	•	•	•	•	•	•	•
Continuity	•		•	•	•	•		•
Display Backlight								•
Work Light								•
Data Hold						•		•
NCV								
Inductance								
hFE Transistor	•	•		•	•			•
Dual Display								
MAX								
MAX/MIN								
MAX/MIN/AVG								
Relative Measurement								
Peak Measurement								
DWELL Test								
TACH Test								

DIGITAL MULTIMETERS
MANUAL RANGING

CAT II
CAT III
CAT IV



Model	MAS838	MS8233A	MS8233B	MS8233C	MS8238	MS8261	MS8264	MS8269
Page	38	39	40	41	42	43	44	445
Safety Rating	CAT II 600V	CAT III 600V	CAT III 600V	CAT III 600V	CAT III 600V	CAT II 1000V CAT III 600V	CAT II 1000V CAT III 600V	CAT II 1000V CAT III 600V
Display Counts	2000	2000	2000	2000	2000	2000	2000	2000
Auto Ranging								
Auto Power Off						•	•	•
True RMS								
DC Voltage	600V	600V	600V	600V	600V	1000V	1000V	1000V
AC Voltage	600V	600V	600V	600V	600V	750V	750V	750V
DC Current	10A	10A	10A	10A	10A	10A	10A	10A
AC Current						10A	10A	10A
Resistance	2MΩ	2MΩ	2MΩ	2MΩ	2MΩ	200MΩ	200MΩ	20MΩ
Capacitance						20μF	20μF	20μF
Frequency							20kHz	
Duty Cycle								
Type K Temperature	-20~1000°C			-20~1000°C -4~1832°F			-20~1000°C	-20~1000°C
Battery Test					•			
Diode	•	•	•	•	•	•	•	•
Continuity	•	•	•	•	•	•	•	•
Display Backlight			•	•		•	•	
Work Light								
Data Hold	•	•	•	•		•	•	•
NCV			•	•				
Inductance								20H
hFE Transistor						•	•	•
Dual Display								
MAX								
MAX/MIN								
MAX/MIN/AVG								
Relative Measurement								
Peak Measurement								
DWELL Test								
TACH Test								







DIGITAL MULTIMETERS
MANUAL RANGING

CAT II
CAT III
CAT IV









Model	MS8301A	MS8301B	MS8321A	MS8321D	MS8360C	MS8360E	MY60	MY61
Page	46	47	48	49	50	51	52	53
Safety Rating	CAT III 600V	CAT III 600V	CAT III 600V	CAT II 1000V CAT III 600V	CAT III 600V	CAT III 600V	CAT II 1000V CAT III 600V	CAT II 1000V CAT III 600V
Display Counts	2000	4000	2000	2000	2000	2000	2000	2000
Auto Ranging	•	•						
Auto Power Off	•	•	•	•	•	•	•	•
True RMS								
DC Voltage	600V	600V	600V	1000V	600V	600V	1000V	1000V
AC Voltage	600V	600V	600V	750V	600V	600V	700V	700V
DC Current		10A	10A	20A	10A	10A	10A	10A
AC Current	10A	10A	10A	20A	10A	10A	10A	10A
Resistance	2MΩ	40MΩ	20MΩ	20MΩ	200MΩ	200MΩ	200MΩ	200MΩ
Capacitance		100μF			200μF	200μF		100μF
Frequency		10kHz			20kHz			
Duty Cycle								
Type K Temperature		-4~1832°F			-20~1000°C -4~1832°F			
Battery Test	•							
Diode	•	•	•	•	•	•	•	•
Continuity	•	•	•	•	•	•	•	•
Display Backlight		•			•	•		
Work Light		•						
Data Hold	•	•	•	•	•	•	•	•
NCV		•			•	•		
Inductance						20H		
hFE Transistor			•	•			•	•
Dual Display								
MAX								
MAX/MIN								
MAX/MIN/AVG								
Relative Measurement								
Peak Measurement								
DWELL Test								
TACH Test								







**DIGITAL MULTIMETERS
MANUAL RANGING**

							
	<p>CAT II CAT III CAT IV</p>						
Model	MY62	MY63	MY64	MY65	MY70	MY74	MY75
Page	54	55	56	57	58	59	60
Safety Rating	CAT II 1000V CAT III 600V	CAT II 1000V CAT III 600V	CAT II 1000V CAT III 600V	CAT II 1000V CAT III 600V	CAT III 600V	CAT III 600V	CAT III 600V
Display Counts	2000	2000	2000	20000	2000	2000	20000
Auto Ranging							
Auto Power Off	•	•	•	•	•	•	•
True RMS							
DC Voltage	1000V	1000V	1000V	1000V	600V	600V	600V
AC Voltage	750V	750V	750V	700V	600V	600V	600V
DC Current	10A	10A	10A	10A	10A	10A	10A
AC Current	10A	10A	10A	10A	10A	10A	10A
Resistance	200MΩ	200MΩ	200MΩ	200MΩ	200MΩ	200MΩ	200MΩ
Capacitance	100μF	100μF	100μF	100μF		100μF	200nF
Frequency		2kHz	20kHz	20kHz		20kHz	20kHz
Duty Cycle							
Type K Temperature	-20~1000°C		-20~1000°C		-20~1000°C		
Battery Test							
Diode	•				•	•	•
Continuity	•	•	•	•	•	•	•
Display Backlight							
Work Light							
Data Hold	•	•	•	•	•	•	•
NCV							
Inductance							
hFE Transistor	•	•	•	•	•	•	
Dual Display							
MAX							
MAX/MIN							
MAX/MIN/AVG							
Relative Measurement							
Peak Measurement							
DWELL Test							
TACH Test							







DIGITAL MULTIMETERS AUTO RANGING

	NEW						
	CAT II	CAT III	CAT IV				
							
Model	MS820L	MS8217	MS8221C	MS8233D	MS8233E	MS8238H	MS8239C
Page	61	62	63	64	65	66	67
Safety Rating	CAT II 600V CAT III 300V	CAT II 1000V CAT III 600V	CAT II 600V	CAT II 600V	CAT III 600V	CAT III 600V	CAT III 600V
Display Counts	2000	4000	2000	2000	2000	4000	4000
Auto Ranging		•	•	•	•	•	•
Auto Power Off	•	•	•	•	•	•	•
True RMS						•	
DC Voltage	500V	1000V	600V	600V	600V	600V	600V
AC Voltage	500V	1000V	600V	600V	600V	600V	600V
DC Current	10A	10A	10A	10A	10A	10A	10A
AC Current		10A	10A	10A	10A	10A	10A
Resistance	200MΩ	40MΩ	20MΩ	20MΩ	20MΩ	40MΩ	40MΩ
Capacitance		100μF	1000μF				100μF
Frequency		100kHz	400Hz	20kHz			10kHz
Duty Cycle							•
Type K Temperature		-55~1000°C	-20~1000°C		-20~1000°C -4~1832°F	-20~1000°C -4~1832°F	-20~1000°C -4~1832°F
Battery Test						•	
Diode		•	•	•	•	•	•
Continuity	•	•	•	•	•	•	•
Display Backlight				•	•		•
Work Light							
Data Hold	•	•		•	•	•	•
NCV				•	•	•	
Inductance							
hFE Transistor			•				
Dual Display							
MAX				•	•		
MAX/MIN							
MAX/MIN/AVG							
Relative Measurement		•					
Peak Measurement							
Low Pass Filter							
AC/DC Current (For Clamp)							
Low Impedance							
Bar Graph							
Interface							Wireless







DIGITAL MULTIMETERS AUTO RANGING

							
	CAT II CAT III CAT IV						
Model	MS8250A	MS8250D	MS8251A	MS8251B	MS8268	MS8301D	MS8332C
Page	68	69	70	71	72	73	74
Safety Rating	CAT IV 600V	CAT III 1000V CAT IV 600V	CAT III 1000V CAT IV 600V	CAT III 1000V CAT IV 600V	CAT II 1000V CAT III 600V	CAT III 600V	CAT III 600V
Display Counts	4000	6600	6600	6600	4000	6000	4000
Auto Ranging	•	•	•	•	•	•	•
Auto Power Off	•	•	•	•	•	•	•
True RMS		•		•			
DC Voltage	600V	1000V	1000V	1000V	1000V	600V	600V
AC Voltage	600V	1000V	1000V	1000V	750V	600V	600V
DC Current	10A	10A	10A	10A	10A		400mA
AC Current	10A	10A	10A	10A	10A		400mA
Resistance	40MΩ	66MΩ	66MΩ	66MΩ	40MΩ	10MΩ	40MΩ
Capacitance	100μF	66mF	66mF	66mF	200μF		100μF
Frequency	5MHz	66MHz	66MHz	10kHz	200kHz	3kHz	5MHz
Duty Cycle	•	•	•	•	•	•	•
Type K Temperature			0~1000°C 32~1832°F	0~1000°C 32~1832°F			
Battery Test							
Diode	•	•	•	•	•		•
Continuity	•	•	•	•	•	•	•
Display Backlight	•	•	•	•	•	•	•
Work Light							
Data Hold	•	•	•	•	•	•	•
NCV	•	•	•	•		•	•
Inductance							
hFE Transistor					•		
Dual Display		•	•	•		•	
MAX							
MAX/MIN		•	•	•		•	
MAX/MIN/AVG							
Relative Measurement	•	•	•	•	•		
Peak Measurement							
Low Pass Filter							
Sound & Light Warning					•		
Low Impedance				•			
Bar Graph				•			
Interface		USB					

**DIGITAL MULTIMETERS
AUTO RANGING**

						
CAT II CAT III CAT IV						
Model	MS8340A	MS8360F	MS8360G	MS8361D	MY68	MY78
Page	75	76	77	78	79	80
Safety Rating	CAT III 1000V	CAT III 600V	CAT III 600V	CAT III 600V	CAT II 1000V CAT III 600V	CAT II 1000V CAT III 600V
Display Counts	6000	4000	4000	4000	4000	4000
Auto Ranging	•	•	•	•	•	•
Auto Power Off	•	•	•	•	•	•
True RMS				•		
DC Voltage	1000V	600V	600V	600V	1000V	600V
AC Voltage	750V	600V	600V	600V	700V	600V
DC Current	10A	10A	10A	10A	10A	10A
AC Current	10A	10A	10A	10A	10A	10A
Resistance	60MΩ	40MΩ	40MΩ	40MΩ	40MΩ	40MΩ
Capacitance	400μF	200μF	4000μF	99.99mF	200μF	200μF
Frequency	10MHz	10MHz	10MHz	10kHz	100kHz	200kHz
Duty Cycle	•	•	•	•		•
Type K Temperature	-10~700°C 14~1292°F		-20~1000°C -4~1832°F			
Battery Test						
Diode	•	•	•	•	•	•
Continuity	•	•	•	•	•	•
Display Backlight	•	•	•	•		
Work Light						
Data Hold	•	•	•	•	•	•
NCV		•	•	•		
Inductance						
hFE Transistor				•	•	•
Dual Display						
MAX						
MAX/MIN	•		•			
MAX/MIN/AVG						
Relative Measurement	•	•	•	•		•
Peak Measurement						
Low Pass Filter	•					
AC/DC Current (For Clamp)						•
Low Impedance						
Bar Graph			•			
Interface				Wireless		

DIGITAL MULTIMETERS POCKET/PEN TYPE

							
Model	M300	M320	MS8333A	MS8211	MS8211D	MS8212A	MS8223A
Page	81	82	83	84	85	86	87
Safety Rating	CAT II 600V CAT III 300V	CAT II 600V CAT III 300V	CAT III 600V	CAT II 600V	CAT II 600V	CAT III 600V	CAT III 600V
Display Counts	2000	4000	6000	2000	2000	2000	2000
Auto Ranging		•	•	•	•	•	•
Auto Power Off		•	•	•	•	•	•
True RMS			•				
DC Voltage	600V	600V	600V	600V	600V	600V	600V
AC Voltage	600V	600V	600V	600V	600V	600V	600V
DC Current	200mA	400mA	600mA		200mA	200mA	200mA
AC Current		400mA	600mA		200mA	200mA	200mA
Resistance	20MΩ	40MΩ	60MΩ	20MΩ	20MΩ	20MΩ	20MΩ
Capacitance		100μF	600μF				
Frequency		100kHz	10kHz				
Duty Cycle			•				
Type K Temperature							
Battery Test			•				
Diode	•	•	•	•	•	•	•
Continuity	•	•	•	•	•	•	•
Display Backlight			•				
Work Light							•
Data Hold		•	•	•	•	•	•
NCV			•	•		•	•
Inductance							
hFE Transistor							
Dual Display							
MAX				•	•	•	•
MAX/MIN							
MAX/MIN/AVG							
Relative Measurement							
Peak Measurement							
DWELL Test							
TACH Test							
Logic Level Test					•	•	•
Retractable Tip				•	•		
Double Molding						•	•







DIGITAL MULTIMETERS BENCH TYPE

CAT II
CAT III
CAT IV









Model	MS6100	MS8040	MS8050
Page	88	89	90
Safety Rating		CAT II 1000V	CAT II 1000V
Display Counts	22000	22000	53000
Auto Ranging	•	•	•
Auto Power Off		•	•
True RMS		•	•
DC Voltage		1000V	1000V
AC Voltage		750V	1000V
DC Current		10A	10A
AC Current		10A	10A
Resistance		200MΩ	50MΩ
Capacitance		20mF	5000μF
Frequency	1300MHz		
Logic Frequency		220MHz	2MHz
Linear Frequency		100kHz	200kHz
Duty Cycle		•	•
OSC. Out	10MHz		
Type K Temperature		-30~1300°C -22~2372°F	
Diode		•	•
hFE Transistor			
Continuity		•	•
Backlight		•	•
Data Hold	•	•	•
MAX/MIN/AVG		MAX/MIN	•
Relative Measurement	•	•	•
Peak Measurement		•	
Low Pass Filter	•	•	
Bar Graph		•	
DC Current (For Clamp)		220/2200A	
AC Current (For Clamp)		220/2200A	
ADP measurement			
Data Logging			30 Groups
Analysis Software			•
Interface		USB	USB







DIGITAL MULTIMETERS SPECIAL APPLICATION

						
	CAT II CAT III CAT IV					
Model	MS5208	MS8209	MS8229	MS8236	MS8239D	MS8265
Page	91	92	93	94	95	96
Safety Rating	CAT III 1000V CAT IV 600V	CAT III 600V	CAT III 600V	CAT III 600V	CAT III 600V	CAT II 1000V CAT III 600V
Display Counts	6600	4000	4000	2000	2000	20000
Auto Ranging	•	•	•	•	•	•
Auto Power Off	•	•	•	•	•	•
True RMS	•					
DC/AC Voltage	1000V/750V	600V/600V	1000V/750V	600V/600V	600V/600V	1000V/750V
DC/AC Current	400mA/400mA	10A/10A	10A/10A	10A/10A	10A/10A	10A/10A
Resistance	66MΩ	40MΩ	40MΩ	20MΩ	40MΩ	200MΩ
Capacitance	66mF	200μF	100μF			200μF
Frequency	10kHz	200kHz	200kHz			20kHz
Duty Cycle	•	•				
Diode	•	•	•	•	•	•
Type K Temperature	-30~1300°C -22~2372°F	-20~1000°C -4~1832°F	-20~1000°C -4~1832°F			
Continuity	•	•	•	•	•	•
Display Backlight	•	•	•	•	•	•
Data Hold	•	•	•	•	•	•
NCV				•		
hFE Transistor						•
MAX				•	•	
MAX/MIN						
MAX/MIN/AVG	•					
Relative Measurement	•	•				
Low Pass Filter	•					
Insulation Test	1000V/2GΩ					
DAR/PI	•					
Relative Humidity		30~90%	20~95%			
Sound level		35~100dB	40~100dB			
Luminosity		40000Lux	4000/40000Lux			
Environment Temperature			0~40°C/32~104°F			
Cable Check						RJ11/RJ45/Tone
Sound & Light Warning			•			•
Data Logging	100 Groups					
Interface						
DWELL/TACH Test				•		

DIGITAL CLAMP METERS AC CURRENT





							
	CAT II CAT III CAT IV						
Model	M266	M266C	M266F	MS2000G	MS2001	MS2001C	MS2001F
Page	98	99	100	101	102	103	104
Safety Rating	CAT II 1000V CAT III 600V	CAT II 1000V CAT III 600V	CAT II 1000V CAT III 600V	CAT II 1000V	CAT II 1000V CAT III 600V	CAT II 1000V CAT III 600V	CAT III 600V CAT IV 600V
Display Counts	2000	2000	2000	2000	2000	2000	2000
Jaw Size	Φ50mm 2.0"	Φ50mm 2.0"	Φ50mm 2.0"	Φ55mm 2.2"	Φ42mm 1.7"	Φ42mm 1.7"	Φ42mm 1.7"
Auto Ranging							
Auto Power Off							
True RMS							
DC Voltage	1000V	1000V	1000V	1000V	1000V	1000V	1000V
AC Voltage	750V	750V	750V	750V	750V	750V	750V
DC Current							
AC Current	1000A	1000A	1000A	2000A	1000A	1000A	1000A
Resistance	20kΩ	20MΩ	2MΩ	2MΩ	2000Ω	2000Ω	2000Ω
Capacitance							
Frequency			2kHz	20kHz			2kHz
Duty Cycle							
Type K Temperature		0~750°C 32~1382°F		0~750°C 32~1382°F		-40~750°C	
Diode			•	•	•		•
Continuity	•	•	•	•	•	•	•
Display Backlight				•	•	•	
Work Light							
Data Hold	•	•	•	•	•	•	•
NCV							
MAX/MIN							
Relative Measurement							
Bar Graph							
Insulation Test	2000MΩ	2000MΩ	2000MΩ				
DC Current (From Plug)							
Low Pass Filter							
Low Impedance							
Dual Display							
Infrared Temperature							
Interface							

DIGITAL CLAMP METERS AC CURRENT







							
Model	MS2008B	MS2009A	MS2009C	MS2025A	MS2025C	MS2026R	MS2028A
Page	105	106	107	108	109	110	111
Safety Rating	CAT III 600V	CAT III 600V	CAT III 600V	CAT III 1000V CAT IV 600V	CAT III 1000V CAT IV 600V	CAT III 600V	CAT III 600V
Display Counts	4000	2000	6000	6000	6600	6000	2000
Jaw Size	Φ26mm 1.0"	Φ26mm 1.0"	Φ26mm 1.0"	Φ40mm 1.6"	Φ40mm 1.6"	Φ40mm 1.6"	Φ26mm 1.0"
Auto Ranging	•	•	•	•	•	•	•
Auto Power Off	•	•	•	•	•	•	•
True RMS				•	•	•	•
DC Voltage	600V	600V	600V	1000V	1000V	1000V	600V
AC Voltage	600V	600V	600V	750V	750V	750V	600V
DC Current							
AC Current	600A	600A	600A	10A	1000A	1000A	600A
Resistance	40MΩ	20MΩ	60MΩ	60MΩ	66MΩ	60MΩ	20MΩ
Capacitance	100μF		60mF	100mF	66mF	4000μF	
Frequency	100kHz		1kHz	10kHz	66MHz	10kHz	
Duty Cycle			•	•	•	•	
Type K Temperature	-20~750°C		-20~1000°C -4~1832°F		-20~1000°C -4~1832°F		
Diode	•	•	•	•	•	•	•
Continuity	•	•	•	•	•	•	•
Display Backlight	•	•	•	•	•	•	•
Work Light		•	•	•	•	•	
Data Hold	•	•	•	•	•	•	•
NCV		•	•	•	•		
MAX/MIN		MAX		•	•	•	Max
Relative Measurement				•	•	•	
Bar Graph					•		
Insulation Test							
DC Current (From Plug)							
Low Pass Filter							
Low Impedance							
Dual Display					•		
Infrared Temperature							
Interface							

DIGITAL CLAMP METERS AC CURRENT

DIGITAL CLAMP METERS AC/DC CURRENT





						
Model	MS2030	MS2030B	MS2033A	MS2101	MS2108	MS2109A
Page	112	113	114	115	116	117
Safety Rating	CAT III 600V	CAT III 600V	CAT III 600V	CAT II 1000V CAT III 600V	CAT III 600V	CAT III 600V
Display Counts	2000	4000	6000	4000	6000	6000
Jaw Size	Φ28mm 1.1"	Φ28mm 1.1"	Φ26mm 1.0"	Φ42mm 1.7"		Φ26mm 1.0"
Auto Ranging		•	•	•	•	•
Auto Power Off		•	•	•	•	•
True RMS						
DC Voltage	600V	600V	600V	1000V	600V	600V
AC Voltage	600V	600V	600V	750V	600V	600V
DC Current				1000A	600A	600A
AC Current	400A	600A	600A	1000A	600A	600A
Resistance	2kΩ	40MΩ	10MΩ	40MΩ	66MΩ	60MΩ
Capacitance		100μF		100μF	66mF	4000μF
Frequency		10kHz	3kHz	100kHz	1kHz	10MHz
Duty Cycle			•	•	•	•
Type K Temperature		-20~1000°C -4~1832°F		-40~750°C		-20~1000°C -4~1832°F
Diode	•	•		•	•	•
Continuity	•	•	•	•	•	•
Display Backlight		•	•		•	•
Work Light		•			•	•
Data Hold	•	•	•	•	•	•
NCV		•				•
MAX/MIN			•			•
Relative Measurement				•		•
Bar Graph						
Insulation Test						
DC Current (From Plug)						
Low Pass Filter						
Low Impedance						
Dual Display			•			
Infrared Temperature						
Interface						

DIGITAL CLAMP METERS
AC/DC CURRENT







						
CAT II CAT III CAT IV						
Model	MS2125A	MS2128	MS2128A	MS2138	MS2138R	MS2160
Page	118	119	120	121	122	123
Safety Rating	CAT III 1000V CAT IV 600	CAT III 600V	CAT III 600V	CAT III 600V	CAT III 600V	CAT III 1000V CAT IV 600
Display Counts	6000	6600	4000	4000	4000	4000
Jaw Size	Φ40mm 1.6"	Φ26mm 1.0"	Φ26mm 1.0"	Φ26mm 1.0"	Φ26mm 1.0"	Φ24mm 0.9"
Auto Ranging	•	•	•	•	•	•
Auto Power Off	•	•	•	•	•	•
True RMS	•	•	•		•	
DC Voltage	1000V	600V	600V	600V	600V	600V
AC Voltage	750V	600V	600V	600V	600V	600V
DC Current	1000A	600A	400A	1000A	1000A	80A
AC Current	1000A	600A	400A	1000A	1000A	80A
Resistance	60MΩ	66MΩ	40MΩ	40MΩ	40MΩ	40MΩ
Capacitance	100mF	66mF	4000μF	4000μF	4000μF	40mF
Frequency	1000Hz	1000Hz	1000Hz	10kHz	10kHz	10kHz
Duty Cycle	•	•	•	•	•	•
Type K Temperature						-20~1000°C -4~1832°F
Diode	•	•	•	•	•	•
Continuity	•	•	•	•	•	•
Display Backlight	•	•	•	•	•	•
Work Light	•	•	•	•	•	•
Data Hold	•	•	•	•	•	•
NCV	•					•
MAX/MIN	•	•	•			
Relative Measurement	•		•	•	•	
Bar Graph			•	•	•	
Insulation Test						
DC Current (From Plug)						
Low Pass Filter						
Low Impedance						
Dual Display						
Infrared Temperature						
Interface						

DIGITAL CLAMP METERS LEAKGE



DIGITAL CLAMP METERS POWER

					
	CAT II CAT III CAT IV				
Model	MS2006B	MS2016A	MS2203	MS2205	MS2225A
Page	124	125	126	127	128
Safety Rating	CAT III 600V	CAT III 600V	CAT III 600V	CAT III 600V	CAT III 1000V
Display Counts	2000	4000	9999	6000	6000
Jaw Size	Φ31mm 1.2"	Ø30mm 1.2"	Φ50mm 2.0"	Φ50mm 2.0"	Φ40mm 1.6"
Auto Ranging		•	•	•	•
Auto Power Off	•	•		•	•
True RMS		•	•	•	•
DC Voltage		600V			1000V
AC Voltage		600V	600V	600V	750V
DC Current					
AC Current	60A	150A	1000A	1000A	1000A
Resistance		40MΩ			60MΩ
Capacitance		40mF			100mF
Frequency			1000Hz	1000Hz	10kHz
Duty Cycle					•
Type K Temperature		-20~1000°C -4~1832°F			
Diode		•			•
Continuity		•			•
Display Backlight			•	•	•
Work Light					•
Data Hold	•	•	•	•	•
NCV					•
MAX/MIN		•	•		•
Relative Measurement					•
Bar Graph			•		
Active Power			600kW	600kW	750kW
Apparent Power			600kVA	600kVA	750kVA
Reactive Power			600kVAr	600kVAr	750kVAr
Power Factor			0.3~1	0.3~1	0.3~1
Active Energy			9999kWh		
Harmonic Measurement				45~65Hz	45~65Hz
Data Logging			28 Groups	100 Groups	
Interface			RS232	RS232	Wireless





DIGITAL CLAMP METERS SPECIAL APPLICATION

						
	CAT II CAT III CAT IV					
Model	M9912	MS2015A	MS2600	MS2601	MS3300	MS3302
Page	129	130	131	132	133	134
Safety Rating	CAT II 1000V	CAT II 1000V	CAT III 600V	CAT III 600V	CAT II 1000V	CAT II 600V
Display Counts	3200	6000	4000	6000		
Jaw Size	Φ55mm 2.2"	Φ40mm 1.6"	Φ12mm 0.5"	Φ12mm 0.5"	Φ55mm 2.2"	Φ28mm 1.1"
Auto Ranging	•		•	•		
Auto Power Off			•	•		
True RMS		•			•	
DC Voltage	750V	1000V	1000V	600V		
AC Voltage	750V	750V	700V	600V		
DC Current	1000A				1000A	
AC Current	1000A	1000A	200A	200A	1000A	400A
Inrush Current						
Resistance	30MΩ	60MΩ	40MΩ	60MΩ		
Capacitance		100mF	40μF	60mF		
Frequency	30kHz	10MHz	100kHz	60MHz		
Duty Cycle		•	•			
Type K Temperature					-20~400°C -4~750°F	
Diode	•	•	•	•		
Continuity	•	•	•	•		
Display Backlight	•	•	•	•		
Work Light	•	•		•		
Data Hold	•	•	•	•		
NCV		•		•		
MAX/MIN		•				
Relative Measurement			•			
Bar Graph						
Insulation Test						
DC Current (From Plug)				1000μA		
Low Pass Filter						
Low Impedance				•		
Dual Display						
Infrared Temperature						
Interface						

LINE SPLITTERS

	<p>CAT II CAT III CAT IV</p> 		
Model	MS922A	MS922D	MS922E
Page	136	137	138
Safety Rating	CAT II 600V	CAT II 600V	CAT II 600V
AC Voltage	125V	250V	250V
AC Current	15A	15A	15A
Frequency	50~60Hz	50~60Hz	50~60Hz
Feature	<ul style="list-style-type: none"> -Allows for easy AC Current measurements -Using a Clamp meter on 2 or 3 Wire Power Cords -Provides the Ability to Safely Measure Current without the need to cut or separate conductors -Separates the Hot/Live conductor from the Neutral and Ground -Voltage check sockets for easy power calculations 		
Style	USA	EU	UK





ELECTRICAL TESTERS

	<p>CAT II CAT III CAT IV</p> 				
Model	MS6580B	MS8900	MS8900A	MS8900C	MS8902A
Page	140	141	142	143	144
Safety Rating	CAT II 1000V CAT III 600V	CAT II 1000V CAT III 600V	CAT II 1000V CAT III 600V	CAT II 1000V CAT III 600V	CAT II 1000V CAT III 600V
Non Contact Voltage	12~1000V	100~240V	90~1000V	100~240V	12~1000V
Contact Voltage					
Frequency	50~60Hz	50~60Hz	50~60Hz	50~60Hz	50~500Hz
Metal Detecting					
RCD Test					
Work Light	•				
Sound & Light	•	•	•	•	•
Auto Power Off	•				•
Sensitivity adjustment	•				•
Infrared temperature	-20~330°C -4~626°F				

ELECTRICAL TESTERS

				
CAT II CAT III CAT IV				
Model	MS8902B	MS8907	MS8922A	MS8922B
Page	145	146	147	148
Safety Rating	CAT II 1000V CAT III 600V	CAT II 1000V CAT III 600V	CAT III 600V	CAT III 400V
Non Contact Voltage	20~1000V	50~1000V		
Contact Voltage			400V	400V
Frequency	50~500Hz	50~60Hz	50~60Hz	50~60Hz
Metal Detecting	<20mm			
RCD Test		•		•
Work Light		•		
Sound & Light	•			
Auto Power Off	•			
Sensitivity adjustment	•			

CIRCUIT TESTERS

					
CAT II CAT III CAT IV					
Model	MS102	MS112	MS5902RT	MS5905RT	MS6860
Page	150	151	152	153	154
Safety Rating	CAT II 125V	CAT II 125V	CAT II 600V	CAT II 600V	CAT II 230V
AC Voltage	125V	400V	230V/120V	230V	230V
Socket Test	•	•	•	•	•
GFCI Test	•		TF type	TF type	
RCD Test					
Work Light			•		
NCV				•	
Buzzer & LED Instruction	•	•	•	•	•





CIRCUIT ANALYZERS

				
	CAT II CAT III CAT IV			
Model	MS5900	MS5901	MS5908A	MS5908C
Page	156	157	158	159
Safety Rating	CAT III 600V	CAT III 600V	CAT III 300V	CAT III 600V
AC Voltage	400V	400V	190V	375V
Frequency	400Hz	400Hz	45~65Hz	45~65Hz
Motor & Phase Rotation Indicator	•	•		
Voltage Drop Current			12/15/20A	12/15/20A
Impedance measurement			>3.00Ω	>3.00Ω
GFCI Test			•	•
RCD Test			•	•
Data Hold			•	•
Backlight			•	•





WIRE & CABLE TESTERS

					
	CAT II CAT III CAT IV				
Model	MS6810	MS6811	MS6812A	MS6813	MS6818
Page	161	162	163	164	165
Safety Rating					CAT III 300V
Auto Ranging					•
DC Voltage					12~400V
AC Voltage					12~400V
Frequency			300kHz	300kHz	125kHz
Low Battery Indicator		•			
Sensitivity Adjustable			•	•	•
Electric Wire			•	•	•
Coaxial Cable (BNC)	•			•	
Network Cable	•	•		•	
Telephone Wire			•	•	
Backlight					•
Worklight					•
Sound & light instructions			•	•	•





LCR METERS

					
Model	MS5308	MS6013	MS8910	MS8911	MY6243
Page	167	168	169	170	171
Auto Ranging			•	•	
Auto Power Off			•	•	
Resistance	2Ω/200MΩ		300Ω/30MΩ	60Ω/20MΩ	
Capacitance	2000pF/2000μF	200pF/20mF	3nF/30mF	600pF/6mF	2nF/200μF
Inductance	2000μH~2000H			600μH/200H	2mH~2H
Diode			•		
Continuity Buzzer			•		
Auto Scanning			•	•	
Zero Adjustment		•			
LCR/DCR	•			•	
Data Hold	•		•	•	
Backlight	•				
Relative Measurement	•				
Interface	RS232				



EARTH RESISTANCE

					
CAT II CAT III CAT IV					
Model	MS2115A	MS2301	MS2302	MS2306	MS2308
Page	173	174	175	176	177
Safety Rating	CAT III 1000V CAT IV 600V	CAT III 150V	CAT III 300V		
Resistance	60MΩ	1200Ω	4000Ω	20kΩ	20kΩ
Measurement Voltage	AC 750V DC 1000V		AC 200V	AC 20V/48V DC 20V	AC 20V/48V DC 20V
Sensing & Inducing Current Transformer					•
Back light	•		•	•	•
Interface					USB

INSULATION TESTERS

					
CAT II CAT III CAT IV					
Model	MS5201	MS5202	MS5203	MS5205	MS5215
Page	179	180	181	182	183
Safety Rating	CAT II 1000V CAT III 600V	CAT II 1000V	CAT III 1000V CAT IV 600V	CAT III 1000V CAT IV 600V	CAT III 1000V CAT IV 600V
Insulation Resistance	0.01MΩ~2GΩ	0.01MΩ~100GΩ	0.01MΩ~10GΩ	0.01MΩ~10GΩ	0.01MΩ~5TΩ
Output Voltage	1kV DC	2.5kV DC	1kV DC	2.5kV DC	5kV DC
Leakage Current test					1nA~3mA
Continuity Test			0.01Ω~200Ω (1mA)	0.01Ω~200Ω (1mA)	
Measurement Voltage	DC 1000V AC 700V	AC 5000V	DC 1000V AC 700V	DC 1000V AC 700V	DC 1000V AC 750V
Short Current	1.8mA		1.8mA	3mA	3mA
Temperature Test					-10~70°C
Back Light			•	•	•
Interface					USB

DIGITAL THERMOMETERS

						
Model	MS6500	MS6505	MS6511	MS6512	MS6513	MS6514
Page	187	188	189	190	191	192
Thermocouple Type	K		K.J.T.E	K.J.T.E	K.J.T.E. R.S.N	K.J.T.E. R.S.N
Temperature	-50~750°C -58~1382°F	-20~60°C -4~140°F	-200~1372°C -328~2501°F	-200~1372°C -328~2501°F	-200~1372°C -328~2501°F	-200~1372°C -328~2501°F
Injection Method	Single		Single	Dual	Single	Dual
Channel			TC	T1/T2/T1-T2	TC	T1/T2/T1-T2
Relative Humidity		0~100%				
Update Rate	500mS					
Clock		•				
MAX/MIN/AVG/DIF		MAX/MIN	•	•	•	•
Date Logging		16300 groups			1000 groups	1000 groups
Backlight		•				
Date Hold	•	•	•	•	•	•
Interface		RS232			USB	USB

INFRARED THERMOMETERS



Model	MS6522A	MS6522B	MS6531B	MS6531C	MS6541
Page	193	194	195	196	197
Color Display			•	•	•
IRT Temperature	-20~300°C -4~572°F	-20~500°C -4~932°F	-40~800°C -40~1472°F	-40~800°C -40~1472°F	-50~760°C -58~1400°F
Type K Temperature				-40~1080°C -40~1976°F	-50~300°C -58~572°F
Distance to Spot(D:S)	10:1	10:1	12:1	12:1	30:1
Emissivity	0.95	0.95	0.1~0.99	0.1~0.99	0.1~0.99
MAX/MIN/AVG/DIF	MAX/MIN/AVG	MAX/MIN/AVG	•	•	•
Data Logging				20 groups	100 groups
Backlight	•	•	•	•	•
Data hold	•	•	•	•	•

SOUND METERS



Model	MS6700	MS6701	MS6708
Page	199	200	201
Display	2000	2000	2000
Auto Ranging	•	•	•
Auto Power Off	•	•	•
Sound Level	30~130dB	30~130dB	30~130dB
Dynamic	50dB	50dB	50dB
Frequency	31.5Hz~8kHz	31.5Hz~8kHz	30Hz~8kHz
A/C Weighting	•	•	•
Data Logging		16000	
Data Hold			•
Date/Time	•	•	
Backlight	•	•	•
MAX	•	•	•
AC adapter	•	•	
AC/DC Signal output	•	•	
Interface		USB	

ANEMOMETERS



Model	MS6252A	MS6252B	MS6252D
Page	202	203	204
m/s	0.8~40 m/s	0.8~40 m/s	0.8~40 m/s
km/h	2.88~144 km/h	2.88~144 km/h	2.88~144 km/h
ft/s	2.62~131.2 ft/s	2.62~131.2 ft/s	2.62~131.2 ft/s
Knots	1.6~77.70 Knots	1.6~77.70 Knots	1.6~77.70 Knots
mile/h	1.8~90.00 mile/h	1.8~90.00 mile/h	1.8~90.00 mile/h
ft/m	157.5~7874 ft/m	157.5~7874 ft/m	157.5~7874 ft/m
Temperature		-10~60°C	-10~60°C
Relative Humidity		20~80%RH	20~80%RH
Ambient		•	•
Dew point		•	•
Wet Bulb		•	•
Interface		USB	Wireless

LIGHT METERS



Model	MS6610	MS6612	MS6612B	MS6612D
Page	205	206	207	208
Auto Ranging		•	•	•
Auto Power Off		•	•	•
Display Counts	2000	2000	2000	2000
Ranging	0~50000Lux	0~200000Lux 0~20000FC	0~200000Lux 0~20000FC 0~999900CD	0~200000Lux 0~20000FC 0~999900CD
Unit Selection	Lux	Lux/FC	Lux/FC/CD	Lux/FC/CD
Relative		•	•	•
Peak		•	•	•
MAX/MIN		•	•	•
Data Hold	•	•	•	•
Bar Graph		•	•	•
LED light source			•	•
Interface				Wireless

MOISTURE METERS



Model	MS6900	MS6900A
Page	209	210
Ranging	Wood , Brick, Plaster ...	Wood , Brick, Plaster ...
Testing Depth	5mm	5mm
Object moisture	0~60%	0~60%
Ambient TEMP	-10~50°C 14~122°F	-10~50°C 14~122°F
Sampling Rate	240mS	240mS
MAX/MIN	•	•
Unit Selection	WB, TD, °C, °F, %RH	WB, TD, °C, °F, %RH
Auxiliary Verification		•
Data Hold	•	•
Backlight	•	•

TACHOMETERS



Model	MS6208A	MS6208B
Page	211	212
Contact	50~19999	
Measurement	50~19999RPM	50~99999RPM (Non-Contact)
Measuring Distance	X	50~250mm
Auto Power Off	•	•
MAX/MIN	•	•
Data Hold	•	•
Backlight	•	•
Unit Selection	•	
Data Logging	100 Groups	100 Groups

GAS DETECTOR



Model	MS6310
Page	213
Alarm at level	10%~40%
Response Time	2 seconds
Warm up time	2 Minutes
Easy to Identify	•
Pinpoint Gas Leaks	•
Portable	•
High Sensitivity	•
Resume Original measurement	State after 7-10 min in clear air
Gas Detected	Natural gas, Methane, Ethane, Propane

PAT TESTER

CAT II
CAT III
CAT IV



Model	MS5911
Page	185
Safety Rating	CAT II 300V
Grounding	20Ω
Insulation Resistance	20MΩ
leakage Current	10.5mA
Cord Test	•
Polarity Test	•
Power Socket Test	•
Auto Power Off	•
Data HoldBacklight	•
Data logging	300 groups

ENVIRONMENT TESTER



Model	MS6300
Page	214
Auto Ranging	•
Auto Power Off	•
Temperature	-10~60°C/14~140°F
Humidity	20~80%RH
Sound level	30~130dB
luminance	2000Lux
Wind Speed	0.5~20m/s, 1.8~72km/h 100~4000FPM, 0.9~38.9Knots
AirFlow [CMM]	0~999900
AirFlow [CFM]	0~999900
A/C Weighting	•
MAX/MIN/AVG/DIF	•
Data Hold	•
Backlight	•

DISTANCE METERS



Model	MS6404/MS6406/MS6408
Page	215
Auto Power Off	•
Distance	40m/60m/80m
Accuracy	±2.0mm
Area & Volume	•
Pythagorean proposition measurement	•
Unit	mm/Inch/feet
Backlight	•
Auxiliary foot level	•
Laser target point	•
Data Logging	30 groups

STUD METAL DETECTOR



Model	MS6906
Page	216
Auto Power Off	7 Minute
Wooden Pillar	30mm
Metal Stud Detection Detph	30mm
Metal Pipe Detector Depth	50mm
AC Voltage Detection Detph	75mm (50~600VAC)
Data Hold	•
Backlight	•

PROCESS CALIBRATOR



Model	MS7221
Page	217
DC Volatge	10V
DC Current	10A
Loop Power Output	24V DC



MAIN APPLICATIONS

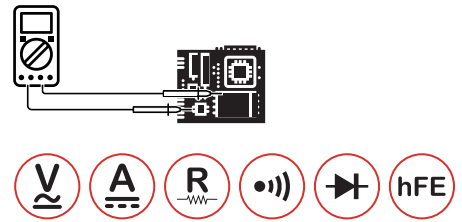
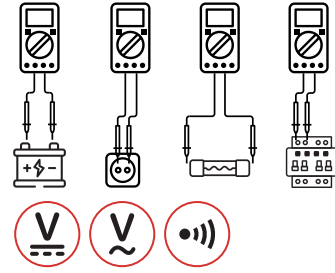

POCKET DIGITAL MULTIMETER
M3900

SKU NO.: M3900CBGLO
UPC CODE: 810053674062
EAN CODE: 8435394779133

FEATURE

- Display 2000 Counts.
- Diode Open Voltage 2.8v.
- Low Battery Display.

SPECIFICATIONS

AC Voltage 750V	DC Voltage 1000V	AC Current 10A
DC Current 10A	Resistance 20MΩ	Display Counts 2000

CONTENTS



172×88×36mm
6.7"×3.5"×1.4"
370g/0.8lb



1×9V 6F22
Battery



ACCESSORIES

Test Leads



Calibration
Certificate



Quick Start
Guide

PACKAGING INFORMATION



Color Box
L165×W70×H255mm



Carton Box
47×37.5×35.5cm



X 20PCS



POCKET DIGITAL MULTIMETER
M830B

SKU NO.: M830BCBGLO
UPC CODE: 810053672495
EAN CODE: 8435394778136

FEATURE

- Display 2000 Counts.
- Pocket Size.

SPECIFICATIONS

AC Voltage 600V	DC Voltage 600V	AC Current 10A
Resistance 200kΩ	Display Counts 2000	

MAIN APPLICATIONS

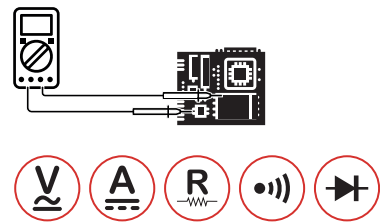
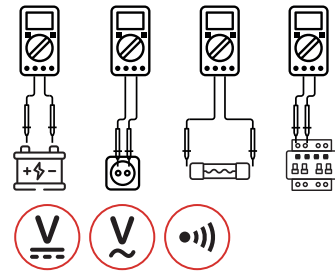

CONTENTS



126×70×25mm
4.9"×2.75"×0.9"
170g/0.4lb



1×9V 6F22
Battery



Test Leads



Calibration
Certificate

ACCESSORIES



Quick Start
Guide

PACKAGING INFORMATION



Color Box
L145×W60×H188mm



Carton Box
40×32×31.5cm



X 20PCS



MAIN APPLICATIONS



DOMESTIC

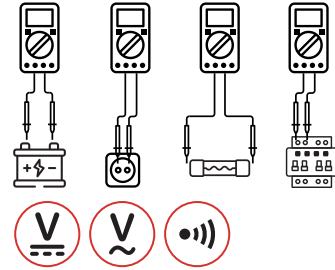

ELECTRONICS

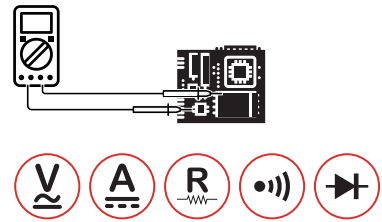

POCKET DIGITAL MULTIMETER
M830BZ

SKU NO.: M830BZCBGLO
UPC CODE: 810053674581
EAN CODE: 8435394779652

FEATURE

- Display 2000 Counts.
- Pocket Size.

SPECIFICATIONS

AC Voltage 600V	DC Voltage 600V	AC Current 10A
Resistance 200kΩ	Display Counts 2000	

CONTENTS



126×70×25mm
4.9"×2.75"×0.9"
170g/0.4lb



1×9V 6F22
Battery



ACCESSORIES

Test Leads



Calibration
Certificate



Quick Start
Guide

PACKAGING INFORMATION



Color Box
L145×W60×H188mm



Carton Box
40×32×31.5cm



X 20PCS



POCKET DIGITAL MULTIMETER
M832

SKU NO.: M832CBGLO
UPC CODE: 810053672501
EAN CODE: 8435394778143

FEATURE

- Display 2000 Counts.
- Pocket Size.

SPECIFICATIONS

AC Voltage 600V	DC Voltage 600V	AC Current 10A
Resistance 2MΩ	Display Counts 2000	Continuity <50Ω

MAIN APPLICATIONS

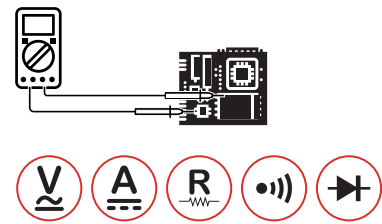
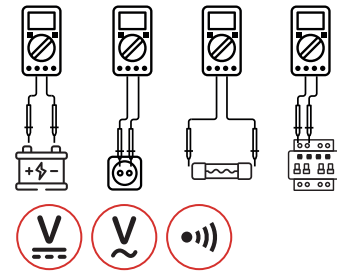

CONTENTS



126×70×25mm
4.9"×2.75"×0.9"
170g/0.4lb



1×9V 6F22
Battery



Test Leads



Calibration
Certificate

ACCESSORIES



Quick Start
Guide

PACKAGING INFORMATION



Color Box
L145×W60×H188mm



Carton Box
40×32×31.5cm



X 20PCS



POCKET DIGITAL MULTIMETER
M838

SKU NO.: M838CBAGLO
UPC CODE: 810053672518
EAN CODE: 8435394778150

FEATURE

- Display 2000 Counts.
- Pocket Size.

SPECIFICATIONS

AC Voltage 600V	DC Voltage 600V	AC Current 10A
Resistance 200kΩ	Display Counts 2000	Continuity <50Ω
Temperature -20~1370°C		

MAIN APPLICATIONS

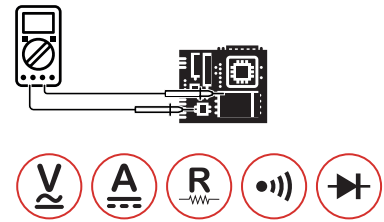
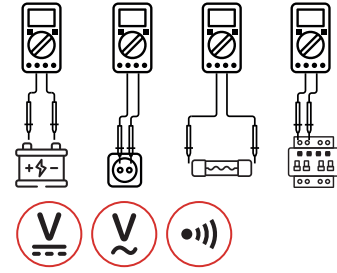

CONTENTS



126×70×25mm
4.9"×2.75"×0.9"
170g/0.4lb



1×9V 6F22
Battery



ACCESSORIES

Test Leads
K-type thermocouple



Calibration
Certificate



Quick Start
Guide

PACKAGING INFORMATION



Color Box
L145×W60×H188mm



Carton Box
40×32×31.5cm



X 20PCS



DIGITAL MULTIMETER

MAS830

SKU NO.: MAS830CBGLO
 UPC CODE: 810053672525
 EAN CODE: 8435394778167

FEATURE

- Diode Open Voltage 3.0V.
- Data Hold.
- Low Battery Display.
- Sample Rate 500mS.

SPECIFICATIONS

AC Voltage 600V	DC Voltage 600V	DC Current 10A
Resistance 2MΩ	Display Counts 2000	Continuity <70±30Ω

MAIN APPLICATIONS

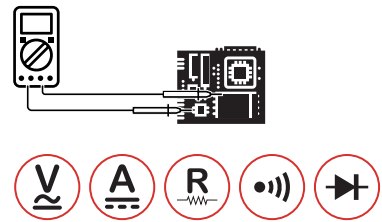
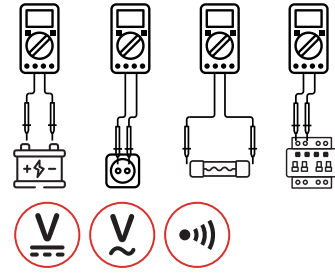

CONTENTS



145×76×40mm
 5.7"×3"×1.57"
 202g/0.44lb



1×9V 6F22
 Battery



Test Leads



Calibration
 Certificate

ACCESSORIES



Quick Start
 Guide

PACKAGING INFORMATION



Color Box
 L145×W60×H188mm



Carton Box
 40×32×31.5cm



X 20PCS



MAIN APPLICATIONS



DOMESTIC

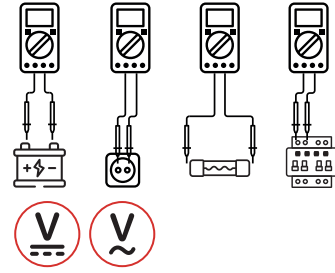

ELECTRONICS

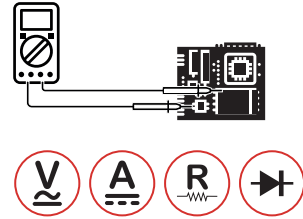

DIGITAL MULTIMETER

MAS830B

SKU NO.: MAS830BCBGLO
 UPC CODE: 810053674864
 EAN CODE: 8435394782072

FEATURE

- Diode Open Voltage 3.0V.
- Data Hold.
- Low Battery Display.
- Continuity Buzzer <math><70 \pm 30\Omega</math>.

SPECIFICATIONS

AC Voltage 600V	DC Voltage 600V	DC Current 10A
Resistance 2MΩ	Display Counts 2000	

CONTENTS



145x76x40mm
 5.7"x3"x1.57"
 202g/0.44lb



1x9V 6F22
 Battery



Test Leads



Calibration
 Certificate

ACCESSORIES



Quick Start
 Guide

PACKAGING INFORMATION



Color Box
 L145xW60xH188mm



Carton Box
 40x32x31.5cm



X 20PCS



DIGITAL MULTIMETER

MAS830L

SKU NO.: MAS830LCBGLO
 UPC CODE: 810053671993
 EAN CODE: 843539477726

FEATURE

- Diode Open Voltage 3.0V.
- Data Hold.
- Low Battery Display.
- Continuity Buzzer <math><70 \pm 30\Omega</math>.

SPECIFICATIONS

AC Voltage 600V	DC Voltage 600V	DC Current 10A
Resistance 2MΩ	Display Counts 2000	Continuity <math><70\pm 30\Omega</math>

MAIN APPLICATIONS

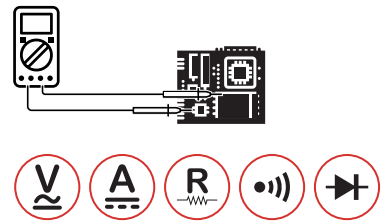
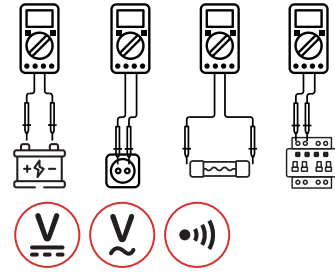

CONTENTS



145×76×40mm
 5.7"×3"×1.57"
 202g/0.44lb



1×9V 6F22
 Battery



Test Leads



Calibration
 Certificate

ACCESSORIES



Quick Start
 Guide

PACKAGING INFORMATION



Color Box
 L145×W60×H188mm



Carton Box
 40×32×31.5cm



X 20PCS



DIGITAL MULTIMETER

MAS838

SKU NO.: MAS838CBGLO
 UPC CODE: 810053672365
 EAN CODE: 8435394784304

FEATURE

- Diode Open Voltage 3.0V.
- Data Hold.
- Low Battery Display.
- Continuity Buzzer <math><70 \pm 30\Omega</math>.

SPECIFICATIONS

AC Voltage 600V	DC Voltage 600V	DC Current 10A
Resistance 2MΩ	Display Counts 2000	Continuity <math><70 \pm 30\Omega</math>
Temperature -20°C~1000°C		

MAIN APPLICATIONS

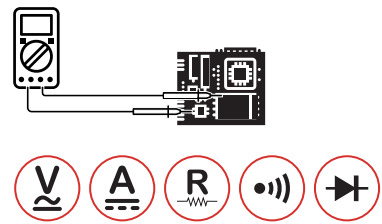
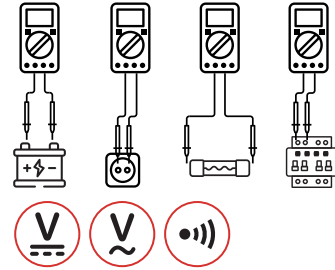

CONTENTS



145×76×40mm
 5.7"×3"×1.57"
 202g/0.44lb



1×9V 6F22
 Battery



Test Leads
 K-type thermocouple

ACCESSORIES



Calibration
 Certificate



Quick Start
 Guide

PACKAGING INFORMATION



Color Box
 L145×W60×H188mm



Carton Box
 40×32×31.5cm



X 20PCS



MAIN APPLICATIONS



DOMESTIC

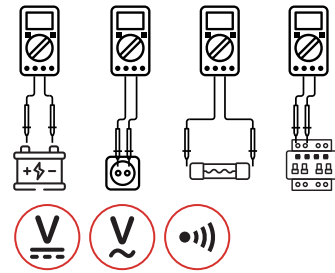

ELECTRONICS

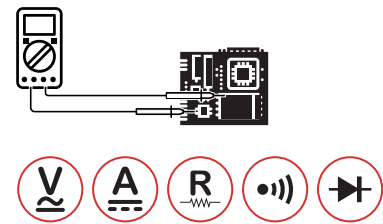

DIGITAL MULTIMETER

MS8233A

SKU NO.: MS8233ACBGLO
 UPC CODE: 810053673140
 EAN CODE: 8435394778877

FEATURE

- Diode Open Voltage 3.0V.
- Continuity Buzzer <60Ω.
- Data Hold.
- Low Battery Display.

SPECIFICATIONS

AC Voltage 600V	DC Voltage 600V	DC Current 10A
Resistance 2MΩ	Continuity <60Ω	Display Counts 2000

CONTENTS



140×67×30mm
 5.5"×2.6"×1.2"
 112g/0.25lb



1×9V 6F22
 Battery



ACCESSORIES

Test Leads
 Battery



Calibration
 Certificate



Quick Start
 Guide

PACKAGING INFORMATION



Color Box
 L145×W60×H188mm



Carton Box
 49×28×37cm



X 20PCS



MAIN APPLICATIONS



DOMESTIC

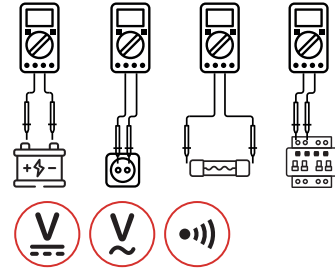

ELECTRONICS

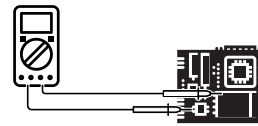

DIGITAL MULTIMETER

MS8233B

SKU NO.: MS8233BCBGLO
 UPC CODE: 810053674840
 EAN CODE: 8435394783369

FEATURE

- Diode Open Voltage 3.0V.
- Low Battery Display.
- Display Backlight.
- Non-contact Voltage Detection.

SPECIFICATIONS

AC Voltage 600V	DC Voltage 600V	DC Current 10A
Resistance 2MΩ	Continuity <60Ω	Display Counts 2000

CONTENTS



140×67×30mm
 5.5"×2.6"×1.2"
 112g/0.25lb



1×9V 6F22
 Battery



ACCESSORIES

Test Leads
 Battery



Calibration
 Certificate



Quick Start
 Guide

PACKAGING INFORMATION



Color Box
 L145×W60×H188mm



Carton Box
 40×32×31.5cm



X 20PCS



DIGITAL MULTIMETER

MS8233C

SKU NO.: MS8233CCBGLO
 UPC CODE: 810053672228
 EAN CODE: 8435394777948

FEATURE

- Diode Open Voltage 3.0V.
- Low Battery Display.
- Display Backlight.
- Non-contact Voltage Detection.

SPECIFICATIONS

AC Voltage 600V	DC Voltage 600V	DC Current 10A
Resistance 2MΩ	Continuity <60Ω	Display Counts 2000
Temperature -20°C~1000°C/-4°F~1832°F		

MAIN APPLICATIONS

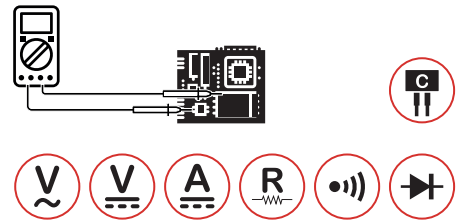
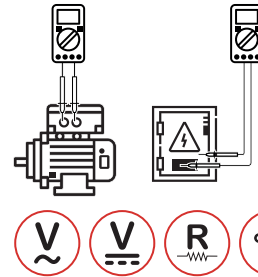
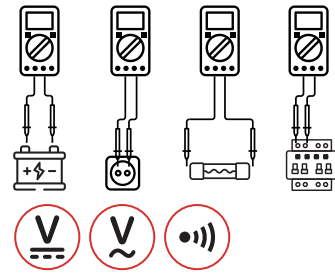

CONTENTS



140×67×30mm
 5.5"×2.6"×1.2"
 112g/0.25lb



1×9V 6F22
 Battery



ACCESSORIES

Test Leads
 K-type thermocouple
 Battery



Calibration
 Certificate



Quick Start
 Guide

PACKAGING INFORMATION



Color Box
 L145×W60×H188mm



Carton Box
 40×32×31.5cm



X 20PCS



MAIN APPLICATIONS



DOMESTIC

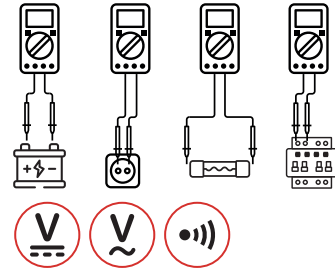

ELECTRONICS

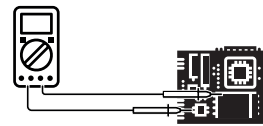

DIGITAL MULTIMETER

MS8238

SKU NO.: MS8238CBGLO
 UPC CODE: 810053672662
 EAN CODE: 8435394778303

FEATURE

- Diode Open Voltage 3.0V.
- Battery Test 1.5V/9V/12V.
- Data Hold.
- Low Battery Display.

SPECIFICATIONS

AC Voltage 600V	DC Voltage 600V	DC Current 10A
Resistance 2MΩ	Continuity <50Ω	Display Counts 2000

CONTENTS



148×73.5×50mm
 5.8"×2.9"×1.96"
 232g/0.51lb



1×9V 6F22
 Battery



Test Leads
 Battery

ACCESSORIES



Calibration
 Certificate



Quick Start
 Guide

PACKAGING INFORMATION



Color Box
 L145×W60×H188mm



Carton Box
 40×32×31.5cm



X 20PCS



DIGITAL MULTIMETER MS8261

SKU NO.: MS8261CBGLO
UPC CODE: 810053674437
EAN CODE: 8435394779508

FEATURE

- Auto Power Off.
- Transistor hFE 0~1000.
- Diode Open Voltage 3.0V.
- Data Hold.

SPECIFICATIONS

AC Voltage 750V	DC Voltage 1000V	AC Current 10A
DC Current 10A	Resistance 200MΩ	Continuity <70Ω
Capacitance 20μF	Display Counts 2000	

MAIN APPLICATIONS

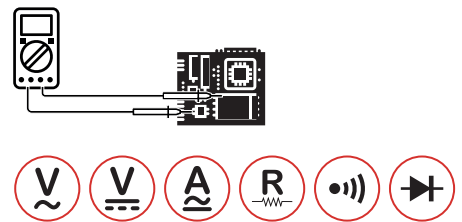
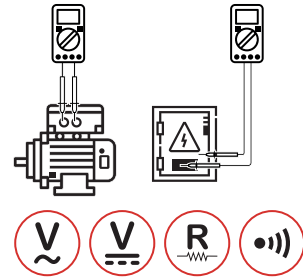
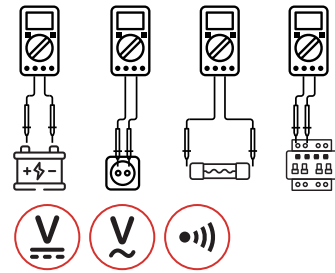

CONTENTS



195×92×55mm
7.7"×3.6"×2.2"
380g/0.83lb



1×9V 6F22
Battery



ACCESSORIES

Test leads
Multi-function socket
Battery



Calibration
Certificate



Quick Start
Guide

PACKAGING INFORMATION



Color Box
L165×W70×H225mm



Carton Box
47×37.5×35.5cm



X 20PCS



MAIN APPLICATIONS

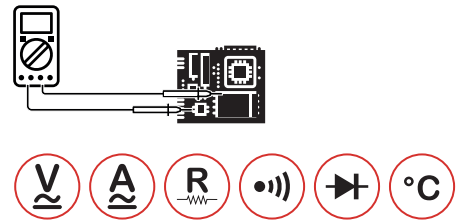
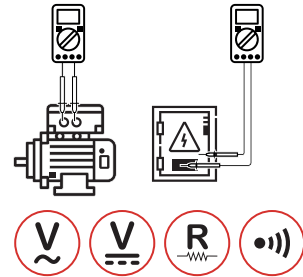
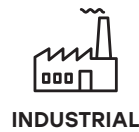
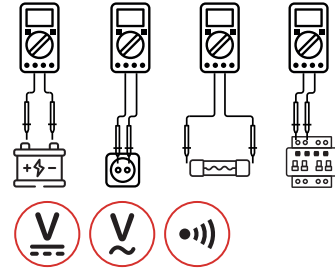

DIGITAL MULTIMETER
MS8264

SKU NO.: MS8264CBGLO
UPC CODE: 810053674444
EAN CODE: 8435394779515

FEATURE

- Auto Power Off.
- Transistor hFE 0~1000.
- Diode Open Voltage 3.0V.
- Data Hold.

SPECIFICATIONS

AC Voltage 750V	DC Voltage 1000V	AC Current 10A
DC Current 10A	Resistance 200MΩ	Continuity <70Ω
Capacitance 20μF	Frequency 20kHz	Display Counts 2000
Temperature -20°C~1000°C		

CONTENTS

	195×92×55mm 7.7"×3.6"×2.2" 380g/0.83lb		1×9V 6F22 Battery
	Test leads K type thermocouple Multi-function socket Battery		Calibration Certificate
			Quick Start Guide

PACKAGING INFORMATION

	Color Box L165×W70×H225mm		Carton Box 47×37.5×35.5cm		X 20PCS
--	-------------------------------------	--	-------------------------------------	--	----------------



DIGITAL MULTIMETER MS8269

SKU NO.: MS8269CBGLO
UPC CODE: 810053674468
EAN CODE: 8435394779539

FEATURE

- Auto Power Off.
- Transistor hFE 0~1000.
- Diode Open Voltage 3.0V.
- Data Hold.

SPECIFICATIONS

AC Voltage 750V	DC Voltage 1000V	AC Current 10A
DC Current 10A	Resistance 20MΩ	Continuity test <70Ω
Capacitance 200μF	Inductance 20H	Display Counts 2000
Temperature -20°C~1000°C		

MAIN APPLICATIONS

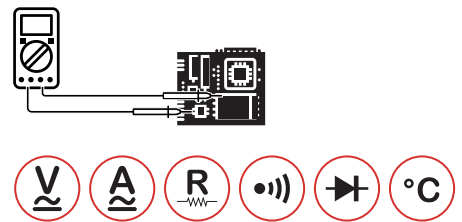
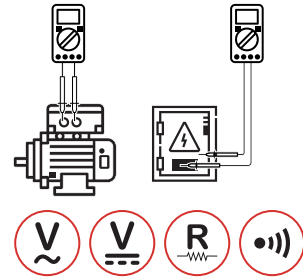
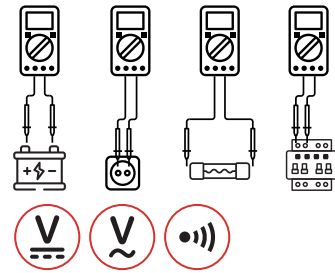

CONTENTS



195×92×55mm
7.7"×3.6"×2.2"
380g/0.83lb



1×9V 6F22
Battery



ACCESSORIES

Test leads
K type thermocouple
Multi-function socket
Battery



Calibration
Certificate



Quick Start
Guide

PACKAGING INFORMATION



Color Box
L165×W70×H225mm



Carton Box
47×37.5×35.5cm



X 20PCS



MAIN APPLICATIONS



DOMESTIC

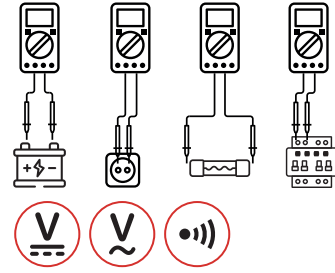

ELECTRONICS

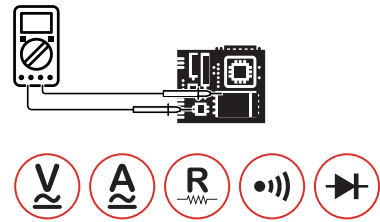

DIGITAL MULTIMETER

MS8301A

SKU NO.: MS8301ACBGLO
 UPC CODE: 810053675540
 EAN CODE: 8435394784298

FEATURE

- Display 2000 Counts.
- Data hold.
- Battery Tester 1.5V/9V.

SPECIFICATIONS

AC Voltage 600V	DC Voltage 600V	DC Current 10A
Resistance 2MΩ	Continuity test <30Ω	Display Counts 2000

CONTENTS



145×60×188mm
 5.7"×2.4"×7.4"
 220g/0.48lb



2×1.5V AAA
 Batteries



ACCESSORIES

Test Leads
 Battery



Calibration
 Certificate



Quick Start
 Guide

PACKAGING INFORMATION



Color Box
 L145×W60×H188mm



Carton Box
 40×32×31.5cm



X 20PCS



MAIN APPLICATIONS



DOMESTIC

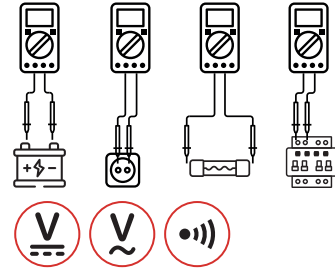

ELECTRONICS

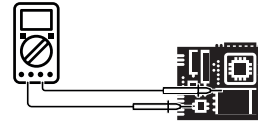

DIGITAL MULTIMETER

MS8301B

SKU NO.: MS8301BCBGLO
 UPC CODE: 810053676769
 EAN CODE: 8435394785295

FEATURE

- Display 4000 Counts.
- Back Light.
- Non-contact Voltage Detector.

SPECIFICATIONS

AC Voltage 600V	DC Voltage 600V	AC Current 10A
DC Current 10A	Resistance 40MΩ	Continuity test <50Ω
Capacitance 100μF	Frequency 10kHz	Display Counts 4000
Temperature -4°F~1832°F		

CONTENTS



145×60×188mm
 5.7"×2.4"×7.4"
 220g/0.48lb



3×1.5V AAA
 Batteries



ACCESSORIES

Test leads
 K type thermocouple
 Battery



Calibration
 Certificate



Quick Start
 Guide

PACKAGING INFORMATION



Color Box
 L145×W60×H188mm



Carton Box
 40×32×31.5cm



X 20PCS



MAIN APPLICATIONS



DOMESTIC

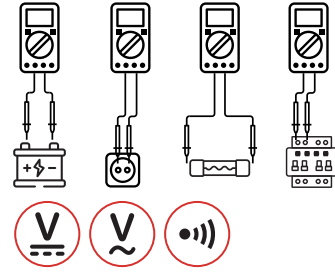

ELECTRONICS

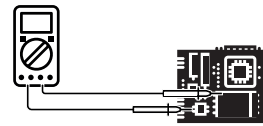

DIGITAL MULTIMETER

MS8321A

SKU NO.: MS8321ACBGLO
 UPC CODE: 810053674475
 EAN CODE: 8435394779546

FEATURE

- Manual Ranging.
- Auto Power Off.
- Data Hold.
- Diode Open Voltage 3.0V.

SPECIFICATIONS

AC Voltage 600V	DC Voltage 600V	AC Current 10A
DC Current 10A	Resistance 20MΩ	Continuity <40Ω
Display Counts 2000		

CONTENTS



158×74×36mm
 5.8"×2.87"×1.5"
 220g/0.48lb



1×9V 6F22
 Battery



ACCESSORIES

Test leads
 Multi-function socket
 Battery



Calibration
 Certificate



Quick Start
 Guide

PACKAGING INFORMATION



Color Box
 L145×W60×H188mm



Carton Box
 40×32×31.5cm



X 20PCS



MAIN APPLICATIONS



DOMESTIC

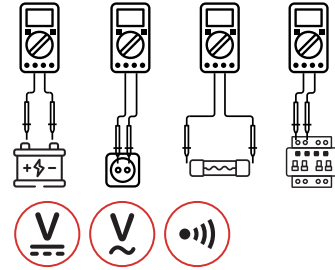

ELECTRONICS

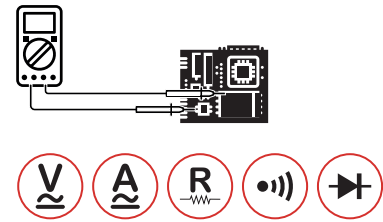

DIGITAL MULTIMETER

MS8321D

SKU NO.: MS8321DCBGLO
 UPC CODE: 810053675342
 EAN CODE: 8435394783390

FEATURE

- Manual Ranging.
- Auto Power Off.
- Data Hold.
- Low Battery Display.

SPECIFICATIONS

AC Voltage 750V	DC Voltage 1000V	AC Current 20A
DC Current 20A	Resistance 20MΩ	Continuity <60Ω
Display Counts 2000		

CONTENTS



158×74×36mm
 5.8"×2.87"×1.5"
 220g/0.48lb



1×9V 6F22
 Battery



ACCESSORIES

Test Leads
 Battery



Calibration
 Certificate



Quick Start
 Guide

PACKAGING INFORMATION



Color Box
 L145×W60×H188mm



Carton Box
 40×32×31.5cm



X 20PCS



MAIN APPLICATIONS



DOMESTIC

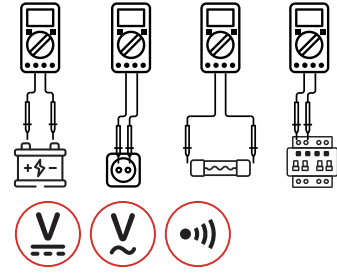

INDUSTRIAL

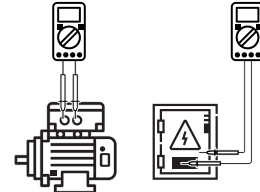

ELECTRONICS

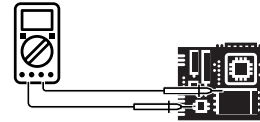

DIGITAL MULTIMETER

MS8360C

SKU NO.: MS8360CCBGLO
 UPC CODE: 810053674925
 EAN CODE: 8435394782669

FEATURE

- Auto Power Off.
- Non-Contact Voltage Detector.
- Transistor hFE 0~1000.
- Diode Open Voltage 3.0V.

SPECIFICATIONS

AC Voltage 600V	DC Voltage 600V	AC Current 10A
DC Current 10A	Resistance 200MΩ	Continuity <50Ω
Capacitance 200μF	Frequency 20kHz	Display Counts 2000
Temperature -20°C~1000°C/-4°F~1832°F		

CONTENTS



188×92×50mm
 7.4"×3.6"×2.0"
 380g/0.83lb



1×9V 6F22
 Battery



ACCESSORIES

Test leads
 K type thermocouple
 Multi-function socket
 Battery



Calibration
 Certificate



Quick Start
 Guide

PACKAGING INFORMATION



Color Box
 L165×W70×H225mm



Carton Box
 47×37.5×35.5cm



X 20PCS



DIGITAL MULTIMETER

MS8360E

SKU NO.: MS8360ECBGLO
 UPC CODE: 810053674499
 EAN CODE: 8435394779560

FEATURE

- Auto Power Off.
- Non-Contact Voltage Detector.
- Transistor hFE 0~1000.
- Diode Open Voltage 3.0V.

SPECIFICATIONS

AC Voltage 600V	DC Voltage 600V	AC Current 10A
DC Current 10A	Resistance 200MΩ	Continuity test <50Ω
Capacitance 200μF	Frequency 20kHz	Display counts 2000

MAIN APPLICATIONS

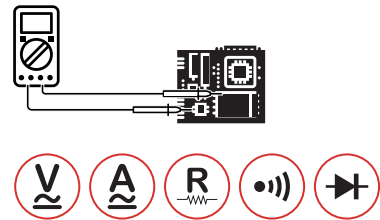
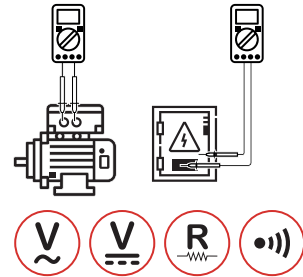
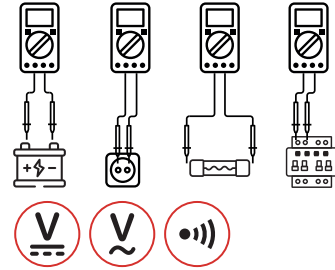

CONTENTS



188×92×50mm
 7.4"×3.6"×2.0"
 380g/0.83lb



1×9V 6F22
 Battery



ACCESSORIES

Test leads
 Multi-function socket
 Battery



Calibration
 Certificate



Quick Start
 Guide

PACKAGING INFORMATION



Color Box
 L165×W70×H225mm



Carton Box
 47×37.5×35.5cm



X 20PCS



MAIN APPLICATIONS



DOMESTIC

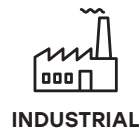
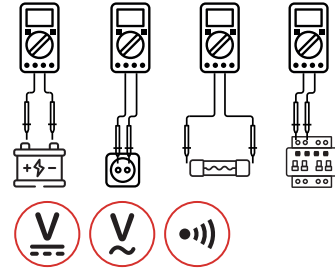

INDUSTRIAL

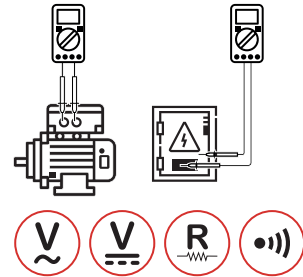

ELECTRONICS

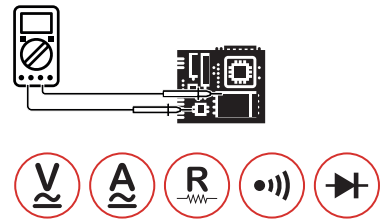

DIGITAL MULTIMETER
MY60

SKU NO.: MY60CBGLO
UPC CODE: 810053672426
EAN CODE: 8435394778068

FEATURE

- Auto Power Off.
- Transistor hFE 0~1000.
- Diode Open Voltage 3.0V.
- Data Hold.

SPECIFICATIONS

AC Voltage 750V	DC Voltage 1000V	AC Current 10A
DC Current 10A	Resistance 200MΩ	Capacitance 100μF
Frequency 20kHz	Continuity <50Ω	Display Counts 2000

CONTENTS



195×95×55mm
7.67"×3.74"×2.16"
366g/0.8lb



1×9V 6F22
Battery



ACCESSORIES

Test leads
Multi-function socket
Battery



Calibration
Certificate



Quick Start
Guide

PACKAGING INFORMATION



Color Box
L165×W70×H225mm



Carton Box
47×37.5×35.5cm



X 20PCS



MAIN APPLICATIONS



DOMESTIC

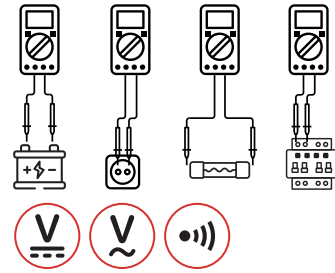

INDUSTRIAL

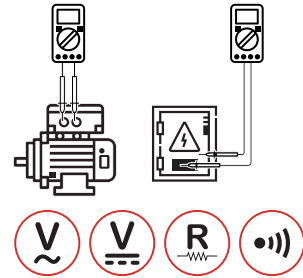

ELECTRONICS

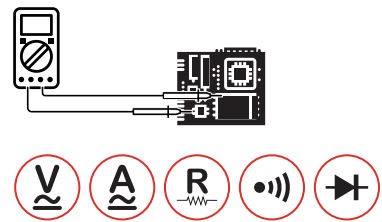

DIGITAL MULTIMETER
MY61

SKU NO.: MY61CBGLO
UPC CODE: 810053672419
EAN CODE: 8435394778051

FEATURE

- Auto Power Off.
- Transistor hFE 0~1000.
- Diode Open Voltage 3.0V.
- Data Hold.

SPECIFICATIONS

AC Voltage 750V	DC Voltage 1000V	AC Current 10A
DC Current 10A	Resistance 200MΩ	Capacitance 100μF
Frequency 20kHz	Continuity <50Ω	Display Counts 2000

CONTENTS



195×95×55mm
7.67"×3.74"×2.16"
366g/0.8lb



1×9V 6F22
Battery



ACCESSORIES

Test leads
Multi-function socket
Battery



Calibration
Certificate



Quick Start
Guide

PACKAGING INFORMATION



Color Box
L165×W70×H225mm



Carton Box
47×37.5×35.5cm



X 20PCS



MAIN APPLICATIONS



DOMESTIC

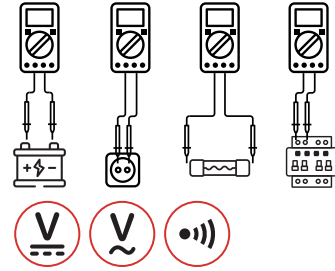

INDUSTRIAL

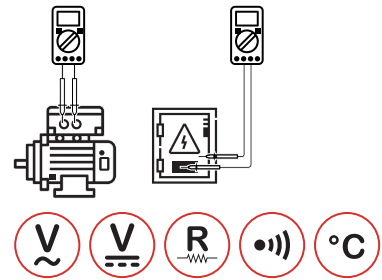

ELECTRONICS

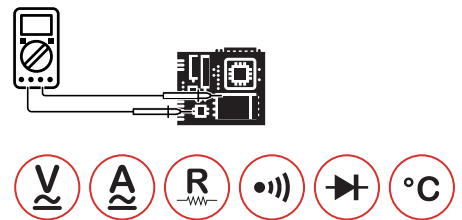

DIGITAL MULTIMETER
MY62

SKU NO.: MY62CBGLO
UPC CODE: 810053672433
EAN CODE: 8435394778075

FEATURE

- Auto Power Off.
- Transistor hFE 0~1000.
- Diode Open Voltage 3.0V.
- Data Hold.

SPECIFICATIONS

AC Voltage 750V	DC Voltage 1000V	AC Current 10A
DC Current 10A	Resistance 200MΩ	Capacitance 100μF
Frequency 20kHz	Continuity <50Ω	Display Counts 2000
Temperature -20°C~1000°C		

CONTENTS



195×95×55mm
7.67"×3.74"×2.16"
366g/0.8lb



1×9V 6F22
Battery



ACCESSORIES

Test leads
K type thermocouple
Multi-function socket
Battery



Calibration
Certificate



Quick Start
Guide

PACKAGING INFORMATION



Color Box
L165×W70×H225mm



Carton Box
47×37.5×35.5cm



X 20PCS



MAIN APPLICATIONS



DOMESTIC

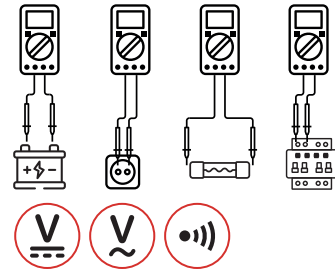

INDUSTRIAL

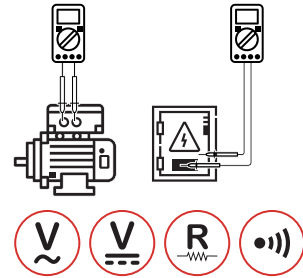

ELECTRONICS

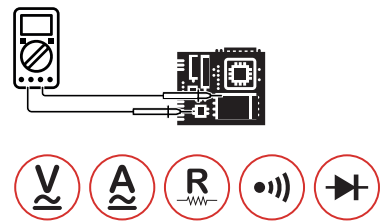

DIGITAL MULTIMETER
MY63

SKU NO.: MY63CBGLO
UPC CODE: 810053674833
EAN CODE: 8435394782003

FEATURE

- Auto Power Off.
- Transistor hFE 0~1000.
- Diode Open Voltage 3.0V.
- Data Hold.

SPECIFICATIONS

AC Voltage 750V	DC Voltage 1000V	AC Current 10A
DC Current 10A	Resistance 200MΩ	Capacitance 100μF
Frequency 20kHz	Continuity <50Ω	Display Counts 2000

CONTENTS



195×95×55mm
7.67"×3.74"×2.16"
366g/0.8lb



1×9V 6F22
Battery



ACCESSORIES

Test leads
Multi-function socket
Battery



Calibration
Certificate



Quick Start
Guide

PACKAGING INFORMATION



Color Box
L165×W70×H225mm



Carton Box
47×37.5×35.5cm



X 20PCS



DIGITAL MULTIMETER
MY64

SKU NO.: MY64CBGLO
UPC CODE: 810053673324
EAN CODE: 8435394779058

FEATURE

- Auto Power Off.
- Transistor hFE 0~1000.
- Diode Open Voltage 3.0V.
- Data Hold.

SPECIFICATIONS

AC Voltage 750V	DC Voltage 1000V	AC Current 10A
DC Current 10A	Resistance 200MΩ	Capacitance 100μF
Frequency 20kHz	Continuity <50Ω	Display Counts 2000
Temperature -20°C~1000°C		

MAIN APPLICATIONS



DOMESTIC

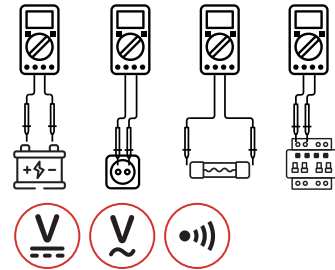

INDUSTRIAL

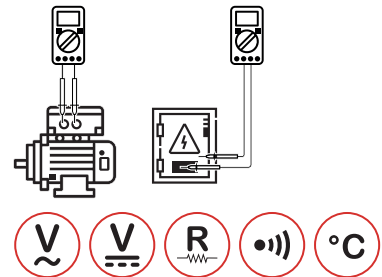

ELECTRONICS

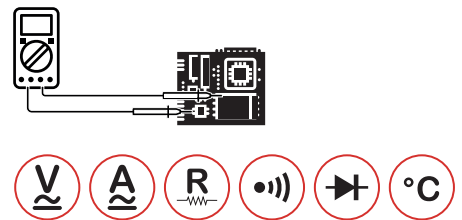

CONTENTS



195×95×55mm
7.67"×3.74"×2.16"
366g/0.8lb



1×9V 6F22
Battery



ACCESSORIES

Test leads
K type thermocouple
Multi-function socket
Battery



Calibration
Certificate



Quick Start
Guide

PACKAGING INFORMATION



Color Box
L165×W70×H225mm



Carton Box
47×37.5×35.5cm



X 20PCS



DIGITAL MULTIMETER
MY65

SKU NO.: MY65CBGLO
UPC CODE: 810053672440
EAN CODE: 8435394778082

FEATURE

- Auto Power Off.
- Transistor hFE 0~1000.
- Diode Open Voltage 3.0V.
- Data Hold.

SPECIFICATIONS

AC Voltage 750V	DC Voltage 1000V	AC Current 10A
DC Current 10A	Resistance 200MΩ	Capacitance 100μF
Frequency 20kHz	Continuity <70Ω	Display Counts 20000

MAIN APPLICATIONS



DOMESTIC

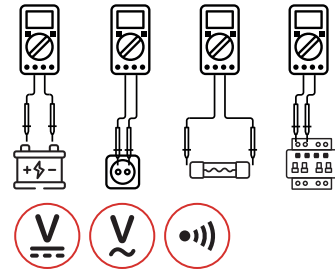

INDUSTRIAL

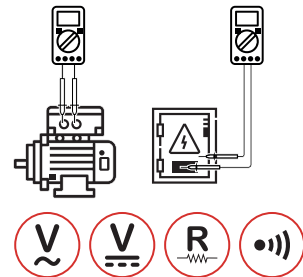

ELECTRONICS

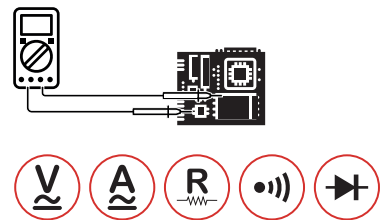

CONTENTS



195×95×55mm
7.67"×3.74"×2.16"
366g/0.8lb



1×9V 6F22
Battery



ACCESSORIES

Test leads
Multi-function socket
Battery



Calibration
Certificate



Quick Start
Guide

PACKAGING INFORMATION



Color Box
L165×W70×H225mm



Carton Box
47×37.5×35.5cm



X 20PCS



DIGITAL MULTIMETER
MY70

SKU NO.: MY70CBGLO
UPC CODE: 810053672280
EAN CODE: 8435394778006

FEATURE

- Auto Power Off.
- Transistor hFE 0~1000.
- Diode Open Voltage 3.0V.
- Data Hold.

SPECIFICATIONS

AC Voltage 600V	DC Voltage 600V	AC Current 10A
DC Current 10A	Resistance 200MΩ	Continuity <50Ω
Display Counts 2000		

MAIN APPLICATIONS

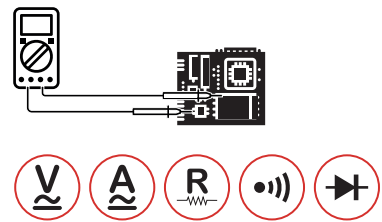
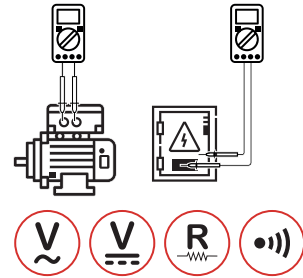
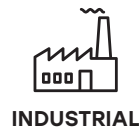
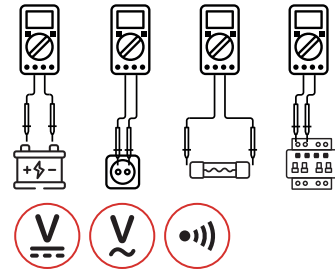

CONTENTS



188×93×50mm
7.4"×3.7"×1.96"
380g/0.84lb



1×9V 6F22
Battery



ACCESSORIES

Test leads
Multi-function socket
Battery



Calibration
Certificate



Quick Start
Guide

PACKAGING INFORMATION



Color Box
L165×W70×H225mm



Carton Box
47×37.5×35.5cm



X 20PCS



DIGITAL MULTIMETER
MY74

SKU NO.: MY74CBGLO
UPC CODE: 810053672297
EAN CODE: 8435394778013

FEATURE

- Auto Power Off.
- Transistor hFE 0~1000.
- Diode Open Voltage 3.0V.
- Data Hold.

SPECIFICATIONS

AC Voltage 600V	DC Voltage 600V	AC Current 10A
DC Current 10A	Resistance 200MΩ	Capacitance 100μF
Frequency 20kHz	Continuity <50Ω	Display Counts 2000
Temperature -20°C~1000°C		

MAIN APPLICATIONS

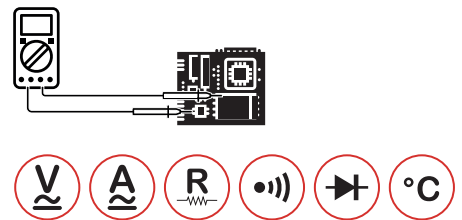
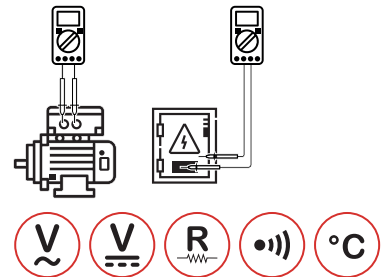
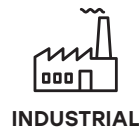
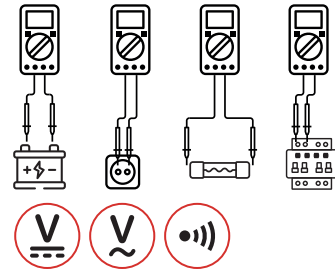

CONTENTS



188×93×50mm
7.4"×3.7"×1.96"
380g/0.84lb



1×9V 6F22
Battery



ACCESSORIES

Test leads
K type thermocouple
Multi-function socket
Battery



Calibration
Certificate



Quick Start
Guide

PACKAGING INFORMATION



Color Box
L165×W70×H225mm



Carton Box
47×37.5×35.5cm



X 20PCS



DIGITAL MULTIMETER
MY75

SKU NO.: MY75CBGLO
UPC CODE: 810053672303
EAN CODE: 8435394778020

FEATURE

- Diode Open Voltage 3.0V.
- Transistor hFE 0~1000.
- Data Hold.
- Auto Power Off.

SPECIFICATIONS

AC Voltage 600V	DC Voltage 600V	AC Current 10A
DC Current 10A	Resistance 200MΩ	Capacitance 200nF
Frequency 20kHz	Continuity <60Ω	Display Counts 20000

MAIN APPLICATIONS

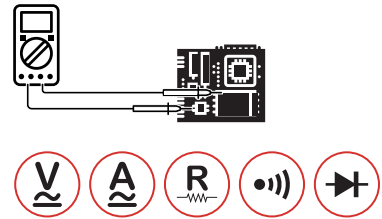
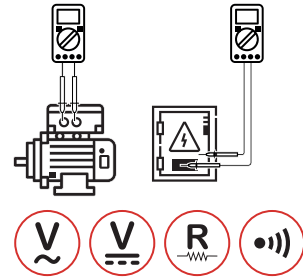
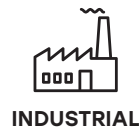
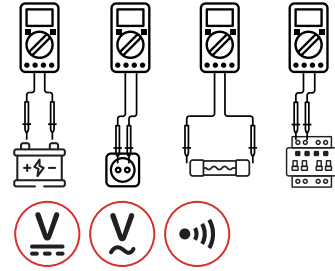

CONTENTS



188×93×50mm
7.4"×3.7"×1.96"
380g/0.84lb



1×9V 6F22
Battery



ACCESSORIES

Test leads
Multi-function socket
Battery



Calibration
Certificate



Quick Start
Guide

PACKAGING INFORMATION



Color Box
L165×W70×H225mm



Carton Box
47×37.5×35.5cm



X 20PCS



MAIN APPLICATIONS

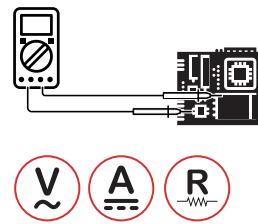
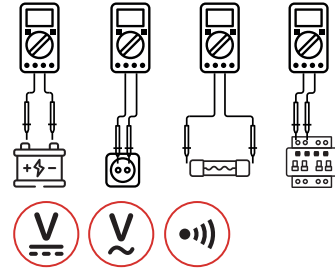

NEW

DIGITAL MULTIMETER

MS820L

SKU NO.: MS820LCBGLO
 UPC CODE: 810053678183
 EAN CODE: 8435394787787

FEATURE

- Display 2000 counts.
- Data Hold.
- Auto Power Off.

SPECIFICATIONS

AC Voltage 500V	DC Voltage 500V	DC Current 10A
Resistance 200MΩ	Continuity <50±20Ω	Display Counts 2000

CONTENTS



115x65x30mm
 4.5"x2.6"x1.2"
 170g/0.37lb



2x1.5V AAA
 Batteries



Test Leads
 Battery

ACCESSORIES



Calibration
 Certificate



Quick Start
 Guide

PACKAGING INFORMATION



Color Box
 L145xW50xH160mm



Carton Box
 53.8x30.8x17.8cm



X 20PCS



MAIN APPLICATIONS



DOMESTIC

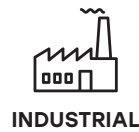
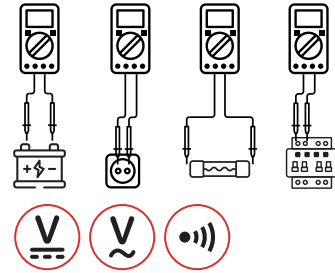

INDUSTRIAL

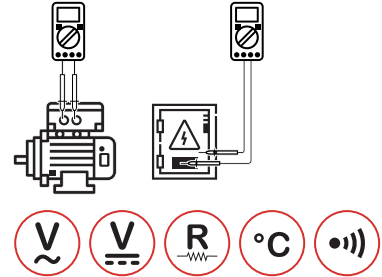

ELECTRONICS

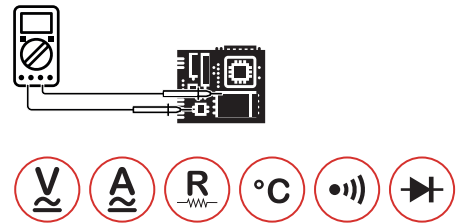

DIGITAL MULTIMETER
MS8217

SKU NO.: MS8217CBGLO
UPC CODE: 810053673263
EAN CODE: 8435394778990

FEATURE

- Auto & Manual Ranging.
- Auto Power Off.
- Relative Measurement.
- Diode Open Voltage 1.5V.

SPECIFICATIONS

AC Voltage 1000V	DC Voltage 1000V	AC Current 10A
DC Current 10A	Resistance 40MΩ	Capacitance 100uF
Frequency 100kHz	Continuity <50±20Ω	Display Counts 2000
Temperature -55°C~1000°C		

CONTENTS

- 185×87×53mm
7.28"×3.4"×2.04"
360g/0.79lb
- 3×1.5V AAA Batteries
- Test leads
K type thermocouple
Multi-function socket
Battery
- Calibration Certificate
- Quick Start Guide

PACKAGING INFORMATION

- Color Box**
L165×W70×H225mm
- Carton Box**
47×37.5×35.5cm
- X 20PCS**



DIGITAL MULTIMETER

MS8221C

SKU NO.: MS8221CCBGLO
 UPC CODE: 810053672310
 EAN CODE: 8435394778457

FEATURE

- Auto & Manual Ranging.
- Auto Power Off.
- Relative Measurement.
- Diode Open Voltage 1.5V.

SPECIFICATIONS

AC Voltage 600V	DC Voltage 600V	AC Current 10A
DC Current 10A	Resistance 20MΩ	Capacitance 1000uF
Frequency 400kHz	Continuity <50±20Ω	Display Counts 2000
Temperature -20°C~1000°C		

MAIN APPLICATIONS

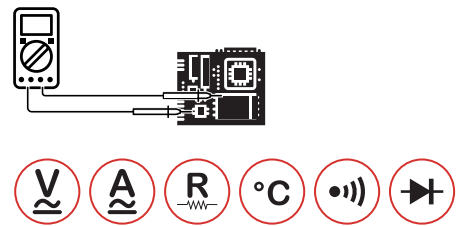
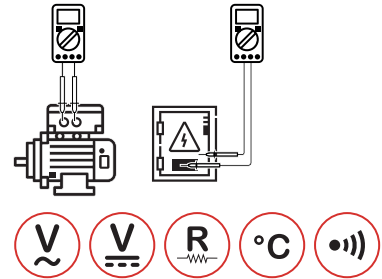
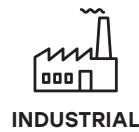
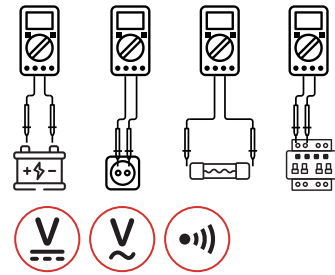

CONTENTS



158×74×32mm
 6.2"×2.9"×1.2"
 250g/0.55lb



3×1.5V AAA
 Battery



ACCESSORIES

Test leads
 K type thermocouple
 Multi-function socket
 Battery



Calibration
 Certificate



Quick Start
 Guide

PACKAGING INFORMATION



Color Box
 L145×W60×H188mm



Carton Box
 40×32×31.5cm



X 20PCS



MAIN APPLICATIONS



DOMESTIC

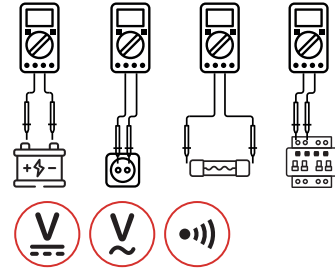

INDUSTRIAL

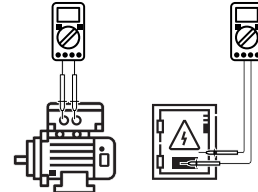

ELECTRONICS

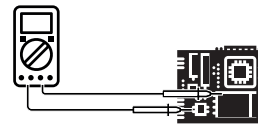

DIGITAL MULTIMETER

MS8233D

SKU NO.: MS8233DCBGLO
 UPC CODE: 810053673201
 EAN CODE: 8435394778938

FEATURE

- Non-contact Voltage Detection.
- Maximum Measurement.
- Display Backlight.
- Low Battery Display.

SPECIFICATIONS

AC Voltage 600V	DC Voltage 600V	AC Current 10A
DC Current 10A	Resistance 20MΩ	Continuity <60Ω
Display Counts 2000		

CONTENTS



140×67×30mm
 5.5"×2.6"×1.2"
 112g/0.25lb



1×9V 6F22
 Battery



Test Leads
 Battery

ACCESSORIES



Calibration
 Certificate



Quick Start
 Guide

PACKAGING INFORMATION



Color Box
 L145×W60×H188mm



Carton Box
 40×32×31.5cm



X 20PCS



MAIN APPLICATIONS



DOMESTIC

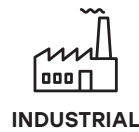
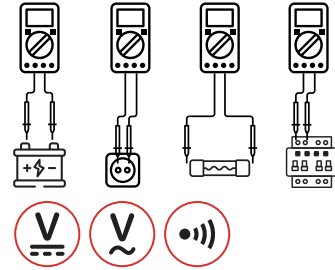

INDUSTRIAL

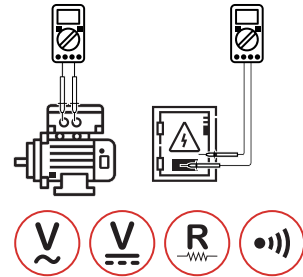

ELECTRONICS

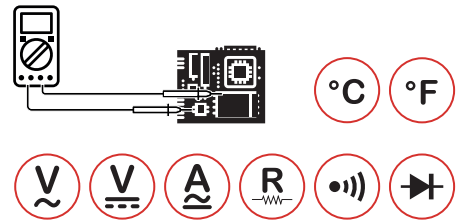

DIGITAL MULTIMETER
MS8233E

SKU NO.: MS8233ECBGLO
UPC CODE: 810053672259
EAN CODE: 8435394777979

FEATURE

- Non-contact Voltage Detection.
- Maximum Measurement.
- Display Backlight.
- Low Battery Display.

SPECIFICATIONS

AC Voltage 600V	DC Voltage 600V	AC Current 10A
DC Current 10A	Resistance 20MΩ	Continuity <60Ω
Display Counts 2000	Temperature -20°C~1000°C/-4°F~1832°F	

CONTENTS



140×67×30mm
5.5"×2.6"×1.2"
112g/0.25lb



1×9V 6F22
Battery



ACCESSORIES

Test leads
K type thermocouple
Battery



Calibration
Certificate



Quick Start
Guide

PACKAGING INFORMATION



Color Box
L145×W60×H188mm



Carton Box
40×32×31.5cm



X 20PCS



MAIN APPLICATIONS



DOMESTIC

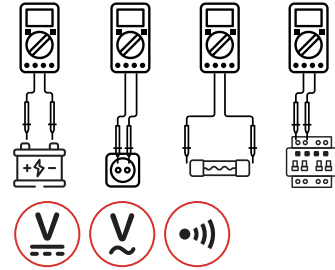

INDUSTRIAL

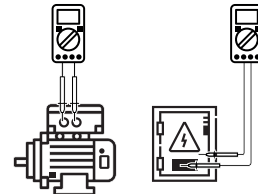

ELECTRONICS

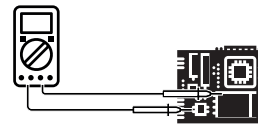

DIGITAL MULTIMETER WITH WIRELESS
MS8238H

SKU NO.: MS8238HCBGLO
UPC CODE: 810053675335
EAN CODE: 8435394783383

FEATURE

- Auto Power Off.
- True RMS For AC Voltage & AC Current.
- Wireless APP connection.
- Non-Contact Voltage Detector.

SPECIFICATIONS

AC Voltage 600V	DC Voltage 600V	AC Current 10A
DC Current 10A	Resistance 40MΩ	Continuity <50Ω
Display Counts 4000	Temperature -20°C~1000°C/-4°F~1832°F	

CONTENTS



148×73.5×50mm
5.8"×2.9"×1.96"
241g/0.53lb



1×9V 6F22
Battery



ACCESSORIES

Test leads
K type thermocouple
Battery



Calibration
Certificate



Quick Start
Guide

PACKAGING INFORMATION



Color Box
L145×W60×H188mm



Carton Box
40×32×31.5cm



X 20PCS



DIGITAL MULTIMETER

MS8239C

SKU NO.: MS8239CCBGLO
 UPC CODE: 810053672266
 EAN CODE: 8435394777986

FEATURE

- Auto & Manual Ranging.
- Auto Power Off.
- Diode Open Voltage 1.5V.
- Data Hold.

SPECIFICATIONS

AC Voltage 600V	DC Voltage 600V	AC Current 10A
DC Current 10A	Resistance 40MΩ	Continuity <50±20Ω
Frequency 10kHz	Temperature -20°C~1000°C/-4°F~1832°F	
Display Counts 4000		

MAIN APPLICATIONS



DOMESTIC

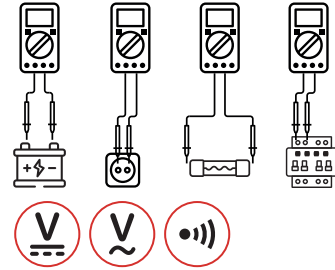

INDUSTRIAL

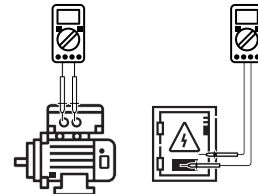

ELECTRONICS

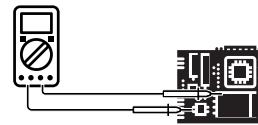

CONTENTS



150×74×41mm
 5.9"×2.9"×1.6"
 202g/0.44lb



2×1.5V AAA
 Batteries



ACCESSORIES

Test leads
 K type thermocouple
 Battery



Calibration
 Certificate



Quick Start
 Guide

PACKAGING INFORMATION



Color Box
 L145×W60×H188mm



Carton Box
 40×32×31.5cm



X 20PCS



MAIN APPLICATIONS



DOMESTIC

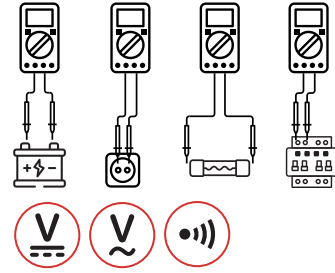

INDUSTRIAL

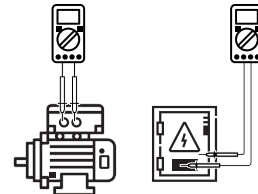

ELECTRONICS

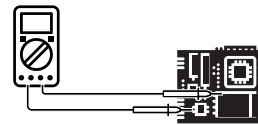

DIGITAL MULTIMETER

MS8250A

SKU NO.: MS8250ACBGLO
 UPC CODE: 810053672679
 EAN CODE: 8435394778310

FEATURE

- Auto & Manual Ranging.
- Auto Power Off.
- Relative Measurement.
- Non-Contact Voltage Detector.

SPECIFICATIONS

AC Voltage 600V	DC Voltage 600V	AC Current 10A
DC Current 10A	Resistance 40MΩ	Continuity <50±20Ω
Capacitance 100μF	Frequency 5MHz	Display Counts 4000

CONTENTS



175x86x52mm
 6.89"x3.38"x2.04"
 372g/0.82lb



1x9V 6F22
 Battery



ACCESSORIES

Test Leads
 Battery



Calibration
 Certificate



Quick Start
 Guide

PACKAGING INFORMATION



Color Box
 L165xW70xH225mm



Carton Box
 47x37.5x35.5cm



X 20PCS



DIGITAL MULTIMETER WITH USB **MS8250D**

SKU NO.: MS8250DCBGLO
UPC CODE: 810053674413
EAN CODE: 8435394779485

FEATURE

- Auto & Manual Ranging.
- Auto Power Off.
- True RMS.
- Non-Contact Voltage Detector.

SPECIFICATIONS

AC Voltage 1000V	DC Voltage 1000V	AC Current 10A
DC Current 10A	Resistance 66MΩ	Continuity test <50Ω
Capacitance 66mF	Frequency 66MHz	Display counts 6600

MAIN APPLICATIONS

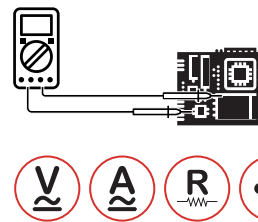
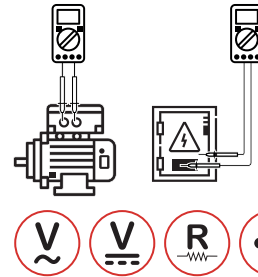
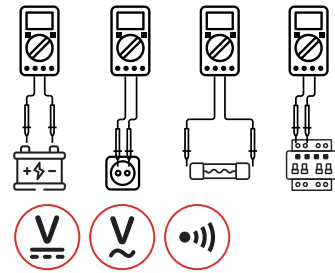

CONTENTS



175×86×52mm
6.89"×3.38"×2.04"
372g/0.82lb



1×9V 6F22
Battery



ACCESSORIES

Test Leads
USB interface cable
Software CD
Battery



Calibration
Certificate



Quick Start
Guide

PACKAGING INFORMATION



Color Box
L165×W70×H225mm



Carton Box
47×37.5×35.5cm



X 20PCS



DIGITAL MULTIMETER

MS8251A

SKU NO.: MS8251ACBGLO
 UPC CODE: 810053673157
 EAN CODE: 8435394778884

FEATURE

- Auto & Manual Ranging.
- Auto Power Off.
- True RMS.
- Non-Contact Voltage Detector.

SPECIFICATIONS

AC Voltage 1000V	DC Voltage 1000V	AC Current 10A
DC Current 10A	Resistance 66MΩ	Continuity <50±20Ω
Capacitance 66mF	Frequency 66MHz	Display Counts 6600

MAIN APPLICATIONS

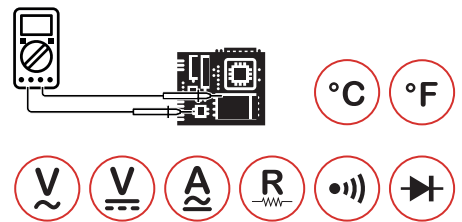
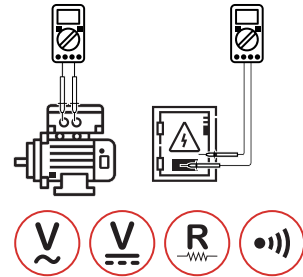
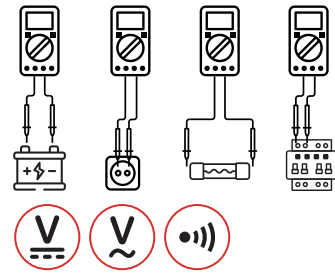

CONTENTS



175×85×52mm
 6.89"×3.3"×2.1"
 420g/0.92lb



1×9V 6F22
 Battery



Test leads
 K type thermocouple
 Multi-function socket
 Carrying strap
 Battery



Calibration
 Certificate



Quick Start
 Guide

PACKAGING INFORMATION



Color Box
 L165×W70×H225mm



Carton Box
 47×37.5×35.5cm



X 20PCS



DIGITAL MULTIMETER

MS8251B

SKU NO.: MS8251BCBGLO
 UPC CODE: 810053672686
 EAN CODE: 8435394778327

FEATURE

- Auto & Manual Ranging.
- Auto Power Off.
- Relative Measurement.
- Non-Contact Voltage Detector.

SPECIFICATIONS

AC Voltage 1000V	DC Voltage 1000V	AC Current 10A
DC Current 10A	Resistance 66MΩ	Continuity <50±20Ω
Capacitance 66mF	Frequency 10kHz	Display Counts 6600
Temperature 0°C~1000°C/32°F~1832°F		

MAIN APPLICATIONS



DOMESTIC

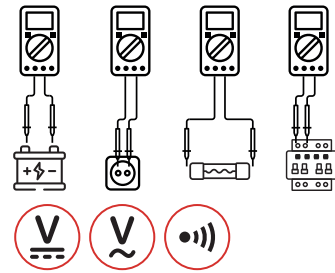

INDUSTRIAL

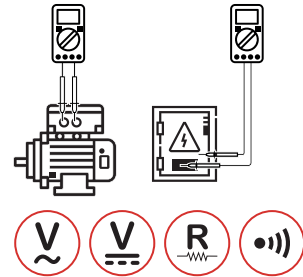

ELECTRONICS

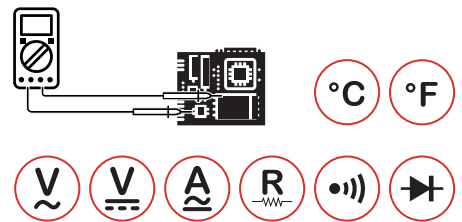

CONTENTS



175x85x52mm
 6.9"x3.3"x2.1"
 420g/0.92lb



1x9V 6F22
 Battery



ACCESSORIES

Test leads
 K type thermocouple
 Multi-function socket
 Carrying strap
 Battery



Calibration
 Certificate



Quick Start
 Guide

PACKAGING INFORMATION



Color Box
 L165xW70xH225mm



Carton Box
 47x37.5x35.5cm



X 20PCS



MAIN APPLICATIONS

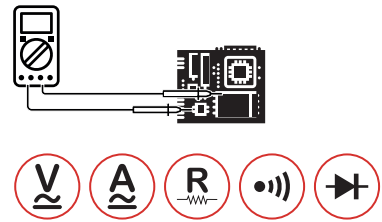
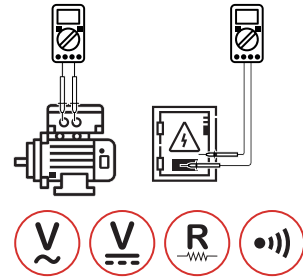
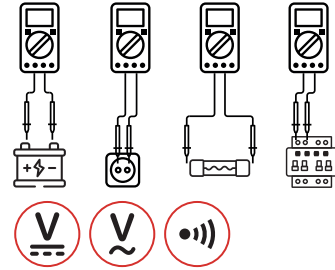

DIGITAL MULTIMETER
MS8268

SKU NO.: MS8268CBGLO
UPC CODE: 810053672709
EAN CODE: 8435394778341

FEATURE

- Auto Ranging.
- Auto Power Off.
- Sound & Light Warning.
- Relative Measurement.

SPECIFICATIONS

AC Voltage 750V	DC Voltage 1000V	AC Current 10A
DC Current 10A	Resistance 40MΩ	Continuity <70Ω
Capacitance 200μF	Frequency 200kHz	Display Counts 4000

CONTENTS



195×92×55mm
7.7"×3.6"×2.2"
400g/0.9lb



3×1.5V AAA Batteries



ACCESSORIES

Test leads
Multi-function socket
Battery



Calibration Certificate



Quick Start Guide

PACKAGING INFORMATION



Color Box
L165×W70×H225mm



Carton Box
47×37.5×35.5cm



X 20PCS



MAIN APPLICATIONS

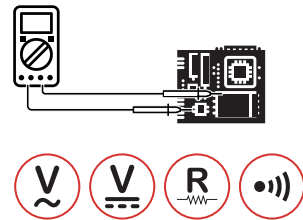
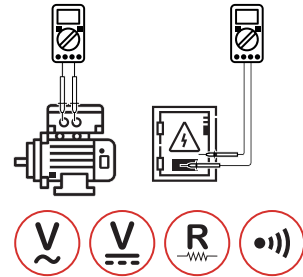
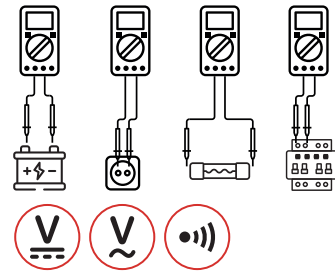

DIGSMART DIGITAL MULTIMETER
MS8301D

SKU NO.: MS8301DCBGLO
UPC CODE: 810053672273
EAN CODE: 8435394777993

FEATURE

- Auto Ranging.
- Auto Power Off.
- Dual Display.
- Continuity Buzzer.

SPECIFICATIONS

AC Voltage 600V	DC Voltage 600V	Resistance 10MΩ
Frequency 3kHz	Continuity <40Ω	Display Counts 6000

CONTENTS



150×74×48mm
5.9"×2.9"×1.7"
220g/0.48lb



2×1.5V AAA
Batteries



ACCESSORIES

Test Leads
Battery



Calibration
Certificate



Quick Start
Guide

PACKAGING INFORMATION



Color Box
L145×W60×H188mm



Carton Box
40×32×31.5cm



X 20PCS



MAIN APPLICATIONS

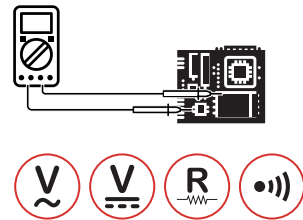
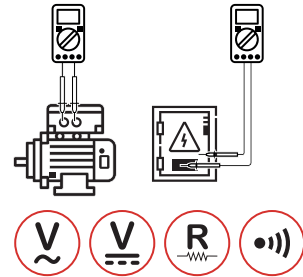
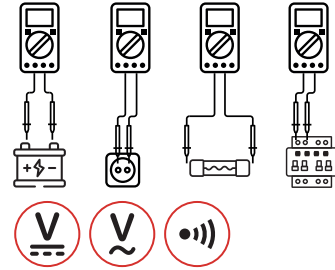

DIGITAL MULTIMETER
MS8332C

SKU NO.: MS8332CCBGLO
UPC CODE: 810053674857
EAN CODE: 8435394782065

FEATURE

- Display 4000 Counts.
- Diode Open Voltage 1.5v.
- Low Battery Display.

SPECIFICATIONS

AC Voltage 600V	DC Voltage 600V	AC Current 400mA
DC Current 400mA	Resistance 40MΩ	Continuity <50±20Ω
Capacitance 100μF	Frequency 5MHz	Display Counts 4000

CONTENTS

- 110×58×33mm
4.4"×2.3"×1.3"
150g/0.25lb
- 2×1.5V AAA Batteries
- Test Leads
- Battery
- Calibration Certificate
- Quick Start Guide

PACKAGING INFORMATION

- Color Box**
L145×W60×H188mm
- Carton Box**
40×32×31.5cm
- X 20PCS**



DIGITAL MULTIMETER

MS8340A

SKU NO.: MS8340ACBGLO
 UPC CODE: 810053675359
 EAN CODE: 8435394783000

FEATURE

- Auto & Manual Ranging.
- Auto Power Off.
- Relative Measurement.
- Low Pass Filter 1kHz.

SPECIFICATIONS

AC Voltage 750V	DC Voltage 1000V	AC Current 10A
DC Current 10A	Resistance 60MΩ	Continuity <50±20Ω
Capacitance 400μF	Frequency 10MHz	Display Counts 6000
Temperature -10°C~700°C/-14°F~1292°F		

MAIN APPLICATIONS

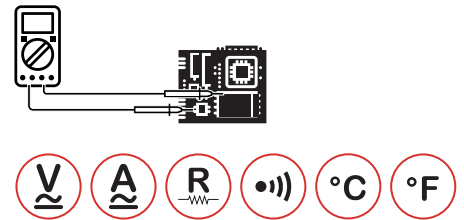
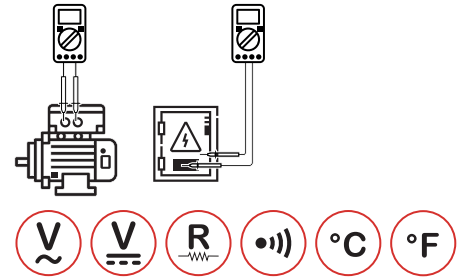
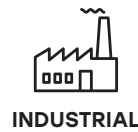
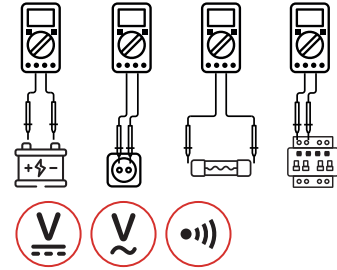

CONTENTS



205x102x58mm
 8.1"x4.0"x2.2"
 390g/0.86lb



4x1.5V AA Batteries



ACCESSORIES

Test leads
 K type thermocouple
 Multi-function socket
 Battery



Calibration Certificate



Quick Start Guide

PACKAGING INFORMATION



Color Box
 L173xW85xH235mm



Carton Box
 49x45x37.2cm



X 20PCS



MAIN APPLICATIONS



DOMESTIC

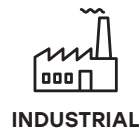
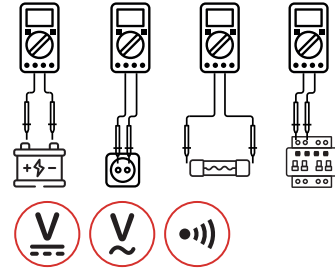

INDUSTRIAL

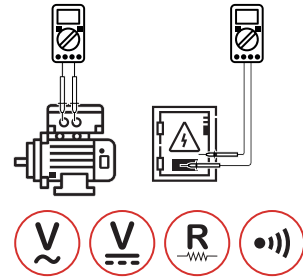

ELECTRONICS

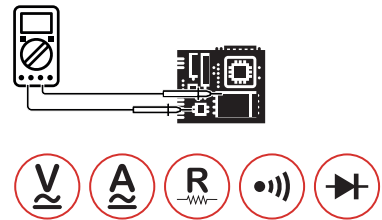

DIGITAL MULTIMETER
MS8360F

SKU NO.: MS8360FCBGLO
UPC CODE: 810053676783
EAN CODE: 8435394785325

FEATURE

- Auto & Manual Ranging.
- Auto Power Off.
- Relative Measurement.
- Non-Contact Voltage Detector.

SPECIFICATIONS

AC Voltage 600V	DC Voltage 600V	AC Current 10A
DC Current 10A	Resistance 40MΩ	Continuity <50±20Ω
Capacitance 200µF	Frequency 10MHz	Display Counts 4000

CONTENTS



188×92×50mm
7.4"×3.6"×2.0"
380g/0.83lb



1×9V 6F22
Battery



ACCESSORIES

Test leads
Multi-function socket
Battery



Calibration
Certificate



Quick Start
Guide

PACKAGING INFORMATION



Color Box
L165×W70×H225mm



Carton Box
47×37.5×35.5cm



X 20PCS



MAIN APPLICATIONS



DOMESTIC

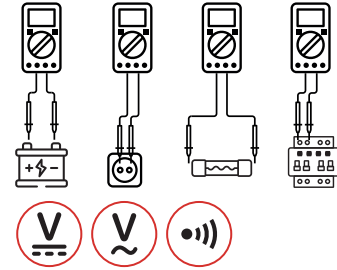

INDUSTRIAL

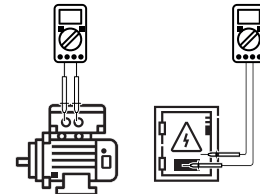

ELECTRONICS

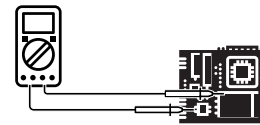

DIGITAL MULTIMETER

MS8360G

SKU NO.: MS8360GCBGLO
 UPC CODE: 810053672075
 EAN CODE: 8435394777801

FEATURE

- Auto & Manual Ranging.
- Auto Power Off.
- Relative Measurement.
- Non-Contact Voltage Detector.

SPECIFICATIONS

AC Voltage 600V	DC Voltage 600V	AC Current 10A
DC Current 10A	Resistance 40MΩ	Continuity <50±20Ω
Capacitance 4000μF	Frequency 10MHz	Display Counts 4000
Temperature -20°C~1000°C/-4°F~1832°F		

CONTENTS



188×92×50mm
 7.4"×3.6"×2.0"
 380g/0.83lb



1×9V 6F22
 Battery



ACCESSORIES

Test leads
 K type thermocouple
 Multi-function socket
 Battery



Calibration
 Certificate



Quick Start
 Guide

PACKAGING INFORMATION



Color Box
 L165×W70×H225mm



Carton Box
 47×37.5×35.5cm



X 20PCS



MAIN APPLICATIONS

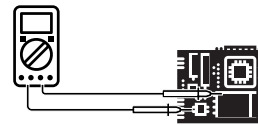
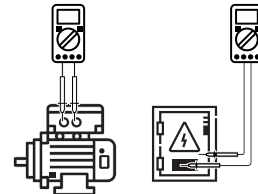
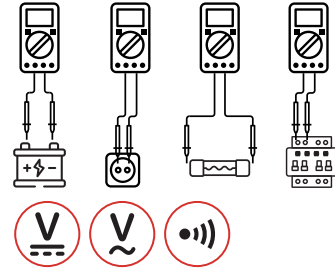

**DIGITAL MULTIMETER WITH WIRELESS
MS8361D**

SKU NO.: MS8361DCBGLO
UPC CODE: 810053675366
EAN CODE: 8435394783406

FEATURE

- Auto & Manual Ranging.
- Auto Power Off.
- True RMS For AC Voltage & AC Current.
- Wireless APP connection.

SPECIFICATIONS

AC Voltage 600V	DC Voltage 600V	AC Current 10A
DC Current 10A	Resistance 40MΩ	Continuity <50Ω
Capacitance 99.99mF	Frequency 10kHz	Display Counts 4000

CONTENTS



188×92×50mm
7.4"×3.6"×2.0"
380g/0.83lb



1×9V 6F22
Battery



ACCESSORIES

Test leads
Multi-function socket
Battery



Calibration
Certificate



Quick Start
Guide

PACKAGING INFORMATION



Color Box
L165×W70×H225mm



Carton Box
47×37.5×35.5cm



X 20PCS



DIGITAL MULTIMETER **MY68**

SKU NO.: MY68CBGLO
UPC CODE: 810053672457
EAN CODE: 8435394778099

FEATURE

- Auto Power Off.
- Transistor hFE 0~1000.
- Diode Open Voltage 3.0V.
- Data Hold.

SPECIFICATIONS

AC Voltage 750V	DC Voltage 1000V	AC Current 10A
DC Current 400mA	Resistance 40MΩ	Capacitance 200μF
Frequency 100kHz	Continuity <50Ω	Display counts 4000

MAIN APPLICATIONS

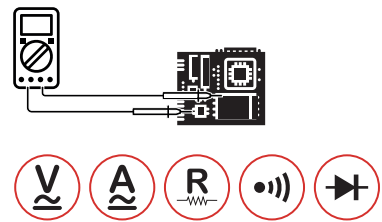
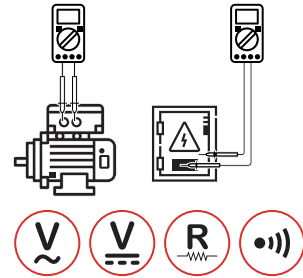
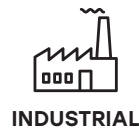
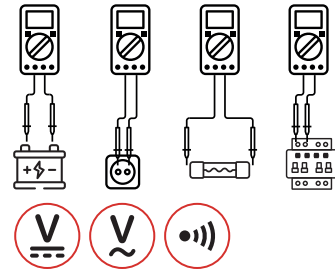

CONTENTS



189×91×31.5mm
7.67"×3.6"×1.24"
310g/0.5lb



1×9V 6F22
Battery



Test Leads
Battery

ACCESSORIES



Calibration
Certificate



Quick Start
Guide

PACKAGING INFORMATION



Color Box
L165×W70×H225mm



Carton Box
47×37.5×35.5cm



X 20PCS



MAIN APPLICATIONS

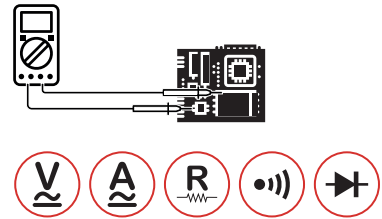
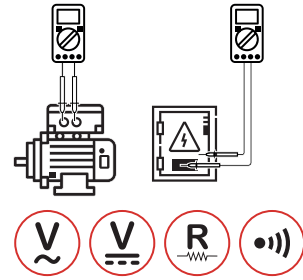
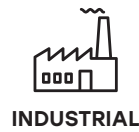
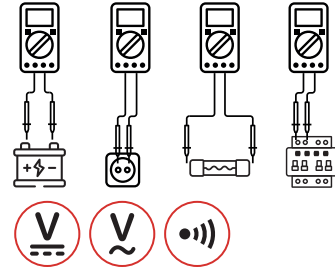

DIGITAL MULTIMETER
MY78

SKU NO.: MY78CBGLO
UPC CODE: 810053674550
EAN CODE: 8435394779621

FEATURE

- Auto & Manual Ranging.
- Relative Measurement.
- Diode Open Voltage 1.5V.
- Transistor hFE 0~1000.

SPECIFICATIONS

AC Voltage 600V	DC Voltage 600V	AC Current 10A
DC Current 10A	Resistance 40MΩ	Capacitance 200µF
Frequency >200kHz	Continuity <50±20Ω	Display Counts 4000

CONTENTS



189×91×31.5mm
7.67"×3.6"×1.24"
420g/0.92lb



1×9V 6F22
Battery



ACCESSORIES

Test leads
Multi-function socket
Battery



Calibration
Certificate



Quick Start
Guide

PACKAGING INFORMATION



Color Box
L165×W70×H225mm



Carton Box
47×37.5×35.5cm



X 20PCS

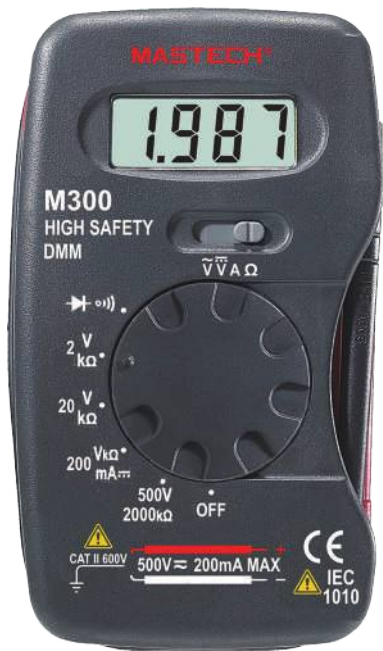

MAIN APPLICATIONS



DOMESTIC

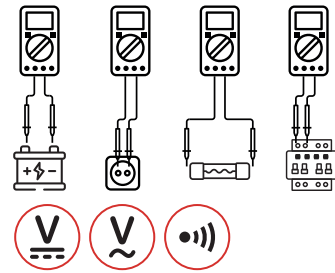

ELECTRONICS

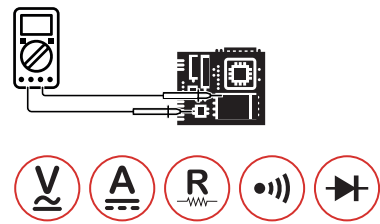

POCKET DIGITAL MULTIMETER
M300

SKU NO.: M300CBGLO
UPC CODE: 810053672082
EAN CODE: 8435394777818

FEATURE

- Pocket format that facilitates product portability.
- Test leads integrated which facilitates its use and storage.

SPECIFICATIONS

AC Voltage 600V	DC Voltage 600V	DC Current 200mA
Resistance 2MΩ	Display Counts 2000	Continuity <50±20Ω

CONTENTS



120×70×18mm
4.7"×2.75"×0.7"
110g/0.23lb



1x12V A23S
Battery



ACCESSORIES

Test leads
Carry bag



Calibration
Certificate



Quick Start
Guide

PACKAGING INFORMATION



Color Box
L95xW35xH154mm



Carton Box
37x32.8x21.5cm



X 40PCS



MAIN APPLICATIONS

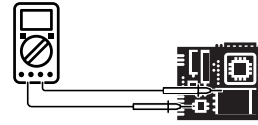
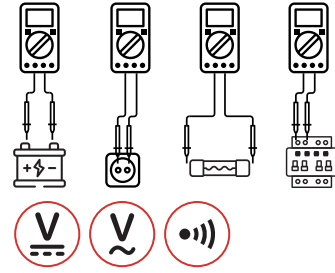

ELECTRONICS



POCKET DIGITAL MULTIMETER
M320

SKU NO.: M320CBGLO
UPC CODE: 810053674048
EAN CODE: 8435394779119

FEATURE

- Auto Ranging.
- Auto Power Off.
- Diode Open Voltage 1.5V.
- Data Hold.

SPECIFICATIONS

AC Voltage 600V	DC Voltage 600V	AC Current 400mA
DC Current 400mA	Resistance 40MΩ	Frequency 100kHz
Display Counts 4000	Continuity <50±20Ω	

CONTENTS



120×70×18mm
4.7"×2.75"×0.7"
110g/0.23lb



2×1.5V 357A(LR44)
Batteries



Test leads
Carry bag

ACCESSORIES



Calibration
Certificate



Quick Start
Guide

PACKAGING INFORMATION



Color Box
L95xW35xH154mm



Carton Box
37x32.8x21.5cm



X 40PCS



POCKET DIGITAL MULTIMETER
MS8333A

SKU NO.: MS8333ACBGLO
UPC CODE: 810053674482
EAN CODE: 8435394779553

FEATURE

- Auto Ranging.
- Auto Power Off.
- True RMS For AC Voltage & AC Current.
- Non-Contact Voltage Detector.

SPECIFICATIONS

AC Voltage 600V	DC Voltage 600V	AC Current 600mA
DC Current 600mA	Resistance 60MΩ	Continuity <50±20Ω
Capacitance 600uF	Frequency 10kHz	Display Counts 6000

MAIN APPLICATIONS

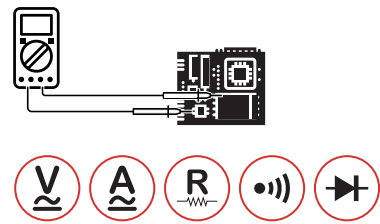
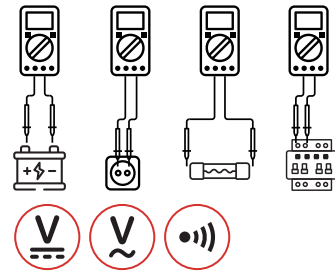

CONTENTS



122×62×44mm
4.8"×2.44"×1.73"
186g/0.4lb



2×1.5V AAA
Batteries



Test leads
Battery

ACCESSORIES



Calibration
Certificate



Quick Start
Guide

PACKAGING INFORMATION



Color Box
L145×W60×H188mm



Carton Box
40×32×31.5cm



X 20PCS



MAIN APPLICATIONS



DOMESTIC

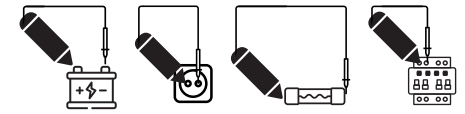

ELECTRONICS

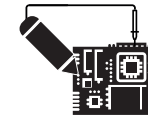

PEN-TYPE DIGITAL MULTIMETER
MS8211

SKU NO.: MS8211CBGLO
UPC CODE: 810053673010
EAN CODE: 8435394778976

FEATURE

- Auto & Manual Ranging.
- Auto Power Off.
- Diode Open Voltage 1.5V.
- Maximum Value Hold.

SPECIFICATIONS

AC Voltage 600V	DC Voltage 600V	Resistance 20MΩ
Continuity <50±20Ω	Display Counts 2000	

CONTENTS



208×38×29mm
8.26"×1.5"×1.1"
110g/0.24lb



2×1.5V AAA
Batteries



ACCESSORIES

Test leads
Alligator Clips
Carry bag
Battery



Calibration
Certificate



Quick Start
Guide

PACKAGING INFORMATION



Color Box
L85×W45×H220mm



Carton Box
46×26×36cm



X 40PCS



MAIN APPLICATIONS



DOMESTIC

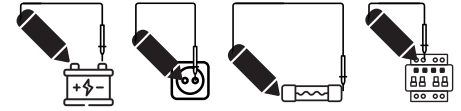

ELECTRONICS

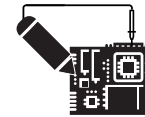

PEN-TYPE DIGITAL MULTIMETER
MS8211D

SKU NO.: MS8211DCBGLO
UPC CODE: 810053672655
EAN CODE: 8435394778747

FEATURE

- Auto & Manual Ranging.
- Auto Power Off.
- Diode Open Voltage 1.5V.
- Maximum Value Hold.

SPECIFICATIONS

AC Voltage 600V	DC Voltage 600V	AC Current 200mA
DC Current 200mA	Resistance 20MΩ	Continuity <50±20Ω
Display Counts 2000		

CONTENTS



208×38×29mm
8.26"×1.5"×1.1"
110g/0.24lb



2×1.5V AAA
Batteries



ACCESSORIES

Test leads
Alligator Clips
Carry bag
Battery



Calibration
Certificate



Quick Start
Guide

PACKAGING INFORMATION



Color Box
L85×W45×H220mm



Carton Box
46×26×36cm



X 40PCS



MAIN APPLICATIONS



DOMESTIC

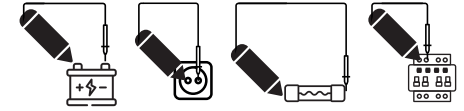

ELECTRONICS

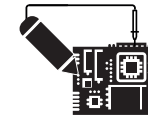

PEN-TYPE DIGITAL MULTIMETER
MS8212A

SKU NO.: MS8212ACBGLO
UPC CODE: 810053673034
EAN CODE: 8435394778761

FEATURE

- Auto & Manual Ranging.
- Auto Power Off.
- Diode Open Voltage 1.5V.
- Maximum Value Hold.

SPECIFICATIONS

AC Voltage 600V	DC Voltage 600V	AC Current 200mA
DC Current 200mA	Resistance 20MΩ	Continuity <50±20Ω
Display Counts 2000		

CONTENTS



238×43×29mm
9.37"×1.7"×1.1"
112g/0.28lb



2×1.5V AAA
Batteries



ACCESSORIES

Test leads
Alligator Clips
Carry bag
Battery



Calibration
Certificate



Quick Start
Guide

PACKAGING INFORMATION



Color Box
L85×W45×H236mm



Carton Box
49×28×37cm



X 40PCS



DIGITAL MULTIMETER **MS8223A**

SKU NO.: MS8223ACBGLO
UPC CODE: 810053672211
EAN CODE: 8435394777931

FEATURE

- Auto & Manual Ranging.
- Auto Power Off.
- Diode Open Voltage 1.5V.
- Maximum Value Hold.

SPECIFICATIONS

AC Voltage 600V	DC Voltage 600V	AC Current 200mA
DC Current 200mA	Resistance 20MΩ	Continuity <50Ω
Display Counts 2000		

MAIN APPLICATIONS



DOMESTIC

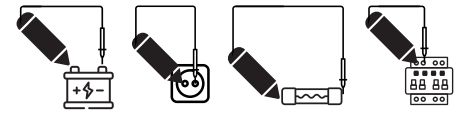

ELECTRONICS

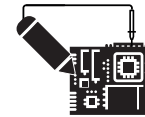

CONTENTS



225×52×40mm
8.86"×2.0"×1.58"
138g/0.3lb



2×1.5V AAA
Batteries



ACCESSORIES

Test leads
Alligator Clips
Carry bag
Battery



Calibration
Certificate



Quick Start
Guide

PACKAGING INFORMATION



Color Box
L85×W50×H236mm



Carton Box
49×28×37cm



X 40PCS



MULTI-FUNCTION DIGITAL COUNTER
MS6100

SKU NO.: MS6100CBGLO
UPC CODE: 810053675199
EAN CODE: 8435394783185

FEATURE

- Operating Temperature 0°C~40°C.
- Storage Temperature -10°C~50°C.
- Relative Humidity 20%~80%RH (0°C~40°C).
- Data Hold.

SPECIFICATIONS

A Input 10~100MHz	B Input 100~1300MHz	Display Counts 2200
-----------------------------	-------------------------------	-------------------------------

MAIN APPLICATIONS



DOMESTIC



HZ



INDUSTRIAL

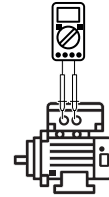

HZ



ELECTRONICS

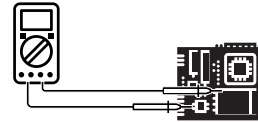

HZ

CONTENTS

	300x260x74mm 11.8"x10.2"x2.9" 1850g/4.02lb		220V/110V AC
	BNC to BNC Test Lead (50 ohm, 100cm) Power Cord		Calibration Certificate
			Quick Start Guide

PACKAGING INFORMATION





	Color Box L320xW140xH310mm	
	Carton Box 59x34x34.5cm	X 4PCS

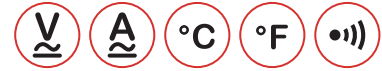
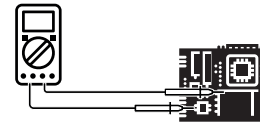

MAIN APPLICATIONS



CONTENTS

-  238x230x83mm
9.4"x9.1x3.3"
1500g/3.4lb
-  220V/110V AC
(50~60Hz)
-  **ACCESSORIES**
Test Leads
K Type Thermocouple
Multi-function socket
RS232C Cable
Power cord
Software CD
Carrying strap
-  Calibration Certificate
-  **QSG** Quick Start Guide

TRUE RMS BENCHTOP MULTIMETER
MS8040

SKU NO.: MS8040CBGLO
UPC CODE: 810053672631
EAN CODE: 8435394778273



FEATURE

- Auto & Manual Ranging.
- True RMS for AC Voltage & AC Current.
- Low Pass Filter (1kHz) for AC Voltage & AC Current.

SPECIFICATIONS

AC Voltage 750V	DC Voltage 1000V	AC Current 10A
DC Current 10A	Resistance 200MΩ	Capacitance 20mF
Display Counts 22000		

PACKAGING INFORMATION

-  **Color Box**
L300xW110xH280mm
-  **Carton Box**
58.5x32x29.5cm
-  **X 5PCS**



MAIN APPLICATIONS

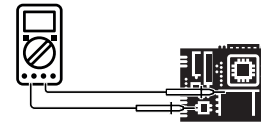

CONTENTS

350x240x100mm
13.8"x9.5"x3.9"
2500g/5.5lb

220V/110V AC

ACCESSORIES
Test leads
Alligator clip
Power cord
RS232C cable
Software CD
Carry case

Calibration Certificate

Quick Start Guide

TRUE RMS BENCHTOP MULTIMETER
MS8050

SKU NO.: MS8050CBGLO
UPC CODE: 810053674390
EAN CODE: 8435394779461

FEATURE

- True RMS.
- dBm Measurement.
- Relative Measurement.
- Diode Open Voltage 3.3V.

SPECIFICATIONS

AC Voltage 1000V	DC Voltage 1000V	AC Current 10A
DC Current 10A	Resistance 50MΩ	Capacitance 5000μF
Display Counts 53000		

PACKAGING INFORMATION

Color Box
L465xW140xH320mm

Carton Box
48.5x30x35cm

X 2PCS



DIGITAL INSULATION MULTIMETER **MS5208**

SKU NO.: MS5208CBGLO
UPC CODE: 810053673065
EAN CODE: 8435394778792

FEATURE

- Auto & Manual Ranging.
- Auto Power Off.
- True RMS For AC Voltage & AC Current.
- DAR/PI Mod.

SPECIFICATIONS

AC Voltage 750V	DC Voltage 1000V	AC Current 400mA
DC Current 400mA	DC Output 1000V	Resistance 66MΩ
Capacitance 66mF	Frequency 10kHz	Continuity <30Ω
Display Counts 6600	Temperature -30°C~1300°C / -22°F~2372°F	

MAIN APPLICATIONS

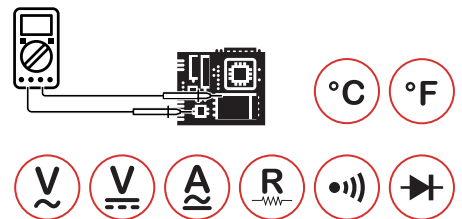
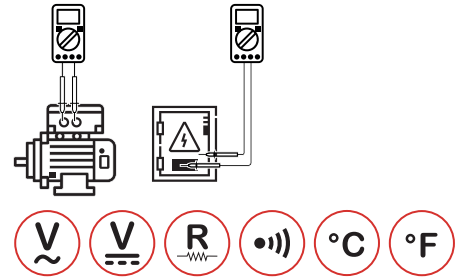
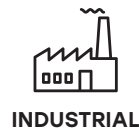
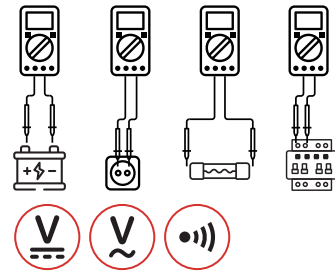

CONTENTS



205x102x58mm
8.1"x4.0"x2.3"
390g/0.86lb



4x1.5V AA
Batteries



ACCESSORIES

Test Leads
Test Clips
K Type Thermocouple
Multi-function socket
Carry Bag
Battery



Calibration
Certificate



Quick Start
Guide

PACKAGING INFORMATION



Color Box
L172xW80xH255mm



Carton Box
53x44.5x37cm



X 20PCS



DIGITAL MULTIMETER WITH ENVIRONMENT 4 IN 1

MS8209

SKU NO.: MS8209CBGLO
 UPC CODE: 810053672648
 EAN CODE: 8435394778280

FEATURE

- Auto & Manual Ranging.
- Auto Power Off.
- Diode Open Voltage 1.5V.
- Relative Measurement.

SPECIFICATIONS

AC Voltage 600V	DC Voltage 600V	AC Current 10A
DC Current 10A	Resistance 40MΩ	Capacitance 200μF
Frequency >200kHz	Continuity <40Ω	Display Counts 4000
Temperature -20°C~1000°C		

MAIN APPLICATIONS



DOMESTIC

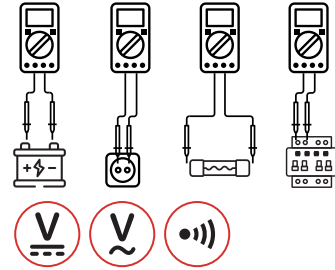

INDUSTRIAL

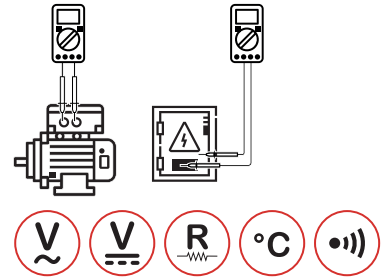

ELECTRONICS

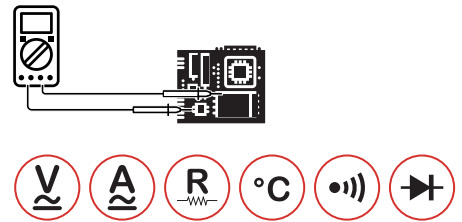

CONTENTS



158×78×39mm
 6.2"×3.1"×1.5"
 260g/0.55lb



1×9V 6F22
 Battery



ACCESSORIES

Test leads
 K type thermocouple
 Carry bag
 Battery



Calibration
 Certificate



Quick Start
 Guide

PACKAGING INFORMATION



Color Box
 L188×W88×H264mm



Carton Box
 55×48.5×39.5cm



X 20PCS



DIGITAL MULTIMETER WITH ENVIRONMENT 5 IN 1

MS8229

SKU NO.: MS8229CBAGLO
 UPC CODE: 810053672327
 EAN CODE: 8435394778433

FEATURE

- Hinged Bracket Facilitate Table Work.
- Auto-Ranging, Relative, Humidity, Luminosity & Sound level.
- For Professional Use.

SPECIFICATIONS

AC Voltage 750V	DC Voltage 1000V	AC Current 10A
DC Current 10A	Resistance 40MΩ	Capacitance 100uF
Frequency >200kHz	Continuity <50±20Ω	Display Counts 4000
Temperature -20°C~1000°C/-4°F~1832°F		

MAIN APPLICATIONS



DOMESTIC

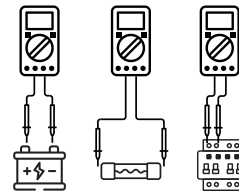

INDUSTRIAL

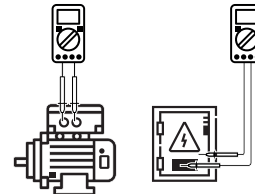

ELECTRONICS

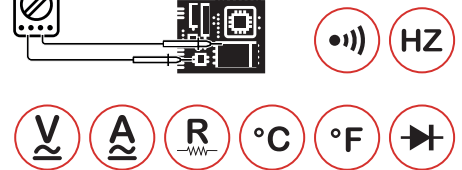
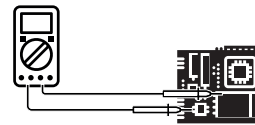

CONTENTS



195×92×55mm
 7.7"×3.6"×2.2"
 390g/0.86lb



3×1.5V AAA Batteries



ACCESSORIES

Test leads
 K type thermocouple
 Battery



Calibration Certificate



Quick Start Guide

PACKAGING INFORMATION



Color Box
 L165×W70×H225mm



Carton Box
 47×37.5×35.5cm



X 20PCS



MAIN APPLICATIONS

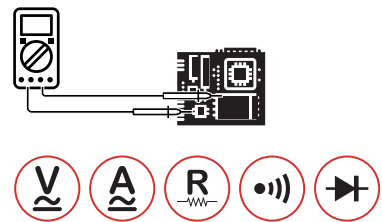
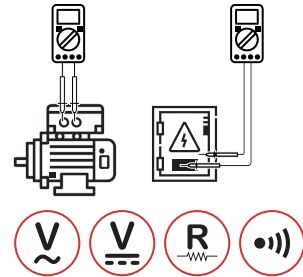
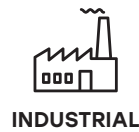
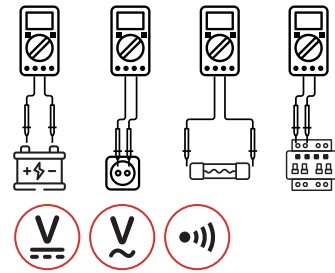

DIGITAL MULTIMETER WITH LAN/PHONE/TONE TESTER

MS8236

SKU NO.: MS8236CBGLO
 UPC CODE: 810053673003
 EAN CODE: 8435394778624

FEATURE

- Auto & Manual Ranging.
- Auto Power Off.
- Non-Contact Voltage Detector.
- Diode Open Voltage 1.7V.

SPECIFICATIONS

AC Voltage 600V	DC Voltage 600V	AC Current 10A
DC Current 10A	Resistance 20MΩ	Continuity <70Ω
Display counts 2000		

CONTENTS

	MS8236: 195x92x55mm 7.7"x3.6"x2.2" 470g/1.04lb		MS6812R: 238x43x26mm 9.4"x1.7"x1.0"
	Test leads Detection connect line Battery		2x9V 6F22 Batteries
	Calibration Certificate		Quick Start Guide

PACKAGING INFORMATION

	Color Box L188xW88xH264mm		Carton Box 55x48.5x39.5mm		X 40PCS
--	-------------------------------------	--	-------------------------------------	--	----------------



DIGITAL MULTIMETER (ENGINE ANALYZER)
MS8239D

SKU NO.: MS8239DCBGLO
 UPC CODE: 810053672983
 EAN CODE: 8435394778716

FEATURE

- Auto & Manual Ranging.
- Auto Power Off.
- Diode Open Voltage 2.7V.
- Maximum Measurement.

SPECIFICATIONS

AC Voltage 600V	DC Voltage 600V	AC Current 10A
DC Current 10A	Resistance 40MΩ	Continuity <50Ω
Display Counts 2000		

MAIN APPLICATIONS



DOMESTIC

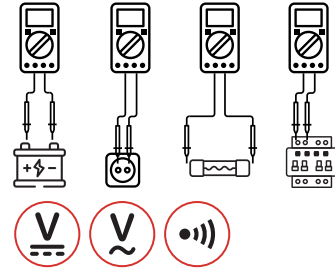

INDUSTRIAL

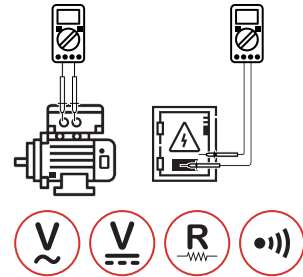

ELECTRONICS

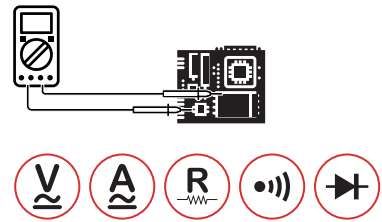

CONTENTS



150×74×41mm
 5.9"×2.9"×1.6"
 202g/0.44lb



2×1.5V AAA
 Batteries



ACCESSORIES

Test leads
 Battery



Calibration
 Certificate



Quick Start
 Guide

PACKAGING INFORMATION



Color Box
 L145×W60×H188mm



Carton Box
 40×32×31.5cm



X 20PCS



MAIN APPLICATIONS



DOMESTIC

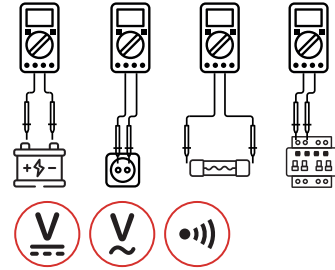

INDUSTRIAL

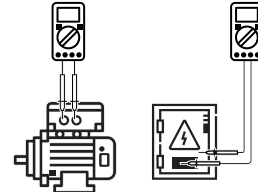

ELECTRONICS

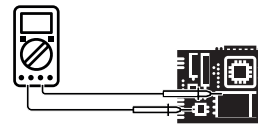

DIGITAL MULTIMETER

MS8265

SKU NO.: MS8265CBGLO
 UPC CODE: 810053674772
 EAN CODE: 8435394779836

FEATURE

- Auto Power Off.
- Sound & Light Warning.
- Transistor hFE 0~1000.
- Diode Open Voltage 3.0V.

SPECIFICATIONS

AC Voltage 750V	DC Voltage 1000V	AC Current 10A
DC Current 10A	Resistance 200MΩ	Continuity <70Ω
Capacitance 200μF	Frequency 20kHz	Display Counts 20000

CONTENTS



195×92×55mm
 7.7"×3.6"×2.2"
 400g/0.9lb



1×9V 6F22
 Battery



ACCESSORIES

Test leads
 Multi-function socket
 Battery



Calibration
 Certificate



Quick Start
 Guide

PACKAGING INFORMATION



Color Box
 L165×W70×H225mm



Carton Box
 47×37.5×35.5cm



X 20PCS

DIGITAL CLAMP METERS

AC CURRENT | AC/DC CURRENT | LEAKAGE | POWER
SPECIAL APPLICATION





MAIN APPLICATIONS

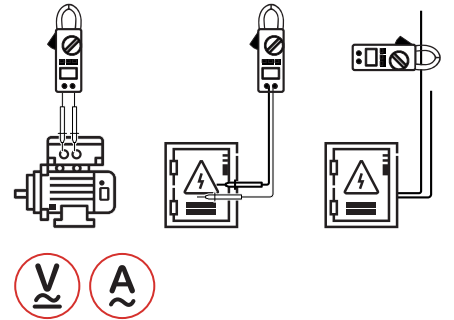
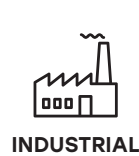
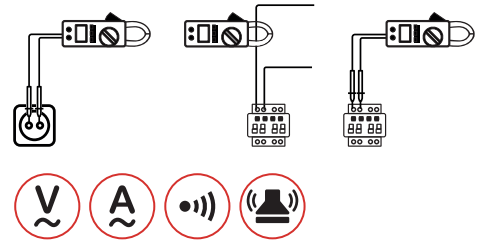

DIGITAL AC ELECTRICAL TESTER
M266

SKU NO.: M266CBGLO
UPC CODE: 810053673287
EAN CODE: 8435394779010

FEATURE

- Data Hold.
- Low Battery Display.

SPECIFICATIONS

AC Voltage 750V	DC Voltage 1000V	AC Current 1000A
Resistance 20kΩ	Display Counts 2000	Continuity <100Ω
Jaw Opening 50mm/2.0"		

CONTENTS



235×96×46mm
9.25"×3.8"×1.8"
268g/0.59lb



1×9V 6F22
Battery



ACCESSORIES

Test Leads
Carry bag
Battery



Calibration
Certificate



Quick Start
Guide

PACKAGING INFORMATION



Color Box
L130×W63×H255mm



Carton Box
53×34×28.5cm



X20PCS



MAIN APPLICATIONS

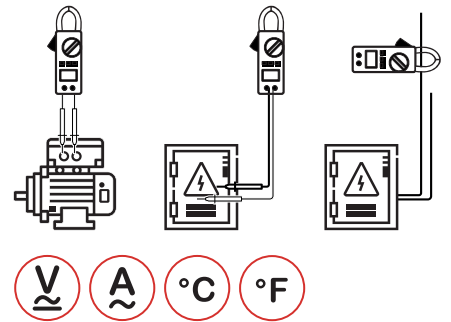
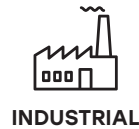
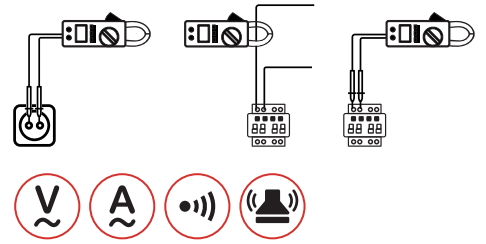

DIGITAL CLAMP TRANSDUCER
M266C

SKU NO.: M266CCBGLO
UPC CODE: 810053672471
EAN CODE: 8435394778112

FEATURE

- Data Hold.
- Low Battery Display.

SPECIFICATIONS

AC Voltage 750V	DC Voltage 1000V	AC Current 1000A
Resistance 2MΩ	Display Counts 2000	Continuity <100Ω
Jaw Opening 12mm/0.5"	Temperature 0°C~750°C/32°F~1382°F	

CONTENTS



235×96×46mm
9.25"×3.8"×1.8"
268g/0.59lb



1×9V 6F22
Battery



ACCESSORIES

Test Leads
K-type thermocouple
Carry bag
Battery



Calibration
Certificate



Quick Start
Guide

PACKAGING INFORMATION



Color Box
L130×W63×H255mm



Carton Box
53×34×28.5cm



X20PCS



MAIN APPLICATIONS

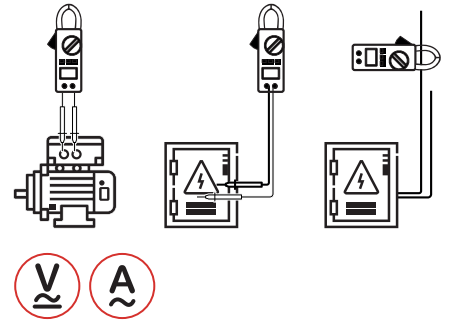
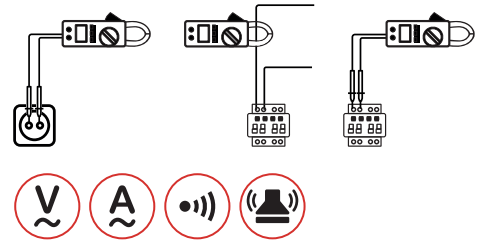

DIGITAL AC CLAMP METER
M266F

SKU NO.: M266FCBGLO
UPC CODE: 810053672488
EAN CODE: 8435394778129

FEATURE

- Diode open voltage 2.7V.
- Data Hold.
- Low Battery Display.

SPECIFICATIONS

AC Voltage 750V	DC Voltage 1000V	AC Current 1000A
Resistance 2MΩ	Frequency 2kHz	Display Counts 2000
Continuity <100Ω	Jaw Opening 12mm/0.5"	

CONTENTS



235×96×46mm
9.25"×3.8"×1.8"
268g/0.59lb



1×9V 6F22
Battery



ACCESSORIES

Test Leads
Carry bag
Battery



Calibration
Certificate



Quick Start
Guide

PACKAGING INFORMATION



Color Box
L130×W63×H255mm



Carton Box
53×34×28.5cm



X20PCS



MAIN APPLICATIONS



DOMESTIC

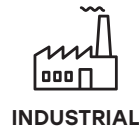
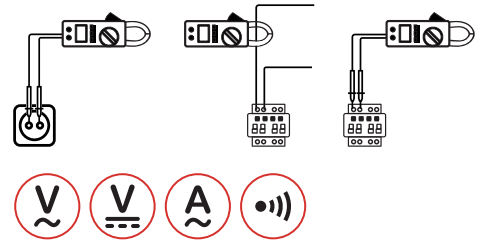

INDUSTRIAL

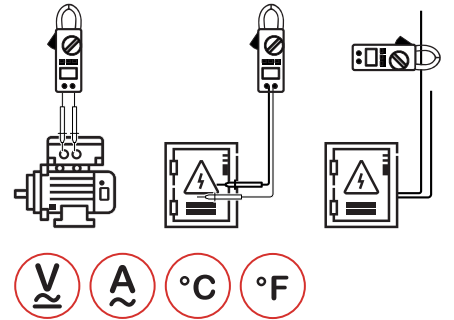

DIGITAL AC CLAMP METER
MS2000G

SKU NO.: MS2000GCBGLO
UPC CODE: 810053674093
EAN CODE: 8435394779164

FEATURE

- Diode Open Voltage 3.0V.
- Data Hold.
- Display Backlight.
- Low Battery Display.

SPECIFICATIONS

AC Voltage 750V	DC Voltage 1000V	AC Current 1000A
Resistance 2MΩ	Frequency 20kHz	Display Counts 2000
Jaw Opening 55mm/2.2"	Continuity <60Ω	
Temperature -0°C~750°C/32°F~1382°F		

CONTENTS



282×104×47mm
11"×4.1"×1.85"
570g/1.26lb



1×9V 6F22
Battery



ACCESSORIES

Test Leads
Wrapping Case
K type thermocouple
Battery



Calibration
Certificate



Quick Start
Guide

PACKAGING INFORMATION



Color Box
L300×W65×H250mm



Carton Box
61.5×37×27cm



X 10PCS



MAIN APPLICATIONS

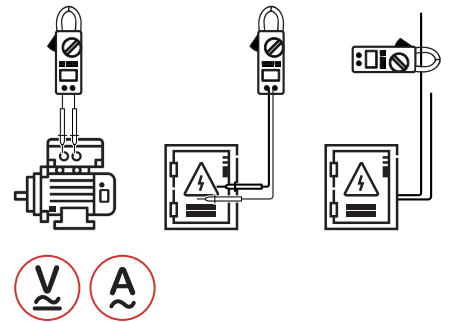
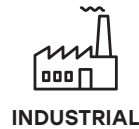
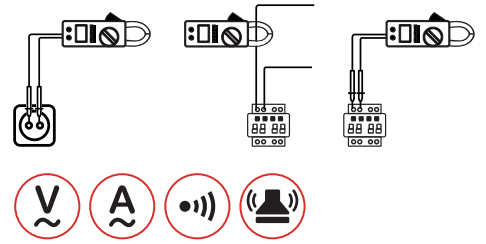

DIGITAL AC CLAMP METER
MS2001

SKU NO.: MS2001CBGLO
UPC CODE: 810053672341
EAN CODE: 8435394778044

FEATURE

- Diode Open Voltage 3.0V.
- Data Hold.
- Display Backlight.
- Low Battery Display.

SPECIFICATIONS

AC Voltage 750V	DC Voltage 1000V	AC Current 1000A
Resistance 2000Ω	Display Counts 2000	Jaw Opening 42mm/1.7"
Continuity <60Ω		

CONTENTS



250×99×43mm
9.8"×3.9"×1.7"
416g/0.92lb



1×9V 6F22
Battery



ACCESSORIES

Test Leads
Wrapping Case
Battery



Calibration
Certificate



Quick Start
Guide

PACKAGING INFORMATION



Color Box
L130×W60×H300mm



Carton Box
35.5×33×29cm



X 10PCS



MAIN APPLICATIONS

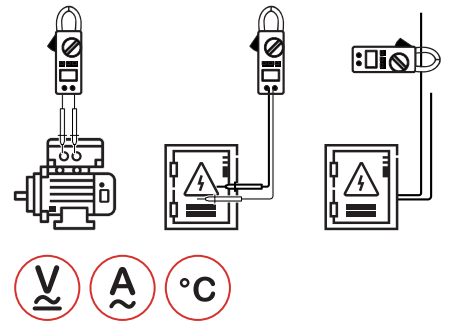
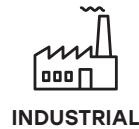
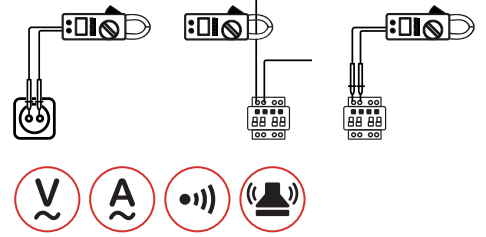

DIGITAL AC CLAMP METER
MS2001C

SKU NO.: MS2001CCBGLO
UPC CODE: 810053674109
EAN CODE: 8435394783055

FEATURE

- Data Hold.
- Display Backlight.
- Low Battery Display.

SPECIFICATIONS

AC Voltage 750V	DC Voltage 1000V	AC Current 1000A
Resistance 2000Ω	Display Counts 2000	Jaw Opening 42mm/1.7"
Continuity <60Ω	Temperature -40°C~750°C	

CONTENTS



250×99×43mm
9.8"×3.9"×1.7"
416g/0.92lb



1×9V 6F22
Battery



ACCESSORIES

Test Leads
K-type thermocouple
Carry bag
Battery



Calibration
Certificate



Quick Start
Guide

PACKAGING INFORMATION



Color Box
L130×W60×H300mm



Carton Box
35.5×33×29cm



X 10PCS



MAIN APPLICATIONS



DOMESTIC

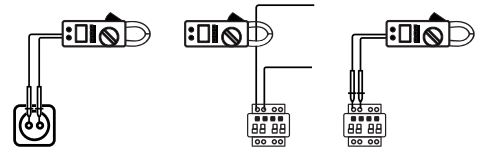

INDUSTRIAL

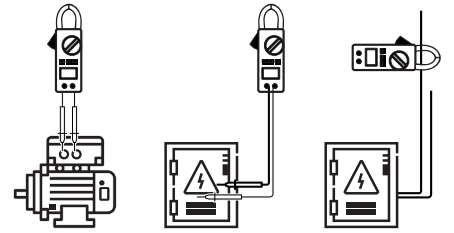

DIGITAL AC CLAMP METER
MS2001F

SKU NO.: MS2001FCBGLO
UPC CODE: 810053673218
EAN CODE: 84835394778945

FEATURE

- Data Hold.
- Diode and Continuity.

SPECIFICATIONS

AC Voltage 750V	DC Voltage 1000V	AC Current 1000A
Resistance 2000Ω	Display Counts 2000	Jaw Opening 42mm/1.7"

CONTENTS



250×99×43mm
9.8"×3.9"×1.7"
416g/0.92lb



1×9V 6F22
Battery



ACCESSORIES

Test Leads
Carry bag
Battery



Calibration
Certificate



Quick Start
Guide

PACKAGING INFORMATION



Color Box
L130×W60×H300mm



Carton Box
35.5×33×29cm



X 10PCS



MAIN APPLICATIONS

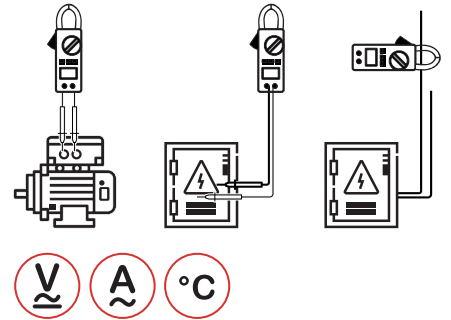
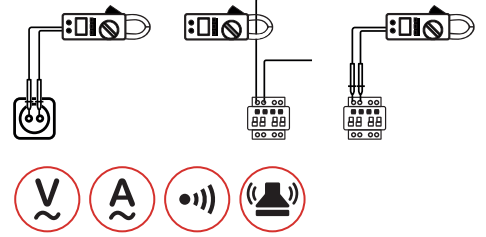

DIGITAL AC CLAMP METER
MS2008B

SKU NO.: MS2008BCBGLO
UPC CODE: 810053674123
EAN CODE: 8435394779195

FEATURE

- Auto & Manual Ranging.
- Auto Power Off.
- Display 4000 Counts.

SPECIFICATIONS

AC Voltage 600V	DC Voltage 600V	AC Current 600A
Resistance 40MΩ	Display Counts 4000	Jaw Opening 26mm/1.0"
Continuity <50Ω	Temperature -20°C~750°C	

CONTENTS



208x78x35mm
8.18"x3.1"x1.4"
240g/0.4lb



3x1.5V AAA
Batteries



Test Leads
K-type thermocouple
Carry bag
Battery



Calibration
Certificate



Quick Start
Guide

PACKAGING INFORMATION



Color Box
L105xW55xH235mm



Carton Box
50x30.5x23cm



X 20PCS



MAIN APPLICATIONS



DOMESTIC

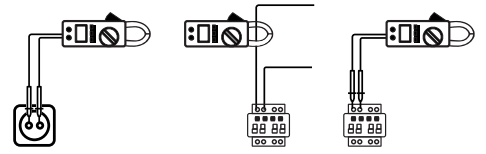

INDUSTRIAL

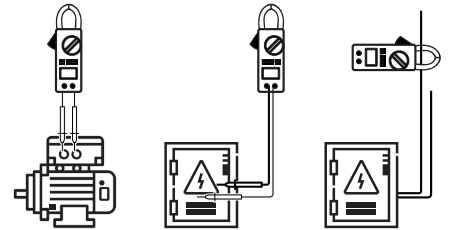

DIGITAL AC CLAMP METER
MS2009A

SKU NO.: MS2009ACBGLO
UPC CODE: 810053672549
EAN CODE: 8435394778181

FEATURE

- Auto & Manual Ranging.
- Auto Power Off.
- Non-Contact Voltage Detector.
- Diode Open Volatge 1.5V.

SPECIFICATIONS

AC Voltage 600V	DC Voltage 600V	AC Current 600A
Resistance 20MΩ	Display Counts 2000	Jaw Opening 26mm/1.0"
Continuity <60Ω		

CONTENTS



218×78×35mm
8.9"×3.1"×1.4"
239g/0.53lb



3×1.5V AAA
Batteries



ACCESSORIES

Test Leads
Carry bag
Battery



Calibration
Certificate



Quick Start
Guide

PACKAGING INFORMATION



Color Box
L105×W55×H235mm



Carton Box
50×30.5×23cm



X 20PCS



MAIN APPLICATIONS

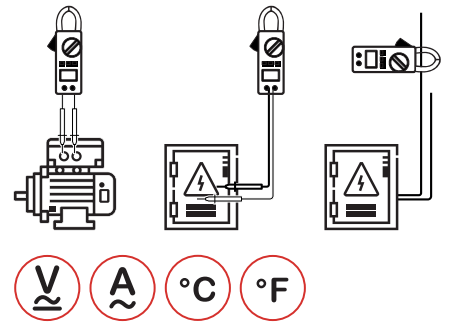
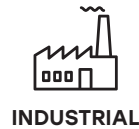
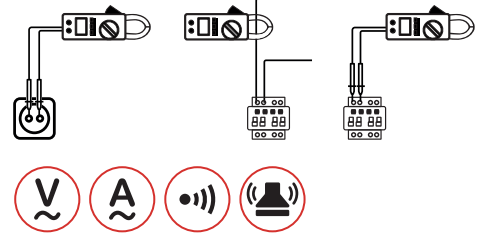

DIGITAL AC CLAMP METER
MS2009C

SKU NO.: MS2009CCBGLO
UPC CODE: 810053674130
EAN CODE: 8435394779201

FEATURE

- Auto & Manual Ranging.
- Auto Power Off.
- Non-Contact Voltage Detector.
- Diode Open Volatge 3.2V.

SPECIFICATIONS

AC Voltage 600V	DC Voltage 600V	AC Current 600A
Resistance 60MΩ	Capacitance 60mF	Frequency 1kHz
Display Counts 6000	Jaw Opening 26mm/1.0"	Continuity <50Ω
Temperature -20°C~1000°C/-4°F~1832°F		

CONTENTS



218×78×35mm
8.9"×3.1"×1.4"
239g/0.53lb



3×1.5V AAA
Batteries



Test Leads
K-type thermocouple
Carry bag
Battery



Calibration
Certificate



Quick Start
Guide

PACKAGING INFORMATION



Color Box
L105×W55×H235mm



Carton Box
50×30.5×23cm



X 20PCS



MAIN APPLICATIONS

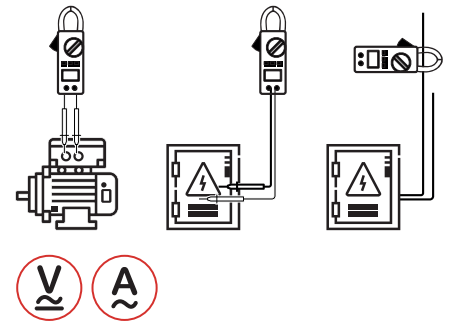
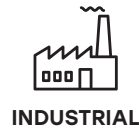
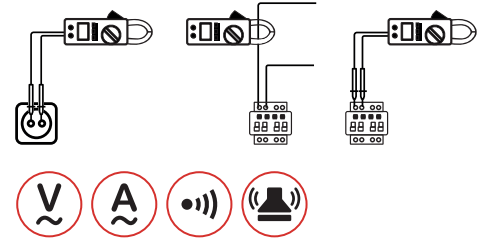

DIGITAL AC CLAMP METER
MS2025A

SKU NO.: MS2025ACBGLO
UPC CODE: 810053674147
EAN CODE: 8435394779218

FEATURE

- Auto & Manual Ranging.
- Auto Power Off.
- Non-Contact Voltage Detector.
- Relative Measurement.

SPECIFICATIONS

AC Voltage 750V	DC Voltage 1000V	AC Current 1000A
Resistance 60MΩ	Capacitance 100mF	Frequency 10kHz
Display Counts 6000	Jaw Opening 40mm/1.6"	Continuity <50Ω

CONTENTS



238×92×50mm
9.37"×3.6"×1.9"
390g/0.86lb



1×9V 6F22
Battery



ACCESSORIES

Test Leads
Carry bag
Battery



Calibration
Certificate



Quick Start
Guide

PACKAGING INFORMATION



Color Box
L130×W63×H255mm



Carton Box
53×34×28.5cm



X 20PCS



MAIN APPLICATIONS

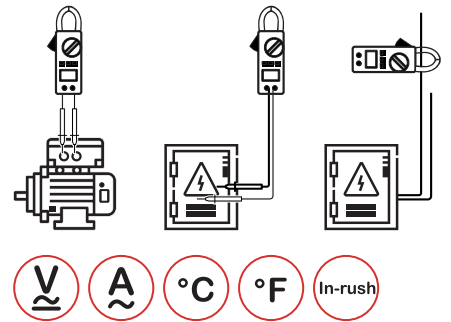
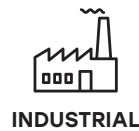
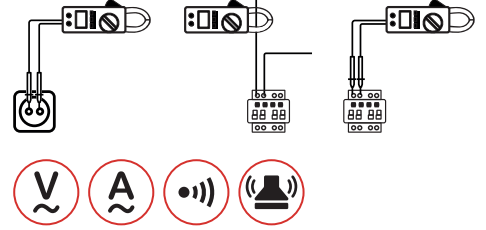

DIGITAL AC CLAMP METER
MS2025C

SKU NO.: MS2025CCBGLO
UPC CODE: 810053674635
EAN CODE: 8435394779690

FEATURE

- Auto & Manual Ranging.
- Auto Power Off.
- Non-Contact Voltage Detector.
- Relative Measurement.

SPECIFICATIONS

AC Voltage 750V	DC Voltage 1000V	AC Current 1000A
Resistance 66MΩ	Capacitance 66mF	Continuity <50Ω
Frequency(A) 660Hz	Frequency(V) 6.6kHz	Display Counts 6600
Jaw Opening 40mm/1.6"	Temperature -20°C~1000°C/-4°F~1832°F	

CONTENTS



238×92×50mm
9.37"×3.6"×1.9"
390g/0.86lb



1×9V 6F22
Battery



ACCESSORIES

Test Leads
K-type thermocouple
Carry bag
Battery



Calibration
Certificate



Quick Start
Guide

PACKAGING INFORMATION



Color Box
L130×W63×H255mm



Carton Box
53×34×28.5cm



X 20CS



MAIN APPLICATIONS



DOMESTIC

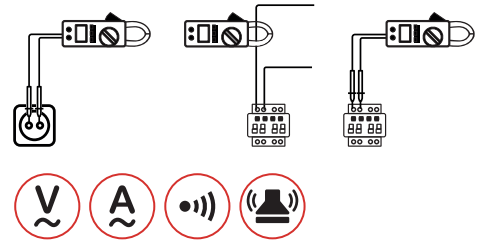

INDUSTRIAL

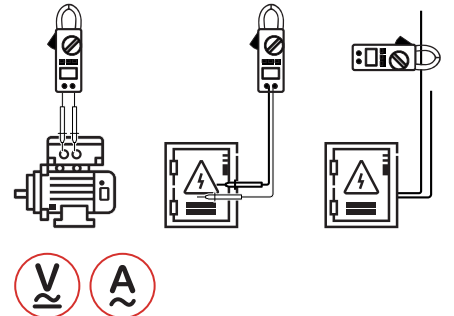

DIGITAL AC CLAMP METER
MS2026R

SKU NO.: MS2026RCBGLO
UPC CODE: 810053676776
EAN CODE: 8435394785301

FEATURE

- Auto & Manual Ranging.
- Auto Power Off.
- Diode Open Voltage 3.3V.
- Low Battery Display.

SPECIFICATIONS

AC Voltage 750V	DC Voltage 1000V	DC Current 1000A
Resistance 60MΩ	Capacitance 4000μF	Frequency 10kHz
Display Counts 6000	Jaw Opening 40mm/1.6"	Continuity <50±20Ω

CONTENTS



222×86×32mm
8.74"×3.38"×1.26"
323g/0.71lb



3×1.5V AAA
Batteries



ACCESSORIES

Test Leads
Carry bag
Battery



Calibration
Certificate



Quick Start
Guide

PACKAGING INFORMATION



Color Box
L130×W63×H255mm



Carton Box
53×34×28.5cm



X 20PCS



MAIN APPLICATIONS

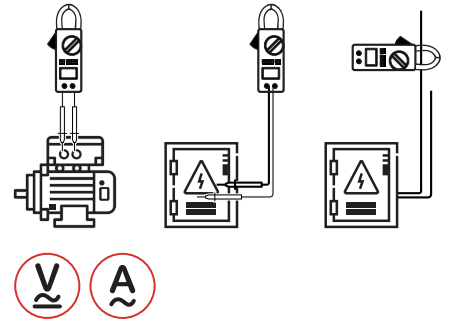
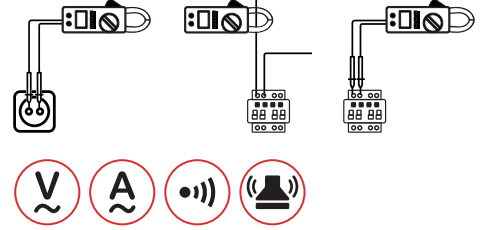

DIGITAL AC CLAMP METER
MS2028A

SKU NO.: MS2028ACBGLO
UPC CODE: 810053674642
EAN CODE: 8435394779706

FEATURE

- Auto & Manual Ranging.
- Auto Power Off.
- Diode Open Voltage 1.5V.
- True Root Mean Square.

SPECIFICATIONS

AC Voltage 600V	DC Voltage 600V	DC Current 600A
Resistance 20MΩ	Display Counts 2000	Jaw Opening 26mm/1.0"
Continuity <50Ω		

CONTENTS



208×78×35mm
8.2"×3.1"×1.4"
245g/0.54lb



3×1.5V AAA
Batteries



ACCESSORIES

Test Leads
Carry bag
Battery



Calibration
Certificate



Quick Start
Guide

PACKAGING INFORMATION



Color Box
L105×W55×H235mm



Carton Box
50×30.5×23cm



X 20PCS



MAIN APPLICATIONS

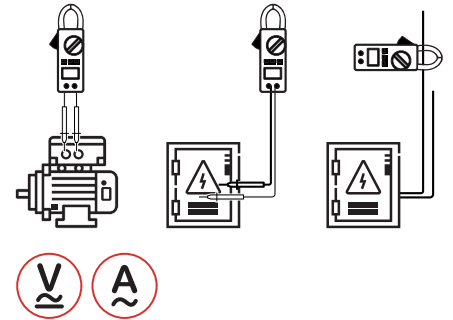
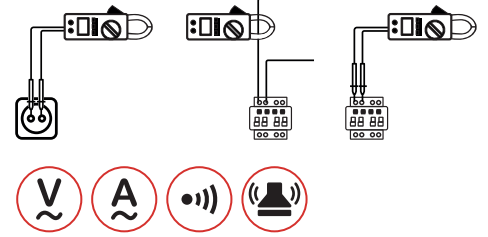

DIGITAL AC CLAMP METER
MS2030

SKU NO.: MS2030CBGLO
UPC CODE: 810053672556
EAN CODE: 8435394778198

FEATURE

- Diode Open Voltage 4.5V.
- Data Hold.
- Low Battery Display.

SPECIFICATIONS

AC Voltage 600V	DC Voltage 600V	AC Current 400A
Resistance 2kΩ	Display Counts 2000	Jaw Opening 28mm/1.1"
Continuity <50±20Ω		

CONTENTS



198×79×38mm
7.8"×3.1"×1.5"
195g/0.43lb



3×1.5V AAA
Batteries



ACCESSORIES

Test Leads
Carry bag
Battery



Calibration
Certificate



Quick Start
Guide

PACKAGING INFORMATION



Color Box
L105×W55×H235mm



Carton Box
50×30.5×23cm



X 20PCS



MAIN APPLICATIONS

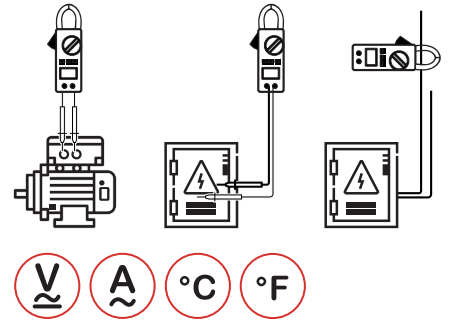
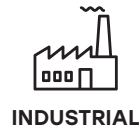
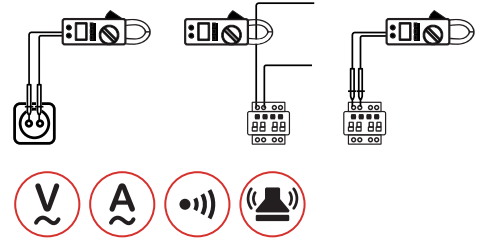

DIGITAL AC CLAMP METER
MS2030B

SKU NO.: MS2030BCBGLO
UPC CODE: 810053674666
EAN CODE: 8435394779720

FEATURE

- Auto & Manual Ranging.
- Auto Power Off.
- Data Hold.
- Non-Contact Voltage Detector.

SPECIFICATIONS

AC Voltage 600V	DC Voltage 600V	AC Current 600A
Resistance 40MΩ	Capacitance 100μF	Frequency 10kHz
Display Counts 4000	Jaw Opening 28mm/1.1"	Continuity <50±20Ω
Temperature -20°C~1000°C/-4°F~1832°F		

CONTENTS



198×79×38mm
7.8"×3.1"×1.5"
195g/0.43lb



3×1.5V AAA
Batteries



ACCESSORIES

Test Leads
K-type thermocouple
Carry bag
Battery



Calibration
Certificate



Quick Start
Guide

PACKAGING INFORMATION



Color Box
L105×W55×H235mm



Carton Box
50×30.5×23cm



X 20PCS



MAIN APPLICATIONS

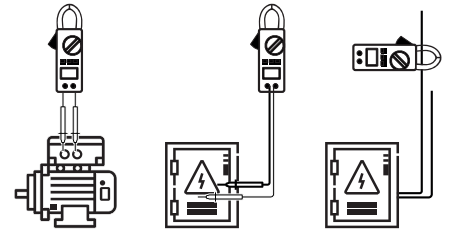
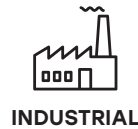
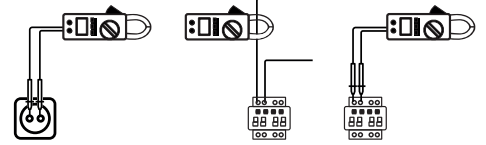

SMART DIGITAL CLAMP METER
MS2033A

SKU NO.: MS2033ACBGLO
UPC CODE: 810053674932
EAN CODE: 8435394782676

FEATURE

- Auto Ranging.
- Auto Power Off.
- Dual Display.
- MAX/MIN.

SPECIFICATIONS

AC Voltage 600V	DC Voltage 600V	AC Current 600A
Resistance 10MΩ	Frequency 3kHz	Display Counts 6000
Jaw Opening 26mm/1.0"	Continuity <40Ω	

CONTENTS



204x78x43mm
8"x3.07"x1.77"
195g/0.43lb



3x1.5V AAA
Batteries



ACCESSORIES

Test Leads
Carry bag
Battery



Calibration
Certificate



Quick Start
Guide

PACKAGING INFORMATION



Color Box
L105xW55xH235mm



Carton Box
50x30.5x23cm



X 20PCS



MAIN APPLICATIONS

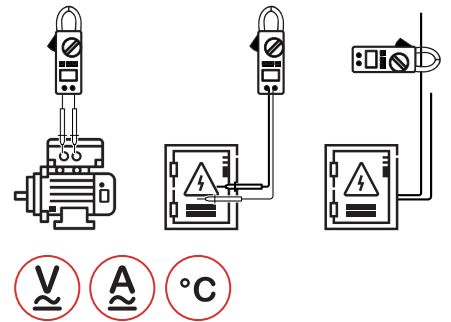
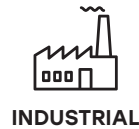
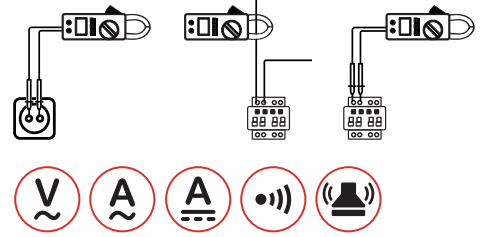

DIGITAL AC/DC CLAMP METER
MS2101

SKU NO.: MS2101CBGLO
UPC CODE: 810053672105
EAN CODE: 8435394777832

FEATURE

- Auto and Manual Ranging.
- Auto Power Off.
- Diode Open Voltage 2.2V.
- Data Hold.

SPECIFICATIONS

AC Voltage 750V	DC Voltage 1000V	AC Current 1000A
DC Current 1000A	Resistance 40MΩ	Capacitance 100μF
Frequency 100kHz	Display Counts 4000	Jaw Opening 42mm/1.7"
Continuity <50Ω±20Ω	Temperature -40°C~750°C	

CONTENTS



250×99×43mm
9.8"×3.9"×1.7"
416g/0.92lb



1×9V 6F22
Battery



ACCESSORIES

Test Leads
K-type thermocouple
Carry bag
Battery



Calibration
Certificate



Quick Start
Guide

PACKAGING INFORMATION



Color Box
L130×W60×H300mm



Carton Box
35.5×33×29cm



X 10PCS



DIGITAL AC/DC CLAMP METER
MS2108

SKU NO.: MS2108CBGLO
UPC CODE: 810053673232
EAN CODE: 8435394778969

FEATURE

- Auto & Manual Ranging.
- Auto Power Off.
- Inrush 100ms Current Integral.
- True Root Mean Square.

SPECIFICATIONS

AC Voltage 600V	DC Voltage 600V	AC Current 600A
DC Current 600A	Resistance 66MΩ	Capacitance 66mF
Frequency 1kHz	Display Counts 6600	

MAIN APPLICATIONS

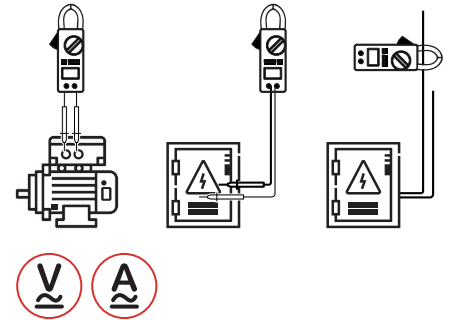
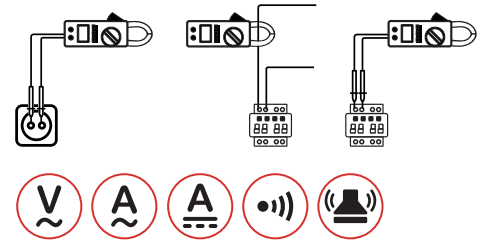

CONTENTS



208x78x53mm
8.2"x3.1"x1.4"
245g/0.54lb



3x1.5V AAA
Batteries



ACCESSORIES

Test Leads
Carry bag
Battery



Calibration
Certificate



Quick Start
Guide

PACKAGING INFORMATION



Color Box
L105xW55xH235mm



Carton Box
50x30.5x23cm



X 20PCS



MAIN APPLICATIONS

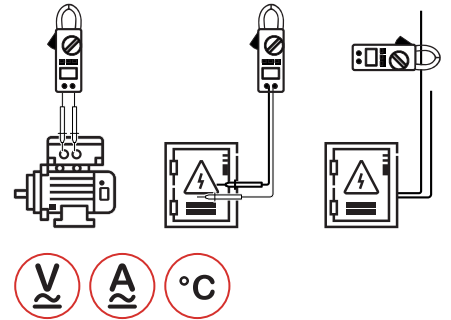
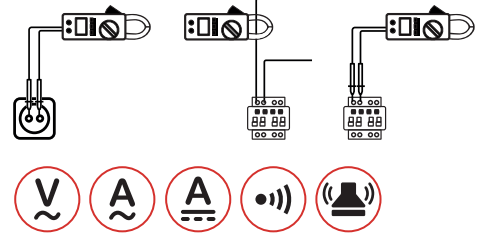

DIGITAL AC/DC CLAMP METER
MS2109A

SKU NO.: MS2109ACBGLO
UPC CODE: 810053672112
EAN CODE: 8435394777849

FEATURE

- Auto Ranging.
- Auto Power Off.
- Non-Contact Voltage Detector.
- Relative Measurement.

SPECIFICATIONS

AC Voltage 600V	DC Voltage 600V	AC Current 600A
DC Current 600A	Resistance 60MΩ	Capacitance 4000μF
Frequency 10kHz	Display Counts 6000	Jaw Opening 26mm/1.0"
Temperature -20°C~1000°C/-4°F~1832°F		Continuity <50±20Ω

CONTENTS



218×78×35mm
8.9"×3.1"×1.4"
239g/0.53lb



3×1.5V AAA
Batteries



ACCESSORIES

Test Leads
K-type thermocouple
Carry bag
Battery



Calibration
Certificate



Quick Start
Guide

PACKAGING INFORMATION



Color Box
L105xW55xH235mm



Carton Box
50×30.5×23cm



X 20PCS



MAIN APPLICATIONS

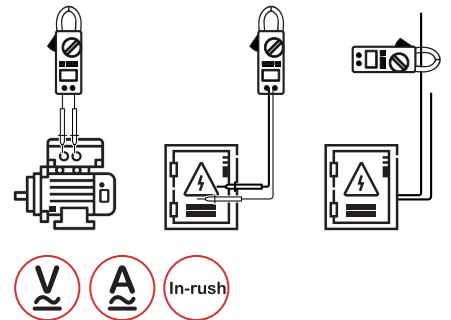
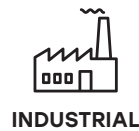
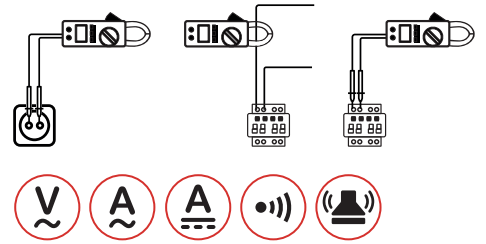

DIGITAL AC/DC CLAMP METER
MS2125A

SKU NO.: MS2125ACBGLO
UPC CODE: 810053672129
EAN CODE: 8435394777856

FEATURE

- Auto & Manual Ranging.
- Auto Power Off.
- Non-Contact Voltage Detector.
- Relative Measurement.

SPECIFICATIONS

AC Voltage 750V	DC Voltage 1000V	AC Current 1000A
DC Current 1000A	Resistance 60MΩ	Capacitance 100mF
Frequency 1000Hz	Display Counts 6000	Jaw Opening 40mm/1.6"
Continuity <50Ω		

CONTENTS



238×92×50mm
9.37"×3.6"×1.9"
386g/0.85lb



1×9V 6F22
Battery



ACCESSORIES

Test Leads
Carry bag
Battery



Calibration
Certificate



Quick Start
Guide

PACKAGING INFORMATION



Color Box
L130×W63×H255mm



Carton Box
53×34×28.5mm



X 20PCS



MAIN APPLICATIONS

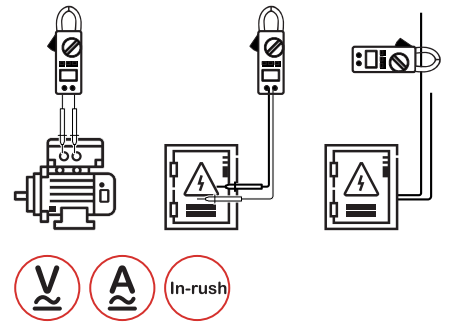
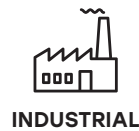
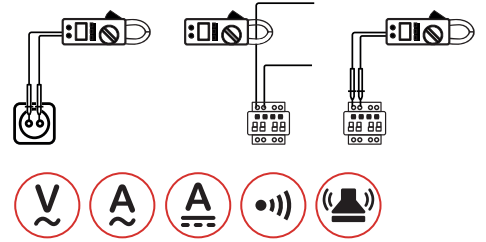

DIGITAL AC/DC CLAMP METER
MS2128

SKU NO.: MS2128CBGLO
UPC CODE: 810053674178
EAN CODE: 8435394779249

FEATURE

- Auto & Manual Ranging.
- Auto Power Off.
- Inrush 100ms Current Integral.
- True Root Mean Square.

SPECIFICATIONS

AC Voltage 600V	DC Voltage 600V	AC Current 600A
DC Current 600A	Resistance 66MΩ	Capacitance 66mF
Frequency(A) 1kHz	Frequency(V) 10kHz	Display Counts 6600
Jaw Opening 26mm/1.0"	Continuity <50±20Ω	

CONTENTS



208x78x53mm
8.2"x3.1"x1.4"
245g/0.54lb



3x1.5V AAA
Batteries



ACCESSORIES

Test Leads
Carry bag
Battery



Calibration
Certificate



Quick Start
Guide

PACKAGING INFORMATION



Color Box
L105xW55xH235mm



Carton Box
50x30.5x23cm



X 20PCS



MAIN APPLICATIONS

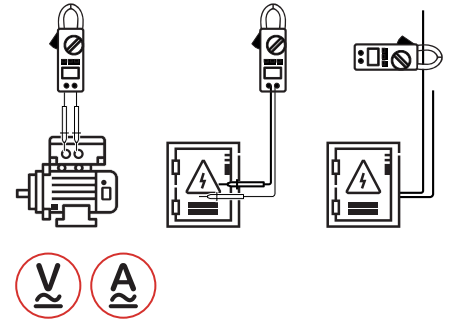
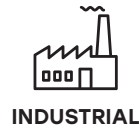
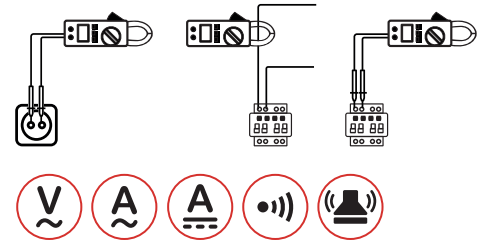

DIGITAL AC/DC CLAMP METER MS2128A

SKU NO.: MS2128ACBGLO
UPC CODE: 810053674673
EAN CODE: 8435394779737

FEATURE

- Auto & Manual Ranging.
- Auto Power Off.
- Relative measurement.
- Diode Open Voltage 3.0V.

SPECIFICATIONS

AC Voltage 600V	DC Voltage 600V	AC Current 400A
DC Current 400A	Resistance 40MΩ	Capacitance 4000μF
Frequency(A) 1kHz	Frequency(V) 10kHz	Frequency(Hz) 10kHz
Display Counts 4000	Jaw Opening 26mm/1.0"	Continuity <50±20Ω

CONTENTS



208×78×53mm
8.2"×3.1"×1.4"
245g/0.54lb



3×1.5V AAA
Batteries



ACCESSORIES

Test Leads
Carry bag
Battery



Calibration
Certificate



Quick Start
Guide

PACKAGING INFORMATION



Color Box
L105×W55×H235mm



Carton Box
50×30.5×23cm



X 20PCS



DIGITAL AC/DC CLAMP METER
MS2138

SKU NO.: MS2138CBGLO
UPC CODE: 810053672136
EAN CODE: 8435394778464

FEATURE

- Auto & Manual Ranging.
- Auto Power Off.
- Diode Open Voltage 2.8V.
- Relative Measurement.

SPECIFICATIONS

AC Voltage 600V	DC Voltage 600V	AC Current 1000A
DC Current 1000A	Resistance 40MΩ	Capacitance 4000μF
Frequency 10kHz	Display Counts 4000	Jaw Opening 40mm/1.6"
Continuity <50±20Ω		

MAIN APPLICATIONS

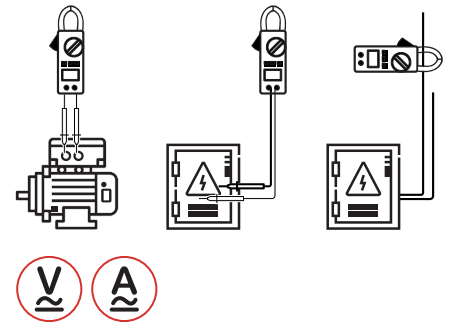
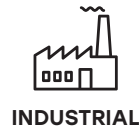
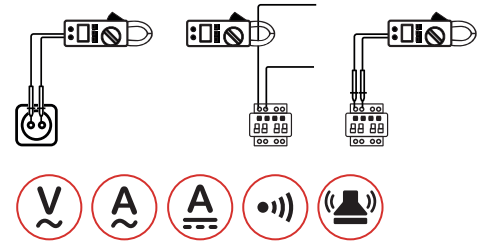

CONTENTS



222×86×32mm
8.74"×3.38"×1.26"
323g/0.71lb



3×1.5V AAA
Batteries



ACCESSORIES

Test Leads
Carry bag
Battery



Calibration
Certificate



Quick Start
Guide

PACKAGING INFORMATION



Color Box
L130×W63×H255mm



Carton Box
53×34×28.5mm



X 20PCS



MAIN APPLICATIONS

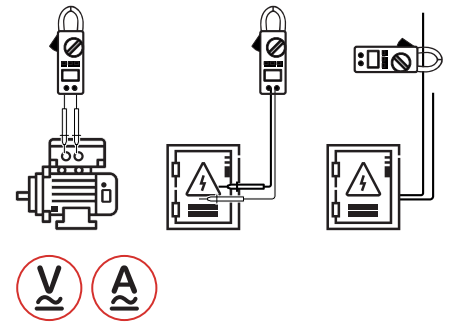
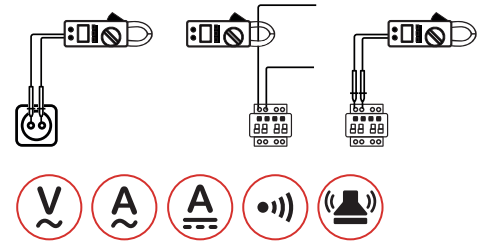

DIGITAL AC/DC CLAMP METER (T-RMS)
MS2138R

SKU NO.: MS2138RCBGLO
UPC CODE: 810053672143
EAN CODE: 8435394777863

FEATURE

- Auto & Manual Ranging.
- Auto Power Off.
- Diode Open Voltage 2.8V.
- Relative Measurement.

SPECIFICATIONS

AC Voltage 600V	DC Voltage 600V	AC Current 1000A
DC Current 1000A	Resistance 40MΩ	Capacitance 4000μF
Frequency 10kHz	Continuity test <50±20Ω	Display Counts 4000
Jaw Opening 40mm/1.6"		

CONTENTS



222×86×32mm
8.74"×3.38"×1.26"
323g/0.71lb



3×1.5V AAA
Batteries



ACCESSORIES

Test Leads
Carry bag
Battery



Calibration
Certificate



Quick Start
Guide

PACKAGING INFORMATION



Color Box
L130×W63×H255mm



Carton Box
53×34×28.5mm



X 20PCS



MAIN APPLICATIONS

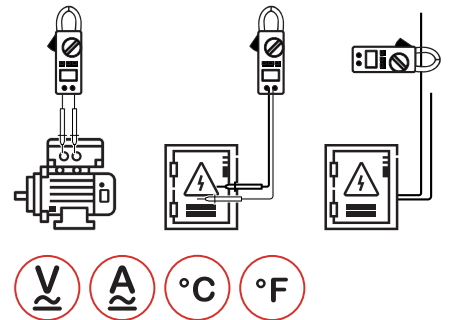
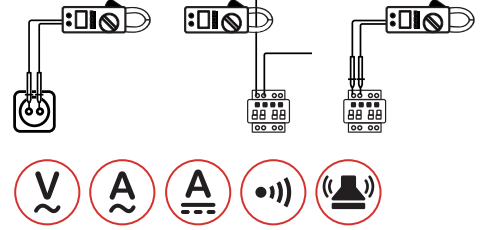

DIGITAL AC/DC CLAMP METER
MS2160

SKU NO.: MS2160CBGLO
UPC CODE: 810053674185
EAN CODE: 8435394779256

FEATURE

- Auto & Manual Ranging.
- Auto Power Off.
- Non-Contact Voltage Detector.
- Diode Open Voltage 3.2V.

SPECIFICATIONS

AC Voltage 600V	DC Voltage 600V	AC Current 80A
DC Current 80A	Resistance 40MΩ	Capacitance 40mF
Frequency 10kHz	Display Counts 4000	Continuity <50Ω
Jaw Opening 24mm/0.9"	Temperature -20°C~100°C/-4°F~1832°F	

CONTENTS



195×80×45mm
7.8"×3.1"×1.8"
195g/0.43lb



3×1.5V AAA
Batteries



Test Leads
K-type thermocouple
Carry bag
Battery



Calibration
Certificate



Quick Start
Guide

PACKAGING INFORMATION



Color Box
L105×W55×H235mm



Carton Box
50×30.5×23cm



X 20PCS



MAIN APPLICATIONS



INDUSTRIAL

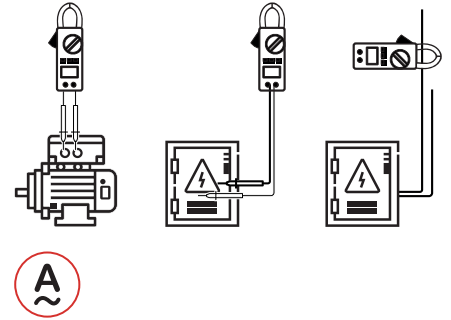

**HIGH SENSITIVITY
AC LEAKAGE CLAMP METER
MS2006B**

SKU NO.: MS2006BCBGLO
UPC CODE: 810053672532
EAN CODE: 8435394778174

FEATURE

- Auto Power Off.
- Data Hold.
- Low Battery Display.

SPECIFICATIONS

AC Current 60A	Display Counts 2000	Jaw Opening 31mm/1.2"
--------------------------	-------------------------------	---------------------------------

CONTENTS



176×59×28mm
6.9"×2.3"×1.1"
150g/0.33lb



2×1.5V AAA
Batteries



Carry bag
Battery

ACCESSORIES



Calibration
Certificate



Quick Start
Guide

PACKAGING INFORMATION



Color Box
L75×W45×H190mm



Carton Box
45×33×29.5cm



X 50PCS



MAIN APPLICATIONS

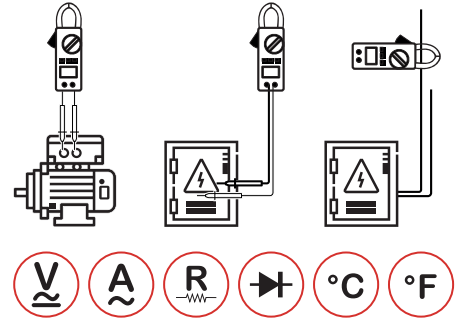

AC LEAKAGE CLAMP METER
MS2016A

SKU NO.: MS2016ACBGLO
UPC CODE: 810053675052
EAN CODE: 8435394783062

FEATURE

- Auto Ranging.
- Auto Power Off.
- True RMS For AC Voltage.
- Low Pass Filter Function (50/60Hz).

SPECIFICATIONS

AC Voltage 600V	DC Voltage 600V	AC Current 150A
Resistance 40MΩ	Capacitance 40mF	Jaw Opening 30mm/1.2"
Display Counts 4000	Temperature -20°C~1000°C/-4°F~1832°F	

CONTENTS



213×62×38mm
8.39"×2.44"×1.5"
238g/0.52lb



2×1.5V AAA
Batteries



ACCESSORIES

Test Leads
K-type thermocouple
Carry bag
Battery



Calibration
Certificate



Quick Start
Guide

PACKAGING INFORMATION



Color Box
L105×W55×H235mm



Carton Box
50×30.5×23cm



X 20PCS



MAIN APPLICATIONS

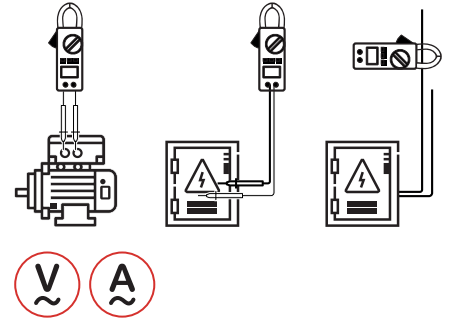
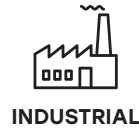

THREE PHASE DIGITAL POWER CLAMP METER
MS2203

SKU NO.: MS2203CBGLO
UPC CODE: 810053672570
EAN CODE: 8435394778211

FEATURE

- Auto & Manual Ranging.
- Data Logging 28 groups.
- True Root Mean Square.
- Bar Graph.

SPECIFICATIONS

AC Voltage 600V	AC Current 1000A	Frequency 1000Hz
Active Power 600kW	Apparent Power 600kVA	Reactive Power 600kVAr
Jaw Opening 50mm/2.0"	Display Counts 9999	

CONTENTS



300x103x51mm
11.8"x4.1"x2.0"
640g/1.4lb



4x1.5V AAA
Batteries



ACCESSORIES

Test Leads
Alligator clip
RS232C interface cable
PC data record graph
software
Carry Case
Battery



Calibration
Certificate



Quick Start
Guide

PACKAGING INFORMATION



Color Box
L370xW140xH324mm



Carton Box
58x39x35cm



X 4PCS



MAIN APPLICATIONS

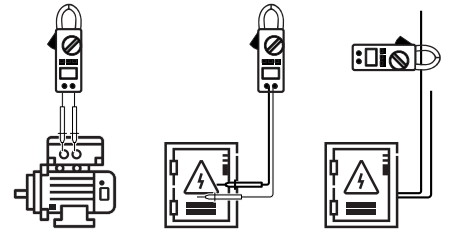
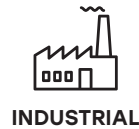
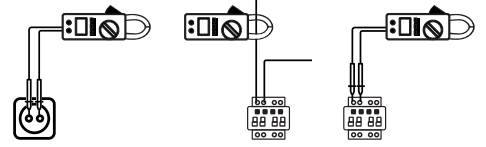

THREE PHASE DIGITAL POWER CLAMP METER
MS2205

SKU NO.: MS2205CBAGLO
UPC CODE: 810053674192
EAN CODE: 8435394779263

FEATURE

- Auto & Manual Ranging.
- Auto Power Off.
- Data Hold.
- True Root Mean Square.

SPECIFICATIONS

AC Voltage 600V	AC Current 1000A	Frequency 1000Hz
Active Power 600kW	Apparent Power 600kVA	Reactive Power 600kVAR
Jaw Opening 50mm/2.0"	Display Counts 6000	

CONTENTS



300x103x51mm
11.8"x4.1"x2.0"
640g/1.4lb



4x1.5V AAA Batteries



ACCESSORIES

Test Leads
Alligator clip
RS232C interface cable
PC data record graph software
Carry Case
Battery



Calibration Certificate



Quick Start Guide

PACKAGING INFORMATION



Color Box
L370xW140xH324mm



Carton Box
58x39x35cm



X 4PCS



MAIN APPLICATIONS

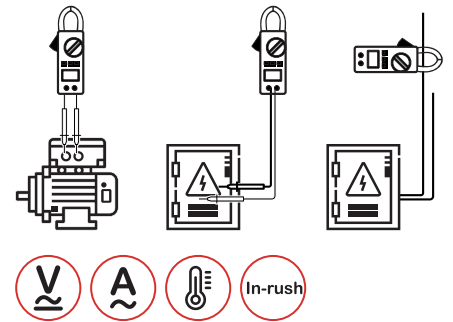
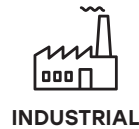
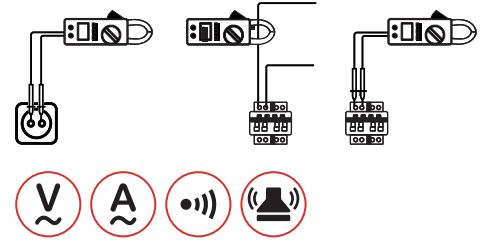

SINGLE PHASE POWER CLAMP METER MS2225A

SKU NO.: MS2225ACBGLO
UPC CODE: 810053674680
EAN CODE: 8435394779744

FEATURE

- Auto & Manual Ranging.
- Auto Power Off.
- True Root Mean Square.
- Diode Open voltage 3.2V.

SPECIFICATIONS

AC Voltage 750V	DC Voltage 1000V	AC Current 1000A
Resistance 60MΩ	Capacitance 1000mF	Continuity <50Ω
Frequency 10kHz	Display Counts 6000	Jaw Opening 40mm/1.6"

CONTENTS



250×98×53mm
9.84"×3.78"×2.09"
450g/0.99lb



1×9V 6F22
Battery



ACCESSORIES

Test Leads
Carry bag
Battery



Calibration
Certificate

Alligator clip
(option)



Quick Start
Guide

PACKAGING INFORMATION



Color Box
L130×W63×H255mm



Carton Box
53×34×28.5mm



X 20PCS



MAIN APPLICATIONS



DOMESTIC

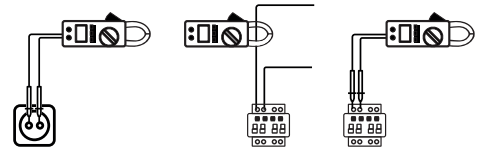

INDUSTRIAL

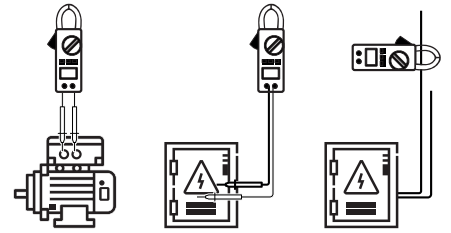

AC/DC CLAMP METER
M9912

SKU NO.: M9912CBAGLO
UPC CODE: 810053674079
EAN CODE: 8435394779140

FEATURE

- Diode and Continuity.
- Display Backlight.
- Data Hold.

SPECIFICATIONS

AC Voltage 750V	DC Voltage 750V	AC Current 1000A
DC Current 1000A	Resistance 30MΩ	Frequency 30kHz
Display Counts 3200	Jaw Opening 55mm/2.2"	

CONTENTS



282×104×47mm
11.1"×4.09"×1.85"
500g/0.83lb



1×9V 6F22
Battery



ACCESSORIES

Test Leads
Carry bag
Battery



Calibration
Certificate



Quick Start
Guide

PACKAGING INFORMATION



Color Box
L300×W65×H250mm



Carton Box
61.5×37×27cm



X 10PCS



MAIN APPLICATIONS

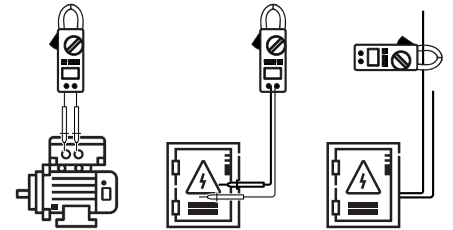
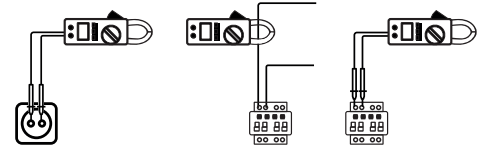

DIGITAL CLAMP METER
MS2015A

SKU NO.: MS2015ACBGLO
UPC CODE: 810053673256
EAN CODE: 8435394778983

FEATURE

- Display 6000 Counts.
- Auto & Manual Ranging.
- Non-Contact Voltage Detector.

SPECIFICATIONS

AC Voltage 750V	DC Voltage 1000V	AC Current 1000A
Resistance 60MΩ	Capacitance 100mF	Frequency(A) 10MHz
Display Counts 6000	Jaw Opening 40mm/1.6"	

CONTENTS



82×42×32mm
3.2"×1.65"×1.26"
45g/0.1lb



1×9V 6F22
Battery



ACCESSORIES

Test Leads
Carry bag
Battery



Calibration
Certificate



Quick Start
Guide

PACKAGING INFORMATION



Color Box
L130×W63×H255mm



Carton Box
53×34×28.5mm



X 20PCS



MAIN APPLICATIONS

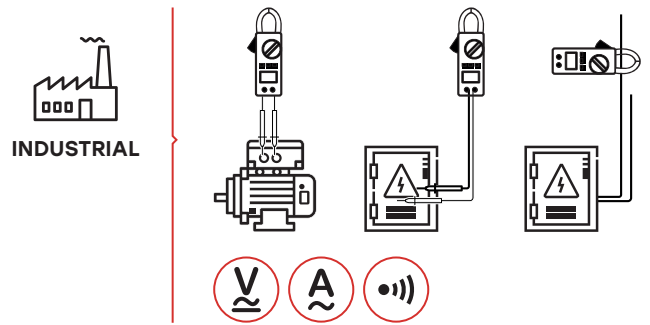

CONTENTS



192×68×43mm
7.56"×2.67"×1.7"
230g/0.5lb



1×9V 6F22
Battery



ACCESSORIES

Test Leads
Carry bag
Battery



Calibration
Certificate



Quick Start
Guide

DIGITAL AC CLAMP METER
MS2600

SKU NO.: MS2600CBGLO
UPC CODE: 810053676806
EAN CODE: 8435394785332

FEATURE

- Auto & Manual Ranging.
- Auto Power Off.
- Relative Measurement.
- Diode Open Voltage 1.5V.

SPECIFICATIONS

AC Voltage 700V	DC Voltage 1000V	AC Current 200A
Resistance 40MΩ	Capacitance 40μF	Frequency(Hz/Duty) 4kHz/100kHz
Display Counts 4000	Jaw Opening 12mm/0.5"	Continuity <50±20Ω

PACKAGING INFORMATION



Color Box
L172×W80×H255mm



Carton Box
53×44.5×37cm



X 20PCS



MAIN APPLICATIONS

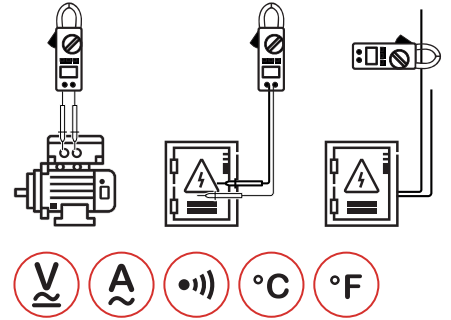

CONTENTS



201×65×43mm
7.7"×2.6"×1.7"
265g/0.58lb



1×9V 6F22
Battery



ACCESSORIES

Test Leads
K type thermocouple
Carry bag
Battery



Calibration
Certificate



Quick Start
Guide

DIGITAL AC CLAMP METER
MS2601

SKU NO.: MS2601CBGLO
UPC CODE: 810053674215
EAN CODE: 8435394779287

FEATURE

- Auto & Manual Ranging.
- Auto Power Off.
- Non-Contact Voltage Detector.
- Diode Open Voltage 3.2V.

SPECIFICATIONS

AC Voltage 600V	DC Voltage 600V	AC Current 200A
Resistance 60MΩ	Capacitance 60mF	Frequency(A/V) 60Hz/60MHz
Display counts 6000	Jaw opening 12mm/0.5"	Continuity <50Ω
Temperature -20°C~400°C/-4°F~752°F		

PACKAGING INFORMATION



Color Box
L172×W80×H255mm



Carton Box
53×44.5×37cm



X 20PCS



MAIN APPLICATIONS

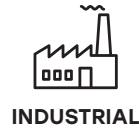

INDUSTRIAL

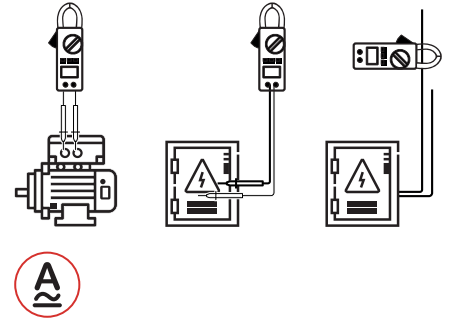

CONTENTS



256×104×47mm
9.3"×3.86"×1.9"
520g/1.1lb



1×9V 6F22
Battery



ACCESSORIES

Wrapping Case



Calibration
Certificate



Quick Start
Guide

DIGITAL CLAMP TRANSDUCER
MS3300

SKU NO.: MS3300CBGLO
UPC CODE: 810053675090
EAN CODE: 8435394783086

FEATURE

- True Root Mean Square.
- DCA Zero Adjust.

SPECIFICATIONS

AC Current
1000A

DC Current
1000A

AC Output
1mV/A

DC Output
1mV/A

Jaw opening
55mm/2.2"

PACKAGING INFORMATION



Color Box
L300×W65×H250mm



Carton Box
61.5×37×27cm



X 10PCS



MAIN APPLICATIONS



INDUSTRIAL

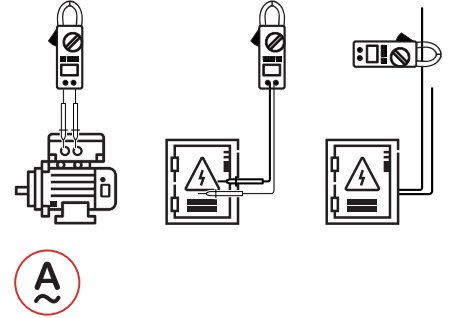

CONTENTS



143×64×30mm
5.6"×2.5"×1.2"
185g/0.4lb



Calibration Certificate



ACCESSORIES

Wrapping Case



Quick Start Guide

DIGITAL CLAMP TRANSDUCER

MS3302

SKU NO.: MS3302CBGLO
UPC CODE: 810053674697
EAN CODE: 8435394784311

FEATURE

- Jaw Opening Φ 28mm/1.1".

SPECIFICATIONS

AC Current
400A

Output
1mV/A

PACKAGING INFORMATION



Color Box
L115×W55×H165mm



Carton Box
47.5×34.5×32cm



X 40PCS

AC LINE SPLITTERS

USA TYPE | EU TYPE | UK TYPE





MAIN APPLICATIONS

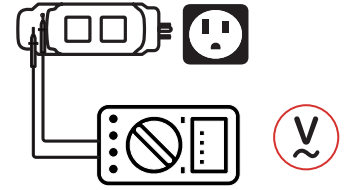
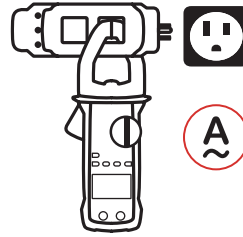

CONTENTS



171x57x48mm
6.7"x2.2"x1.9"
131g/0.29lb



Calibration Certificate



Quick Start Guide

PACKAGING INFORMATION



Color Box
L85xW65xH230mm



Carton Box
48x34.5x36.5cm



X 40PCS

AC LINE SPLITTER

MS922A

SKU NO.: MS922ACBGLO
UPC CODE: 810053675380
EAN CODE: 8435394783420

FEATURE

- Allows for Easy AC Current Measurements Using a Clamp Meter on 2 or 3 Wire Power Cords.
- Voltage Check Sockets for Easy Power Calculations.

SPECIFICATIONS

AC Voltage
125V

AC Current
15A



MAIN APPLICATIONS

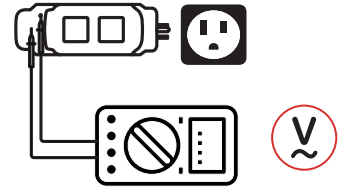
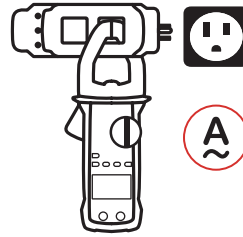

CONTENTS



200x57x48mm
7.8"x2.2"x2.9"
140g/0.3lb



Calibration Certificate



Quick Start Guide

PACKAGING INFORMATION



Color Box
L85xW65xH230mm



Carton Box
48x34.5x36.5cm



X 40PCS

AC LINE SPLITTER

MS922D

SKU NO.: MS922DCBGLO
UPC CODE: 810053675397
EAN CODE: 8435394783437

FEATURE

- Allows for Easy AC Current Measurements Using a Clamp Meter on 2 or 3 Wire Power Cords.
- Voltage Check Sockets for Easy Power Calculations.

SPECIFICATIONS

AC Voltage
250V

AC Current
15A



MAIN APPLICATIONS

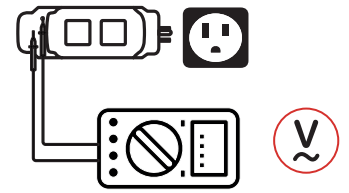
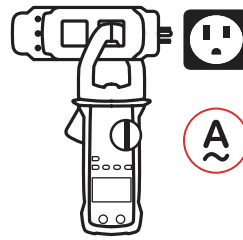

CONTENTS



173x57x48mm
6.8"x2.2"x1.9"
131g/0.29lb



Calibration Certificate



Quick Start Guide

PACKAGING INFORMATION



Color Box
L85xW65xH230mm



Carton Box
48x34.5x36.5cm



X 40PCS

AC LINE SPLITTER

MS922E

SKU NO.: MS922ECBGLO
UPC CODE: 810053675403
EAN CODE: 8435394783444

FEATURE

- Allows for Easy AC Current Measurements Using a Clamp Meter on 2 or 3 Wire Power Cords.
- Voltage Check Sockets for Easy Power Calculations.

SPECIFICATIONS

AC Voltage
250V

AC Current
15A

ELECTRICAL TESTERS

NON CONTACT VOLTAGE TESTER
TWO POLE VOLTAGE TESTER





MAIN APPLICATIONS

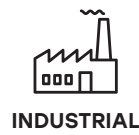
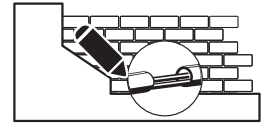

NCV WITH INFRARED THERMOMETER
MS6580B

SKU NO.: MS6580BCBGLO
UPC CODE: 810053675250
EAN CODE: 8435394783260

FEATURE

- Non-Contact Voltage Detector.
- NCV Sensitivity 4 Levels.
- Infrared Temperature.
- Spectral Response 8-14 μm.

SPECIFICATIONS

AC Voltage 1000V	Temperature -20°C~330°C/-46°F~626°F
Repeatability ±0.1°C	Emissivity 0.95

CONTENTS

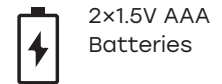
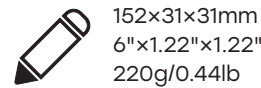

PACKAGING INFORMATION

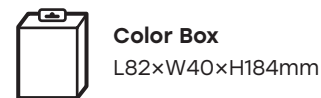



MAIN APPLICATIONS



DOMESTIC

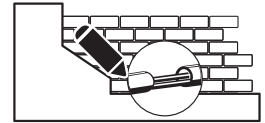

INDUSTRIAL



NON CONTACT AC VOLTAGE DETECTOR
MS8900

SKU NO.: MS8900CBGLO
UPC CODE: 810053672723
EAN CODE: 8435394778365

FEATURE

- Sound and Light Instruction.
- Double Molded Case.
- Operating Temperature 0°C~50°C.

SPECIFICATIONS

AC Voltage 100~240V	Frequency 50Hz~60Hz	Humidity 85%RH
-------------------------------	-------------------------------	--------------------------

CONTENTS



157×24×20mm
6.18"×0.94"×0.78"
42g/0.09lb



2×1.5V AAA
Batteries



ACCESSORIES

Battery



Calibration
Certificate



Quick Start
Guide

PACKAGING INFORMATION



Color Box
L82×W40×H184mm



Carton Box
39×22×35.5cm



X 40PCS



MAIN APPLICATIONS

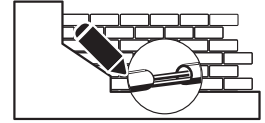

NON CONTACT AC VOLTAGE DETECTOR
MS8900A

SKU NO.: MS8900ACBGLO
UPC CODE: 810053673041
EAN CODE: 8435394778778

FEATURE

- Sound and Light Instruction.
- Double Molded Case.
- Operating Temperature 0°C~50°C.

SPECIFICATIONS

AC Voltage 90~1000V	Frequency 50Hz~60Hz	Humidity 85%RH
Altitude <2000m		

CONTENTS



157×24×20mm
6.18"×0.94"×0.78"
42g/0.09lb



2×1.5V AAA
Batteries



ACCESSORIES

Battery



Calibration
Certificate



Quick Start
Guide

PACKAGING INFORMATION



Color Box
L82×W40×H184mm



Carton Box
39×22×35.5cm



X 40PCS



MAIN APPLICATIONS



DOMESTIC

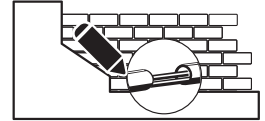

INDUSTRIAL



NON CONTACT AC VOLTAGE DETECTOR
MS8900C

SKU NO.: MS8900CCBGLO
UPC CODE: 810053675373
EAN CODE: 8435394783413

FEATURE

- Sound and Light Instruction.
- Double Molded Case.
- Operating Temperature 0°C~50°C.

SPECIFICATIONS

AC Voltage 100~240V	Frequency 50Hz~60Hz	Humidity 85%RH
Altitude <2000m		

CONTENTS



157×24×20mm
6.18"×0.94"×0.78"
42g/0.09lb



2×1.5V AAA
Batteries



ACCESSORIES

Battery



Calibration
Certificate



Quick Start
Guide

PACKAGING INFORMATION



Color Box
L82×W40×H184mm



Carton Box
39×22×35.5cm



X 40PCS



MAIN APPLICATIONS

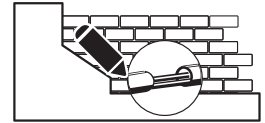

NON CONTACT AC VOLTAGE DETECTOR
MS8902A

SKU NO.: MS8902ACBGLO
 UPC CODE: 810053672730
 EAN CODE: 8435394778372

FEATURE

- Sound and Light Instruction.
- Double Molded Case.
- Operating Temperature 0°C~50°C.

SPECIFICATIONS

AC Voltage 12~1000V	Frequency 50Hz~500Hz	Humidity 85%RH
Altitude <2000m		

CONTENTS



157×24×20mm
 6.18"×0.94"×0.78"
 42g/0.09lb



2×1.5V AAA
 Batteries



ACCESSORIES

Battery



Calibration
 Certificate



Quick Start
 Guide

PACKAGING INFORMATION



Color Box
 L82×W40×H184mm



Carton Box
 39×22×35.5cm



X 40PCS



MAIN APPLICATIONS



DOMESTIC

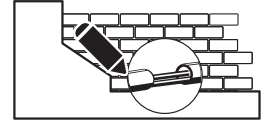

INDUSTRIAL



NON CONTACT AC VOLTAGE DETECTOR
MS8902B

SKU NO.: MS8902BCBGLO
UPC CODE: 810053674505
EAN CODE: 8435394779577

FEATURE

- Sound and Light Instruction.
- Double Molded Case.
- Operating Temperature 0°C~50°C.

SPECIFICATIONS

AC Voltage
20~1000V

Frequency
50Hz~500Hz

Humidity
85%RH

Altitude
<2000m

CONTENTS



157×24×20mm
6.18"×0.94"×0.78"
42g/0.09lb



1×12V A23S
Battery



ACCESSORIES

Battery



Calibration
Certificate



Quick Start
Guide

PACKAGING INFORMATION



Color Box
L82×W40×H184mm



Carton Box
39×22×35.5cm



X 40PCS



MAIN APPLICATIONS



DOMESTIC

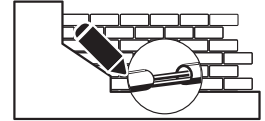

INDUSTRIAL



NON CONTACT AC VOLTAGE DETECTOR
MS8907

SKU NO.: MS8907CBGLO
UPC CODE: 810053674789
EAN CODE: 8435394779843

FEATURE

- Sound and Light Instruction.
- Work Light.
- Operating Temperature -10°C~50°C.

SPECIFICATIONS

AC Voltage 50~1000V	Frequency 50Hz/60Hz	Humidity 85%RH
Altitude <2000m		

CONTENTS



157×24×20mm
6.2"×0.95"×0.79"
42g/0.09lb



2×1.5V AAA
Batteries



ACCESSORIES

Battery



Calibration
Certificate



Quick Start
Guide

PACKAGING INFORMATION



Color Box
L82×W40×H184mm



Carton Box
39×22×35.5cm



X 40PCS



MAIN APPLICATIONS



DOMESTIC

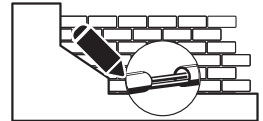

INDUSTRIAL



VOLTAGE TESTER

MS8922A

SKU NO.: MS8922ACBGLO
 UPC CODE: 810053674529
 EAN CODE: 8435394779591

FEATURE

- Ergonomic Design That Facilitates Its Use.
- Operation Time Maximum 30s.
- Recovery Time 10 Minutes.

SPECIFICATIONS

AC Voltage
400V

DC Voltage
400V

Frequency
50Hz/60Hz

Altitude
<2000m

CONTENTS



223×40×32mm
 8.78"×1.57"×1.26"
 98.5g/0.26lb



Calibration Certificate



Quick Start Guide

PACKAGING INFORMATION



Color Box
 L125×W40×H255mm



Carton Box
 53×25×27cm



X 20PCS



MAIN APPLICATIONS



DOMESTIC

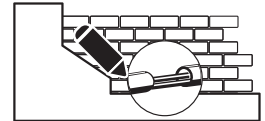

INDUSTRIAL



VOLTAGE TESTER WITH RCD
MS8922B

SKU NO.: MS8922BCBGLO
UPC CODE: 810053674536
EAN CODE: 8435394779607

FEATURE

- RCD Test Function.
- Operation Time Maximum 30s.
- Recovery Time 10 Minutes.
- Operation Temperature -10~55°C/14~131°F.

SPECIFICATIONS

AC Voltage
400V

DC Voltage
400V

Frequency
50Hz/60Hz

Altitude
<2000m

CONTENTS



223×40×32mm
8.78"×1.57"×1.26"
98.5g/0.26lb



Calibration Certificate



Quick Start Guide

PACKAGING INFORMATION



Color Box
L125×W40×H255mm



Carton Box
53×25×27cm



X 20PCS

CIRCUIT TESTERS

WIRE TESTERS AND TRACKER | SOCKET TESTER
CIRCUIT BREAKER FINDER





3 WIRE / GFCI OUTLET TESTER
MS102

SKU NO.: MS102CBGLO
UPC CODE: 810053675038
EAN CODE: 8435394783031

FEATURE

- Quick and Easy Tool to Use to Make Sure That An Outlet or GFCI Is Safe for Use.

SPECIFICATIONS

AC Voltage 125V	Temperature 0~40°C	Humidity <80% RH
---------------------------	------------------------------	-------------------------------

MAIN APPLICATIONS

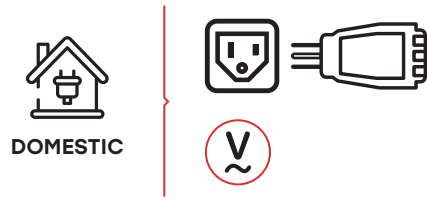

CONTENTS

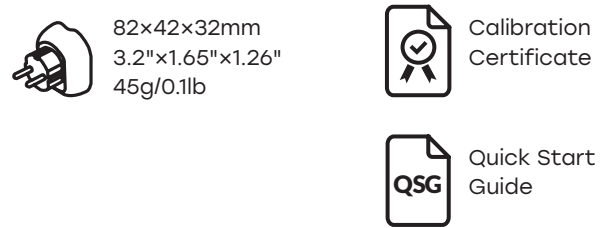

PACKAGING INFORMATION

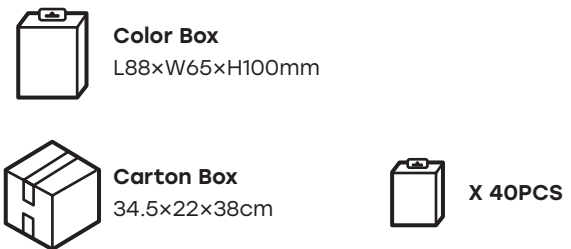



3 WIRE OUTLET TESTER
MS112

SKU NO.: MS112CBGLO
UPC CODE: 810053675045
EAN CODE: 8435394783048

FEATURE

- Quick and Easy Tool to Use to Make Sure That An Outlet or GFCI Is Safe for Use.

SPECIFICATIONS

AC Voltage 125V	Temperature 0~40°C	Humidity <80% RH
---------------------------	------------------------------	-------------------------------

MAIN APPLICATIONS

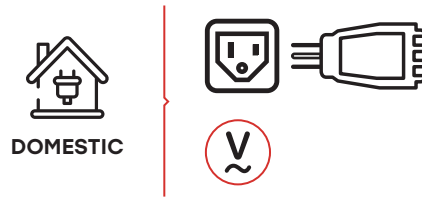

CONTENTS

- 82x42x32mm
3.2"x1.65"x1.26"
45g/0.1lb
- Calibration Certificate
- Quick Start Guide

PACKAGING INFORMATION

- Color Box**
L88xW65xH100mm
- Carton Box**
34.5x22x38cm
- X 40PCS**



MS5902RTD



MS5902RTE



MS5902RTF



MAIN APPLICATIONS



DOMESTIC

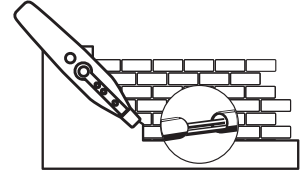
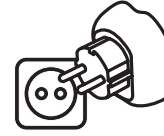

CONTENTS



MS5902R:
198×40×50mm
7.8"×1.57"×1.97"
126g/0.28lb

MS5902TD/TE:
71×64×55mm
2.8"×2.5"×2.16"
60g/0.13lb

MS5902TF:
82×42×32mm
3.2"×1.65"×1.26"
35g/0.1lb



Carry bag

ACCESSORIES



1×9V 6F22
Battery



Calibration
Certificate



Quick Start
Guide

CIRCUIT BREAKER FINDER

MS5902RT

SKU NO.	MS5902RTDCBGLO	MS5902RTECBGLO	MS5902RTFCBGLO
UPC CODE	810053672877	810053675106	810053674727
EAN CODE	8435394778556	8435394783093	8435394779782

FEATURE

- Socket Tester and Circuit Breaker Finder.
- Sound and Light Signals.
- Professional Reference.

SPECIFICATIONS

AC Voltage(TD)
230V

AC Voltage(TE)
230V

AC Voltage(TF)
120V

PACKAGING INFORMATION



Color Box
L130×W63×H255mm



Carton Box
53×34×28.5cm



X 20PCS



MS5905TD



MS5905TE



MAIN APPLICATIONS



DOMESTIC

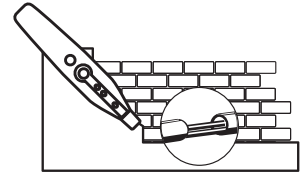
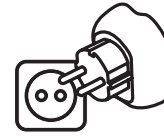

CONTENTS



MS5905R:
177×46×31mm
6.97"×1.81"×1.22"
130g/0.29lb

MS5905TD/TE:
71×64×55mm
2.8"×2.5"×2.16"
63g/0.14lb



Carry bag
Battery

ACCESSORIES



1×9V 6F22
Battery



Calibration
Certificate



Quick Start
Guide

CIRCUIT BREAKER FINDER with NCV
MS5905RT

SKU NO.	MS5905RTDCBGLO	MS5905RTECBGLO
UPC CODE	810053675120	810053673126
EAN CODE	8435394783116	8435394778853

FEATURE

- Socket Tester and Circuit Breaker Finder.
- Sound and Light Signals.
- Professional Reference.

SPECIFICATIONS

AC Voltage(TD)	AC Voltage(TE)
230V	230V

PACKAGING INFORMATION



Color Box
L130×W63×H255mm



Carton Box
53×34×28.5mm



X 20PCS



MAIN APPLICATIONS



DOMESTIC

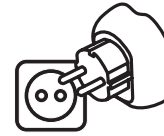

MS6860D



MS6860E

SOCKET TESTER

MS6860

SKU NO.	MS6860DCBGLO	MS6860ECBGLO
UPC CODE	810053674369	810053675281
EAN CODE	8435394779430	8435394783307

FEATURE

- Reliable and Easy to Use Modern, Ergonomic Design with Unique Soft Finger Grip Compact, Durable-Designed to Safety Standard EN61010.

SPECIFICATIONS

AC Voltage(MS6860D)
230V

AC Voltage(MS6860E)
230V

CONTENTS



68x60x56mm
2.67"x2.36"x2.2"
60g/0.13lb



Calibration Certificate



Quick Start Guide

PACKAGING INFORMATION



Color Box
L88xW65xH100mm



Carton Box
34.5x22x38cm



X 40PCS

CIRCUIT ANALYZERS

MOTOR & PHASE ROTATION INDICATOR
CIRCUIT ANALYZER





MAIN APPLICATIONS



DOMESTIC

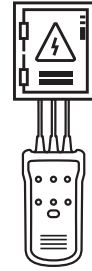
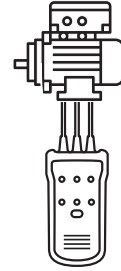

CONTENTS



130x72x32mm
5.1"x2.8"x1.3"
193g/0.43lb



1x9V 6F22
Battery



ACCESSORIES

Test alligator clips
Carry bag
Battery



Calibration
Certificate



Quick Start
Guide

MOTOR & PHASE ROTATION INDICATOR
MS5900

SKU NO.: MS5900CBGLO
UPC CODE: 810053672006
EAN CODE: 8435394777733

FEATURE

- Motor & phase rotation tester.
- Led light signals.
- Operating Altitude 2000m.
- Pollution Degree 2.

SPECIFICATIONS

AC Voltage()
120~400V

Frequency
2~400Hz

PACKAGING INFORMATION



Color Box
L168xW64xH238mm



Carton Box
49.5x37x35.5cm



X 20PCS



MAIN APPLICATIONS

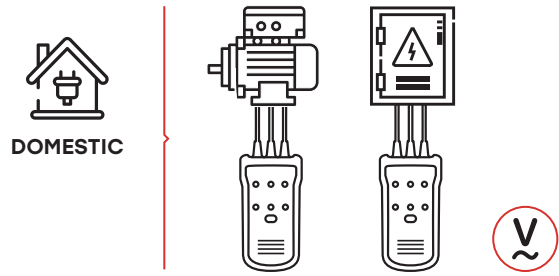

CONTENTS



130x72x32mm
5.1"x2.8"x1.3"
193g/0.43lb



1x9V 6F22
Battery



ACCESSORIES

Test alligator clips
Carry bag
Battery



Calibration
Certificate



Quick Start
Guide

MOTOR & PHASE ROTATION INDICATOR
MS5901

SKU NO.: MS5901CBGLO
UPC CODE: 810053672921
EAN CODE: 8435394778655

FEATURE

- Motor & phase rotation tester.
- Led light signals.
- Operating Altitude 2000m.
- Pollution Degree 2.

SPECIFICATIONS

AC Voltage 120~400V	Frequency 2~400Hz
-------------------------------	-----------------------------

PACKAGING INFORMATION



Color Box
L168xW64xH238mm



Carton Box
51x36x36cm



X 20PCS



MAIN APPLICATIONS

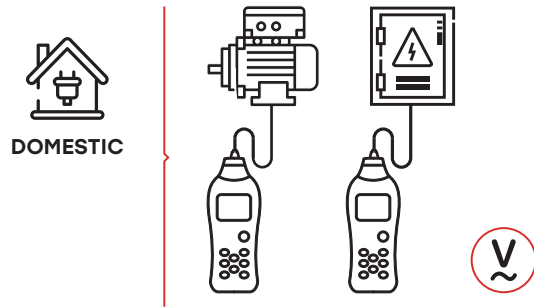

CONTENTS

- 194x78x37mm
7.64"x3.07"x1.46"
254g/0.56lb
- 6x1.5V AAA Batteries
- Power Cord
- Carry bag
- Battery
- Calibration Certificate
- Quick Start Guide

CIRCUIT ANALYZER

MS5908A

SKU NO.: MS5908ACBGLO
UPC CODE: 810053673119
EAN CODE: 8435394778846

FEATURE

- Auto Power Off.
- Data Hold.
- Low Battery Display.

SPECIFICATIONS

Line Voltage 85~135V	Peak Line Voltage 120~190V	Frequency 45~65Hz
Voltage Drop Load Current 12/15/20A	RCD Trip Time 1ms~6.5S	
RCD Trip Current 30mA~37mA	GFCI Trip Time 1ms~6.5S	GFCI Trip Current 6mA~9mA

PACKAGING INFORMATION

- Color Box**
L130xW63xH255mm
- Carton Box**
53x34x28.5mm
- X 20PCS**



MAIN APPLICATIONS

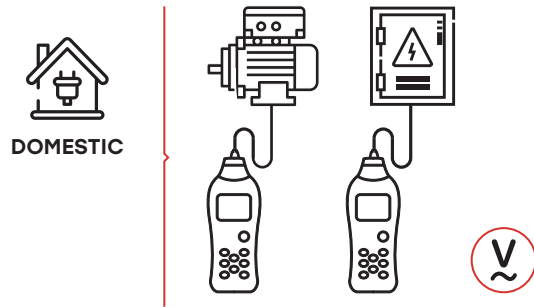

CONTENTS

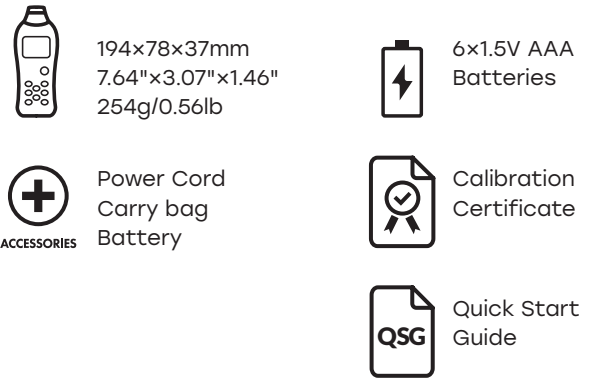

CIRCUIT ANALYZER
MS5908C

SKU NO.: MS5908CCBGLO
UPC CODE: 810053672808
EAN CODE: 8435394778440

FEATURE

- Auto Power Off.
- Data Hold.
- Low Battery Display.

SPECIFICATIONS

Line Voltage 85~265V	Peak Line Voltage 120~375V	Frequency 45~65Hz
Voltage Drop Load Current 5/8/10A	RCD Trip Time 1ms~6.5S	
RCD Trip Current 30mA~37mA	GFCI Trip Time 1ms~6.5S	GFCI Trip Current 6mA~9mA

PACKAGING INFORMATION

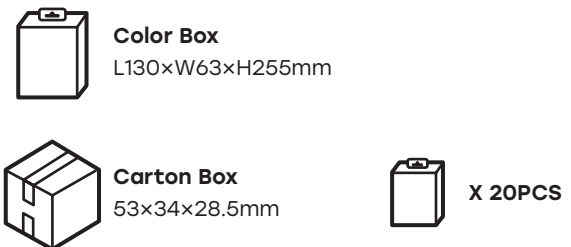

WIRE & CABLE TESTERS

NETWORK CABLE TESTER | CABLE TRACKER

MULTI-FUNCTIONS CABLE TRACKER | ADVANCED CABLE LOCATOR





MAIN APPLICATIONS

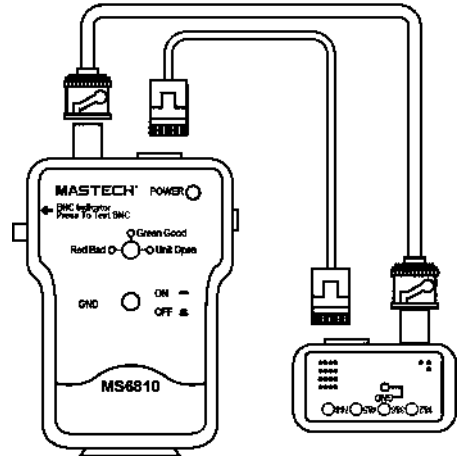

NETWORK CABLE TESTER
MS6810

SKU NO.: MS6810CBGLO
UPC CODE: 810053674345
EAN CODE: 8435394779416

FEATURE

- Widely Used For Coaxial Cable (BNC), UTP And STP Cable. It Can Automatically Check For Open Circuits, Shorts, Miswired, And Reversals.

SPECIFICATIONS

Distance
200m(max)

CONTENTS



153×74×31mm
6.0"×2.9"×1.2"
120g/0.26lb



1×9V 6F22
Battery



Carry bag
Battery

ACCESSORIES



Calibration
Certificate



Quick Start
Guide

PACKAGING INFORMATION



Color Box
L90×W40×H165mm



Carton Box
42.5×35×29cm



X 60PCS



NETWORK CABLE TESTER **MS6811**

SKU NO.: MS6811CBGLO
UPC CODE: 810053672624
EAN CODE: 8435394778266

FEATURE

- Tests for Open Circuits, Shorts, Miswires, Reversals, and Split Pairs.
- DEBUG Quickly Identifies Which Cable Pairs Have A Specific Wiring Fault.

SPECIFICATIONS

Distance
200m(max)

MAIN APPLICATIONS

Fault details

Fig.1 SPLIT PAIRS

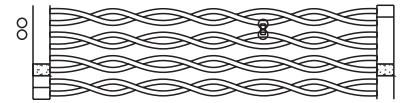

Fig.2 SHORT

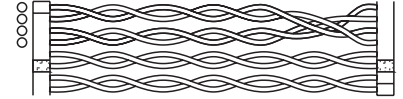

Fig.3 MISWIRE

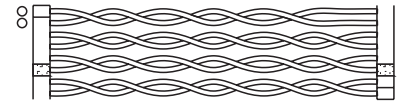
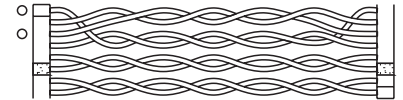

Fig.4 REVERSED



CONTENTS



125×55×30mm
4.9"×2.2"×1.2"
106g/0.23lb



1×6V 4LR44/
4AG13 Battery



Carry bag
Battery

ACCESSORIES



Calibration
Certificate



Quick Start
Guide

PACKAGING INFORMATION



Color Box
L90×W40×H165mm



Carton Box
42.5×35×29cm



X 60PCS



MAIN APPLICATIONS

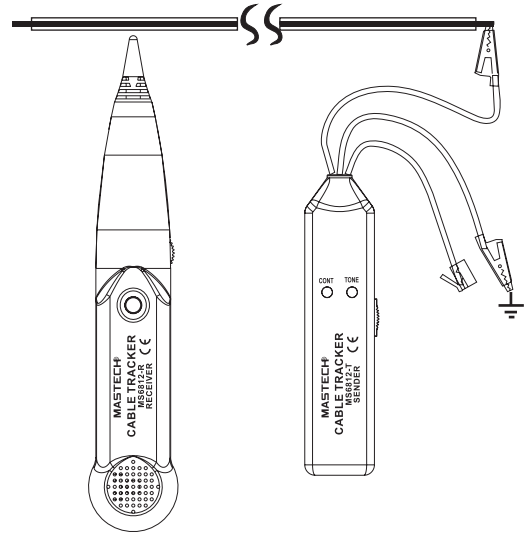

CABLE TRACKER
MS6812A

SKU NO.: MS6812ACBGLO
UPC CODE: 810053675274
EAN CODE: 8435394783291

FEATURE

- Sound and Light Instruction.
- Cont and Tone LED Light.

SPECIFICATIONS

Send Tone Frequency
1.5kHz

Receive Frequency
100Hz~300kHz

CONTENTS



Receiver:
238×43×26mm
9.4"×1.7"×1.0"
71g/0.16lb



Emitter:
145×35×25mm
5.7"×1.38"×0.98"
87g/0.2lb



ACCESSORIES

Carry bag
Battery



2x9V 6F22
Batteries



Calibration
Certificate



Quick Start
Guide

PACKAGING INFORMATION



Color Box
L125×W40×H255mm



Carton Box
53×22×27cm



X 20PCS



MULTI-FUNCTIONS CABLE TRACKER
MS6813

SKU NO.: MS6813CBGLO
UPC CODE: 810053672976
EAN CODE: 8435394778709

FEATURE

- Multifunction.
- Cable tester and tracker.
- State of the telephone lines.
- Small size ideal for transport.

SPECIFICATIONS

Receive Frequency
100Hz~300kHz

Send Tone Frequency
1.5kHz

MAIN APPLICATIONS

Fig.1 SHORT

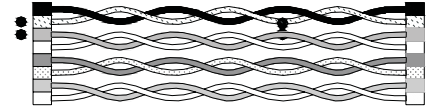

Fig.2 MISWIRE



Fig.3 REVERSED



Fig.4 SPLIT PAIRS



CONTENTS



206×84×55mm
8.1"×3.3"×2.1"
330g/0.72lb



2×9V 6F22
Batteries



ACCESSORIES

Carry bag
Battery



Calibration
Certificate



Quick Start
Guide

PACKAGING INFORMATION



Color Box
L172×W80×H255mm



Carton Box
46×27×37cm



X 10PCS



MAIN APPLICATIONS

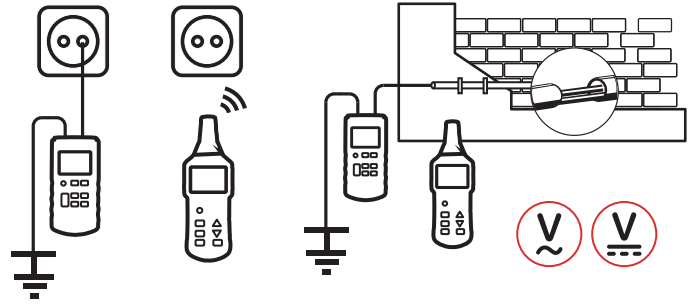

CONTENTS



Transmitter:
190×89×42.5mm
7.48"×3.5"×1.67"
420g/0.92lb



Receiver:
241.5×78×38.5mm
9.5"×3"×1.5"
350g/0.77lb



ACCESSORIES

Test leads
Test probe
Alligator clip
Grounding rod
Carry bag
Battery



1×9V 6F22 Battery/
6×1.5V AAA
Batteries



Calibration
Certificate



Quick Start
Guide

ADVANCED WIRE TRACKER
MS6818

SKU NO.: MS6818CBGLO
UPC CODE: 810053672204
EAN CODE: 8435394777924

FEATURE

- Track Cables In The Wall or Earth.
- One or Dual-pole Application.
- Adjustable Sensitivity In Transmitter and Receiver.

SPECIFICATIONS

AC Voltage
12~400V

DC Voltage
12~400V

Output Signal
125kHz

Display Counts
2000

PACKAGING INFORMATION



Color Box
L200xW85xH280mm



Carton Box
44.5x32.5x42cm



X 10PCS

LCR METERS

DIGITAL LCR METER | SMART SMD TESTER





MAIN APPLICATIONS

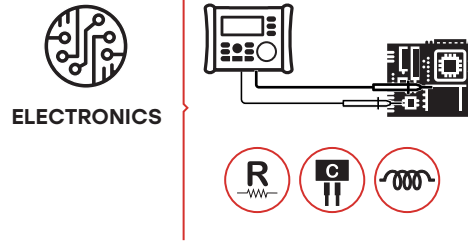

CONTENTS

- 224x172x58mm
8.8"x6.8"x2.3"
841g/1.85lb
- 8x1.5 AA Batteries
- Kelvin test clip
SMD test probe
IR data line
Software CD
Battery
- Calibration Certificate
- Quick Start Guide
- External power supply (option)

DIGITAL LCR METER WITH USB INTERFACE
MS5308

SKU NO.: MS5308CBGLO
UPC CODE: 810053673102
EAN CODE: 8435394778839

FEATURE

- Auto & Manual Ranging.
- Auto Power off.
- LCR smart check and measurement.
- DCR mode.

SPECIFICATIONS

Resistance 200Ω	Capacitance 2000μF	LCR 2000H
---------------------------	------------------------------	---------------------

PACKAGING INFORMATION

- Color Box**
L320xW125xH255mm
- Carton Box**
52x33.5x29cm
- X 4PCS**



MAIN APPLICATIONS



ELECTRONICS

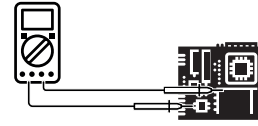

CONTENTS



189×91×31.5mm
7.4"×3.6"×1.2"
240g/0.52lb



1×9V 6F22
Battery



ACCESSORIES

Test Leads
Carry bag
Battery



Calibration
Certificate



Quick Start
Guide

DIGITAL LCR METER

MS6013

SKU NO.: MS6013CBGLO
UPC CODE: 810053674222
EAN CODE: 8435394779294

FEATURE

- Zero Adjustment approx. ± 20pF.
- Input Jacks.
- High Accuracy in Measuring.
- Low Battery Display.

SPECIFICATIONS

Capacitance
200pF~20mF

Display Counts
2000

PACKAGING INFORMATION



Color Box
L165×W70×H225mm



Carton Box
47×37.5×35.5cm



X 20PCS



MAIN APPLICATIONS



ELECTRONICS

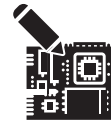

CONTENTS



175x32x20mm
6.89"x1.26"x0.79"
48g/0.10lb



1x3V CR2032
Battery



ACCESSORIES

Spare test pin
Battery



Calibration
Certificate



Quick Start
Guide

SMART SMD TESTER (R/C)
MS8910

SKU NO.: MS8910CBGLO
UPC CODE: 810053672747
EAN CODE: 8435394778389

FEATURE

- Auto Ranging.
- Auto Power Off.
- Data Hold.
- Low Battery Display.

SPECIFICATIONS

Resistance
30MΩ

Capacitance
30mF

Display Counts
3000

Continuity
30Ω

PACKAGING INFORMATION



Color Box
L57xW29xH203mm



Carton Box
44x32x31.5cm



X 100PCS



MAIN APPLICATIONS

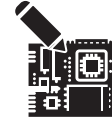

SMART SMD TESTER (R/C/L)
MS8911

SKU NO.: MS8911CBGLO
UPC CODE: 810053674512
EAN CODE: 8435394779584

FEATURE

- Auto Ranging.
- Auto Power Off.
- Data Hold.
- Low Battery Display.

SPECIFICATIONS

Resistance 20MΩ	Capacitance 6mF	Inductance 200H
Display Counts 6000		

CONTENTS



186×35×23.6mm
7.3"×1.38"×0.93"
90g/0.2lb



1×3V CR2450
Battery



ACCESSORIES

Spare test pin
Battery



Calibration
Certificate



Quick Start
Guide

PACKAGING INFORMATION



Color Box
L57×W29×H203mm



Carton Box
44×32×31.5cm



X 100PCS



MAIN APPLICATIONS

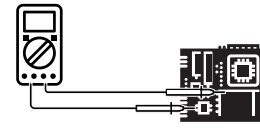

CONTENTS



189×91×31.5mm
7.4"×3.6"×1.2"
240g/0.52lb



1×9V 6F22
Battery



ACCESSORIES

Test Leads



Calibration
Certificate



Quick Start
Guide

DIGITAL LCR METER

MY6243

SKU NO.: MY6243CBGLO
UPC CODE: 810053672754
EAN CODE: 8435394778396

FEATURE

- Input Jacks.
- High Accuracy in Measuring.
- Low Battery Display.

SPECIFICATIONS

Capacitance
200µF

Inductance
2H

Display Counts
2000

PACKAGING INFORMATION



Color Box
L165×W70×H225mm



Carton Box
47×37.5×35.5cm



X 20PCS

EARTH RESISTANCE

EARTH RESISTANCE CLAMP METER | EARTH RESISTANCE TESTER
ADVANCED EARTH RESISTANCE TESTER





MAIN APPLICATIONS

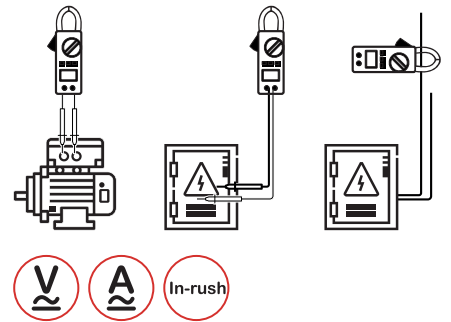
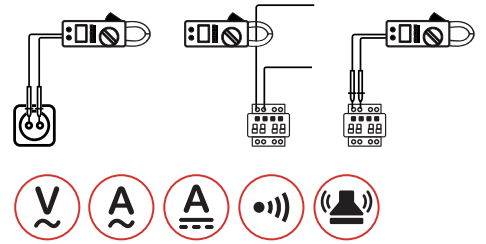

EARTH RESISTANCE CLAMP METER
MS2115A

SKU NO.: MS2115ACBGLO
UPC CODE: 810053672051
EAN CODE: 8435394777788

FEATURE

- Auto Power Off.
- Low Battery Display.
- MAX/MIN.

SPECIFICATIONS

AC Voltage 750V	DC Voltage 1000V	AC Current 1000A
DC Current 1000A	Resistance 60MΩ	Capacitance 100mF
Frequency 1000Hz	Display Counts 6000	Continuity <50Ω

CONTENTS



238×92×50mm
9.3"×3.62"×1.96"
420g/0.7lb



1×9V 6F22
Battery



Test Leads
Carry bag
Battery



Calibration
Certificate



Quick Start
Guide

PACKAGING INFORMATION



Color Box
L130×W63×H255mm



Carton Box
53×34×28.5mm



X 20PCS



MAIN APPLICATIONS



DOMESTIC

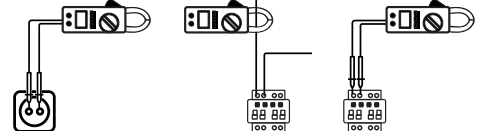

INDUSTRIAL

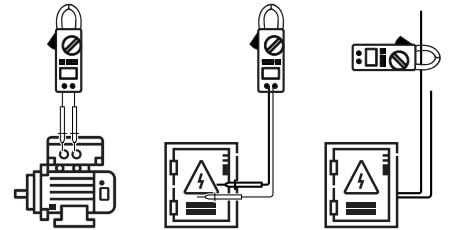

EARTH RESISTANCE CLAMP METER
MS2301

SKU NO.: MS2301CBGLO
UPC CODE: 810053674208
EAN CODE: 8435394779270

FEATURE

- Auto & Manual Ranging.
- Logging and Recall 99 Groups.
- Setting Alarm Threshold in 1~100Ω.

SPECIFICATIONS

Resistance 1200Ω	AC Current 20A	Display Counts 9999
Jaw Opening 45mmx32mm/1.8"x1.3"		Data Logging 99 groups

CONTENTS



276×104×54mm
10.8"×4.33"×2.1"
1050g/2.31lb



1×9V Alkaline Battery



ACCESSORIES

Calibration loop of resistance (1Ω/5Ω/10Ω)
Carry case
Battery



Calibration Certificate



Quick Start Guide

PACKAGING INFORMATION



Color Box
L370×W140×H324mm



Carton Box
58×39×35cm





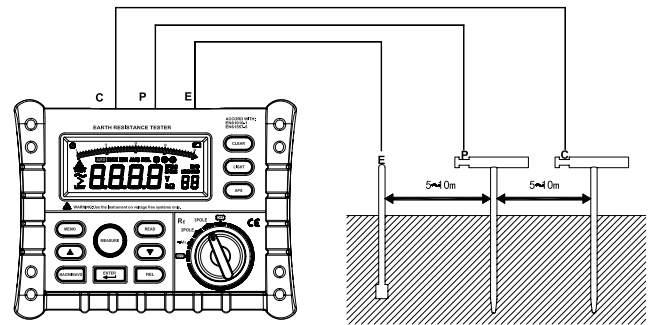
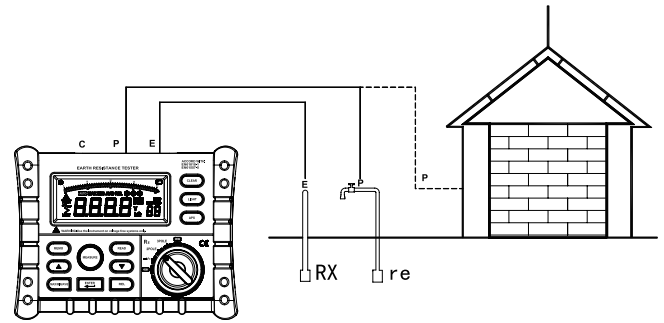

X 4PCS



MAIN APPLICATIONS



CONTENTS

-  330x265x125mm
13"x10.4"x4.9"
900g/1.98lb
-  6x1.5V AA Batteries
-  Test leads (Red-15m/
Green-10m/Black-5m)
Wrapping bag
Auxiliary earth bar
Battery
-  Calibration Certificate
-  Quick Start Guide

PACKAGING INFORMATION

-  **Color Box**
L325xW125xH255mm
-  **Carton Box**
52x33.5x29cm
-  **X 4PCS**



EARTH RESISTANCE TESTER
MS2302

SKU NO.: MS2302CBGLO
UPC CODE: 810053672150
EAN CODE: 8435394777870

FEATURE

- Auto & Manual Ranging.
- Auto Power Off.
- Segments Bar Graph.
- MAX/MIN/AVG.

SPECIFICATIONS

Earth Voltage AC 0~200V	Earth Resistance 0.01~4000Ω
-----------------------------------	---------------------------------------



ADVANCED EARTH RESISTANCE TESTER
MS2306

SKU NO.: MS2306CTGLO
 UPC CODE: 810053675069
 EAN CODE: 8435394783079

FEATURE

- Auto Power Off.
- Alarming indicator for limit-value measurement.
- AVG.
- Compensation Resistance.

SPECIFICATIONS

3 Pole & 4 Pole Earthing-Resistance Test 0.1Ω~20kΩ	
2 Pole R (AC) 0.1Ω~20kΩ	Soil Resistivity ρ 0.02~1000

MAIN APPLICATIONS

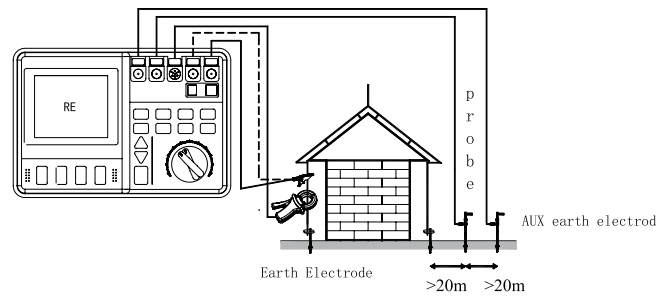
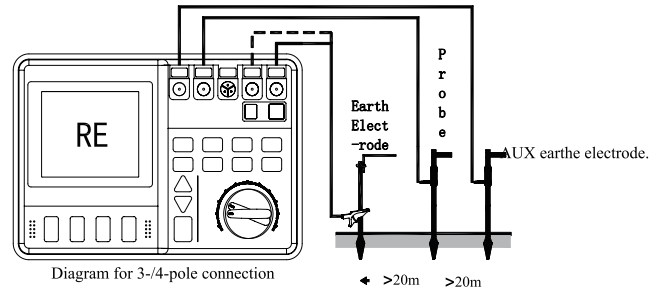

CONTENTS

- | | |
|--|--|
| 284×230×125mm
11.2"×9.1"×4.9"
2.5kg/5.5lb | 6×1.5V AA Batteries/
Ni~MH Recharge Battery, 7.2V |
| ACCESSORIES
Test wire
Alligator clip
Auxiliary earth bar
Power cord
Carry bag
Battery | Calibration Certificate |
| Rechargeable Ni-MH battery (optional)
Charger (optional) | Quick Start Guide |

PACKAGING INFORMATION

- | | |
|-------------------------------------|---------------|
| Carton Box
40×17.5×31.5cm | X 1PCS |
|-------------------------------------|---------------|



ADVANCED EARTH RESISTANCE TESTER
MS2308

SKU NO.: MS2308CTGLO
UPC CODE: 810053676790
EAN CODE: 8435394785318

FEATURE

- Auto Power Off.
- Alarming indicator for limit-value measurement.
- AVG.
- Compensation Resistance.

SPECIFICATIONS

3 Pole & 4 Pole Earthing-Resistance Test 0.02Ω~300kΩ		
2 Pole R (AC) 0.02Ω~300kΩ	2 Pole R (DC) 0.02Ω~3kΩ	Soil Resistivity ρ 0.02~1000

MAIN APPLICATIONS

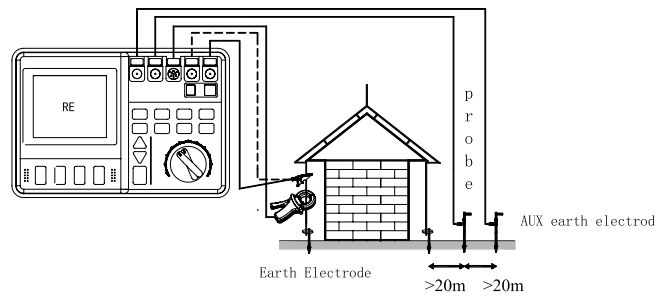
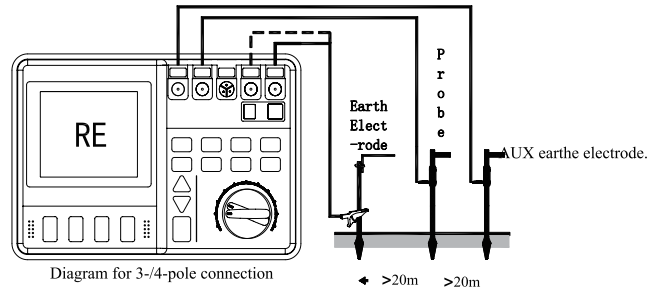

CONTENTS



284×230×125mm
11.2"×9.1"×4.9"
2.5kg/5.5lb



6×1.5V AA Batteries/
Ni~MH Recharge Battery, 7.2V



ACCESSORIES

- Test wire
- Alligator clip
- Auxiliary earth bar
- Power cord
- Current transformer φ51mm
- Current clamp cable
- Carry bag
- Software CD
- USB interface cable
- Battery



Calibration Certificate



Quick Start Guide

- Rechargeable Ni-MH battery (optional)
- Charger (optional)

PACKAGING INFORMATION



Carton Box
40×17.5×31.5cm



X 1PCS

INSULATION TESTERS

DIGITAL INSULATION TESTER | HIGH VOLTAGE DIGITAL INSULATION TESTER | ADVANCED HIGH VOLTAGE INSULATION TESTER





MAIN APPLICATIONS

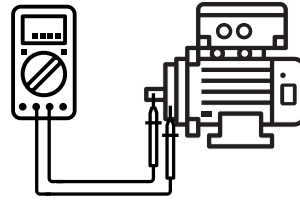

CONTENTS



192×122×55mm
7.48"×4.7"×2.2"
545g/1.3lb



6×1.5V AA
Batteries



ACCESSORIES

Test Leads
Test Clips
Screwdriver
Soft Case
Carrying Case
Battery



Calibration
Certificate



Quick Start
Guide

DIGITAL INSULATION TESTER
MS5201

SKU NO.: MS5201CBGLO
UPC CODE: 810053672884
EAN CODE: 8435394778617

FEATURE

- Data Hold.
- Low Battery Display.
- Constant Measuring Lock.

SPECIFICATIONS

AC Voltage 700V	DC Voltage 1000V	Resistance 2000MΩ
Display Counts 2000	Continuity <50Ω	

PACKAGING INFORMATION



Color Box
L370×W140×H324mm



Carton Box
58×39×35cm



X 4PCS



MAIN APPLICATIONS

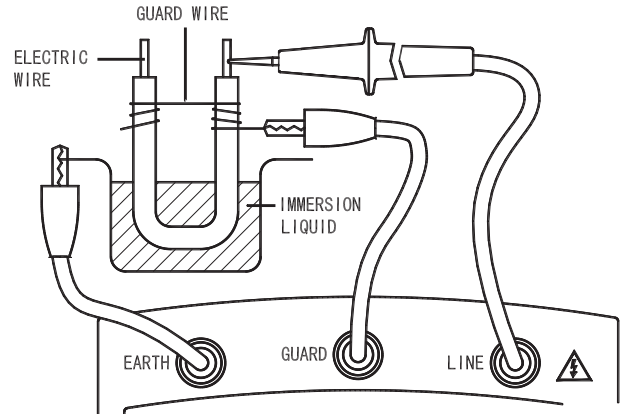

CONTENTS



225×138×81mm
8.86"×5.3"×3.19"
1200g/2.75lb



8×1.5V AA Batteries/
1×9V 6F22 Battery



ACCESSORIES

Test Clips
Carry bag
Battery



Calibration
Certificate



Quick Start
Guide

HIGH VOLTAGE INSULATION TESTER
MS5202

SKU NO.: MS5202CBGLO
UPC CODE: 810053673072
EAN CODE: 8435394778808

FEATURE

- Inner Battery Testing.
- Low Battery Display.
- Constant Measuring Lock.

SPECIFICATIONS

DC Output
2500V

Resistance
0~100GΩ

PACKAGING INFORMATION



Color Box
L370×W140×H324mm



Carton Box
58×39×35cm



X 4PCS



MAIN APPLICATIONS

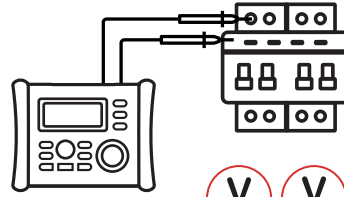

CONTENTS



200x155x76mm
7.6"x5.9"x2.95"
900g/1.98lb



6x1.5V AA
Batteries



ACCESSORIES

Test Leads
Alligator clip
Wrapping bag
Battery



Calibration
Certificate



Quick Start
Guide

DIGITAL INSULATION TESTER
MS5203

SKU NO.: MS5203CBGLO
UPC CODE: 810053672587
EAN CODE: 8435394784328

FEATURE

- Auto Power Off.
- MIN/MAX/AVG.
- Compare Function.
- Timer.

SPECIFICATIONS

AC Voltage
750V

DC Voltage
1000V

DC Output
1000V

Resistance
200Ω

PACKAGING INFORMATION



Color Box
L325xW125xH255mm



Carton Box
52x33.5x29cm



X 4PCS



MAIN APPLICATIONS

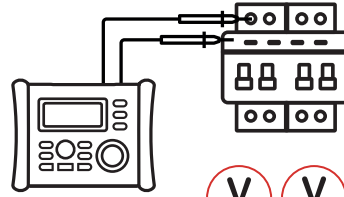

CONTENTS



180x140x65mm
7.1"x5.5"x2.56"
900g/1.98lb



8x1.5V AA
Batteries



ACCESSORIES

Test Leads
Alligator clip
Wrapping bag
Battery



Calibration
Certificate



Quick Start
Guide

DIGITAL INSULATION TESTER
MS5205

SKU NO.: MS5205CBGLO
UPC CODE: 810053672907
EAN CODE: 8435394778952

FEATURE

- Auto Power Off.
- Lock.
- MIN/MAX/AVG.
- Compare Function.

SPECIFICATIONS

AC Voltage
750V

DC Voltage
1000V

DC Output
2500V

Resistance
200Ω

PACKAGING INFORMATION



Color Box
L325xW125xH255mm



Carton Box
52x33.5x29cm



X 4PCS



MAIN APPLICATIONS

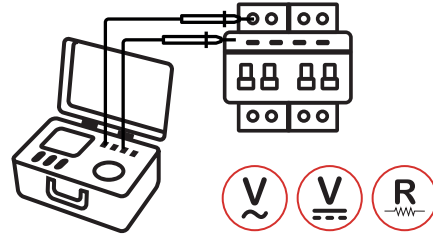

**ADVANCED HIGH VOLTAGE
INSULATION TESTER
MS5215**

SKU NO.: MS5215CBGLO
UPC CODE: 810053672914
EAN CODE: 8435394778648

FEATURE

- Broad Range Of Testing Voltage.
- Insulation Diagnosis.
- Large Storage Memory.
- Clear Display.

SPECIFICATIONS

AC Voltage 50~750V	DC Voltage 50~1000V	Resistance 0.01MΩ~5TΩ
Temperature -10°C~70°C		

CONTENTS

- 284×230×125mm
11.2"×9.1"×4.9"
2426g/5.34lb
- 6×LR14 Batteries/
6×1.2V AA Batteries
- Charger:
Input Voltage
100V~240V
- Tester probes leads 3m (Red/Black/Blue)
Crocodile clips (Red/Black/Blue)
Temperature Sensor
USB data line (1m)
Data analysis software CD
Instrument backpack
Battery
- Rechargeable battery pack(for charging Ni-Hy battery)(optional)
AC charger (optional)
- Calibration Certificate
- Quick Start Guide

PACKAGING INFORMATION

- Color Box**
L400×W175×H315mm
- Carton Box**
42×37×34cm
- X 2PCS**

PAT TESTER

SAFETY PAT PLUS TESTER



CLASS I CLASS II DATA RECALL CORD / EXT

A

B

C



MAIN APPLICATIONS

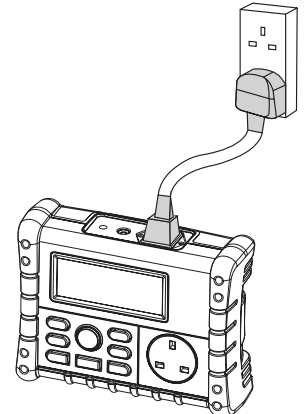
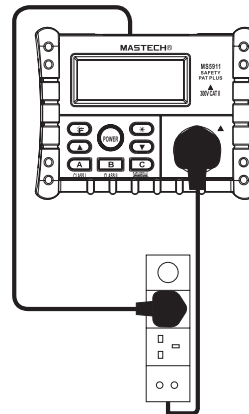
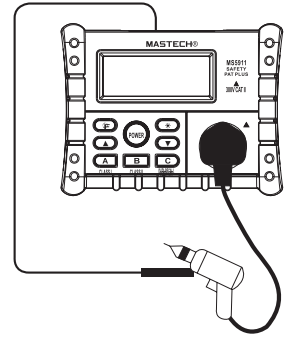
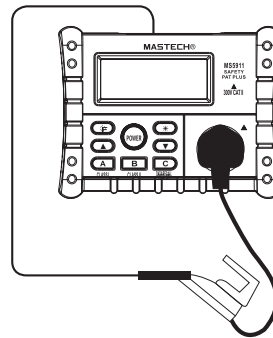

SAFETY PAT PLUS TESTER
MS5911

SKU NO.: MS5911CBGLO
UPC CODE: 810053675137
EAN CODE: 8435394783123

FEATURE

- Safety CLASS I - Grounding/Insulation Resistance/Leakage Current
- Safety CLASS II - Insulation Resistance/Leakage Current

SPECIFICATIONS

DC Output 250/500V	Resistance 20MΩ
------------------------------	---------------------------

CONTENTS



204x155x76mm
7.8"x6.1"x3"
1270g/2.8lb



DV12V /
8x1.5V AA
Batteries



ACCESSORIES

- Main test cord
- Alligator clip test cord
- Probe
- Rugged padded carrying case
- Battery



Calibration Certificate



Quick Start Guide

DC power adapter (optional)

PACKAGING INFORMATION



Color Box
L325xW125xH255mm



Carton Box
52x33.5x29cm



X 4PCS

THERMOMETERS

DIGITAL THERMOMETER | DIGITAL THERMO-HYGROMETER
NON-CONTACT INFRARED THERMOMETER





MAIN APPLICATIONS

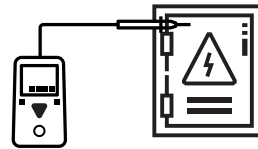
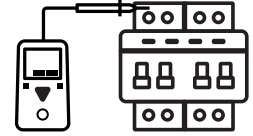
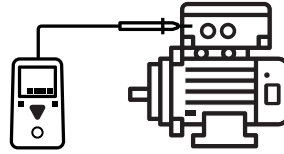

DIGITAL THERMOMETER
MS6500

SKU NO.: MS6500CBGLO
UPC CODE: 810053673089
EAN CODE: 8435394778815

FEATURE

- Sample Rate 500mS.
- Display 2000 counts.
- Data Hold.
- K-Type Thermocouple.

SPECIFICATIONS

Celcius -50°C~750°C	Fahrenheit -58°F~1382°F	Display Counts 2000
-------------------------------	-----------------------------------	-------------------------------

CONTENTS



125.5x72x27mm
5.6"x2.8"x1.0"
145g/0.30lb



1x9V 6F22
Battery



ACCESSORIES

K type thermocouple
Carry bag
Battery



Calibration
Certificate



Quick Start
Guide

PACKAGING INFORMATION



Color Box
L105xW40xH145mm



Carton Box
42x31.5x34cm



X 60PCS



MAIN APPLICATIONS

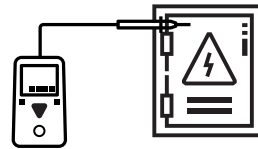
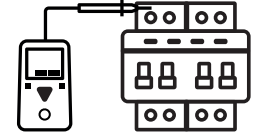
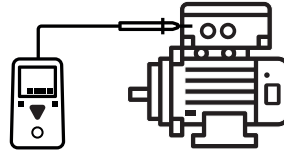

DIGITAL THERMO-HYGROMETER
MS6505

SKU NO.: MS6505CBGLO
UPC CODE: 810053675229
EAN CODE: 8435394783222

FEATURE

- Auto Power Off.
- MAX/MIN.
- Clock.
- Data logging 16300 groups.

SPECIFICATIONS

Temperature
-20°C~60°C/-4°F~140°F

Display Counts
2000

CONTENTS



183×74×42mm
7.3"×2.9"×1.6"
330g/0.7lb



1×9V 6F22
Battery



ACCESSORIES

RS232 date line
Software CD
Carry bag
AC adapter
Battery



Calibration
Certificate



Quick Start
Guide

PACKAGING INFORMATION



Color Box
L172×W80×H255mm



Carton Box
53×44.5×37cm



X 20PCS



MAIN APPLICATIONS

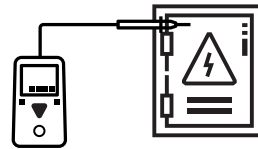
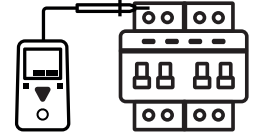
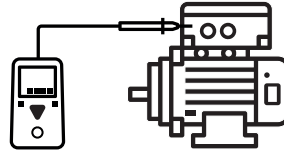

DIGITAL THERMOMETER
MS6511

SKU NO.: MS6511CBGLO
UPC CODE: 810053675243
EAN CODE: 8435394783246

FEATURE

- Auto Power Off.
- Data Hold.
- MAX/MIN/AVG.
- Low Battery Display.

SPECIFICATIONS

Type K, J, T, E	Channel TC
---------------------------	----------------------

CONTENTS



190×89×42mm
7.5"×3.5"×1.7"
350g/0.8lb



1×9V 6F22
Battery



ACCESSORIES

K type thermocouple
Battery



Calibration
Certificate



Quick Start
Guide

PACKAGING INFORMATION



Color Box
L165×W70×H225mm



Carton Box
47×37.5×35.5cm



X 20PCS



MAIN APPLICATIONS

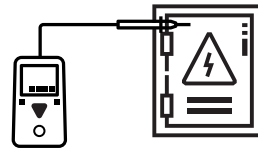
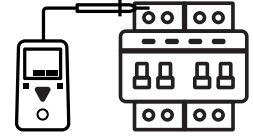
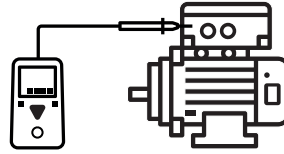

DIGITAL THERMOMETER
MS6512

SKU NO.: MS6512CBGLO
UPC CODE: 810053672945
EAN CODE: 8435394778679

FEATURE

- Auto Power Off.
- Data Hold.
- MAX/MIN/AVG.
- Low Battery Display.

SPECIFICATIONS

Type K, J, T, E	Channel T1/T2/T1-T2
---------------------------	-------------------------------

CONTENTS



190×89×42mm
7.5"×3.5"×1.7"
350g/0.8lb



1×9V 6F22
Battery



ACCESSORIES

K type thermocouple
Battery



Calibration
Certificate



Quick Start
Guide

PACKAGING INFORMATION



Color Box
L165×W70×H225mm



Carton Box
47×37.5×35.5cm



X 20PCS



MAIN APPLICATIONS

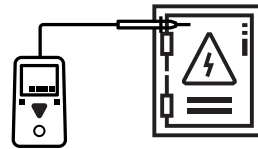
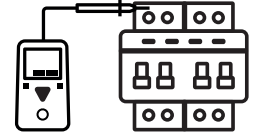
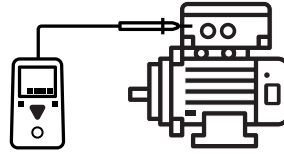

DIGITAL THERMOMETER
MS6513

SKU NO.: MS6513CBGLO
UPC CODE: 810053672044
EAN CODE: 8435394783253

FEATURE

- Auto Power Off.
- Data Hold.
- Memory Save Data.
- USB Interface.

SPECIFICATIONS

Type
K, J, T, E, R, S, N

Channel
TC

CONTENTS



190×89×42mm
7.5"×3.5"×1.7"
350g/0.8lb



1×9V 6F22
Battery



ACCESSORIES

K type thermocouple
USB interface cable
Software CD
Battery



Calibration
Certificate



Quick Start
Guide

PACKAGING INFORMATION



Color Box
L165×W70×H225mm



Carton Box
47×37.5×35.5cm



X 20PCS



MAIN APPLICATIONS

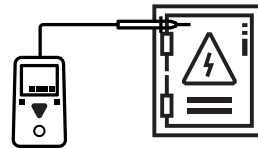
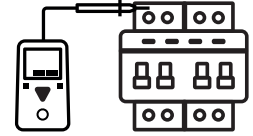
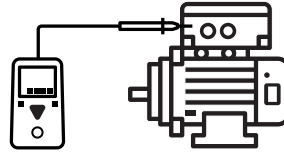

DIGITAL THERMOMETER
MS6514

SKU NO.: MS6514CBGLO
UPC CODE: 810053672037
EAN CODE: 843539477764

FEATURE

- Auto Power Off.
- Data Hold.
- Memory Save Data.
- USB Interface.

SPECIFICATIONS

Type
K, J, T, E, R, S, N

Channel
T1/T2/T1-T2

CONTENTS



190×89×42mm
7.5"×3.5"×1.7"
350g/0.8lb



1×9V 6F22
Battery



ACCESSORIES

K type thermocouple
USB interface cable
Software CD
Battery



Calibration
Certificate



Quick Start
Guide

PACKAGING INFORMATION



Color Box
L165×W70×H225mm



Carton Box
47×37.5×35.5cm



X 20PCS



MAIN APPLICATIONS

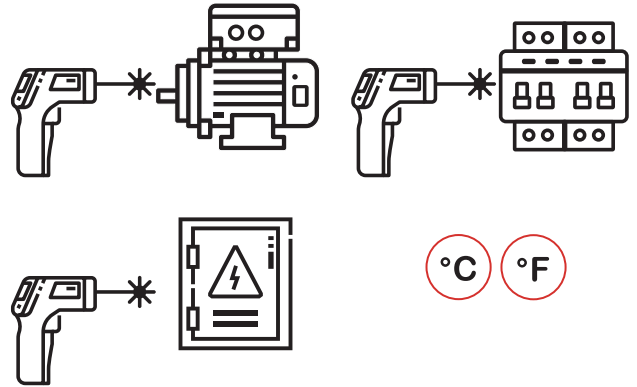

INFRARED THERMOMETER
MS6522A

SKU NO.: MS6522ACBGLO
UPC CODE: 810053674567
EAN CODE: 8435394779638

FEATURE

- Spectral Response 8-14 μm .
- Laser <math><1\text{mW}</math>/630-670nm.
- Response Time 1 Second.
- Relative Humidity 10%~90%

SPECIFICATIONS

Repeatability
 $\pm 0.1^{\circ}\text{C}$

Temperature
 $-20^{\circ}\text{C}\sim 300^{\circ}\text{C}/-4^{\circ}\text{F}\sim 572^{\circ}\text{F}$

Emissivity
0.95

CONTENTS



143x99x47mm
5.6"x3.9"x1.85"
135g/0.3lb



2x1.5V AAA
Batteries



ACCESSORIES

Battery



Calibration
Certificate



Quick Start
Guide

PACKAGING INFORMATION



Color Box
L125xW55xH183mm



Carton Box
57.5x39.1x27.5cm



X 40PCS



MAIN APPLICATIONS

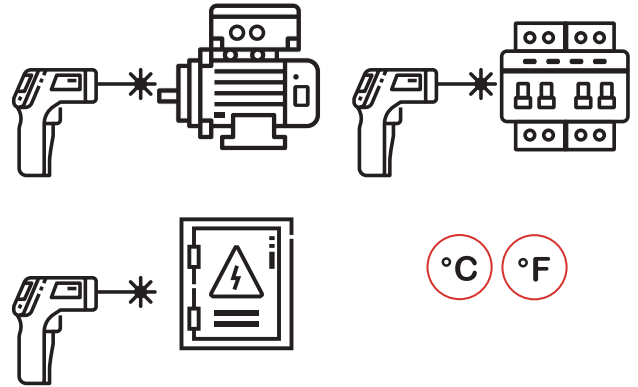

INFRARED THERMOMETER
MS6522B

SKU NO.: MS6522BCBGLO
UPC CODE: 810053672617
EAN CODE: 8435394778914

FEATURE

- Spectral Response 8-14 μm.
- Laser <1mW/630-670nm.
- Response Time 1 second.
- Relative Humidity 10%~90%

SPECIFICATIONS

Repeatability ±0.1°C	Temperature -20°C~500°C/-4°F~932°F
Emissivity 0.95	

CONTENTS

- 143x99x47mm
5.6"x3.9"x1.85"
135g/0.3lb
- 2x1.5V AAA Batteries
- Battery
- Calibration Certificate
- ACCESSORIES
- Quick Start Guide

PACKAGING INFORMATION

- Color Box**
L125xW55xH183mm
- Carton Box**
57.5x39.1x27.5cm
- X 40PCS**



MAIN APPLICATIONS

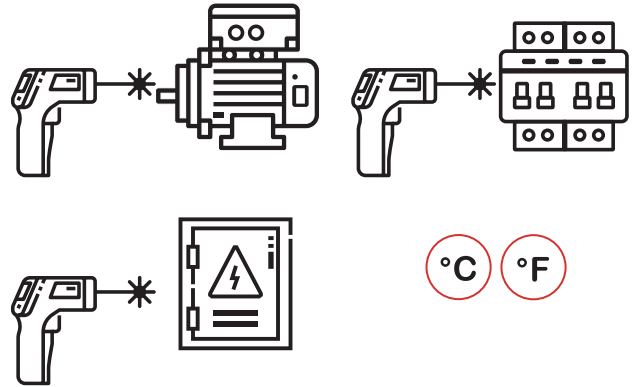

INFRARED THERMOMETER COLOR LCD
MS6531B

SKU NO.: MS6531BCBGLO
UPC CODE: 810053672969
EAN CODE: 8435394778693

FEATURE

- Color Display.
- Auto Power Off.
- Spectral Response 8-14 μ m.
- Laser <1mW/630-670nm.

SPECIFICATIONS

IRT Temperature
-40°C~800°C/-40°F~1472°F

Repeatability
±0.1°C

Emissivity
0.10~1.00

CONTENTS



176×132×49mm
6.9"×5.2"×1.9"
223g/0.5lb



1×9V 6F22
Battery



ACCESSORIES

Carry bag
Battery



Calibration
Certificate



Quick Start
Guide

PACKAGING INFORMATION



Color Box
L126×W58×H210mm



Carton Box
44.5×34×28cm



X 20PCS



MAIN APPLICATIONS

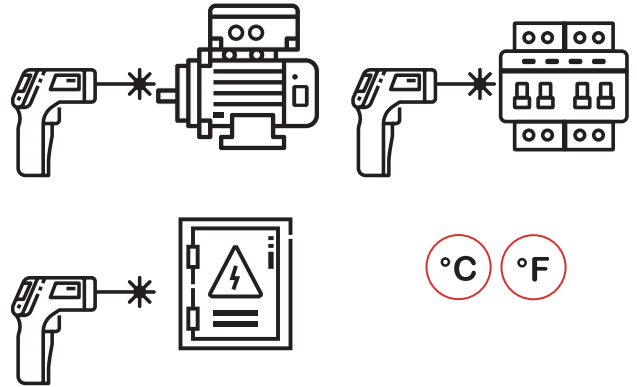

INFRARED THERMOMETER COLOR LCD
MS6531C

SKU NO.: MS6531CCBGLO
UPC CODE: 810053674284
EAN CODE: 8435394779355

FEATURE

- Color Display.
- Auto Power Off.
- Spectral Response 8-14 μ m.
- Laser <1mW/630-670nm.

SPECIFICATIONS

IRT Temperature -40°C~800°C/-40°F~1472°F	Repeatability ±0.1°C
K-Type Temperature -40°C~1080°C/-40°F~1976°F	Emissivity 0.10~1.00

CONTENTS

- 176x132x49mm
6.9"x5.2"x1.9"
223g/0.5lb
- 1x9V 6F22 Battery
- K type thermocouple
Carry bag
Battery
- Calibration Certificate
- Quick Start Guide

PACKAGING INFORMATION

- Color Box**
L126xW58xH210mm
- Carton Box**
44.5x34x28cm
- X 20PCS**



MAIN APPLICATIONS

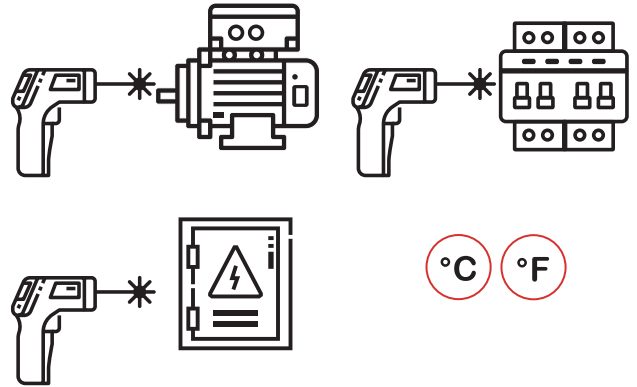

INFRARED THERMOMETER
MS6541

SKU NO.: MS6541CBGLO
UPC CODE: 810053674291
EAN CODE: 8435394779362

FEATURE

- Color Display.
- Auto Power Off.
- Spectral Response 8-14 μm.
- Laser <1mW/630-670nm.

SPECIFICATIONS

IRT Temperature -50°C~760°C/-58°F~1400°F	Repeatability ±0.1°C
K-Type Temperature -50°C~300°C/-58°F~572°F	Emissivity 0.10~1.00

CONTENTS

- 192x95x83mm
7.5"x3.7"x3.3"
275g/0.6lb
- 1x9V 6F22 Battery
- K type thermocouple
Carry bag
Battery
- Calibration Certificate
- Quick Start Guide

PACKAGING INFORMATION

- Color Box**
L126xW58xH210mm
- Carton Box**
44.5x34x28cm
- X 20PCS**

ENVIRONMENTAL METERS

SOUND LEVEL METER | ANEMOMETER | LIGHT METER
MOISTURE TESTER | TACHOMETERS | GAS DETECTOR
MULTI-FUNCTIONS ENVIRONMENT TESTER | DISTANCE METERS
ELECTRONIC STUD METAL FINDER | VOLTAGE AND CURRENT
CALIBRATOR





MAIN APPLICATIONS

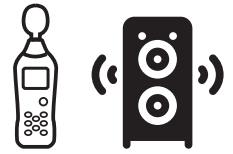
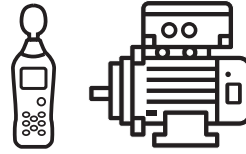

DIGITAL SOUND LEVEL METER
MS6700

SKU NO.: MS6700CBGLO
UPC CODE: 810053676691
EAN CODE: 8435394784779

FEATURE

- Auto & Manual Ranging.
- Auto Power Off.
- Dynamic 50dB.
- Frequency 31.5Hz~8kHz.

SPECIFICATIONS

Sound Level 30dB~130dB	Frequency 31.5Hz~8KHz	Dynamic 50dB
Display Counts 2000		

CONTENTS



265x80x69mm
10.4"x3.15"x2.7"
317g/0.7lb



6x1.5V AAA
Batteries



ACCESSORIES

Windscreen
Earphone plug
Wapping case
Battery



Calibration
Certificate



Quick Start
Guide

PACKAGING INFORMATION



Color Box
L160xW74xH295mm



Carton Box
38.5x32x34cm



X 10PCS



MAIN APPLICATIONS

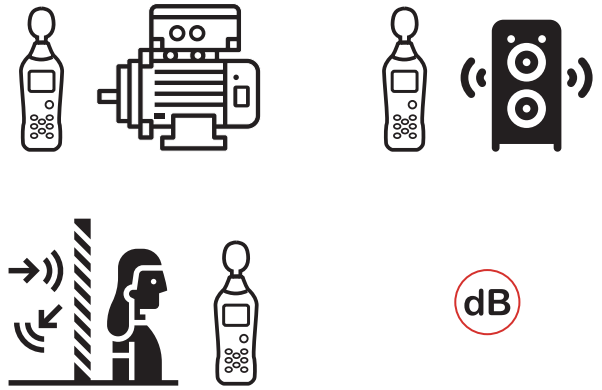

dB

DIGITAL SOUND LEVEL METER
MS6701

SKU NO.: MS6701CBGLO
UPC CODE: 810053674321
EAN CODE: 8435394779393

FEATURE

- Auto & Manual Ranging.
- Auto Power Off.
- Dynamic 50dB.
- Frequency 31.5Hz~8kHz.

SPECIFICATIONS

Sound Level 30dB~130dB	Frequency 31.5Hz~8KHz	Dynamic 50dB
Data Recording 16000	Display Counts 2000	

CONTENTS

	265x80x69mm 10.4"x3.15"x2.7" 317g/0.7lb		6x1.5V AAA Batteries
	Windscreen Earphone plug Wapping case USB Interface cable Software CD Battery		Calibration Certificate
			Quick Start Guide

PACKAGING INFORMATION

	Color Box L160xW74xH295mm	
	Carton Box 38.5x32x34cm	X 10PCS



MAIN APPLICATIONS

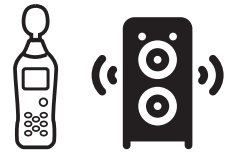
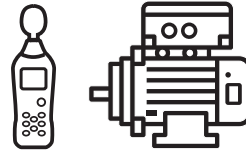

DIGITAL SOUND LEVEL METER
MS6708

SKU NO.: MS6708CBGLO
UPC CODE: 810053674338
EAN CODE: 8435394779409

FEATURE

- Auto & Manual Ranging.
- Auto Power Off.
- Dynamic 50dB.
- Loudness Measurement..

SPECIFICATIONS

Sound Level 30dB~130dB	Frequency 10Hz~8kHz	Dynamic 50dB
Display Counts 2000		

CONTENTS



193×60×29mm
7.6"×2.4"×1.1"
222g/0.48lb



4×1.5V AAA
Batteries



ACCESSORIES

Windscreen
Carry bag
Battery



Calibration
Certificate



Quick Start
Guide

PACKAGING INFORMATION



Color Box
L95×W45×H230mm



Carton Box
49.5×27×41cm



X 40PCS



MAIN APPLICATIONS

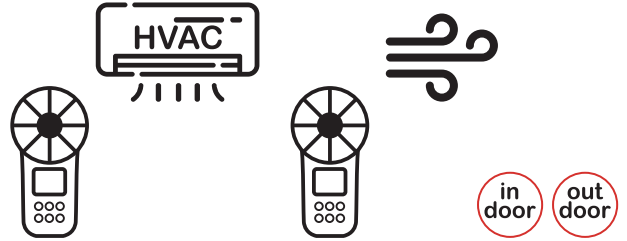

CONTENTS

- 165x85x38mm
6.5"x3.3"x1.5"
168g/0.37lb
- 1x9V 6F22 Battery
- Carry bag
- Battery
- Calibration Certificate
- Detector bracket (optional)
- Quick Start Guide

DIGITAL ANEMOMETER

MS6252A

SKU NO.: MS6252ACBGLO
UPC CODE: 810053672181
EAN CODE: 8435394777900

FEATURE

- Display 9999 Counts With Backlight.
- Flow Area Setting.
- MAX/MIN.
- Data Hold.

SPECIFICATIONS

m/s 0.80~40.00m/s	km/h 2.88~144.0km/h	ft/s 2.62~131.2ft/s
Knots 1.6~77.70knots	mile/h 1.8~90.00mil/h	ft/m 157.5~7874ft/m
Display Counts 9999		

PACKAGING INFORMATION

- Color Box**
L110xW60xH190mm
- Carton Box**
40x33.5x24cm
- X 20PCS**



DIGITAL ANEMOMETER
MS6252B

SKU NO.: MS6252BCBGLO
UPC CODE: 810053673096
EAN CODE: 8435394778822

FEATURE

- USB Interface.
- Display 9999 Counts With Backlight.
- Temperature Mode.
- MAX/MIN/Data Hold.

SPECIFICATIONS

m/s 0.80~40.00m/s	km/h 2.88~144.0km/h	ft/s 2.62~131.2ft/s
Knots 1.6~77.7knots	mile/h 1.8~90.00mil/h	ft/m 157.5~7874ft/m
Temperature -10°C~60°C/14°F~140°F		Display Counts 9999

MAIN APPLICATIONS

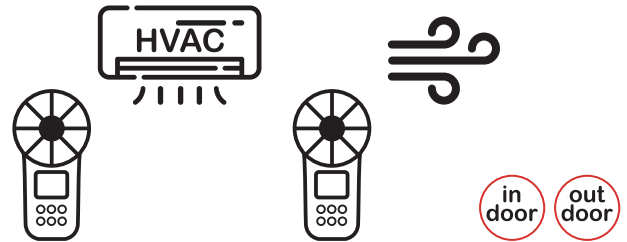

CONTENTS

	165×85×38mm 6.5"×3.3"×1.5" 168g/0.37lb		1×9V 6F22 Battery
	Carry bag Battery USB interface cable Software CD		Calibration Certificate
	Detector bracket (optional)		Quick Start Guide

PACKAGING INFORMATION





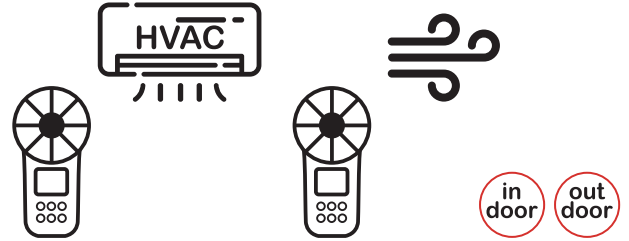

	Color Box L110×W60×H190mm	
	Carton Box 40×33.5×24cm	X 20PCS



MAIN APPLICATIONS



CONTENTS

-  165x85x38mm
6.5"x3.3"x1.5"
168g/0.37lb
-  1x9V 6F22 Battery
-  Carry bag
Battery
-  Calibration Certificate
-  ACCESSORIES
Detector bracket (optional)
-  QSG
Quick Start Guide

DIGITAL ANEMOMETER

MS6252D

SKU NO.: MS6252DCBGLO
UPC CODE: 810053676813
EAN CODE: 8435394785349



FEATURE

- Wireless Interface.
- Display 9999 Counts With Backlight.
- Temperature Mode.
- MAX/MIN/Data Hold.

SPECIFICATIONS

m/s 0.80~40.00m/s	km/h 2.88~144.0km/h	ft/s 2.62~131.2ft/s
Knots 1.6~77.7knots	mile/h 1.8~90.00mil/h	ft/m 157.5~7874ft/m
Temperature -10°C~60°C/14°F~140°F		Display Counts 9999

PACKAGING INFORMATION

-  **Color Box**
L110xW60xH190mm
-  **Carton Box**
40x33.5x24cm
-  **X 20PCS**



MAIN APPLICATIONS

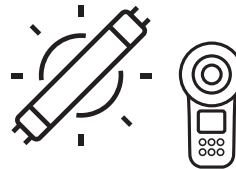
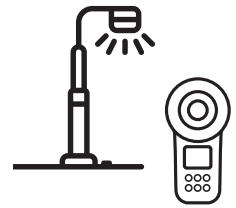
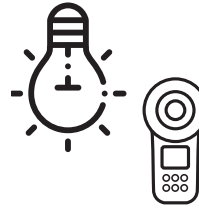

**DIGITAL LIGHTMETER [LUX]
MS6610**

SKU NO.: MS6610CBGLO
UPC CODE: 810053673058
EAN CODE: 8435394778785

FEATURE

- Data Hold.
- Silicon Photo Diode with Filter Photo Detector.
- Lead Length 150cm (Approx).
- Low Battery Indicator.

SPECIFICATIONS

LUX Ranging 50,000	Display Counts 2000
------------------------------	-------------------------------

CONTENTS



126×72×27mm
5.0"×2.8"×1.0"
180g/0.4lb

Detector Size:
83×52×21mm
3.2"×2.0"×0.8"



ACCESSORIES

Carry bag
Battery



1×9V 6F22
Battery



Calibration
Certificate



Quick Start
Guide

PACKAGING INFORMATION



Color Box
L115×W55×H165mm



Carton Box
48×34×31.5cm



X 40PCS



MAIN APPLICATIONS

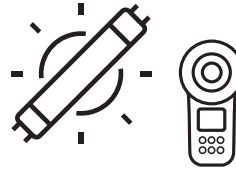
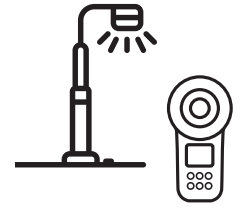
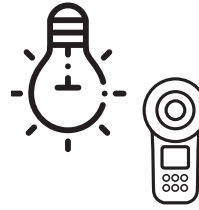

**DIGITAL LIGHTMETER [LUX/FC]
MS6612**

SKU NO.: MS6612CBGLO
UPC CODE: 810053674307
EAN CODE: 8435394779379

FEATURE

- Relative Measurement.
- Peak Measurement.
- Zero Calibration.
- LUX & FC unit selection.

SPECIFICATIONS

LUX Ranging 200,000	FC Ranging 20,000	Display Counts 2000
-------------------------------	-----------------------------	-------------------------------

CONTENTS



170×89×43mm
6.7"×3.5"×1.7"
420g/0.93lb



1×9V 6F22
Battery



ACCESSORIES

Carry bag
Battery



Calibration
Certificate



Quick Start
Guide

PACKAGING INFORMATION



Color Box
L110×W60×H190mm



Carton Box
40×33.5×24cm



X 20PCS



MAIN APPLICATIONS

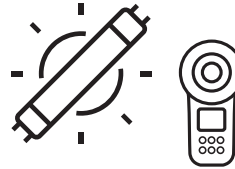
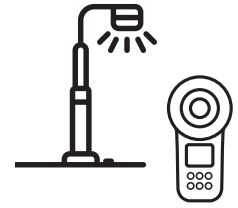
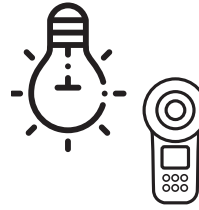

**DIGITAL LIGHTMETER [LUX/FC/CD]
MS6612B**

SKU NO.: MS6612BCBGLO
UPC CODE: 810053674314
EAN CODE: 8435394779386

FEATURE

- Relative Measurement.
- Peak Measurement.
- Zero Calibration.
- LUX, FC & CD unit selection.

SPECIFICATIONS

CD Ranging 999,900	LUX Ranging 200,000	FC Ranging 20,000
Display Counts 2000		

CONTENTS



170×89×43mm
6.7"×3.5"×1.7"
420g/0.93lb



1×9V 6F22
Battery



ACCESSORIES

Carry bag
Battery



Calibration
Certificate



Quick Start
Guide

PACKAGING INFORMATION



Color Box
L110×W60×H190mm



Carton Box
40×33.5×24cm



X 20PCS



MAIN APPLICATIONS

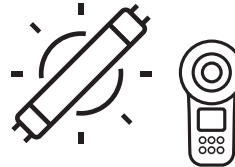
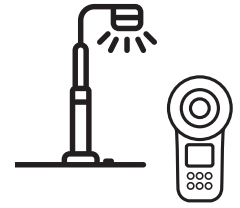
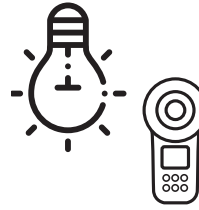

CONTENTS



170×89×43mm
6.7"×3.5"×1.7"
420g/0.93lb



1×9V 6F22
Battery



Carry bag
Battery



Calibration
Certificate

ACCESSORIES



Quick Start
Guide

**DIGITAL LIGHTMETER [LUX/FC/CD]
MS6612D**

SKU NO.: MS6612DCBGLO
UPC CODE: 810053676820
EAN CODE: 8435394785356

FEATURE

- Relative Measurement.
- Peak Measurement.
- Zero Calibration.
- LUX, FC & CD unit selection.

SPECIFICATIONS

CD Ranging
999,900

LUX Ranging
200,000

FC Ranging
20,000

Display Counts
2000

PACKAGING INFORMATION



Color Box
L110×W60×H190mm



Carton Box
40×33.5×24cm



X 20PCS



MAIN APPLICATIONS

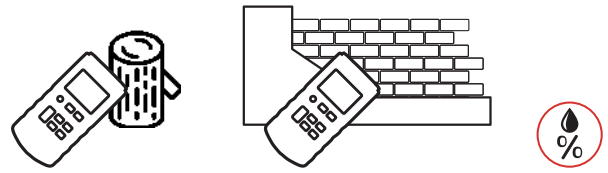

CONTENTS



130×56×29mm
 5.1"×2.2"×1.1"
 120g/0.26lb



2×1.5V AAA
 Batteries



Carry bag
 Battery



Calibration
 Certificate

ACCESSORIES



Quick Start
 Guide

PACKAGING INFORMATION



Color Box
 L75×W55×H155mm



Carton Box
 61×33×25cm



X 60PCS

MOISTURE TESTER

MS6900

SKU NO.: MS6900CBGLO
 UPC CODE: 810053674376
 EAN CODE: 8435394779447

FEATURE

- Verification Test Points.
- Depth 0~5mm.
- Sampling Rate 240ms.
- Unit Selection %, WB, TD, °C, °F, %RH.

SPECIFICATIONS

Material Moisture
0.0~60.0%

Ambient TEMP
-10°C~50°C/14°F~122°F

Relative Humidity
10~90%



MAIN APPLICATIONS

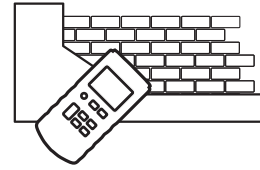

CONTENTS



130×56×29mm
5.1"×2.2"×1.1"
120g/0.26lb



2×1.5V AAA
Batteries



Carry bag
Battery

ACCESSORIES



Calibration
Certificate



Quick Start
Guide

MOISTURE TESTER

MS6900A

SKU NO.: MS6900ACBGLO
UPC CODE: 810053675298
EAN CODE: 8435394783314

FEATURE

- Verification Test Points.
- Depth 0~5mm.
- Sampling Rate 240ms.
- Unit Selection %, WB, TD, °C, °F, %RH.

SPECIFICATIONS

Material Moisture
0.0~60.0%

Ambient TEMP
-10°C~50°C/14°F~122°F

Relative Humidity
10~90%

PACKAGING INFORMATION



Color Box
L75×W55×H155mm



Carton Box
61×33×25cm



X 60PCS



MAIN APPLICATIONS

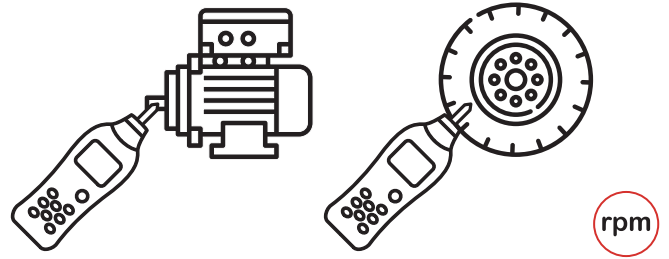

CONTENTS



170×60×27mm
6.7"×2.4"×1.1"
130g/0.28lb



4×1.5AAA
Batteries



ACCESSORIES

Measurement idler wheels
Touch tips
Lengthening bar
Carry bag
Battery



Calibration Certificate



Quick Start Guide

DIGITAL TACHOMETER (Contact)
MS6208A

SKU NO.: MS6208ACBGLO
UPC CODE: 810053672167
EAN CODE: 8435394777887

FEATURE

- Contact Measuring Mode.
- Unit Selection m/min, m/sec, ft/min, ft/sec, in/min
- Auto Power Off.

SPECIFICATIONS

Ranging (contact)
50~19,999RPM

PACKAGING INFORMATION



Color Box
L95×W45×H195mm



Carton Box
41.5×27×41cm







X 40PCS

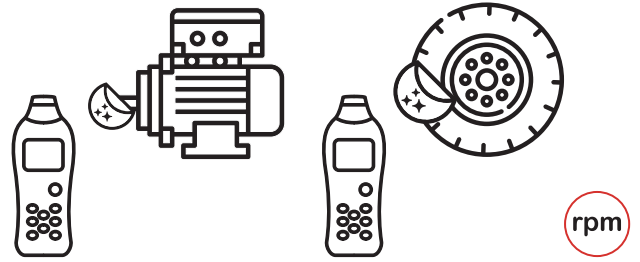

MAIN APPLICATIONS



CONTENTS

-  155×60×27mm
6.1"×2.4"×1.1"
120g/0.26lb
-  4×1.5 AAA Batteries
-  Reflective sheetin
Carry bag
Battery
-  Calibration Certificate
-  Quick Start Guide

DIGITAL TACHOMETER (Non-Contact)
MS6208B

SKU NO.: MS6208BCBGLO
UPC CODE: 810053672174
EAN CODE: 8435394777894



FEATURE

- Non-Contact Measuring Mode.
- Measuring Distance 50mm~250mm.
- Auto Power Off.
- MAX/MIN.

SPECIFICATIONS

Ranging (non-contact)
50~99,999 RPM

PACKAGING INFORMATION

-  **Color Box**
L95×W45×H195mm
-  **Carton Box**
41.5×27×41cm
-  **X 40PCS**



MAIN APPLICATIONS

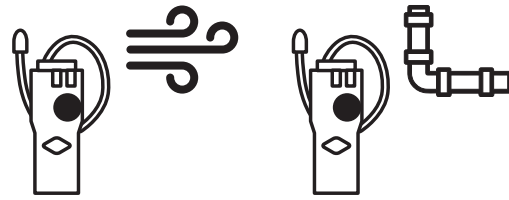

CONTENTS



172×70×465mm
6.8"×2.8"×1.8"
354g/0.78lb



4×1.5 AA
Batteries



Carry bag
Battery



Calibration
Certificate

ACCESSORIES



Quick Start
Guide

COMBUSTIBLE GAS DETECTOR

MS6310

SKU NO.: MS6310CBGLO
UPC CODE: 810053672334
EAN CODE: 8435394778242

FEATURE

- Easy to Identify and Pinpoint Gas Leaks.
- Portable and High Sensitivity.
- Resume Original Measurement State After 7~10 Minutes in Clear Air.

SPECIFICATIONS

Resolution
50ppm

Alarm
10%~40%

PACKAGING INFORMATION



Color Box
L130×W63×H255mm



Carton Box
53×34×28.5mm



X 20PCS



MAIN APPLICATIONS

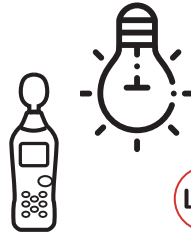

Lux

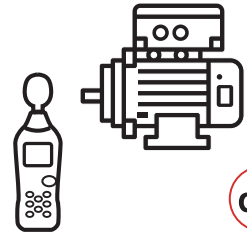

dB



km/h knots m/s FPM

MULTI-FUNCTIONS ENVIRONMENT TESTER
MS6300

SKU NO.: MS6300CBGLO
UPC CODE: 810053672594
EAN CODE: 8435394778235

FEATURE

- AVG / MAX / MIN / DIF (MAX-MIN)
- A/C Weighting Indication.
- Data Hold.
- Display Backlight.

SPECIFICATIONS

Sound Level 30~130dB(A)	Luminance 0~50,000LUX	Wind Speed 0.5~20m/s
Air Flow 999,900CMM/CFM	Humidity 20~80%RH	
Temperature -10°C~60°C/14°F~140°F		

CONTENTS



280×89×50mm
11.0"×3.5"×2.0"
433g/0.95lb



1×9V 6F22
Battery



ACCESSORIES

Windbreak
Holder
Wrapping case
Battery



Calibration
Certificate



Quick Start
Guide

PACKAGING INFORMATION



Color Box
L325×W80×H160mm



Carton Box
42×35×35cm



X 10PCS



MAIN APPLICATIONS

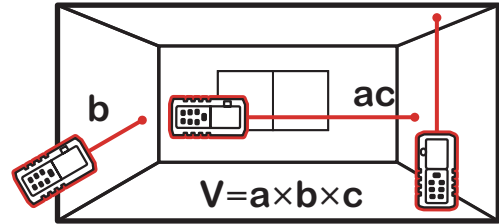
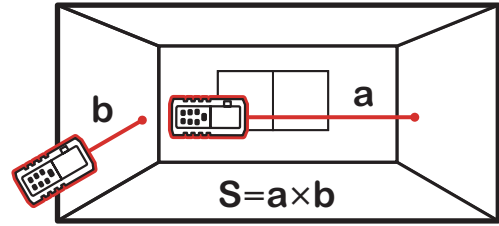

DISTANCE METER

MS6404/06/08

SKU NO.	MS6404CBGLO	MS6406CBGLO	MS6408CBGLO
UPC CODE	810053674246	810053676837	810053676844
EAN CODE	8435394779317	8435394786209	8435394786216

FEATURE

- Automatically cut off laser 20s.
- Automatic shutdown 150s.
- Data Logging 30 groups.
- MIN & MAX measurement.

SPECIFICATIONS

Distance(MS6404) 40m	Distance(MS6406) 60m	Distance(MS6408) 80m
Accuracy ±2.0mm	Unit mm / inch / ft	

CONTENTS



112×52×27mm
4.4"×6.0".0×1"
120g/0.26lb



2×1.5V AAA
Batteries



Portable bag
Battery

ACCESSORIES



Calibration
Certificate



Quick Start
Guide

PACKAGING INFORMATION



Color-Box
L75×W55×H155mm



Carton Box
61×33×25cm



X 60PCS



MAIN APPLICATIONS

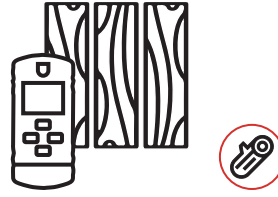

CONTENTS



160×74×42mm
6.3"×2.9"×1.65"
154g/0.33lb



1×9V 6F22
Battery



Battery

ACCESSORIES



Calibration
Certificate



Quick Start
Guide

ELECTRONIC STUD METAL FINDER

MS6906

SKU NO.: MS6906CBGLO
UPC CODE: 810053674574
EAN CODE: 8435394779645

FEATURE

- Auto Power Off.
- Low Battery Display.
- Display Backlight, Work Light.

SPECIFICATIONS

Wooden Pillar
30mm

Metal Stud Detection Depth
30mm

Metal Pipe Detector Depth
50mm

AC Voltage Detector Depth(50~600VAC)
75mm

PACKAGING INFORMATION



Color Box
L145×W60×H188mm



Carton Box
40×32×31.5cm



X 20PCS



MAIN APPLICATIONS

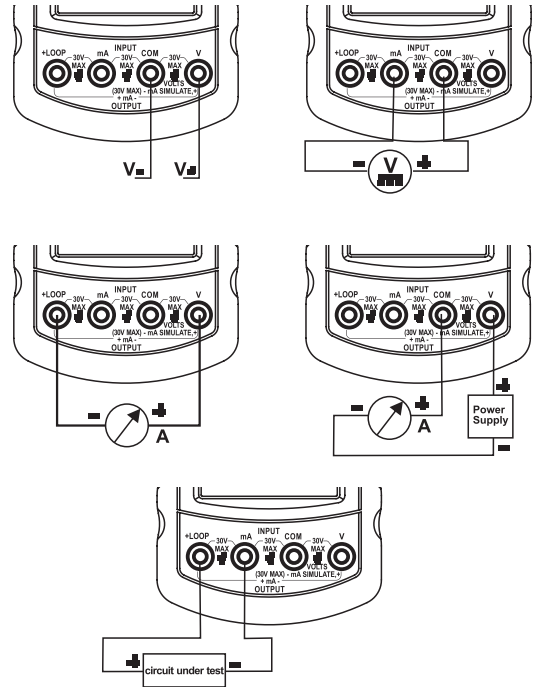

VOLTAGE AND CURRENT CALIBRATOR
MS7221

SKU NO.: MS7221CBGLO
UPC CODE: 810053672020
EAN CODE: 8435394777757

FEATURE

- Selection of Absolute or Percentage Value in Amp Mode
- Calibration and Simulation of External Transducers
- LOOP Mode

SPECIFICATIONS

DC Voltage (Input/Output) 0~100mV, 0~10V	DC Current 0~24mA
DC Voltage (Loop) 0~24V	

CONTENTS

- 190×89×42mm
7.5"×3.5"×1.7"
350g/0.77lb
- 1×9V 6LR61 Battery
- Test leads
Wapping case
Battery
- Calibration Certificate
- Quick Start Guide

PACKAGING INFORMATION

- Color Box**
L188×W88×H264mm
- Carton Box**
47×31×39.5cm
- X 10PCS**

TEST LEADS

T3009U



SKU NO..	UPC CODE	EAN CODE
T3009UPEGLO		

- Probe Length: 146mm/ø10.2mm
- Right Angle Type, M4 screw
- Length: 1200mm
- Tip: ø2mm
- Plug: ø4.5mm
- Wire: UL 1803/18AWG
- MAX 10A

TEST LEADS

T3016U



SKU NO..	UPC CODE	EAN CODE
T3016UPEGLO	810053674000	8435394779072

- Probe Length: 132mm/ø10mm
- Right Angle Type, M4 screw
- Length: 1000mm
- Tip: ø2mm
- Plug: ø4.5mm
- Wire: UL 1803/18AWG
- MAX 10A

TEST LEADS

T3022



SKU NO..	UPC CODE	EAN CODE
T3022PEGLO	810053674017	8435394779089

- Straight Type & Right Angle Type
- Length: 1000mm
- Plug: ø4.5mm
- Wire: UL 1803/18AWG
- MAX 10A

TEST LEADS

T3030U

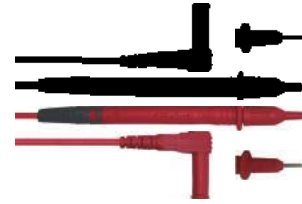

SKU NO..	UPC CODE	EAN CODE
T3030UPEGLO	810053672778	8435394778419

- Probe Length: 143mm/ø10mm
- Length: 1000mm
- Tip: ø2mm
- Plug: ø4.5mm
- Wire: UL 1803/18AWG
- MAX 10A

TEST LEADS

T3033U

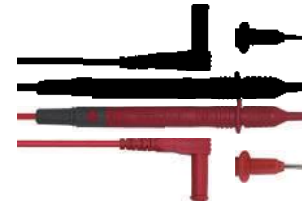

SKU NO..	UPC CODE	EAN CODE
T3033UPEGLO	810053672785	8435394778426

- Probe Length: 119mm/ø9mm
- Length: 800mm
- Tip: ø2mm
- Plug: ø4.5mm
- Wire: UL 1803/20AWG
- MAX 10A

TEST LEADS

T3060A

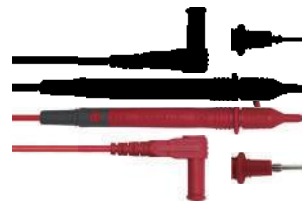

SKU NO..	UPC CODE	EAN CODE
T3060APEGLO	810053674819	8435394783482

- Probe Length: 132mm/ø10mm
- Right Angle Type, M4 screw
- Length: 1000mm
- Tip: ø2mm
- Plug: ø4.5mm
- Wire: UL 1803/18AWG
- MAX 10A

TEST LEADS

T3060B



SKU NO..	UPC CODE	EAN CODE
T3060BPEGLO	810053674826	8435394779881

- Probe Length: 132mm/ø10mm
- Right Angle Type, M4 screw
- Length: 1500mm
- Tip: ø2mm
- Plug: ø4.5mm
- Wire: UL 1803/18AWG
- MAX 10A

TEST LEADS

T3103



SKU NO..	UPC CODE	EAN CODE
T3103PEGLO	810053674024	8435394779096

- Straight Type
- Length: 1340mm
- Plug: ø4.5mm
- Wire: UL 1803/18AWG
- MAX 10A

Big Mouth Alligator Clip

C3107



SKU NO..	UPC CODE	EAN CODE
C3107PEGLO	810053674031	8435394779102

- Length: 87mm
- ø4mm cross plug
- Max 32A

Alligator Clip

C3109A



SKU NO..	UPC CODE	EAN CODE
C3109APEGLO	810053674901	8435394782355

- Length: 61.5mm
- with M4 screw

Medium Alligator Clip

C3109B



SKU NO..	UPC CODE	EAN CODE
C3109BPEGLO	810053673249	8435394778723

- Length: 55mm
- with M4 screw

IC Test Clip

C3112



SKU NO..	UPC CODE	EAN CODE
C3112PEGLO	810053675014	8435394783451

- Length: 185mm
- Plug: ø4mm Jack
- Max 5A

THERMOCOUPLES
P3400



SKU NO..	UPC CODE	EAN CODE
P3400PEGLO	810053676752	8435394779867

- Length:1000mm
- Ranging:-40~260°C(-40~500°F)

THERMOCOUPLES
P3408A



SKU NO..	UPC CODE	EAN CODE
P3408APEGLO	810053675410	8435394783482

- Length:1000mm
- Ranging:-40~260°C(-40~500°F)
- Plug lenth : 12mm

THERMOCOUPLES
P3401



SKU NO..	UPC CODE	EAN CODE
P3401PEGLO	810053674888	8435394782096

- Length:1000mm
- Ranging:-40~260°C(-40~500°F)

THERMOCOUPLES
P3409A



SKU NO..	UPC CODE	EAN CODE
P3409APEGLO	810053675434	8435394783505

- Length:1000mm
- Ranging:-40~800°C(-40~1472°F)
- Plug lenth : 12mm

THERMOCOUPLES
P3408B



SKU NO..	UPC CODE	EAN CODE
P3408BPEGLO	810053675427	8435394783499

- Length:1000mm
- Ranging:-40~260°C(-40~500°F)
- Plug lenth : 16mm

THERMOCOUPLES
P3409B



SKU NO..	UPC CODE	EAN CODE
P3409BPEGLO	810053674802	8435394779867

- Length:1000mm
- Ranging:-40~800°C(-40~1472°F)
- Plug lenth : 16mm

THERMOCOUPLES

P3410



SKU NO..	UPC CODE	EAN CODE
P3410PEGLO	810053675441	8435394783512

- Length:1000mm
 - Ranging:-40~600°C(-40~1112°F)

THERMOCOUPLES

P3412



SKU NO..	UPC CODE	EAN CODE
P3412PEGLO	810053675458	8435394783529

- Length:1000mm
 - Ranging:-40~260°C(-40~500°F)

MASTECH®

www.mastech-group.com



AMERICAS

MGL America, Inc.

✉ cs.na@mgl-intl.com
6509 Northpark Blvd Unit 400,
Charlotte, NC 28216 USA
Tel: +1 833 533-5899

APAC

MGL APPA Corporation

✉ cs.apac@mgl-intl.com
Flat 4-1, 4/F, No. 35, Section 3
Minqun East Road, Taipei, Taiwan
Tel: +886 2-2508-0877

EMEA

MGL Euman S.L.

✉ cs.emea@mgl-intl.com
C/ Picu Castiellu, Parcelas i1-i4
Argame, Morcin 33163, Asturias, Spain
Tel: +36 985-08-18-70

MEXICO & LATAM

MGL LATAM SA DE CV

✉ cs.latam@mgl-intl.com
Colonia Industrial Vallejo Del.
Azcapotzalco 02300, Mexico DF
Tel: +1 883-533-5899

UNITED KINGDOM

POWER PROBE GROUP LIMITED

✉ cs.uk@mgl-intl.com
14 Weller St, London, SE1 1QU, UK
Tel: +34 985-08-18-70

Где купить:

ООО "КОМПАНИЯ ОПТУЛС"

г.Москва, ул.Бирюлёвская, д.53, корп. 2, офис 113

Tel.: +7 (495) 646-00-96

E-Mail: sale@opttools.ru

Internet: www.opttools.ru