



Price List 2019





IZELTAS[®]

*“50 yıldır aileden biri”
"family member since 50 years"*

www.izeltas.com.tr



b2b.izeltas.com.tr

Close to you at every platform

**Her platformda
Bir tık kadar yakınızdada...**



İZELTAŞ - İŞIKKENT



İZELTAŞ - SÜTÇÜLER



İZELTAŞ - TURGUTLU



Yarım asırlık 'güven'

Kalite yolculuğu inanmakla başlar.

Türkiye'nin ilk ve en büyük el aletleri üreticisi İZELTAŞ, tam 50 yıl önce Ege'nin gözbebeği İzmir'den işte bu inançla yola çıktı. Yüzde 100 Türk sermayesiyle oluşturulan ve günden güne büyüyen İZELTAŞ, modern teknolojiyle donatılmış dev tesislerinde üretilen dört bin beş yüz den fazla ürünle 40 ülkeye ihracat yaparak hem kendi insanına hem de ülke ekonomisine katkı sağlıyor.

El aletlerinin yanı sıra üretilen dövme parçalar ile başta otomotiv olmak üzere inşaat, denizcilik ve madencilik sektörüne, savunma ve havacılık sanayilerine, ziraat endüstrisine, altyapı işlerine dek birçok kamu ve özel sektör kuruluşuna hizmet sunuyor.

Daha iyisi, daha yenisi için...

Kalıphane, dövme, işleme, ısıtma işlemi, krom-nikel kaplama, boyama, plastik daldırma, plastik enjeksiyon ve markalama departmanlarından oluşan dünyadaki ender entegre fabrikalardan İZELTAŞ'ta üretimin her aşamasında kalite kontrolüne tabi tutulan ürünler; fiziksel, metalürjik, kimyasal ve elektriksel testlerden geçirilerek İZELTAŞ güvencesine alınıyor. Ar-Ge ve inovasyon ışığında değişime ve gelişime her daim açık olan İZELTAŞ, bu sayede gücüne güç katıyor.

T.C. Sanayi ve Teknoloji Bakanlığ'ından AR-GE Merkezi belgesine sahip İZELTAŞ, TS EN ISO 9001 Kalite Yönetim Sistemi, IATF 16949 Otomotiv Kalite Yönetim Sistemi, TS (OHSAS) 18001 İş Sağlığı ve Güvenliği Yönetim Sistemi, TS EN ISO 14001 Çevre Yönetim Sistemi, TS EN ISO 50001 Enerji Yönetim Sistemleri; TSE, TSEK, VDE GS ürün kalite belgeleri ve yüksek teknolojisi ile sadece Türkiye'de değil, dünyada da farkını ortaya koyuyor.

Önce güvenlik, sonra üretim

İnsan önemli, emek değerlidir. İZELTAŞ, "Önce güvenlik" anlayışından ayrılmadan, çalışanları için önlem almaya, onları iş sağlığı ve güvenliği konusunda eğitmeye devam ediyor. Çünkü; "İnsan vücudunun yedek parçası yoktur"

Size ulaştıktan sonra...

Satış sonrasında tüketici haklarını koruma ve sınırsız hizmet anlayışı İZELTAŞ'ın vazgeçilmez şirket politikalarından birini oluşturuyor.

Dolayısıyla...

- El aletleri' dendiğinde akla gelen ilk isim olabildiysek,
- Yarım asırdır 'aileden biri' olmanın hakkını verebildiysek,
- 'Türk malı' sözünün altına imzamız atabildiysek,
- 'Yıllarca kullanılır' diyerek her zaman tercih edildiysek,

Gücümüzü, şevkimizi ve inancımızı siz değerli bayilerimiz ve tüketicilerimizden alıyoruz.

850 çalışanımızla birlikte üreterek, değer sağlayarak dünya markası olmanın haklı gururunu yaşıyoruz.

Nice 50 yıllara!

Half a century of reliability

Faith is the essential step on the journey to achieve utmost quality.

As the first and largest hand tool manufacturer of Turkey, İZELTAŞ, had this faith as it started its journey 50 years ago in İzmir, the beautiful city in the Aegean region. Its establishment, consisting of 100% national capital, İZELTAŞ has grown in years into an industrial giant with huge facilities equipped with state-of-the-art technologies and over 4500 products. Exporting to more than 40 countries, the company is a prominent contributor to not only the Turkish economy but also the community.

Along with manufacturing hand tools, İZELTAŞ produces forged steel parts for various industries like automotive, construction, maritime, mining, aviation, defence, agriculture and infrastructure.

Newer and better

İZELTAŞ is one of the few fully integrated factories in the world that consists of die tooling, forging, processing, heat processing, chrome-nickel plating, dyeing, pvc coating, plastic injection and marking departments. Every stage of the production is tested for quality assurance using physical, metallurgical, chemical and electrical methods. R&D and innovation are the key words that empower İZELTAŞ as a company which embraces development and improvement as its main philosophy.

İZELTAŞ is an accredited R&D Center by the Ministry of Science, Industry and Technology and has been certified with the following: ISO 9001 Quality Management System, IATF 16949 Automotive Quality Management System, OHSAS 18001 Occupational Health and Safety Management System, ISO 14001 Environment Management System, ISO 50001 Energy Management System certification, TSE, TSEK and VDE GS product certification.

Safety before production

Humans are the most significant factors of any industry and their labour is precious. Health and safety awareness is the fundamental policy of İZELTAŞ. The company continuously organizes training programs on occupational health and safety which emphasise that safety comes first and it is not possible to fix humans by changing the damaged organs with spare ones.

Customer satisfaction

Another fundamental policy of İZELTAŞ is the customer satisfaction. The company is dedicated to serve its customers and protect their rights as consumers.

Hence...

- We are the first brand that comes to mind in the hand tools industry
- We are valued almost as a part of the families of our consumer
- We have proved ourselves worthy of the statement "Made in Turkey"
- We have been the first choice of the consumers for durability over the years

Our power, enthusiasm and faith are derived from our distinguished dealers and consumers.

We are proud to have become a world brand with our 850 employees who strive everyday to contribute to the productivity of the company, creating an added value for the economy and our community.

To many 50 years to come!

Takım Dolapları ve Takım Çantaları
Tool Trolleys, Tool Boxes



7-38

1

Anahtarlar
Wrenches



41-60

2

Lokma ve Bijon Anahtarları
Sockets and Rim Wrenches



61-84

3

Boru Anahtarları ve Penseler
Pipe Wrenches and Pliers



85-98

4

1000V Grubu Ürünler
1000V Product Group



99-102

5

Tornavida ve Allen Anahtarlar
Screwdrivers and Hex Key Wrenches



103-123

6

Keskiler ve Çekiçler
Chisels and Hammers



125-130

7

Servis Alet ve Ekipmanları
Maintenance Tools and Equipment



131-138

8

Makaslar
Shears



139-144

9

Çektirmeler
Pullers



145-150

10

Yedek Parçalar
Spare Parts



151-154

11

Ticari Teşhir Standları
Commercial Display Stands



155-158

12

Teknik Bilgiler
Technical Information



159-166

13



ZELTAS

10 12 14 16 18 20 22 24 27 30 36 42 48 54 60 66 72 78 84 90 96 102 108 114 120 126 132 138 144 150 156 162 168 174 180 186 192 198 204 210 216 222 228 234 240 246 252 258 264 270 276 282 288 294 300 306 312 318 324 330 336 342 348 354 360 366 372 378 384 390 396 402 408 414 420 426 432 438 444 450 456 462 468 474 480 486 492 498 504 510 516 522 528 534 540 546 552 558 564 570 576 582 588 594 600 606 612 618 624 630 636 642 648 654 660 666 672 678 684 690 696 702 708 714 720 726 732 738 744 750 756 762 768 774 780 786 792 798 804 810 816 822 828 834 840 846 852 858 864 870 876 882 888 894 900 906 912 918 924 930 936 942 948 954 960 966 972 978 984 990 996

1

Takım Dolapları Takım Çantaları ve Alet Setleri Tool Trolleys, Tool Boxes and Hand Tool Sets



Takım Dolapları Tool Cabinets

Takım Çantaları Tool Boxes

Servis Masaları Service Tables

Alet Setleri Tool Sets



ZELTAS

8241 PRO SERİSİ / PRO SERIES

Pro Serisi Takım Dolabı (5-6-7-8 Çekmeceli) Pro Series Workshop Trolley (5-6-7-8 Drawers)



Ölçü/Size: 470x670x1006 mm

Sacdan imal edilmiş, Fırın boyalı
Made of sheet metal, Electrostatic paint

✓ Merkezi kilit sistemi, mandal sistemi ve devrilme emniyet sistemi.
● Central lock system, handgrip lock system and antitilt system.



✓ Teleskobik rulmanlı kızaklar tüm çekmeceler %100 açılabilir.
● Telescopic slides which are %100 extendable.



✓ 8 bölmeli sağlam ve dayanıklı ABS plastik üst malzeme tabla.
● Durable ABS worktop with 8 divisions

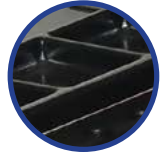

✓ 2 sabit, 2 hareketli frenli tekerlek Ø 125mm
● 2 swivel castors with brake, 2 fixed castors Ø 125mm



✓ Yüksek dayanımlı elektrostatik toz boya.
● High strength electrostatic powder coating



✓ Toplam 6 Adet yan ve arka avadanlık bölümleri.
● 6 tool holders



KOD/CODE	ÇEKMECE DRAWERS	35 kg	45 kg	45 kg	kg	RENK COLORS	EURO
		400x548x68	400x548x143	400x548x218			
8241 32 1005	5	1X	4X	--	59		324,72
8241 32 1006	6	4X	1X	1X	62	RAL 7035 RAL 3020	336,12
8241 32 1007	7	5X	2X	--	65		348,16
8241 32 1008	8	7X	1X	--	67		359,34
8241 32 2005	5	1X	4X	--	59		324,72
8241 32 2006	6	4X	1X	1X	62	RAL 7035 RAL 5003	336,12
8241 32 2007	7	5X	2X	--	65		348,16
8241 32 2008	8	7X	1X	--	67		359,34
8241 32 3005	5	1X	4X	--	59		324,72
8241 32 3006	6	4X	1X	1X	62	RAL 7035 RAL 7016	336,12
8241 32 3007	7	5X	2X	--	65		348,16
8241 32 3008	8	7X	1X	--	67		359,34
8241 00 1209 Dolu/Full 209 Parça/Pcs	8	7x	1x	--			1.455,69

1. Pro Seri Çekmece/Drawer

Kod / Code 8241001030

KOD CODE	İÇERİK CONTENTS	□	EURO
0130	İki Ağız Anahtar Uzun Boy / D/E Open Jaw Wrench Long Pattern 6x7 - 8x9 - 10x11 - 12x13 14x15 - 16x17 - 18x19 - 20x22 21x23 - 24x26	10	
0330	Kombine Anahtar Uzun Boy / Combination Wrench Long Pattern 6 - 7 - 8 - 9 - 10 - 11 - 12 - 13 14 - 17 - 19 - 22	12	96,87
0430	Yıldız Anahtar / D/E Ring Wrench 6x7 - 8x9 - 10x11 - 12x13 14x15 - 16x17 18x19 - 20x22	8	

2. Pro Seri Çekmece/Drawer

Kod / Code 8241002072

KOD CODE	İÇERİK CONTENTS	□	EURO
1107	1/4" Karbüratör Lokma Takımı / 1/4" Socket Wrench Set 4 - 5 - 6 7 - 8 - 9 - 10 11 - 12 - 13 Altı Köşe Six Point 8 - 10 Sekiz Köşe Eight Points	18	
1113	1/2" Lokma Takımı / 1/2" Socket Wrench Set 10 - 11 - 12 13 - 14 - 15 16 - 17 - 18 19 - 21 - 22 23 - 24 - 26 27 - 28 - 30 32	24	288,39
1113	1/2" Lokmalı Allen Uçlar / 1/2" Hexagonal Bits Sockets H5-H6-H7-H8-H10-H12-H14	7	
1113	1/2" Lokmalı Star Uç / 1/2" Star Bits Socket T20-T25-T27-T30-T40-T45-T50-T55-T60	9	
0330	Kombine Anahtar Uzun Boy / Combination Wrench Long Pattern	2	
4900	Allen Takımı 6 Köşe / Hex Key Wrench Set 2-2.5-3-3.5-4-5-6-7-8-9-10-12	12	

3. Pro Seri Çekmece/Drawer

Kod / Code 8241003051

KOD CODE	İÇERİK CONTENTS	□	EURO
07415	Sıralı Tel Fırça 3 Sıralı / Hand Brush 3 Raws	1	
6350	Levye Oluklu / Tyre Lever 400 mm	1	
6220	Spiralli Mıknatıs / Flexible Magnet Holder 500 gr	1	
4110	Düz Topaç Tornavida / Screwdriver , Stubby, Flat 6.5x25	1	
4130	Yıldız Topaç Tornavida / Screwdriver , Stubby, Phillips 6x25	1	146,59
4770	Lokma Uçlu Tornavida / Nutspinner 6-7-8-9-10-13	6	
4780	Manyetik Bits Tutucu Tornavida / Screwdriver, Magnetic Bit Holder 6.3x120	1	
4905	Yuvarlak Başlı Allen Takımı (Kutulu) / Hexkey Wrench Ballpoint Set 2-2.5-3-4-5-6-8-10 mm	8	
4800	Bits Set Takım (Kutulu) / Bits Set in metal case	31	



4

4. Pro Seri Çekmece/Drawer

Kod / Code 8241004027

KOD CODE	İÇERİK CONTENTS	☐	EURO
0340	Cırcır Kombine Anahtar / Combination Wrench With Ratchet 10-13-17-19 mm	4	
4909	T Tipi Torx Allen Anahtar / Torx Allen Key T type T9-T10-T15-T20-T25-T27-T30-T40	8	
1108	1/2" Altı Köşe Derin Lokma / 1/2" Deep Socket Wrench, six points 10-11-12-13-14-15-16-17-18-19	10	247,45
1113	1/2" Altı Köşe Havalı Lokma / 1/2" Impact Socket Wrench 13-17-18-19-24 mm	5	

1



5

5. Pro Seri Çekmece/Drawer

Kod / Code 8241005010

KOD CODE	İÇERİK CONTENTS	☐	EURO
3331	İç Eğri Segman Pense / Circlip Pliers, Internal, Bent 170 mm	1	
3321	İç Düz Segman Pense / Circlip Pliers, Internal, Flat 180 mm	1	
3311	Dış Eğri Segman Pense / Circlip Pliers, External, Bent 170 mm	1	
3301	Dış Düz Segman Pense / Circlip Pliers, External, Flat 180 mm	1	
3700	Yan Keski Opak İzole / Side Cutting Pliers, 160 mm	1	201,59
3220	Düz Kargaburun Opak İzole / Nose Pliers, 200 mm	1	
3020	Kombine Pense Opak İzole / Combination Pliers, 180 mm	1	
2510	Special Ayarlı Pense / Special Grip 250 mm	1	
0600	Kurbağacık Anahtar / Adjustable Jaw Wrench 10"	1	
2400	Üniversal Fort Pense / Universal Grip 240 mm	1	



6

6. Pro Seri Çekmece/Drawer

Kod / Code 8241006018

KOD CODE	İÇERİK CONTENTS	☐	EURO
4300	Opak Seri Düz Uçlu Tornavida / Opak Screwdriver, Flat 4x100-5x125-6x150-8x175	4	
4320	Opak Seri Yıldız Uçlu Tornavida / Opak Screwdriver, Phillips 4.5x80-6x100	2	
5800	Tesviyeci Çekiç / Mechanist Hammer 300 gr	1	
5850	Plastik Çekiç / Plastic Hammer ø30	1	
5545	Konik Pim Zimba / Drift Punch 5 mm	1	114,86
5550	Düz Pim Zimba / Split Pin Punch 5 mm	1	
5540	Nokta Zimba / Center Punch 5x120	1	
5500	Düz Keski / Flat Cold Chisel 150 mm	1	
4920	T Tipi Allen Anahtar / T Type Hex Key Wrench 3-4-5-6-7-8	6	



8245 PREMIUM SERİSİ / PREMIUM SERIES

Premium Serisi Takım Dolabı (5-7 Çekmeceli) Premium Series Workshop Trolley (5-7 Drawers)



✓ 6 bölmeli sağlam ve dayanıklı ABS plastik üst malzeme tabla.
● Resistant and solid top cover having 6 divisions



✓ %100 açılabilir teleskobik raylar.
● %100 extendable telescopic slides



✓ Merkezi kilit
✓ Mandal sistemi
✓ Devrilme emniyet sistemi
● Central lock
● Handgrip Lock system
● Anti tilt system



✓ 2 sabit, 2 hareketli frenli tekerlek ø 125mm
● 2 swivel castors with brake
2 fixed castors ø 125mm



✓ Standard tutma sapı
● Standard handle



✓ Plastik köşe koruma
● Plastic corner protection







✓ Yüksek dayanımlı elektrostatik toz boya.
● High strength electrostatic powder coating.

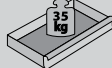

Ölçü/Size: 495x717x947

Sacdan imal edilmiş, Fırın boya
Made of sheet metal, Electrostatic paint

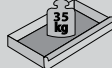

KOD/CODE	ÇEKMECE DRAWERS					RENK COLORS	EURO
		400x548x62	400x548x132	400x548x201			
8245 32 1005	5	2	1	2			347,46
8245 32 1007	7	5	1	1		RAL 9005 RAL 3020	378,66
8245 00 7096 Dolu/Full 245 Parça/Pcs	7	5	1	1			1.714,06

1. Premium Seri Çekmece/Drawer Kod / Code 8245001042

KOD CODE	İÇERİK CONTENTS	□	EURO
0100	İki Ağız Anahtar Kısa Boy D/E Open jaw wrenches Short Pattern 6x7-8x9-10x11-12x13-14x15-16x17-18x19-20x22	8	
0320	Kombine Anahtar Kısa Boy Combination wrenches Short Pattern 6-7-8-9-10-11-12-13-14-15-16-17-18-19-20-21-22-24-27-30-32	21	213,72
0430	Yıldız Anahtar Ring Wrenches 6x7-8x9-10x11-12x13-14x15-16x17-18x19-20x22	8	
0340	Cırcır Kombine Anahtar / Combination Wrench With Ratchet 8-10-13-17-19 mm	5	

2. Premium Seri Çekmece/Drawer Kod / Code 8245002094

KOD CODE	İÇERİK CONTENTS	□	EURO
1107	1/4" Lokmalı Allen Uçlar / Hexagonal Bits Socket 2,5 - 3 - 4 - 5 - 6 - 7 - 8 - 10	8	
1107	1/4" Lokmalı Torx Uç / Torx Bits Socket T8-T9-T10-T15-T20-T25-T27-T30-T40	9	
1107	1/4" Lokmalı Yıldız Uç / Phillips Bits Socket PH1-PH2-PH3	3	
1107	1/4" Lokmalı Düz Uç / Slotted Bits Socket 3 - 4 - 5,5 - 6,5	4	
1107	1/4" Altı Köşe Derin Lokma / Deep Socket Wrench 6 Point 4-5-5,5-6-7-8-9-10-11-12-13	11	
1113	1/2" Lokmalı Allen Uç Takım / Hexagonal Bits Socket 5-6-7-8-10-12-14	7	
1113	1/2" Lokmalı Torx Uç Takım / Torx Bits Socket T20-T25-T27-T30-T40-T45-T50-T55-T60	9	
1107	1/4" Karbüratör Lokma Takımı / Socket Wrench Set 4 - 5 - 6 7 - 8 - 9 - 10 11 - 12 - 13 Altı Köşe Six Points	18	351,95
1113	8 - 10 Sekiz Köşe	1	
1113	10 - 11 - 12 - 13 14 - 15 16 - 17 - 18 19 - 21 - 22 23 - 24 - 26 - 27 28 - 30 32 Altı Köşe Six Points	24	
	1/4" Cırcır kolu / Ratchet Handle		
	1/4" Mafsal / Universal Joint		
	1/4" T Kol / Sliding T Handle		
	1/4" Ara Kol / Extension Bar 50-100 mm		
	1/4" Mafsalı Kol / Flexible Handle		
	1/2" Buji Lokma Lastikli Spark Plug Socket With Rubber 16 mm		
	1/2" Lokma Takımı / Socket Wrench Set		
	1/2" Cırcır Kolu 32 Diş Ratchet Handle		
	1/2" Mafsal / Universal Joint		
	1/2" T Kol Adaptör / Sliding T Handle Adapter		
	1/2" Ara Kol / Extension Bar 125 mm		
	1/2" Ara Kol / Extension Bar 250 mm		

3. Premium Seri Çekmece/Drawer Kod / Code 8245003014

KOD CODE	İÇERİK CONTENTS	□	EURO
3700	Yan Keski Opak İzole / Side Cutting Pliers 160 mm	1	
3020	Kombine Pense Opak İzole / Combination Pliers 180 mm	1	
3220	Düz Kargaburun Opak İzole / Nose Pliers Flat 180 mm	1	
4300	Opak Seri Düz Uçlu Tornavida / Screwdriver, Flat 3x80-5x125-7x150mm	3	
4320	Opak Seri Yıldız Uçlu Tornavida / Screwdriver, Philips 3x60-4.5x80-6x100-8x150mm	4	166,73
3301	Dış segman Pensi Yaylı Düz / Circlip Pliers, External Flat 140-180mm	2	
3321	İç segman Pensi Yaysız Düz / Circlip Pliers, Internal Flat 140-180mm	2	

4. Premium Seri Çekmece/Drawer Kod / Code 8245004043

KOD CODE	İÇERİK CONTENTS	□	EURO
4770	Lokma Uçlu Tornavida / Nutspinner 6-7-8-9-10-13	6	169,23
4910	Torx Allen Takım / Torx Key Wrench Set T9-T10-T15-T20-T25-T27-T30-T40	8	
4900	Allen Takımı 6 Köşe / Hex Key Wrench Set 2-2.5-3-3.5-4-5-6-7-8-9-10-12	12	
4906	Yuvarlak Başlı Uzun Allen Takımı / Hex key Wrench Ballpoint Long Pattern Set 1,5-2-2,5-3-4-5-6-8-10 mm	9	
4920	T Tipi Allen Anahtar / T Type Hex Key Wrench 2.5-3-4-5-6-7-8-10	8	

5. Premium Seri Çekmece/Drawer Kod / Code 8245005043

KOD CODE	İÇERİK CONTENTS	□	EURO
4565	Oto Elektrik Kontrol Kalemi Car Voltage Tester 135mm	1	164,87
07415	Sıralı Tel Fırça 4 Sıralı / Hand Brush 4 Raws	1	
2400	Üniversal Fort Pense PVC / Universal Grip 240 mm	1	
2500	Üniversal Ayarlı Pense Universal Grip 250 mm	1	
0600	Kurbağacık Anahtar / Adjustable Wrench 10"	1	
4780	Manyetik Bits Tutucu Tornavida / Screwdriver, Magnetic Bit Holder 6.3x120	1	
4800	31'li Bits Takım (Plastik Kutulu) / Bits Set in plastic case	31	
4110	Düz Topaç Tornavida / Screwdriver, Stubby, Flat 6.5x25	1	
4130	Yıldız Topaç Tornavida / Screwdriver, Stubby, Phillips 6x25	1	
5500	Düz Keski Krom Flat Cold Chisel 150 mm	1	
5800	Tesviyeci Çekici Machinist's Hammer 300-1500 gr	2	
6350	Levye Oluklu / Tyre Lever 500 mm	1	

6. Premium Seri Çekmece/Drawer Kod / Code 8245006009

KOD CODE	İÇERİK CONTENTS	□	EURO
1855	Mafsallı T Kol Lokma T- Handle Wrench with Universal Join 8-10-12-13-17-19	6	268,90
6230	Gres Pompası Grease Gun 500cc	1	
06375	Ayarlı Yağ Filtre Sökeceği Adjustable Slot Type Oil Filter Wrench	1	
6225	Madeni Yağdanlık (Flexible Uçlu) Oiler With Flexible Spout 200cc	1	



8242 GARAJ SERİSİ / GARAGE SERIES

Garaj Serisi Takım Dolabı (5-6-7-8 Çekmeceli)
Garage Series Workshop Trolley (5-6-7-8 Drawers)



- ✓ Ergonomik sap
● Ergonomic handle
- ✓ 8 Bölmeli, sağlam ABS tabla
● Durable ABS worktop with divisions
- ✓ Havluluk x1
Avadanlık x2 Askılık x1
● Paper Roll Holder
x1 Bottle & Tins Holder x2 Hanger x1
- ✓ %100 açılabilir teleskobik raylar
● %100 extendable telescopic slides
- ✓ Merkezi kilit sistemi, mandal sistemi devrilme emniyet sistemi.
● Central locking, system handgrip lock system anti-tilt system
- ✓ 2 sabit, 2 hareketli frenli tekerlek Ø 125mm
● 2 swivel castors with brake 2 fixed castors Ø 125 mm
- ✓ Yüksek dayanımlı elektrostatik toz boya.
● High strength electrostatic powder coating

Ölçü/Size: 470x670x1008 mm

Sacdan imal edilmiş, Fırın boya
Made of sheet metal, Electrostatic paint



KOD/CODE	ÇEKMECE DRAWERS	35 kg	45 kg	45 kg	kg	RENK COLORS	EURO
		400x548x68	400x548x143	400x548x218			
8242 32 1005	5	1X	4X	--	59		306,40
8242 32 1006	6	4X	1X	1X	62	RAL 7016 RAL 3020	320,10
8242 32 1007	7	5X	2X	--	65		333,78
8242 32 1008	8	7X	1X	--	67		349,36
8242 32 2005	5	1X	4X	--	59		306,40
8242 32 2006	6	4X	1X	1X	62	RAL 7016 RAL 5003	320,10
8242 32 2007	7	5X	2X	--	65		333,78
8242 32 2008	8	7X	1X	--	67		349,36
8242 32 3005	5	1X	4X	--	59		306,40
8242 32 3006	6	4X	1X	1X	62	RAL 7016 RAL 7035	320,10
8242 32 3007	7	5X	2X	--	65		333,78
8242 32 3008	8	7X	1X	--	67		349,36
8242 00 1142	7	5X	2X	--			1.128,51
Dolu/Full 142 Parça/Pcs							
8242 00 8142	8	7X	1X	--			1.144,09
Dolu/Full 142 Parça/Pcs							

1. Garaj Seri Çekmece/Drawer

Kod / Code 8242001030

KOD CODE	İÇERİK CONTENTS	☐	EURO
0130	İki Ağız Anahtar Uzun Boy D/E Open Jaw Wrench Long Pattern 6x7 - 8x9 - 10x11 - 12x13 14x15 - 16x17 - 18x19 - 20x22 - 21x23 - 24x26	10	
0330	Kombine Anahtar Uzun Boy Combination Wrenches Long Pattern 6 - 7 - 8 - 9 - 10 - 11 - 12 - 13 - 14 - 17 - 19 - 22	12	96,73
0430	Yıldız Anahtar Ring Wrench 6x7 - 8x9 - 10x11 - 12x13 - 14x15 - 16x17 18x19 - 20x22	8	

2. Garaj Seri Çekmece/Drawer

Kod / Code 8242002072

KOD CODE	İÇERİK CONTENTS	☐	EURO
1113	1/2" Lokmalı Allen Uçlar Hexagonal Bits Socket H5-H6-H7-H8-H10-H12-H14	7	
1113	1/2" Lokmalı Star Uç / 1/2 Star Bits Socket T20-T25-T27-T30-T40-T45-T50-T55-T60	9	
0330	Kombine Anahtar Uzun Boy Combination Pliers Long 16-18 mm	2	
4900	Allen Takımı 6 Köşe / Hex Key Wrench Set 2-2.5-3-3.5-4-5-6-7-8-9-10-12	12	
1107	1/4" Karbüratör Lokma Takımı Socket Wrench Set 1/4" Cırcır Kolu Ratchet Handle 1/4" Mafsalsal Universal Joint 1/4" T Kol / Sliding T Handle 1/4" Ara Kol / Extension Bar 54 mm 1/4" Ara Kol Extension Bar 100 mm 1/4" Mafsalsal Kol Flexible Handle	18	288,25
1113	1/2" Lokma Takımı Socket Wrench Set 1/2" Cırcır Kolu 72 Diş Ratchet Handle (Max Gear) 1/2" Mafsalsal Universal Joint 1/2" T Kol Adaptör Sliding T Handle Adapter 1/2" Ara Kol Extension Bar 125 mm 1/2" Ara Kol Extension Bar 250 mm	24	

3. Garaj Seri Çekmece/Drawer

Kod / Code 8242003010

1



KOD CODE	İÇERİK CONTENTS	☐	EURO
3331	İç Eğri Segman Pense Circlip Pliers Internal (Bent) 170 mm	1	201,45
3321	İç Düz Segman Pense Circlip Pliers Internal (Flat) 180 mm	1	
3311	Dış Eğri Segman Pense Circlip Pliers External (Bent) 170 mm	1	
3301	Dış Düz Segman Pense Circlip Pliers External (Flat) 180 mm	1	
3700	Yan Keski Opak İzole Side Cutting Pliers 160 mm	1	
3220	Düz Kargaburun Opak İzole Nose Pliers (Flat) 200 mm	1	
3020	Kombine Pense Opak İzole Combination Pliers 180 mm	1	
2510	Special Ayarlı Pense / Universal Grip 250 mm	1	
0600	Kurbağacık Anahtar / Adjustable Wrench 10"	1	
2400	Üniversal Fort Pense / Waterpump Pliers Universal 240 mm	1	

4. Garaj Seri Çekmece/Drawer

Kod / Code 8242004018



KOD CODE	İÇERİK CONTENTS	☐	EURO
4300	Opak Seri Düz Uçlu Tornavida Screwdriver, Opak Flat 5x125-4x100-6x150-8x175	4	114,72
4320	Opak Seri Yıldız Uçlu Tornavida Screwdriver, Opak Phillips 4.5x80-6x100	2	
5800	Tesviyeci Çekiç Machinist's Hammer 300 gr	1	
5850	Plastik Çekiç Plastic Hammer ø30	1	
5545	Konik Pim Zimba Drift Punch 5 mm	1	
5550	Düz Pim Zimba Split Pin Punch 5 mm	1	
5540	Nokta Zimba Center Punch 5x120	1	
5500	Düz Keski Flat Cold Chisel 150 mm	1	
4920	T Tipi Allen Anahtar / Hex Key Wrench 3-4-5-6-7-8	6	

5. Garaj Seri Çekmece/Drawer

Kod / Code 8242005011



KOD CODE	İÇERİK CONTENTS	☐	EURO
07415	Sıralı Tel Fırça 3 Sıralı Hand Brush 3 Raws	1	93,04
6350	Levye Oluklu Tyre Lever, Straight 400 mm	1	
6220	Spiralli Mıknatıs Flexible Magnet Holder 500 gr	1	
4110	Düz Topaç Tornavida Screwdriver Stubby Flat 6.5x25	1	
4130	Yıldız Topaç Tornavida Screwdriver Stubby Phillips 6x25	1	
4770	Lokma Uçlu Tornavida Nut Spinner 6-7-8-9-10-13	6	

1



8235 PARTNER SERİSİ / PARTNER SERIES

1

Partner Mobil Takım Dolabı (5 Çekmeceli)
Partner Workshop Trolley (5 Drawers)



✓ Merkezi kilit.
● Central lock system



✓ %100 açılabilir, kendinden frenli teleskobik ray
● %100 extendable telescopic soft close slides



✓ 8 Bölmeli, sağlam ABS tabla
● 8 Durable ABS worktop with divisions



✓ 2 sabit, 2 hareketli frenli tekerlek ø 100mm
● 2 swivel castors with brake
2 fixed castors ø 100 mm





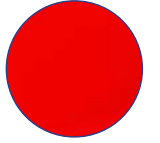



✓ Yüksek dayanımlı elektrostatik toz boya.
● High strength electrostatic powder coating



Ölçü/Size: 470x670x975 mm

Sacdan imal edilmiş, Fırın boya
Made of sheet metal, Electrostatic paint



KOD/CODE	ÇEKMECE DRAWERS	 35 kg	 45 kg		RENK COLORS	EURO
		350x550x75	400x550x180			
8235 32 6005	5	3X	2X	56		259,26
8235 32 5005	5	3X	2X	56		259,26
8235 32 7005	5	3X	2X	56		259,26
8235 00 6121 Dolu/Full 121 Parça/Pcs	5	3X	2X			828,20

1. Partner Seri Çekmece/Drawer

Kod / Code 8235001072

KOD CODE	İÇERİK CONTENTS	□	EURO
1107	<p>1/4" Karbüratör Lokma Takımı 1/4" Socket Wrench Set</p> <p>1/4" Cırcır kolu Ratchet Handle</p> <p>1/4" Mafsal Universal Joint</p> <p>4 - 5 - 6 7 - 8 - 9 - 10 11 - 12 - 13 Altı Köşe Six Points</p> <p>8 - 10 Sekiz Köşe Eight Points</p>	18	
1113	<p>1/4" Mafsalı Kol Flexible Handle</p> <p>1/2" Lokma Takımı 1/2" Socket Set</p> <p>1/2" Cırcır Kolu 32 Diş Ratchet Handle</p> <p>1/2" Mafsal Universal Joint</p> <p>10 - 11 - 12 - 13 14 - 15 16 - 17 - 18 19 - 21 - 22 23 - 24 - 26 - 27 - 28 30 - 32</p> <p>1/2" T Kol Adaptör Sliding T Handle Adapter</p> <p>1/2" Ara Kol Extention Bar 125 mm</p> <p>1/2" Ara Kol Extention Bar 250 mm</p>	24	320,56
1507	<p>1/4" Derin Lokma Tornavida Adaptörü Spindle Handle</p>	1	
4900	<p>12 'li Allen Anahtar Takımı Hex Key Wrench Set 2-2.5-3-3.5-4-5-6-7-8-9-10-12 mm</p>	12	
4910	<p>8 'li Torx Allen Anahtar Takımı Torx Key Wrench 6 Point T9-T10-T15-T20-T27-T25-T30-T40</p>	8	
1108	<p>1/2" Altı Köşe Derin Lokma Deep Socket Wrench 6 Point 10-13-16-17-18-19 mm</p>	6	
1113	<p>1/2" 16 mm Buji Lokma Anahtar Spark Plug Socket With Rubber</p>	1	
2400	<p>240 mm Üniversal Fort Pense Waterpump Pliers, Universal</p>	1	
2500	<p>250 mm Üniversal Ayarlı Pense Universal Grip</p>	1	



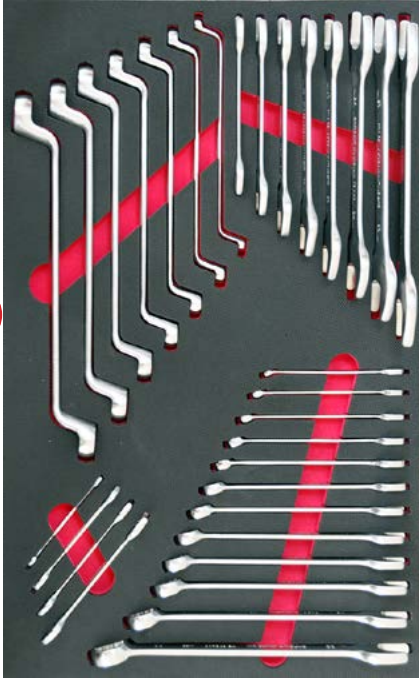

2. Partner Seri Çekmece/Drawer

Kod / Code 8235002031

KOD CODE	İÇERİK CONTENTS		EURO
0100	İki Ağız Anahtar Kısa Boy Double Ended Open Jaw Wrench Short Pattern 6x7 - 8x9 - 10x11 - 12x13 14x15 - 16x17 - 18x19 - 20x22 21x23 - 24x26 - 25x28 - 30x32	12	
0320	Kombine Anahtar Kısa Boy Combination Wrench Short Pattern 8 - 9 - 10 - 11 - 12 - 13 14 - 15 - 16 - 17 - 19 - 22	12	101,81
0430	Yıldız Anahtar Ring Wrench 8x9 - 10x11 - 12x13 - 14x15 - 16x17 18x19 - 20x22	7	



3. Partner Seri Çekmece/Drawer

Kod / Code 8235003017

KOD CODE	İÇERİK CONTENTS		EURO
4300	Opak Seri Düz Uçlu Tornavida Screwdriver, Opak Flat 3x80-4x80-4x100-5x125-6x150	5	
4320	Opak Seri Yıldız Uçlu Tornavida Screwdriver, Opak Phillips 4.5x80-6x100	2	
3700	Yan Keski Opak İzole Side Cutting Pliers 160 mm	1	
3020	Kombine Pense Opak İzole Combination Pliers 180 mm	1	145,97
3220	Düz Kargaburun Opak İzole Nose Pliers Flat 200 mm	1	
4770	Lokma Uçlu Tornavida Nut Spinner 6-7-8-10-13	5	
5500	Düz Keski Flat Cold Chisel 150 mm	1	
5800	Tesviyeci Çekiçi Machinist's Hammer 500 gr	1	



8243 EKO SERİSİ / ECO SERIES

1

Eko Serisi Takım Dolabı (5-7 Çekmeceli) Eco Series Workshop Trolley (5-7 Drawers)



✓ 4 bölmeli sağlam ve dayanıklı
ABS plastik üst malzeme tabla.
● Resistant and solid
top cover with 4 divisions

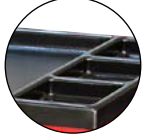

✓ %100 açılabilir teleskobik raylar.
● %100 extendable telescopic slides



✓ Merkezi kilit
● Central locking



✓ 2 sabit, 2 hareketli
frenli tekerlek ø 100 mm
● 2 swivel castors with brake
2 fixed castors ø 100 mm



✓ Yüksek dayanımlı elektrostatik toz boya.
● High strength electrostatic powder coating

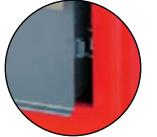

✓ Elokсалlı alüminyum tutma çantası.
● Handle with anodised aluminum

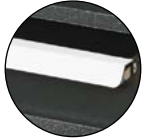

Sacdan imal edilmiş, Fırın boya
Made of sheet metal, Electrostatic paint

Ölçü/Size: 405x613x894 mm



RAL 7016
RAL 3020



RAL 7016
RAL 5003



RAL 7035
RAL 7016

KOD/CODE	ÇEKMECE DRAWERS	35 kg	45 kg	Kg	RENK COLORS	EURO
		350x503x82	400x503x176			
8243 32 1005	5	3X	2X	43	RAL 7016 RAL 3020	210,92
8243 32 1007	7	7X	--	43		236,76
8243 32 2005	5	3X	2X	43	RAL 7016 RAL 5003	210,92
8243 32 2007	7	7X	--	43		236,76
8243 32 3005	5	3X	2X	43	RAL 7035 RAL 7016	210,92
8243 32 3007	7	7X	--	43		236,76
8243 00 1096 Dolu/Full 96 Parça/Pcs	5	3X	2X			662,39
8243 00 7096 Dolu/Full 96 Parça/Pcs	7	3x	--			688,19

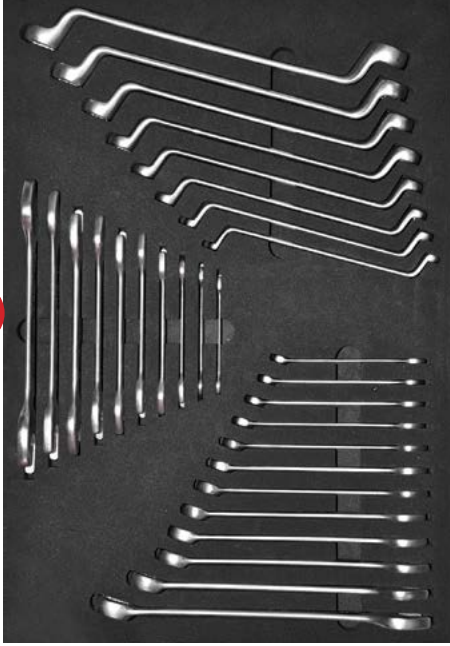

1

1. Eko Seri Çekmece/Drawer

Kod / Code 8243001030

KOD/CODE	İÇERİK CONTENTS	□	EURO
0100	İki Ağız Anahtar Kısa Boy D/E Open Jaw Wrench Short Pattern 6x7 - 8x9 - 10x11 - 12x13 14x15 - 16x17 - 18x19 - 20x22 - 21x23 - 24x26	10	93,95
0320	Kombine Anahtar Kısa Boy Combination Wrench Short Pattern 8 - 9 - 10 - 11 - 12 - 13 - 14 - 15 - 16 - 17 - 19 - 22	12	
0430	Yıldız Anahtar Ring Wrench 6x7 - 8x9 - 10x11 - 12x13 - 14x15 - 16x17 18x19 - 20x22	8	

1



2

2. Eko Seri Çekmece/Drawer

Kod / Code 8243002052

KOD/CODE	İÇERİK CONTENTS	□	EURO
1113	1113 1/2" 17'li Lokma Takımı Socket Wrench Set 1/2" mm 10 - 11 - 12 - 13 - 14 - 15 - 17 - 19 22 - 24 - 27 - 30 - 32 250 - 250 - 70 1/2" T Kol Adaptör/Sliding T Handle Adapter	17	227,33
1107	Karbüratör Lokma Takımı Socket Wrench Set 1/4" mm 4 - 5 - 6 - 7 - 8 - 9 - 10 - 11 - 12 - 13 Sekiz köşe / Eight points 8 - 10 140 - 115 - 100 - 50 - 38 - 130	18	
4900	Allen Anahtar Takımı Hex Key Wrench Set 2 - 2.5 - 3 - 3.5 - 4 - 5 - 6 - 7 - 8 - 9 - 10 - 12	12	
4770	Lokma Uçlu Tornavidalar Nutspinners 6 - 7 - 8 - 10 - 13	5	



3

3. Eko Seri Çekmece/Drawer

Kod / Code 8243003013

KOD/CODE	İÇERİK CONTENTS	□	EURO
4320	Opak Yıldız Uçlu Tornavida Opak Screwdriver, Phillips 4,5x80-6x100 mm	2	129,59
4300	Opak Düz Uçlu Tornavida Opak Screwdriver, Flat 5x125-4x100-6x150-8x175 mm	4	
3700	Yan Keski Opak Side Cutting Pliers 160 mm	1	
3020	Kombine Pense Opak Combination Pliers 180 mm	1	
3220	Kargaburun Düz Uçlu Opak Nose Pliers, Flat 160 mm	1	
5500	Düz Keski Krom Flat Cold Chisel 150 mm	1	
5800	Tesviyecici Çekici Machinist's Hammer 300 gr	1	
2510	Spesiyel Ayarlı Pense / Waterpump Pliers Special 250 mm	1	
2400	Üniversal Fort Pense PVC / Universal Grip 240 mm	1	

1

Trend Serisi Takım Dolabı (5-7 Çekmeceli)
Trend Series Workshop Trolley (5-7 Drawers)



✓ 4 bölmeli sağlam ve dayanıklı ABS plastik üst malzeme tabla.
● Resistant and solid top cover with 4 divisions

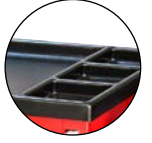

✓ %100 açılabilir teleskobik raylar.
● %100 extendable telescopic slides



✓ Merkezi kilit
● Central locking

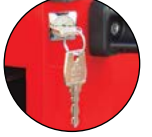

✓ 2 sabit, 2 hareketli frenli tekerlek ø 100 mm
● 2 swivel castors with brake
2 fixed castors ø 100 mm



✓ Yüksek dayanımlı elektrostatik toz boya
● High strength electrostatic powder coating







✓ Kendiliğinden açılmayı engelleyen plastik kilit
● Plastic lock preventing self opening



Ölçü/Size: 405x613x894 mm



Sacdan imal edilmiş, Fırın boya
Made of sheet metal, Electrostatic paint

KOD/CODE	ÇEKMECE DRAWERS	 350x503x82	 400x503x176	 Kg	RENK COLORS	EURO
8244 32 1005	5	3X	2X	43		189,00
8244 32 1007	7	7X	--	43		233,00
8244 00 5096 Dolu/Full 96 Parça/Pcs	5	3X	2X			623,71
8244 00 7096 Dolu/Full 96 Parça/Pcs	7	7X	--			667,71

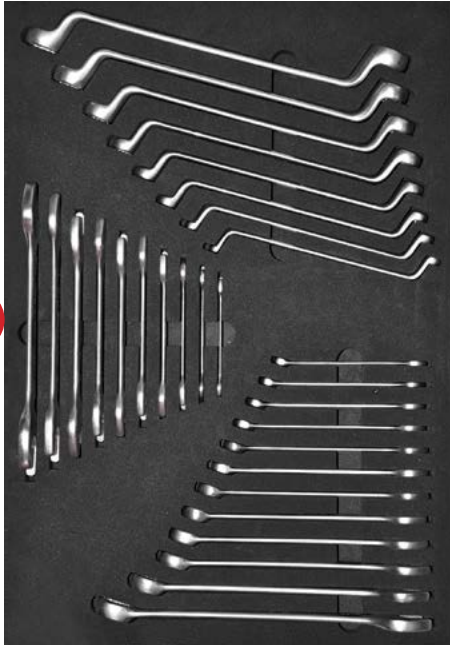

1

1. Trend Seri Çekmece/Drawer Kod / Code 8244001030

KOD/CODE	İÇERİK CONTENTS	□	EURO
0100	İki Ağız Anahtar Kısa Boy D/E Open Jaw Wrench Short Pattern 6x7 - 8x9 - 10x11 - 12x13 14x15 - 16x17 - 18x19 - 20x22 - 21x23 - 24x26	10	93,95
0320	Kombine Anahtar Kısa Boy Combination Wrench Short Pattern 8 - 9 - 10 - 11 - 12 - 13 - 14 - 15 - 16 - 17 - 19 - 22	12	
0430	Yıldız Anahtar Ring Wrench 6x7 - 8x9 - 10x11 - 12x13 - 14x15 - 16x17 18x19 - 20x22	8	

1



2

2. Trend Seri Çekmece/Drawer Kod / Code 8244002052

KOD/CODE	İÇERİK CONTENTS	□	EURO
1113	1/2" 17'li Lokma Takımı Socket Wrench Set 1/2" mm 10 - 11 - 12 - 13 - 14 - 15 - 17 - 19 22 - 24 - 27 - 30 - 32 250 - 250 - 70 1/2" T Kol Adaptör/Sliding T Handle Adapter	17	210,57
1107	1/4" Karbüratör Lokma Takımı Socket Wrench Set 1/4" mm 4 - 5 - 6 - 7 - 8 - 9 - 10 - 11 - 12 - 13 Sekiz köşe / Eight points 8 - 10 140 - 115 - 100 - 50 - 38 - 130	18	
4900	Allen Anahtar Takımı Hex Key Wrench Set 2 - 2.5 - 3 - 3.5 - 4 - 5 - 6 - 7 - 8 - 9 - 10 - 12	12	
4770	Lokma Uçlu Tornavidalar Nutspinners 6 - 7 - 8 - 10 - 13	5	



3

3. Trend Seri Çekmece/Drawer Kod / Code 8244003013

KOD/CODE	İÇERİK CONTENTS	□	EURO
4320	Opak Yıldız Uçlu Tornavida Opak Screwdriver, Phillips 4.5x80-6x100 mm	2	129,59
4300	Opak Düz Uçlu Tornavida Opak Screwdriver, Flat 5x125-4x100-6x150-8x175 mm	4	
3700	Yan Keski Opak Side Cutting Pliers 160 mm	1	
3020	Kombine Pense Opak Combination Pliers 180 mm	1	
3220	Kargaburun Düz Uçlu Opak Nose Pliers, Flat 160 mm	1	
5500	Düz Keski Krom Flat Cold Chisel 150 mm	1	
5800	Tesviyecı Çekici Machinist Hammer 300 gr	1	
2510	Special Ayarlı Pense / Waterpump Pliers Special 250 mm	1	
2400	Üniversal Fort Pense PVC / Üniversal Grip 240 mm	1	

1

Vagon Serisi Takım Dolabı
Wagon Series Workshop Trolley



- ✓ 8 Bölmeli, sağlam ABS tabla
- Durable ABS worktop with divisions



- ✓ Kilit T kol
- Locked T-handle



- ✓ 2 Sabit, 2 hareketli frenli tekerlek ø 125mm
- 2 swivel castors with brake 2 fixed castors ø 125 mm



- ✓ Yüksek dayanımlı elektrostatik toz boya.
- High strength electrostatic powder coating

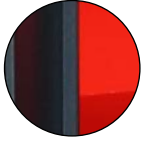

- ✓ 2X ayarlanabilir raf (10 adet seperatör ile)
- 2x adaptable shelves with separator 10 pcs



- ✓ Standard tutma sapı
- Standard handle



- ✓ 2X avadanlık
- 2X tin holder

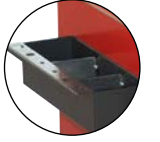

RAL 7016
RAL 3020

Ölçü/Size: 470x670x970 mm

Sacdan imal edilmiş, Fırın boya
Made of sheet metal, Electrostatic paint

KOD/CODE	Ölçü / SIZE (mm)	KG	RENK COLORS	FİYAT TL/AD
----------	------------------	----	-------------	-------------

8210 32 6001

470x670x1020

45

RAL 7016
RAL 3020

232,54

8160 TAKIM DOLABI / TOOL CABINET

Takım Dolabı
Tool Cabinet



Ölçü/Size: 250x650x1010 mm

Sacdan imal edilmiş, Fırın boya
Made of sheet metal, Electrostatic paint

✓ Kilit T kol
● Locked T-handle



✓ %100 açılabilir teleskobik raylar.
● %100 extendable telescopic slides



✓ 2 hareketli frenli tekerlek ø 50mm
● 2 swivel castors with brake ø 50 mm



✓ Yüksek dayanımlı elektrostatik toz boya.
● High strength electrostatic powder coating



✓ Avadanlık x2
● Bottle and tins holder x2



✓ Askılık x4
● Hanger x4



✓ Özel askılık x4
● Special hanger x4



✓ Anahtar askısı x1
● Hanger for wrenches x1



✓ Özel avadanlık x1
● Special tin holder x1



✓ Matkap ucu tutucu x1
● Drill bits holder x1



RAL 7016
RAL 3020

KOD/CODE	 200x500x55	Ölçü / SIZE (mm)	 KG	COLORS	FİYAT EURO
----------	--	------------------	--	--------	------------

8160 32 6001

3x

250x650x1010

35

RAL 7016
RAL 3020

298,98

8550

1

Demonte Mini Servis Arabası
Disassembled Mini Service Trolley



- **3X Kauçuk Kaydırmaz Mat**
3X Rubber Anti Slipping Mats
- **2X Sabit, 2X Hareketli Frenli Tekerlek (ø 100 mm)**
2X Fixed, 2X Swivel Castors with Brake (ø 100 mm)
- **Sağlam sac metal yapı, Her raf 50 Kg taşır.**
Robust sheet-steel construction, Loading capacity per shelf 50 Kg

Çelik konstrüksiyon
Steel construction

KOD/CODE	 420x590x57	Ölçü / SIZE (mm)	 KG	COLORS	FIYAT EURO
----------	---	------------------	---	--------	------------

8550 34 8001

3x

424x677x822

18

RAL 9005
RAL 3020

151,26

8550

Demonte Mini Servis Arabası (kapalı)
Disassembled Mini Service Trolley (closed)



- **3X Kauçuk Kaydırmaz Mat**
3X Rubber Anti Slipping Mats
- **2X Sabit, 2X Hareketli Frenli Tekerlek (ø 100 mm)**
2X Fixed, 2X Swivel Castors with Brake (ø 100 mm)
- **Sağlam sac metal yapı, Her raf 50 Kg taşır.**
Robust sheet-steel construction, Loading capacity per shelf 50 Kg
- **Arabanın yanları ve arkasında kare askı delikleri**
Square-shaped perforation on the side panels and back panel offers individual fastening

Çelik konstrüksiyon
Steel construction

KOD/CODE	 420x590x57	Ölçü / SIZE (mm)	 KG	COLORS	FIYAT EURO
----------	---	------------------	---	--------	------------

8550 34 8002

3x

424x677x822

23

RAL 9005
RAL 3020

202,22

8545

Taşıma Arabası
Platform Wagon



- **18mm Plywood Tabla (Kauçuk Mat ile Birlikte)**
18mm PLYWOOD table (with rubber mat)
- **2X Sabit, 2X Hareketli Frenli Tekerlek (ø 200mm)**
2X Fixed, 2X Swivel Castors with Brake (ø 200mm)
- **Sağlam sac metal yapı, Her raf 540 Kg taşır.**
Robust sheet-steel construction, Loading capacity per shelf 540 Kg

Çelik konstrüksiyon
Steel construction

KOD/CODE	Ölçü / SIZE (mm)	KG	COLORS	FİYAT EURO
----------	------------------	----	--------	------------

8545 34 1005

600x1145x1104

38

RAL 9005

250,00

8550

Servis Arabası (Büyük Boy)
Service Trolley (Large Size)



- **3X Kauçuk Kaydırmaz Mat**
3X Rubber Anti Slipping Mats
- **2X Sabit, 2X Hareketli Frenli Tekerlek (ø 125 mm)**
2X Fixed, 2X Swivel Castors with Brake (ø 125 mm)
- **Sağlam sac metal yapı, Her raf 75 Kg taşır.**
Robust sheet-steel construction, Loading capacity per shelf 75 Kg

Çelik konstrüksiyon
Steel construction

KOD/CODE	Ölçü / SIZE (mm)	KG	COLORS	FİYAT EURO
----------	------------------	----	--------	------------

8550 34 6001

3x

500x850x935

37

RAL 3020

157,10

8500

1

Servis Masası (Panolu)
Work Bench (With Panel)



- **Merkezi kilit sistemi, mandal sistemi**
Central locking system, handgrip lock system
- **Kaynaklı sağlam tasarım**
Robust welded design
- **%100 Açılabilir teleskobik raylar**
100% extendable telescopic slides
- **Yüksek dayanımlı elektrostatik toz boya.**
High strength electrostatic powder paint
- **Delikli panel (220 V prizler ile).**
Perforated panel with electrical plugs 220 V

Çelik Konstrüksiyon ve zor koşullarda çalışmaya elverişli
Özel Plywood ahşap tezgah
Strong and durable steel construction and
Plywood bench

KOD/CODE		Ölçü / SIZE (mm)	 KG	COLORS	FİYAT EURO
	348x548x90				

8500 34 6001

3x

720x1680x1495

102



844,00

8501

Servis Masası (Panosuz)
Work Bench (Without Panel)



- **Merkezi kilit sistemi, mandal sistemi**
Central locking system, handgrip lock system
- **Kaynaklı sağlam tasarım**
Robust welded design
- **%100 Açılabilir teleskobik raylar**
100% extendable telescopic slides
- **Yüksek dayanımlı elektrostatik toz boya.**
High strength electrostatic powder paint

Çelik konstrüksiyon ve zor koşullarda çalışmaya elverişli
Özel Plywood ahşap tezgah
Strong and durable steel construction and Plywood bench

KOD/CODE		Ölçü / SIZE (mm)	 KG	COLORS	FİYAT EURO
	348x548x90				

8501 34 6001

3x

700x1680x900

84



561,20

8502

1

Demonte Servis Masası
Disassembled Work Bench



- **Demonte sağlam tasarım**
Robust disassembled design
- **18mm Plywood Tabla (Kauçuk mat ile birlikte)**
18mm Plywood Bench with non-slip rubber insert
- **Ayarlanabilir ayaklar**
Height adjustable feet
- **İZELTAS Eco ve/veya Trend Dolaplar ile kombine kullanabilme imkanı**
Can be combined with IZELTAS Eco and Trend Trolley

Çelik konstrüksiyon
Steel construction

KOD/CODE		Ölçü / SIZE (mm)	 KG	COLORS	FİYAT EURO
	200x500x55				

8502 34 6001

3x

710x1692x1002

35

RAL 3020

314,66

Çekmeceli Alet Sandığı
Tool Chest With Drawers



285x650x322





285x550x322



285x450x322



KOD/CODE	Ölçü / SIZE (mm)	ÇEKMECE DRAWERS				EURO
8320 33 1003	285x650x322	3x	2x	1x	20	213,34
8320 33 1002	285x550x322	3x	2x	1x	18	211,12
8320 33 1001	285x450x322	3x	2x	1x	16	208,90

8420

Takım Çantası (5 Gözlü)
Tool Box (5 Trays)

1

195x300x210

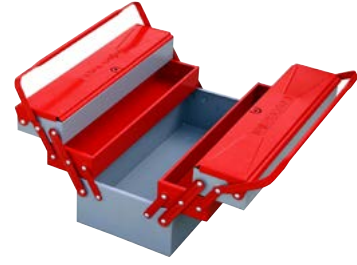
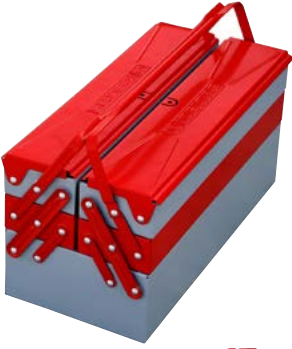

195x420x210

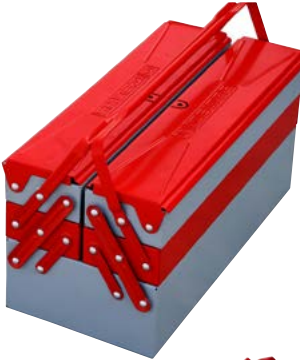

195x520x210

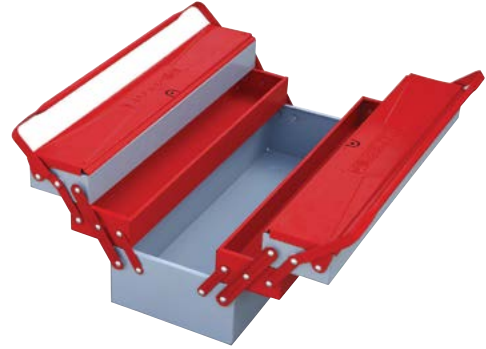
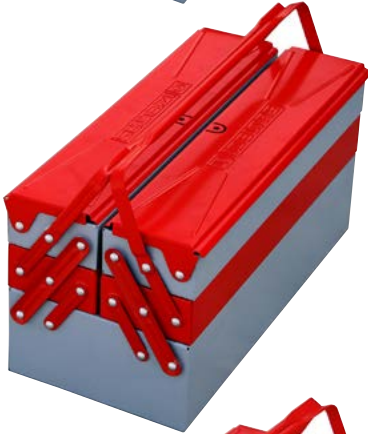

195x600x210

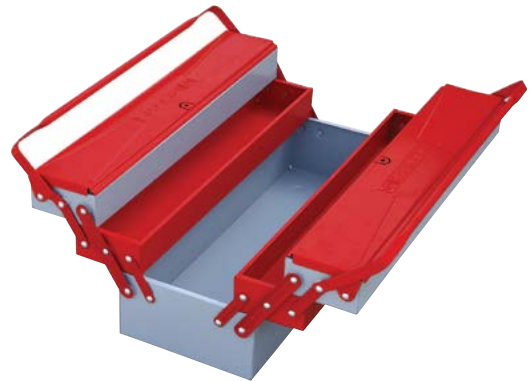
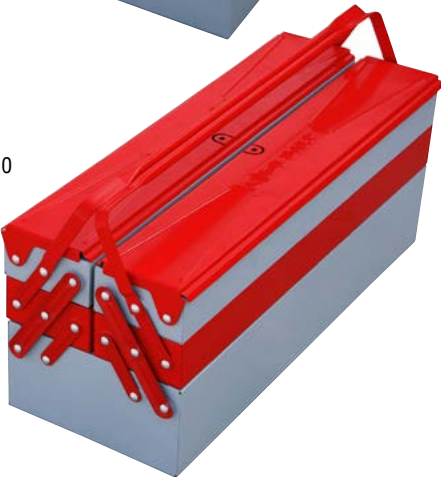

Sacdan imal edilmiş, Fırın boya
Made from metal sheet, Electrostatic paint

KOD CODE	Ölçü / SIZE (mm)	g	1	EURO
8420 33 6105	195x300x210	3200	1	27,46
8420 33 6205	195x420x210	4200	1	30,26
8420 33 6305	195x520x210	5000	1	39,36
8420 33 6405	195x600x210	5600	1	42,64

8420

1

Takım Çantası (5 Gözlü)
Tool Box (5 Trays)



8420 00 5063

Mekanik Takım Çantası (62 Parça, 5 Gözlü)
Tool Box for Mechanician (62 Pcs, 5 Trays)



8420 00 5046

Elektrikçi Takım Çantası (45 Parça, 5 Gözlü)
Tool Box for Electrician (45 Pcs, 5 Trays)



8420 00 5028

Tesisatçı Takım Çantası (28 Parça, 5 Gözlü)
Tool Box for Plumbers (28 Pcs, 5 Trays)



8420 00 5063
Mekanikçi Takım Çantası (5 Gözlü)
Tool Box for Mechanician (5 Trays)

KOD CODE	ÖLÇÜ SIZE mm	□	EURO
8420 00 5063	190x420x200 DOLU / FULL	62	240,59

KOD CODE	İÇERİK CONTENTS	□
05881 50 015	5 m Krom Şerit Metre Chrom Case Steel, Measuring tapes	1
4785 19 6330	6.3x30 Kısa Bits Tutucu Tornavida Screwdriver, Magnetic Bit Holder (Short)	1
4800 00 8110	10 'Lu Bits Takım Bits Set 10 (Pcs) 25 mm	1
4320	Yıldız Uçlu Tornavida Opak Seri Screwdriver, Opak, Flat 4.5x80-6x100	2
4300	Düz Uçlu Tornavida Opak Seri Screwdriver, Opak, Philips 3x80-4x100-5x125-6x150	4
4550 17 0135	135mm Kontrol Kalem Voltage Tester	1
2400 11 0240	240mm Üniversal Fort Pense Water Pump Pliers Universal	1
1113	1/2" Lokma Anahtar Socket Wrench 10-11-12-13-14-15-17 19-22-24-27-30-32 mm	13
1513 06 4250	1/2" Uzun Ara Kol Extension Bar Long 250 mm	1
1513 06 4070	1/2" Mafsalsal Universal Joint 70 mm	1
1513 06 0032	1/2" Cırcır Kol 32 Dişli Ratchet Handle 250 mm	1
4900 00 3112	12 'Li Allen Takım Hex Key Wrench Set	1
0320	Kısa Kombine Anahtar Combination Wrench Short Pattern 8-9-10-11-12-13 14-17-19-22 mm	10
3700 16 2160	160mm Opak İzole Yan Keski Side Cutting Nippers, Opak insulated	1
3020 12 2180	180mm Opak İzole Kombine Pense Combination Pliers, Opak Insulated	1
3220 13 2160	160mm Opak İzole Düz Kargaburun Nose Pliers, Flat, Opak Insulated	1

8420 00 5046
Elektrikçi Takım Çantası (5 Gözlü)
Tool Box for Electrician (5 Trays)

KOD CODE	ÖLÇÜ SIZE mm	□	EURO
8420 00 5046	190x420x200 DOLU / FULL	45	244,72

KOD CODE	İÇERİK CONTENTS	□
05881 50 005	5m Plastik Şerit Metre Plastic Measuring Tape	1
4783 19 6120	1000V İzoleli Manyetik Bits Tutucu Tornavida Screwdriver, Magnetic Bit Holder Insulated 6.3x120	1
4800 00 8106	6 'Li Bits Takım Bits Set (6 Pcs)	1
0600 01 1010	10" Kurbağcık Anahtar Adjustable Jaw Wrench, PVC Insulated	1
4140-4145	1000V İzoleli Elektrikçi Düz Yıldız Tornavida Insulated Electrician type Flat Screwdriver, Phillips 1000V 4x100-5.5x125 - 4.5x80-6x100	4
4550 17 0135	135mm Kontrol Kalem Voltage Tester	1
4550 17 0190	190mm Kontrol Kalem Voltage Tester	1
4773	1000V Süngüsü İzoleli Lokma Uçlu Tornavida Nut Spinner, Electrician Blade Insulated 1000V 6-7-8-10-13 mm	5
0340	Cırcır Kombine Anahtar Combination Wrench With Ratchet 8-10-12-13-17-19 mm	6
4900 00 3110	10 'Lu Allen Anahtar Takımı (mm) Hex Key Wrench Set 10 pcs	1
4500-4520	Klemens Tornavida Screwdriver, Electronic 3x80-3x100-3x125-3x60-4x80	5
3700 16 6160	1000V İzoleli Elektrikçi 160mm Yan Keski Insulated Electrician Type Side Cutter 1000V	1
3020 12 6180	1000V İzoleli Elektrikçi 180mm Kombine Pense Insulated Electrician Type Combination Plier 1000V	1
3220 13 6160	1000V İzoleli Elektrikçi 160mm Kargaburun Insulated Electrician Type Nose Plier 1000V	1

8420 00 5028
Tesisatçı Takım Çantası (5 Gözlü)
Tool Box for Plumbers (5 Trays)

KOD CODE	ÖLÇÜ SIZE mm	□	EURO
8420 00 5028	190x420x200 DOLU / FULL	28	219,45

KOD CODE	İÇERİK CONTENTS	□
0600 01 1010	10" Kurbağcık Anahtar 10" Adjustable Jaw Wrench, PVC Insulated	1
0600 01 1012	12" Kurbağcık Anahtar 12" Adjustable Jaw Wrench, PVC Insulated	1
2400 11 0240	240 Üniversal Fort Pense 240 Waterpump Pliers, Universal	1
2100 10 0012	12" Stilson Boru Anahtarı 12" Pipe Wrench, Stillson	1
4901 22 1270	1/2" Sae Allen Anahtar 1/2" Hex Key Wrench SAE	1
4300 17 6150	Düz Uçlu Tornavida Opak Seri Screwdriver, Opak, Slotted 6x150 mm	1
4320 18 6100	Yıldız Uçlu Tornavida Opak Seri Screwdriver, Opak, Phillips 6x100 mm	1
5800 25 0500	500gr Çekiç / Machinist Hammer	1
5500 23 0200	200mm Beton Keski / Flat Cold Chisel	1
3830 15 0250	250mm Betoncu Kerpeten Tower Pincers	1
4900 00 3112	12 'Li Allen Anahtar Takımı (mm) Hex Key Wrench Set 12 pcs	1
0588 15 0015	5m Krom Şerit Metre Chrom Case Steel Measuring Tape	1
2201 10 0010	1" Maşalı Boru Anahtarı 1" Pipe Wrench	1
3700 16 2160	160mm Opak İzole Yan Keski Side Cutting Nippers, Opak insulated	1
3020 12 2180	180mm Opak İzole Kombine Pense Combination Pliers, Opak Insulated	1
3220 13 2160	160mm Opak İzole Düz Kargaburun Nose Pliers, Flat, Opak Insulated	1

8440

1

Plastik Takım Çantaları
Plastic Tool Boxes



22"



16"-19"

KOD CODE	inch	ÖLÇÜ SIZE mm	g	□	EURO
8440 33 1016	16"	413x212x186	1207	4	8,32
8440 33 1019	19"	480x267x242	1922	4	11,38
8440 33 1022	22"	564x310x310	2870	4	19,84



8705 00 6113

Hobby Set Oto Tipi (13 Parça)
Hobby Set Auto Type (13 pcs)



KOD CODE	İÇERİK CONTENTS	□	EURO
0100	İki Ağız Anahtar (Kısa Boy) Duble Ended Open Jaw Wrench Short Pattern 8x9-10x11-12x13-14x15-16x17-18x19	6	70,78
1841	21 mm Kovan Anahtar Bir Ağız Single Ended Tubular Socket Wench	1	
2400	240 mm Ünlversal Fort Pense Waterpump Pliers Universal	1	
3020	160 mm Kombine Pense Opak Combination Pliers	1	
4240	Değişken Uçlu Tornavida Takımı Screwdriver Set Reversible 4.5x80 - 6x80	1	
5800	200 gr Tesviyeci Çekiç / Machinist Hammer	1	
6350	300 mm Levye Oluklu / Tyre Lever Straight	1	

8790 00 8106

Bakım Onarım Seti (5 Parça)
Maintenance Set (5 Pcs)



KOD CODE	İÇERİK CONTENTS	□	EURO
3020 12 3160	160 mm Kombine Pense Kraft Combination Pliers	1	65,83
3220 13 3160	160 mm Kargaburun Düz Uçlu Kraft Nose Pliers Flat	1	
3700 16 3140	140 mm Yan Keski Kraft Side Cutting Pliers	1	
4100 17 5100	5x100 Kraft Seri Düz Uçlu Tornavida Screwdriver Kraft, Flat	1	
4120 18 4580	4.5x80 Kraft Seri Yıldız Uçlu Tornavida Screwdriver Kraft, Phillips	1	



Anahtar İşleme Aşamaları / Manufacturing steps



2

Anahtarlar Wrenches



- | | |
|------------------------------|-----------------------------|
| <i>İki Ağız Anahtarlar</i> | <i>Open Jaw Wrenches</i> |
| <i>Kombine Anahtarlar</i> | <i>Combination Wrenches</i> |
| <i>Yıldız Anahtarlar</i> | <i>Ring Wrenches</i> |
| <i>Çakma Anahtarlar</i> | <i>Slugging Wrenches</i> |
| <i>Kurbağacık Anahtarlar</i> | <i>Adjustable Wrenches</i> |

★ Fiyat belirtilmeyen ebatlar için miktar belirterek fiyat talep ediniz.

İki Ağız Anahtar Kısa Boy (mm)
Double Ended Open Jaw Wrench Short Pattern (mm)

TS
TS 81-6
DIN 895

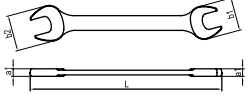

Krom vanadyum, Krom kaplı
Chrom vanadium, Chrom plated

KOD CODE	mm	L mm	a1 mm	b1 mm	b2 mm	g	□	EURO
0100 01 0405	4x5	97	3.5	11	12.5	15	10	1,05
0100 01 0607	6x7	97	3.5	14	16	18	10	1,07
0100 01 0809	8x9	108	4	18	20	30	10	1,25
0100 01 0810	8x10	117	4.6	18	22	33	10	1,35
0100 01 1011	10x11	120	4.6	22	24	41	10	1,45
0100 01 1012	10x12	120	4.6	22	26	35	10	1,47
0100 01 1013	10x13	120	4.6	22	28	38	10	1,49
0100 01 1114	11x14	133	5.2	26	28	50	10	1,52
0100 01 1213	12x13	133	5.2	26	28	57	10	1,59
0100 01 1214	12x14	147	5.2	26	30	59	10	1,89
0100 01 1314	13x14	147	5.2	28	30	66	10	1,89
0100 01 1415	14x15	147	5.8	30	32	78	10	2,17
0100 01 1317	13x17	162	6.2	28	36	80	10	2,21
0100 01 1417	14x17	162	6.2	30	36	90	10	2,26
0100 01 1617	16x17	162	6.2	34	36	109	10	2,45
0100 01 1719	17x19	178	7	36	40	143	10	2,51
0100 01 1819	18x19	178	7	38	40	144	10	2,87
0100 01 1820	18x20	178	7	38	40	125	10	3,23
0100 01 1822	18x22	195	7.4	38	46	160	10	3,23
0100 01 1922	19x22	195	7.4	40	46	175	10	2,98
0100 01 2022	20x22	195	7.4	42	46	196	10	3,34
0100 01 2123	21x23	213	7.7	44	48	230	10	3,45
0100 01 2224	22x24	213	8	46	50	239	10	3,54
0100 01 2426	24x26	232	8.2	50	54	297	10	3,76
0100 01 2427	24x27	232	8.2	50	56	296	10	4,06
0100 01 2528	25x28	248	8.6	52	57.5	366	10	4,61
0100 01 2732	27x32	265	9	56	66	415	10	5,51
0100 01 3032	30x32	265	9	62	66	465	10	5,51

SPECIAL SERIES (ASK FOR QUOTATION SEPARATELY)

0100 01 0608	6x8	97	3.5	14	18	20	10	
0100 01 0708	7x8	108	3.5	16	18	20	10	
0100 01 0709	7x9	108	4	16	20	25	10	
0100 01 0910	9x10	117	4.6	20	22	30	10	
0100 01 0911	9x11	120	4.6	20	24	30	10	
0100 01 1014	10x14	120	5.2	22	30	50	10	
0100 01 1113	11x13	133	5.2	26	28	50	10	
0100 01 1315	13x15	147	5.8	28	32	65	10	
0100 01 1722	17x22	195	7.4	36	46	160	10	
0100 01 1924	19x24	213	7.7	40	50	200	10	
0100 01 2226	22x26	232	8	46	54	250	10	
0100 01 2227	22x27	232	8.2	46	56	260	10	
0100 01 2430	24x30	265	9	50	62	370	10	
0100 01 2730	27x30	265	9	56	62	380	10	

0100

İki Ağız Anahtar Takımı Kısa Boy (mm)
Double Ended Open Jaw Wrench
Short Pattern Set (mm)

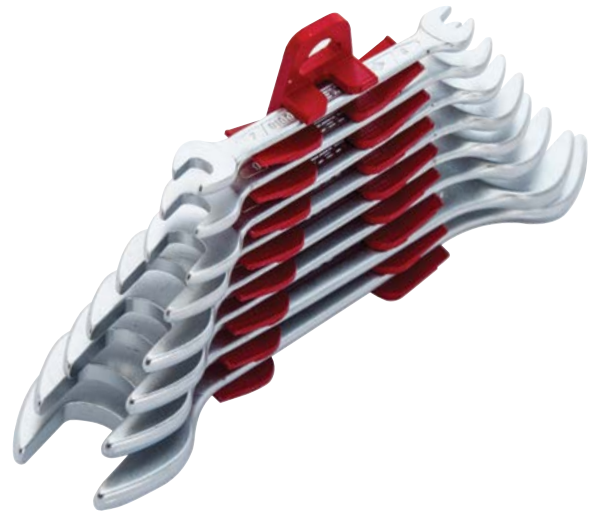

KOD CODE	İÇERİK CONTENTS	g	□	EURO
0100 00 2108	6x7 - 8x9 - 10x11 12x13 - 14x15 - 16x17 18x19 - 20x22	736	8	18,53
0100 00 2112	6x7 - 8x9 - 10x11 12x13 - 14x15 - 16x17 18x19 - 20x22 - 21x23 24x26 - 25x28 - 30x32	2110	12	39,32

0130

İki Ağız Anahtar Uzun Boy (mm)

Double Ended Open Jaw Wrench Long Pattern (mm)

TS ISO 10102
DIN 3110

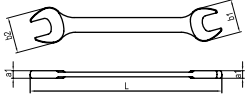

Krom vanadyum, Krom kaplı
Chrom vanadium, Chrom plated

KOD CODE	mm	L mm	a1 mm	b1 mm	b2 mm	g		EURO
0130 01 0607	6x7	125	3.5	14	16	24	10	1,22
0130 01 0608	6x8	125	3.5	14	18	20	10	---
0130 01 0809	8x9	140	4	18	20	35	10	1,42
0130 01 0810	8x10	140	4	18	22	36	10	1,49
0130 01 1011	10x11	155	4.5	22	24	47	10	1,59
0130 01 1012	10x12	162	4.7	22	26	57	10	1,60
0130 01 1013	10x13	162	4.7	22	28	61	10	1,61
0130 01 1014	10x14	162	4.7	22	28	65	10	1,67
0130 01 1113	11x13	172	5	26	28	70	10	---
0130 01 1114	11x14	172	5	26	30	65	10	1,67
0130 01 1213	12x13	172	5	26	28	67	10	1,67
0130 01 1214	12x14	172	5	26	30	65	10	1,88
0130 01 1314	13x14	188	5.5	28	30	85	10	1,96
0130 01 1315	13x15	188	5.5	30	32	93	10	---
0130 01 1415	14x15	188	5.5	30	32	91	10	2,24
0130 01 1317	13x17	205	6.2	28	36	111	10	2,29
0130 01 1417	14x17	205	6.2	30	36	106	10	2,50
0130 01 1617	16x17	205	6.2	34	36	120	10	2,69
0130 01 1618	16x18	220	7	36	40	165	10	---
0130 01 1719	17x19	220	7	36	40	160	10	2,99
0130 01 1819	18x19	220	7	38	40	161	10	3,20
0130 01 1921	19x21	235	7.5	40	46	195	5	3,38
0130 01 1922	19x22	235	7.5	40	46	195	5	3,38
0130 01 2022	20x22	235	7.5	42	46	195	5	3,38
0130 01 1924	19x24	248	8.3	40	50	235	5	3,61
0130 01 2123	21x23	248	8.3	44	48	235	5	4,06
0130 01 2224	22x24	248	8.3	46	50	235	5	4,40
0130 01 2426	24x26	265	8.8	50	54	300	5	4,75
0130 01 2427	24x27	265	8.8	50	56	300	5	4,89
0130 01 2430	24x30	282	9.3	50	61.5	380	5	---
0130 01 2528	25x28	282	9.3	52	57.5	390	5	5,10
0130 01 2729	27x29	300	9.8	56	59	400	5	6,63
0130 01 2730	27x30	300	9.8	56	59	440	5	6,63
0130 01 2732	27x32	300	9.8	56	65.5	460	5	6,63
0130 01 3032	30x32	300	9.8	61.5	65.5	480	5	6,63
0130 01 3036	30x36	325	10.4	61.5	76	645	5	7,75
0130 01 3236	32x36	325	10.4	65.5	76	680	5	8,52
0130 01 3436	34x36	330	10.4	71	76	690	5	---
0130 01 3641	36x41	360	12	76	87	955	5	15,06
0130 01 4146	41x46	400	12.5	87	98	1300	5	26,06
0130 01 4650	46x50	450	13	98	107	1635	5	30,40

SPECIAL SERIES (ASK FOR QUOTATION SEPARATELY)

0130 01 0555	5x5.5	97	3.5	14	16	15	10	
0130 01 0708	7x8	135	3.5	16	18	20	10	
0130 01 0709	7x9	140	4	16	20	30	10	
0130 01 0910	9x10	140	4.5	20	22	45	10	
0130 01 0911	9x11	155	4.5	20	24	45	10	
0130 01 1722	17x22	235	7.5	36	46	190	5	
0130 01 1724	17x24	248	8.3	36	50	240	5	
0130 01 2227	22x27	265	8.8	46	56	300	5	

0130

İki Ağız Anahtar Takımı Uzun Boy (mm)

Double Ended Open Jaw Wrench
Long Pattern Set (mm)

TS ISO 10102
DIN 3110



KOD CODE	İÇERİK CONTENTS	g		EURO
0130 00 2108	6x7 - 8x9 - 10x11 - 12x13 14x15 - 16x17 - 18x19 20x22	815	8	18,53
0130 00 2112	6x7 - 8x9 - 10x11 12x13 - 14x15 - 16x17 18x19 - 20x22 - 21x23 24x26 - 25x28 - 27x32	2315	12	39,32

İki Ağız Anahtar Uzun Boy (SAE)
Double Ended Open Jaw Wrench Long Pattern (SAE)

TSEK

2



Krom vanadyum, Krom kaplı
Chrom vanadium, Chrom plated

0161

İki Ağız Anahtar Takımı Uzun Boy (SAE)
Double Ended Open Jaw Wrench
Long Pattern Set (SAE)

TSEK

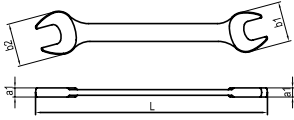

KOD CODE	inch	L mm	a1 mm	b1 mm	b2 mm	g	□	EURO
0161 01 0608	1/4"x5/16"	125	3.5	14	16	20	10	1,18
0161 01 0809	5/16"x3/8"	140	4	18	20	30	10	1,35
0161 01 0810	5/16"x11/32"	140	4	18	20	30	10	1,44
0161 01 0811	5/16"x7/16"	140	4	18	22	30	10	1,49
0161 01 0911	3/8"x7/16"	155	4.5	22	24	35	10	1,49
0161 01 1112	7/16"x1/2"	172	5	26	28	40	10	1,61
0161 01 1214	1/2"x9/16"	172	5	26	30	65	10	1,88
0161 01 1416	9/16"x5/8"	188	5.5	30	32	85	10	2,26
0161 01 1417	9/16"x11/16"	205	6.2	30	36	110	10	2,38
0161 01 1517	19/32"x11/16"	205	6.2	34	36	115	10	2,58
0161 01 1619	5/8"x3/4"	220	7	36	40	150	10	2,99
0161 01 1920	3/4"x25/32"	220	7	38	40	160	10	3,45
0161 01 2021	25/32"x13/16"	235	7.5	40	46	195	10	3,61
0161 01 1922	3/4"x7/8"	235	7.5	40	46	195	10	3,79
0161 01 2122	13/16"x7/8"	248	8.3	44	48	235	10	4,06
0161 01 2325	15/16"x1"	265	8.8	50	54	300	10	4,15
0161 01 2328	15/16"x1 1/8"	265	8.8	50	56	300	10	4,38
0161 01 2628	1 1/16"x1 1/8"	300	9.8	56	59.5	460	10	5,47
0161 01 2631	1 1/16"x1 1/4"	300	9.8	56	65.5	460	10	6,08
0161 01 2833	1 1/8"x1 5/16"	300	9.8	56	65.5	460	10	6,77

KOD CODE	İÇERİK CONTENTS	g	□	EURO
0161 00 2108	1/4"x5/16" - 5/16"x3/8" 7/16"x1/2" - 9/16"x5/8" - 19/32"x11/16" 3/4"x25/32" - 13/16"x7/8" - 15/16"x1"	1090	8	20,93
0161 00 2112	1/4"x5/16" - 5/16"x3/8" - 3/8"x7/16" 7/16"x1/2" - 1/2"x9/16" - 9/16"x5/8" 19/32"x11/16" - 3/4"x25/32" - 13/16"x7/8" 15/16"x1" - 1 1/16"x1 1/4" 1 1/8"x1 5/16"	2165	12	37,17

0250

Bir Ağız Taçlı Anahtar (mm) Single Ended Open Jaw Wrench (mm)



Krom vanadyum
Chrom vanadium

KOD CODE	mm	L mm	a1 mm	b1 mm	g	EURO
0250 01 0030	30	260	10.5	60.2	250	7,17
0250 01 0036	36	300	10.5	74.6	370	14,92
0250 01 0041	41	345	12.2	85.5	550	16,26
0250 01 0046	46	390	14	96.3	750	17,40
0250 01 0050	50	425	15.2	105	1000	22,25
0250 01 0055	55	455	16.5	113.5	1300	25,12
0250 01 0060	60	490	18.4	121	1600	---
0250 01 0065	65	524	19	130	1980	38,24

SPECIAL SERIES (ASK FOR QUOTATION SEPARATELY)

0250 01 0021	21	185	8	42.4	95	10	----
0250 01 0022	22	195	8	44.4	110	10	----
0250 01 0023	23	195	8	46.3	115	10	----
0250 01 0024	24	215	9	48.3	150	10	----
0250 01 0025	25	215	9	50.3	155	10	----
0250 01 0027	27	240	9.5	54.3	200	5	----
0250 01 0032	32	270	10.5	64	300	5	----
0250 01 0034	34	270	10.5	68	320	5	----
0250 01 0038	38	300	10.5	76.8	400	5	----
0250 01 0070	70	564	20.8	140	2480	1	----
0250 01 0075	75	608	21.8	151	3100	1	----

0255

Süper İzole Çatal Bir Ağız Anahtar (mm) Single Ended Open Jaw Wrench Super Insulated (mm)



Krom vanadyum, Krom kaplı, Kalın PVC izoleli
Chrom vanadium, Chrom plated, Triple PVC insulated

KOD CODE	mm	L mm	g	EURO
0255 01 0010	10	110	40	3,03
0255 01 0011	11	120	45	3,25
0255 01 0012	12	130	50	3,71
0255 01 0013	13	140	60	3,71
0255 01 0014	14	155	75	4,38
0255 01 0017	17	170	100	5,22
0255 01 0019	19	185	150	5,31
0255 01 0022	22	200	200	7,59
0255 01 0024	24	220	280	9,25

0325

Montaj Anahtar (mm) Speed Wrench (mm)



Krom vanadyum, Krom kaplı
Chrom vanadium, Chrom plated

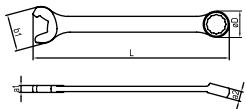

KOD CODE	mm	L mm	a1 mm	a2 mm	b1 mm	ØD mm	g	EURO
0325 02 0010	10	130	4.3	6.9	22	15.5	35	2,68
0325 02 0013	13	160	5.2	7.9	28	19.5	45	3,26
0325 02 0017	17	200	6.4	9.8	36	25.5	110	4,56
0325 02 0019	19	220	7	11	40	28.5	155	5,24
0325 02 0020	20	235	7.2	11.4	42	30	180	5,57
0325 02 0021	21	245	7.4	12	44	31.5	180	6,15
0325 02 0022	22	255	8.2	12.6	46	33	245	7,06

%100 Daha Hızlı

Yeni tasarlanan montaj anahtarı, 2 kat hızlıncı civarcı mekanizması mantığına dayanan çalışma prensibinden alır. Kullanım sırasında, montaj anahtarını civatadan ayırmadan döndürme kolaylığı kullanım hızını artırırken, civata köşelerine sağlam tutunan anahtar profili güvenli ve kaydırmaz kullanım sağlar.

Uzun Ömür

Bu yeni montaj anahtarı profili, civata ve somunlar ile köşelerinden değil düz yüzeyleri üzerinden temas ederek düzenli tork iletimini sağlarken, gerilimin artmasını da engelleyerek anahtar ömrünün uzamasını sağlar.

• Anahtarı civatadan ayırmadan hızlı kullanım.

• Güvenli tork iletimi ve uzun ömür.

100% Faster

The 100% new design speed wrench takes the 2-fold speed from the operating principle based on the ratchet mechanism logic. While in use, the ease of rotation without detaching the mounting wrench from the bolt increases the speed of use and the profile that firmly secured to the corners ensures safe and non-slip use

Long Life

This new mounting wrench profile by contacting bolts and nuts, not on corners, but on their flat surfaces, allows regular torx transmission, prevents the increase in surface tension and provides longer life.

• Quick use without detaching the wrench from the bolt.

• Safe torx transmission and long life.

Kombine Anahtar Kısa Boy (mm)
Combination Wrench Short Pattern (mm)



TS 3794
TS ISO 7738 Form A
DIN 3113

2

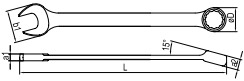

Krom vanadyum, Krom kaplı
Chrom vanadium, Chrom plated

KOD CODE	mm	L mm	a1 mm	a2 mm	b1 mm	øD mm	g	□	EURO
0320 02 0005	5	100	3.4	5.1	14	10	15	10	1,45
0320 02 0055	5.5	100	3.4	5.1	14	10	15	10	1,49
0320 02 0006	6	100	3.4	5.1	14	10	15	10	1,54
0320 02 0007	7	110	3.6	5.5	16	11	20	10	1,54
0320 02 0008	8	120	3.8	5.9	18	13	25	10	1,77
0320 02 0009	9	130	4	6.3	20	14	30	10	1,77
0320 02 0010	10	140	4.3	6.9	22	15.5	40	10	2,03
0320 02 0011	11	150	4.5	7.3	24	17	45	10	2,03
0320 02 0012	12	160	4.9	7.7	26	18.5	55	10	2,40
0320 02 0013	13	170	5.2	7.9	28	19.5	60	10	2,40
0320 02 0014	14	180	5.5	8.7	30	21.5	75	10	2,89
0320 02 0015	15	190	5.8	9.1	32	22.5	90	10	2,89
0320 02 0016	16	200	6.1	9.6	34	24	105	10	3,62
0320 02 0017	17	210	6.4	9.8	36	25.5	120	10	3,62
0320 02 0018	18	220	6.8	10.4	38	27	145	10	3,95
0320 02 0019	19	232	7	11	40	28.5	170	10	3,95
0320 02 0020	20	240	7.2	11.4	42	30	195	10	4,40
0320 02 0021	21	250	7.4	12	44	31.5	190	10	4,70
0320 02 0022	22	260	8.2	12.6	46	33	275	10	5,63
0320 02 0023	23	270	8.3	13	48	35	255	5	6,46
0320 02 0024	24	280	8.5	13.6	50	36.5	320	5	6,87
0320 02 0025	25	290	8.8	14	52	39	320	5	7,47
0320 02 0026	26	300	9	14.8	54	41	400	5	7,91
0320 02 0027	27	310	9.3	15	56	41.5	400	5	8,24
0320 02 0028	28	320	9.4	15.4	57.5	42.5	380	5	8,73
0320 02 0029	29	330	10	15.6	59	43.5	510	5	9,11
0320 02 0030	30	340	10.3	16	61.5	44	505	5	9,71
0320 02 0032	32	370	10.5	16.2	65.5	47	560	5	10,04
0320 02 0034	34	400	10.7	16.8	71	50	675	5	10,28

0320

Kombine Anahtar Takımı Kısa Boy (mm)
Combination Wrench Short Pattern Set (mm)



KOD CODE	İÇERİK CONTENTS	g	□	EURO
0320 00 2108	6 - 7 - 8 - 9 - 10 - 13 - 17 - 19	475	8	18,97
0320 00 2112	8 - 9 - 10 - 11 - 12 - 13 - 14 15 - 16 - 17 - 19 - 22	1190	12	35,86
0320 00 2117	6 - 7 - 8 - 9 - 10 - 11 - 12 - 13 - 14 15 - 16 - 17 - 18 - 19 - 20 - 21 - 22	1760	17	52,04
0320 00 2121	6 - 7 - 8 - 9 - 10 - 11 - 12 - 13 - 14 15 - 16 - 17 - 18 - 19 - 20 - 21 - 22 24 - 27 - 30 - 32	3650	21	86,01

0330

Kombine Anahtar Uzun Boy (mm)
Combination Wrench, Long Pattern (mm)



TS 3794
TS ISO 7738 Form A
DIN 3113

2

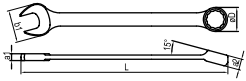

Krom vanadyum, Krom kaplı
Chrom vanadium, Chrom plated

KOD CODE	mm	L mm	a1 mm	a2 mm	b1 mm	øD mm	g	mm	EURO
0330 02 0005	5	95	3.2	5.2	12.5	9	20	10	1,94
0330 02 0055	5.5	100	3.4	5.4	13.5	9.5	20	10	1,94
0330 02 0006	6	105	3.8	5.6	14	10.5	20	10	1,75
0330 02 0007	7	117	4	6.1	16	12	20	10	1,75
0330 02 0008	8	130	4.2	6.6	18	13.5	30	10	1,97
0330 02 0009	9	141	4.5	7	20	15	40	10	1,97
0330 02 0010	10	154	4.7	7.6	22	16	50	10	2,24
0330 02 0011	11	166	5	8.2	24	17.5	60	10	2,24
0330 02 0012	12	178	5.2	8.7	26	19	70	10	2,69
0330 02 0013	13	190	5.6	9.2	28	20.5	80	10	2,69
0330 02 0014	14	203	5.8	9.7	30	22	100	10	3,05
0330 02 0015	15	215	6.4	10.1	32	23.5	115	10	3,31
0330 02 0016	16	227	6.4	10.8	34	25	135	10	3,50
0330 02 0017	17	239	6.6	11.4	36	26.5	160	10	3,79
0330 02 0018	18	250	7	12	38	28	186	10	4,04
0330 02 0019	19	263	7.3	12.7	40	29.5	205	10	4,38
0330 02 0020	20	275	7.7	13.2	42	31	235	10	4,63
0330 02 0021	21	288	8.1	13.3	44	31.5	260	10	5,12
0330 02 0022	22	300	8.5	13.7	46	34	300	10	5,86
0330 02 0023	23	315	8.8	14.2	48	35.5	300	5	5,86
0330 02 0024	24	330	9	14.2	50	37	390	5	6,52
0330 02 0025	25	340	9.3	14.7	52	38.5	380	5	6,65
0330 02 0026	26	350	9.7	14.7	54	40	475	5	6,98
0330 02 0027	27	360	10	15.2	56	41	475	5	7,41
0330 02 0028	28	370	10.4	15.7	57.5	43	475	5	8,47
0330 02 0029	29	390	10.8	16.2	59	44	610	5	9,75
0330 02 0030	30	410	11.2	16.6	61.5	45	610	5	10,21
0330 02 0032	32	420	11.5	17.1	65.5	48	755	5	10,21
0330 02 0034	34	430	11.8	17.4	71	51	735	5	10,44
0330 02 0036	36	440	12.2	17.7	76	53	1000	5	11,85
0330 02 0038	38	450	12.5	18.7	80	56	1000	5	12,13
0330 02 0041	41	480	13.5	19.7	87	61	1240	5	13,91
0330 02 0046	46	505	14.7	20.7	95	67.5	1635	1	18,48
0330 02 0050	50	540	15.9	22.7	104	73.5	2100	1	22,18

0330

Kombine Anahtar Takımı Uzun Boy (mm)
Combination Wrench Long Pattern Set (mm)



KOD CODE	İÇERİK CONTENTS	g	mm	EURO
0330 00 2108	6 - 7 - 8 - 9 - 10 - 13 17 - 19	665	8	20,81
0330 00 2112	8 - 9 - 10 - 11 - 12 13 - 14 - 15 - 16 17 - 19 - 22	1780	12	37,17
0330 00 2117	6 - 7 - 8 - 9 - 10 11 - 12 - 13 - 14 - 15 16 - 17 - 18 - 19 20 - 21 - 22	2170	17	55,52
0330 00 2121	6 - 7 - 8 - 9 - 10 - 11 12 - 13 - 14 - 15 - 16 17 - 18 - 19 - 20 - 21 22 - 24 - 27 - 30 - 32	4465	21	89,73

Kombine Anahtar Uzun Boy (SAE)
Combination Wrench Long Pattern (SAE)

TSEK

2



Krom vanadyum, Krom kaplı
Chrom vanadium, Chrom plated

0331

Kombine Anahtar Takımı Uzun Boy (SAE)
Combination Wrench Long Pattern Set (SAE)

TSEK

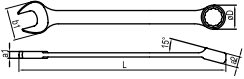

KOD CODE	inch	L mm	a1 mm	a2 mm	b1 mm	øD mm	g	□	EURO
0331 02 0005	3/16"	95	3.2	5.2	12.5	9	15	10	1,82
0331 02 0006	1/4"	105	3.8	5.6	14	10.5	20	10	1,82
0331 02 0008	5/16"	130	4.2	6.6	18	13.5	30	10	1,95
0331 02 0010	3/8"	154	4.7	7.6	22	16	50	10	2,40
0331 02 0011	7/16"	166	5	8.2	24	17.5	60	10	2,40
0331 02 0013	1/2"	190	5.6	9.2	28	20.5	80	10	2,99
0331 02 0014	9/16"	203	5.8	9.7	30	22	100	10	3,20
0331 02 0015	19/32"	215	6.4	10.1	32	23.5	115	10	3,20
0331 02 0016	5/8"	227	6.4	10.8	34	25	135	10	4,31
0331 02 0017	11/16"	239	6.6	11.4	36	26.5	155	10	4,31
0331 02 0019	3/4"	263	7.3	12.7	40	29.5	205	10	4,38
0331 02 0020	25/32"	275	7.7	13.2	42	31	230	10	5,10
0331 02 0021	13/16"	288	8.1	13.3	44	31.5	260	5	5,53
0331 02 0022	7/8"	300	8.5	13.7	46	34	310	5	6,47
0331 02 0024	15/16"	330	9	14.2	50	37	380	5	6,83
0331 02 0025	1"	340	9.3	14.7	52	38.5	380	5	7,00
0331 02 0027	1 1/16"	360	10	15.2	56	41	470	5	7,63
0331 02 0028	1 1/8"	370	10.4	15.7	57.5	43	470	5	9,30
0331 02 0030	1 3/16"	410	11.2	16.6	61.5	45	635	5	11,88
0331 02 0032	1 1/4"	420	11.5	17.1	65.5	48	775	5	12,44
0331 02 0033	1 5/16"	430	11.8	17.4	71	51	775	5	12,44
0331 02 0038	1 1/2"	450	12.5	18.7	80	56	1015	5	14,82

SPECIAL SERIES (ASK FOR QUOTATION SEPARATELY)

0331 02 0035	1 3/8"	440	12.2	17.7	76	53	1015	5	
0331 02 0036	1 7/16"	440	12.2	17.7	76	53	1015	5	
0331 02 0041	1 5/8"	480	13.5	19.7	87	61	1325	5	
0331 02 0046	1 13/16"	505	14.7	20.7	95	67.5	1750	5	
0331 02 0050	2"	540	15.9	22.7	104	73.5	2200	5	

KOD CODE	İÇERİK CONTENTS	g	□	EURO
0331 00 2108	5/16" - 3/8" - 7/16" - 1/2" - 9/16" 5/8" - 11/16" - 3/4"	925	8	26,01
0331 00 2112	5/16" - 3/8" - 7/16" - 1/2" - 9/16" 5/8" - 11/16" - 3/4" - 13/16" - 7/8" 15/16" - 1"	2320	12	52,01
0331 00 2117	1/4" - 5/16" - 3/8" - 7/16" - 1/2" 9/16" - 19/32" 5/8" - 11/16" - 3/4" - 25/32" - 13/16" 7/8" - 15/16" - 1" 1 1/16" - 1 3/16"	3875	17	82,19
0331 00 2120	1/4" - 5/16" - 3/8" - 7/16" 1/2" - 9/16" - 19/32" - 5/8" - 11/16" 3/4" - 25/32" 13/16" - 7/8" - 15/16" 1" - 1 1/16" - 1 1/8" 1 3/16" - 1 1/4" - 1 5/16"	5880	20	116,56

0340

Cırcır Kombine Anahtar (mm) Combination Wrench With Ratchet (mm)

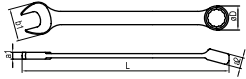

KOD CODE	mm	L mm	a1 mm	a2 mm	b1 mm	øD mm	g		EURO
0340 02 0008	8	136	5.1	7	18	17.5	35	10	11,84
0340 02 0009	9	143	5.4	7.6	20	19.3	40	10	11,84
0340 02 0010	10	160	5.8	7.7	22	21	55	10	12,65
0340 02 0011	11	168	6.1	8.3	24.5	22.7	70	10	12,65
0340 02 0012	12	174	6.4	8.7	26.5	24.7	80	10	13,44
0340 02 0013	13	180	6.7	9.3	27.6	26	90	10	14,10
0340 02 0014	14	193	7.4	9.4	31.4	27.7	120	10	14,68
0340 02 0015	15	200	7.7	10	33.4	29	135	10	15,57
0340 02 0016	16	216	8.1	10.6	34.6	30.7	155	10	17,28
0340 02 0017	17	233	8.8	10.9	38.4	33	190	10	17,94
0340 02 0018	18	239	9	11.2	39.9	33.7	200	10	18,60
0340 02 0019	19	250	9.5	11.5	41.5	34.8	240	10	19,30
0340 02 0021	21	285	10.2	13	45.8	42	350	10	26,36
0340 02 0022	22	285	10.2	13	45.8	42	340	10	26,36
0340 02 0024	24	325	11	14.5	51.5	47.5	470	5	30,66

0335

Çoklu Yıldız Cırcır Anahtar (mm) Multi-Ring Wrench (mm)



Krom vanadyum, Krom kaplı
Chrom vanadium, Chrom plated

KOD CODE	ÖLÇÜ SIZE	g		EURO
0335 02 0010	10x13x17x19	215	5	30,94

0340

Cırcır Kombine Anahtar Takımı (mm) Combination Wrench With Ratchet, Set (mm)



KOD CODE	İÇERİK CONTENTS	g		EURO
0340 00 2110	8 - 9 - 10 - 11 12 - 13 - 14 - 15 17 - 19	1315	10	144,03
0340 00 2115	8 - 9 - 10 - 11 - 12 - 13 14 - 15 - 16 - 17 - 18 19 - 21 - 22 - 24	2445	15	263,28

0345

Mafsallı Cırcır Kombine Anahtar (mm)
Flexible Head Combination Wrench With Ratchet (mm)

2



Krom vanadyum, Krom kaplı
Chrom vanadium, Chrom plated

0345

Mafsallı Cırcır Kombine Anahtar Takımı (mm)
Flexible Head Combination Wrench
With Ratchet, Set (mm)

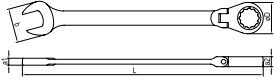

KOD CODE	mm	L mm	a1 mm	a2 mm	b mm	ØD mm	g	mm	EURO
0345 02 0008	8	136	5.5	7	17.1	17.5	40	10	13,19
0345 02 0009	9	136	5.5	7	17.1	17.5	50	10	13,50
0345 02 0010	10	140	6.1	7.7	21.3	21	60	10	14,25
0345 02 0011	11	142	6.4	8.3	23.7	22.7	80	10	14,35
0345 02 0012	12	143	6.7	8.7	25.8	24	90	10	14,97
0345 02 0013	13	156	7	9.3	26.8	26	105	10	15,30
0345 02 0014	14	164	7.3	9.4	30.4	27.7	125	10	16,12
0345 02 0015	15	174	7.7	10	31.1	29.1	145	10	17,01
0345 02 0016	16	176	8	10.6	33.8	30.7	185	10	18,05
0345 02 0017	17	195	8.3	10.9	37	32.6	210	10	18,62
0345 02 0018	18	213	8.6	11.2	38.7	33.7	235	10	19,49
0345 02 0019	19	214	9	11.3	40.2	34.8	260	10	20,16

KOD CODE	İÇERİK CONTENTS	g	mm	EURO
0345 00 2112	8 - 9 - 10 - 11 - 12 - 13 14 - 15 - 16 - 17 - 18 - 19	1365	12	195,01



0370

Boyunlu Kombine Anahtar (mm)
Offset Combination Wrench (mm)



TS 3794
TS ISO 7738 Form B
DIN 3113

2



Krom vanadyum, Krom kaplı
Chrom vanadium, Chrom plated

0370

Boyunlu Kombine Anahtar Takımı (mm)
Offset Combination Wrench, Set (mm)

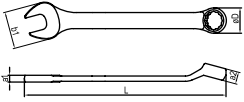

KOD CODE	mm	L mm	a1 mm	a2 mm	b1 mm	σD mm	g	mm	EURO
0370 02 0006	6	110	3.8	5.6	16	10.4	20	10	1,74
0370 02 0007	7	120	4	6.2	18	11.8	25	10	1,74
0370 02 0008	8	130	4.2	6.7	20	13.2	30	10	1,97
0370 02 0009	9	140	4.4	7.3	22	14.6	35	10	1,97
0370 02 0010	10	150	4.6	7.8	24	16	40	10	2,24
0370 02 0011	11	160	4.8	8.4	26	17.2	50	10	2,24
0370 02 0012	12	167	5	9	28	18.7	65	10	2,69
0370 02 0013	13	175	5.4	9.6	30	20	75	10	2,69
0370 02 0014	14	185	5.8	10.2	32	21.7	90	10	3,05
0370 02 0015	15	195	6.2	10.8	34	23	105	10	3,31
0370 02 0016	16	210	6.6	11.4	36	24.5	120	10	3,50
0370 02 0017	17	225	7	12	38	26	160	10	3,79
0370 02 0018	18	237	7.4	12.4	40	27.5	170	10	4,04
0370 02 0019	19	250	7.8	13	42	29	200	10	4,38
0370 02 0020	20	267	8.2	13.2	44	30.5	230	10	4,63
0370 02 0021	21	283	8.6	13.8	46	32	265	10	5,12
0370 02 0022	22	295	9	14.6	48	35	300	10	5,86
0370 02 0023	23	295	9	14.6	48	35	300	5	5,86
0370 02 0024	24	329	9.4	15.4	52	38	380	5	6,52
0370 02 0025	25	329	9.4	15.4	52	38	380	5	6,65
0370 02 0026	26	360	10.2	16.8	58	41.5	485	5	6,98
0370 02 0027	27	360	10.2	16.8	58	41.5	475	5	7,41
0370 02 0028	28	360	10.2	16.8	58	41.5	470	5	8,47
0370 02 0029	29	394	11	18.2	64	44.5	610	5	9,57
0370 02 0030	30	394	11	18.2	64	44.5	620	5	10,21
0370 02 0032	32	435	11.8	19.7	66	47.5	765	5	10,21
0370 02 0036	36	468	12.6	21.2	76	53	1020	5	11,85

KOD CODE	İÇERİK CONTENTS	g	mm	EURO
0370 00 2108	6 - 7 - 8 - 9 - 10 - 13 - 17 - 19	665	8	20,81
0370 00 2112	8 - 9 - 10 - 11 - 12 - 13 - 14 15 - 16 - 17 - 19 - 22	1375	12	37,17
0370 00 2117	6 - 7 - 8 - 9 - 10 - 11 - 12 - 13 - 14 15 - 16 - 17 - 18 - 19 - 20 - 21 - 22	2100	17	55,52
0370 00 2121	6 - 7 - 8 - 9 - 10 - 11 - 12 - 13 - 14 - 15 16 - 17 - 18 - 19 - 20 - 21 - 22 - 24 - 27 30 - 32	4425	21	89,73

Torx® - mm Kombine Anahtar
Torx® - mm Combination Wrench

2

R&D
AR-GE

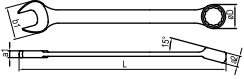

Krom vanadyum, Krom kaplı
Chrom vanadium, Chrom plated

KOD CODE	mm	*	L mm	a1 mm	a2 mm	b1 mm	σD mm	g	□	EURO
0380 02 0008	8	E10	170	4.5	7.5	20.3	13.2	45	10	3,34
0380 02 0009	9	E12	180	4.5	8	22.4	14.6	45	10	3,40
0380 02 0010	10	E14	190	5	8.5	24.4	16	60	10	3,71
0380 02 0011	11	E14	200	5.5	9	26.4	17.2	75	10	3,97
0380 02 0012	12	E16	210	6	9.5	28.4	19	90	10	3,97
0380 02 0013	13	E18	225	6.5	10	30.5	20	110	10	4,48
0380 02 0014	14	E18	235	7	11	32.5	21.8	120	10	4,66
0380 02 0015	15	E20	250	7.5	12	34.5	23	150	10	4,96
0380 02 0017	17	E22	280	8.5	14	38.4	26.5	210	10	5,70
0380 02 0018	18	E24	295	9	15	40.6	28	240	10	6,18
0380 02 0019	19	E24	310	9.5	16	42.6	29.5	280	10	6,70
0380 02 0022	22	E26	350	11	18	48.7	34.5	410	10	9,05

0380

Torx® - mm Kombine Anahtar Takımı
Torx® - mm Combination Wrench Set



Torx® -mm Kombine Anahtar: Bir çatal ağız ve bir yıldız ağızdan oluşan anahtarlarımız 8-22 mm arasında boyları bulunmaktadır. Çatal ağız kısmı mevcut çatal anahtarlardan farklı olarak 6 köşe avatanın yanısıra farklı geometri lere sahip avataları açabilmekte ve sıkabilmektedir.

TORX-mm combination wrench: Our wrenches consisting of an open end and a ring end are available in sizes from 8 to 22 mm. Unlike the existing open end wrenches, its open end can unbolt and tighten bolts with different geometries as well as the

KOD CODE	İÇERİK CONTENTS	g	□	EURO
	8 - 9 - 10 - 11 - 12 - 13 - 17 - 19			
0380 00 2108	E10 - E12 - E14 - E14 E16 - E18 - E22 - E24	790	8	35,32
	8 - 9 - 10 - 11 - 12 - 13 14 - 15 - 17 - 18 - 19 - 22			
0380 00 2112	E10 - E12 - E14 - E14 - E16 - E18 E18 - E20 - E22 - E24 - E24 - E26	1590	12	60,13

0430

Yıldız İki Ağız Anahtar (mm)
Double Ended Ring Wrench (mm)



TS 3794
TS ISO 10104 Form B
DIN 838

2



Krom vanadyum, Krom kaplı
Chrom vanadium, Chrom plated

KOD CODE	mm	L mm	a1 mm	a2 mm	b1 mm	b2 mm	g	□	EURO
0430 03 0607	6x7	176	5.6	6	10	11.5	55	10	2,40
0430 03 0809	8x9	190	6.4	6.8	13	14.5	75	10	2,69
0430 03 0810	8x10	190	6.4	7.3	13	15.5	70	10	2,87
0430 03 1011	10x11	206	7.3	7.6	15.5	17	105	10	2,99
0430 03 1012	10x12	206	7.3	8.5	15.5	18.5	105	10	3,07
0430 03 1013	10x13	220	7.3	9	15.5	20	120	10	---
0430 03 1113	11x13	220	7.6	9	17	20	130	10	3,22
0430 03 1213	12x13	220	8.5	9	18.5	20	135	10	3,45
0430 03 1214	12x14	220	8.5	9.5	18.5	21.5	145	10	3,58
0430 03 1415	14x15	236	9.5	10	21.5	23	180	10	4,11
0430 03 1317	13x17	250	9	11.5	20	26.5	215	10	4,56
0430 03 1417	14x17	250	9.5	11.5	21.5	26.5	210	10	4,67
0430 03 1617	16x17	250	10.8	11.5	25	26.5	220	10	4,75
0430 03 1618	16x18	250	10.8	12	25	27.5	210	10	4,94
0430 03 1719	17x19	271	11.5	12.5	26.5	29	270	10	5,20
0430 03 1819	18x19	271	12	12.5	27.5	29	270	10	5,65
0430 03 1922	19x22	291	12.5	13.5	29	33	330	5	6,21
0430 03 1924	19x24	311	12.5	14.2	29	36.5	345	5	---
0430 03 2022	20x22	291	12.9	13.5	30.5	33	330	5	6,67
0430 03 2123	21x23	311	13.1	14	32	35	410	5	8,47
0430 03 2224	22x24	321	13.5	14.2	33	36.5	410	5	9,14
0430 03 2426	24x26	331	14.2	14.6	36.5	39.5	495	5	9,91
0430 03 2427	24x27	331	14.2	15	36.5	40.5	495	5	10,14
0430 03 2430	24x30	352	14.2	16.7	36.5	40	530	5	---
0430 03 2528	25x28	352	14.5	15.5	38	42.5	550	5	10,77
0430 03 2729	27x29	371	15	16.7	40.5	45	660	5	11,71
0430 03 2730	27x30	371	15	16.7	40.5	45	660	5	11,88
0430 03 2732	27x32	371	15	16.7	40.5	47.5	660	5	11,88
0430 03 3032	30x32	371	16.4	16.7	45	47.5	660	5	11,88
0430 03 3036	30x36	402	16.4	17.5	45	53	880	5	12,42
0430 03 3236	32x36	402	16.7	17.5	47.5	53	890	5	14,46
0430 03 3436	34x36	420	17.1	17.5	50	53	1000	5	20,54
0430 03 3641	36x41	438	17.5	19.5	53	61	1150	5	24,73
0430 03 4146	41x46	485	19.5	20.5	61	67.5	1430	5	33,66
0430 03 4650	46x50	535	20.5	22.4	67.5	73.5	1960	5	46,71

SPECIAL SERIES (ASK FOR QUOTATION SEPARATELY)

0430 03 1014	10x14	220	7.3	9.5	15.5	21.5	120	10	
0430 03 1315	13x15	236	9	10	20	23	170	10	
0430 03 2227	22x27	331	14.2	15	36.5	40.5	500	5	
0430 03 3034	30x34	379	16.4	16.9	45	50	690	5	

0430

Yıldız İki Ağız Anahtar Takımı (mm)
Double Ended Ring Wrench Set (mm)



KOD CODE	İÇERİK CONTENTS	g	□	EURO
0430 00 2108	6x7 - 8x9 - 10x11 - 12x13 - 14x15 16x17 - 18x19 - 20x22	1450	8	32,78
0430 00 2112	6x7 - 8x9 - 10x11 - 12x13 - 14x15 16x17 - 18x19 - 20x22 - 21x23 24x26 - 25x28 - 27x32	3610	12	73,96

Yıldız İki Ağzı Anahtar (SAE)
Double Ended Ring Wrench (SAE)

TSEK

2

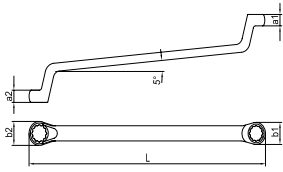

Krom vanadyum, Krom kaplı
Chrom vanadium, Chrom plated

0431

Yıldız İki Ağzı Anahtar Takımı (SAE)
Double Ended Ring Wrench, Set (SAE)

TSEK

KOD CODE	inch	L mm	a1 mm	a2 mm	b1 mm	b2 mm	g	□	EURO
0431 03 0608	1/4"x5/16"	176	5.6	6	10	11.5	55	10	2,89
0431 03 0809	5/16"x3/8"	190	6.4	6.8	13	14.5	75	10	3,05
0431 03 0811	5/16"x7/16"	190	6.4	7.3	13	15.5	115	10	3,16
0431 03 0911	3/8"x7/16"	206	7.3	7.6	15.5	17	115	10	3,16
0431 03 1112	7/16"x1/2"	220	8.5	9	18.5	20	135	10	3,34
0431 03 1214	1/2"x9/16"	220	8.5	9.5	18.5	21.5	145	10	3,70
0431 03 1415	9/16"x19/32"	236	9.5	10	21.5	23	165	10	4,32
0431 03 1416	9/16"x5/8"	236	9.5	10	21.5	23	165	10	4,50
0431 03 1517	19/32"x11/16"	250	10.8	11.5	25	26.5	210	10	4,98
0431 03 1920	3/4"x25/32"	271	12	12.5	27.5	29	270	10	5,89
0431 03 2122	13/16"x7/8"	311	13.1	14	32	35	400	5	7,00
0431 03 2325	15/16"x1"	331	14.2	14.6	36.5	39.5	495	5	10,70
0431 03 2631	1 1/16"x1 1/4"	371	15	16.7	40.5	48	640	5	12,42
0431 03 2833	1 1/8"x1 5/16"	371	15	16.7	40.5	48	660	5	13,44
0431 03 3033	1 3/16"x1 5/16"	371	16.4	16.7	45	48	670	5	13,44

SPECIAL SERIES (ASK FOR QUOTATION SEPARATELY)

0431 03 1217	1/2"x11/16"	250	9	10	20	26.5	185	10	
0431 03 1417	9/16"x11/16"	250	9.5	11.5	21.5	26.5	185	10	
0431 03 1617	5/8"x11/16"	250	10.8	11.5	25	26.5	210	10	
0431 03 1619	5/8"x3/4"	271	11.5	12.5	26.5	29	270	10	
0431 03 2021	25/32"x13/16"	291	12.9	13.5	30.5	33	270	5	
0431 03 1922	3/4"x7/8"	291	12.9	13.5	30.5	33	400	5	
0431 03 2223	7/8"x15/16"	321	13.5	14.2	33	36.5	400	5	
0431 03 2328	15/16"x1 1/8"	331	14.2	15	36.5	40.5	500	5	
0431 03 2528	1"x1 1/8"	352	14.5	15.5	38	42.5	570	5	
0431 03 3036	1 3/16"x1 3/8"	402	16.4	17.5	45	53	880	5	
0431 03 3236	1 1/4"x1 7/16"	402	16.7	17.5	48	53	890	5	
0431 03 3641	1 7/16"x1 5/8"	438	17.5	19.5	53	61	1100	5	
0431 03 4146	1 11/16"x1 7/8"	485	19.5	20.5	61	67.5	1390	5	
0431 03 4650	1 13/16"x2"	535	20.5	22.5	67.5	73.5	1955	5	



KOD CODE	İÇERİK CONTENTS	g	□	EURO
0431 00 2108	1/4"x5/16" - 5/16"x3/8" 7/16"x1/2" - 9/16"x5/8" 19/32"x11/16" 3/4"x25/32" - 13/16"x7/8" 15/16"x1"	1915	8	41,91
0431 00 2112	1/4"x5/16" - 5/16"x3/8" 3/8"x7/16" - 7/16"x1/2" 9/16"x5/8" - 19/32"x11/16" 3/4"x25/32" - 13/16"x7/8" 15/16"x1" - 1 1/16"x1 1/4" 1 1/8"x1 5/16" 1 3/16"x1 5/16"	3985	12	84,81

0440

Düz Yıldız Anahtar (mm)
Flat Ring Wrench (mm)

TS 3794
TS ISO 10103
DIN 838

2

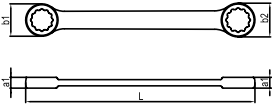

Krom vanadyum, Krom kaplı
Chrom vanadium, Chrom plated

KOD CODE	mm	L mm	a1 mm	b1 mm	b2 mm	g	mm	EURO
0440 03 0607	6x7	99	4.4	9.5	11	10	10	2,29
0440 03 0809	8x9	113	5.2	12.5	14	25	10	2,60
0440 03 1011	10x11	125	6	15.5	16.5	30	10	2,88
0440 03 1213	12x13	140	6.8	18.5	20	45	10	3,32
0440 03 1415	14x15	156	7.2	21	22.5	60	10	3,98
0440 03 1617	16x17	170	8	24	25	80	10	4,56
0440 03 1819	18x19	188	8.8	26.5	27.5	105	10	5,43
0440 03 2022	20x22	208	9.6	29	32	135	10	6,41
0440 03 2123	21x23	230	10.6	30	33	170	10	8,12
0440 03 2426	24x26	256	10.8	35	37.5	225	10	9,52
0440 03 2528	25x28	280	11.8	36	40.5	270	10	10,95
0440 03 2732	27x32	310	12.8	38.5	45.5	355	10	14,41

SPECIAL SERIES (ASK FOR QUOTATION SEPARATELY)

0440 03 0810	8x10	120	5.6	12.5	15.5	30	10	
0440 03 1013	10x13	140	6.6	15.5	20	45	10	
0440 03 1315	13x15	156	7.2	20	22.5	55	10	
0440 03 1317	13x17	170	8	20	25	85	10	
0440 03 1618	16x18	188	8.6	24	26.5	90	10	
0440 03 1719	17x19	188	8.8	25	27.5	105	10	
0440 03 2224	22x24	230	10.8	32	35	170	10	
0440 03 2427	24x27	256	10.8	35	38.5	225	10	
0440 03 2729	27x29	290	12.8	38.5	42.5	285	10	
0440 03 3032	30x32	310	12.8	43	45.5	360	10	

0440

Düz Yıldız Anahtar Takımı (mm)
Flat Ring Wrench, Set (mm)



KOD CODE	İÇERİK CONTENTS	g	mm	EURO
0440 00 2108	6x7 - 8x9 - 10x11 - 12x13 - 14x15 16x17 - 18x19 - 20x22	560	8	31,46
0440 00 2112	6x7 - 8x9 - 10x11 - 12x13 - 14x15 16x17 - 18x19 - 20x22 - 21x23 24x26 - 25x28 - 27x32	1540	12	71,46

0435

Süper İzoleli Bir Ağız Yıldız Anahtar (mm)
Single Ended Ring Wrench Super Insulated (mm)

2



Krom vanadyum, Krom kaplı, Kalın PVC izoleli
Chrom vanadium, Chrom plated, Triple PVC insulated

KOD CODE	mm	L mm	g	□	EURO
0435 03 0010	10	170	100	10	4,93
0435 03 0011	11	180	110	10	4,74
0435 03 0012	12	190	130	10	4,00
0435 03 0013	13	200	150	10	4,38
0435 03 0014	14	215	180	10	5,06
0435 03 0017	17	230	220	10	5,00
0435 03 0019	19	245	270	10	5,82
0435 03 0022	22	260	310	10	8,35
0435 03 0024	24	280	420	10	10,19

0530

Yarım Ay Anahtar Yıldız İki Ağız (mm)
Double - Hex Starter and Block Wrench (mm)

TSEK

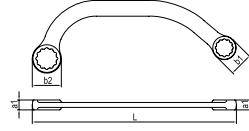

Krom vanadyum, Krom kaplı
Chrom vanadium, Chrom plated

KOD CODE	mm	L mm	a1 mm	b1 mm	b2 mm	g	□	EURO
0530 04 0810	8x10	120	6	12.5	15.5	30	10	4,14
0530 04 1011	10x11	150	7	17	20	55	10	4,32
0530 04 1012	10x12	150	7	17	20	55	10	4,56
0530 04 1113	11x13	150	7	17	20	55	10	5,06
0530 04 1315	13x15	185	9	21.5	26	110	10	6,04
0530 04 1317	13x17	185	9	21.5	26	105	10	6,04
0530 04 1417	14x17	185	9	21.5	26	110	10	6,80
0530 04 1517	15x17	185	9	21.5	26	100	10	6,80
0530 04 1922	19x22	230	11	29	33	195	10	7,92

0540

Rekor Anahtar (mm)
Flarenut Wrench (mm)

DIN 3118

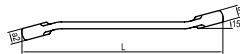
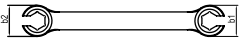

Krom vanadyum, Krom kaplı
Chrom vanadium, Chrom plated

KOD CODE	mm	L mm	a1 mm	a2 mm	b1 mm	b2 mm	g	□	EURO
0540 01 0810	8x10	130	7	8.5	18	20	60	10	6,87
0540 01 1011	10x11	150	8.5	9.3	20	22	75	10	9,41
0540 01 1012	10x12	150	8.5	9.3	20	22	75	10	9,41
0540 01 1113	11x13	170	9.3	10.8	22	25.5	105	10	10,12
0540 01 1214	12x14	170	9.3	10.8	22	25.5	105	10	10,12
0540 01 1719	17x19	210	11.8	13	30.5	33.5	185	10	13,66
0540 01 1922	19x22	230	12.8	14.9	33.5	39.5	235	10	16,99

0531

Yarım Ay Anahtar Yıldız İki Ağız (SAE)
Double - Hex Starter and Block Wrench (SAE)

TSEK

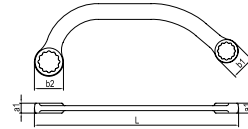

Krom vanadyum, Krom kaplı
Chrom vanadium, Chrom plated

KOD CODE	inch	L mm	a1 mm	b1 mm	b2 mm	g	□	EURO
0531 04 1112	7/16"x1/2"	150	7	17	20	50	10	6,59
0531 04 1214	1/2"x9/16"	185	9	21.5	26	110	10	7,25
0531 04 1416	9/16"x5/8"	185	9	21.5	26	115	10	7,85
0531 04 1922	3/4"x7/8"	230	11	29	33	195	10	9,42

SPECIAL SERIES (ASK FOR QUOTATION SEPARATELY)

0531 04 0809	5/16"x3/8"	120	6	12.5	15.5	30	10	
0531 04 0911	3/8"x7/16"	150	7	17	20	50	10	
0531 04 1417	9/16"x11/16"	185	9	21.5	26	110	10	
0531 04 1517	9/32"x11/16"	185	9	21.5	26	105	10	

0700

Çatal Çakma Anahtar (mm)
Slugging Open Jaw Wrench (mm)

TS 81
DIN 133

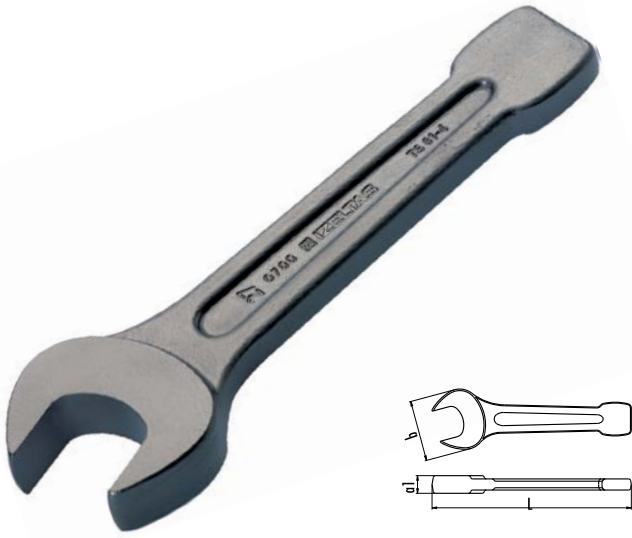

Krom vanadyum
Chrom vanadium

KOD CODE	mm	L mm	a1 mm	b mm	g		EURO
0700 05 0024	24	160	15	42	280	1	17,96
0700 05 0027	27	180	16	45	385	1	18,49
0700 05 0030	30	190	17	50	525	1	19,25
0700 05 0032	32	190	17	50	530	1	20,49
0700 05 0036	36	205	19	58	755	1	23,69
0700 05 0038	38	205	19	58	760	1	28,42
0700 05 0041	41	225	20	62	920	1	29,94
0700 05 0042	42	225	20	62	930	1	34,42
0700 05 0046	46	240	22	72	1305	1	36,73
0700 05 0047	47	240	22	72	1320	1	39,91
0700 05 0050	50	255	23	78	1565	1	42,23
0700 05 0055	55	272	25	88	2305	1	49,40
0700 05 0060	60	272	25	88	2310	1	54,85
0700 05 0065	65	300	28	98	3300	1	71,31
0700 05 0070	70	330	32	108	4555	1	89,13
0700 05 0075	75	330	32	108	4460	1	92,26
0700 05 0080	80	360	35	126	6115	1	120,31
0700 05 0085	85	360	35	126	5740	1	121,80
0700 05 0090	90	390	40	140	8040	1	152,24
0700 05 0095	95	390	40	140	8160	1	167,48
0700 05 0100	100	420	44	148	12355	1	259,75
0700 05 0105	105	420	44	148	11785	1	271,77
0700 05 0110	110	450	48	166	15000	1	312,34
0700 05 0115	115	450	48	166	14830	1	358,66
0700 05 0120	120	490	54	178	18865	1	379,24

SPECIAL SERIES (ASK FOR QUOTATION SEPARATELY)

0700 05 0125	125	490	54	178	17250	1	-----
0700 05 0130	130	518	59	196	20000	1	-----
0700 05 0135	135	518	59	196	19700	1	-----
0700 05 0140	140	518	59	196	19400	1	-----
0700 05 0145	145	580	62	223	28000	1	-----
0700 05 0150	150	580	62	223	27600	1	-----

0750

Yıldız Çakma Anahtar (mm)
Slugging Ring Wrench (mm)

TS 3794
DIN 7444



Krom vanadyum
Chrom vanadium

KOD CODE	mm	L mm	a1 mm	b mm	g		EURO
0750 05 0024	24	160	15	42	235	1	16,15
0750 05 0027	27	180	16	46	325	1	17,73
0750 05 0030	30	190	17	52	435	1	21,26
0750 05 0032	32	190	17	52	425	1	22,75
0750 05 0036	36	205	19	59	550	1	28,44
0750 05 0038	38	205	19	59	530	1	28,79
0750 05 0041	41	225	20	64	730	1	36,98
0750 05 0042	42	225	20	64	700	1	39,09
0750 05 0046	46	240	22	73	970	1	41,00
0750 05 0047	47	240	22	73	930	1	43,81
0750 05 0050	50	255	23	78	1160	1	47,13
0750 05 0055	55	272	25	88	1520	1	51,84
0750 05 0060	60	272	25	88	1460	1	56,01
0750 05 0065	65	300	28	100	2025	1	72,79
0750 05 0070	70	330	32	109	2890	1	80,07
0750 05 0075	75	330	32	109	2755	1	84,04
0750 05 0080	80	360	35	123	4000	1	126,11
0750 05 0085	85	360	35	123	3620	1	151,28
0750 05 0090	90	390	40	142	5465	1	181,55
0750 05 0095	95	390	40	142	5250	1	199,70
0750 05 0100	100	420	44	152	6755	1	229,83
0750 05 0105	105	420	44	152	6445	1	240,90
0750 05 0110	110	450	46	165	8500	1	265,32
0750 05 0115	115	450	46	165	8460	1	291,34
0750 05 0120	120	490	54	178	10000	1	373,68

SPECIAL SERIES (ASK FOR QUOTATION SEPARATELY)

0750 05 0125	125	490	54	178	9900	1	-----
0750 05 0130	130	518	59	196	16000	1	-----
0750 05 0135	135	518	59	196	15900	1	-----
0750 05 0140	140	518	59	196	15800	1	-----
0750 05 0145	145	580	61.8	223	22000	1	-----
0750 05 0150	150	580	61.8	223	21900	1	-----
0750 05 0155	155	580	61.8	223	21800	1	-----
0750 05 0160	160	648	67	262	30100	1	-----
0750 05 0165	165	648	67	262	30000	1	-----
0750 05 0170	170	648	67	262	29800	1	-----
0750 05 0180	180	648	67	262	29700	1	-----

0550

Boru Uzatmalı Yıldız Anahtar (mm) Offset Ring Wrench (mm)

2



Krom vanadyum, Krom kaplı
Chrom vanadium, Chrom plated

KOD CODE	mm	L mm	a1 mm	b mm	øD mm	h mm	g		EURO
0550 05 0024	24	180	17	37	18.5	30	400	1	21,42
0550 05 0027	27	190	18	42	18.5	33	450	1	21,98
0550 05 0030	30	200	20	46	18.5	34	520	1	23,97
0550 05 0032	32	235	21.5	49	21.2	37	700	1	24,09
0550 05 0036	36	245	23	53.5	21.2	42	830	1	26,94
0550 05 0038	38	270	25	60.5	21.2	42	965	1	35,48
0550 05 0041	41	270	25	60.5	21.2	43	950	1	35,48
0550 05 0046	46	280	26	68	24.2	45	1240	1	40,59
0550 05 0050	50	290	28	74	24.2	47	1410	1	45,59
0550 05 0055	55	300	30	79	24.2	50	1550	1	50,65
0550 05 0060	60	345	32	89	29	50.5	2390	1	64,01
0550 05 0065	65	355	35	98	29	53	2730	1	68,22

SPECIAL SERIES (ASK FOR QUOTATION SEPARATELY)

0550 05 0022	22	180	17	37	18.5	30	400	1	-----
0550 05 0034	34	235	21.5	49	21.2	37	750	1	-----
0550 05 0070	70	365	37	104	29	55	2900	1	-----
0550 05 0075	75	375	40	109	29	57.5	3100	1	-----
0550 05 0080	80	385	43	124	29	59	3900	1	-----
0550 05 0085	85	385	43	124	29	59	3750	1	-----
0550 05 0090	90	410	46	140	29	63	5100	1	-----
0550 05 0095	95	410	46	140	29	63	4950	1	-----
0550 05 0100	100	420	46	150	29	65	4800	1	-----

0551

Döndürme Kolu Borusu Tubular Handle

Dikişsiz Çelik Boru
Seamless Steel Pipe

KOD CODE	mm	L mm	ø mm	g		EURO
0551 05 0001	22 - 30	460	19	700	1	12,86
0551 05 0002	32 - 41	610	22	1220	1	19,28
0551 05 0003	46 - 55	760	25	1880	1	31,50
0551 05 0004	60 - 100	860	30	2975	1	40,47

0600

Kurbağacak Anahtar Adjustable Wrench



TS 3796
DIN 3117



Yedek parça sayfa 152
Spare parts page 152

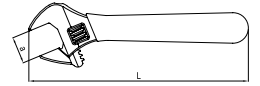

Krom vanadyum, Krom kaplı, PVC izoleli
Chrom vanadium, Chrom plated, PVC insulated

KOD CODE	L mm	L inch	a mm	g		EURO
0600 01 1006	160	6"	18	120	5	13,19
0600 01 1008	208	8"	23	230	5	19,48
0600 01 1010	260	10"	28	400	5	25,11
0600 01 1012	308	12"	34	670	5	34,64
0600 01 1015	388	15"	43	1555	1	54,43

0860

Kanca Anahtar (dörtgen uçlu) Hook Wrench

TS 3798 • DIN 1810

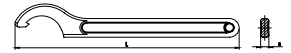

Krom vanadyum, Krom kaplı
Chrom vanadium, Chrom plated

KOD CODE	mm	L mm	a1 mm	g		EURO
0860 05 2528	25/28	136	5	50	10	6,92
0860 05 3032	30/32	136	5	50	10	6,92
0860 05 3436	34/36	170	6	95	10	7,70
0860 05 4042	40/42	170	6	95	10	7,70
0860 05 4550	45/50	210	7	160	10	9,06
0860 05 5255	52/55	210	7	160	10	9,06
0860 05 5862	58/62	242	8	270	5	11,38
0860 05 6875	68/75	242	8	270	5	11,38
0860 05 8090	80/90	281	9	400	5	14,62
0860 05 9510	95/100	281	9	400	5	14,62

0615

Ayarlı Montaj Anahtarı
Adjustable Speed Wrench

R&D
AR-GE



Yedek parça sayfa 152
Spare parts page 152

Krom vanadyum, Krom kaplı
Chrom vanadium, Chrom plated

6 ile 22 mm arası **altı köşe, torx, yive, ribe, kare** gibi farklı geometriye sahip cıvataları açabilme imkanı sağlar. Anahtarı civate başından tam olarak çıkarmadan açma ve sıkma hareketi olanağı sağlar. Anahtar sapına özel olarak açılmış 10-13-15 mm altı köşe cıvataları açabilme imkanı sağlar

Allows to open bolts with different geometry such as **hexagon, torx, yive, ribe, square** in sizes from 6 to 22 mm. Enables unbolting and tightening turn without removing the wrench completely from the bolt head. Specially opened 10-13-15 mm holes on the handle, allows to open hexagon bolts.

KOD CODE	L mm	L inch	a mm	g	EURO	
0615 01 0200	200	8"	6-22	220	5	28,15



MCD ÇOK NOKTADAN TEMAS PROFİLİ / MCD MULTI CONTACT DRIVE PROFILE



İzeltas Yeni Jenerasyon Yıldız Anahtar Profili

MCD, Multi Contact Drive (çoklu temas), sıkma performansının geliştirilmesi amacıyla dizayn edilmiştir. Bilgisayar destekli titiz çalışmaların sonucunda geliştirilen MCD, klasik 12 köşe anahtardan çok daha kullanışlı, çok daha güçlüdür.

En önemli özelliği, yıldız kafadaki çoklu temas yüzeyleridir. Bu sayede civata ve somunla maksimum temas sağlanır. Böylece basınç tüm köşelere eşit olarak dağılır, temas edilen yüzeylerdeki olası hasarlar önlenir, aletin ömrü uzar.

- Yıldız kafadaki yeni profil, düzenli bir dalga şeklindedir. Güç, civatanın köşelerine değil, yan yüzeylerine etki eder (çoklu temas). Basınç daha dengeli dağıldığından temas edilen yüzeylerde ezilme meydana gelmez.
- Tolerans dışı civatalar için de uygundur.
- Civata başlarının köşelerini ezmez.
- Geniş temas alanı, anahtar ömrünü arttırır.
- Bozuk ve deforme olmuş civataları kolayca açar.

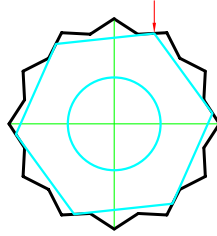

Çoklu Temas / Multi Point Contact

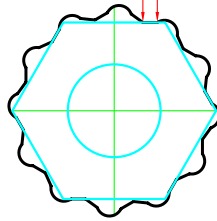

MCD Profil
MCD Profile

IZELTAS New Generation Ring Wrench Profile

MCD (Multi Contact Drive) is designed to improve the driving performance of the ring wrench. MCD, designed through computer aided drafting, transmits more torque and has longer life than conventional 12 edge ring profile.

Multi point contact is the source of effectiveness, where maximum surface area is in touch with fastener flats. Increased contact also maximizes tool's life through decreased pressure on the contact points.

- New profile of the ring wrench is formed of curves. Torque is transmitted through these curves rather than edges. As the stress is balanced between enlarged surfaces, the risk of deformation is minimized.
- It is possible to drive off-tolerance fasteners.
- Does not deform the fastener edges.
- Larger contact area increases tool's life.
- Works well with deformed fasteners.

MONTAJ ANAHTARI / SPEED WRENCH



%100 Daha Hızlı

Yeni tasarlanan montaj anahtarı, 2 kat hızlı cırcır mekanizması mantığına dayanan çalışma prensibinden alır. Kullanım sırasında, montaj anahtarını civatadan ayırmadan döndürme kolaylığı kullanım hızını arttırırken, civata köşelerine sağlam tutunan anahtar profili güvenli ve kaydırmaz kullanım sağlar.

Uzun Ömür

Bu yeni montaj anahtarı profili, civata ve somunlar ile köşelerinden değil düz yüzeyleri üzerinden temas ederek düzenli tork iletimini sağlarken, gerilimin artmasını da engelleyerek anahtar ömrünün uzamasını sağlar.

- Anahtarı civatadan ayırmadan hızlı kullanım.
- Güvenli tork iletimi ve uzun ömür.

100% Faster

New designed speed wrench takes its 100% faster rotational drive from the ratchet mechanism principle. Rotating the tool without the need for removing from the fastener provides faster usage, while enabling safer and slip-free usage with fully gripping upper and lower jaws.

Longer Tool Life

This new speed wrench profile contacts the fasteners from their flats rather than edges, which provides balanced torque transmission and decreases stress accumulation on the edges increasing the tool life considerably.

- Fast drive without removing the wrench from the fastener.
- Firm torque transmission and longer life.

AYARLI MONTAJ ANAHTARI / ADJUSTABLE SPEED WRENCH



6 ile 22 mm arası altı köşe, torx,yive ,ribe, kare gibi farklı geometriye sahip civataları açabilme imkanı sağlar. Anahtarı civata başından tam olarak çıkarmadan açma ve sıkma hareketi olanağı sağlar. Anahtar sapına özel olarak açılmış 10-13-15 mm altı köşe civataları açabilme imkanı sağlar

This tool is used for all different shapes of bolts between 6 and 22 mm. Contact between the tool and bolt is not removed to loosen and tighten the bolt. With the hexagonal holes in the handle, tool also can be used for 10-13-15mm bolts and nuts.

3

Lokma ve Bijon Anahtarları Sockets and Rim Wrenches



- Lokma Anahtarlar* Socket Wrenches
- Lokma Takımları* Socket Wrench Sets
- Kovan Anahtarlar* Tubular Socket Wrenches
- Bijon Anahtarlar* Rim Wrenches
- Tork Anahtarları* Torque Wrenches

1107

1/4" Altı Köşe Lokma Anahtar (mm)
Socket Wrench 6 Points (mm)

TS ISO 2725 -1
DIN 3124

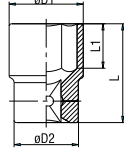

Krom vanadyum, Krom kaplı, Polisajlı
Chrom vanadium, Chrom plated, Polished

1/4"

KOD CODE	mm	ø D1 mm	ø D2 mm	L mm	L1 mm	g	mm	EURO
1107 06 0004	4	6.8	11.8	24.5	4	10	10	0,59
1107 06 0045	4.5	7.4	11.8	24.5	5	10	10	0,59
1107 06 0005	5	8	11.8	24.5	6	10	10	0,59
1107 06 0055	5.5	8.7	11.8	24.5	6	10	10	0,59
1107 06 0006	6	9.2	11.8	24.5	7	10	10	0,59
1107 06 0007	7	10.3	11.8	24.5	7	10	10	0,59
1107 06 0008	8	11.4	11.8	24.5	8	10	10	0,59
1107 06 0009	9	12.9	12.2	24.5	8	15	10	0,59
1107 06 0010	10	14.3	13	24.5	9	20	10	0,59
1107 06 0011	11	15.8	14.2	24.5	9	20	10	0,79
1107 06 0012	12	16.8	15.5	24.5	9	25	10	0,79
1107 06 0013	13	17.8	16.5	24.5	9	30	10	0,89



Havali aletler ile kullanmayınız / Do not use with power-tools

1107

1/4" Altı Köşe Derin Lokma Anahtar (mm)
Deep Socket Wrench 6 Points (mm)

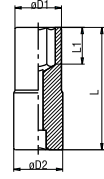

Krom vanadyum, Krom kaplı, Polisajlı
Chrom vanadium, Chrom Plated, Polished

1/4"

KOD CODE	mm	ø D1 mm	ø D2 mm	L mm	L1 mm	g	mm	EURO
1107 06 4004	4	6.8	11.8	50	6	10	10	1,85
1107 06 4005	5	8	11.8	50	7	20	10	1,85
1107 06 4055	5.5	8.7	11.8	50	9	20	10	1,85
1107 06 4006	6	9.2	11.8	50	9	25	10	2,07
1107 06 4007	7	10.3	11.8	50	15	25	10	2,07
1107 06 4008	8	11.8	11.8	50	15	25	10	2,07
1107 06 4009	9	13	13	50	15	30	10	2,07
1107 06 4010	10	14.5	14.5	50	15	40	10	2,07
1107 06 4011	11	15.8	15.8	50	21	45	10	2,26
1107 06 4012	12	16.8	16.8	50	21	50	10	2,26
1107 06 4013	13	17.8	17.8	50	21	55	10	2,26

1107

1/4" Derin Lokma Anahtar Takımı (14 parça, mm)
Socket Wrench Set Long Type (14 pcs, mm)



1/4"

KOD CODE	LOKMA LAR Sockets	AVADANLIKLAR Accessories	g	mm	EURO
1107 00 6014	4-5-5.5-6 7-8-9-10 11-12-13 Altı Köşe Derin Lokma Deep Socket Wrench 6 Points	1/4" Cırcır Kol Ratchet Handle 1/4" Ara Kol Extension Bar 50 mm 1/4" Ara Kol Extension Bar 100 mm	1005	14	34,52

1107

1/4" Lokmalı Allen Uç
Hexagonal Bit Socket Wrench



1/4"

Krom vanadyum, Krom Kaplı
Chrom vanadium, Chrom Plated

KOD CODE	mm	L mm	g	□	EURO
1107 06 1125	2.5	37	13	10	1,10
1107 06 1103	3	37	13	10	1,10
1107 06 1104	4	37	15	10	1,10
1107 06 1105	5	37	15	10	1,10
1107 06 1106	6	37	15	10	1,10
1107 06 1107	7	37	16	10	1,31
1107 06 1108	8	37	17	10	1,31
1107 06 1110	10	37	19	10	1,57

1107

1/4" Lokmalı Star Delikli (Torx®) Uç
Tamper Resistant Torx Bit Socket Wrench



1/4"

Krom vanadyum, Krom Kaplı
Chrom vanadium, Chrom Plated

KOD CODE	□	L mm	g	□	EURO
1107 06 1308	TR8	37	13	10	1,26
1107 06 1309	TR9	37	13	10	1,26
1107 06 1310	TR10	37	13	10	1,26
1107 06 1315	TR15	37	14	10	1,26
1107 06 1320	TR20	37	14	10	1,26
1107 06 1325	TR25	37	14	10	1,26
1107 06 1327	TR27	37	14	10	1,26
1107 06 1330	TR30	37	15	10	1,26
1107 06 1340	TR40	37	16	10	1,26

1107

1/4" Lokmalı Star (Torx®) Uç
Torx Bit Socket Wrench



1/4"

Krom vanadyum, Krom Kaplı
Chrom vanadium, Chrom Plated

KOD CODE	★	L mm	g	□	EURO
1107 06 1208	T8	37	12	10	1,14
1107 06 1209	T9	37	12	10	1,14
1107 06 1210	T10	37	13	10	1,14
1107 06 1215	T15	37	14	10	1,14
1107 06 1220	T20	37	14	10	1,14
1107 06 1225	T25	37	14	10	1,14
1107 06 1227	T27	37	14	10	1,14
1107 06 1230	T30	37	15	10	1,14
1107 06 1240	T40	37	16	10	1,14

1107

1/4" Lokma Düz Uç
Slotted Bit Socket Wrench



1/4"

Krom vanadyum, Krom Kaplı
Chrom vanadium, Chrom Plated

KOD CODE	⊖	L mm	g	□	EURO
1107 06 1403	3	37	13	10	1,14
1107 06 1435	3.5	37	14	10	1,14
1107 06 1404	4	37	14	10	1,14
1107 06 1445	4.5	37	14	10	1,14
1107 06 1455	5.5	37	15	10	1,14
1107 06 1465	6.5	37	15	10	1,14
1107 06 1407	7	37	16	10	1,14
1107 06 1408	8	37	16	10	1,14
1107 06 1410	10	37	17	10	1,14

1107

1/4" Lokmalı Yıldız Uç
Phillips Bit Socket Wrench

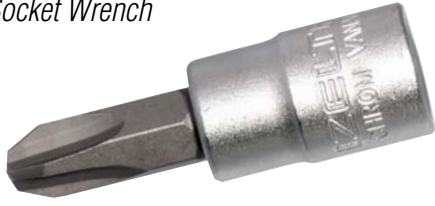

1/4"

Krom vanadyum, Krom Kaplı
Chrom vanadium, Chrom Plated

KOD CODE	+	L mm	g	□	EURO
1107 06 1501	Ph 1	37	14	10	1,14
1107 06 1502	Ph 2	37	14	10	1,14
1107 06 1503	Ph 3	37	15	10	1,14
1107 06 1504	Ph 4	37	16	10	1,14

1107

1/4" Bits Uçlu Lokma Takımı (42 Parça)
Bit Socket Wrench Set (42 Pcs)



1/4"

KOD CODE	İÇERİK CONTENTS	□	EURO
1107 00 1042	1/4" Lokmalı Star Torx® Uçlar Torx® Bit Socket T8-T9-T10-T15-T20-T25-T27-T30-T40	42	80,17
	1/4" Lokmalı Star Delikli Torx® Uçlar Tamper Resistant Torx® Bit Socket Wrench TR8-TR9-TR10-TR15-TR20-TR25-TR27 TR30-TR40		
	1/4" Lokmalı Allen Uçlar Hexagonal Bit Socket Wrench 2.5-3-4-5-6-7-8-10		
	1/4" Lokmalı Düz Uç Slotted Bit Socket Wrench 3-3.5-4-4.5-5.5 6.5-7-8-10		
	1/4" Lokmalı Yıldız Uç Phillips Bit Socket Wrench Ph1-Ph2-Ph3-Ph4		
	1/4" Cırcır kolu Ratchet Handle		
	1/4" Ara Kol Extension Bar 100 mm		
	1/4" Lokma Torna Vida Adaptörü Spindle Handle		

1507

1/4" Cırcır Kolu (Plastik Saplı)
Ratchet Wrench (Plastic Handle)

TS ISO 3315



1/4"

Krom vanadyum, Krom kaplı, Polisajlı
Chrom vanadium, Chrom plated, Polished

KOD CODE	L mm	g	□	EURO
1507 06 2140	195	140	5	16,40

1507

1/4" Cırcır Kolu
Ratchet Handle

TS ISO 3315
DIN 3122

1/4"



Krom vanadyum, Krom kaplı, Polisajlı
Chrom vanadium, Chrom plated, Polished

KOD CODE	L mm	g	□	EURO
1507 06 0140	140	140	5	6,57

1507

1/4" Ara Kol
Extension Bar

TS ISO 1174
DIN 3123

1/4"



Krom vanadyum, Krom kaplı, Polisajlı
Chrom vanadium, Chrom plated, Polished

KOD CODE	L mm	g	□	EURO
1507 06 0050	50	25	5	2,40
1507 06 0100	100	45	5	2,87

1507

1/4" Mafsal
Universal Joint

TS ISO 1174
DIN 3123

1/4"



Krom vanadyum, Krom kaplı, Polisajlı
Chrom vanadium, Chrom plated, Polished

KOD CODE	L mm	g	□	EURO
1507 06 0038	38	25	5	3,54

1507

1/4" T Kol
Sliding T - Handle

TS ISO 3315
DIN 3122



1/4"

Krom vanadyum, Krom kaplı, Polisajlı
Chrom vanadium, Chrom plated, Polished

KOD CODE	L mm	g	□	EURO
1507 06 4115	115	45	5	3,37

1507

1/4" Lokma Adaptörü
Adapter

TS ISO 1174
DIN 3123



1/4"

Krom vanadyum, Krom kaplı, Polisajlı
Chrom vanadium, Chrom plated, Polished

KOD CODE	inch	g	□	EURO
1507 06 0004	1/4"Fx3/8"M	20	5	2,52

1507

1/4" Derin Lokma Torna Vida Adaptörü
Spindle Handle

DIN 3122



1/4"

Krom vanadyum, Krom kaplı, Polisajlı, Selüloz Asetat Saplı
Chrom vanadium, Chrom plated, Polished, Cellulose Acetate Handle

KOD CODE	L mm	L1 mm	g	□	EURO
1507 06 4080	150	65	100	10	4,01

1107

1/4" Karbüratör Lokma Takımı (18 parça, mm)
Socket Wrench Set (18 pcs, mm)



1/4"

KOD CODE	LOKMARLAR Sockets	AVADANLIKLAR Accessories	g	□	EURO
		1/4" Cırcır kolu Ratchet Handle			
		1/4" Mafsal Universal Joint			
	4 - 5 - 6 7 - 8 - 9 - 10 11 - 12 - 13 Altı Köşe Six Points	1/4" T Kol Sliding T Handle	960	18	49,37
1107 00 6018	8 - 10 Sekiz Köşe Eight Points	1/4" Ara Kol Extension Bar 50 mm			
		1/4" Ara Kol Extension Bar 100 mm			
		1/4" Mafsalı Kol Flexible Handle			

1110

3/8" Altı Köşe Lokma Anahtar (mm)
Socket Wrench 6 Points (mm)

TS ISO 2725 - 1
DIN 3124

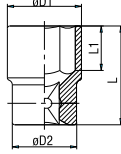

3

3/8"

Krom vanadyum, Krom kaplı, Polisajlı
Chrom vanadium, Chrom plated, Polished

KOD CODE	mm	β D1 mm	β D2 mm	L mm	L1 mm	g	mm	EURO
1110 06 0006	6	9.8	17.8	27	9	25	10	0,97
1110 06 0007	7	10.8	17.8	27	9	25	10	0,97
1110 06 0008	8	12	17.8	27	9	25	10	0,97
1110 06 0009	9	13.2	17.8	27	9	25	10	0,97
1110 06 0010	10	14.5	17.8	27	9	25	10	0,97
1110 06 0011	11	15.8	17.8	27	9	30	10	1,09
1110 06 0012	12	16.8	17.8	27	9	30	10	1,09
1110 06 0013	13	17.8	16.8	27	9	30	10	1,23
1110 06 0014	14	19.6	17.5	29	11	35	10	1,23
1110 06 0015	15	20.8	18	29	11	45	10	1,47
1110 06 0016	16	21.8	19	29	11	45	10	1,47
1110 06 0017	17	23.4	20	29	11	55	10	1,59
1110 06 0018	18	24.7	21	29	13	60	10	1,74
1110 06 0019	19	25.8	22	29	13	65	10	1,79
1110 06 0021	21	27.8	24	32	13	80	10	2,32
1110 06 0022	22	29.7	26	32	15	85	10	2,56
1110 06 0023	23	29.7	26	32	15	90	10	2,56

1110

3/8" Buji Lokma Anahtar Lastikli
Spark Plug Socket with Rubber

TS ISO 2725 - 1



3/8"

Krom vanadyum, Krom kaplı, Polisajlı
Chrom vanadium, Chrom plated, Polished

KOD CODE	mm	L mm	g	mm	EURO
1110 06 9208	21	70	145	10	2,27

1510

3/8" Cırcır Kolu
Ratchet Handle

TS ISO 3315
DIN 3122



3/8"

Krom vanadyum, Krom kaplı, Polisajlı
Chrom vanadium, Chrom plated, Polished

KOD CODE	L mm	g	mm	EURO
1510 06 0200	200	295	5	24,44

1510

3/8" Ara Kol
Extension Bar

TS ISO 1174
DIN 3123



3/8"

Krom vanadyum, Krom kaplı, Polisajlı
Chrom vanadium, Chrom plated, Polished

KOD CODE	L mm	g	mm	EURO
1510 06 0075	75	75	5	2,02
1510 06 0150	150	145	5	2,64

1510

3/8" Mafsal
Universal Joint

TS ISO 1174
DIN 3123



3/8"

Krom vanadyum, Krom kaplı, Polisajlı
Chrom vanadium, Chrom plated, Polished

KOD CODE	L mm	g	mm	EURO
1510 06 0056	56.5	60	5	5,88

1510

3/8" T Kol
Sliding T - Handle

TS ISO 3315
DIN 3122



3/8"

Krom vanadyum, Krom kaplı, Polisajlı
Chrom vanadium, Chrom plated, Polished

KOD CODE	L mm	g	□	EURO
1510 06 1200	200	180	5	5,88

1510

3/8" Lokma Adaptörü
Adapter

TS ISO 1174
DIN 3123



3/8"

Krom vanadyum, Krom kaplı, Polisajlı
Chrom vanadium, Chrom plated, Polished

KOD CODE	inch	g	□	EURO
1510 06 0007	3/8"Fx1/2"M	45	5	3,03



1110

3/8" Altı Köşe Lokma Takımı (20 parça, mm)
6 Points Socket Wrench Set (20 Pcs, mm)



3



3/8"

KOD CODE	LOKMARLAR Sockets	AVADANLIKLAR Accessories	g	□	EURO
		3/8" Cırcır Kolu Ratchet Handle			
		3/8" Mafsal Universal Joint			
	6 - 7 - 8 - 9 10 - 11 - 12 13 - 14 - 17 19 - 21 - 23	3/8" T Kol Sliding T Handle			
1110 00 6020	Altı Köşe Six Points 20.8	3/8" Ara Kol Extension Bar 75 mm	2500	20	73,14
	Buji Lokma Lastikli Altı Köşe Spark Plug Socket With Rubber	3/8" Ara Kol Extension Bar 150 mm			
		3/8" Mafsalı Kol Flexible Handle			

Havali aletler ile kullanmayınız / Do not use with power-tools

1113

1/2" Lokma Anahtar Sehpası (145 Parça)
Display Frame for Sockets (145 Pcs)



1/2"

KOD CODE	İÇERİK CONTENTS	g	□	EURO
	Dolu/Full			
	10-11-12 13-14-15 16-17-18-19 10 adet /10 Pcs			
1113 00 6145		18.236	1	786,36
	21-22-23 24-26-27 28-30-32 5 Adet / 5 Pcs			

1113

1/2" Altı Köşe Lokma Anahtar (mm)
Socket Wrench 6 Points (mm)

TS ISO 2725 -1
DIN 3124

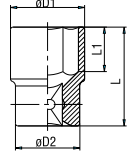

1/2"

Krom vanadyum, Krom kaplı
Chrom vanadium, Chrom plated

KOD CODE	mm	a D1 mm	a D2 mm	L mm	L1 mm	g	□	EURO
1113 06 1008	8	13.2	21.8	38	7	55	10	3,24
1113 06 1009	9	14	21.8	38	7	55	10	3,24
1113 06 1010	10	15	23.3	38	8	55	10	4,34
1113 06 1011	11	16.4	23.3	38	8	60	10	4,34
1113 06 1012	12	17.8	23.3	38	9	60	10	4,34
1113 06 1013	13	19	23.3	38	10	65	10	4,64
1113 06 1014	14	20.4	23.3	38	11	65	10	4,64
1113 06 1015	15	21.6	23.3	38	11	65	10	4,64
1113 06 1016	16	22.9	24	38	11	70	10	4,88
1113 06 1017	17	24	22.5	38	12	70	10	4,88
1113 06 1018	18	25.2	23	38	13	75	10	5,06
1113 06 1019	19	26.8	23	38	13	75	10	5,10
1113 06 1020	20	28	23	38	13	80	10	5,10
1113 06 1021	21	29.2	23	38	13	85	5	5,10
1113 06 1022	22	30.2	24	40	15	95	5	5,10
1113 06 1023	23	31.4	25	40	15	100	5	5,32
1113 06 1024	24	32.6	26	42	17	115	5	5,32
1113 06 1025	25	34	27	42	17	125	5	5,32
1113 06 1026	26	35.3	28	42	17	135	5	5,38
1113 06 1027	27	36.6	28	42	19	140	5	6,10
1113 06 1028	28	37.8	30	42	20	160	5	6,10
1113 06 1029	29	39	30	44	21	170	5	6,10
1113 06 1030	30	40	29.5	44	21	180	5	6,10
1113 06 1032	32	42.5	30	44	23	190	5	6,10



Havali aletler ile kullanmayınız / Do not use with power-tools

1114

1/2" On İki Köşe Lokma Anahtar (mm) Socket Wrench 12 Points (mm)

TS ISO 2725 - 1
DIN 3124

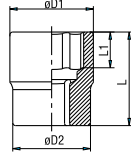

1/2"

Krom vanadyum, Krom kaplı
Chrom vanadium, Chrom plated

KOD CODE	Ø mm	ø D1 mm	ø D2 mm	L mm	L1 mm	g	□	EURO
1114 06 1010	10	15	23.3	38	8	60	10	4,34
1114 06 1011	11	16.4	23.3	38	8	60	10	4,34
1114 06 1012	12	17.8	23.3	38	9	60	10	4,34
1114 06 1013	13	19	23.3	38	10	60	10	4,64
1114 06 1014	14	20.4	23.3	38	11	60	10	4,64
1114 06 1015	15	21.6	23.3	38	11	65	10	4,64
1114 06 1016	16	22.9	24	38	11	70	10	4,88
1114 06 1017	17	24	22.5	38	12	70	10	4,88
1114 06 1018	18	25.2	23	38	13	70	10	4,88
1114 06 1019	19	26.8	23	38	13	75	10	5,10
1114 06 1020	20	28	23	38	13	80	10	5,10
1114 06 1021	21	29.2	23	38	13	80	5	5,10
1114 06 1022	22	30.2	24	40	15	95	5	5,10
1114 06 1023	23	31.4	25	40	15	100	5	5,32
1114 06 1024	24	32.6	26	42	17	105	5	5,32
1114 06 1026	26	35.3	28	42	17	135	5	5,32
1114 06 1027	27	36.6	28	42	19	135	5	6,10
1114 06 1028	28	37.8	30	42	20	155	5	6,10
1114 06 1030	30	40	30	44	21	165	5	6,10
1114 06 1032	32	42.5	30	44	23	180	5	6,10



Havale aletler ile kullanmayınız / Do not use with power-tools

1413

1/2" On İki Köşe Lokma Anahtar (SAE) Socket Wrench 12 Points (SAE)

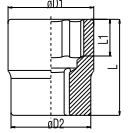

1/2"

Krom vanadyum, Krom kaplı
Chrom vanadium, Chrom plated

KOD CODE	Ø inch	ø D1 mm	ø D2 mm	L mm	L1 mm	g	□	EURO
1413 06 1008	5/16"	13.2	21.8	37	6	45	10	4,34
1413 06 1095	3/8"	15	21.8	37	8	50	10	4,34
1413 06 1010	7/16"	16.4	23.3	37	9	60	10	4,34
1413 06 1011	15/32"	18	23.3	37	9	60	10	4,34
1413 06 1012	1/2"	19	23.3	37	9	60	10	4,34
1413 06 1013	9/16"	20.4	23.3	37	11	60	10	4,70
1413 06 1014	19/32"	21.6	23.3	37	11	65	10	4,70
1413 06 1015	5/8"	23.1	22	38	11	70	10	4,70
1413 06 1016	11/16"	24.5	22.5	38	11	70	10	4,88
1413 06 1017	3/4"	26.8	23	38	13	75	10	4,88
1413 06 1020	25/32"	28	23	38	13	75	10	5,10
1413 06 1021	13/16"	28.6	23	38	13	80	10	5,10
1413 06 1022	7/8"	30.2	24	40	15	90	5	5,10
1413 06 1024	15/16"	32.6	26	42	17	115	5	5,32
1413 06 1025	1"	35	28	42	17	130	5	5,32
1413 06 1027	1 1/16"	36.6	28	42	19	135	5	6,10
1413 06 1029	1 1/8"	38.8	30	42	19	170	5	6,10
1413 06 1030	1 3/16"	40	29.5	44	20	170	5	6,10
1413 06 1032	1 1/4"	42.5	30	44	22	185	5	6,10

1113

1/2" Buji Lokma Anahtar (Lastikli) Spark Plug Socket with Rubber



1/2"

Krom vanadyum, Krom kaplı, Polisajlı
Chrom vanadium, Chrom plated, Polished

KOD CODE	Ø mm	L mm	g	□	EURO
1113 06 9160	16	70	80	10	4,46
1113 06 9208	21	70	155	10	4,88

1108

1/2" Altı Köşe Derin Lokma Anahtar (mm)
Deep Socket Wrench 6 Points (mm)

TS ISO 2725 - 1
DIN 3124

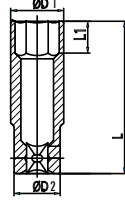

Krom vanadyum, Krom kaplı
Chrom vanadium, Chrom plated

1/2"

KOD CODE	Ø mm	ØD1 mm	ØD2 mm	L mm	L1 mm	g	EURO
1108 06 0010	10	15,5	24	75	6	110	8,66
1108 06 0011	11	16,7	24	75	7	110	8,66
1108 06 0012	12	18	24	75	8	110	8,66
1108 06 0013	13	19,2	24	75	8	120	9,27
1108 06 0014	14	20,5	24	75	10	120	9,27
1108 06 0015	15	21,7	24	75	10	140	9,27
1108 06 0016	16	23	25,5	75	10	140	9,70
1108 06 0017	17	24,2	25,5	75	10	140	9,70
1108 06 0018	18	25,5	25,5	75	12	150	9,70
1108 06 0019	19	26,7	26,7	75	12	150	10,19

1108

1/2" Altı Köşe Derin Lokma Anahtar Takımı (10 parça mm)
Deep Socket Set (10 pcs. mm)



1/2"

KOD CODE	L mm	g	EURO
1108 00 6010	10-11-12-13-14-15 16-17-18-19	1290	93,10

1113

1/2" Star Lokma Anahtar
Star Socket

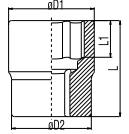

Krom vanadyum, Krom kaplı
Chrom vanadium, Chrom plated



1/2"

KOD CODE	Ø D1 mm	Ø D2 mm	L mm	L1 mm	g	EURO	
1113 06 0210	E10	13.2	23.8	37	7.5	60	3,83
1113 06 0212	E12	15	23.8	37	9	65	3,83
1113 06 0214	E14	16.4	23.8	37	10	65	3,83
1113 06 0216	E16	18.8	23.8	37	11	70	3,83
1113 06 0218	E18	20.5	23.8	39	12.5	75	3,83
1113 06 0220	E20	23	23.8	39	14	75	4,34

1113

1/2" Star (Torx®) Lokma Anahtar Takımı (7 Parça)
Star Torx® Socket Wrench Set (7 Pcs)



1/2"

KOD CODE	İÇERİK CONTENTS	g	EURO
1113 00 6007	Star Lokma / Star Socket E10 - E12 - E14 - E16 - E18 - E20 125 mm ara kol / Extension Bar	1075	29,14

1113

1/2" Lokmalı Allen Uç
Hexagonal Bit Socket Wrench



1/2"

Krom vanadyum, Krom kaplı
Chrom vanadium, Chrom plated

KOD CODE	mm	L mm	g		EURO
1113 06 1105	5	60	70	10	4,77
1113 06 1106	6	60	70	10	4,77
1113 06 1107	7	60	75	10	4,77
1113 06 1108	8	60	75	10	4,77
1113 06 1110	10	60	85	10	4,77
1113 06 1112	12	60	100	10	4,77
1113 06 1114	14	60	115	10	5,43
1113 06 4105	5	100	90	10	3,00
1113 06 4106	6	100	90	10	3,00
1113 06 4107	7	100	90	10	3,00
1113 06 4108	8	100	95	10	3,00
1113 06 4110	10	100	105	10	3,32
1113 06 4112	12	100	145	10	3,64
1113 06 4114	14	100	155	10	4,40
1113 06 4117	17	100	200	10	5,88

1113

1/2" Lokmalı Star (Torx®) Uç
Star (Torx) Bit Socket Wrench



1/2"

Krom vanadyum, Krom kaplı
Chrom vanadium, Chrom plated

KOD CODE	★	L mm	g		EURO
1113 06 1220	T20	60	70	10	5,86
1113 06 1225	T25	60	70	10	5,86
1113 06 1227	T27	60	70	10	5,86
1113 06 1230	T30	60	70	10	5,86
1113 06 1240	T40	60	70	10	5,86
1113 06 1245	T45	60	70	10	5,86
1113 06 1250	T50	60	75	10	5,86
1113 06 1255	T55	60	80	10	5,86
1113 06 1260	T60	60	100	10	5,86
1113 06 4220	T20	100	78	10	3,00
1113 06 4225	T25	100	79	10	3,00
1113 06 4227	T27	100	80	10	3,00
1113 06 4230	T30	100	80	10	3,00
1113 06 4240	T40	100	80	10	3,00
1113 06 4245	T45	100	82	10	3,00
1113 06 4250	T50	100	82	10	3,00
1113 06 4255	T55	100	100	10	3,32
1113 06 4260	T60	100	134	10	4,55

3

1113

1/2" Lokmalı Allen Uç Takımı (60 mm, 7 Parça)
Hexagonal Bits Socket Wrench Set (60 mm, 7 Pcs)

YENİ
NEW



1/2"

KOD CODE	İÇERİK CONTENTS	g		EURO
1113 00 1107	Allen Uçlar 60mm Hex Bit Socket 5-6-7-8-10-12-14	1040	7	30,77

1113

1/2" Lokmalı Torx® Uç Takımı (60 mm, 9 parça)
Torx® Bits Socket Wrench Set (60 mm, 9 Pcs)

YENİ
NEW



1/2"

KOD CODE	İÇERİK CONTENTS	g		EURO
1113 00 6009	Torx® Uçlar 60mm Star Socket T20 - T25 - T27 - T30 - T40 - T45 T50 - T55 - T60	1125	9	47,88

1113

1/2" Lokmalı Allen Uç ve Star (Torx)® Uç Takımı (17 Parça)
Hex Bit Sockets - Torx Bit Sockets Set (17 Pcs)

3



1/2"



KOD CODE	İÇERİK CONTENTS	□	EURO
1113 00 6017	<p>T Kol (1/2") Sliding T Handle 5 - 6 - 7 - 8 - 10 - 12 - 14</p> <p>Lokmalı Allen Uç 60mm Hex Bit Socket</p> <p>T20 - T25 - T27 T30 - T40 T45 - T50 - T55 - T60</p> <p>Lokmalı Torx Allen Uç 60mm Torx Bit Socket</p>	17	114,64

1114

1/2" On İki Köşe Lokmalı Bits Uç Yivli
Hex Bit Socket 12 Points



1/2"



Krom vanadyum, Krom kaplı
Chrom vanadium, Chrom plated

KOD CODE	★	L mm	g	□	EURO
1114 06 4005	M5	60	60	10	3,90
1114 06 4006	M6	60	62	10	3,90
1114 06 4008	M8	60	62	10	3,90
1114 06 4010	M10	60	78	10	3,90
1114 06 4012	M12	60	84	10	3,90
1114 06 4106	M6	80	69	10	4,27
1114 06 4108	M8	80	70	10	4,27
1114 06 4110	M10	80	84	10	4,71
1114 06 4112	M12	80	103	10	5,23
1114 06 4114	M14	80	133	10	5,54
1114 06 4208	M8	140	96	10	6,00
1114 06 4210	M10	140	125	10	7,33
1114 06 4212	M12	140	161	10	8,30
1114 06 4214	M14	140	210	10	9,31
1114 06 4216	M16	140	281	10	13,51

1114

1/2" Lokmalı (Ribe) Bits Uç
Socket Wrench 6 Points



1/2"



Krom vanadyum, Krom kaplı
Chrom vanadium, Chrom plated

KOD CODE	★	L mm	g	□	EURO
1114 06 5004	4	100	75	10	5,49
1114 06 5005	5	100	76	10	5,49
1114 06 5006	6	100	76	10	5,49
1114 06 5007	7	100	77	10	5,49
1114 06 5008	8	100	78	10	5,49
1114 06 5009	9	100	85	10	5,54
1114 06 5010	10	100	96	10	5,54
1114 06 5011	10.5	100	96	10	5,68
1114 06 5012	12	100	121	10	7,08
1114 06 5013	13	100	148	10	7,78
1114 06 5014	14	100	150	10	7,78
1114 06 5016	16	100	198	10	10,53



Havali aletler ile kullanmayınız / Do not use with power-tools

1513

1/2" Cırcır Kolu (32 Diş)
Ratchet Handle



TS ISO 3315
DIN3122



1/2"

Krom vanadyum, Krom kaplı
Chrom vanadium, Chrom plated

KOD CODE	L mm	g	5	EURO
1513 06 0032	250	580	5	25,28

1513

1/2" Cırcır Kolu (72 Diş)
Max Gear Ratchet Handle

TS ISO 3315



1/2"

Krom vanadyum, Krom kaplı
Chrom vanadium, Chrom plated

KOD CODE	L mm	g	5	EURO
1513 06 0072	250	460	5	34,88

1513

1/2" Ara Kol
Extension Bar

TS ISO 1174
DIN 3123



1/2"

Krom vanadyum, Krom kaplı
Chrom vanadium, Chrom plated

KOD CODE	L mm	g	5	EURO
1513 06 4075	75	140	5	4,88
1513 06 4125	125	215	5	5,65
1513 06 4250	250	420	5	10,10

1513

1/2" T Kol Adaptörü
Adapter



1/2"

Krom vanadyum, Krom kaplı
Chrom vanadium, Chrom plated

KOD CODE	L mm	g	5	EURO
1513 06 5250	40	90	5	4,68

1513

1/2" T Kol
Sliding T - Handle

TS ISO 3315
DIN 3122



1/2"

Krom vanadyum, Krom kaplı
Chrom vanadium, Chrom plated

KOD CODE	L mm	g	5	EURO
1513 06 2250	250	355	5	13,52

1513

1/2" Mafsal
Universal Joint

TS ISO 1174
DIN 3123



1/2"

Krom vanadyum, Krom kaplı
Chrom vanadium, Chrom plated

KOD CODE	L mm	g	5	EURO
1513 06 4070	70	140	5	8,59

1513

1/2" Lokma Adaptörü
Adapter

TS ISO 1174
DIN 3123



1/2"

Krom vanadyum, Krom kaplı
Chrom vanadium, Chrom plated

KOD CODE	inch	g	5	EURO
1513 06 0002	1/2"Fx3/8"M	55	5	3,39
1513 06 0003	1/2"Fx3/4"M	115	5	4,98

1113

1/2" Altı Köşe Lokma Anahtar Takımı (17 Parça, mm)
Socket Wrench Set 6 Points (17 pcs, mm)

3



1/2"



KOD CODE	LOKMALAR Sockets	AVADANLIKLAR Accessories	g	□	EURO
1113 00 2017	10 - 11 - 12 13 - 14 - 15 17 - 19 - 22 24 - 27 - 30 32	1/2" Cırcır Kolu Ratchet Handle 1/2" T Kol Adaptör Sliding T Handle Adapter 1/2" Mafsal Universal Joint 1/2" Ara Kol Extension Bar 250 mm	2880	17	117,50

1113

1/2" Altı Köşe Lokma Anahtar Takımı (24 Parça, mm)
Socket Wrench Set 6 Points (24 pcs, mm)



1/2"



KOD CODE	LOKMALAR Sockets	AVADANLIKLAR Accessories	g	□	EURO
1113 00 2024	10 - 11 - 12 13 - 14 - 15 16 - 17 - 18 19 - 21 - 22 23 - 24 - 26 27 - 28 - 30 32	1/2" Cırcır Kolu Ratchet Handle 1/2" Mafsal Universal Joint 1/2" T Kol Adaptör Sliding T Handle Adapter 1/2" Ara Kol Extension Bar 125 mm 1/2" Ara Kol Extension Bar 250 mm	3650	24	157,06

1114

1/2" On İki Köşe Lokma Anahtar Takımı (24 Parça, mm)
Socket Wrench Set 12 Points (24 pcs, mm)



1/2"



KOD CODE	LOKMALAR Sockets	AVADANLIKLAR Accessories	g	□	EURO
1114 00 6024	10 - 11 - 12 13 - 14 - 15 16 - 17 - 18 19 - 21 - 22 23 - 24 - 26 27 - 28 - 30 32	1/2" Cırcır Kolu Ratchet Handle 1/2" Mafsal Universal Joint 1/2" T Kol Adaptör Sliding T Handle Adapter 1/2" Ara Kol Extension Bar 125 mm 1/2" Ara Kol Extension Bar 250 mm	4150	24	157,05

1413

1/2" On İki Köşe Lokma Anahtar Takımı (24 parça, SAE)
Socket Wrench Set 12 Points (24 pcs, SAE)



1/2"



KOD CODE	LOKMALAR Sockets	AVADANLIKLAR Accessories	g	□	EURO
1413 00 6024	5/16" - 3/8" 7/16" - 15/32" 1/2" - 9/16" 19/32" - 5/8" 11/16" - 3/4" 25/32" - 13/16" 7/8" - 15/16" 1" - 1 1/16" 1 1/8" - 1 3/16" 1 1/4"	1/2" Cırcır Kolu Ratchet Handle 1/2" Mafsal Universal Joint 1/2" T Kol Adaptör Sliding T Handle Adapter 1/2" Ara Kol Extension Bar 125 mm 1/2" Ara Kol Extension Bar 250 mm	4150	24	157,05

1119

3/4" Altı Köşe Lokma Anahtar (mm) Socket Wrench 6 Points (mm)

TS ISO 2725 -1
DIN 3124

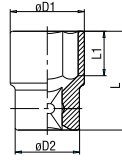

3/4"

Krom vanadyum, Krom kaplı
Chrom vanadium, Chrom plated

KOD CODE	mm	Ø D1 mm	Ø D2 mm	L mm	L1 mm	g	EURO
1119 06 1022	22	33	36	52	16	225	7,79
1119 06 1024	24	35	36	52	16	230	7,79
1119 06 1027	27	38	36	52	19	235	8,08
1119 06 1030	30	42	38	54	21	300	8,65
1119 06 1032	32	44	38	56	23	320	8,65
1119 06 1034	34	47	42	58	24	400	10,53
1119 06 1036	36	50	42	58	25	440	11,33
1119 06 1038	38	52	45	60	27	500	11,33
1119 06 1041	41	56	45	64	29	580	17,46
1119 06 1046	46	62	48	68	33	730	18,55
1119 06 1050	50	68	48	72	34	885	22,43
1119 06 1055	55	76	48	76	37	1070	26,72
1119 06 1060	60	80	48	78	38	1170	32,07

1419

3/4" On İki Köşe Lokma Anahtar (SAE) Socket Wrench 12 Points (SAE)

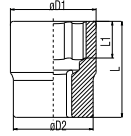

3/4"

Krom vanadyum, Krom kaplı
Chrom vanadium, Chrom plated

KOD CODE	inch	Ø D1 mm	Ø D2 mm	L mm	L1 mm	g	EURO
1419 06 1022	7/8"	33	36	52	16	220	7,79
1419 06 1024	15/16"	35	36	52	16	220	7,79
1419 06 1025	1"	35	36	52	17	220	8,03
1419 06 1027	1 1/16"	38	36	52	19	225	8,03
1419 06 1028	1 1/8"	40	38	52	19	225	8,18
1419 06 1032	1 1/4"	44	38	56	23	315	8,18
1419 06 1033	1 5/16"	46	38	56	23	355	8,18
1419 06 1035	1 3/8"	48	42	58	25	400	11,33
1419 06 1036	1 7/16"	50	42	58	25	425	11,33
1419 06 1038	1 1/2"	52	45	60	27	475	11,33
1419 06 1041	1 5/8"	56	45	64	29	555	17,46
1419 06 1044	1 3/4"	60	47	66	31	660	18,55
1419 06 1046	1 13/16"	62	47	68	34	685	18,55
1419 06 1047	1 7/8"	64	48	70	34	730	20,30
1419 06 1050	2"	68	48	72	34	805	22,43

1120

3/4" On İki Köşe Lokma Anahtar (mm) Socket Wrench 12 Points (mm)

TS ISO 2725 -1
DIN 3124

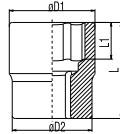

3/4"

Krom vanadyum, Krom kaplı
Chrom vanadium, Chrom plated

KOD CODE	mm	Ø D1 mm	Ø D2 mm	L mm	L1 mm	g	EURO
1120 06 1022	22	33	36	52	16	220	7,79
1120 06 1024	24	35	36	52	17	225	7,79
1120 06 1027	27	38	36	52	19	225	8,03
1120 06 1030	30	42	38	54	21	285	8,65
1120 06 1032	32	44	38	56	23	310	8,65
1120 06 1034	34	47	42	57	24	385	10,53
1120 06 1036	36	50	42	58	25	435	11,33
1120 06 1041	41	56	45	64	29	560	17,46
1120 06 1046	46	62	47	68	34	685	18,55
1120 06 1050	50	68	48	72	34	840	22,43

1519

3/4" Cırcır Kolu Ratchet Handle

TS ISO 3315
DIN 3122



3/4"

Krom vanadyum, Krom kaplı
Chrom vanadium, Chrom plated

KOD CODE	L mm	g	EURO
1519 06 4510	510	2230	57,54

1519

3/4" Ara Kol Extension Bar

TS ISO 1174
DIN 3123



3/4"

Krom vanadyum, Krom kaplı
Chrom vanadium, Chrom plated

KOD CODE	L mm	g	EURO
1519 06 4200	200	730	17,38
1519 06 4400	400	1370	24,84

1519

3/4" T Kol
Sliding T - Handle

TS ISO 3315
DIN 3122



3/4"

Krom vanadyum, Krom kaplı
Chrom vanadium, Chrom plated

KOD CODE	L mm	g	□	EURO
1519 06 4500	500	1485	5	24,83

1519

3/4" Lokma Adaptörü
Adapter

TS ISO 1174
DIN 3123



3/4"

Krom vanadyum, Krom kaplı
Chrom vanadium, Chrom plated

KOD CODE	inch	g	□	EURO
1519 06 0008	3/4"Fx1/2"M	140	5	7,47
1519 06 0001	3/4"Fx1"M	300	5	9,96

1119

3/4" Altı Köşe Lokma Anahtar Takımı (14 parça, mm)
Socket Wrench Set 6 Points (14 pcs, mm)



3/4"

KOD CODE	LOKMALAR Sockets	AVADANLIKLAR Accessories	g	□	EURO
1119 00 6114	22 - 24 - 27 30 - 32 - 34 36 - 41 - 46 50	3/4" Cırcır Kolu Ratchet Handle	10180	14	246,78
		3/4" T Kol Sliding T Handle			
		3/4" Ara Kol Extension Bar 200 mm			
		3/4" Ara Kol Extension Bar 400 mm			

1120

3/4" On İki Köşe Lokma Anahtar Takımı (14 parça, mm)
Socket Wrench Set 12 Points (14 pcs, mm)



3/4"

KOD CODE	LOKMALAR Sockets	AVADANLIKLAR Accessories	g	□	EURO
1120 00 6014	22 - 24 - 27 30 - 32 - 34 36 - 41 - 46 50	3/4" Cırcır Kolu Ratchet Handle	13700	14	246,78
		3/4" T Kol Sliding T Handle			
		3/4" Ara Kol Extension Bar 200 mm			
		3/4" Ara Kol Extension Bar 400 mm			

1419

3/4" On İki Köşe Lokma Takımı (14 parça, SAE)
Socket Wrench Set 12 Points (14 pcs, SAE)



3/4"

KOD CODE	LOKMALAR Sockets	AVADANLIKLAR Accessories	g	□	EURO
1419 00 6114	15/16" - 1 1/6" 1 1/8" - 1 1/4" 1 5/16" 1 3/8" 1 1/2" - 1 5/8" 1 7/8" - 2"	3/4" Cırcır Kolu Ratchet Handle	10180	14	246,78
		3/4" T Kol Sliding T Handle			
		3/4" Ara Kol Extension Bar 200 mm			
		3/4" Ara Kol Extension Bar 400 mm			

1225

1" On İki Köşe Lokma Anahtar (mm)
Socket Wrench 12 Points (mm)

DIN 3124

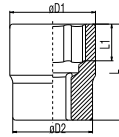

1"

Krom vanadyum, Krom kaplı
Chrom vanadium, Chrom plated

KOD CODE	mm	Ø D1 mm	Ø D2 mm	L mm	L1 mm	g	□	EURO
1225 06 0036	36	52	48	65	26	525	1	18,10
1225 06 0041	41	58	50	70	29	665	1	20,44
1225 06 0046	46	65	54	75	32	900	1	24,42
1225 06 0050	50	70	57	75	34	1040	1	28,75
1225 06 0055	55	76	57	83	42	1250	1	33,51
1225 06 0060	60	82	60	87	46	1505	1	43,37

1525

1" Lokma Adaptörü
Adapter

TS ISO 1174
DIN 3123



1"

Krom vanadyum, Krom kaplı
Chrom vanadium, Chrom plated

KOD CODE	inch	g	□	EURO
1525 06 0005	1"Fx3/4"M	330	5	11,87

1113

1/2" Alaşımli Jant Lokma Takımı (3 Parca, mm)
Combination Lug Nut Socket Set (3 Pcs, mm)



1/2"

KOD CODE	LOKMA LAR Sockets	g	□	EURO
1113 00 9003	17-19-21	800	3	36,00

1113

1/2" Altı Köşe Havalı Lokma Anahtar (mm)
Impact Socket Wrench 6 Points (mm)

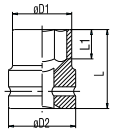

1/2"

Krom molibden, Fosfat kaplamalı
Chrom molybdenum, Phosphate finish

KOD CODE	mm	Ø D1 mm	Ø D2 mm	L mm	L1 mm	g	□	EURO
1113 06 7010	10	17	25	38	8	70	10	4,42
1113 06 7011	11	18	25	38	8	70	10	4,42
1113 06 7012	12	19	25	38	9	70	10	4,42
1113 06 7013	13	20	25	38	10	70	10	4,42
1113 06 7014	14	22	25	38	10	75	10	4,42
1113 06 7015	15	23	30	38	11	110	10	5,01
1113 06 7016	16	24	30	38	11	110	10	5,01
1113 06 7017	17	26	30	38	12	115	10	5,51
1113 06 7018	18	27	30	38	13	115	10	6,74
1113 06 7019	19	28	30	38	13	120	10	6,74
1113 06 7021	21	30	30	40	14	125	5	7,75
1113 06 7022	22	32	30	40	14	145	5	7,75
1113 06 7024	24	34	30	42	15	150	5	7,75
1113 06 7027	27	38	30	44	16	175	5	8,94

1108

1/2" Altı Köşe Havalı Derin Lokma Anahtar (mm)
6 Point Impact Socket Wrench, Long Type (mm)

YENİ
NEW

3



1/2"

Krom molibden, Fosfat kaplamalı
Chrom molybdenum, Phosphate finish

KOD CODE	mm	L mm	g		EURO
1108 06 7010	10	80	136	10	4,46
1108 06 7011	11	80	144	10	4,46
1108 06 7012	12	80	157	10	4,46
1108 06 7013	13	80	157	10	4,46
1108 06 7014	14	80	172	10	4,46
1108 06 7015	15	80	223	10	5,41
1108 06 7016	16	80	230	10	5,41
1108 06 7017	17	80	240	10	5,41
1108 06 7018	18	80	255	10	5,41
1108 06 7019	19	80	236	10	5,41
1108 06 7021	21	80	240	10	5,64
1108 06 7022	22	80	296	5	5,64
1108 06 7024	24	80	308	5	5,97
1108 06 7027	27	80	356	5	7,91
1108 06 7030	30	80	416	5	8,96
1108 06 7032	32	80	510	5	9,45

1513

1/2" Havalı Lokma Adaptörü
Impact Socket Adapter



1/2"

Krom molibden, Fosfat kaplamalı
Chrom molybdenum, Phosphate finish

KOD CODE	inch	g		EURO
1513 06 7002	1/2"Fx3/8"M	95	5	4,71
1513 06 7003	1/2"Fx3/4"M	175	5	4,98

1513

1/2" Havalı Lokma Mafsalı
Impact Socket Universal Joint



1/2"

Krom molibden, Fosfat kaplamalı
Chrom molybdenum, Phosphate finish

KOD CODE	L mm	g		EURO
1513 06 7075	75	220	5	22,30

1513

1/2" Havalı Lokma Ara Kol
Impact Socket Extension Bar



1/2"

Krom molibden, Fosfat kaplamalı
Chrom molybdenum, Phosphate finish

KOD CODE	L mm	g		EURO
1513 06 7125	125	275	5	12,43



1119

3/4" Altı Köşe Havalı Lokma Anahtar (mm)
Impact Socket Wrench 6 Points (mm)



3/4"

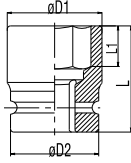

Krom molibden, Fosfat kaplamalı
Chrom molybdenum, Phosphate finish

KOD CODE	mm	Ø D1 mm	Ø D2 mm	L mm	L1 mm	g	EURO	
1119 06 7019	19	32	44	50	13	330	5	13,42
1119 06 7021	21	35	44	50	15	340	5	13,42
1119 06 7022	22	36	44	50	15	345	5	13,42
1119 06 7024	24	38	44	50	16	350	5	13,42
1119 06 7027	27	42	44	53	17	380	5	13,85
1119 06 7030	30	46	44	53	20	410	1	14,42
1119 06 7032	32	48	44	57	20	460	1	14,42
1119 06 7034	34	51	44	57	22	490	1	14,87
1119 06 7036	36	53	44	57	22	520	1	18,90
1119 06 7041	41	59	44	58	24	580	1	25,76
1119 06 7046	46	66	44	62	24	715	1	25,76

1519

3/4" Havalı Lokma Ara Kol
Impact Socket Extension Bar



3/4"

Krom molibden, Fosfat kaplamalı
Chrom molybdenum, Phosphate finish

KOD CODE	L mm	g	EURO	
1519 06 7175	175	865	5	25,57
1519 06 7250	250	1155	5	33,01
1519 06 7330	330	1425	5	42,30

1519

3/4" Havalı Lokma Mafsal
Impact Socket Universal Joint



3/4"

Krom molibden, Fosfat kaplamalı
Chrom molybdenum, Phosphate finish

KOD CODE	L mm	g	EURO	
1519 06 7108	108	735	5	44,55

1519

3/4" Havalı Lokma Adaptörü
Impact Socket Adapter



3/4"

Krom molibden, Fosfat kaplamalı
Chrom molybdenum, Phosphate finish

KOD CODE	inch	g	EURO	
1519 06 7011	3/4"Fx1/2"M	315	5	16,15



1125

1" Altı Köşe Havalı Lokma Anahtar (mm)
Impact Socket Wrench 6 Points (mm)



1"

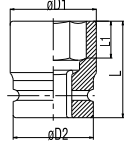

Krom molibden, Fosfat kaplamalı
Chrom molybdenum, Phosphate finish

KOD CODE	mm	Ø D1 mm	Ø D2 mm	L mm	L1 mm	g	□	EURO
1125 06 7024	24	41	54	58	17	560	1	17,14
1125 06 7027	27	44	54	58	19	565	1	17,24
1125 06 7030	30	48	54	60	21	605	1	17,39
1125 06 7032	32	51	54	62	21	650	1	17,60
1125 06 7033	33	52	54	62	21	660	1	17,60
1125 06 7034	34	53	54	62	24	765	1	17,60
1125 06 7036	36	56	54	65	24	720	1	17,78
1125 06 7038	38	58	54	65	26	735	1	18,51
1125 06 7041	41	61	54	70	28	845	1	22,30
1125 06 7046	46	68	54	75	30	1075	1	26,54
1125 06 7050	50	73	54	75	32	1170	1	27,84
1125 06 7055	55	79	54	83	37	1435	1	44,25
1125 06 7060	60	86	54	87	37	1760	1	58,19

1525

1" Havalı Lokma Mafsal
Impact Socket Universal Joint



1"

Krom molibden, Fosfat kaplamalı
Chrom molybdenum, Phosphate finish

KOD CODE	L mm	g	□	EURO
1525 06 7128	128	1530	1	64,12

1525

1" Havalı Lokma Ara Kol
Impact Socket Extension Bar



1"

Krom molibden, Fosfat kaplamalı
Chrom molybdenum, Phosphate finish

KOD CODE	L mm	g	□	EURO
1525 06 7175	175	1395	5	42,35
1525 06 7250	250	1890	5	50,26
1525 06 7330	330	2455	5	59,56

1525

1" Havalı Lokma Adaptörü
Impact Socket Adapter



1"

Krom molibden, Fosfat kaplamalı
Chrom molybdenum, Phosphate finish

KOD CODE	inch	g	□	EURO
1525 06 7015	1"Fx3/4"M	560	5	18,02

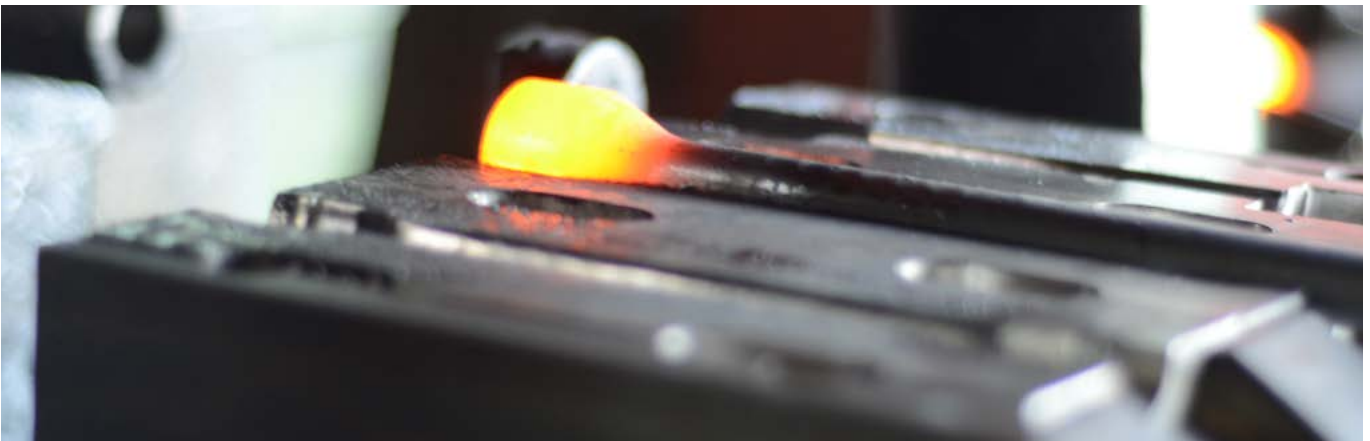

1800

Kovan Anahtar İki Ağz (mm) Double Ended Tubular Socket Wrench (mm)

TS ISO 3793
DIN 896
TSE



Dikişsiz çelik boru, Çinko kaplı
Seamless steel tube, Zinc plated

KOD CODE	mm	L mm	AA1 mm	AA2 mm	H1 mm	H2 mm	g	EURO
1800 07 0607	6x7	105	8.6	9.6	7	8	25	4,60
1800 07 0809	8x9	105	11.2	12.2	9	10	35	5,00
1800 07 1011	10x11	120	13.6	14.6	11	11.5	55	5,39
1800 07 1213	12x13	135	16	17	12	12.5	80	5,76
1800 07 1415	14x15	135	18.5	19.5	13	13.5	110	5,63
1800 07 1617	16x17	150	21	22	14	14.5	150	5,74
1800 07 1819	18x19	150	23	24	15	15.5	170	5,70
1800 07 2022	20x22	165	25.4	27.4	16	18	220	5,91
1800 07 2224	22x24	180	27.4	29.4	18	20	330	5,11,05
1800 07 2427	24x27	180	30.4	33.4	20	23	400	5,12,32

1800

Kovan Anahtar Takımı İki Ağz (mil dahil, mm) Double Ended Tubular Socket Wrench Set with Tommy Bars (mm)

TSE

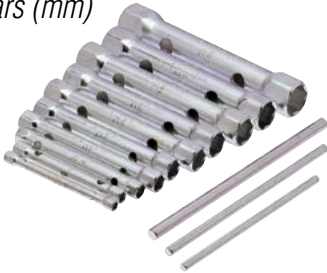

KOD CODE	mm	g	EURO
1800 00 2108	6x7 - 8x9 - 10x11 12x13 - 14x15 - 16x17 18x19 - 20x22 Mil/Handle Bars 5x125-8x180 mm	920	8

1841

Kovan Anahtar Bir Ağz (mil dahil) Single Ended Tubular Socket Wrench with Tommy Bar

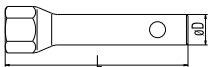

Dikişsiz çelik boru, Çinko kaplı
Seamless steel tube, Zinc plated

KOD CODE	mm		L mm	σD mm	Mil Handle bar mm	g	EURO
	mm	inch					
1841 07 0021	21	13/16"	120	20	10x120	215	5, 6,90

1850

Kovan Anahtar Mili Tommy Bar

TS ISO 3793
DIN 900

KOD CODE	σDxL mm	g	EURO
1850 07 5125	5x125	20	0,95
1850 07 8180	8x180	70	1,61
1850 07 1120	10x120	75	2,06
1850 07 1200	10x200	120	2,35

1870

Ağır Tip Bijon Anahtarı İki Ağz Uzun Double Ended Rim Wrench (long)

TSEK



Yüksek alaşımlı çelik, Nikel kaplı
Special steel, Nickel plated

KOD CODE	mm	L mm	t mm	σD1 mm	σD2 mm	g	EURO
1870 09 2427	24x27	400	34.5	36	40	1135	10, 29,13
1870 09 2730	27x30	400	34.5	40	44	1380	10, 30,22
1870 09 2732	27x32	400	34.5	40	46	1380	10, 31,77
1870 09 3032	30x32	400	34.5	44	46	1380	10, 32,50
1870 09 3233	32x33	400	34.5	46	47	1450	10, 35,14

1874

Ağır Tip Bijon Anahtarı İki Ağz Kısa Double Ended Rim Wrench (short)

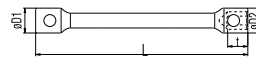

Yüksek alaşımlı çelik, Nikel kaplı
Special steel, Nickel plated

KOD CODE	mm	L mm	t mm	σD1 mm	σD2 mm	g	EURO
1874 09 2224	22x24	170	34.5	34	36	720	10, 10,33
1874 09 2427	24x27	200	34.5	36	40	800	10, 11,74

1850

Bijon Anahtar Mili Tommy Bar

TS ISO 3793
DIN 900

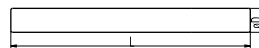

KOD CODE	σDxL mm	g	EURO
1850 09 1630	18x630	1260	1, 9,20

1975

Bijon Anahtarı İstavroz Tipi
Cross Rim Wrench

TS ISO 6788

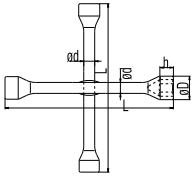

Yüksek alaşımlı çelik, Krom kaplı
Special steel, Chrom plated

KOD CODE	mm	inch	øD mm	h mm	L mm	ød mm	g	EURO	
1975 09 1719	17	11/16"	28	12	420	16	1422	10	16,75
	19	3/4"	30	14					
	21	13/16"	32	16					
	22	7/8"	34	17					

1975

1/2" Adaptörlü Bijon Anahtarı İstavroz Tipi
Cross Rim Wrench (with 1/2" adapter)

TS ISO 6788

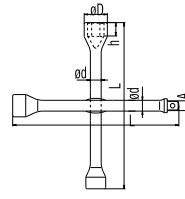

Yüksek alaşımlı çelik, Krom kaplı
Special steel, Chrom plated

KOD CODE	mm	inch	øD mm	h mm	L mm	A mm	ød mm	g	EURO	
1975 09 1322	17	11/16"	28	12	420	12.65	16	1375	10	18,44
	19	3/4"	30	14						
	22	7/8"	34	17						
		1/2"								

1940

Bijon Anahtarı Pipo Tipi (Tornavida Ağızlı)
Offset Socket Wrench with Screwdriver

TSEK

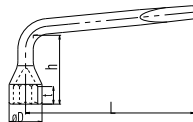

Yüksek alaşımlı çelik, Krom kaplı
Special steel, Chrom plated

KOD CODE	mm	inch	L mm	øD mm	h mm	t mm	g	EURO	
1940 09 0019	19	3/4"	285	28	65	14	470	10	11,20
1940 09 0021	21	13/16"	320	30	85	16	575	10	13,86



1855

Mafsallı T Kol Lokma
T - Handle Wrench with Universal Joint



Özel alaşım çelik, Krom kaplı
Special steel, Chrom plated

KOD CODE	mm	L mm	g	□	EURO
1855 08 0008	8	400	225	10	33,32
1855 08 0010	10	450	405	10	33,32
1855 08 0012	12	450	410	10	33,32
1855 08 0013	13	450	425	10	33,32
1855 08 0017	17	500	485	10	37,09
1855 08 0019	19	510	895	10	47,20

1840

1/2" Mafsallı T Kol
Swivel Handle With Sliding T 1/2"



Özel alaşım çelik, Krom kaplı
Special steel, Chrom plated

KOD CODE	mm	L mm	g	□	EURO
1840 08 0500	1/2"	500	740	10	33,32

3



1610

3/8" Tork Anahtarı
Torque Wrench

TS EN ISO 6789-1
TS EN ISO 6789-2



3/8"

KOD CODE	ÖLÇÜ SIZE	g	□	EURO
1610 06 0100	2.5 - 11 Nm - 0.3 - 1.2 Kg	515	1	116,93
1610 06 0300	5 - 33 Nm - 0.5 - 3.4 Kg	640	1	120,10

1613

1/2" Tork Anahtarı
Torque Wrench

TS EN ISO 6789-1
TS EN ISO 6789-2



1/2"

KOD CODE	ÖLÇÜ SIZE	g	□	EURO
1613 06 1200	25 - 135 Nm - 3 - 14 Kg	1430	1	130,21
1613 06 2000	50 - 225 Nm - 5 - 23 Kg	2165	1	136,06
1613 06 3000	70 - 330 Nm - 7 - 35 Kg	2870	1	141,65

1619

3/4" Tork Anahtarı
Torque Wrench

TS EN ISO 6789-1
TS EN ISO 6789-2



3/4"

KOD CODE	ÖLÇÜ SIZE	g	□	EURO
1619 06 2080	200 - 800 Nm-22-82 kg	8860	1	585,98

1607

1/4" Cıvırlı Tork Anahtar

Torque Wrench With Reversible Ratchet-Head

TS EN ISO 6789-1
TS EN ISO 6789-2



1/4"

KOD CODE	ÖLÇÜ SIZE	g	□	EURO
1607 06 0420	4 - 20 Nm	640	1	104,99

1610

3/8" Cıvırlı Tork Anahtar

Torque Wrench With Reversible Ratchet-Head

TS EN ISO 6789-1
TS EN ISO 6789-2



3/8"

KOD CODE	ÖLÇÜ SIZE	g	□	EURO
1610 06 2010	20 -100 Nm	1300	1	131,23

1613

1/2" Cıvırlı Tork Anahtar

Torque Wrench With Reversible Ratchet-Head

TS EN ISO 6789-1
TS EN ISO 6789-2



1/2"

KOD CODE	ÖLÇÜ SIZE	g	□	EURO
1613 06 4020	40- 200Nm	1590	1	134,51
1613 06 6034	60- 340Nm	1810	1	136,15

1619

3/4" Cıvırlı Tork Anahtar

Torque Wrench With Reversible Ratchet-Head

TS EN ISO 6789-1
TS EN ISO 6789-2



3/4"

KOD CODE	ÖLÇÜ SIZE	Diş Sayısı Gear Teeth	L mm	g	□	EURO
1619 06 1060	100-600 Nm	24	1048	5600	1	392,91

4

Boru Anahtarları ve Penseler Pipe Wrenches and Pliers



- Boru Anahtarları* Pipe Wrenches
- Fort Penseler* Water Pump Pliers
- Ayarlı Penseler* Grip Wrenches
- Penseler* Pliers
- Uzun Kargaburunlar* Long Nose Pliers
- Kerpetenler* Carpenter Pincers
- Elektronikçi Penseler* Electronic Pliers

2100

Stilson Boru Anahtarı
Pipe Wrench, Stilson



TS 3796



4

Yedek parça sayfa 152
Spare parts page 152

Krom vanadyum, Dişler indüksiyonda sertleştirilmiş, Elektrostatik boyanmış
Chrom vanadium, Teeth induction hardened, Electrostatically painted

KOD CODE	L mm	L inch	mm	ÖLÇÜ SIZE Inch	g	□	EURO
2100 10 0008	200	8"	27	3/4"	280	1	22,28
2100 10 0010	250	10"	34	1"	550	1	26,05
2100 10 0012	300	12"	42	1 1/4"	725	1	29,34
2100 10 0014	350	14"	50	1 1/2"	1030	1	35,04
2100 10 0018	450	18"	60	2"	1775	1	47,62
2100 10 0024	600	24"	76	2 1/2"	2775	1	77,07

2110

Ağır Tip Boru Anahtarı
Pipe Wrench, Heavy Duty



Yedek parça sayfa 152
Spare parts page 152

Krom vanadyum, Dişler indüksiyonda sertleştirilmiş, Elektrostatik boyanmış
Chrom vanadium, Teeth induction hardened, Electrostatically painted

KOD CODE	L mm	L inch	mm	ÖLÇÜ SIZE Inch	g	□	EURO
2110 10 0008	200	8"	34	1"	425	1	23,10
2110 10 0010	250	10"	42	1 1/4"	795	1	30,23
2110 10 0012	300	12"	50	1 1/2"	1245	1	35,14
2110 10 0014	350	14"	60	2"	1710	1	40,30
2110 10 0018	450	18"	75	2 1/2"	2685	1	54,31
2110 10 0024	600	24"	90	3"	4370	1	90,76
2110 10 0036	900	36"	140	5"	7600	1	201,82
2110 10 0048	1200	48"	165	6"	15600	1	381,33

2201

Maşalı Boru Anahtarı (85°)
Pipe Wrench (85°)



TS 3796
DIN 5234



Yedek parça sayfa 152
Spare parts page 152

Krom vanadyum, Dişler indüksiyonda sertleştirilmiş, Elektrostatik boyanmış
Chrom vanadium, Teeth induction hardened, Electrostatically painted

KOD CODE	L mm	mm	ÖLÇÜ SIZE Inch	g	□	EURO
2201 10 0010	325	40	1"	870	1	24,56
2201 10 0015	430	60	1 1/2"	1585	1	35,88
2201 10 0020	585	70	2"	2700	1	53,79
2201 10 0030	690	100	3"	4270	1	76,98
2201 10 0040	760	130	4"	5800	1	102,33

2400

Üniversal Fort Pense
Waterpump Pliers Universal



TS 60 TS ISO 8976
DIN ISO 8976



Krom vanadyum, Krom kaplı, PVC izoleli
Chrom vanadium, Chrom plated, PVC insulated

KOD CODE	L mm	L inch	mm	g	□	EURO
2400 11 0160	160	6 1/4"	30	125	5	16,17
2400 11 0240	240	9 1/2"	35	355	5	13,03
2400 11 0315	315	12 1/2"	40	530	5	41,38

2400

1000V İzoleli Üniversal Fort Pense
Insulated Type Waterpump
Pliers Universal 1000V



TS 60
TS ISO 8976



Krom vanadyum, Krom kaplı, çift komponent saplı
Chrom vanadium, Chrom plated, Two component handle

KOD CODE	L mm	L inch	mm	g	EURO
2400 11 6240	240	9 1/2"	35	370	5, 20,75

2500

Üniversal Ayarlı Pense
Universal Grip



Çeneler krom vanadyum çeliğinden dövülmüştür, Nikel kaplama,
Kullanım sahası: Yuvarlak ve düz malzemeler
Jaws Chrom vanadium forged, Nickel plated
Application field : Flat and round materials

KOD CODE	L mm	L inch	mm	g	EURO
2500 11 0250	250	10"	30	560	5, 19,74

2415

Yaylı Fort Pense
Waterpump Pliers With Spring



Krom vanadyum, Karartma, PVC izoleli
Chrom vanadium, Black finish, PVC insulated

KOD CODE	L mm	L inch	mm	g	EURO
2415 11 0240	240	6 1/4"	30	365	5, 22,20

2505

Standart Ayarlı Pense
Standard Grip



Çeneler krom vanadyum çeliğinden dövülmüştür, Nikel kaplama
Kullanım sahası: Düz malzemeler
Jaws, Chrom vanadium forged, Nickel plated
Application field: Flat materials

KOD CODE	L mm	L inch	mm	g	EURO
2505 11 0250	250	10"	30	535	5, 19,74

2510

Spesiyal Ayarlı Pense
Special Grip



Çeneler krom vanadyum çeliğinden dövülmüştür, Nikel kaplama,
Kullanım sahası: Yuvarlak ve düz malzemeler
Jaws Chrom vanadium forged, Nickel plated
Application field: Flat and round materials

KOD CODE	L mm	L inch	mm	g		EURO
2510 11 0250	250	10"	30	550	5	19,74

2511

C tipi Ayarlı Pense
Clamp Grip C-type



Çeneler krom vanadyum çeliğinden dövülmüştür, Nikel kaplama,
Kullanım sahası: Ağılı profillerin tutulmasında
Jaws Chrom vanadium forged, Nickel plated
Application field: For Gripping angled sheet metal

KOD CODE	L mm	L inch	mm	g		EURO
2511 11 0280	280	11"	70	700	1	35,02

2512

Kaynakçı Ayarlı Pense (Düz Ağız)
Lock Grip With Flat Jaws



Özel alaşımli çelikten imal edilmiş, Nikel kaplama,
Kullanım sahası: 80 mm düz çeneleri ile kıvrık metal levhaları
Made from special alloy steel, Nickel plated, Application field:
Gripping sheet metals with 80 mm Flat jaws

KOD CODE	L mm	L inch	mm	g		EURO
2512 11 0200	200	8"	30	485	1	34,08

2513

Kaynakçı Ayarlı Pense (Boru İçin)
Grip For Tubes



Özel alaşımli çelikten imal edilmiş, Nikel kaplama,
Kullanım sahası: Boru malzemeler
Made from special alloy steel, Nickel plated, Application field: Tubes

KOD CODE	L mm	L inch	mm	g		EURO
2513 11 0280	280	11"	50	800	1	34,08

2515

Kaportacı Ayarlı Pense
Welding Grip



Özel alaşımli çelikten imal edilmiş- Nikel kaplama,
Kullanım sahası: Yassı ve köşeli malzemelerde
Application field : Angled corners and edges

KOD CODE	L mm	L inch	mm	g		EURO
2515 11 0270	270	10 5/8"	50	765	1	34,08

3020

Kombine Pense Opak Seri Combination Pliers

TS 60
TS ISO 5746
DIN ISO 5746



Özel alaşımli çelik, Kesici ağızlar induksiyonda sertleştirilmiş
Special steel, Cutters induction hardened

KOD CODE	L mm	L inch	MODEL	g	□	EURO
3020 12 2160	160	6 1/4"	OPAK	205	5	10,12
3020 12 2180	180	7 1/8"	OPAK	275	5	14,85
3020 12 2200	200	8"	OPAK	315	5	16,66

3020

Kombine Pense Kraft Seri Combination Pliers

TS 60
TS ISO 5746
DIN ISO 5746



Özel alaşımli çelik, Kesici ağızlar induksiyonda sertleştirilmiş
Special steel, Cutters induction hardened

KOD CODE	L mm	L inch	MODEL	g	□	EURO
3020 12 3160	160	6 1/4"	KRAFT	225	5	17,43
3020 12 3180	180	7 1/8"	KRAFT	285	5	19,97
3020 12 3200	200	8"	KRAFT	380	5	22,35

3020

Kombine Pense Ergonomik Seri Combination Pliers

TS 60
TS ISO 5746
DIN ISO 5746



Özel alaşımli çelik, Kesici ağızlar induksiyonda sertleştirilmiş
Special steel, Cutters induction hardened

KOD CODE	L mm	L inch	MODEL	g	□	EURO
3020 12 5160	160	6 1/4"	ERGONOMİK	205	5	16,61
3020 12 5180	180	7 1/8"	ERGONOMİK	260	5	19,01
3020 12 5200	200	8"	ERGONOMİK	345	5	21,28

3020

1000V İzoleli Elektrikçi Kombine Pense Electrician Type Insulated Combination Plier 1000V



TS 60
TS ISO 5746
DIN ISO 5746



⚡ 1000 V
IEC 60900



Özel alaşımli çelik, Kesici ağızlar induksiyonda sertleştirilmiş, Krom kaplı
Special steel, Cutters induction hardened, Chrom plated

KOD CODE	L mm	L inch	MODEL	g	□	EURO
3020 12 6160	160	6 1/4"	1000V	205	5	19,05
3020 12 6180	180	7 1/8"	1000V	260	5	20,34
3020 12 6200	200	8"	1000V	345	5	22,63

3030

Kombine Pense Ağır Tip (çelik tel için) Combination Pliers Heavy Duty (for piano wire)



Özel alaşımli çelik, Kesici ağızlar induksiyonda sertleştirilmiş
Special steel, Cutters induction hardened

KOD CODE	L mm	L inch	g	□	EURO
3030 12 2180	180	7 1/8"	285	5	20,96
3030 12 2200	200	8"	380	5	----

3220

Kargaburun Düz Uçlu Opak Seri
Long Nose Pliers (Flat)

TS 60 - TS ISO 5745
DIN ISO 5745



Özel alaşımli çelik, Kesici ağızlar indüksiyonda sertleştirilmiş
Special steel, Cutters induction hardened

KOD CODE	L mm	L inch	MODEL	g	□	EURO
3220 13 2140	140	5 1/2"	OPAK	110	5	13,42
3220 13 2160	160	6 1/4"	OPAK	135	5	14,45
3220 13 2180	180	7 1/8"	OPAK	170	5	16,52
3220 13 2200	200	8"	OPAK	205	5	17,49

3220

Kargaburun Düz Uçlu Ergonomik Seri
Long Nose Pliers (Flat)

TS 60 - TS ISO 5745
DIN ISO 5745



Özel alaşımli çelik, Kesici ağızlar indüksiyonda sertleştirilmiş
Special steel, Cutters induction hardened

KOD CODE	L mm	L inch	MODEL	g	□	EURO
3220 13 5140	140	5 1/2"	ERGONOMİK	110	5	21,00
3220 13 5160	160	6 1/4"	ERGONOMİK	140	5	21,69
3220 13 5180	180	7 1/8"	ERGONOMİK	160	5	22,76
3220 13 5200	200	8"	ERGONOMİK	170	5	24,03

3220

Kargaburun Düz Uçlu Kraft Seri
Long Nose Pliers (Flat)

TS 60 - TS ISO 5745
DIN ISO 5745



Özel alaşımli çelik, Kesici ağızlar indüksiyonda sertleştirilmiş
Special steel, Cutters induction hardened

KOD CODE	L mm	L inch	MODEL	g	□	EURO
3220 13 3140	140	5 1/2"	KRAFT	120	5	21,00
3220 13 3160	160	6 1/4"	KRAFT	155	5	21,69
3220 13 3180	180	7 1/8"	KRAFT	185	5	22,76
3220 13 3200	200	8"	KRAFT	210	5	24,03

3220

1000V İzoleli Elektrikçi Kargaburun
Insulated Electrician Type
Long Nose Plier 1000V



TS 60
TS ISO 5745
DIN ISO 5745
⚡ 1000 V
IEC 60900



Özel alaşımli çelik, Kesici ağızlar indüksiyonda sertleştirilmiş, Krom kaplı
Special steel, Cutters induction hardened, Chrom plated

KOD CODE	L mm	L inch	MODEL	g	□	EURO
3220 13 6140	140	5 1/2"	1000V	110	5	21,43
3220 13 6160	160	6 1/4"	1000V	140	5	23,69
3220 13 6180	180	7 1/8"	1000V	160	5	24,18
3220 13 6200	200	8"	1000V	170	5	25,03



3225

Kargaburun Eğri Uçlu Opak Seri
Long Nose Pliers (Bent)

TS 60 - TS ISO 5745



3225

Kargaburun Eğri Uçlu Kraft Seri
Long Nose Pliers (Bent)

TS 60 - TS ISO 5745



4

Özel alaşımli çelik, Kesici ağızlar indüksiyonda sertleştirilmiş
Special steel, Cutters induction hardened

KOD CODE	L mm	L inch	MODEL	g	□	EURO
3225 13 2160	160	6 1/4"	OPAK	140	5	16,02
3225 13 2180	180	7 1/8"	OPAK	170	5	17,56
3225 13 2200	200	8"	OPAK	175	5	19,60

Özel alaşımli çelik, Kesici ağızlar indüksiyonda sertleştirilmiş
Special steel, Cutters induction hardened

KOD CODE	L mm	L inch	MODEL	g	□	EURO
3225 13 3160	160	6 1/4"	KRAFT	150	5	22,76
3225 13 3180	180	7 1/8"	KRAFT	190	5	23,85
3225 13 3200	200	8"	KRAFT	195	5	25,26



3700

Yan Keski Opak Seri
Side Cutting Pliers

TS 60 - TS ISO 5749
DIN ISO 5749



Özel alaşımli çelik, Kesici ağızlar indüksiyonda sertleştirilmiş
Special steel, Cutters induction hardened

KOD CODE	L mm	L inch	MODEL	g	□	EURO
3700 16 2140	140	5 1/2"	OPAK	165	5	13,76
3700 16 2160	160	6 1/4"	OPAK	230	5	16,57
3700 16 2180	180	7 1/8"	OPAK	230	5	18,23

3700

Yan Keski Ergonomik Seri
Side Cutting Pliers

TS 60 - TS ISO 5749
DIN ISO 5749



Özel alaşımli çelik, Kesici ağızlar indüksiyonda sertleştirilmiş
Special steel, Cutters induction hardened

KOD CODE	L mm	L inch	MODEL	g	□	EURO
3700 16 5140	140	5 1/2"	ERGONOMİK	165	5	18,49
3700 16 5160	160	6 1/4"	ERGONOMİK	215	5	20,91
3700 16 5180	180	7 1/8"	ERGONOMİK	215	5	24,23

3700

Yan Keski Kraft Seri
Side Cutting Pliers

TS 60 • DIN ISO 5749
DIN ISO 5749



Özel alaşımli çelik, Kesici ağızlar indüksiyonda sertleştirilmiş
Special steel, Cutters induction hardened

KOD CODE	L mm	L inch	MODEL	g	□	EURO
3700 16 3140	140	5 1/2"	KRAFT	190	5	18,49
3700 16 3160	160	6 1/4"	KRAFT	240	5	20,91
3700 16 3180	180	7 1/8"	KRAFT	255	5	24,23

3700

1000V İzoleli Elektrikçi Yan Keski
Insulated Electrician Type Side Cutter 1000V

TS 60
TS ISO 5749
DIN ISO 5749

⚡ 1000 V
IEC 60900



Özel alaşımli çelik, Kesici ağızlar indüksiyonda sertleştirilmiş, Krom kaplı
Special steel, Cutters induction hardened, Chrom plated

KOD CODE	L mm	L inch	MODEL	g	□	EURO
3700 16 6140	140	5 1/2"	1000V	165	5	20,50
3700 16 6160	160	6 1/4"	1000V	215	5	22,95
3700 16 6180	180	7 1/8"	1000V	225	5	26,25

3705

İnce Uçlu Yan Keski (Plastikler İçin)
Side Cutter For Plastics

TS 60
TS ISO 5749

3730

Yan Keski Ağır Tip (çelik tel için)
Side Cutter Heavy Duty (for piano wire)

YENİ
NEW



4

Özel alaşımli çelik, Kesici ağızlar induksiyonda sertleştirilmiş, PVC izoleli
Special steel, Cutters induction hardened, PVC insulated

Özel alaşımli çelik, Kesici ağızlar induksiyonda sertleştirilmiş
Special steel, Cutters induction hardened

KOD CODE	L mm	L inch	g	□	EURO
3705 16 5160	160	6 1/4"	220	5	18,31

KOD CODE	L mm	L inch	g	□	EURO
3730 16 2160	160	6 1/4"	200	5	21,96
3730 16 2200	200	8"	320	5	27,48



3301

Dış Segman Pense (Düz)
Circlip Pliers, External (Flat)

TS 60
DIN 5254



Krom vanadyum, Krom kaplı, PVC izoleli
Chrom vanadium, Chrom plated, PVC insulated

KOD CODE	L mm	⌀	g	□	EURO
3301 12 0140	140	10 - 25	90	5	16,53
3301 12 0180	180	19 - 60	195	5	18,91
3301 12 0225	225	40 - 100	235	5	21,34
3301 12 0295	295	85 - 165	445	5	52,91

3321

İç Segman Pense (Düz)
Circlip Pliers Internal (Flat)

TS 60
DIN 5256



Krom vanadyum, Krom kaplı, PVC izoleli
Chrom vanadium, Chrom plated, PVC insulated

KOD CODE	L mm	⌀	g	□	EURO
3321 12 0140	140	8 - 25	100	5	14,43
3321 12 0180	180	19 - 60	185	5	16,95
3321 12 0225	225	40 - 100	250	5	19,45
3321 12 0310	310	85 - 165	445	5	51,77

3311

Dış Segman Pense (Eğri)
Circlip Pliers, External (Bent)

TS 60
DIN 5254



Krom vanadyum, Krom kaplı, PVC izoleli
Chrom vanadium, Chrom plated, PVC insulated

KOD CODE	L mm	⌀	g	□	EURO
3311 12 0125	125	10 - 25	105	5	16,75
3311 12 0170	170	19 - 60	190	5	19,47
3311 12 0210	210	40 - 100	250	5	22,08
3311 12 0275	275	85 - 165	445	5	56,41

3331

İç Segman Pense (Eğri)
Circlip Pliers Internal (Bent)

TS 60
DIN 5256



Krom vanadyum, Krom kaplı, PVC izoleli
Chrom vanadium, Chrom plated, PVC insulated

KOD CODE	L mm	⌀	g	□	EURO
3331 12 0130	130	8 - 25	105	5	15,70
3331 12 0170	170	19 - 60	185	5	18,55
3331 12 0210	210	40 - 100	250	5	21,40
3331 12 0290	290	85 - 165	440	5	52,26

3420

Hortum Kelepçe Pensesi
Hose Clamp Pliers



KOD CODE	L mm	L inch	g		EURO
3420 12 0220	220	8 3/4"	185	5	13,00

3425

Hortum Kelepçe Pensesi (Sıkıştırma Tipi)
Hose Clamp Pliers



KOD CODE	L mm	L inch	g		EURO
3425 12 0220	235	9 1/4"	355	5	13,30

3852

Delik Zimba
Revolving Punch Pliers



KOD CODE	L mm	L inch	g		EURO
3852 24 0225	225	9"	270	5	16,02

3715

Tek Ağızlı Kablo Kesici
Cable Cutter



Özel alaşımlı çelik, Kesici ağızlar induksiyonda sertleştirilmiş, PVC izoleli
Special steel, Cutters induction hardened, PVC insulated

KOD CODE	L mm	L inch	g		EURO
3715 16 0165	165	6 1/4	140	5	13,16

3720

Çift Ağızlı Kablo Kesici
Cable Cutter, Double Cutter



Özel alaşımlı çelik, Kesici ağızlar induksiyonda sertleştirilmiş, PVC izoleli
Special steel, Cutters induction hardened, PVC insulated

KOD CODE	L mm	L inch	g		EURO
3720 16 0220	220	8"	320	5	20,78

3860

Testere Çaprazı
Saw - Setting Pliers

TSEK



Özel alaşımlı çelik, İndüksiyonda sertleştirilmiş,
Natural Vernikli, PVC izoleli
Special steel, induction hardened, PVC insulated

KOD CODE	L mm	L inch	g		EURO
3860 26 0180	180	7 1/8"	245	5	18,81

3550

Elektronikçi Yan Keski
Electronic Diagonal Side Cutting Pliers



Özel alaşımli çelik
Special steel

KOD CODE	L mm	g		EURO
3550 14 0125	125	76	5	12,16

3553

Elektronikçi Düz Uçlu Kargaburun
Electronic Flat Nose Pliers



Özel alaşımli çelik
Special steel

KOD CODE	L mm	g		EURO
3553 14 0150	150	88	5	12,16

4

3551

Elektronikçi Tepe Keski
Electronic End Cutting Pliers

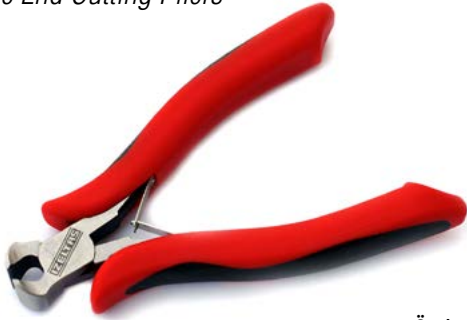

Özel alaşımli çelik
Special steel

KOD CODE	L mm	g		EURO
3551 14 0125	125	77	5	12,16

3554

Elektronikçi Uzun Kargaburun
Electronic Long Nose Pliers



Özel alaşımli çelik
Special steel

KOD CODE	L mm	g		EURO
3554 14 0150	150	88	5	12,16

3552

Elektronikçi Yuvarlak Uçlu Kargaburun
Electronic Round Nose Pliers



Özel alaşımli çelik
Special steel

KOD CODE	L mm	g		EURO
3552 14 0125	125	78	5	12,16

3555

Elektronikçi Sivri Uçlu Düz Kargaburun
Electronic Needle Flat Nose Pliers



Özel alaşımli çelik
Special steel

KOD CODE	L mm	g		EURO
3555 14 0150	150	86	5	12,16

3556

Elektronikçi Sivri Uçlu Eğri Kargaburun
Electronic Needle Bent Nose Pliers



Özel alaşımli çelik
Special steel

KOD CODE	L mm	g	□	EURO
3556 14 0150	150	85	5	12,16

3557

Elektronikçi Pense
Electronic Pliers



Özel alaşımli çelik
Special steel

KOD CODE	L mm	g	□	EURO
3557 14 0125	125	80	5	12,16

3560 00 2104

Elektronikçi Keski ve Pense Seti (4 Parça)
Electronic Cutter & Pliers Set (4 Pcs)



KOD CODE	L mm	İÇERİK CONTENTS	□	TL Ad.
3550 14 0125	125	Elektronikçi Yan Keski Electronic Diagonal Side Cutting Pliers	1	48,64
3551 14 0125	125	Elektronikçi Tepe Keski Electronic End Cutting Pliers	1	
3554 14 0150	150	Elektronikçi Uzun kargaburun Electronic Long Nose Pliers	1	
3557 14 0125	125	Elektronikçi Pense Electronic Pliers	1	

3565 00 2104

Elektronikçi Kargaburun Seti (4 Parça)
Electronic Long Nose Pliers Set (4 Pcs)

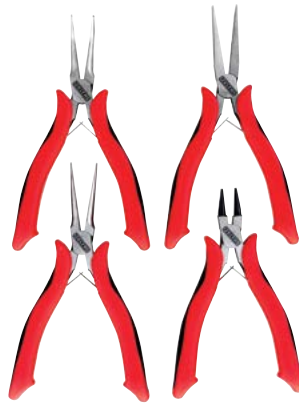

KOD CODE	L mm	İÇERİK CONTENTS	□	TL Ad.
3552 14 0125	125	Elektronikçi Yuvarlak Uçlu Kargaburun Electronic Round Nose Pliers	1	48,64
3553 14 0150	150	Elektronikçi Düz Uçlu Kargaburun Electronic Flat Nose Pliers	1	
3555 14 0150	150	Elektronikçi Sivri Uçlu Düz Kargaburun Electronic Needle Nose Pliers	1	
3556 14 0150	150	Elektronikçi Sivri Uçlu Eğri Kargaburun Electronic Bent Needle Nose Pliers	1	

4

3800

Kerpeten
Carpenter Pincers

TS 60 - TS ISO 9243
DIN ISO 9243



Özel alaşımlı çelik,
Kesici ağızlar indüksiyonda sertleştirilmiş,
Vernikli, PVC izoleli
Special steel, Cutters induction hardened,
Lacquered, PVC insulated

KOD CODE	L mm	L inch	g	EURO
3800 15 0160	160	6 1/4"	220	12,95
3800 15 0180	180	7 1/8"	295	13,29
3800 15 0200	200	8"	330	13,94
3800 15 0250	250	10"	530	19,90

3830

Betoncu Kerpeteni
Tower Pincers

TS 60 • TS ISO 9242
DIN ISO 9242



Özel alaşımlı çelik, Kesici ağızlar indüksiyonda sertleştirilmiş,
Vernikli, PVC izoleli
Special steel, Cutters induction hardened,
Lacquered, PVC insulated

KOD CODE	L mm	L inch	g	EURO
3830 15 0225	225	9"	345	13,94
3830 15 0250	250	10"	395	15,58
3830 15 0280	280	11"	450	17,65

3831

Betoncu Kerpeteni Yaylı
Tower Pincers with spring

TS 60 - TS ISO 9242
DIN ISO 9242



Özel alaşımlı çelik, Kesici ağızlar indüksiyonda sertleştirilmiş,
Vernikli, PVC izoleli
Special steel, Cutters induction hardened,
Lacquered, PVC insulated

KOD CODE	L mm	L inch	g	EURO
3831 15 0280	280	11"	455	27,55

3835

Ağır Tip Betoncu Kerpeteni
Heavy Duty Tower Pincers

TS 60 - TS ISO 9242
DIN ISO 9242



Özel alaşımlı çelik, Kesici ağızlar indüksiyonda sertleştirilmiş,
Vernikli, PVC izoleli
Special steel, Cutters induction hardened,
Lacquered, PVC insulated

KOD CODE	L mm	L inch	g	EURO
3835 15 0280	280	11"	435	18,11

3850

Danalya
Shoemaker Pliers



Özel alaşımlı çelik, İndüksiyonda sertleştirilmiş, Siyah Oksit kaplı
Special steel, Induction hardened, Black finish

KOD CODE	L mm	L inch	g	EURO
3850 12 0200	200	8"	360	19,85

5

1000V İzoleli Aletler

1000V Insulated Tools



VDE belgeli ürünler ilgili uluslararası standartlara göre kontrol edildikten sonra ek olarak 5 ayrı teste tabi tutulur.

- 1- Voltaj Testi : 3 dakika boyunca 10.000 V'a tabi tutulan izoleli el aletinde kaçak yada elektrik akımı atlama olmamalıdır.
- 2- Soğuk Şoklama Testi : -24 derece 2 saat bekletilmiş (şoklanmış) el aletine 60-80 cm yükseklikten 600gr ağırlık ile darbeler uygulanır. İzolede kırılma yada çatlama olmamalıdır.
- 3- Dayanıklılık Testi : +70 derece 1 hafta bekletilmiş el aletine 50kg yük ile sap sökme testi uygulanır. Sap yerinden çıkmamalıdır.
- 4- Geçirgenlik Testi : 5000V elektrik akımına karşı 3 dakika boyunca 2kg sivri uçlu ağırlıkta baskı yapılarak elektrik verilir. Kaçak yada elektrik atlama olmamalıdır.
- 5- Yanma Testi : Yüksek yoğunluktaki alev 20 saniye maruz bırakılarak teste tabi tutulur. Alevden uzaklaştırılan izole yanmaya devam etmemelidir.

After internationally recognised standard controls, VDE certified hand tools are passed through 5 additional tests.

- 1- Voltage test : For 3 minutes under 10.000V, no current leak should occur in the handle
- 2- Cold shock test : Tools are kept in -24 degrees Celcius for 2 hours. A mass with 600gr is dropped on the handle from 60-80cm. No crack or break on the handle should occur.
- 3- Durability test : Tools are kept in +70 degrees Celcius for 1 week. When a force of 50kg is applied, handle should not pull away from the tool.
- 4- Conductivity test : Under 5.000V, a mass of 2 kg with a point tip is pressed onto the handle for 3 minutes. No current leakage should occur.
- 5- Flame retardancy test: When applied to an open flame for 20 seconds, handle material should not catch flame.

0255

Süper İzole Çatal Bir Ağız Anahtar (mm)
Single Ended Open Jaw Wrench
Super Insulated (mm)



Krom vanadyum, Krom kaplı, Kalın PVC izoleli
Chrom vanadium, Chrom plated, Triple PVC insulated

5

KOD CODE	mm	L mm	g	□	EURO
0255 01 0010	10	110	40	10	3,03
0255 01 0011	11	120	45	10	3,25
0255 01 0012	12	130	50	10	3,71
0255 01 0013	13	140	60	10	3,71
0255 01 0014	14	155	75	10	4,38
0255 01 0017	17	170	100	10	5,22
0255 01 0019	19	185	150	10	5,31
0255 01 0022	22	200	200	10	7,59
0255 01 0024	24	220	280	10	9,25

0435

Süper İzoleli Bir Ağız Yıldız Anahtar (mm)
Single Ended Ring Wrench Super
Insulated (mm)



Krom vanadyum, Krom kaplı, Kalın PVC izoleli
Chrom vanadium, Chrom plated, Triple PVC insulated

KOD CODE	mm	L mm	g	□	EURO
0435 03 0010	10	170	100	10	4,93
0435 03 0011	11	180	110	10	4,74
0435 03 0012	12	190	130	10	4,00
0435 03 0013	13	200	150	10	4,38
0435 03 0014	14	215	180	10	5,06
0435 03 0017	17	230	220	10	5,00
0435 03 0019	19	245	270	10	5,82
0435 03 0022	22	260	310	10	8,35
0435 03 0024	24	280	420	10	10,19

2400

1000V İzoleli Üniöersal Fort Pense
Insulated Type Waterpump
Pliers Universal 1000V



TS 60
TS ISO 8976



Krom vanadyum, Krom kaplı, çift komponent saplı
Chrom vanadium, Chrom plated, Two component handle

KOD CODE	L mm	L inch	mm	g	□	EURO
2400 11 6240	240	9 1/2"	35	370	5	20,75

3020

1000V İzoleli Elektrikçi Kombine Pense
Insulated Electrician Type
Combination Plier 1000V



TS 60
TS ISO 5746
DIN ISO 5746



1000 V
IEC 60900



Özel alaşımli çelik, Kesici ağızlar indüksiyonda sertleştirilmiş, Krom kaplı
Special steel, Cutters induction hardened, Chrom plated

KOD CODE	L mm	L inch	MODEL	g	□	EURO
3020 12 6160	160	6 1/4"	1000V	205	5	19,05
3020 12 6180	180	7 1/8"	1000V	260	5	20,34
3020 12 6200	200	8"	1000V	345	5	22,63

3220

1000V İzoleli Elektrikçi Kargaburun
Insulated Electrician Type
Nose Plier 1000V

YENİ
NEW



TS 60
TS ISO 5745
DIN ISO 5745
△ 1000 V
IEC 60900



Özel alaşımli çelik, Kesici ağızlar indüksiyonda sertleştirilmiş, Krom kaplı
Special steel, Cutters induction hardened, Chrom plated

KOD CODE	L mm	L inch	MODEL	g	□	EURO
3220 13 6140	140	5 1/2"	1000V	110	5	21,43
3220 13 6160	160	6 1/4"	1000V	140	5	23,69
3220 13 6180	180	7 1/8"	1000V	160	5	24,11
3220 13 6200	200	8"	1000V	170	5	25,03

3700

1000V İzoleli Elektrikçi Yan Keski
Insulated Electrician Type Side Cutter 1000V

YENİ
NEW



TS 60
TS ISO 5749
DIN ISO 5749
△ 1000 V
IEC 60900



Özel alaşımli çelik, Kesici ağızlar indüksiyonda sertleştirilmiş, Krom kaplı
Special steel, Cutters induction hardened, Chrom plated

KOD CODE	L mm	L inch	MODEL	g	□	EURO
3700 16 6140	140	5 1/2"	1000V	165	5	20,50
3700 16 6160	160	6 1/4"	1000V	215	5	22,95
3700 16 6180	180	7 1/8"	1000V	225	5	26,25

4140

1000V İzoleli Elektrikçi Düz Uçlu Tornavida
Insulated Electrician Type Flat
Screwdriver 1000V

TS 59
TS ISO 2380-1
DIN ISO 2380-1
△ 1000 V
IEC 60900

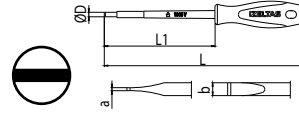

Krom vanadyum, Siyah oksit kaplı
Chrom vanadium, Black finish

KOD CODE	øDxL1 mm	⊖		L mm	g	□	EURO
		a mm	b mm				
4140 17 2575	2.5x75	0.4	2.5	150	25	10	2,56
4140 17 4100	4x100	0.8	4	185	40	10	3,40
4140 17 5512	5.5x125	1	5.5	220	70	10	4,45
4140 17 6515	6.5x150	1.2	6.5	245	90	10	5,85

4145

1000V İzoleli Elektrikçi Yıldız Uçlu Tornavida
Insulated Electrician Type Phillips
Screwdriver 1000V

TS 59 TS 59-5
ISO 8764 DIN ISO 8764
△ 1000 V
IEC 60900

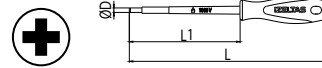

Krom vanadyum, Siyah oksit kaplı
Chrom vanadium, Black finish

KOD CODE	øDxL1 mm	+	L mm	g	□	EURO
4145 18 0360	3x60	Ph0	135	25	10	3,15
4145 18 4580	4.5x80	Ph1	165	45	10	4,35
4145 18 6100	6x100	Ph2	195	70	10	5,75

4140

1000V İzoleli Elektrikçi Tornavida Seti (6 Parça)
Insulated Electrician Set (6 Pcs) Screwdriver 1000V

YENİ
NEW



KOD CODE	İÇERİK CONTENTS	g	□	EURO
4140 00 9106	2.5x75 - 4x100 ⊖ 5.5x125 - 6.5x150 Düz uçlu / Flat	340	6	26,36
	4.5x80 - 6x100 ⊕ Yıldız uçlu / Phillips			

4773

1000V Süngüsü İzoleli Lokma Uçlu Tornavida
Nut Spinner, Electrician Blade Insulated
1000V

DIN 3125

YENİ
NEW

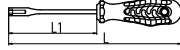

Krom vanadyum, iki komponent saplı
Chrome vanadium, Two component handle

5

KOD CODE	mm	L mm	L1 mm	g		EURO
4773 19 0040	4	220	125	90	10	13,49
4773 19 0050	5	220	125	90	10	13,49
4773 19 0055	5.5	220	125	90	10	13,49
4773 19 0060	6	220	125	90	10	13,49
4773 19 0070	7	230	125	110	10	14,48
4773 19 0080	8	230	125	120	10	14,48
4773 19 0090	9	230	125	125	10	15,62
4773 19 0100	10	230	125	125	10	15,62
4773 19 0110	11	230	125	140	10	17,11
4773 19 0120	12	230	125	145	10	18,33
4773 19 0130	13	230	125	150	10	19,76
4773 19 0140	14	230	125	150	10	21,38

4773

1000V Süngüsü İzoleli Lokma Uçlu Tornavida Seti (8 Parça)
Nut Spinner, Electrician Blade Insulated Set (8 Pcs)
1000V

YENİ
NEW



KOD CODE	İÇERİK CONTENTS	g		EURO
4773 00 8108	6 - 7 - 8 - 9 - 10 - 11 - 12 - 13	2225	8	117,89

4783

1000V Süngüsü İzoleli Manyetik Bits Tutucu Tornavida
Screwdriver, Magnetic Bit Holder Insulated
1000V

1000 V
IEC 60900

YENİ
NEW

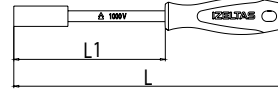

KOD CODE	mm	L mm	L1 mm	g		EURO
4783 19 6120	6.3	230	120	115	10	12,00

8795 00 6005

1000V İzoleli Elektrikçi Seti (5 Parça)
1000V Insulated Tool Set (5 Pcs)

YENİ
NEW



KOD CODE	İÇERİK CONTENTS		EURO
3020 12 6180	180 mm 1000V İzoleli Elektrikçi Kombine Pense Insulated Electrician Type Combination Pliers 1000V	1	78,52
3220 13 6200	200 mm 1000V İzoleli Elektrikçi Kargaburun Insulated Electrician Type Nose Pliers	1	
3700 16 6160	160 mm 1000V İzoleli Elektrikçi Yankeki Insulated Electrician Type Nose	1	
4140 17 5512	5.5x125 1000V Elektrikçi Düz Uçlu Tornavida Insulated Electrician Type Flat Screwdriver 1000V	1	
4145 18 6100	6x100 1000V İzoleli Elektrikçi Yıldız Uçlu Tornavida Insulated Electrician Type Phillips Screwdriver 1000V	1	

6

Tornavida ve Allen Anahtarlar Screwdrivers and Hex Key Wrenches



Tornavidalar Screwdrivers
Kontrol Kalemleri Testers
Bits Uçlar ve Aparatları Bits
Allen Anahtarlar Hex Key Wrenches

4550

Elektrik Kontrol Kalemi (Düz Uçlu)
Voltage Tester (Flat)

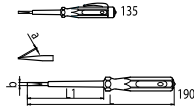

Krom vanadyum, Krom kaplı, Şeffaf selüloz asetat saplı
Chrom vanadium, Chrom plated, Transparent cellulose acetate handle

KOD CODE	L mm	⊖		L1 mm	g	□	EURO
		a mm	b mm				
4550 17 0135	135	0.5	3	60	20	10	2,63
4550 17 0190	190	0.8	4	100	40	10	3,27

4555

Master Kontrol Kalemi (Düz Uçlu)
Voltage Tester Master (Flat)

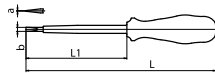

Krom vanadyum, Krom kaplı, Şeffaf selüloz asetat saplı
Chrom vanadium, Chrom plated, Transparent cellulose acetate handle

KOD CODE	L mm	⊖		L1 mm	g	□	EURO
		a mm	b mm				
4555 17 0165	165	0.5	3.5	88	40	10	2,93

4560

Elektrik Kontrol Kalemi (Yıldız Uçlu)
Voltage Tester Phillips

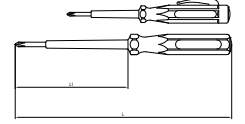

Krom vanadyum, Krom kaplı, Şeffaf selüloz asetat saplı
Chrom vanadium, Chrom plated, Transparent cellulose acetate handle

KOD CODE	L mm	L1 mm	+	g	□	EURO
4560 18 0135	135	60	Ph0	20	10	2,83
4560 18 0190	190	100	Ph0	35	10	3,57

4565

Oto Kontrol Kalemi
Car Voltage Tester

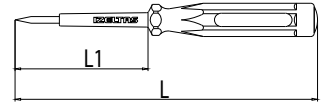

Krom vanadyum, Krom kaplı, Şeffaf selüloz asetat saplı
Chrom vanadium, Chrom plated, Transparent cellulose acetate handle

Tüm otomobil ve ağır vasıta araçlarda 6-24V arası elektrik tesisatının kontrol edilmesinde kullanılır. Sivri uçlu olması sebebiyle kablo ve soketleri yerinden sökmeden kontrol kolaylığı sağlar.

Tool is used to control 6-24V electrical wiring in all cars and heavy duty vehicles. With its point tip, wires and sockets are not required to be disassembled.

KOD CODE	L mm	L1 mm	●	Kablo L (m)	g	□	EURO
4565 17 0135	135	60		1	30	10	7,00

4100

Kraft Seri Düz Uçlu Tornavida
Screwdriver, Kraft, Flat

TS ISO 2380 - 1
DIN ISO 2380-1



Krom vanadyum, Krom kaplı, Ucu siyah oksit, Selüloz asetat saplı
Chrom vanadium, Chrom plated and black tip,
Cellulose acetate handle

KOD CODE	øDxL1 mm	⊖		L mm	g	□	EURO
		a mm	b mm				
4100 17 0340	3x40	0.5	3	110	20	10	2,10
4100 17 0380	3x80	0.5	3	155	35	10	2,33
4100 17 0480	4x80	0.8	4	165	50	10	2,63
4100 17 4100	4x100	0.8	4	185	50	10	3,09
4100 17 0580	5x80	1.0	5.5	175	70	10	2,85
4100 17 5100	5x100	1.0	5.5	195	75	10	3,27
4100 17 5125	5x125	1.0	5.5	220	80	10	4,04
4100 17 5150	5x150	1.0	5.5	245	80	10	4,87
4100 17 6100	6x100	1.2	6.5	195	85	10	3,59
4100 17 6125	6x125	1.2	6.5	220	90	10	4,70
4100 17 6150	6x150	1.2	6.5	245	95	10	5,57
4100 17 6175	6x175	1.2	6.5	270	100	10	6,02
4100 17 7125	7x125	1.2	8	230	120	10	5,00
4100 17 7150	7x150	1.2	8	255	130	10	5,81
4100 17 7175	7x175	1.2	8	280	135	10	6,26
4100 17 8150	8x150	1.6	10	255	145	10	6,43
4100 17 8175	8x175	1.6	10	280	150	10	7,18
4100 17 8200	8x200	1.6	10	305	160	10	7,67
4100 17 9200	9x200	2.0	12	305	190	10	8,51
4100 17 1125	11x250	2.5	14	365	305	10	10,63



4100

Kraft Seri Düz Uçlu Tornavida Seti (8 Parça)
Screwdriver, Flat, Kraft Set (8 Pcs)



KOD CODE	İÇERİK CONTENTS	g	□	EURO
4100 00 8108	3x80 - 4x80 - 4x100 5x100 - 5x125 - 6x100 6x125 - 6x150 ⊖ Düz uçlu / Flat	550	8	29,22

4100

Kraft Seri Süngüsü Uzun Düz Uçlu Tornavida
Screwdriver, Kraft, Flat, Long

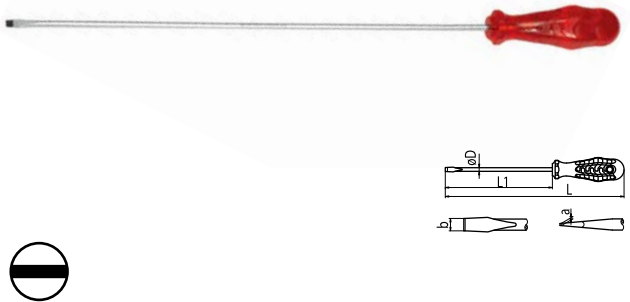

Krom vanadyum, Krom kaplı, Ucu siyah oksit, Selüloz asetat saplı
Chrom vanadium, Chrom plated and black tip,
Cellulose acetate handle

KOD CODE	øDxL1 mm	⊖		L mm	g	□	EURO
		a mm	b mm				
4100 17 4300	4x300	0.8	4	385	70	10	10,09
4100 17 5250	5x250	1.0	5.5	345	95	10	11,26
4100 17 5350	5x350	1.0	5.5	445	115	10	12,73
4100 17 6350	6x350	1.2	6.5	445	125	10	13,52

4120

Kraft Seri Yıldız Uçlu Tornavida
Screwdriver, Kraft, Phillips

TS 59 - 5 ISO 8764-1
DIN ISO 8764-1

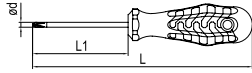

Krom vanadyum, Krom kaplı, Ucu siyah oksit, Selüloz asetat saplı
Chrom vanadium, Chrom plated and black tip,
Cellulose acetate handle.

KOD CODE	ØdxL1 mm	+	L mm	g	□	EURO
4120 18 0360	3x60	Ph0	135	30	10	2,85
4120 18 4580	4.5x80	Ph1	165	55	10	3,95
4120 18 5100	4.5x100	Ph1	185	55	10	4,48
4120 18 5150	4.5x150	Ph1	235	60	10	5,37
4120 18 6100	6x100	Ph2	195	85	10	5,22
4120 18 6150	6x150	Ph2	245	95	10	6,26
4120 18 6200	6x200	Ph2	295	105	10	7,83
4120 18 8150	8x150	Ph3	255	150	10	9,33
4120 18 1200	10x200	Ph4	315	240	10	11,67

6

4120

Kraft Seri Yıldız Uçlu Tornavida Seti (6 parça)
Screwdriver, Kraft, Phillips, Set (6 Pcs)



KOD CODE	İÇERİK CONTENTS	g	□	EURO
4120 00 8106	3x60 - 4.5x80 4.5x100 - 4.5x150 6x100 - 6x150 Yıldız uçlu / Phillips	380	6	28,12

4120

Kraft Seri Süngüsü Uzun Yıldız Uçlu Tornavida
Screwdriver, Kraft, Phillips, Long

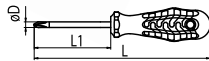

Krom vanadyum, Krom kaplı, Ucu siyah oksit, Selüloz asetat saplı
Chrom vanadium, Chrom plated and black tip,
Cellulose acetate handle

KOD CODE	ØDxL1 mm	+	L mm	g	□	EURO
4120 18 5300	4.5x300	Ph1	385	80	10	15,58
4120 18 6300	6x300	Ph2	395	125	10	16,09

4100

Kraft Seri Tornavida Seti (7 parça)
Screwdriver Set, Kraft (7 Pcs)



KOD CODE	İÇERİK CONTENTS	g	□	EURO
4100 00 8107	3x80 - 4x80 - 4x100 5x125 - 6x150 Düz uçlu / Flat 4.5x80 - 6x100 Yıldız uçlu / Phillips	445	7	27,30

4110

Kraft Seri Düz Uçlu Topaç Tornavida
Screwdriver, Kraft, Stubby, Flat

TS 59

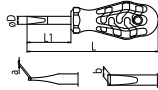

Krom vanadyum, Krom kaplı, Ucu siyah oksit, Selüloz asetat saplı
Chrom vanadium, Chrom plated and black tip,
Cellulose acetate handle

KOD CODE	øDxL1 mm	⊖		L mm	g	□	EURO
		a mm	b mm				
4110 17 5525	5.5x25	1	5.5	70	30	5	2,40
4110 17 5540	5.5x40	1	5.5	105	45	5	3,20
4110 17 6525	6.5x25	1.2	6.5	70	35	5	2,89
4110 17 6540	6.5x40	1.2	6.5	105	50	5	4,27

4130

Kraft Seri Yıldız Uçlu Topaç Tornavida
Screwdriver, Kraft, Stubby, Phillips

TS 59-5

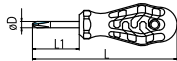

Krom vanadyum, Krom kaplı, Ucu siyah oksit, Selüloz asetat saplı
Chrom vanadium, Chrom plated and black tip,
Cellulose acetate handle

KOD CODE	øDxL1 mm	⊕	L mm	g	□	EURO
4130 18 4540	4.5x40	Ph1	105	40	5	3,42
4130 18 0625	6x25	Ph2	70	30	5	3,83
4130 18 0640	6x40	Ph2	105	50	5	4,40

4140

1000V İzoleli Elektrikçi Düz Uçlu Tornavida
Insulated Electrician Type Flat
Screwdriver 1000V

TS 59 TS ISO 2380-1
DIN ISO 2380-1
⚡ 1000 V
IEC 60900

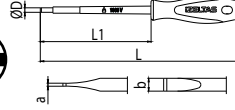

Krom vanadyum, Siyah oksit kaplı
Chrom vanadium, Black finish

KOD CODE	øDxL1 mm	⊖		L mm	g	□	EURO
		a mm	b mm				
4140 17 2575	2.5x75	0.4	2.5	150	25	10	2,56
4140 17 4100	4x100	0.8	4	185	40	10	3,40
4140 17 5512	5.5x125	1	5.5	220	70	10	4,45
4140 17 6515	6.5x150	1.2	6.5	245	90	10	5,85

4145

1000V İzoleli Elektrikçi Yıldız Uçlu Tornavida
Insulated Electrician Type Phillips
Screwdriver 1000V

TS 59 TS 59-5
ISO 8764 DIN ISO 8764
⚡ 1000 V
IEC 60900

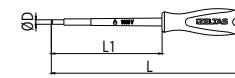

Krom vanadyum, Siyah oksit kaplı
Chrom vanadium, Black finish

KOD CODE	øDxL1 mm	⊕	L mm	g	□	EURO
4145 18 4580	4.5x80	Ph1	165	45	10	4,35
4145 18 6100	6x100	Ph2	195	70	10	5,75

4140

1000V İzoleli Elektrikçi Tornavida Seti (6 Parça)
Insulated Electrician Set (6 Pcs) Screwdriver 1000V



KOD CODE	İÇERİK CONTENTS	g	□	EURO

4300

Opak Seri Düz Uçlu Tornavida
Screwdriver, Opak, Flat

TS ISO 2380-1
DIN ISO 2380-1

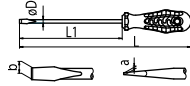

Krom vanadyum, Krom kaplı, Ucu siyah oksit, PP saplı
Chrome vanadium, Chrom plated and black tip, PP handle

KOD CODE	øDxL1 mm	-		L mm	g	□	EURO
		a mm	b mm				
4300 17 0380	3x80	0.5	3	155	25	10	2,33
4300 17 0480	4x80	0.8	4	165	35	10	2,63
4300 17 4100	4x100	0.8	4	185	40	10	3,09
4300 17 5100	5x100	1.0	5.5	195	60	10	3,27
4300 17 5125	5x125	1.0	5.5	220	60	10	4,04
4300 17 6100	6x100	1.2	6.5	195	65	10	3,59
4300 17 6125	6x125	1.2	6.5	220	70	10	4,70
4300 17 6150	6x150	1.2	6.5	245	80	10	5,57
4300 17 7125	7x125	1.2	8	230	95	10	5,00
4300 17 7150	7x150	1.2	8	255	105	10	5,81
4300 17 8175	8x175	1.6	10	280	130	10	7,18
4300 17 9200	9x200	2.0	12	305	165	10	8,47

6

4300

Opak Seri Tornavida Seti (7 Parça)
Screwdriver Set, Opak (7 Pcs)



KOD CODE	İÇERİK CONTENTS	g	□	EURO
4300 00 8107	3x80 - 4x80 - 4x100	520	7	27,30
	5x125 - 6x150			
	Düz uçlu / Flat			
	4.5x80 - 6x100			
	Yıldız uçlu / Phillips			

4320

Opak Seri Yıldız Uçlu Tornavida
Screwdriver, Opak, Phillips

TS 59 - 5 ISO 8764
DIN ISO 8764

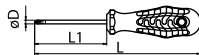

Krom vanadyum, Krom kaplı, Ucu siyah oksit, PP saplı
Chrome vanadium, Chrom plated and black tip, PP handle

KOD CODE	øDxL1 mm	+	L mm	g	□	EURO
4320 18 0360	3x60	Ph0	135	25	10	2,85
4320 18 4580	4.5x80	Ph1	165	40	10	3,95
4320 18 6100	6x100	Ph2	195	70	10	5,22
4320 18 8150	8x150	Ph3	255	140	10	6,47

4325

Opak Seri Pozidriv Yıldız Uçlu Tornavida
Screwdriver, Opak, Pozidriv

DIN ISO 8764

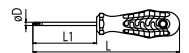

Krom vanadyum, Krom kaplı, Ucu siyah oksit, PP saplı
Chrome vanadium, Chrom plated and black tip, PP handle

KOD CODE	øDxL1 mm	+	L mm	g	□	EURO
4325 18 0360	3x60	Pz0	135	25	10	2,85
4325 18 4580	4.5x80	Pz1	165	40	10	3,95
4325 18 6100	6x100	Pz2	195	70	10	5,22
4325 18 8150	8x150	Pz3	255	140	10	6,47

4350

Ergonomik Seri Düz Uçlu Tornavida
Screwdriver, Ergonomic, Flat

TS ISO 2380 - 1
DIN ISO 2380-1

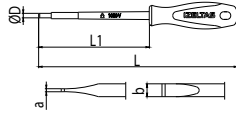

Krom vanadyum, Krom kaplı, Ucu siyah oksit, İki komponent saplı
Chrome vanadium, Chrom plated and black tip,
Two component handle.

KOD CODE	øDxL1 mm	-		L mm	g	□	EURO
		a mm	b mm				
4350 17 0380	3x80	0.5	3	155	25	10	2,33
4350 17 0480	4x80	0.8	4	165	40	10	2,63
4350 17 4100	4x100	0.8	4	185	40	10	3,09
4350 17 5100	5x100	1.0	5.5	195	60	10	3,27
4350 17 5125	5x125	1.0	5.5	220	65	10	4,04
4350 17 6100	6x100	1.2	6.5	195	70	10	3,59
4350 17 6125	6x125	1.2	6.5	220	75	10	4,70
4350 17 6150	6x150	1.2	6.5	245	80	10	5,32
4350 17 7125	7x125	1.2	8	230	100	10	5,00
4350 17 7150	7x150	1.2	8	255	110	10	5,81
4350 17 8175	8x175	1.6	10	280	140	10	7,18
4350 17 9200	9x200	2	12	305	180	10	8,47

4350

Ergonomik Seri Tornavida Seti (7 Parça)
Screwdriver Set, Ergonomic (7 Pcs.)



KOD CODE	İÇERİK CONTENTS	g	□	EURO
4350 00 8107	3x80 - 4x80 - 4x100	370	7	27,30
	5x125 - 6x150			
	Düz uçlu / Flat			
	4.5x80 - 6x100			
	Yıldız uçlu / Phillips			

4370

Ergonomik Seri Yıldız Uçlu Tornavida
Screwdriver, Ergonomic, Phillips

TS 59 - 5
ISO 8764-1
DIN ISO 8764-1



Krom vanadyum, Krom kaplı, Ucu siyah oksit, İki komponent saplı
Chrome vanadium, Chrom plated and black tip,
Two component handle

KOD CODE	øDxL1 mm	+	L mm	g	□	EURO
4370 18 0360	3x60	Ph0	135	25	10	2,85
4370 18 4580	4.5x80	Ph1	165	45	10	3,95
4370 18 6100	6x100	Ph2	195	70	10	5,22
4370 18 8150	8x150	Ph3	255	130	10	6,47



4240

Değişken Uçlu Tornavida
Screwdriver - Reversible

TSEK



Krom vanadyum, Krom kaplı, Selüloz asetat saplı
Chrom vanadium, Chrom plated, Cellulose acetate handle

KOD CODE	σDxL1 mm	⊖ axb mm	⊕	L mm	g	□	EURO
4240 17 0680	6x80	1.2x6	Ph2	175	80	10	5,27

4500

Elektronikçi Tip (Klemens) Düz Uçlu Tornavida
Electronic Screwdriver, Flat

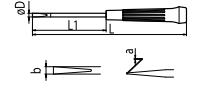

Krom vanadyum, Krom kaplı, Ucu siyah oksit, PP saplı
Chrome vanadium, Chrom plated and black tip, PP handle

KOD CODE	σDxL1 mm	⊖		L mm	g	□	EURO
		a mm	b mm				
4500 17 2560	2.5x60	0.4	2.5	140	15	10	2,17
4500 17 2580	2.5x80	0.4	2.5	160	15	10	2,24
4500 17 0380	3x80	0.5	3	160	15	10	2,33
4500 17 3100	3x100	0.5	3	180	20	10	2,60
4500 17 3125	3x125	0.5	3	205	20	10	2,85
4500 17 3510	3.5x100	0.6	3.5	180	20	10	2,67
4500 17 0480	4x80	0.8	4	160	20	10	2,82
4500 17 4100	4x100	0.8	4	180	20	10	3,13
4500 17 4125	4x125	0.8	4	205	25	10	3,52
4500 17 4150	4x150	0.8	4	230	25	10	3,93

4240

6 Değişken Uçlu Tornavida Takımı
Screwdriver Set - Reversible

TSEK



KOD CODE	σDxL1 mm	⊖		L mm	g	□	EURO
		a mm	b mm				
4240 00 7102	6x80	1.2x6	Ph2	175	105	1	6,56
	4x80	0.8x4.5	Ph1				

4540

Klips Sökme Tornavidası
Hupcap and Clip Remover

YENİ
NEW



Krom vanadyum, Krom kaplı, PP Saplı
Chrom vanadium, Chrom plated, PP insulated

KOD CODE	L mm	L1	g	□	EURO
4540 19 0190	290	180	160	10	6,70

4520

Elektronikçi Tip (Klemens) Yıldız Uçlu Tornavida
Electronic Screwdriver, Phillips



Krom vanadyum, Krom kaplı, Ucu siyah oksit, PP saplı
Chrome vanadium, Chrom plated and black tip, PP handle

KOD CODE	σDxL1 mm	⊕	L mm	g	□	EURO
4520 18 0360	3x60	Ph0	140	15	10	2,58
4520 18 0480	4x80	Ph0	160	20	10	3,27
4520 18 4150	4x150	Ph0	230	25	10	4,50

4500

Elektronikçi Tip (Klemens) Tornavida Seti (6 Parça)
Electronic Screwdriver Set (6 Pcs)



KOD CODE	İÇERİK CONTENTS	g	6	EURO
4500 00 8106	3x80 - 3x100 3x125 - 4x150 Düz uçlu / Flat 3x60 - 4x80 Yıldız uçlu / Phillips	115	6	17,61

4530

Elektronikçi Tip (Klemens) Torx® Uçlu Tornavida
Electronic Screwdriver, Torx®

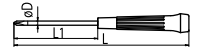

Krom vanadyum, Krom kaplı, Ucu siyah oksit, PP saplı
Chrome vanadium, Chrom plated and black tip, PP handle

KOD CODE	ØDxL1 mm	★	L mm	g	6	EURO
4530 17 0560	2.5x60	T5	145	15	10	2,24
4530 17 0660	2.5x60	T6	145	15	10	2,24
4530 17 0760	3x60	T7	145	15	10	2,31
4530 17 0860	3x60	T8	145	20	10	2,31
4530 17 0960	3x60	T9	145	20	10	2,31
4530 17 1060	3.5x60	T10	145	20	10	2,31

4530

Elektronikçi Tip (Klemens) Torx® Uçlu Tornavida Seti (6 Parça)
Electronic Screwdriver Set Torx (6 Pcs)



KOD CODE	İÇERİK CONTENTS	g	6	EURO
4530 00 1006	T5 - T6 - T7 - T8 - T9 - T10	115	6	13,72

6

4765

T Kol Lokma Uçlu Tornavida (mm)
Nut Spinner With T-Handle (mm)

YENİ
NEW

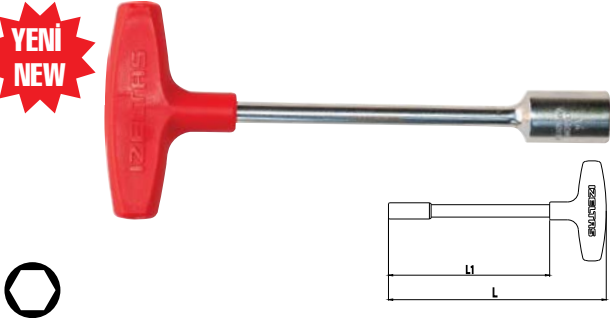

Krom vanadyum, Krom kaplı, PP Saplı
Chrom vanadium, Chrom plated, PP insulated

KOD CODE	mm	L mm	L1 mm	g	□	EURO
4765 19 0040	4	185	135	75	10	3,82
4765 19 0050	5	185	135	75	10	3,82
4765 19 0055	5.5	185	135	75	10	3,82
4765 19 0060	6	185	135	75	10	3,82
4765 19 0070	7	185	135	90	10	4,09
4765 19 0080	8	185	135	95	10	4,09
4765 19 0090	9	185	135	100	10	4,53
4765 19 0100	10	185	135	100	10	4,53
4765 19 0110	11	185	135	110	10	5,01
4765 19 0120	12	185	135	110	10	5,01
4765 19 0130	13	185	135	115	10	5,40
4765 19 0140	14	185	135	115	10	6,29

4770

Lokma Uçlu Tornavida (mm)
Nut Spinner (mm)

DIN 3125



Krom vanadyum, Krom kaplı, PP Saplı
Chrom vanadium, Chrom plated, PP insulated

KOD CODE	mm	L mm	L1 mm	g	□	EURO
4770 19 0040	4	220	125	80	10	8,99
4770 19 0050	5	220	125	80	10	8,99
4770 19 0055	5.5	220	125	80	10	8,99
4770 19 0060	6	220	125	80	10	8,99
4770 19 0070	7	230	125	100	10	9,65
4770 19 0080	8	230	125	110	10	9,65
4770 19 0090	9	230	125	115	10	10,41
4770 19 0100	10	230	125	115	10	10,41
4770 19 0110	11	230	125	130	10	11,40
4770 19 0120	12	230	125	135	10	12,22
4770 19 0130	13	230	125	140	10	13,17
4770 19 0140	14	230	125	140	10	14,25

6



4770

Lokma Uçlu Tornavida Seti (8 Parça, mm)
Nut Spinner Set (8 Pcs, mm)



KOD CODE	İÇERİK CONTENTS	g	□	EURO
4770 00 8108	6 - 7 - 8 - 9 - 10 11 - 12 - 13	2145	8	107,33

4773

1000V Süngüsü İzoleli Lokma Uçlu Tornavida
Nut Spinner, Electrician Blade Insulated 1000V

DIN 3125

YENİ
NEW

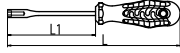

Krom vanadyum, PP saplı
Chrome vanadium, PP handle

KOD CODE	mm	L mm	L1 mm	g	□	EURO
4773 19 0040	4	220	125	90	10	13,49
4773 19 0050	5	220	125	90	10	13,49
4773 19 0055	5.5	220	125	90	10	13,49
4773 19 0060	6	220	125	90	10	13,49
4773 19 0070	7	230	125	110	10	14,48
4773 19 0080	8	230	125	120	10	14,48
4773 19 0090	9	230	125	125	10	15,62
4773 19 0100	10	230	125	125	10	15,62
4773 19 0110	11	230	125	140	10	17,11
4773 19 0120	12	230	125	145	10	18,33
4773 19 0130	13	230	125	150	10	19,76
4773 19 0140	14	230	125	150	10	21,38

4773

1000V Süngüsü İzoleli Lokma Uçlu Tornavida Seti (8 Parça)
Nut Spinner, Electrician Blade Insulated Set (8 Pcs)
1000V

YENİ
NEW



KOD CODE	İÇERİK CONTENTS	g	□	EURO
4773 00 8108	6 - 7 - 8 - 9 - 10 - 11 - 12 - 13	2225	8	117,89

4775

Torx® Uçlu Tornavida
Torx® Screwdriver

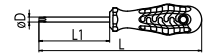
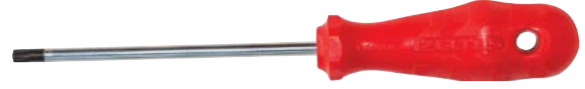

Krom vanadyum, Krom kaplı, Ucu siyah oksit, PP saplı
Chrome vanadium, Chrom plated and blackened, PP handle

KOD CODE	ØDxL1 mm	★	L mm	g	□	EURO
4775 18 0010	4x80	T10	165	35	10	4,84
4775 18 0015	4x80	T15	165	35	10	4,84
4775 18 0020	4x100	T20	185	40	10	5,41
4775 18 0025	4.5x100	T25	185	40	10	6,24
4775 18 0027	5x125	T27	220	60	10	6,89
4775 18 0030	6x125	T30	220	70	10	7,33
4775 18 0040	7x125	T40	230	100	10	9,10
4775 18 0045	8x125	T45	230	120	10	10,29

4775

Torx® Uçlu Tornavida Seti (7 Parça)
Torx® Screwdriver Set (7 Pcs)



KOD CODE	İÇERİK CONTENTS	g	□	EURO
4775 00 8107	T10 - T15 - T20 - T25 - T27 - T30 - T40	380	7	44,65

4776

Delikli Torx® Uçlu Tornavida
Torx® Screwdriver / Tamper Resistance

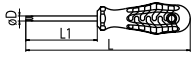

Krom vanadyum, Krom kaplı, Ucu siyah oksit, PP saplı
Chrome vanadium, Chrom plated and blackened, PP handle

6

KOD CODE	ØDxL1 mm		L mm	g		EURO
4776 18 0009	4x60	TR9	145	35	10	6,04
4776 18 0010	4x80	TR10	165	35	10	6,04
4776 18 0015	4x80	TR15	165	40	10	6,04
4776 18 0020	4x100	TR20	185	40	10	6,77
4776 18 0025	4.5x100	TR25	185	45	10	7,79
4776 18 0027	5x125	TR27	220	60	10	8,62
4776 18 0030	6x125	TR30	220	70	10	9,17
4776 18 0040	7x125	TR40	230	100	10	11,38

4776

Delikli Torx® Uçlu Tornavida Seti (7 Parça)
Torx® Screwdriver / Tamper Resistance Set (7 Pcs)

YENİ
NEW



KOD CODE	İÇERİK CONTENTS	g		EURO
4776 00 8107	TR10 - TR15 - TR20 - TR25 - TR27 TR30 - TR40	380	7	55,81

4780

Manyetik Bits Tutucu Tornavida (Uzun)
Screwdriver, Magnetic Bit Holder (Long)



KOD CODE	mm	L mm	L1 mm	g		EURO
4780 19 6120	6.3	230	120	105	10	10,54

4783

1000V Süngüsü İzoleli Manyetik Bits Tutucu Tornavida
Screwdriver, Magnetic Bit Holder Insulated
1000V

1000 V
IEC 60900



YENİ
NEW

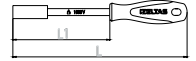

KOD CODE	mm	L mm	L1 mm	g		EURO
4783 19 6120	6.3	230	120	115	10	12,00

4785

Manyetik Bits Tutucu Tornavida (Kısa)
Screwdriver, Magnetic Bit Holder, (Short)



KOD CODE	mm	L mm	L1 mm	g		EURO
4785 19 6330	6.3	130	30	60	10	9,11

4790

Üniversal Bits Adaptörü (Manyetik)
Screwdriver Universal Bit Holder (Magnetic)



KOD CODE	mm	mm	L mm	g		EURO
4790 26 6360	6.3	6.3	60	25	10	7,64

4795

T Tipi Manyetik Bits Tutucu Tornavida
Magnetic Bit Holder With T-Handle



KOD CODE	mm	L mm	L1 mm	g		EURO
4795 19 0010	6.3	185	130	60	10	18,24

4788

Manyetik Bits Tutucu Tornavida, Flexible
Screwdriver, Magnetic Bit Holder, Flexible



KOD CODE	mm	L mm	L1 mm	g		EURO
4788 19 6160	6.3	275	170	130	10	14,50

4815

Değişken Bits Uçlu Tornavida Set (7 parça)
Screwdriver - Interchangeable Bits Set (7 pcs)



KOD CODE	İÇERİK CONTENTS	g		EURO
4815 00 6107	100mm Sap Ph1x4.5 Ph2x5.5 Ph3x7 Pz1x4.5 Pz2x5.5 Pz3x7	140	1	8,82

4800

6'lı Bits Set
Bit Set (6 Pcs)



KOD CODE	İÇERİK CONTENTS	g		EURO
4800 00 8106	0.6x4.5 - 0.8x5.5	50	6	3,44
	Ph1 - Ph2 - Ph3			
	T27			

4800

10'lu Bits Set
Bit Set (10 Pcs)



KOD CODE	İÇERİK CONTENTS	g		EURO
4800 00 8110	0.6x4.5 - 0.8x5.5 1.2x6.5	55	10	5,81
	Ph1 - Ph2 - Ph3			
	T25 - T27 - T30 - T40			

4800

31'li Bits Takım (Plastik Kutulu)
Bit Set In Plastic Case (31 Pcs)

YENİ NEW



KOD CODE	İÇERİK CONTENTS	g		EURO
4800 00 8131	0.6x4.5 - 0.8x5.5	385	3 - 3	29,67
	1.2x6.5		4	
	Ph1		3	
	Ph2 - Ph3		6 - 6	
	T27		2	
	T25 - T30 - T40		1-1-1	
	6.3 x 60 Adaptör		1	

4810-4860

Düz Bits Uçlar

Bits Flat

25mm-50mm-75mm-100mm-150mm



YENİ
NEW



Krom vanadyum
Chrom vanadium

4820-4870

Yıldız Bits Uçlar

Bits Phillips

25mm-50mm-75mm-100mm-150mm



YENİ
NEW



Krom vanadyum
Chrom vanadium

6

KOD CODE	⊖	L mm	g	□	EURO
4810 20 0645	0.6x4.5	25	5	10	0,46
4810 20 0855	0.8x5.5	25	5	10	0,46
4810 20 1265	1.2x6.5	25	5	10	0,46
4810 20 5645	0.6x4.5	50	10	10	1,16
4810 20 5855	0.8x5.5	50	10	10	1,16
4810 20 5265	1.2x6.5	50	10	10	1,16
4860 20 0745	4.5	75	11	10	0,86
4860 20 0755	5.5	75	13	10	0,86
4860 20 0765	6.5	75	15	10	0,86
4860 20 1045	4.5	100	14	10	1,32
4860 20 1055	5.5	100	17	10	1,32
4860 20 1065	6.5	100	18	10	1,32
4860 20 1545	4.5	150	21	10	1,88
4860 20 1555	5.5	150	26	10	1,88
4860 20 1565	6.5	150	28	10	1,88

KOD CODE	⊕	L mm	g	□	EURO
4820 21 0001	Ph1	25	5	10	0,46
4820 21 0002	Ph2	25	5	10	0,46
4820 21 0003	Ph3	25	5	10	0,46
4820 21 0011	Ph1	50	10	10	1,16
4820 21 0012	Ph2	50	10	10	1,16
4820 21 0013	Ph3	50	10	10	1,16
4870 21 0701	Ph1	75	17	10	1,01
4870 21 0702	Ph2	75	18	10	1,33
4870 21 0703	Ph3	75	18	10	1,01
4870 21 1001	Ph1	100	20	10	1,69
4870 21 1002	Ph2	100	24	10	1,69
4870 21 1003	Ph3	100	24	10	1,69
4870 21 1501	Ph1	150	23	10	1,88
4870 21 1502	Ph2	150	33	10	1,88
4870 21 1503	Ph3	150	33	10	1,88

4810

Düz Bits Set (25 mm)

Flat Bit Set (25 mm)



KOD CODE	⊖	g	□	EURO
4810 00 0645	06x4.5	45	10	6,47
4810 00 0855	0.8x5.5	50	10	6,47
4810 00 1265	1.2x6.5	55	10	6,47

4820

Yıldız Bits Set (25 mm)

Phillips Bit Set (25 mm)



KOD CODE	⊕	g	□	EURO
4820 00 0001	Ph1	50	10	6,47
4820 00 0002	Ph2	50	10	6,47
4820 00 0003	Ph3	55	10	6,47

4825-4880

Pozidriv Bits Uçlar

Bits Pozidriv

25mm-50mm-75mm-100mm-150mm



Krom vanadyum
Chrom vanadium

KOD CODE	+	L mm	g	□	EURO
4825 21 0001	Pz1	25	5	10	0,58
4825 21 0002	Pz2	25	5	10	0,58
4825 21 0003	Pz3	25	5	10	0,58
4825 21 0011	Pz1	50	10	10	1,16
4825 21 0012	Pz2	50	10	10	1,16
4825 21 0013	Pz3	50	10	10	1,16
4880 21 0701	Pz1	75	17	10	0,86
4880 21 0702	Pz2	75	18	10	0,86
4880 21 0703	Pz3	75	18	10	0,86
4880 21 1001	Pz1	100	20	10	1,32
4880 21 1002	Pz2	100	24	10	1,32
4880 21 1003	Pz3	100	24	10	1,32
4880 21 1501	Pz1	150	23	10	1,88
4880 21 1502	Pz2	150	33	10	1,88
4880 21 1503	Pz3	150	33	10	1,88

4830-4885

Torx® Bits Uçlar

Bits Torx®

25mm-50mm-75mm-100mm-150mm



Krom vanadyum
Chrom vanadium

KOD CODE	+	L mm	g	□	EURO
4830 21 0025	T25	25	5	10	0,58
4830 21 0027	T27	25	5	10	0,58
4830 21 0030	T30	25	5	10	0,58
4830 21 0040	T40	25	5	10	0,58
4830 21 0125	T25	50	10	10	1,29
4830 21 0127	T27	50	10	10	1,29
4830 21 0130	T30	50	10	10	1,29
4830 21 0140	T40	50	10	10	1,29
4885 21 0725	T25	75	12	10	0,86
4885 21 0727	T27	75	15	10	0,86
4885 21 0730	T30	75	15	10	0,86
4885 21 0740	T40	75	17	10	0,86
4885 21 1025	T25	100	15	10	1,32
4885 21 1027	T27	100	20	10	1,32
4885 21 1030	T30	100	20	10	1,32
4885 21 1040	T40	100	23	10	1,32
4885 21 1525	T25	150	20	10	1,88
4885 21 1527	T27	150	25	10	1,88
4885 21 1530	T30	150	25	10	1,88
4885 21 1540	T40	150	33	10	1,88

6

4825

Pozidriv Bits Set (25 mm)

Pozidriv Bit Set (25 mm)



KOD CODE	+	g	□	EURO
4825 00 0001	Pz1	50	10	7,53
4825 00 0002	Pz2	55	10	7,53
4825 00 0003	Pz3	55	10	7,53

4830

Torx® Bits Set (25 mm)

Torx® Bit Set (25 mm)



KOD CODE	+	g	□	EURO
4830 00 0025	T25	50	10	7,53
4830 00 0027	T27	50	10	7,53
4830 00 0030	T30	55	10	7,53
4830 00 0040	T40	60	10	7,53

4850

75mm Uzun Bits Uç Takımı (13 Parça)
Bit Set, Long Type 75 mm (13 Pcs)

75mm

YENİ
NEW



KOD CODE	İÇERİK CONTENTS	g	□	EURO
4850 00 0713	Düz Uçlar Flat Bits 4.5 - 5.5 - 6.5	204	13	17,39
	Yıldız Uçlar Phillips Bits Ph1 - Ph2 - Ph3			
	Pozidriv Uçlar Pozidriv Bits Pz1 - Pz2 - Pz3			
	Torx® Uçlar Torx® Bits T25 - T27 T30 - T40			

6

4850

150mm Uzun Bits Uç Takımı (13 Parça)
Bit Set, Long Type 150 mm (13 Pcs)

150mm

YENİ
NEW



KOD CODE	İÇERİK CONTENTS	g	□	EURO
4850 00 1513	Düz Uçlar Flat Bits 4.5 - 5.5 - 6.5	356	13	34,27
	Yıldız Uçlar Phillips Bits Ph1 - Ph2 - Ph3			
	Pozidriv Uçlar Pozidriv Bits Pz1 - Pz2 - Pz3			
	Torx® Uçlar Torx® Bits T25 - T27 - T30 - T40			

4850

100mm Uzun Bits Uç Takımı (13 Parça)
Bit Set, Long Type 100 mm (13 Pcs)

100mm

YENİ
NEW



KOD CODE	İÇERİK CONTENTS	g	□	EURO
4850 00 1013	Düz Uçlar Flat Bits 4.5 - 5.5 - 6.5	263	13	23,41
	Yıldız Uçlar Phillips Bits Ph1 - Ph2 - Ph3			
	Pozidriv Uçlar Pozidriv Bits Pz1 - Pz2 - Pz3			
	Torx® Uçlar Torx® Bits T25 - T27 - T30 - T40			



4900

Allen Anahtar Altı Köşe (mm) Hex Key Wrench (mm)

TS ISO 2936
DIN ISO 2936

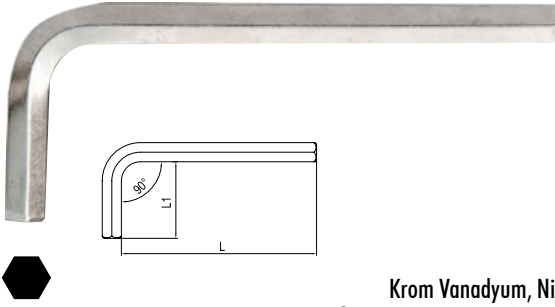

Krom Vanadyum, Nikel Kaplı
Chrom Vanadium, Nickel Plated

KOD CODE	mm	L mm	L1 mm	g	□	EURO
4900 22 0015	1.5	45	14	1.5	10	0,08
4900 22 0020	2	50	16	2	10	0,08
4900 22 0025	2.5	56	18	4	10	0,15
4900 22 0030	3	63	20	6	10	0,17
4900 22 0035	3.5	66	22	8	10	0,34
4900 22 0040	4	70	25	10	10	0,38
4900 22 0050	5	80	28	20	10	0,51
4900 22 0060	6	90	32	30	10	0,61
4900 22 0070	7	95	34	40	10	0,98
4900 22 0080	8	100	36	55	10	1,19
4900 22 0090	9	105	38	75	10	1,76
4900 22 0100	10	112	40	100	10	1,76
4900 22 0120	12	125	45	160	10	2,73
4900 22 0140	14	140	56	250	5	4,26
4900 22 0160	16	152	60	375	5	6,87
4900 22 0170	17	160	63	425	5	7,25
4900 22 0190	19	180	70	610	5	9,38
4900 22 0220	22	200	80	940	5	15,78
4900 22 0240	24	224	90	1250	5	21,29

4900

Allen Anahtar Takım Altı Köşe (mm) Hex Key Wrench Set (mm)

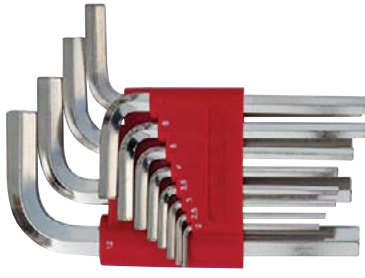

KOD CODE	İÇERİK CONTENTS	g	□	EURO
4900 00 3110	2 - 2.5 - 3 - 4 - 5 - 6 7 - 8 - 9 - 10	400	10	17,44
4900 00 3112	2 - 2.5 - 3 - 3.5 - 4 - 5 6 - 7 - 8 - 9 - 10 - 12	565	12	19,25

4901

Allen Anahtar Altı Köşe (SAE) Hex Key Wrench (SAE)

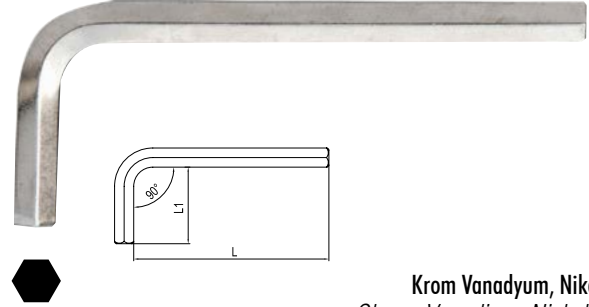

Krom Vanadyum, Nikel Kaplı
Chrom Vanadium, Nickel Plated

KOD CODE	inch	L mm	L1 mm	g	□	EURO
4901 22 1984	5/64"	50	16	2	10	0,08
4901 22 2381	3/32"	54	18	4	10	0,08
4901 22 3125	1/8"	58	20	5	10	0,22
4901 22 3968	5/32"	62	22	10	10	0,34
4901 22 4762	3/16"	68	24	15	10	0,44
4901 22 5556	7/32"	74	26	25	10	0,51
4901 22 6350	1/4"	82	28	35	10	0,81
4901 22 7937	5/16"	94	32	55	10	1,19
4901 22 9825	3/8"	106	38	90	10	1,74
4901 22 1111	7/16"	118	42	130	10	2,24
4901 22 1270	1/2"	132	46	190	10	2,73
4901 22 1428	9/16"	144	52	265	10	5,36
4901 22 1587	5/8"	156	58	365	10	8,03
4901 22 1905	3/4"	176	66	600	5	9,38

4901

Allen Anahtar Takım Altı Köşe (SAE) Hex Key Wrench Set (SAE)

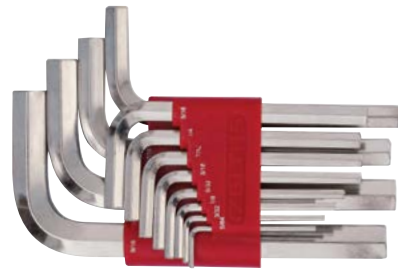

KOD CODE	İÇERİK CONTENTS	g	□	EURO
4901 00 3110	5/64" - 3/32" - 1/8" - 5/32" 3/16" - 7/32" - 1/4" - 5/16" 3/8" - 7/16"	405	10	9,40
4901 00 3112	5/64" - 3/32" - 1/8" - 5/32" 3/16" - 7/32" - 1/4" - 5/16" 3/8" - 7/16" - 1/2" - 9/16"	855	12	17,47

4903

Allen Anahtar Altı Köşe Uzun Boy (mm)
Hex Key Wrench Long Pattern (mm)

TS ISO 2936
DIN ISO 2936

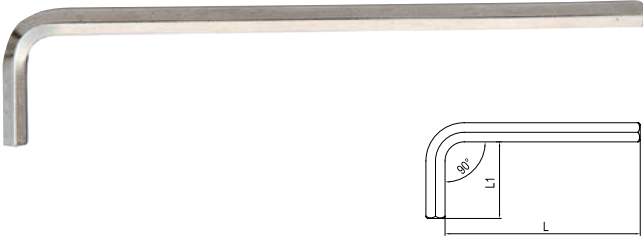

Krom Vanadyum, Nikel Kaplı
Chrom Vanadium, Nickel Plated

KOD CODE	mm	L mm	L1 mm	g	□	EURO
4903 22 0020	2	100	16	3	10	0,16
4903 22 0025	2.5	112	18	5	10	0,57
4903 22 0030	3	126	20	10	10	0,57
4903 22 0035	3.5	136.5	22	15	10	0,57
4903 22 0040	4	140	25	20	10	0,76
4903 22 0050	5	160	28	30	10	0,95
4903 22 0060	6	180	32	50	10	1,33
4903 22 0070	7	190	34	80	10	1,69
4903 22 0080	8	200	36	100	10	2,02
4903 22 0090	9	210	38	145	10	3,03
4903 22 0100	10	224	40	180	10	3,03
4903 22 0120	12	250	45	285	10	5,69
4903 22 0140	14	280	56	460	5	6,30
4903 22 0160	16	300	60	625	5	10,95
4903 22 0170	17	320	63	750	5	11,90
4903 22 0190	19	360	70	1100	5	13,95

6

4905

Yuvarlak Başlı Allen Anahtar (mm)
Hex Key Wrench Ballpoint (mm)



Krom Vanadyum, Nikel Kaplı
Chrom Vanadium, Nickel Plated

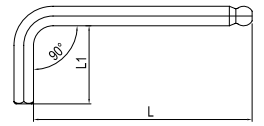

KOD CODE	mm	L mm	L1 mm	g	□	EURO
4905 22 0020	2	50	16	3	10	0,37
4905 22 0025	2.5	56	18	4	10	0,40
4905 22 0030	3	63	20	5	10	0,45
4905 22 0040	4	70	25	10	10	0,74
4905 22 0050	5	80	28	20	10	0,89
4905 22 0060	6	90	32	30	10	1,53
4905 22 0080	8	100	36	55	10	2,68
4905 22 0100	10	112	40	100	10	4,69

4903

Allen Anahtar Takım Altı Köşe Uzun Boy (mm)
Hex Key Wrench Set Long Pattern (mm)



KOD CODE	İÇERİK CONTENTS	g	□	EURO
4903 00 3110	2 - 2.5 - 3 - 4 - 5 - 6 7 - 8 - 9 - 10	660	10	11,70
4903 00 3112	2 - 2.5 - 3 - 3.5 - 4 - 5 6 - 7 - 8 - 9 - 10 - 12	940	12	16,39

4905

Yuvarlak Başlı Allen Anahtar Takımı (8 Parça, mm)
Hex Key Wrench Ballpoint Set (8 Pcs, mm)



KOD CODE	İÇERİK CONTENTS	g	□	EURO
4905 00 7108	2 - 2.5 - 3 - 4 5 - 6 - 8 - 10	275	8	13,45

4906

Yuvarlak Başlı Allen Anahtar Uzun Boy (mm)
Hex Key Wrench Ballpoint Long Pattern (mm)

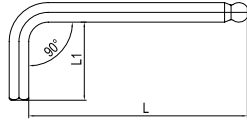

Krom Vanadyum, Nikel Kaplı
Chrom Vanadium, Nickel Plated

KOD CODE	mm	L mm	L1 mm	g	□	EURO
4906 22 0015	1.5	79	12	1.5	10	0,48
4906 22 0020	2	84	16	3	10	0,76
4906 22 0025	2.5	89	16	5	10	0,81
4906 22 0030	3	99	18	7	10	0,90
4906 22 0040	4	109	23	13	10	1,04
4906 22 0050	5	125	26	25	10	1,48
4906 22 0060	6	150	28	42	10	2,16
4906 22 0080	8	167	33	85	10	3,76
4906 22 0100	10	190	37	150	10	6,58

4910

Torx® Allen Anahtar
Torx® Key Wrench

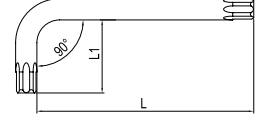
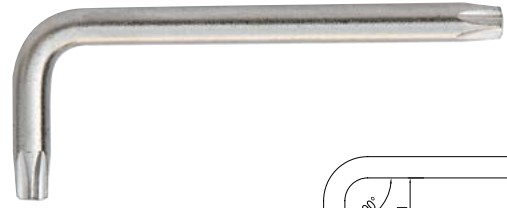

Krom Vanadyum, Nikel Kaplı
Chrom Vanadium, Nickel Plated

KOD CODE	★	L mm	L1 mm	g	□	EURO
4910 22 0006	T6	42	16	2	10	2,29
4910 22 0007	T7	48	16	2	10	2,29
4910 22 0008	T8	48	16	3	10	2,29
4910 22 0009	T9	48	16	3	10	2,33
4910 22 0010	T10	51	17	4	10	2,33
4910 22 0015	T15	54	18	5	10	2,44
4910 22 0020	T20	57	19	5	10	2,55
4910 22 0025	T25	60	20	10	10	2,55
4910 22 0027	T27	64	21	15	10	2,55
4910 22 0030	T30	70	24	20	10	2,69
4910 22 0040	T40	76	26	30	10	2,88
4910 22 0045	T45	83	29	40	10	3,54
4910 22 0050	T50	95	32	60	10	4,04
4910 22 0055	T55	108	35	125	10	5,64
4910 22 0060	T60	120	38	185	10	7,77

6

4906

Yuvarlak Başlı Allen Anahtar Takım Altı Köşe Uzun Boy (9 parça, mm)
Hex Key Wrench Ballpoint Long Pattern Set (9 Pcs, mm)



KOD CODE	İÇERİK CONTENTS	g	□	EURO
4906 00 3109	1.5 - 2 - 2.5 - 3 - 4 - 5 - 6 8 - 10	355	9	18,83

4910

Torx® Allen Anahtar Takımı (8 Parça)
Torx® Key Wrench Set (8 Pcs)



KOD CODE	İÇERİK CONTENTS	g	□	EURO
4910 00 7108	T9 - T10 - T15 T20 - T25 - T27 T30 - T40	155	8	22,01

4912

Kaset Allen Anahtar Takımı (7 Parça, mm)
Hex Key Wrench Folding Set (7 Pcs, mm)



Krom vanadyumu
Chrom vanadium

KOD CODE	İÇERİK CONTENTS	g	1	EURO
4912 00 3107	2.5 - 3 - 4 - 5 - 6 - 8 - 10	355	1	16,44
4912 00 0007	1.5 - 2 - 2.5 - 3 - 4 - 5 - 6	130	1	14,78

4909

T Tipi Torx Allen Anahtar
T Handle Torx Key Wrench



Krom vanadyum, Nikel kaplı, PP saplı
Chrom vanadium, Nickel plated, PP handle

KOD CODE	★	L1 mm	L2 mm	g	1	EURO
4909 22 0009	T9	125	15	22	5	6,80
4909 22 0010	T10	125	15	22	5	6,85
4909 22 0015	T15	125	15	26	5	7,07
4909 22 0020	T20	125	15	44	5	7,13
4909 22 0025	T25	150	20	49	5	7,22
4909 22 0027	T27	150	20	62	5	7,48
4909 22 0030	T30	150	20	82	5	7,55
4909 22 0040	T40	175	25	100	5	7,99

4909

T Tipi Torx Allen Anahtar Takımı (8 Parça)
T Handle Torx Key Wrench Set (8 Pcs)



KOD CODE	İÇERİK CONTENTS	g	1	EURO
4909 00 8108	T9 - T10 - T15 - T20 T25 - T27 - T30 - T40	407	8	58,09



4920

T Tipi Allen Anahtar (mm)
Hex Key Wrench T - Handle (mm)

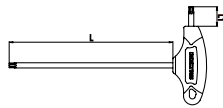

Krom Vanadyum
Chrom Vanadium



KOD CODE	mm	L mm	L1 mm	g		EURO
4920 22 0025	2.5	110	14	20	5	4,53
4920 22 0030	3	125	17	23	5	4,53
4920 22 0040	4	140	20	45	5	4,79
4920 22 0050	5	155	23	58	5	5,23
4920 22 0060	6	170	26	100	5	5,79
4920 22 0070	7	185	30	125	5	6,64
4920 22 0080	8	200	34	150	5	6,92
4920 22 0100	10	220	40	240	5	12,53

4921

Yuvarlak Başlı T Tipi Allen Anahtar (mm)
Hex Key Wrench T - Handle Ballpoint (mm)

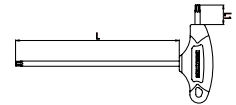

Krom Vanadyum
Chrom Vanadium



KOD CODE	mm	L mm	L1 mm	g		EURO
4921 22 0025	2.5	110	14	20	5	6,39
4921 22 0030	3	125	17	23	5	6,49
4921 22 0040	4	140	20	45	5	7,30
4921 22 0050	5	155	23	58	5	7,80
4921 22 0060	6	170	26	100	5	8,95
4921 22 0070	7	185	30	125	5	9,40
4921 22 0080	8	200	34	150	5	11,11
4921 22 0100	10	220	40	235	5	16,78

6

4920

T Tipi Allen Anahtar Takımı (8 Parça, mm)
Hex Key Wrench T - Handle Set (8 Pcs, mm)



KOD CODE	İÇERİK CONTENTS	g		EURO
4920 00 8108	2.5 - 3 - 4 - 5 6 - 7 - 8 - 10	760	8	51,01

4921

Yuvarlak Başlı T Tipi Allen Anahtar Takımı (8 Parça, mm)
Hex Key Wrench T - Handle Ballpoint Set (8 Pcs, mm)



KOD CODE	İÇERİK CONTENTS	g		EURO
4921 00 8108	2.5 - 3 - 4 5 - 6 - 7 - 8 - 10	755	8	74,21



7

Keskiler ve Çekiçler Chisels and Hammers



Keskiler Chisels
Zimbalar Punches
Çekiçler Hammers
Keserler Adzes

5010

Iskarpela (Düz)
Wood Chisel

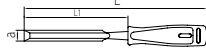

Özel alaşımli çelik, Uç indüksiyonda sertleştirilmiş, PP Saplı
Special steel, Induction hardened tips, PP Handle

KOD CODE	a mm	L mm	L1 mm	g	□	EURO
5010 23 0006	6	273	153	115	5	7,56
5010 23 0008	8	273	153	125	5	8,09
5010 23 0010	10	273	153	135	5	9,17
5010 23 0012	12	273	153	135	5	9,38
5010 23 0014	14	273	153	145	5	9,83
5010 23 0016	16	273	153	150	5	10,42
5010 23 0018	18	273	153	160	5	11,09
5010 23 0020	20	273	153	170	5	12,41
5010 23 0022	22	273	153	190	5	13,43
5010 23 0024	24	273	153	195	5	14,45
5010 23 0026	26	273	153	200	5	15,09
5010 23 0028	28	273	153	200	5	15,41
5010 23 0030	30	275	155	205	5	16,49

7

5010

Iskarpela Takım (6 parça)
Wood Chisel Set (6 Pcs)



KOD CODE	İÇERİK CONTENTS	g	□	EURO
5010 00 8106	10 - 12 - 14 16 - 18 - 20	985	6	62,29

5500

Düz Keski
Flat Cold Chisel

TS 492
DIN 6453



Özel alaşımli çelik, Krom kaplı
Special steel, Chrom plated

KOD CODE	L mm	a mm	g	□	EURO
5500 23 0100	100	17	75	5	3,41
5500 23 0125	125	19	110	5	4,10
5500 23 0150	150	21	180	5	4,30
5500 23 0175	175	24	245	5	4,80
5500 23 0200	200	27	340	5	5,40
5500 23 0250	250	30	525	5	6,40
5500 23 0300	300	30	635	5	7,25

5500

Düz Keski (Kalkan İzoleli)
Flat Cold Chisel (With Safety Handle)

TS 492
DIN 6453

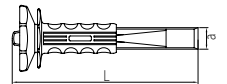

Özel alaşımli çelik, Krom kaplı
Special steel, Chrom plated

KOD CODE	L mm	a mm	g	□	EURO
5500 23 1250	250	30	700	1	9,57
5500 23 1300	300	30	790	1	10,63

5510

Tesviyeci Düz Keski
Flat Cold Chisel Octagonal

TS 492
DIN 6453



Krom vanadyum, Krom kaplı
Chrom vanadium, Chrom plated

KOD CODE	L mm	a mm	g	EURO
5510 23 0125	125	10	75	4,83
5510 23 0150	150	14	125	5,11

5520

Tırnak Keski
Cross Cut Chisel

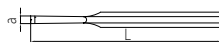

Krom vanadyum, Krom kaplı
Chrom vanadium, Chrom plated

KOD CODE	L mm	a mm	g	EURO
5520 23 0125	130	5	70	5,46
5520 23 0150	150	6	110	5,87

5540

Nokta Zimba
Center Punch

DIN 7250

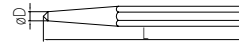

Krom vanadyum, Elektrostatik boyanmış
Chrom vanadium, Electrostatically painted

KOD CODE	L mm	L inch	øD mm	g	EURO	
5540 24 4120	120	4 3/4"	4	65	10	5,06
5540 24 5120	120	4 3/4"	5	95	10	5,76
5540 24 5150	150	6"	5	115	10	6,04
5540 24 0412	120	4 3/4"	4	65	10	6,78

5545

Konik Pim Zimba
Drift Punch

DIN 6458

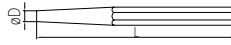

Krom vanadyum, Elektrostatik boyanmış
Chrom vanadium, Electrostatically painted

KOD CODE	L mm	L inch	øD mm	g	EURO	
5545 24 0002	120	4 3/4"	2	90	10	5,49
5545 24 0003	120	4 3/4"	3	90	10	6,22
5545 24 0004	120	4 3/4"	4	90	10	7,00
5545 24 0005	120	4 3/4"	5	95	10	7,18
5545 24 0006	120	4 3/4"	6	95	10	10,59
5545 24 0007	120	6"	7	100	10	11,09
5545 24 0008	150	6"	8	125	10	11,60
5545 24 0009	150	6"	9	130	10	11,89
5545 24 0010	150	6"	10	130	10	12,08
5545 24 0012	150	6"	12	180	10	12,85
★5545 24 0103	120	4 3/4"	3	90	10	6,53

5550

Düz Pim Zimba
Split Pin Punch

DIN 6450

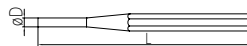

Krom vanadyum, Elektrostatik boyanmış
Chrom vanadium, Electrostatically painted

KOD CODE	L mm	L inch	øD mm	g	EURO	
5550 24 0002	150	6"	2	70	5	5,76
5550 24 0003	150	6"	3	65	5	7,21
5550 24 0004	150	6"	4	65	5	7,32
5550 24 0005	150	6"	5	65	5	7,32
5550 24 0006	150	6"	6	70	5	7,32
5550 24 0007	150	6"	7	100	5	7,74
5550 24 0008	150	6"	8	105	5	7,77
5550 24 0009	150	6"	9	110	5	8,02
5550 24 0010	150	6"	10	120	5	8,23
★5550 24 0105	150	6"	5	65	5	7,63

5550

Düz Pim Zımba Takımı (6 Parça)
Split Pin Punch (6 Pcs)



KOD CODE	İÇERİK CONTENTS	g	6	EURO
5550 00 1006	3 - 4 - 5 - 6 - 7 - 8	865	6	28,92

5600

Keski Zımba Takımı
Chisel And Punch Set



KOD CODE	İÇERİK CONTENTS	g	6	EURO
5600 00 6106	125 tevsiyeci düz keski 125 Flat Cold Chisel Octagonal	865	6	38,29
	150 tevsiyeci düz keski 150 Flat Cold Chisel Octagonal			
	125 tırnak keski 125 Cross Cut Chisel			
	4x120 nokta zımba 4x120 Center Punch			
	5x150 düz pim zımba 5x150 Split PinPunch			
	3x120 konik pim zımba 3x120 Drift Punch			

5700

Kayış Zımba
Belt Punch

DIN 7200

TSEK



Krom vanadyum, Elektrostatik boyanmış
Chrom vanadium, Electrostatically painted

KOD CODE	ØD mm	L mm	g	10	EURO
5700 24 0003	3	105	35	10	3,13
5700 24 0004	4	105	40	10	3,38
5700 24 0005	5	110	50	10	3,64
5700 24 0006	6	110	60	10	3,83
5700 24 0007	7	115	75	10	4,27
5700 24 0008	8	115	90	10	4,56
5700 24 0009	9	120	100	10	4,87
5700 24 0010	10	120	110	10	5,46
5700 24 0011	11	125	130	5	5,87
5700 24 0012	12	125	165	5	6,52
5700 24 0013	13	130	165	5	7,18
5700 24 0014	14	130	180	5	7,90
5700 24 0015	15	135	245	5	8,02
5700 24 0016	16	135	300	5	8,23
5700 24 0017	17	140	365	5	9,78
5700 24 0018	18	140	380	5	10,65
5700 24 0019	19	145	405	5	11,48
5700 24 0020	20	145	450	5	12,44

5700

Kayış Zımba Takımı
Belt Punch Set



KOD CODE	İÇERİK CONTENTS	g	10	EURO
5700 00 2110	3 - 4 - 5 - 6 - 7 8 - 9 - 10 - 11 - 12	845	10	45,54
5700 00 2112	3 - 4 - 5 - 6 - 7 - 8 - 9 10 - 11 - 12 - 13 - 14	1180	12	60,62

5800

Tesviyeci Çekiç Machinist Hammer

TS 5
DIN 1041
TSE



Yedek parça sayfa 153
Spare parts page 153

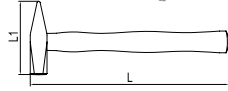

Özel alaşımlı çelik, İndüksiyonda sertleştirilmiş, Elektrostatik boyanmış
Special steel, Induction hardened, Electrostatically painted

KOD CODE	L mm	L1 mm	g	g	g	EURO
5800 25 0100	260	82	100	160	10	5,87
5800 25 0200	280	95	200	260	10	8,02
5800 25 0300	300	105	300	395	10	9,78
5800 25 0500	320	118	500	600	5	12,24
5800 25 1000	360	135	1000	1095	5	17,73
5800 25 1500	380	145	1500	1630	5	21,23
5800 25 2000	400	155	2000	2100	5	29,72

5810

Emniyet Çekici Safety Hammer

TS 5

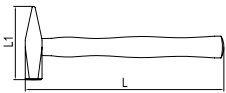

Özel alaşımlı çelik, İndüksiyonda sertleştirilmiş, Elektrostatik boyanmış
Special steel, Induction hardened, Electrostatically painted

KOD CODE	L mm	L1 mm	g	g	g	EURO
5810 25 1000	260	135	1000	1095	5	22,34
5810 25 1500	280	145	1500	1630	5	30,92
5810 25 2000	400	155	2000	2100	5	38,21

Emniyet çekici

Çekiç kafası ile sapın birleşiminde yuvarlak kama ve yapışkan malzeme kullanılarak sağlamlığı artırılmış ayrıca birleşimi çelik sac malzeme ile desteklenerek güvenli kullanım sağlanmıştır.

Safety Hammer

Connection between the hammer head and the handle is ensured by circular wedge and epoxy glue, while it is also reinforced by sheet metal for safe use.

5850

Plastik Çekiç Plastic Hammer

TS 5
TSE

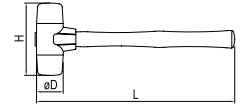

Yedek parça sayfa 152
Spare parts page 152

Darbeye dayanıklı, Kolay değiştirilebilir başlık
Durable and easily changeable heads

KOD CODE	L mm	øD mm	H mm	g	g	EURO
5850 25 0030	300	30	100	345	5	15,75
5850 25 0040	320	40	110	645	5	17,96
5850 25 0050	350	50	120	1015	5	21,65

5870

Lastik Çekiç Rubber Hammer

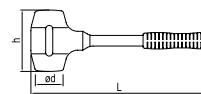

KOD CODE	L mm	ød mm	h mm	g	g	EURO	
5870 25 0400	300	47	104	400	610	5	13,15

5865

Madırğa
Mallet

TS 5

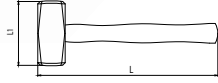

Yedek parça sayfa 153
Spare parts page 153

Özel alaşımli çelik
Special steel

KOD CODE	L mm	L1 mm		g		EURO
5865 25 1000	260	95	1000	1210	1	23,53
5865 25 1500	280	110	1500	1770	1	28,14

6400

Keser
Adze

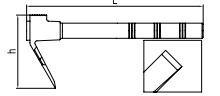

Yedek parça sayfa 152
Spare parts page 152

Özel alaşımli çelik, İndüksiyonda sertleştirilmiş,
Elektrostatik boyanmış, PVC ağız koruyucu
Special steel, Induction hardened, Electrostatically painted,
PVC cutting edge protector

KOD CODE	L mm	h mm	g	g		EURO
6400 25 0600	400	125	400	550	5	21,68

7

6410

Nacak
Hatchet

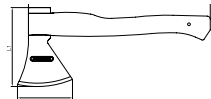

Yedek parça sayfa 153
Spare parts page 153

Özel alaşımli çelik, İndüksiyonda sertleştirilmiş, Elektrostatik boyanmış
Special steel, Induction hardened, Electrostatically painted

KOD CODE	L mm	L1 mm	L2 mm	g	g		EURO
6410 25 0800	380	165	115	800	1065	1	28,60

6401

Usta Keseri
Master Adze

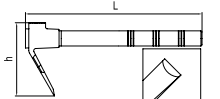

Yedek parça sayfa 152
Spare parts page 152

Özel alaşımli çelik, İndüksiyonda sertleştirilmiş,
Elektrostatik boyanmış, PVC ağız koruyucu
Special steel, Induction hardened, Electrostatically painted,
PVC cutting edge protector

KOD CODE	L mm	h mm	g	g		EURO
6401 25 0600	400	125	400	540	5	21,68

8

Servis Alet ve Ekipmanları Maintenance Tools and Equipment



<i>Servis Aletleri</i>	<i>Service Equipment</i>
<i>Perçin Tabancası</i>	<i>Riveting Pliers</i>
<i>İşkenceler</i>	<i>Clamps</i>
<i>İnşaat Ekipmanları</i>	<i>Construction Equipment</i>
<i>Metreler</i>	<i>Measuring Tapes</i>
<i>Mengene</i>	<i>Forged Steel Vice</i>
<i>Su Terazisi</i>	<i>Straight Level</i>
<i>Gres Pompası</i>	<i>Grease Gun</i>

03750

Kablo Sıyrıcı
Wire Stripper



Yedek parça sayfa 153
Spare parts page 153

KOD CODE	ÖLÇÜ SIZE	g	□	EURO
03750 50 020	Ø8-28	79	5	14,58

03752

Kablo Sıyrıcı
Cable Stripper



8

Yedek parça sayfa 153
Spare parts page 153

KOD CODE	ÖLÇÜ SIZE	g	□	EURO
03752 50 625	Tek 6/300 Çok 1.5/25	70	5	13,25

03751

Koaksiyel Kablo Sıyrıcı
Coaxial Cable Stripper



KOD CODE	ÖLÇÜ SIZE	g	□	EURO
03751 50 012	Dış (1) İç (2)	20	5	19,05

03753

Mekanik Kablo Sıyrıcı
Mechanical Cable Stripper



KOD CODE	ÖLÇÜ SIZE	g	□	EURO
03753 50 054	0.5/4	100	5	24,98

05881

Plastik, Krom Şerit Metre
Plastic, Chrom Steel Case, Measuring tapes



KOD CODE	ÖLÇÜ SIZE M	g	MODEL	□	EURO
05881 50 003	3	145	Plastik/Plastic	5	5,58
05881 50 005	5	200	Plastik/Plastic	5	6,89
05881 50 013	3	160	Krom/Chrom	5	7,30
05881 50 015	5	220	Krom/Chrom	5	8,59

05886

Arazi Tipi Fibreglas Şerit Metre (Saplı)
Fiberglass Measuring Tape Field Type (With Holder)



KOD CODE	ÖLÇÜ SIZE M	g	□	EURO
05886 50 020	20	520	1	17,04
05886 50 030	30	585	1	18,15
05886 50 050	50	820	1	29,22

05880

Su terazisi
Straight Level



Alüminyum gövde
Aluminum body

KOD CODE	L mm	g	□	EURO
05880 50 040	400	250	5	15,35
05880 50 050	500	300	5	16,91
05880 50 060	600	350	5	18,13
05880 50 070	700	400	5	19,57
05880 50 080	800	450	5	20,96
05880 50 100	1000	500	5	23,87
05880 50 120	1200	550	5	28,25
05880 50 150	1500	600	5	32,56
05880 50 200	2000	800	5	45,49

05887

Kumpas
Vernier



Sürgülü, Stoplu
Sliding and with stop

KOD CODE	L mm	g	□	EURO
05887 50 150	150	155	5	41,15

05890

Testere Kolu
Hacksaw Frame

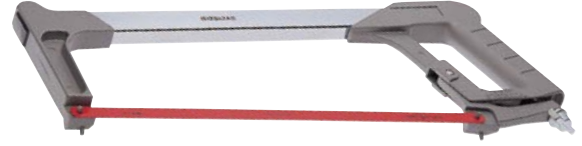

Yedek parça sayfa 153
Spare parts page 153

KOD CODE	L mm	g	□	EURO
05890 50 830	300	540	5	13,69

05895

Kıl Testere Kolu (Ağaç saplı)
Hacksaw Frame (Wooden Handle)



KOD CODE	L mm	g	□	EURO
05895 50 150	150	95	10	3,51

6735

Dal Budama Testeresi
Pruning Saw



Yedek parça sayfa 153
Spare parts page 153

KOD CODE	L mm	g	□	EURO
6735 27 0300	300	400	5	19,68

8

05901

Sentil (20 Parça, mm)
Feeler Gauges (20 Pcs, mm)



KOD CODE	ÖLÇÜ SIZE mm	g		EURO
05901 50 020	0.05 - 1	90	10	9,66

05902

Sentil (20 Parça, SAE)
Feeler Gauges (20 Pcs, SAE)



KOD CODE	ÖLÇÜ SIZE inch	g		EURO
05902 50 020	2 - 35/1000"	65	10	18,30

6195

Perçin Tabancası
Riveting Pliers



KOD CODE	ÖLÇÜ SIZE	CAPACITY mm	g		EURO
6195 26 0260	260	2.5 - 3.2 - 4 - 4.8	625	1	26,36

6220

Spiralli Mıknatıs
Flexible Magnet Holder

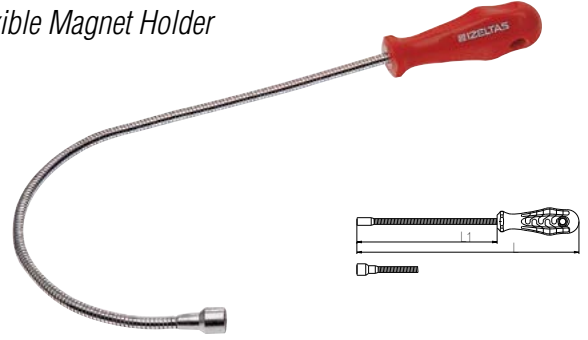

KOD CODE	ÖLÇÜ	L mm	L1 mm	g		EURO
6220 26 0500	500	465	375	100	10	13,24
6220 26 1000	1000	465	375	105	10	14,05

6225

Madeni Yağdanlık (Flexible Uçlu)
Oiler With Flexible Spout



KOD CODE	ÖLÇÜ SIZE cc	g		EURO
6225 26 0200	200	170	5	11,60
6225 26 0300	300	200	5	13,71
6225 26 0500	500	225	5	15,06

6230

Gres Pompası
Grease Gun



 Yedek parça sayfa 153
Spare parts page 153

KOD CODE	ÖLÇÜ SIZE cc	g		EURO
6230 26 0300	300	1200	1	20,13
6230 26 0500	500	1320	1	23,71

6240

Tapı Anahtarı (İki ağız)
Offset Wrench For Carter Case



KOD CODE	ÖLÇÜ mm	g	□	EURO
6240 26 0810	8x10	250	10	13,17

6370

Yağ Filtresi Sökeceği
Band Type Oil Filter Wrench



KOD CODE	Ø mm	g	□	EURO
6370 26 0100	75 - 100	335	5	14,37

6350

Levye Oluklu
Tyre Lever, Straight

TSEK



Krom vanadyum, Krom kaplı
Chrom vanadium, Chrom plated

KOD CODE	L mm	L inch	g	□	EURO
6350 26 0300	300	12"	265	5	4,46
6350 26 0400	400	16"	440	5	6,00
6350 26 0500	500	20"	675	5	7,79
6350 26 0600	600	24"	900	5	9,51

6360

Levye Oluklu Kıvrık Uçlu
Tyre Lever, Bent

TSEK



Krom vanadyum, Krom kaplı
Chrom vanadium, Chrom plated

KOD CODE	L mm	L inch	g	□	EURO
6360 26 0600	600	24"	910	5	10,30

6375

Çift Yönlü Üç Ayak Yağ Filtre Sökeceği
Left and Right Hand Operation, Triple Leg Oil Filter Wrench

**YENİ
NEW**



3/8" - 1/2"

KOD CODE	L mm	g	□	EURO
6375 26 6512	75-120	603	5	24,18

6380

Çift Zincirli Yağ Filtresi Sökeceği
Oil Filter Wrench With Double Chain

**YENİ
NEW**



KOD CODE	L mm	g	□	EURO
6380 26 6016	60-160	380	5	73,04

06373

Kayırlı Yağ Filtresi Sökeceği
Strap Wrench



KOD CODE	Ø mm	g	□	EURO
06373 50 140	60x140	245	5	23,24

06374

Zincirli Yağ Filtresi Sökeceği
Chain Wrench



KOD CODE	Ø mm	g	□	EURO
06374 50 140	60x140	390	5	19,57

06375

Ayarlı Yağ Filtresi Sökeceği
Adjustable Slot Type Oil Filter Wrench



 Yedek parça sayfa 153
Spare parts page 153

KOD CODE	Ø mm	g	□	EURO
06375 50 100	100	215	5	13,06

06390

Segman Çemberi
Piston Ring Compressor

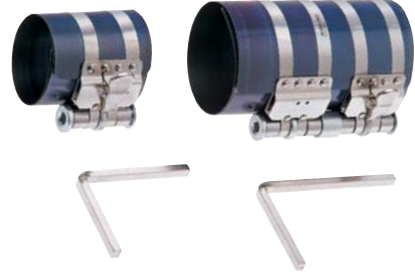

KOD CODE	Ø mm	g	□	EURO
06390 50 125	125	235	5	19,69
06390 50 175	175	505	5	34,86

07415

Sıralı Tel Fırça (Ağaç Saplı)
Hand Brush (Wooden Handle)



KOD CODE	ÖLÇÜ SIZE	g	□	EURO
07415 50 003	3 SIRA 3 RAWS	125	5	1,97
07415 50 004	4 SIRA 4 RAWS	135	5	2,13
07415 50 005	5 SIRA 5 RAWS	145	5	2,36
07415 50 006	6 SIRA 6 RAWS	170	5	2,82

07416

Kıvrık Uçlu Fırça (Plastik Saplı)
Hand Brush (PP Handle)



KOD CODE	ÖLÇÜ SIZE	g	□	EURO
07416 50 001	270	110	5	1,76

07410

Makaralı Uzatma Kablosu Extension Cord Reel



el tipi / with handle

ayaklı / with stand

KOD CODE	MODEL	ÖLÇÜ SIZE	g	□	EURO
07410 50 010	el tipi / with handle	10	1400	1	32,98
07410 50 025	ayaklı / with stand	25	4130	1	64,00
07410 50 050	ayaklı / with stand	50	6745	1	92,46

7400

Dövme Çelik Mengene Forged Steel Vice

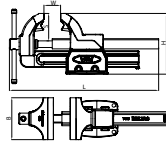

Özel alaşım çelik, Fırın boya
Special steel, Electrostatic Paint

KOD CODE	B mm	W mm	H mm	L mm	g	□	EURO
7400 30 0100	100	125	148	440	5000	1	123,96
7400 30 0125	125	155	183	550	11000	1	169,89
7400 30 0150	150	180	220	675	20000	1	216,87
7400 30 0175	175	205	245	760	29000	1	266,47

8

7401

Mengene Döner Tablası Swivel Base of Vice

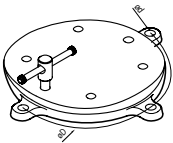

Özel alaşım çelik, Krom kaplı
Special steel, Chrom plated

KOD CODE	ÖLÇÜ SIZE	ød mm	øD mm	g	□	EURO
7401 30 0100	100	10.5	170	1550	1	44,86
7401 30 0125	125	12.5	200	2700	1	61,00
7401 30 0150	150	12.5	240	3800	1	65,27
7401 30 0175	175	12.5	280	6650	1	83,35

7400

Dövme Çelik Mengene (Döner Tabla dahil) Forged Steel Vice with Swivel Base

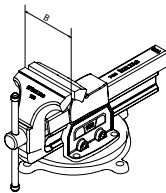
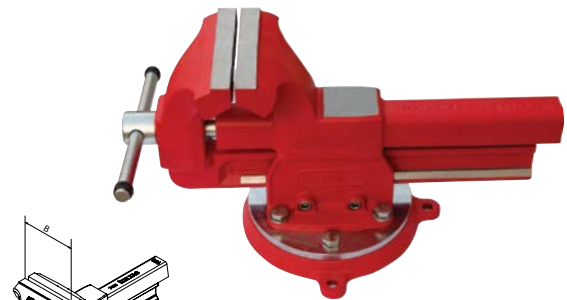

Özel alaşım çelik, Fırın boya
Special steel, Electrostatic Paint

KOD CODE	B mm	g	□	EURO
7400 00 0100	100	6550	1	168,82
7400 00 0125	125	13700	1	230,89
7400 00 0150	150	23800	1	282,14
7400 00 0175	175	35650	1	349,82

7300

İşkence (Marangoz Mengenesi Plastik Ağızlı)
Carpenter Screw Clamp

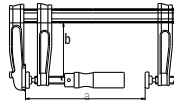
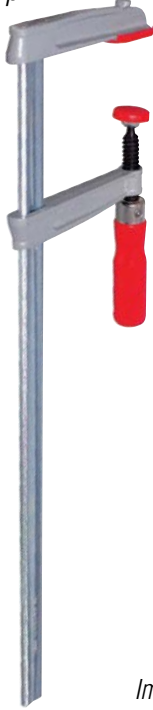

Darbeye dayanıklı çeneler
Impact resistant cast iron jaws

KOD CODE		a mm	b mm	g		EURO
7300 30 3012	30x12	300	120	1605	5	24,48
7300 30 4012	40x12	400	120	1780	5	25,86
7300 30 5012	50x12	500	120	1935	5	27,06
7300 30 6012	60x12	600	120	2080	5	28,68
7300 30 8012	80x12	800	120	2470	5	31,49
7300 30 1012	100x12	1000	120	2790	5	33,76

7310

Mini İşkence
Mini Clamp

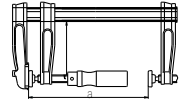

Alaşımlı alüminyum çeneler
Alloyed aluminum jaws

KOD CODE		a mm	b mm	g		EURO
7310 30 1005	10x5	100	50	250	5	7,12
7310 30 1505	15x5	150	50	280	5	7,48
7310 30 2005	20x5	200	50	310	5	7,75
7310 30 2505	25x5	250	50	330	5	8,14
7310 30 3005	30x5	300	50	360	5	8,42

8



9

Makaslar Shears



- | | |
|----------------------------------|-----------------------------|
| <i>Demir Kesme Makası</i> | <i>Bolt Cutters</i> |
| <i>Saç Makasları</i> | <i>Sheet Metal Cutters</i> |
| <i>Plastik Boru Kesme Makası</i> | <i>Plastic Pipe Cutters</i> |
| <i>Bağ Makasları</i> | <i>Prunig Shears</i> |

2350

Demir Kesme Makası
Bolt Cutters



Yedek parça sayfa 152
Spare parts page 152

Özel alaşımli çelik, Kesici ağızlar indüksiyonda sertleştirilmiş,
Elektrostatik boyanmış çeneler ve bağlantı parçaları dövme
Special steel, Cutters induction hardened,
Electrostatically painted jaws and connection parts drop forged

KOD CODE	L mm	L inch	KAPASİTE CAPACITY Ø mm	g	□	EURO
2350 27 0018	450	18"	6 - 8	1510	1	48,40
2350 27 0024	600	24"	8 - 10	2350	1	71,26
2350 27 0030	750	30"	9 - 13	3750	1	111,59
2350 27 0036	900	36"	11 - 16	5500	1	144,39

2350

Demir Kesme Makası Sehпасı
Bolt Cutters Frame



KOD CODE	İÇERİK CONTENTS	g	□	EURO
2350 00 6104	18"(450) - 24"(600) 30"(750) - 36"(900)	21.110	4	433,21

6205

Alüminyum Ve Sac Kesme Makası Sağ
Snip For Aluminum and Metal Sheet (Right)



Özel alaşımli çelik, Kesici ağızlar indüksiyonda sertleştirilmiş,
Special steel, Cutters induction hardened,

KOD CODE	L mm	L inch	g	□	EURO
6205 27 0240	240	10"	380	5	22,40

6206

Alüminyum Ve Sac Kesme Makası Sol
Snip For Aluminum and Metal Sheet (Left)



Özel alaşımli çelik, Kesici ağızlar indüksiyonda sertleştirilmiş
Special steel, Cutters induction hardened

KOD CODE	L mm	L inch	g	□	EURO
6206 27 0240	240	10"	380	5	22,40

6207

Alüminyum Ve Sac Kesme Makası Düz
Snip For Aluminum and Metal Sheet (Flat)



Özel alaşımli çelik, Kesici ağızlar indüksiyonda sertleştirilmiş
Special steel, Cutters induction hardened

KOD CODE	L mm	L inch	g	□	EURO
6207 27 0240	240	10"	380	5	22,40

6210

Kaportacı Makası (Sağ)
Punch Snip (Right)

DIN 6438



Özel alaşımlı çelik, Kesici ağzlar indüksiyonda sertleştirilmiş, PVC izoleli
Special steel, Cutters induction hardened, PVC insulated

KOD CODE	L mm	L inch	g	□	EURO
6210 27 0250	250	10"	555	5	20,64
6210 27 0275	275	11"	600	5	21,34
6210 27 0300	300	12"	640	5	22,66

6211

Kaportacı Makası (Sol)
Punch Snip (Left)

DIN 6438



Özel alaşımlı çelik, Kesici ağzlar indüksiyonda sertleştirilmiş, PVC izoleli
Special steel, Cutters induction hardened, PVC insulated

KOD CODE	L mm	L inch	g	□	EURO
6211 27 0250	250	10"	535	5	20,64
6211 27 0275	275	11"	605	5	21,34
6211 27 0300	300	12"	665	5	22,66

6820

Tenekeci Makası
Tinman's Snip

TSEK



Özel alaşımlı çelik, Kesici ağzlar indüksiyonda sertleştirilmiş, PVC izoleli
Special steel, Cutters induction hardened, PVC insulated

KOD CODE	L mm	L inch	g	□	EURO
6820 27 0200	200	8"	320	5	17,73
6820 27 0250	250	10"	575	5	18,44
6820 27 0300	300	12"	870	5	21,66

6821

Tenekeci Makası (Yaylı)
Tinman's Snip (With Spring)

TSEK



Özel alaşımlı çelik, Kesici ağzlar indüksiyonda sertleştirilmiş, PVC izoleli
Special steel, Cutters induction hardened, PVC insulated

KOD CODE	L mm	L inch	g	□	EURO
6821 27 0250	250	10"	575	5	18,81
6821 27 0300	300	12"	895	5	21,89

6800

Kuyumcu Makası (Düz)
Jeweller's Snip (Straight)



KOD CODE	L mm	L inch	g	□	EURO
6800 27 0180	180	7 1/8"	140	5	19,80

6815

Tel Kesme Makası
Bolt Cutters



KOD CODE	L mm	L inch	g	□	EURO
6815 27 0200	200	8"	295	5	9,25

6801

Kuyumcu Makası (Eğri)
Jeweller's Snip (Curved)



KOD CODE	L mm	L inch	g	□	EURO
6801 27 0180	180	7 1/8"	140	5	21,09

6740

Kombine Makas
Multi Purpose Scissors



KOD CODE	L mm	L inch	g	□	EURO
6740 27 0140	140	5 1/2"	60	5	14,50
6740 27 0190	190	7 1/2"	120	5	16,46

6710

Bağ Makası (Lüks)
Pruning Shears (Lux)



Özel alaşımlı çelik, Kesici ağızlar induksiyonda sertleştirilmiş, PVC izoleli
Special steel, Cutters induction hardened, PVC insulated

KOD CODE	L mm	L inch	g	5	EURO
6710 27 0230	230	9"	390	5	21,34

6720

Bağ Makası (Hafif Tip)
Pruning Shears (Light)



Alüminyum gövde, PVC izoleli
Aluminum forged body, PVC insulated

KOD CODE	L mm	L inch	g	5	EURO
6720 27 0220	220	8 5/8"	265	5	23,57

6715

Bağ Makası (Comfort)
Pruning Shears (Comfort)



Özel alaşımlı çelik, PVC izoleli
Special steel, PVC insulated

KOD CODE	L mm	L inch	g	5	EURO
6715 27 0225	225	9"	340	5	24,82

6712

Elma Makası
Pruning Shears (Fruit)



Özel alaşımlı çelik, Kesici ağızlar induksiyonda sertleştirilmiş, PVC izoleli
Special steel, Cutters induction hardened, PVC insulated

KOD CODE	L mm	L inch	g	5	EURO
6712 27 0210	210	8 1/4"	365	5	26,67

06760

Plastik Boru Kesme Makası Plastic Pipe Cutter



Yedek parça sayfa 153
Spare parts page 153

KOD CODE	Ø mm	g		EURO
06760 50 042	42	400	5	85,49
06760 50 063	63	610	5	15,06

6860

Teleskopik Boru Kesici (Bakır ve Alüminyum İçin) Telescopic Tube Cutter (For Copper and Aluminum)



Yedek parça sayfa 154
Spare parts page 154

KOD CODE	ÖLÇÜ SIZE	g		EURO
6860 28 0635	1/4" - 1 3/8"	470	1	50,53

6850

Mini Boru Kesici (Bakır ve Alüminyum İçin) Mini Tube Cutter (For Copper and Aluminum)



Yedek parça sayfa 154
Spare parts page 154

KOD CODE	ÖLÇÜ SIZE	g		EURO
6850 28 0322	1/8" - 5/8"	120	1	20,15

6865

Profesyonel Boru Kesici (Çelik İçin) Professional Tube Cutter (For Steel)



Yedek parça sayfa 154
Spare parts page 154

KOD CODE	ÖLÇÜ SIZE	g		EURO
6865 28 1050	1/8" - 2"	2380	1	128,15

6855

Standart Boru Kesici (Bakır ve Alüminyum İçin) Standard Tube Cutter (For Copper and Aluminum)



Yedek parça sayfa 154
Spare parts page 154

KOD CODE	ÖLÇÜ SIZE	g		EURO
6855 28 0330	1/8" - 1 1/8"	305	1	25,60



10

Çektirmeler Pullers



Çektirmeler Pullers
İç Rulman Çektirmeler Inside Pullers
Rotil Çektirmeler Balljoint Pullers
Saplama Sökmeler Stud Inserters and Removers

7010

Standart Çektirme (İki Kollu)
Standard Puller (Two Arms)

TSEK

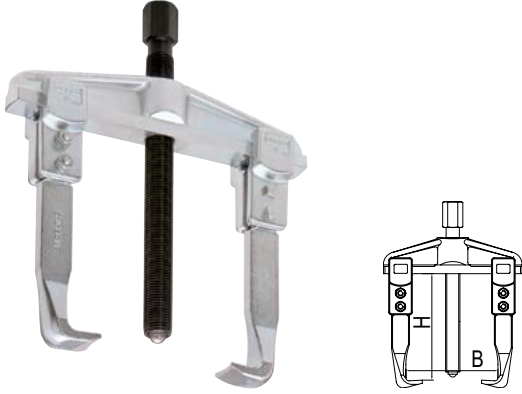

Yedek parça sayfa 154
Spare parts page 154

Krom vanadyum, Çinko kaplı, Kollar sertleştirilmiş,
Mil indüksiyonda sertleştirilmiş
Chrom vanadium, Zinc plated,
Arms hardened, Spindle induction hardened

KOD CODE		B mm	H mm	g		EURO
7010 29 0810	8x10	80	100	1080	1	52,95
7010 29 1210	12x10	120	100	1235	1	56,67
7010 29 1615	16x15	160	150	2850	1	96,57
7010 29 2015	20x15	200	150	3060	1	105,64
7010 29 2520	25x20	250	200	4400	1	225,56
7010 29 3520	35x20	350	200	9900	1	334,69
7010 29 5220	52x20	520	200	13500	1	492,17

7010

Çektirme Sehpa'sı
Display Frame For Pullers



KOD CODE	İÇERİK CONTENTS	g		EURO
7010 00 6105	8x10 - 12x10 - 16x15 20x15 - 25x20	17840	5	546,15

7020

Standart Çektirme (Üç Kollu)
Standart Puller (Three Arms)

TSEK

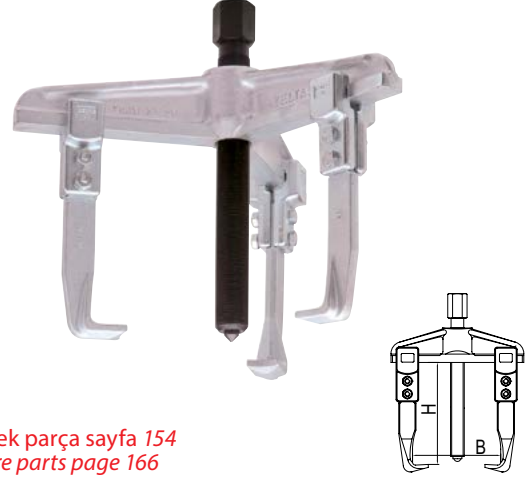

Yedek parça sayfa 154
Spare parts page 166

Krom vanadyum, Çinko kaplı, Kollar sertleştirilmiş,
Mil indüksiyonda sertleştirilmiş
Chrom vanadium, Zinc plated,
Arms hardened, Spindle induction hardened

KOD CODE		B mm	H mm	g		EURO
7020 29 3720	37x20	370	200	13700	1	497,81
7020 29 5220	52x20	520	200	17815	1	686,40



7030

Master Çektirme (İki Kollu) Master Puller (Two Arms)

TSEK

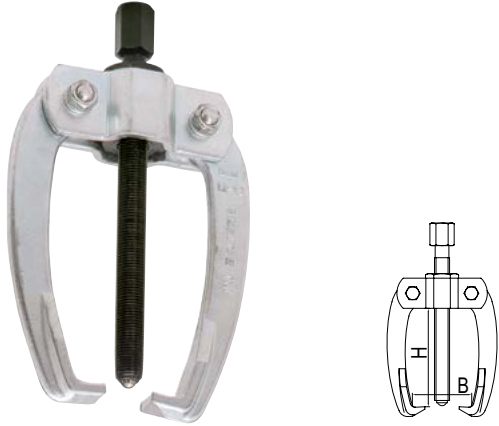

Yedek parça sayfa 154
Spare parts page 154

Krom vanadyum, Çinko kaplı, Kollar sertleştirilmiş,
Mil indüksiyonda sertleştirilmiş
Chrom vanadium, Zinc plated,
Arms hardened, Spindle induction hardened

KOD CODE		B mm	H mm	g	□	EURO
7030 29 0808	8x8	80	80	545	1	21,82
7030 29 1212	12x12	120	120	1075	1	44,99
7030 29 1616	16x16	160	160	1885	1	67,68
7030 29 2320	23x20	230	200	3240	1	92,00

7040

Master Çektirme (Üç Kollu) Master Puller (Three Arms)

TSEK



Yedek parça sayfa 154
Spare parts page 154

Krom vanadyum, Çinko kaplı, Kollar sertleştirilmiş,
Mil indüksiyonda sertleştirilmiş
Chrom vanadium, Zinc plated,
Arms hardened, Spindle induction hardened

KOD CODE		B mm	H mm	g	□	EURO
7040 29 0808	8x8	80	80	680	1	41,80
7040 29 1212	12x12	120	120	1355	1	61,45
7040 29 1616	16x16	160	160	2320	1	89,99
7040 29 2320	23x20	230	200	4025	1	121,17

7050

Batarya Çektirme (İki Kollu) Battery Puller (Two Arms)

TSEK

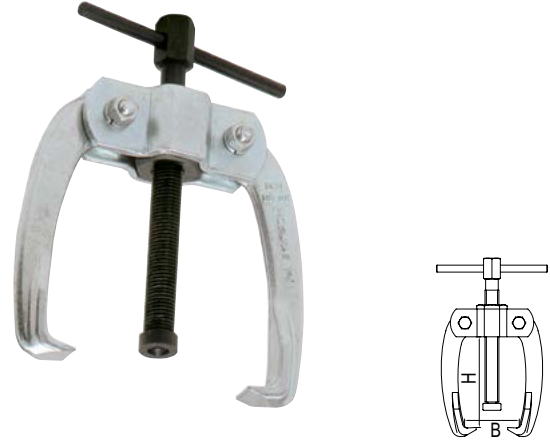

Yedek parça sayfa 154
Spare parts page 154

Krom vanadyum, Çinko kaplı, Kollar sertleştirilmiş,
Mil indüksiyonda sertleştirilmiş
Chrom vanadium, Zinc plated,
Arms hardened, Spindle induction hardened

KOD CODE		B mm	H mm	g	□	EURO
7050 29 0604	6x4	60	40	245	1	23,25
7050 29 0606	6x6	60	60	275	1	24,18
7050 29 0808	8x8	80	80	555	1	25,19

7060

Batarya Çektirme (Üç Kollu) Battery Puller (Three Arms)

TSEK

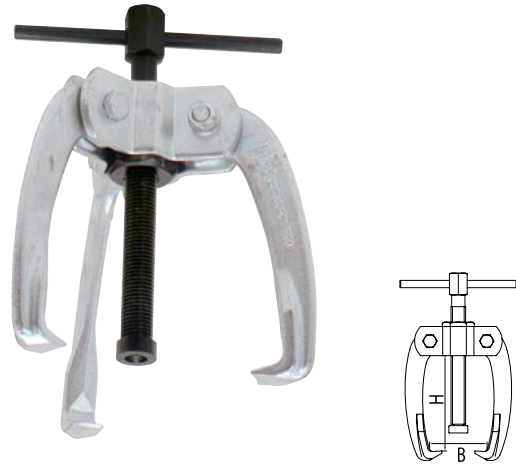

Yedek parça sayfa 154
Spare parts page 154

Krom vanadyum, Çinko kaplı, Kollar sertleştirilmiş,
Mil indüksiyonda sertleştirilmiş
Chrom vanadium, Zinc plated,
Arms hardened, Spindle induction hardened

KOD CODE		B mm	H mm	g	□	EURO
7060 29 0604	6x4	60	40	300	1	30,00
7060 29 0606	6x6	60	60	345	1	31,19
7060 29 0808	8x8	80	80	715	1	32,37

7070

S Tipi Çektirme (İki Kollu)
S Type Puller (Two Arms)

TSEK

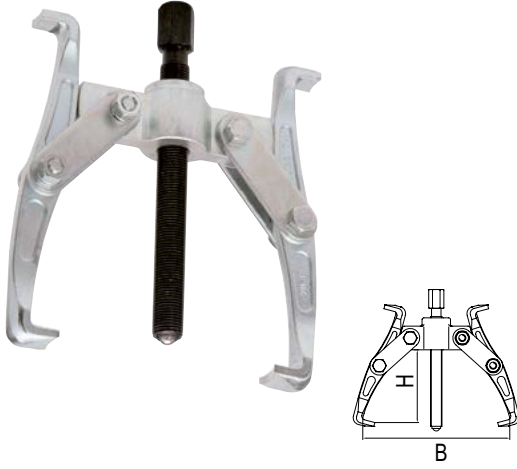

Yedek parça sayfa 154
Spare parts page 154

Krom vanadyum, Çinko kaplı, Kollar sertleştirilmiş,
Mil indüksiyonda sertleştirilmiş
Chrom vanadium, Zinc plated,
Arms hardened, Spindle induction hardened

KOD CODE		B mm	H mm	g		EURO
7070 29 2013	20x13	200	130	2420	1	63,69

7090

Üniversal Çektirme (İki Kollu)
Universal Puller (Two Arms)

TSEK

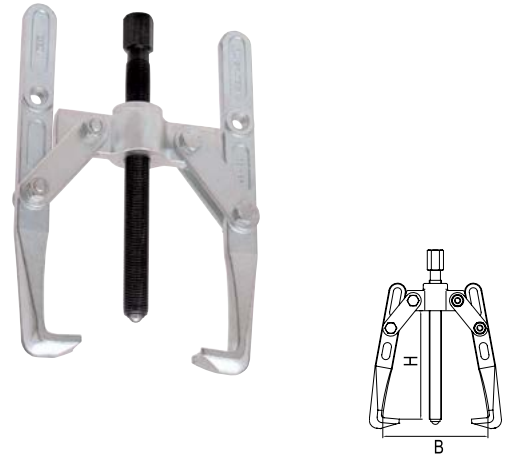

Yedek parça sayfa 154
Spare parts page 154

Krom vanadyum, Çinko kaplı, Kollar sertleştirilmiş,
Mil indüksiyonda sertleştirilmiş
Chrom vanadium, Zinc plated,
Arms hardened, Spindle induction hardened

KOD CODE		B mm	H mm	g		EURO
7090 29 2222	22x22	220	220	3085	1	75,84

7080

S Tipi Çektirme (Üç Kollu)
S Type Puller (Three Arms)

TSEK

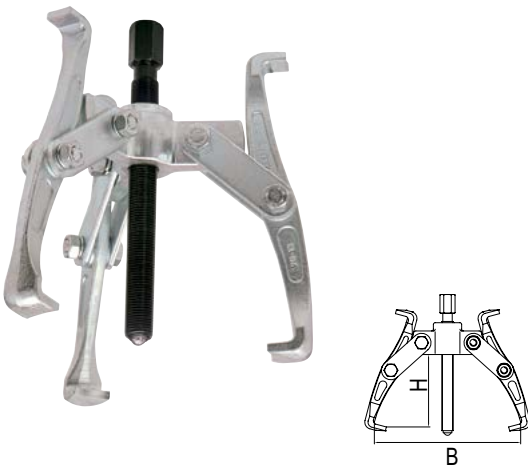

Yedek parça sayfa 154
Spare parts page 154

Krom vanadyum, Çinko kaplı, Kollar sertleştirilmiş,
Mil indüksiyonda sertleştirilmiş
Chrom vanadium, Zinc plated,
Arms hardened, Spindle induction hardened

KOD CODE		B mm	H mm	g		EURO
7080 29 2013	20x13	200	130	3250	1	88,17

7100

Üniversal Çektirme (Üç Kollu)
Universal Puller (Three Arms)

TSEK

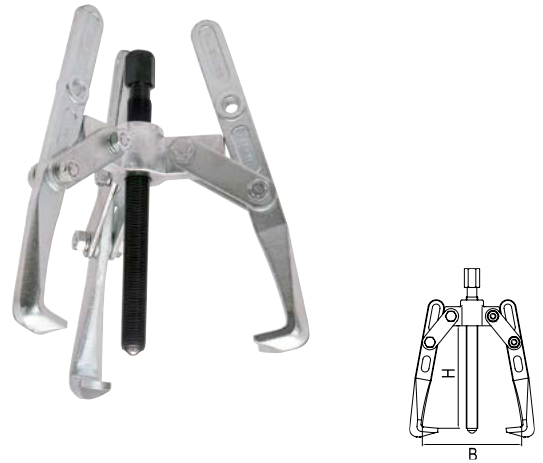

Yedek parça sayfa 154
Spare parts page 154

Krom vanadyum, Çinko kaplı, Kollar sertleştirilmiş,
Mil indüksiyonda sertleştirilmiş
Chrom vanadium, Zinc plated,
Arms hardened, Spindle induction hardened

KOD CODE		B mm	H mm	g		EURO
7100 29 2222	22x22	220	220	4125	1	99,42

10

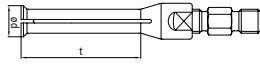
7120
İç Rulman Çektirme Pensleri - Model A
Internal Expansion Puller - Model A

KOD CODE	øD mm	Kullanılan Kol / For	t mm	Adaptör vidası	g	EURO
7120 29 0507	5 - 7	35 - 75	30	M10	40	49,78
7120 29 0709	7 - 9	35 - 75	30	M10	40	49,78
7120 29 0912	9 - 12	35 - 75	30	M10	40	46,10
7120 29 1013	10 - 13	35 - 75	30	M10	40	46,10
7120 29 1317	13 - 17	35 - 75	50	M10	60	46,10
7120 29 1419	14 - 19	35 - 75	60	M10	75	47,34
7120 29 1621	16 - 21	35 - 75	60	M10	75	47,34
7120 29 1823	18 - 23	35 - 75	60	M10	100	56,82
7120 29 2025	20 - 25	35 - 75	60	M10	100	59,66
7120 29 2530	25 - 30	35 - 75	60	M10	110	62,03
7120 29 3037	30 - 37	35 - 75 60 - 130	70	M10	250	71,32
7120 29 3542	35 - 42	35 - 75 60 - 130	70	M10	250	74,89
7120 29 3845	38 - 45	35 - 75 60 - 130	70	M10	250	78,55
7120 29 4350	43 - 50	35 - 75 60 - 130	70	M10	400	86,48

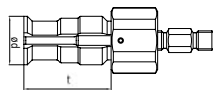
7120
İç Rulman Çektirme Pensleri - Model B
Internal Expansion Puller - Model B

KOD CODE	øD mm	Kullanılan Kol / For	t mm	Adaptör vidası	g	EURO
7120 29 2540	25 - 40	35 - 75 60 - 130	45	M10	235	100,82

7120
İç Rulman Çektirme Kolları
Arms For Internal Expansion Puller

Krom vanadyum, Çinko kaplı, Kollar sertleştirilmiş,
 Mil indüksiyonda sertleştirilmiş
 Chrom vanadium, Zinc plated,
 Arms hardened, Spindle induction hardened

KOD CODE	Kapasite Capacity mm	Kullanılan pensler / For	Adaptör vidası Screw Adapter	g	EURO
----------	----------------------	--------------------------	------------------------------	---	------

7120 29 3575	35 - 75	Model A 5 - 7'den 43 - 50'ye Model B 25 - 40	M10	625	1 50,67
--------------	---------	--	-----	-----	---------

7120 29 6013	60 - 130	Model A 30 - 37'den 43 - 50'ye Model B 25 - 40	M10	1000	1 101,42
--------------	----------	--	-----	------	----------

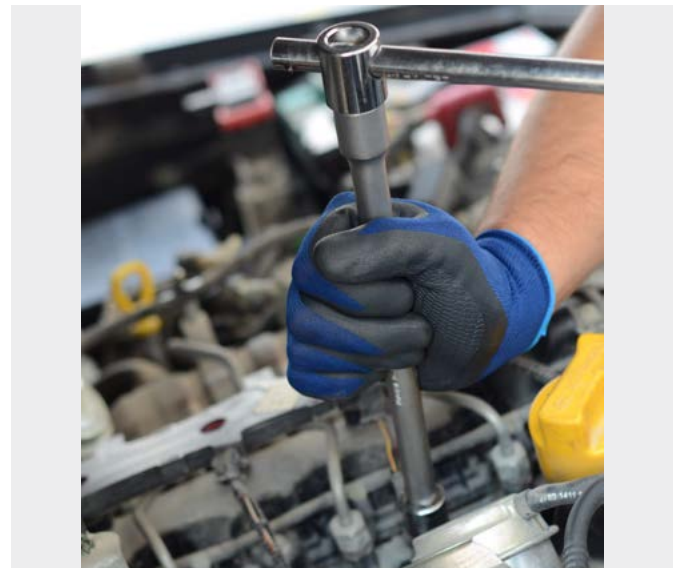
10

7122

Dış Rulman Çektirme Çeneleri
Seperator



Krom vanadyum, Çinko kaplı, Kollar sertleştirilmiş,
Mil indüksiyonda sertleştirilmiş
Chrom vanadium, Zinc plated,
Arms hardened, Spindle induction hardened

KOD CODE	Ø mm	Kullanılan Kollar / For	Adaptör vidası	g	1	EURO
7122 29 0560	5 - 60	40 - 115	M12	370	1	71,48
7122 29 1275	12 - 75	40 - 115	M12	635	1	85,68
7122 29 2211	22 - 115	55 - 205	M16x1.5	1780	1	133,80
7122 29 2515	25 - 155	90 - 260	M20x1.5	3940	1	209,49
7122 29 3022	30 - 220	100 - 360	M20x1.5	11000	1	594,17
7122 29 4028	40 - 280	140 - 435	M24x1.5	15000	1	1066,80

7122

Dış Rulman Çektirme Kolları
Puller Arms For Separator

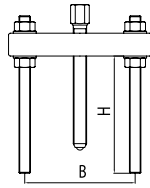

Krom vanadyum, Çinko kaplı, Kollar sertleştirilmiş,
Mil indüksiyonda sertleştirilmiş
Chrom vanadium, Zinc plated,
Arms hardened, Spindle induction hardened

KOD CODE	B mm	Kullanılan Çene / For	H mm	Adaptör vidası	g	1	EURO
7122 29 4011	40-115	5 - 60 12 - 75	150	M12	990	1	101,96
7122 29 5520	55-205	22 - 115	210	M16x1.5	2700	1	161,47
7122 29 9026	90-260	25 - 155	315	M20x1.5	4965	1	224,96
7122 29 1036	100-360	30 - 220	305	M20x1.5	7000	1	449,58
7122 29 1443	140-435	40 - 280	320	M24x1.5	11000	1	674,49

7126

Rotil Çektirme
Extractor For Ball Joint

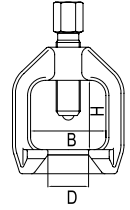

KOD CODE	ØD mm	B mm	H mm	g	1	EURO
7126 29 0018	18	40	40	315	1	42,57
7126 29 0025	25	50	50	540	1	58,35
7126 29 0029	29	60	60	915	1	74,79
7126 29 0040	40	80	80	1965	1	101,81
7126 29 0045	45	90	100	2670	1	119,97

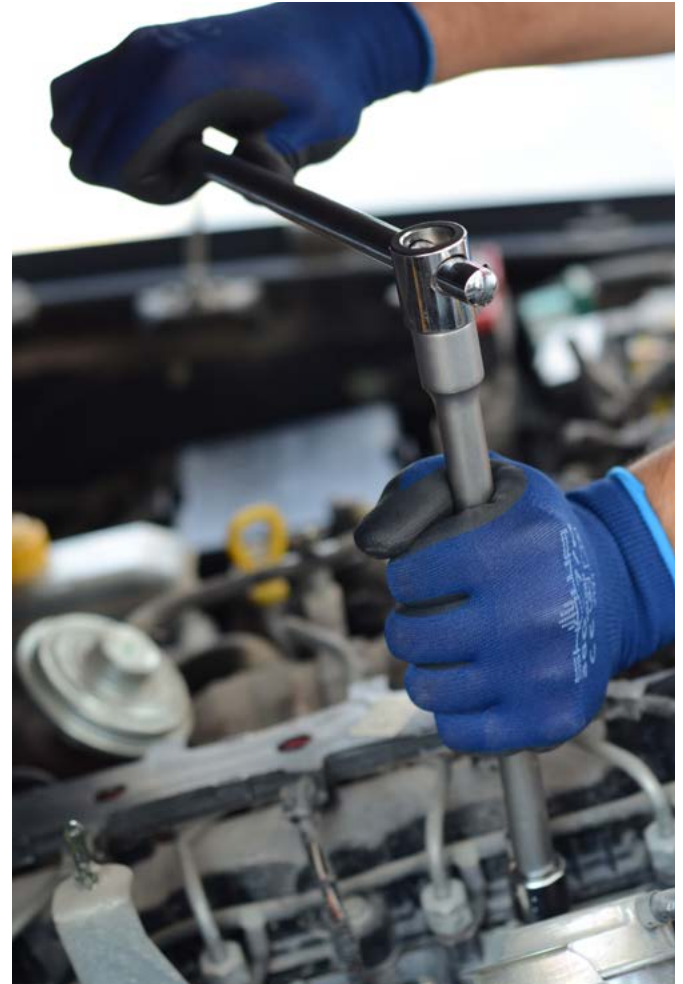

0600

Kurbağacak Anahtar ve Ayarlı Montaj Anahtarları Yedek Parçalar Adjustable Wrench, Spare Parts

	KOD CODE	L mm	L inch	g	□	EURO
Somun Nut	0600 01 0206	160	6"	5	10	1,20
	0600 01 0208	208	8"	10	10	1,81
	0600 01 0210	260	10"	10	10	2,45
	0600 01 0212	308	12"	20	10	3,09
	0600 01 0215	388	15"	65	10	4,46
	Vida Bolt	0600 01 0306	160	6"	3	10
0600 01 0308		208	8"	5	10	0,53
0600 01 0310		260	10"	5	10	0,62
0600 01 0312		308	12"	10	10	0,86
0600 01 0315		388	15"	20	10	1,12
Yay Spring		0600 01 0406	160	6"	1	10
	0600 01 0408	208	8"	1	10	0,21
	0600 01 0410	260	10"	1	10	0,21
	0600 01 0412	308	12"	1	10	0,21
	0600 01 0415	388	15"	3	10	0,21

2100

Stilson Anahtar Yedek Parçaları Stilson Wrench Spare Part

	KOD CODE	ÖLÇÜ FOR	g	□	EURO	
Çene Jaw	2100 10 0108	8"	80	5	7,17	
	2100 10 0110	10"	180	5	10,64	
	2100 10 0112	12"	320	5	11,88	
	2100 10 0114	14"	400	5	14,35	
	2100 10 0118	18"	575	5	19,22	
	2100 10 0124	24"	980	5	27,70	
	Bağlantı Parçası Connection Part	2100 10 0208	8"	60	5	5,50
		2100 10 0210	10"	95	5	8,19
2100 10 0212		12"	100	5	8,98	
2100 10 0214		14"	195	5	10,85	
2100 10 0218		18"	345	5	12,36	
2100 10 0224		24"	445	5	22,26	
Somun Nut		2100 10 0308	8"	10	5	1,94
		2100 10 0310	10"	30	5	2,78
	2100 10 0312	12"	25	5	3,08	
	2100 10 0314	14"	45	5	3,72	
	2100 10 0318	18"	75	5	4,88	
	2100 10 0324	24"	105	5	7,63	

2350

Demir Kesme Makası Yedek Bolt Cutters Spare Part

	KOD CODE	ÖLÇÜ SIZE	KAPASİTE CAPACITY Ø mm	g	□	EURO
Çene Jaw	2350 27 0118	18"	6 - 8	850	1	25,89
	2350 27 0124	24"	8 - 10	870	1	33,72
	2350 27 0130	30"	9 - 13	1250	1	59,72
	2350 27 0136	36"	11 - 16	1850	1	110,29

2110

Ağır Tip Boru Anahtarları Yedek Parçaları Pipe Wrench, Heavy Duty Spare Parts

	KOD CODE	ÖLÇÜ FOR	g	□	EURO	
Çene Jaw	2110 10 0108	8"	100	5	8,87	
	2110 10 0110	10"	205	5	11,55	
	2110 10 0112	12"	235	5	14,30	
	2110 10 0114	14"	400	5	16,72	
	2110 10 0118	18"	675	5	26,10	
	2110 10 0124	24"	900	5	40,62	
	2110 10 0136	36"	1820	5	94,50	
	2110 10 0148	48"	3410	5	131,63	
	Somun Nut	2110 10 0308	8"	10	5	3,10
		2110 10 0310	10"	25	5	3,43
		2110 10 0312	12"	35	5	3,83
		2110 10 0314	14"	40	5	4,37
		2110 10 0318	18"	65	5	6,29
		2110 10 0324	24"	115	5	9,40
2110 10 0336		36"	230	5	17,58	
2110 10 0348		48"	305	5	20,17	
Alt Çene ve Pim Lower Jaw and Pin		2110 10 0408	8"	15	5	8,50
		2110 10 0410	10"	40	5	9,33
	2110 10 0412	12"	60	5	10,50	
	2110 10 0414	14"	60	5	10,50	
	2110 10 0418	18"	90	5	10,86	
	2110 10 0424	24"	125	5	12,40	
	2110 10 0436	36"	225	5	19,92	
	2110 10 0448	48"	285	5	26,73	

2201

Maşalı Boru Anahtarları Yedek Somun Nut

	KOD CODE	ÖLÇÜ FOR	g	□	EURO
Maşalı Boru Anahtarları Yedek Somun Nut	2201 10 0110	1"	25	10	1,42
	2201 10 0115	1 1/2"	40	10	1,81
	2201 10 0120	2"	60	10	2,73
	2201 10 0130	3"	75	10	3,18
	2201 10 0140	4"	75	10	3,78

5850

Plastik Çekiç Yedek Başlık Plastic Hammer Spare Head

	KOD CODE	ØD mm	g	□	EURO
Plastik Çekiç Yedek Başlık Plastic Hammer Spare Head	5850 25 0130	30	35	10	3,44
	5850 25 0140	40	70	10	4,97
	5850 25 0150	50	120	10	7,14

6400

Keser Sapı / Adze Handle

	KOD CODE	L mm	g	□	EURO
Keser Sapı / Adze Handle	6400 25 0001	400	140	10	1,93

5800

Tesfiyecı Çekiç Yedek Sapaı (Kamalı) Hammer Handle (With Pin)



KOD CODE	L mm	g	g	□	EURO
5800 25 0001	260	100	60	10	3,05
5800 25 0002	280	200	60	10	3,09
5800 25 0003	300	300	95	10	3,31
5800 25 0005	320	500	100	10	3,86
5800 25 0010	360	1000	165	10	4,86
5800 25 0015	380	1500	185	10	5,63
5800 25 0020	400	2000	205	10	6,07

5865

Madırğa Sapaı (Kamalı) Mallet Handle (With Pin)



KOD CODE	L mm	g	g	□	EURO
5865 25 0001	260	1000	210	10	3,02
5865 25 0002	280	1500	270	10	3,32

6410

Nacak Sapaı (Kamalı) Hatchet Handle (With Pin)



KOD CODE	L mm	g	g	□	EURO
6410 25 0001	380	800	250	10	6,66

03755

Kablo Sıyırıcı Yedek Bıçağı Cable Strippers Spare Blade



KOD CODE	ÖLÇÜ SIZE	g	□	EURO
03755 50 625	Tek 6/300 Çok 1,5/25	25	5	1,45

06375

Ayarlı Yağ Filtresi Sökeceği Yedek Kelepeç Adjustable Slot Type Oil Filter Wrench Spare Clamp



KOD CODE	Ø mm	g	□	EURO
06375 50 010	100	20	5	1,25

6230

Gres Pompası Yedek Ucu Grease Gun Nozzle



500cc
300cc

KOD CODE	L mm	Ø mm	g	□	EURO
6230 26 2500	38	15	31	10	0,96

Hortumu

Hose for Grease Gun



500cc
300cc

KOD CODE	Ø mm	L mm	g	□	EURO
6230 26 3300	8	300	34	10	1,34
6230 26 3500	12	300	102	10	2,32

05898

HSS Testere Laması Hacksaw Blade HSS



KOD CODE	ÖLÇÜ SIZE	g	□	EURO
05898 50 283	13x0.65x18	20	100	2,07

05899

Bimetal Testere Laması Hacksaw Blade Bimetal



KOD CODE	ÖLÇÜ SIZE	g	□	EURO
05899 50 283	13x0.65x18	20	100	2,24

6735

Dal Budama Testeresi Yedek Bıçak Spare Blade for Pruning Saw



KOD CODE	L mm	g	□	EURO
6735 27 1300	300	60	5	13,72

06765

Plastik Boru Kesme Makası Yedek Bıçağı Plastic Pipe Cutter Spare Blade



KOD CODE	Ø mm	g	□	EURO
06765 50 042	42	73	5	30,00
06765 50 063	63	105	5	30,00

6850

Mini Boru Kesici Bıçağı / Blade For Mini Tube Cutter
Standart Boru Kesici Bıçağı / Blade For Standard Tube Cutter
Teleskopik Boru Kesici Bıçağı / Blade For Telescopic Tube Cutter



KOD CODE	ÖLÇÜ SIZE	g		EURO
6850 28 1322	1/4" - 1 3/8"	5	10	5,07

7010-7020

Standart Çektirme Yedek Parçaları
Spare Parts For Standard Pullers

Uzatma Parçası / Connection Part, Extention



KOD CODE	L mm	KULLANILAN ÇEKTİRME FOR	g		EURO
7010 29 2033	200	8x10 - 12x10	415	1	17,80
7010 29 3033	300	16x15 - 20x15	890	1	31,06
7010 29 4033	400	25x20 - 35x20 37x20 - 52x20	2350	1	46,00

Kol / Arm



KOD CODE	ÖLÇÜ SIZE	g		EURO
7010 29 0822	8x10 - 12x10	110	1	13,36
7010 29 1622	16x15 - 20x15	330	1	23,32
7010 29 2522	25x20 - 35x20 52x20 - 37x20	775	1	40,96

Bağlantı Parçası / Connection Part



KOD CODE	ÖLÇÜ SIZE	g		EURO
7010 29 0833	8x10 - 12x10	160	1	6,68
7010 29 1633	16x15 - 20x15	325	1	11,67
7010 29 2533	25x20 - 35x20 52x20 - 37x20	930	1	20,45

Mil / Spindle



KOD CODE	ÖLÇÜ SIZE	g		EURO
7010 29 0844	8x10 - 12x10	185	1	12,24
7010 29 1644	16x15 - 20x15	555	1	23,43
7010 29 2544	25x20	1400	1	40,38
7010 29 3544	35x20 - 37x20	2185	1	52,67
7010 29 5244	52x20	3210	1	52,67

7070-7080

S Tipi Çektirme Yedek Parçaları
Spare Parts For S Type Puller

Kol / Arm



KOD CODE	KULLANILAN ÇEKTİRME FOR	g		EURO
7070 29 2022	20x13	405	1	14,68

Mil / Spindle



KOD CODE	ÖLÇÜ SIZE	g		EURO
7070 29 2044	20x13	520	1	20,45

6865

Profesyonel Boru Kesici Bıçağı
Blade For Professional Tube Cutter



KOD CODE	ÖLÇÜ SIZE	g		EURO
6865 28 0150	1/8" - 2"	30	5	13,19

7030-7040

Master Çektirme Yedek Parçaları / Spare Parts For Master Puller

Kol / Arm



KOD CODE	KULLANILAN ÇEKTİRME FOR	g		EURO
7030 29 0822	8x8	110	1	7,29
7030 29 1222	12x12	215	1	10,23
7030 29 1622	16x16	345	1	18,18
7030 29 2322	23x20	580	1	24,75

Mil / Spindle



KOD CODE	KULLANILAN ÇEKTİRME FOR	g		EURO
7030 29 0844	8x8	180	1	7,29
7030 29 1244	12x12	360	1	14,65
7030 29 1644	16x16	680	1	16,17
7030 29 2344	23x20	1230	1	22,20

7050-7060

Batarya Çektirme Yedek Parçaları
Spare Parts For Battery Pullers

Kol / Arm



KOD CODE	KULLANILAN ÇEKTİRME FOR	g		EURO
7050 29 0422	6x4	40	1	5,91
7050 29 0622	6x6	50	1	6,30
7050 29 0822	8x8	110	1	7,29

Mil / Spindle



KOD CODE	KULLANILAN ÇEKTİRME FOR	g		EURO
7050 29 0444	6x4	95	1	6,64
7050 29 0644	6x6	105	1	7,42
7050 29 0844	8x8	200	1	8,33

7090-7100

Üniversal Çektirme Yedek Parçaları
Spare Parts For Universal Puller

Kol / Arm



KOD CODE	KULLANILAN ÇEKTİRME FOR	g		EURO
7090 29 2322	22x22	690	1	16,32

Mil / Spindle



KOD CODE	ÖLÇÜ SIZE	g		EURO
7090 29 2244	22x22	565	1	21,54

12

Ticari Teşhir Ürünleri Commercial Display Products



Ticari Teşhir Ürünleri
Commercial Display Products

1113

1/2" Lokma Anahtar Sehpa
Display Frame for Sockets



1/2"

KOD CODE	ÖLÇÜ SIZE mm	g	1	EURO
1113 31 6100	175x360x605	5800	1	55,36

7010

Çektirme Sehpa
Display Frame For Pullers



KOD CODE	İÇERİK CONTENTS	g	1	EURO
7010 31 6105	Boş - Empty	2000	1	7,50

2350

Demir Kesme Makası Sehpa
Display Frame for Bolt Cutters

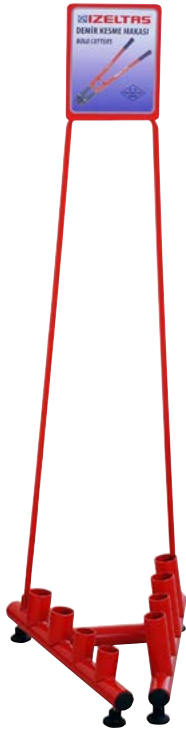

7300

İşkence Sehpa
Display Frame for Screw Clamps



12

KOD CODE	İÇERİK CONTENTS	g	1	EURO
2350 31 6104	Boş - Empty	7400	1	34,80

KOD CODE	ÖLÇÜ SIZE mm	g	1	EURO
7300 31 6150	100x520x1420	8000	1	57,98

8001 - 8002

Çatal ve Yıldız Anahtar Sehpası Display Frame For Wrenches



Sacdan imal edilmiş, Fırın boya
Made from metal sheet, Electrostatic paint

KOD CODE	ÖLÇÜ SIZE mm	g	İÇERİK CONTENTS		EURO
8001 31 6012	160x500	800	Çatal / Open Jaw	1	9,26
8002 31 6012	170x560	1000	Yıldız / Ring	1	9,26

8004

Dövme Çelik Mengene Sehpası Forged Steel Vice Frame



KOD CODE	İÇERİK CONTENTS	g		EURO
8004 31 6004	Boş - Empty	8000	1	71,94

8015

Tekerlekli Üçgen Teşhir Standı Triangular Display Frame



Sacdan imal edilmiş, Fırın boya
Made from metal sheet, Electrostatic paint

KOD CODE	ÖLÇÜ SIZE mm	g		EURO
8015 31 6001	520x1670	29500	1	147,54



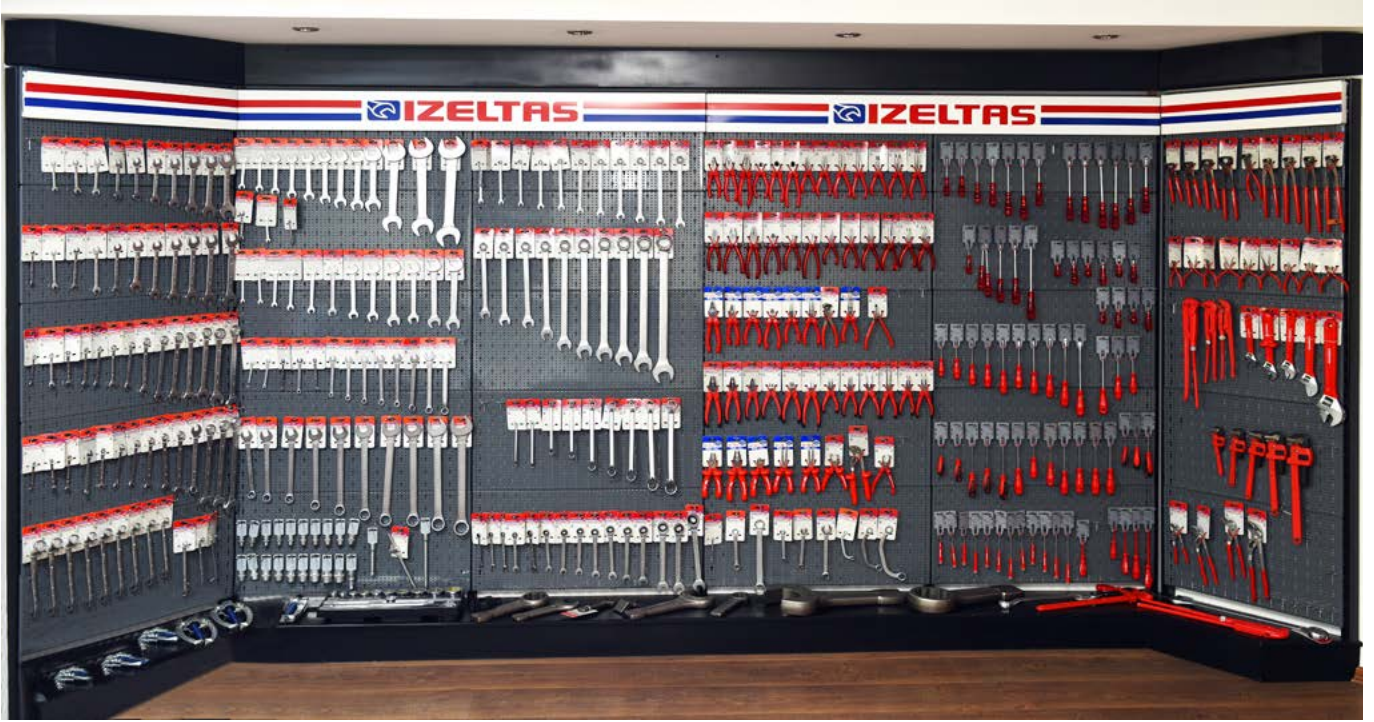

İzeltaş El Aletleri Teşhir Panosu, satış noktaları için özel olarak dizayn edilmiştir. Kolayca monte edilebilen 19 ana parçadan oluşan panonun derinliği 46 cm, genişliği 100 cm, yüksekliği 220 cm'dir. Etkili görünümü ve tüm ürünleri bir arada sergileme özelliği yanında, perakende satışlarda seçme kolaylığı sağlaması bakımından da önem taşımaktadır.

İzeltaş's Product Exhibition Board has been specially designed for selling points. These boards have been formed from easily mountable 19 main parts and have the dimensions as following, width 46 cm, length 100 cm and height 220 cm.

Board features an impressive looking and displays the products all together, which makes it easy to choose desired tools during retail selling activities.

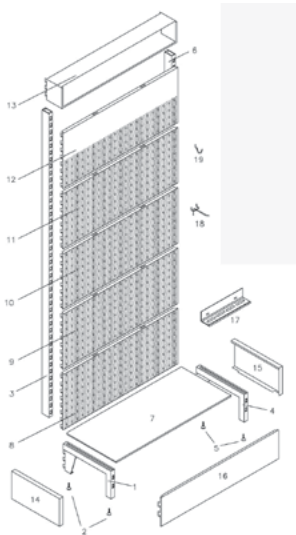

Montaj Sırası / Montage Order

1. Ayak / Stand right leg
2. Plastik ayak / Plastic leg
3. Kolon / Stand right column
4. Ayak / Stand left leg
5. Plastik ayak / Plastic leg
6. Kolon / Stand left column
7. Raf / Shelf
8. Delikli pano / Drilled panel
9. Delikli pano / Drilled panel
10. Delikli pano / Drilled panel
11. Delikli pano / Drilled panel
12. Yarım delikli pano / Half - drilled panel
13. Aydınlatma alınlığı / Illumination panel
14. Yan kapak / Side cover
15. Yan kapak / Side cover
16. Ön kapak / Front cover
17. Tornavida askısı / Screwdriver hanger
18. Büyük askı / Long hanger
19. Küçük askı / Short hanger

Büyük Pano Display Panel (Empty)

KOD CODE	ÖLÇÜ SIZE mm	Cinsi	g	1	EURO
8010 31 6001	460x1000x2200	Boş/Empty	43000	1	335,88

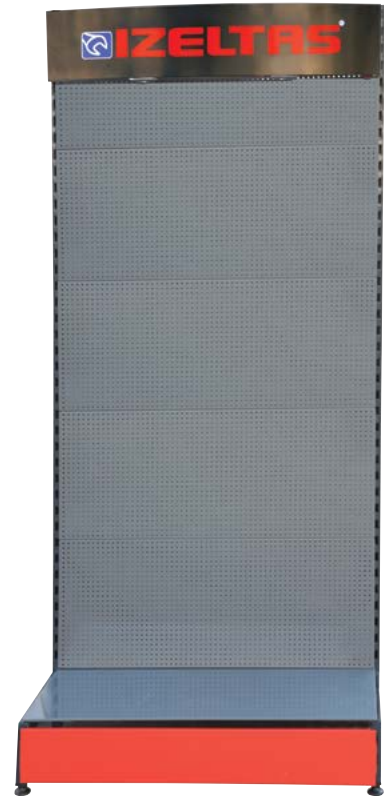

13

Teknik Bilgiler Technical Informations



Teknik Bilgiler Technical Informations

Do not use any extension that the torque exerted through
grasp from the handle.
Do not overload by applying torque exceeds rated
capacity.

Güvenlik Uyarıları/Safety Recommendations



Risk almayın, tedbir alın

İzeltaş El Aletleri, işinizi daha da kolaylaştırmak için her zaman yanınızda olan, özel olarak tasarlanmış en iyi iş arkadaşlarınız. Gelin, onları iş güvenliği kurallarına uyarak, alınacak tedbirleri ihmal etmeyerek kullanalım, sağlığımızı tehlikeye atmayalım.

Don't take risk, just take the necessary measures

İzeltaş Hand Tools are your best work-friends, specially designed for facilitating your job. Let us use them within taking care of the necessary rules, and do not endanger our lives.



Elektrikle bağlantılı işlerde çalışırken mutlaka VDE 1000V aletlerini kullanınız. Diğer plastik saplar izolasyon amaçlı tasarlanmamıştır.

Use VDE 1000 V tools only while you are working with live components. Other plastic handles of the tools are not designed to insulate.



İşin türüne göre gereken, iş güvenliği ekipmanlarını kullanınız.

Use necessary protection materials according to the specification of the job.



Sıkma ve sökme işlemi daima çekerek yapılmalı.

Tightening and extracting applications must be always do as pulling.



Doğru duruşla, doğru hareketi yapın ve uygun olan aleti kullanın.

Make sure that you are well balanced, doing the right motion and use the suitable tools.

GÜVENLİK UYARILARI / Safety Recommendations

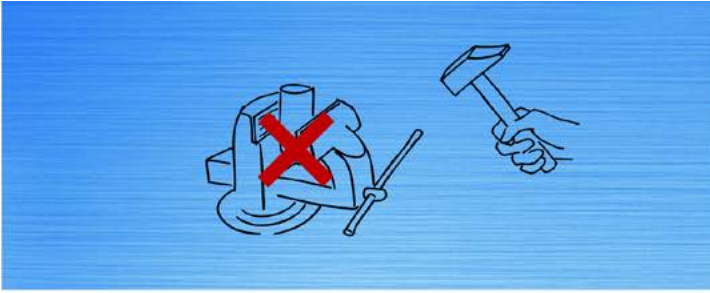

Mengene, işkence türü aletlerin sıkma işleminde çekiç ve uzatma kolu kullanmayınız.

Do not use hammer and extension bar while using kinds of clamping tools.

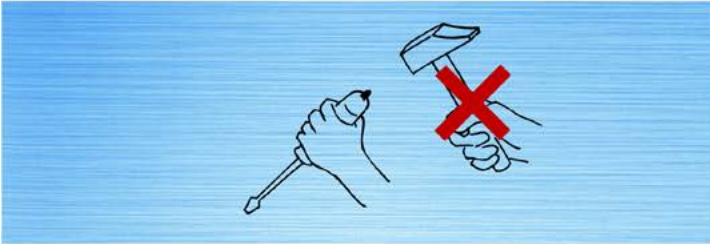

Tornavidanızı keski, punta veya levye yerine kesinlikle kullanmayınız.

Do not use a screwdriver as a chisel or lever.

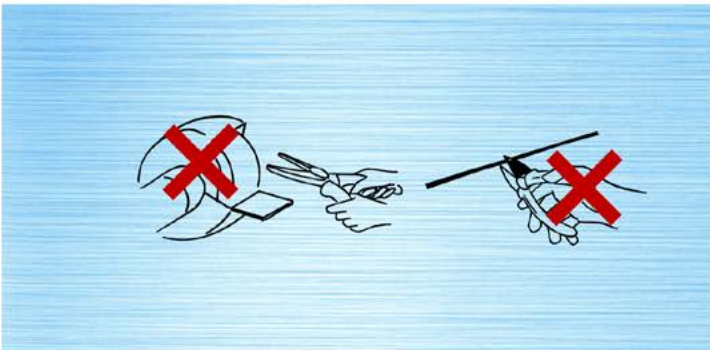

Kesme için uç yerine mafsala yakın yeri kullanınız. Somun ve civata üzerinde kullanmayınız. Çekiç gibi kullanmayınız. Ayarlı (kilitlenebilir) penseleri uzun süre kilitli bırakmayınız, asla basamak gibi kullanmayınız, elemanlar oynayabilir. Asla orijinali bozmayınız.

Use the throat rather than tip of cutting edge. Do not use for bolts and nuts. Do not use like a hammer. Grip pliers should not be used as a permanent clamp, parts can move. Do not modify products.



Eşit sertlikteki veya daha sert yüzeylere çekiçle vurmaktan sakınıınız. Çekiğin çarpma yüzeyinin vurulan alandan geniş olmasına özen gösteriniz (Çekiç kafasının çapı vurulan yüzeyden yaklaşık 10 mm daha geniş olmalıdır). Arızalı, gevşek veya çatlak çekiçleri kesinlikle kullanmayınız.

Never hit on equal or hards surfaces. A hammer should have a diameter approx. 10 mm larger than the surface to hit. Do not use loose, cracked head hammers.

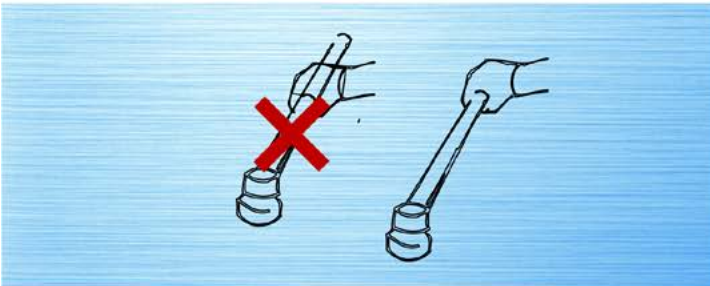

Tork anahtarı ile birlikte asla uzatma kullanmayınız. Doğru ölçümler için daima sap yerinden tutunuz. Kapasitesinin üzerinde yük uygulamayınız. Tork anahtarını sökme amaçlı kullanmayınız.

Do not use any extension with the torque wrenches. Always grasp from the handle. Do not overload by applying torque exceeds rated capacity. Do not use the torque wrench to loosen.

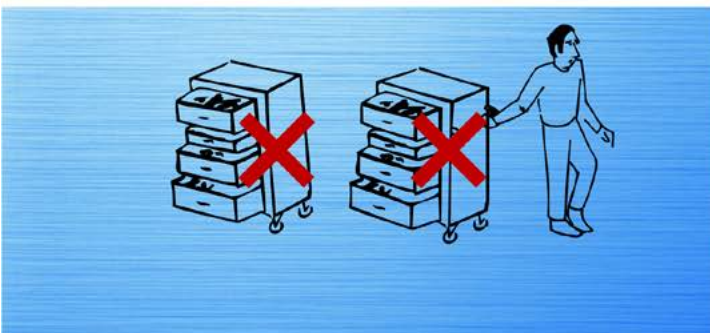

Sabit kullanımda birden fazla çekmece açmayınız. Hareket halinde bütün çekmeceler ve kapılar kapalı olmalı ve üzerinde bir şey bulunmamalıdır.

Do not open more than one drawer during your usage. While moving all drawers, doors must be locked.

Semboller / Symbols

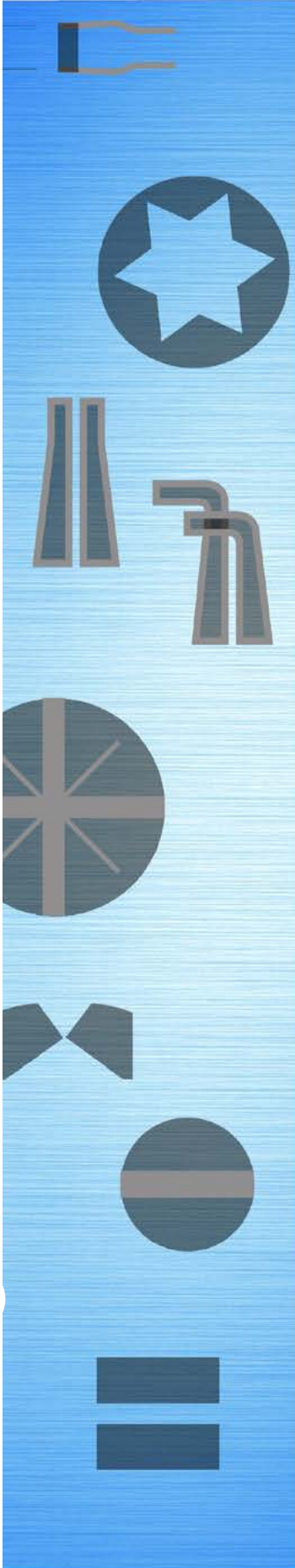

Anahtar Ağız
Size



Ağız Açıklığı
Opening Limit of Jaws



Altı Köşe Lokma Bijon
Anahtar Ağız
Six Point Sockets



Sekiz Köşe Anahtar Ağız
Eight Point Wrench



On iki Köşe Anahtar Ağız
Twelve Point Wrench



Kare Adaptör
Square Adapter



Kovan Anahtar
Tubular Socket Wrench



Bir Ağız Bijon Anahtar
Single Ended Rim Wrench



TORX® Lokma Anahtar
TORX Socket



Düz Uç
Flat Tip



Yıldız Uç
PHILLIPS® Tip



POZIDRIV® Yıldız Uç
POZIDRIV® Tip



TORX® Uç
TORX® Tip



Delikli TORX® Uç
TORX® with hole



Bits Tutucular
Bit Holders



Allen Anahtar
Hexagonal Allen Keys



Segman
Circlip



Gövde Ağırlık
Weight of Body



Tapa Anahtar
Wrench for Carter Case



İşkençe
Screw Clamp



Çektirme
Puller

SIKMA / TEST TORK DEĞERLERİ TIGHTENING / TEST TORQUE VALUES

Önerilen (Bağlayıcı olmayan) cıvata sıkma torkları Nm (Newton Metre)
Suggested (Not Compulsory) Bolt Tightening Torque in Nm (Newton Meter)

Kalite Sınıfı DIN 267'ye Göre Sıkma Değerleri
Tightening Torques Values According to Quality Class DIN 267

	4.6	5.6	6.9	8.8	10.9	12.9
M 2	0,123	0,162	0,314	0,373	0,520	0,628
M 2,2	0,196	0,265	0,510	0,598	0,843	1,010
M 2,5	0,284	0,373	0,726	0,863	1,206	1,451
M 3	0,441	0,588	1,128	1,344	1,883	2,256
M 3,5	0,677	0,902	1,736	2,060	2,893	3,481
M 4	1,000	1,344	2,599	3,040	4,315	5,148
M 5	1,916	2,648	5,099	6,031	8,483	10,200
M 6	3,432	4,511	8,728	10,300	14,710	17,652
M 7	5,590	7,453	14,220	17,162	24,517	28,439
M 8	8,238	10,787	21,575	25,497	35,304	42,168
M 10	16,67	21,575	42,168	50,014	70,608	85,317
M 12	28,44	38,246	73,550	87,279	122,60	147,10
M 14	45,11	60,801	116,70	138,30	194,20	235,40
M 16	69,63	93,163	178,5	210,80	299,10	357,90
M 18	95,12	127,50	245,20	289,3	411,90	490,30
M 20	135,3	180,45	384,10	411,90	578,60	696,30
M 22	182,4	245,16	470,70	559,00	784,50	941,40
M 24	230,5	308,91	598,20	711,00	1000	1196
M 27	343,2	460,90	887,50	1049	1481	1775
M 30	465,8	622,72	1206	1422	2010	2403
M 33	632,5	848,30	1628	1932	2716	3266
M 36	814,0	1089	2099	2481	3491	4197
M 39	1059	1412	2716	3226	4531	5443
M 42	1304	1746	3364	3991	5609	6727
M 45	1638	2177	4207	4992	7012	8414
M 48	1981	2638	5080	6021	8473	10150
M 52	2540	3393	6541	7747	10885	13092
M 56	3168	4227	8149	9650	13582	16279
M 60	3932	5247	10101	11964	16867	20202
M 64	4737	6306	12160	14416	20300	24320

Ölçü Birimleri Measuring Units

Giga	G	1.000.000.000	=10 ⁹	1GW= 1 Milyar Watt
Mega	M	1.000.000	=10 ⁶	1 MW= 1 Milyon Watt
Kilo	k	1.000	=10 ³	1 kW= Bin Watt
Milli	m	0.001	=10 ⁻³	1 mm= Binde Bir Watt
Mikro	m	0.000001	=10 ⁻⁶	1 mm= 1 Milyonda Bir Watt
Nano	n	0.000000001	=10 ⁻⁹	1 nm= 1 Milyarda Bir Watt

Önemli Ölçülerin Değişim Tablosu Conversion Table For Essential Measuring Units

Uzunluk Length	Metre	m		
Kütle Weight	Kilogram	kg		
Zaman Time	Saniye	s		
Kuvvet Force	Newton	N	=kg m/s ²	1 N= 0.102 kp
Döndürme Mom. Torque	Newtonmetre			9.81 Nm= 1kpm
İş Enerjisi Work	Joule	J	=Nm	
Isı Enerjisi Heat	Joule	J		1 J= 0.239 cal
Güç Power	Watt	W	=Nm/s	1 kW= 1.36 PS=860 kcal/h
Basınç Pressure	Pascal	Pa	=N/m ²	100.000 Pa=1 bar=10 mWS
Elektrik Akımı Electricity Current	Amper	A		
Sıcaklık Temperature	Kelvin	K		1K= -272.15 °C

Döndürme Momenti Dönüşüm Tablosu Conversion Table For Bending Moments

Var Olan Ölçüler/ present units	İstenen Ölçüler / Wanted Units					
	=Ncm	=Nm	=kpcm	=kpm	=lbf.in.	=lbf.ft.
Ncm	1	0.01	0.10197	0.00102	0.0885	0.00738
Nm	100	1	10.197	0.10197	8.851	0.7376
kpcm	9.807	0.09807	1	0.01	0.868	0.0723
kpm	980.07	9.807	100	1	86.796	7.233
lbf.in.	11.298	0.11298	1.152	0.01152	1	0.0833
lbf.ft.	135.58	1.3558	13.825	0.13825	12	1

Newton-Metre ve Librefoot Dönüşüm Tablosu Conversion Table Of Newton-Meter And Librefoot (1 Nm=0.738 lbf.ft.)

Nm	ft.,lbs.									
	0	1	2	3	4	5	6	7	8	9
0	0	0.74	1.48	2.21	2.95	3.69	4.43	5.17	5.90	6.64
10	7.38	8.12	8.86	9.59	10.33	11.07	11.81	12.54	13.28	14.02
20	14.76	15.50	16.2	16.97	17.71	18.45	19.19	19.93	20.65	21.40
30	22.14	22.88	23.62	24.35	25.10	25.83	26.57	27.31	28.04	28.78
40	29.52	30.26	31.00	31.73	32.47	33.21	33.95	34.69	35.42	36.16
50	36.90	37.64	38.38	39.11	39.85	40.59	41.33	42.07	42.80	43.54
60	44.28	45.02	45.76	46.49	47.23	47.97	48.71	49.45	50.18	50.92
70	51.66	52.40	53.14	53.87	54.61	55.35	56.09	56.83	57.56	58.30
80	59.04	59.78	60.52	61.25	62.00	62.73	63.47	64.21	64.94	65.68
90	66.42	67.16	67.90	68.63	69.37	70.11	70.85	71.59	72.32	73.06
100	73.80	74.54	75.28	76.01	76.75	77.49	78.23	78.97	79.70	80.44

Librefoot ve Newton-Metre Dönüşüm Tablosu Conversion Table Of Librefoot And Newton-Meter (1 lbf.ft.=1.356 Nm)

ft.- lbs.	Nm									
	0	1	2	3	4	5	6	7	8	9
0	0	1.36	2.71	4.07	5.42	6.78	8.14	9.49	10.85	12.20
10	13.56	14.92	16.27	17.63	18.98	20.34	21.70	23.05	24.41	25.76
20	27.12	28.48	29.83	31.19	32.54	33.90	35.26	36.61	37.97	39.32
30	40.68	42.04	43.39	44.75	46.10	47.46	48.82	50.17	51.53	52.88
40	54.24	55.60	56.95	58.31	59.66	61.02	62.38	63.73	65.09	66.44
50	67.80	69.16	70.51	71.87	73.22	74.58	75.94	77.29	78.65	80.00
60	81.36	82.72	84.07	85.43	86.78	88.14	89.50	90.85	92.21	93.56
70	94.92	96.28	97.63	98.99	100.34	101.70	103.06	104.41	105.77	107.12
80	108.48	109.84	111.19	112.55	113.90	115.26	116.62	117.97	119.33	120.68
90	122.04	123.40	124.75	126.11	127.46	128.82	130.18	131.53	132.89	134.24
100	135.60	136.96	138.31	139.67	141.02	142.38	143.74	145.09	146.45	147.80

Newton-Metre ve Kilopound-Metre Dönüşüm Tablosu Conversion Table Of Newton-Meter and Kilopound-Meter (1 Nm=0.102 kpm)

Nm	kpm									
	0	1	2	3	4	5	6	7	8	9
0	0.00	1.02	2.04	3.06	4.08	5.10	6.12	7.14	8.16	9.18
100	10.20	11.22	12.24	13.26	14.28	15.30	16.31	17.33	18.35	19.37
200	20.39	21.41	22.43	23.45	24.47	25.49	26.51	27.53	28.55	29.57
300	30.59	31.61	32.63	33.65	34.67	35.69	36.71	37.73	38.75	39.77
400	40.79	41.81	42.83	43.85	44.87	45.89	46.91	47.93	48.95	49.97
500	50.99	52.00	53.02	54.04	55.06	56.08	57.10	58.12	59.14	60.16
600	61.18	62.20	63.22	64.24	65.26	66.28	67.30	68.32	69.34	70.36
700	71.38	72.40	73.42	74.44	75.46	76.48	77.50	78.52	79.54	80.56
800	81.58	82.60	83.62	84.64	85.66	86.68	87.70	88.71	89.73	90.75
900	91.77	92.79	93.81	94.83	95.85	96.87	97.89	98.91	99.93	100.95
1000	101.97	102.99	104.01	105.03	106.05	107.07	108.09	109.11	110.13	111.15

Sertlik Dönüşüm Tablosu

Hardness Conversion Table

Vickers Sertlik Hardness	Brinell Sertlik Hardness	Rockwell Sertlik Hardness		Çekme dayanımı Tensile Strength sB N/mm2
		HRB	HRC	
HV 30	HB 30	HRB	HRC	sB N/mm2
80	80.7	36.4	-	270
85	85	42.4	-	290
90	90	47.4	-	310
95	95	52.00	-	320
100	100	56.4	-	340
105	105	60.0	-	360
110	110	63.4	-	380
115	115	66.4	-	390
120	120	69.4	-	410
125	125	72.0	-	420
130	130	74.4	-	440
135	135	76.4	-	460
140	140	78.4	-	470
145	145	80.4	-	490
150	150	82.2	-	500
155	155	83.8	-	520
160	160	85.4	-	540
165	165	86.8	-	550
170	170	88.2	-	570
175	175	89.6	-	590
180	180	90.8	-	600
185	185	91.8	-	620
195	190	91.5	-	640
200	195	94.0	-	660
200	200	95.0	-	670
205	205	95.8	-	680
210	210	96.6	-	710
215	215	97.4	-	720
220	220	98.2	-	730
225	225	99.0	-	750
230	230	-	19.2	760
235	235	-	20.2	780
240	240	-	21.2	800
245	245	-	22.1	820
250	250	-	23.0	830
255	255	-	23.8	850
260	260	-	24.6	870
265	265	-	25.4	880
280	280	-	27.1	900
275	275	-	26.9	920
280	280	-	27.6	940
285	285	-	28.3	950
290	290	-	29.0	970
295	295	-	29.6	990
300	300	-	30.3	1010
310	310	-	31.5	1040
320	320	-	32.7	1080
330	330	-	33.8	1110

Vickers Sertlik Hardness	Brinell Sertlik Hardness	Rockwell Sertlik Hardness		Çekme dayanımı Tensile Strength sB N/mm2
		HRB	HRC	
HV 30	HB 30	HRB	HRC	sB N/mm2
340	340	-	34.9	1140
350	350	-	36.0	1170
360	359	-	37.0	1200
370	368	-	38.0	1260
380	376	-	38.9	1260
390	385	-	39.8	1290
400	392	-	40.7	1320
410	400	-	41.5	1350
420	408	-	42.4	1380
440	423	-	44.0	1430
450	430	-	44.8	1460
460	-	-	45.6	-
470	-	-	46.3	-
480	-	-	47.0	-
490	-	-	47.7	-
500	-	-	48.3	-
510	-	-	49.1	-
520	-	-	49.7	-
530	-	-	50.4	-
540	-	-	51.0	-
550	-	-	51.6	-
560	-	-	52.2	-
570	-	-	52.8	-
580	-	-	53.3	-
590	-	-	53.9	-
600	-	-	54.4	-
610	-	-	55.0	-
620	-	-	55.5	-
630	-	-	56.0	-
640	-	-	56.5	-
650	-	-	57.0	-
660	-	-	57.5	-
670	-	-	58.0	-
680	-	-	58.5	-
690	-	-	59.0	-
700	-	-	59.5	-
720	-	-	60.4	-
740	-	-	61.2	-
760	-	-	62.0	-
780	-	-	62.8	-
800	-	-	63.6	-
820	-	-	64.3	-
840	-	-	65.0	-
860	-	-	65.7	-
880	-	-	66.3	-
900	-	-	66.9	-
920	-	-	67.5	-
940	-	-	68.0	-

TEKNIK BİLGİLER / Technical Information

in.	dec.in.	0"	1"	2"	3"	4"	5"	6"	7"	8"	9"	10"	11"
		millimeters (mm)											
0	0	0	25.400 0	50.800 0	76.200 0	101.600 0	127.000 0	152.400 0	177.800 0	203.200 0	228.600 0	254.000 0	279.400 0
1/64	0.015 625	0.396 9	25.796 9	51.196 9	76.596 9	101.996 9	127.396 9	152.796 9	178.196 9	203.596 9	228.996 9	254.396 9	279.796 9
1/32	0.031 25	0.793 8	26.193 8	51.593 8	76.993 8	102.393 8	127.793 8	153.193 8	178.593 8	203.993 8	229.393 8	254.793 8	280.193 8
3/64	0.046 875	1.190 6	26.590 6	51.990 6	77.390 6	102.790 6	128.190 6	153.590 6	178.990 6	204.390 6	229.790 6	255.190 6	280.590 6
1/16	0.062 5	1.587 5	26.987 5	52.387 5	77.787 5	103.187 5	128.587 5	153.987 5	179.387 5	204.787 5	230.187 5	255.587 5	280.987 5
5/64	0.078 125	1.984 4	27.384 4	52.784 4	78.184 4	103.584 4	128.984 4	154.384 4	179.784 4	205.184 4	230.584 4	255.984 4	281.384 4
3/32	0.093 75	2.381 2	27.781 2	53.181 2	78.581 2	103.981 2	129.381 2	154.781 2	180.181 2	205.581 2	230.981 2	256.381 2	281.781 2
7/64	0.109 375	2.778 1	28.178 1	53.578 1	78.978 1	104.378 1	129.778 1	155.178 1	180.578 1	205.978 1	231.378 1	256.778 1	282.178 1
1/8	0.125	3.175 0	28.575 0	53.975 0	79.375 0	104.775 0	130.175 0	155.575 0	180.975 0	206.375 0	231.775 0	257.175 0	282.575 0
9/64	0.140 625	3.571 9	28.971 9	54.371 9	79.771 9	105.171 9	130.571 9	155.971 9	181.371 9	206.771 9	232.171 9	257.571 9	282.971 9
5/32	0.156 25	3.968 8	29.368 8	54.768 8	80.168 8	105.568 8	130.968 8	156.368 8	181.768 8	207.168 8	232.568 8	257.968 8	283.368 8
11/64	0.171 875	4.365 6	29.765 6	55.165 6	80.565 6	105.965 6	131.365 6	156.765 6	182.165 6	207.565 6	232.965 6	258.365 6	283.765 6
3/16	0.187 5	4.762 5	30.162 5	55.562 5	80.962 5	106.362 5	131.762 5	157.162 5	182.562 5	207.962 5	233.362 5	258.762 5	284.162 5
13/64	0.203 125	5.159 4	30.559 4	55.959 4	81.359 4	106.759 4	132.159 4	157.559 4	182.959 4	208.359 4	233.759 4	259.159 4	284.559 4
7/32	0.218 75	5.556 2	30.956 2	56.356 2	81.756 2	107.156 2	132.556 2	157.956 2	183.356 2	208.756 2	234.156 2	259.556 2	284.956 2
15/64	0.234 375	5.953 1	31.353 1	56.753 1	82.153 1	107.553 1	132.953 1	158.353 1	183.753 1	209.153 1	234.553 1	259.953 1	285.353 1
1/4	0.25	6.350 0	31.750 0	57.150 0	82.550 0	107.950 0	133.350 0	158.750 0	184.150 0	209.550 0	234.950 0	260.350 0	285.750 0
17/64	0.265 625	6.746 9	32.146 9	57.546 9	82.946 9	108.346 9	133.746 9	159.146 9	184.546 9	209.946 9	235.346 9	260.746 9	286.146 9
9/32	0.281 25	7.143 8	32.543 8	57.943 8	83.343 8	108.743 8	134.143 8	159.543 8	184.943 8	210.343 8	235.743 8	261.143 8	286.543 8
19/64	0.296 875	7.540 6	32.940 6	58.340 6	83.740 6	109.140 6	134.540 6	159.940 6	185.340 6	210.740 6	236.140 6	261.540 6	286.940 6
5/16	0.312 5	7.937 5	33.337 5	58.737 5	84.137 5	109.537 5	134.937 5	160.337 5	185.737 5	211.137 5	236.537 5	261.937 5	287.337 5
21/64	0.328 125	8.334 4	33.734 4	59.134 4	84.534 4	109.934 4	135.334 4	160.734 4	186.134 4	211.534 4	236.934 4	262.334 4	287.734 4
11/32	0.343 75	8.731 2	34.131 2	59.531 2	84.931 2	110.331 2	135.731 2	161.131 2	186.531 2	211.931 2	237.331 2	262.731 2	288.131 2
23/64	0.359 375	9.128 1	34.528 1	59.928 1	85.328 1	110.728 1	136.128 1	161.528 1	186.928 1	212.328 1	237.728 1	263.128 1	288.528 1
3/8	0.375	9.525 0	34.925 0	60.325 0	85.725 0	111.125 0	136.525 0	161.925 0	187.325 0	212.725 0	238.125 0	263.525 0	288.925 0
25/64	0.390 625	9.921 9	35.321 9	60.721 9	86.121 9	111.521 9	136.921 9	162.321 9	187.721 9	213.121 9	238.521 9	263.921 9	289.321 9
13/32	0.406 25	10.318 8	35.718 8	61.118 8	86.518 8	111.918 8	137.318 8	162.718 8	188.118 8	213.518 8	238.918 8	264.318 8	289.718 8
27/64	0.421 875	10.715 6	36.115 6	61.515 6	86.915 6	112.315 6	137.715 6	163.115 6	188.515 6	213.915 6	239.315 6	264.715 6	290.115 6
7/16	0.437 5	11.112 5	36.512 5	61.912 5	87.312 5	112.712 5	138.112 5	163.512 5	188.912 5	214.312 5	239.712 5	265.112 5	290.512 5
29/64	0.453 125	11.509 4	36.909 4	62.309 4	87.709 4	113.109 4	138.509 4	163.909 4	189.309 4	214.709 4	240.109 4	265.509 4	290.909 4
15/32	0.468 75	11.906 2	37.306 2	62.706 2	88.106 2	113.506 2	138.906 2	164.306 2	189.706 2	215.106 2	240.506 2	265.906 2	291.306 2
31/64	0.484 375	12.303 1	37.703 1	63.103 1	88.503 1	113.903 1	139.303 1	164.703 1	190.103 1	215.503 1	240.903 1	266.303 1	291.703 1
1/2	0.5	12.700 0	38.100 0	63.500 0	88.900 0	114.300 0	139.700 0	165.100 0	190.500 0	215.900 0	241.300 0	266.700 0	292.100 0
33/64	0.515 625	13.096 9	38.496 9	63.896 9	89.296 9	114.696 9	140.096 9	165.496 9	190.896 9	216.296 9	241.696 9	267.096 9	292.496 9
17/32	0.531 25	13.493 8	38.893 8	64.293 8	89.693 8	115.093 8	140.493 8	165.893 8	191.293 8	216.693 8	242.093 8	267.493 8	292.893 8
35/64	0.546 875	13.890 6	39.290 6	64.690 6	90.090 6	115.490 6	140.890 6	166.290 6	191.690 6	217.090 6	242.490 6	267.890 6	293.290 6
9/16	0.562 5	14.287 5	39.687 5	65.087 5	90.487 5	115.887 5	141.287 5	166.687 5	192.087 5	217.487 5	242.887 5	268.287 5	293.687 5
37/64	0.578 125	14.684 4	40.084 4	65.484 4	90.884 4	116.284 4	141.684 4	167.084 4	192.484 4	217.884 4	243.284 4	268.684 4	294.084 4
19/32	0.593 75	15.081 2	40.481 2	65.881 2	91.281 2	116.681 2	142.081 2	167.481 2	192.881 2	218.281 2	243.681 2	269.081 2	294.481 2
39/64	0.609 375	15.478 1	40.878 1	66.278 1	91.678 1	117.078 1	142.478 1	167.878 1	193.278 1	218.678 1	244.078 1	269.478 1	294.878 1
5/8	0.625	15.875 0	41.275 0	66.675 0	92.075 0	117.475 0	142.875 0	168.275 0	193.675 0	219.075 0	244.475 0	269.875 0	295.275 0
41/64	0.640 625	16.271 9	41.671 9	67.071 9	92.471 9	117.871 9	143.271 9	168.671 9	194.071 9	219.471 9	244.871 9	270.271 9	295.671 9
21/32	0.656 25	16.668 8	42.068 8	67.468 8	92.868 8	118.268 8	143.668 8	169.068 8	194.468 8	219.868 8	245.268 8	270.668 8	296.068 8
43/64	0.671 875	17.065 6	42.465 6	67.865 6	93.265 6	118.665 6	144.065 6	169.465 6	194.865 6	220.265 6	245.665 6	271.065 6	296.465 6
11/16	0.687 5	17.462 5	42.862 5	68.262 5	93.662 5	119.062 5	144.462 5	169.862 5	195.262 5	220.662 5	246.062 5	271.462 5	296.862 5
45/64	0.703 125	17.859 4	43.259 4	68.659 4	94.059 4	119.459 4	144.859 4	170.259 4	195.659 4	221.062 5	246.459 4	271.859 4	297.259 4
23/32	0.718 75	18.256 2	43.656 2	69.056 2	94.456 2	119.856 2	145.256 2	170.656 2	196.056 2	221.456 2	246.856 2	272.256 2	297.656 2
47/64	0.734 375	18.653 1	44.053 1	69.453 1	94.853 1	120.253 1	145.653 1	171.053 1	196.453 1	221.853 1	247.253 1	272.653 1	298.053 1
3/4	0.75	19.050 0	44.450 0	69.850 0	95.250 0	120.650 0	146.050 0	171.450 0	196.850 0	222.250 0	247.650 0	273.050 0	298.450 0
49/64	0.765 625	19.446 9	44.846 9	70.246 9	95.646 9	121.046 9	146.446 9	171.846 9	197.246 9	222.646 9	248.046 9	273.446 9	298.846 9
25/32	0.781 25	19.843 8	45.243 8	70.643 8	96.043 8	121.443 8	146.843 8	172.243 8	197.643 8	223.043 8	248.443 8	273.843 8	299.243 8
51/64	0.796 875	20.240 6	45.640 6	71.040 6	96.440 6	121.840 6	147.240 6	172.640 6	198.040 6	223.440 6	248.840 6	274.240 6	299.640 6
13/16	0.812 5	20.637 5	46.037 5	71.437 5	96.837 5	122.237 5	147.637 5	173.037 5	198.437 5	223.837 5	249.237 5	274.637 5	300.037 5
53/64	0.828 125	21.034 4	46.434 4	71.834 4	97.234 4	122.634 4	148.034 4	173.434 4	198.834 4	224.234 4	249.634 4	275.034 4	300.434 4
27/32	0.843 75	21.431 2	46.831 2	72.231 2	97.631 2	123.031 2	148.431 2	173.831 2	199.231 2	224.631 2	250.031 2	275.431 2	300.831 2
55/64	0.859 375	21.828 1	47.228 1	72.628 1	98.028 1	123.428 1	148.828 1	174.228 1	199.628 1	225.028 1	250.428 1	275.828 1	301.228 1
7/8	0.875	22.225 0	47.625 0	73.025 0	98.425 0	123.825 0	149.225 0	174.625 0	200.025 0	225.425 0	250.825 0	276.225 0	301.625 0
57/64	0.890 625	22.621 9	48.021 9	73.421 9	98.821 9	124.221 9	149.621 9	175.021 9	200.421 9	225.821 9	251.221 9	276.621 9	302.021 9
29/32	0.906 25	23.018 8	48.418 8	73.818 8									



“50 yıldır aileden biri”

“member of family”



YASAL UYARI

Bu katalog, önceki baskıların yerine geçer.

Katalog içeriğinde yer alan ürünlerin teknik özellikleri, görünümü, ölçüleri mevcut şartları temsil etmektedir. Firmanın, gerektiğinde ürünlerle ilgili değişiklik yapma hakkı saklıdır.

Ürün kataloğu ve içeriğindeki tüm görsellerin telif hakkı İZELTAŞ İzmir El Aletleri Sanayi ve Ticaret A.Ş.'ye aittir. İzinsiz kullanılması ve çoğaltılması yasaktır.

Kullanıcı, kataloğdaki ürünlerle ilgili güvenlik uyarılarına uymakla yükümlüdür. Bu uyarılara uyulmaması durumunda ortaya çıkacak zararlardan firma sorumlu tutulamaz

Grafik Tasarım ve Düzenleme

İZELTAŞ İzmir El Aletleri Sanayi ve Ticaret A.Ş.

LEGAL NOTICE

This catalog replaces previous editions.

The technical features, appearance and measurements of the products included in the catalog represent the current conditions.

The company reserves the right to make changes to the products if necessary.

The copyright of the product catalog and all the images in the content belongs to İZELTAŞ İzmir El Aletleri Sanayi ve Ticaret A.Ş.

Unauthorized use and reproduction is prohibited.

The user is obliged to comply with the safety instructions for the products in the catalog. The company shall not be liable for any damages resulting from failure to comply with these instructions.

Graphic design and editing

İZELTAŞ İzmir El Aletleri Sanayi ve Ticaret A.Ş.



www.izeltas.com.tr

Где купить:
ООО "КОМПАНИЯ ОПТУЛС"
г.Москва, ул.Иловайская, д.3, стр.2
Tel.: +7 (495) 646-00-96
E-Mail: sale@opttools.ru
Internet: www.opttools.ru



IZELTAS[®]
İZMİR EL ALETLERİ SANAYİ VE TİCARET A.Ş.

Kemalpaşa Caddesi No: 303 Işıkkent İzmir - TÜRKİYE

İNTERNET ADRESİMİZ /WEB ADDRESS
www.izeltas.com.tr info@izeltas.com.tr

SİPARİŞ TEL / PHONE FOR ORDERS

Direkt: +90.232 472 13 92
Santral Tel: +90.232 472 13 75
Fax: +90.232 472 13 78

**ANKARA BÖLGE MÜDÜRLÜĞÜ:
ANKARA OFFICE:**

Alinteri Bulvarı Alinteri Plaza 23 / 3
OSTİM ANKARA
Tel: +90.312 385 24 83 - 385 24 28
Fax: +90.312 385 04 13

**İSTANBUL BÖLGE MÜDÜRLÜĞÜ:
İSTANBUL OFFICE:**

Tel: +0533 603 4181 - 0535 461 5487