

 **LINDSTRÖM**<sup>®</sup>  
A registered trademark of SNA Europe Group

Precision tools

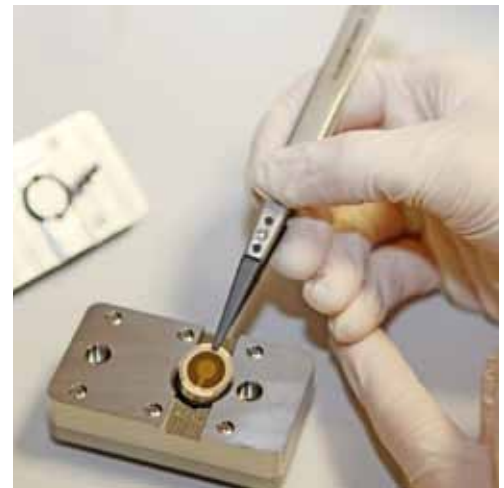

## **LINDSTRÖM PRECISION TOOLS**

Lindström precision tools are the essential, specialist tools for electronic, electromechanical and medical device assembly, rework and repair. Since 1856, Lindström tools have been setting the standards for precision tool manufacturing ever since.

The expression 'the right tool for the job' could not be more appropriate than in a discussion about hand tools. Whether in the hands of a skilled professional or a new operator, the right tool can make the most difficult operation a simple task.

## **CHOOSING THE RIGHT HAND TOOLS**

In today's complex working environment, it is important to understand and consider the different requirements and conditions that affect your choice of hand tools.

For example:

- How frequently are you going to use the tool?
- What type of result are you trying to achieve?
- What kind of material are you going to cut or bend?
- Can you use one tool instead of two?
- Do you have concerns about ESD or other specialized standards?

These questions and many more should be considered in making your choice. This catalogue includes information to assist you in choosing the right tool for your application.

# INDEX

## INFORMATION

About	3
Manufacturing know-how	4
Cutting pliers	9 - 14
Capacity and options	15 - 16
Cutting capacity	17
Holding pliers	18

## PRODUCT RANGES

Rx Series	19 - 26
80 Series	27 - 30
Supreme Series	31 - 35
Tweezers	36
Torque screwdriver	52

## INDIVIDUAL LISTINGS AND SPECIFICATIONS

Rx cutters and pliers	21 - 27
80 Series cutters	28 - 31
Supreme cutters and pliers	32 - 37
Tweezers	38 - 51
Torque screwdrivers	52

## LINDSTRÖM HISTORY

Started in 1856, Lindström has set the standard in precision tool manufacturing. As one of the oldest continuous producers of hand tools in existence today, Lindström maintains its edge over the competition through its technical understanding, response to market needs, and commitment to advanced technology. Metallurgy, manufacturing techniques, and tremendously skilled crafts people – particularly in the hardening of steel – are the hallmarks of this world renowned manufacturer.

Some companies have been able to implement one facet or another of the Lindström manufacturing cycle. Others have attempted to copy the form, appearance and even the actual part numbers of Lindström cutters. However, none has been able to successfully blend all the elements that are required to achieve the level of performance recognized worldwide as belonging to a true Lindström cutter.

## BACKGROUND

Many years ago, cutters were primarily used in heavy-duty work, i.e. cutting heavy electrical wire and wires used in the telecom field. In order to meet the requirements of linesmen and other general use workers, tool manufacturers designed a cutter that left a wide, pyramid-shaped lead end after cutting. Its hardness was adequate for the strain put on the cutter blades.

However, as the electronics and other related industries developed, the requirements on tools, and in particular cutters, became far different. For example, many people believe that an electrician must do a lot of cutting. Yet, an electrician may make fewer cuts in his lifetime than some electronic assembly workers make in one month! Therefore, the need for cutting small wires thousands and thousands of times necessitated a radically new and innovative technology.

Small cutters were needed that could cut both extremely small and relatively large diameter wires, often of quite different materials. In addition, the lead ends had to be quite different since the solderability of

these wires was of paramount importance. These lead ends had to be covered completely and properly with no bare copper or basis material exposed.

Compounding the problem was the accessibility issue, as not all cutters could get into the same area. Transmission of the mechanical shock of cutting to sensitive semiconductor components added even more cutter design challenges. However, despite some manufacturers' claims to the contrary, there are no secret or 'magic' materials or processes that can give you some kind of super cutter for all applications. Some inherent trade-offs in the design of tools and choices must be made in order to meet certain application requirements. For example:



At what point is the cutter head small enough to gain access and still be able to withstand the impact of cutting wires (of various sizes) innumerable times?

How flush should the cutting edges be in order to meet tough specifications yet still keep tool life extended to the maximum? And what about resistance to edge damage due to occasional misuse?

To what degree of hardness should the tool be made in order to extend tool life and still limit breakage due to being too brittle?

What type of joint should be put into a tool to extend the precision of the cutting edges and still be cost effective for you to use?

Understanding these trade-offs is the key to making an objective and cost-effective choice of tools for your specific application.

Lindström cutters offer an unequalled blend of the technical elements required to achieve the level of performance demanded by a growing number of users.

## **MATERIALS**

Every cutter begins with the fundamental materials. Even slight adjustments to these ingredients can change the way steel performs. Lindström has been refining this formula for over 150 years. The 1% carbon, with a pinch of chrome and other key

of tremendous resiliency and toughness with the ability to withstand greater impact, yet with the ability to return to its original form without damage. This is one of the reasons why Lindström cutters offer greater life and have less breakage than other brands used in the same applications.

## **LUBRICITY**

Another characteristic that emerges from a Lindström cutter is the ease with which the tool makes its cut. The precision of the machining makes it as if there is a built-in, which makes the cutting easier. This not only helps to make a better cutter, but also reduces operator fatigue.

## **HARDNESS**

Different steels have different personalities – each allowing a certain level of hardness. If specific steel is hardened too much for its composition, it will break easily. On the other hand, not enough hardening can sharply reduce tool life. How steel is cooled after hardening and recognizing the different strength capacities of that steel are some of the key factors that make the hardening process a difficult science to master.

materials, is similar in many ways to the steel used for high-quality ball bearings. This is the material used for all Lindström pliers. The use of ball-bearing grade steel and appropriate heat treatment ensures Lindström cutters last for longer than other brands used in the same applications.

## **RESILIENCY**

One of the challenges in tool design and usage alike is the search to increase tool life. Decreased life is caused generally by usage beyond the limits of the material and its corresponding hardness.

The use of ball bearing grade steel together with proper heat treatment offers the possibility of a cutter

Measuring the hardness on a Rockwell Hardness Scale, Lindström cutters are elevated to a hardness of 63-65 on the cutting edge. This hardness ranks among the highest of any cutters made. For most manufacturers, this hardness level would create a high breakage rate.

Yet, because of the steel, and proper control and consistency of the hardening area – even when used beyond the rated capacity – Lindström cutters have remarkably little breakage.



## METHODS OF MANUFACTURING

### FORGINGS

One of the major breakthroughs in Lindström technology is the ability to produce exact, precision forgings. Without that capability, the automated production process cannot be utilized effectively. Therefore, as the first step in the manufacturing cycle, forgings are a key element in the total production process. To maintain interchangeability, every forging must be perfectly precise and compatible to one another.

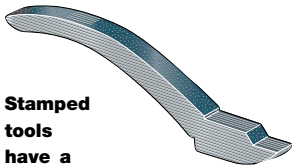

**Stamped tools have a straight grain; this construction is useful for certain applications but ultimate tool life and strength can be compromised.**

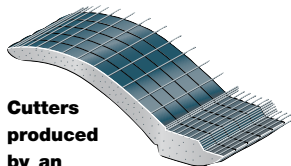

**Cutters produced by an extrusion method have a cross grain structure; thus, they are susceptible to greater breakage, particularly along the cutting edges and the joint.**

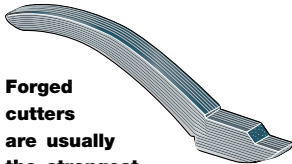

**Forged cutters are usually the strongest. Their grain structure follows the profile of the cutter.**

Despite automation, any production process can be extremely limiting if not utilized effectively. Lindström effectiveness is directly related to the use of forgings of exact dimensions. When forgings are not uniform, it becomes nearly impossible to obtain the repeatability necessary to produce a consistent quality tool.

Attempts have been made by others in the industry to automate the manufacturing process without such forgings, but the tools produced are physically erratic. The result is an increased breakage level or rapid deterioration of the cutting edges – expensive tools at any price.



### PROCESSES

Anyone involved in manufacturing knows that to attain a quality process, there are no shortcuts – learning must be by doing. Subsequent steps in the Lindström cutter production process have been painstakingly developed over a 30-year period backed by more than 150 years of precision tool production and know-how. Lindström is constantly seeking the best way to achieve consistent quality results. These results are seen in the perfect symmetry of the cutter components, the exactness of the grinding, and the consistent hardening. The reliability and consistency of these details are the Lindström hallmark.



## JOINTS

The joint is a crucial part of the structure of the pliers. It is the key to smooth running and long term performance. For this reason, all Lindström precision pliers have screw joint while the lap joint with rivet is only used for heavy duty pliers.



## LAP JOINT WITH SCREW

The lap joint with screw is the marriage of a fine pitch threaded screw and miniature nut. It is extremely important that these two parts are geometrically correct. However, there is more to achieving strength and precision in the joint than that. For example, a screw-and-nut combination that is absolutely flush with the edge of the tool may have insufficient threads to maintain consistent alignment. On the other hand, a screw-and-nut combination that has external heads on both sides of the joint may limit the cutters' possibility to be used for a number of tight access applications. Lindström eliminated this predicament through the positive integration of both designs. With one flat external head and one flush head, both adverse conditions are eliminated. In the end, this design assures the user of sufficient threads for continuous alignment and a narrower profile for greater accessibility on inner contact surfaces in terms of finish and tolerances.

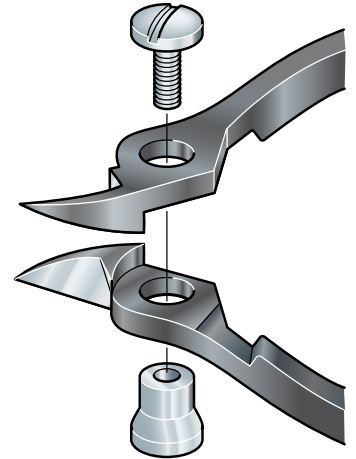

## LAP JOINT WITH RIVET

The lap joint with rivet is both economical and effective for those tools used for occasional work or for heavy-duty cutting where the requirements for precision are not as great. This joint's limitation is that it is difficult to achieve the precision of a screw and nut in terms of holding torque and bearing surface for moving parts and thus it can loosen or develop 'play' more easily over time. This leads to misaligned cutting edges, a property that is not conducive to exact and continuous cutting.

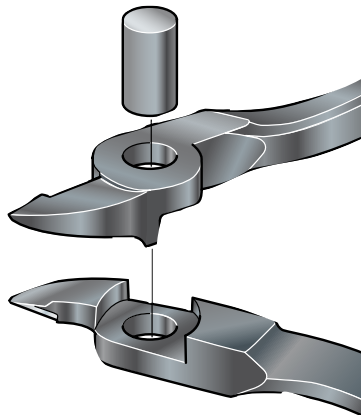

## ERGO™ & DESIGN



If hand tools are to be ergonomic, they must be perfectly suited to the task, the user and the environment. That is why all three of these factors are crucial when creating an ERGO™ product.

Ergonomic tools are designed to fit the human hand, minimising grip-strength demands and allowing muscles to relax periodically, reducing the risk of static muscle fatigue. Locking or adjusting mechanisms must be safe and easy-to-use, mitigating the risk of injury or any awkward hand positioning. Contact stress and slipping should be managed through the right choice of materials and handle design. The handle is fundamental as it also provides the right sensory feedback for accuracy, precision and optimum control of the tool, and is designed to reduce vibrations to the hand and arm.

Whenever an ERGO™ tool is being developed, sustainable efficiency and effectiveness are considered, as well as reliability and durability in challenging environments. Safety is paramount and we work to prevent risks of both immediate and long-term injuries and pain.

We also take pride and the experience into account - our ergonomic tools are made to be attractive and give the user control, comfort and precision. We innovate continuously, in terms of function, material and design.

We believe it is important to adapt tools to the potential and limitations of human anatomy, instead of expecting people to adapt to our tools.

We believe in putting the right tools in the hands of professional users, mitigating injury and making their work more efficient, effective, less tiring and more fun!

### ERGO™ Development Program

Our scientific ERGO™ Development Program (the 11-point program) has resulted in many successful and scientifically evaluated ergonomic tools. We work hard to deliver the best possible tools to every customer, and over the years we have continuously developed, improved and fine-tuned the way we do this.

### The ERGO™ Process

So far there are some 500 ERGO™ tools, and the demand is ever-increasing. In order to sharpen our competitive edge in ergonomics and industrial design we have refined the way we design into the ERGO™

Process. This is a comprehensive three-phase process, with each phase consisting of several steps.

The ERGO™ Process is unique to Lindström and scientifically formulated with the help of Industrial Designers and Ergonomists.



The ERGO™ Process complies with ISO 9241.

The first phase of the ERGO™ Process is Observe. Its purpose is to provide the foundation for ergonomic product development. It consists of pre-studies for each product idea, with emphasis on the ergonomic survey - a series of interviews to obtain insights into the tasks performed with the tool, looking at how it is handled, who uses it, and in what kind of environment.

The second phase is Experiment. It starts with a prototype design that is then tested by users and those test results analysed. This leads to a new series of prototypes that are put through user tests and analysis again. The number of design and test rounds varies, depending on a number of factors.



At the end of this phase, conclusions are made and a successful product prototype can move to the last phase, themed as Define. At this point the final design proposal is made based on all the studies and tests made the previous two phases, and the product specifications and other necessary documents are prepared for the product to be ready for introduction.

### The Registered Trademark ERGO™

Each ergonomic Lindström tool is developed by following the ERGO™ Process thoroughly. The Design Manager of SNA Europe certifies that this process has been correctly followed and that the research for the tool has been performed accordingly. An ERGO™ Diploma is issued for all approved tools, and they are marked with the  logo.

Professionals used to be satisfied with very durable steel tools. This emphasis on durability meant that almost all attention was focused on the composition of steel, the life of cutting edges, joints, etc. Thus, for many years, the design of high quality tools for professional use in industry has been technology driven, rather than operator oriented.

Today, users are more demanding in terms of function and comfort. As a matter of fact, a growing number of professional users now demand tools that meet the highest standards of performance and simultaneously reduce the risk of injury in the short and long term. This demand is primarily due to two factors: First, the increased concern with safety in the workplace, particularly with regard to the frequent involvement of both repetitive motions and high force in many industrial tasks, often in combination with poor hand/arm posture caused by the inappropriate design of some traditional hand tools. The costs for the use of inappropriate hand tools, unsuitable work stations, and job routines will, of course,

be shared among the individual operators, the company, and society in the form of direct medical expenses, work lost, reduced quality, training of workers, disruption of work, increased insurance and administrative costs.

Second, this demand reflects the recognition of the importance of quality as well as output volume in many industrial tasks, and the need for tools which enhance not only user capabilities but which also offer the ability to give consistent, high performance results – day in and day out.

By introducing ergonomists and industrial designers into the design process, additional focus is being placed upon industry and operator demands. Thus, the dynamics of tool use, operator preference, and the size and shape of the hand tool are now all design priorities.



## CUTTER HEAD SHAPE AND SIZE

Head shapes vary in size and configuration depending on the application. However, there are four primary types, with variations of each.

### OVAL HEAD

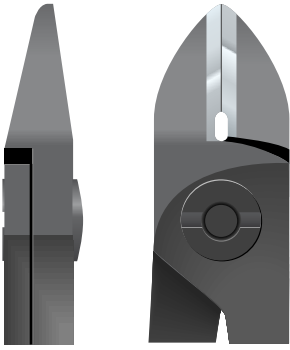

Most common of all the head shapes is the oval head. Combining strength and flexibility, the oval head can withstand and distribute the impact of cutting and is utilized in a myriad of applications. The head shape combined with materials, method of manufacturing, type of

cut, and the tool's hardness, determine the range of cutting capability.

### TAPERED HEAD

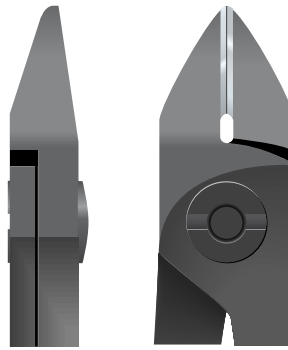

When the sides of the cutters' head are shaped along diagonal lines, the operator can effectively broaden the range of tasks this tool can fulfil. The Lindström tapered head cutter utilizes this design without reducing the cutting range, and increases the number of

areas that the operator can gain access to.

However, since the tapered head does not stand up to occasional misuse as well as an oval head design of similar dimensions, a greater degree of care should be observed in its use.



The Rx8130 with miniature oval head will cut copper wire up to 1.25mm/16 gauge in diameter. Yet, the Rx8130 is far smaller than models from other manufacturers considered to be of similar capacity and is one of the strongest miniature cutters on the market.



Tapered Rx8143 allows better tip access yet still has a good general range of cutting capacity.

## TAPERED AND RELIEVED HEAD

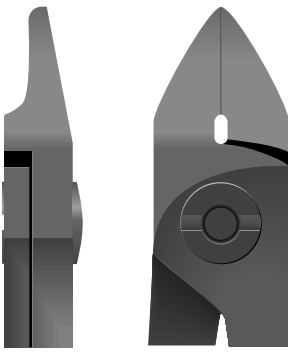

This head style is the smallest of the standard cutting heads available. Not only does it taper on both sides, but also the underside is cut away, allowing the operator to gain access into some difficult areas. Although this provides an obvious advantage, this head style

does have a slightly reduced cutting range.

**Special care should be taken not to use tapered and relieved cutters outside their specified range of cutting capability.**

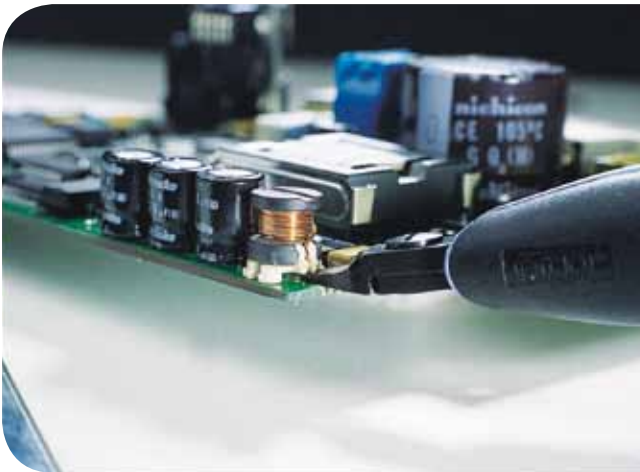

**Tapered and relieved Rx8146 provides improved access and visibility for even the most difficult job.**

## ANGLE HEAD

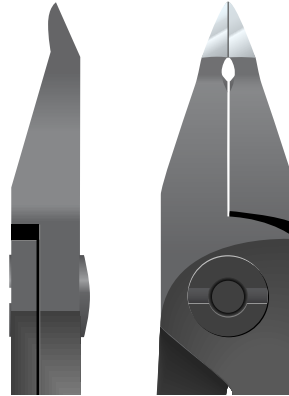

This head shape is sometimes called an oblique style with its head set at an angle to the main body of the cutter, the purpose of which is to reach between wires or parts or into areas which are difficult to access.

Tools of this design can also be used to trim standard leads or parts with the advantage being

that the operator's hand can be in a different position if desired. The cutting range of the angulated head will vary depending upon its style, but some degree of care should be observed in its use.

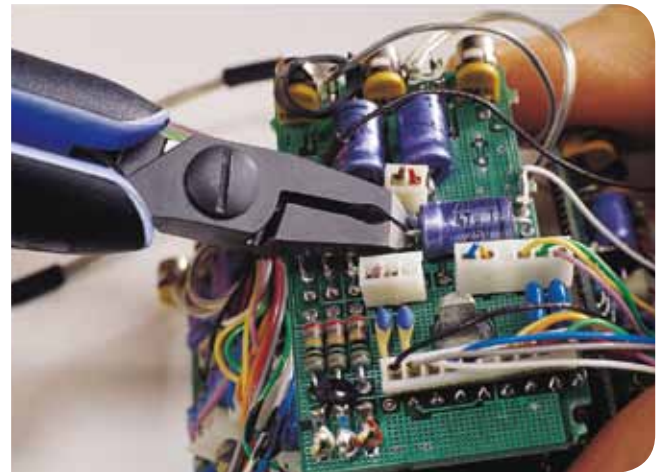

**Angle head Rx8247 provides benefit of reach and operator visibility.**



## Lead-Catchers

Lindström's patented lead-catcher is an accessory that stops just-cut ends of wire from falling into critical or sensitive areas, which could result in a short circuit or contamination. Almost all Rx cutters can be factory equipped with a leadcatcher. Just add "S" to the tool part number. Ex. Rx 8140-S.

## CUTTING EDGES

Explaining the type of cut that particular cutters make is perhaps the greatest area of confusion and worthy of special study as there is no real standardization of terminology, and each brand offers its own description of its type of cut. Understanding these differences is particularly important in the ordering process.

It is imperative that you recognize what type of cut you require and what the cut lead-end should look like after it is cut. This is especially true in the tighter requirements and specifications of military and high-end commercial electronics.

### THE SEMI-FLUSH CUT

This type of cut leaves a large lead-end, shaped like a pyramid, and has been manufactured for decades by every tool manufacturer. This type of cutting edge is a good application match for general electrical or hobby cutting where tool price is often the primary consideration.

This application match is good due to the fact that the cut lead shape is satisfactory for these applications and the cutting edge itself does not require a high level of hardness, sophisticated material to achieve that hardness, or an extremely precise type of joint in order to function.

### THE MICRO-BEVEL CUT

To meet the requirements of the electronic assembly industry, Lindström designed the Micro-Bevel. Its unique cut is quite different from the semi-flush cutters. Its leads are 'pinched', unlike the pyramid look of the semi-flush cut, allowing less altitude and smaller overall surface area. Because of its design, it has an extremely wide cutting range, and a variety of uses far beyond any other cutter produced today. For example: Lindström produces a cutter (Rx8130) that has a cutting range for copper from 0.2 mm/32 gauge to 1.25 mm/16 gauge yet has a remarkably small overall head size.

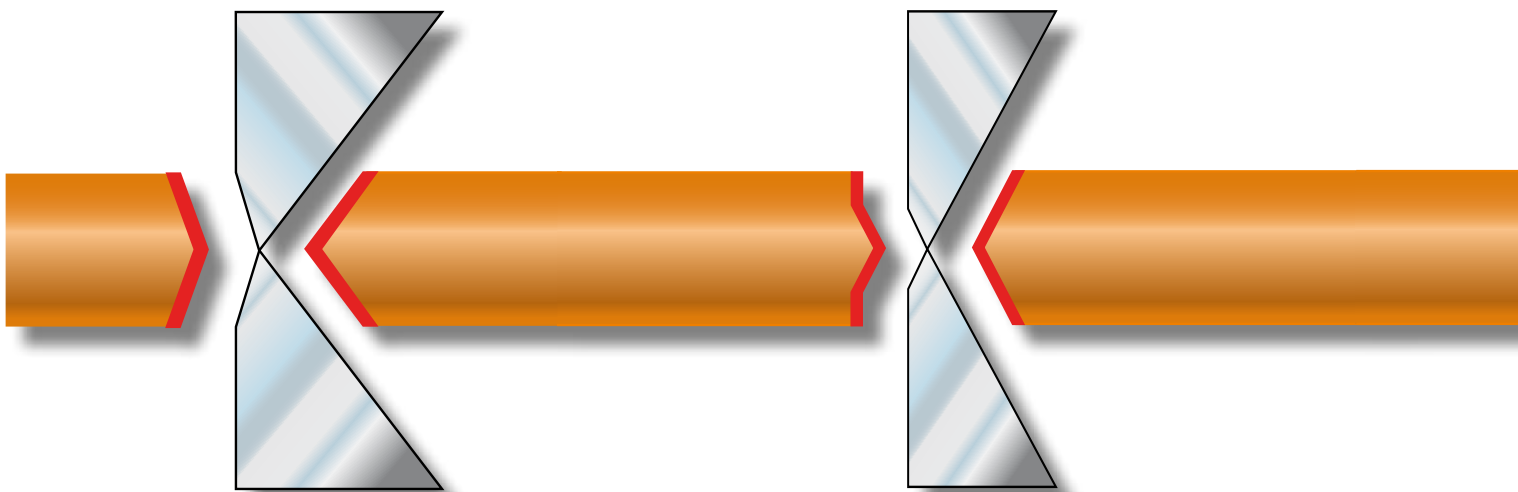

**THE SEMI-FLUSH CUT**

**THE MICRO-BEVEL CUT**

## THE FLUSH CUT

The cutting result of most flush cutters, their individual terminology notwithstanding, is somewhat similar. Flush cutters also pinch the leads, but at a lower altitude than Micro-Bevel cutters. These cutters have finer cutting edges than semi-flush or Micro-Bevel cutters. Lindström's flush cut also creates a pinched lead. However, it is configured slightly differently than that produced by other cutters. The Lindström flush cutters leaves a narrower and shorter taper along the pinch, thereby reducing the total exposed area. The reason for using a Lindström flush cutter rather than the Micro-Bevel is to meet a slightly tighter specification for the cut lead-end or to gain a more flush result to a board, component, or part.

### EXCEEDING THE FLUSH CUT

**Many manufacturers have a cut which, in reality, is just a smaller pinch, allowing own equipment manufacturers to meet solderability specifications and alleviate shock. This pinched lead is deemed acceptable for many items produced for high-specification applications, but confusion is caused by the size and height of the pinch as each cut will vary from brand to brand and between manufacturers.**

**The general consensus is that the greater this pinch becomes, the less the acceptability of the cut. The critical area here is realizing that as the cutters wear down, the size of the pinch increases and could rise above the maximum acceptable height. Moreover, the greater the pinch, the greater the mechanical shock transmitted.**

## THE ULTRA-FLUSH CUT

The question to be addressed then is why have a pinch cut at all? Lindström engineers have designed the Ultra-Flush cutter which virtually eliminates the pinch other cutters make. The Ultra-Flush configures two flat planes with a barely discernible line separating each of these planar surfaces. Only a precise screw joint and a specially designed radius on the cutting edge could allow this razor-sharp edge to be utilized effectively.

The trade-off in this case is a more limited cutting range and greater possibility for edge damage due to misuse. However, with the exception of Lindström's own Micro-Bevel and Flush cutters, the Ultra-Flush will outlast any other 'flush' or 'shear' type of tool and still match competitive cutting ranges.

The unique design of the Ultra-Flush is perfect for use in close tolerance electronic and medical device assembly where concerns about mechanical shock transmission or final lead-end configuration are a top priority.



THE FLUSH CUT

THE ULTRA-FLUSH CUT

## HOW TO CHOOSE?

Deciding which cutters to use among the very large assortment offered in this catalogue can be challenging, to say the least. In addition, there can be several good options to choose from for a given application.

We are often asked, 'Why do you offer such a large range of hand tools, and specifically, so many cutters?' There are two primary reasons for having such a large assortment.

First, the applications served by these tools are almost infinite. From a pure application point of view, more specialized tools are often required to achieve the most cost effective and technically sound result. In addition, requirements in terms of size and composition of materials to be cut or bent and the end result required can change very rapidly in the fast-moving assembly industry. So maintaining a wide assortment gives you assurance that you can find a good solution for future application requirements that you may not have at present.

Secondly, applications are only a part of the reason for such a wide assortment. The fact is that beyond certain basic health and safety guidelines in proper tool usage, operator preference in terms of positioning, visibility, reach, experience, etc., varies greatly from one operator to another, with very few clear 'right or wrong' aspects. We have the broadest assortment in the precision pliers market to ensure that we offer the perfect tool for each application. This means we have to offer many variations.

However, even with that understanding, choosing can still be a challenge! Here are some basic suggestions that can help you narrow your choice to a few very good options.

### What kind of cutting result do you want?

1. If the cutting result is not critical, then go with the Micro-Bevel as this cutting edge bevel gives you the best capacity and life in most applications.

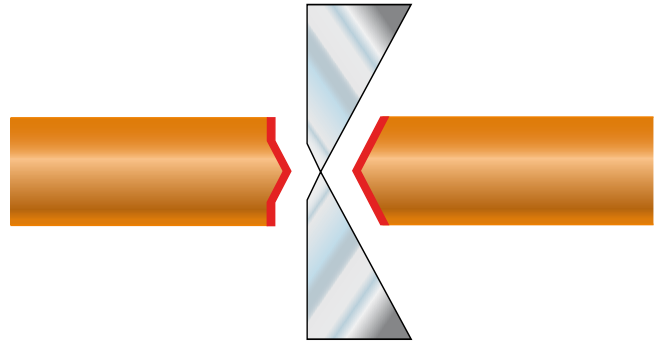

2. Use the Flush if Micro-Bevel is not suitable.

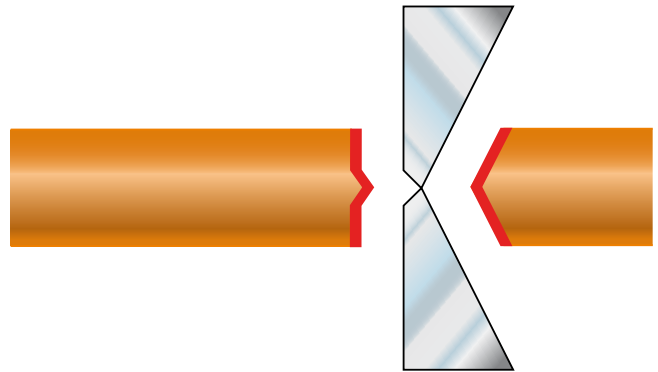

3. Use the Ultra-Flush only when required, as it requires the most care in use.

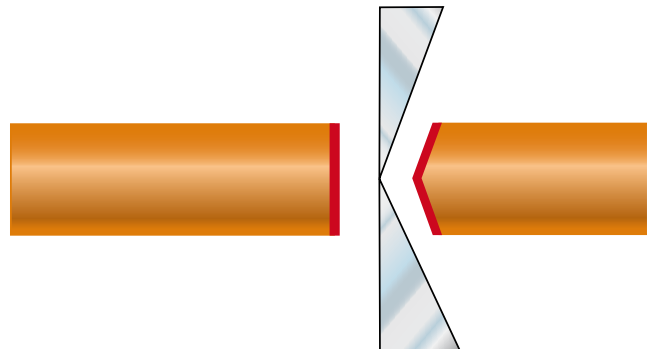

## WHAT ARE THE TYPES AND DIAMETERS OF MATERIAL YOU WANT TO CUT?

All of our cutters are rated for copper wire. However, quite often you are not cutting simple copper wire. We rate them for copper as that is a standard that almost all can relate to. Some cutters are also rated for tougher material such as spring wire. However, almost everything else you are cutting will fall in toughness between copper and spring wire.

For instance; is the material a little tougher than copper or a lot? This will further narrow the field by eliminating the cutters not likely suitable for the application.

## IS ACCESS (SPACE AVAILABILITY) TO THE APPLICATION AN ISSUE?

If access is not a challenge, then lean towards an Oval head - in as large size as possible - as this is the strongest type of head configuration. One basic fact of the assembly and repair environment is that cutters on a workbench or in the field will at one time or another be used on something either larger or harder than the original intended application. This is when having chosen a Lindström, which is solidly engineered and conservatively rated to begin with and the strongest and largest configuration in the Lindström range that can be used for the application, makes sense. And saves you a lot of money - the tool will much more easily survive occasional misuse and continue to give good results.

If access is an issue, then try to use a smaller Oval head. If that puts you out of cutting range or is still too large at the tip, then move over to a Tapered head. If a Tapered head still doesn't fit the application, then go with the Tapered and Relieved head.

## IS REACH OR ANGLE TO THE APPLICATION AN ISSUE?

Then consider an angle or tip cutter. However, keep in mind that the smallest configurations in this type should then be reserved for that application and used with considerable care.

## CONTACT US

If you still have questions about which tools are best suited for your application, we strongly encourage you to contact Lindström or SNA Europe. Our representatives can make informed recommendations or furnish tools for evaluation where they provide the best opportunity for you to observe their value – on the job. On our Website, [www.lindstromtools.com](http://www.lindstromtools.com), you will find our world-wide presence and can easily locate a Lindström professional ready to help you find the right tool for the job.



# Capacity and Options

## SIZE

<b>XS</b>	Extra Small
<b>S</b>	Small
<b>M</b>	Medium
<b>L</b>	Large



## SHAPE

<b>O</b>	Oval
<b>T</b>	Tapered
<b>T&amp;R</b>	Tapered & Relieved
<b>A</b>	Angle
<b>TP</b>	Tip
<b>ED</b>	End

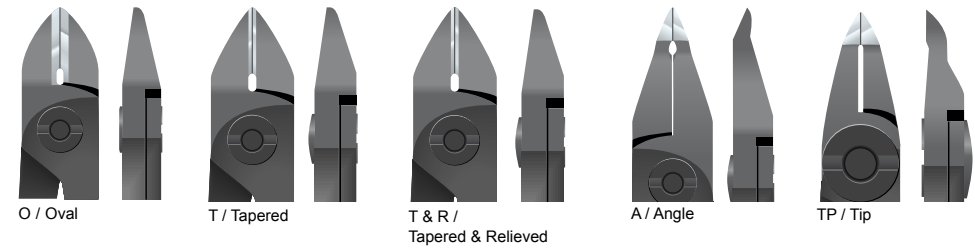

## CUT OR SURFACE

<b>MB</b>	Micro-Bevel®
<b>F</b>	Flush
<b>UF</b>	Ultra-Flush
<b>SM</b>	Smoth-Tip
<b>SE</b>	Serrated-Tip

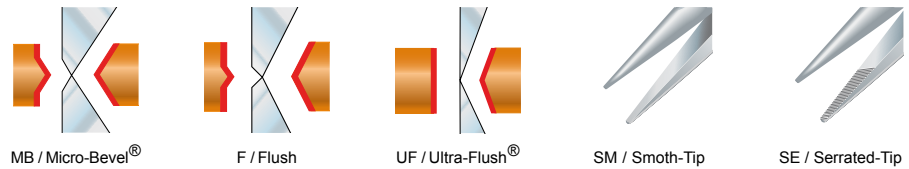

## HANDLE OPTIONS

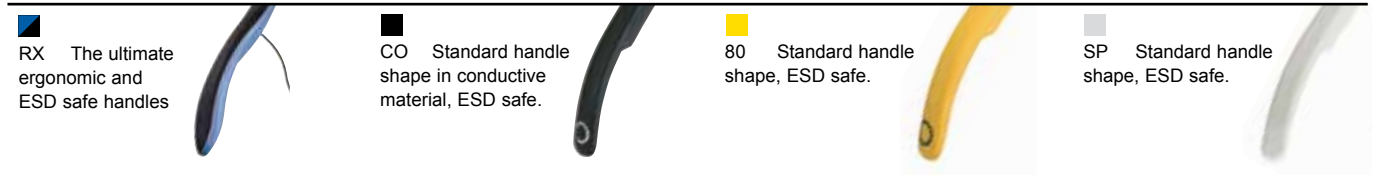

## LEAD CATCHER

Lindström's patented lead-catcher is an accessory that stops just-cut ends of wire from falling into critical or sensitive areas, which could result in a short circuit or contamination. The lead catcher product code is 813 for 8130-8132 and RX 8130-8132, and 814 for cutters 8140-8148 and RX 8140-8148.









## PLIERS

### EXTENSIONS OF THE HAND

Holding pliers are used on the toughest, most forceful applications – from removing plate steel retaining pins on an oil derrick to the most sensitive and sterile of environments such as surgery. This is because pliers represent the functional expression of replicating and increasing the capabilities of the human hand across many dimensions, particularly of the thumb and adjoining finger, in terms of force and precision.



That is why holding pliers are available today in an almost limitless number of shapes, styles, configurations, materials, and sizes.

### PLIERS EVALUATION

Evaluating pliers in an objective manner is not a straightforward task. Cutters, for example, can be put on a machine or on the assembly line, and capacity or number of cuts can be tested with some degree of confidence.

Holding pliers are not so easily tested in an objective way – again, because of the almost limitless way in which they are configured and used and also because of their often very long service life.

The forces at work on holding pliers are also different from cutting pliers. With cutters, force and wear act on the joint in primarily a single plane, and the overall concern is the precision with which the joint keeps the edges in alignment together with the performance of the cutting edges and jaws when subject to the impact and wear of continuous cutting. By comparison, the joint in holding pliers must be able to withstand the very high and often simultaneous force of multiple plane actions such as holding and twisting

in combination with pushing or pulling. In addition, in most applications actual wear on the pliers' jaws is somewhat secondary to the concern with the ultimate strength and resistance to breakage of the jaws with maximum force applied. Therefore, holding pliers' performance and capability tend to be strongly influenced by the type and quality of construction of the pivot joint used.

The consideration of the positives and negatives of each of these constructions can be somewhat different than for cutters. The key is to take these considerations into account together with your intended application and frequency of use so that you can make an informed, cost-effective decision.



# RX Series

## LINDSTRÖM RX: THE ULTIMATE IN PERFORMANCE, PRECISION, AND COMFORT

To be the leader in a competitive field takes dedication, hard work, and practice, which is exactly what Lindström has been doing since 1856 – perfecting the best hand tools money can buy. For more than 150 years, we have designed and refined the world's leading cutters and pliers. And in that time, we have learned what works, and what does not. But to fully comprehend what makes the Rx the very best, one should take a close look at the Rx and then compare all else on the market to it. The Rx will always come out on top.



### ESD safety

All Lindström RX pliers (except TRX 8180) are ESD safe. Resins with conductive additives in the handles create a material that safely dissipates electrostatic charges, reducing possibility of damage to sensitive components.

**Warning! Lindström pliers are not 1000V insulated and therefore should never be used on electrified equipment.**

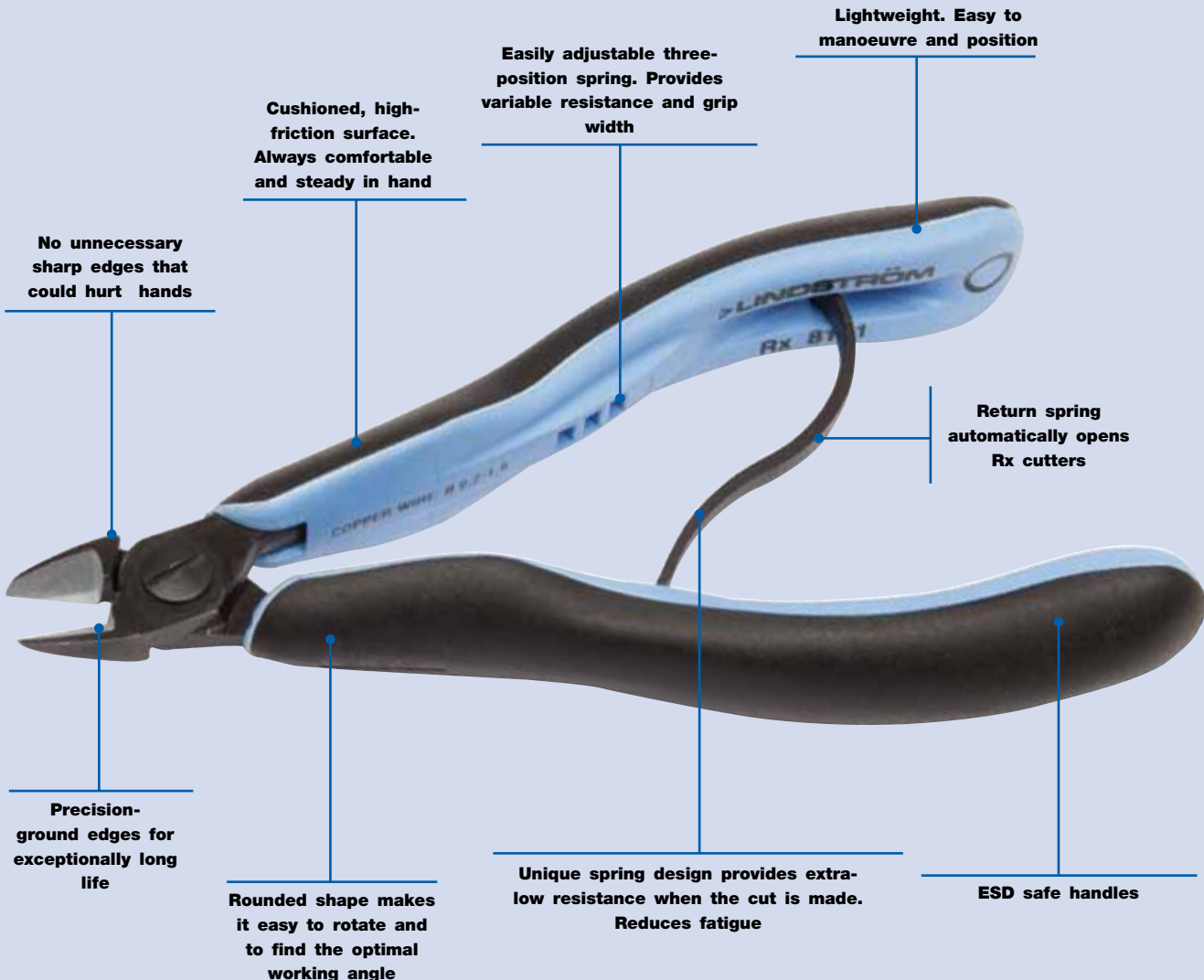

## TO ADJUST RX

1. Pull the tool handles apart



2. Place the spring into the desired port



3. Close the tool



### Biospring®

Since it is the traditional nature of a return spring to provide greater resistance the more it is compressed, this has been a challenge for ergonomists whose goal is to make work easier and safer.

The solution lies in Lindström's new, patent applied for, Biospring®, a solution that is as simple as it is ingenious – where the material and design work together to provide new characteristics.



### Rx plus Biospring®

- Tension is kept minimal and limited throughout the working cycle of the tool.
- Handle width is controlled for ease of tool pick-up and handling.
- Tension and opening width can be adjusted to suit your preference via three different ports.
- Almost indestructible in normal use.

Microtouch is the shape that makes it possible to control and rotate the RX between thumb and index finger for precision work.



# RX Cutters and Pliers

## Rx Series diagonal cutters oval head

### RX 8130-RX 8162

ergo®

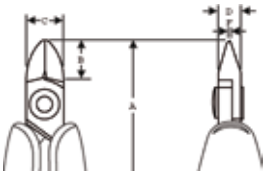

			A mm	B mm	C mm	D mm	F mm			
	731415									
RX 8130	0103003	1	133.5	8.5	8.0	5	0.8	0.2-1.0	Micro	68
RX 8131	0103010	1	133.5	8.5	8.0	5	0.8	0.1-1.0	Flush	68
RX 8132	0103027	1	133.5	8.5	8.0	5	0.8	0.1-0.8	Ultra	68
RX 8140	0103034	1	135.5	10.5	10.0	6	0.8	0.2-1.25	Micro	70
RX 8141	0103041	1	135.5	10.5	10.0	6	0.8	0.1-1.25	Flush	70
RX 8142	0103058	1	135.5	10.5	10.0	6	0.8	0.1-1.0	Ultra	70
RX 8150	0103133	1	138.0	13.0	12.5	6	1.2	0.3-1.6	Micro	73
RX 8151	0103140	1	138.0	13.0	12.5	6	1.2	0.2-1.6	Flush	73
RX 8152	0103157	1	138.0	13.0	12.5	6	1.2	0.2-1.25	Ultra	73
RX 8160	0111534	10	147.0	16.0	16.0	8	1.6	0.4-2.0	Micro	97
RX 8161	0111541	10	147.0	16.0	16.0	8	1.6	0.3-2.0	Flush	97
RX 8162	0111558	10	147.0	16.0	16.0	8	1.6	0.3-1.6	Ultra	97

## Rx Series diagonal cutters tapered head

### RX 8143-RX 8145

ergo®

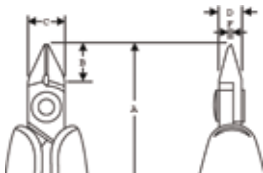

			A mm	B mm	C mm	D mm	F mm			
	731415									
RX 8143	0103065	1	135.5	10.5	10	6	0.8	0.2-1.25	Micro	68
RX 8144	0103072	1	135.5	10.5	10	6	0.8	0.1-1.25	Flush	68
RX 8145	0103089	1	135.5	10.5	10	6	0.8	0.1-1.0	Ultra	68

## Rx Series diagonal cutters tapered and relieved head

### RX 8146-RX 8148

ergo®

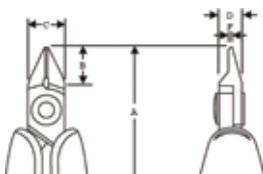

			A mm	B mm	C mm	D mm	F mm			
	731415									
RX 8146	0103096	1	135.5	10.5	10	6	0.8	0.2-1.0	Micro	68
RX 8147	0103102	1	135.5	10.5	10	6	0.8	0.1-1.0	Flush	68
RX 8148	0103119	1	135.5	10.5	10	6	0.8	0.1-0.8	Ultra	68

# RX Cutters and Pliers

## Rx Series diagonal cutters tip cutter

### RX 8149

ergo®

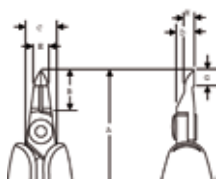

	 731415		A mm	B mm	C mm	D mm	E mm	G mm	H mm	 mm		 g
RX 8149	0103126	1	139.0	14	10	6	5	5	3.2	0.1-0.6	Flush	70

## Rx Series oblique cutters 20° short head

### RX 8211

ergo®

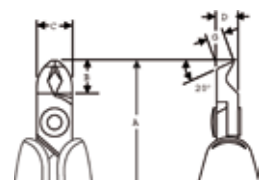

	 731415		A mm	B mm	C mm	D mm	G mm	 mm		 g
RX 8211	0103188	1	134.5	9.5	10	6	4.1	0.2-1.2	Flush	70

## Rx Series oblique cutters 45° long head

### RX 8247

ergo®

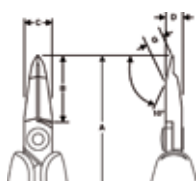

	 731415		A mm	B mm	C mm	D mm	G mm	 mm		 g
RX 8247	0103164	1	143.0	18	10	6	6.7	0.2-1.0	Flush	72

# RX Cutters and Pliers

## RX 8248

ergo®

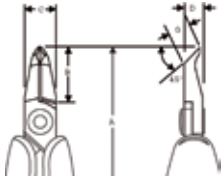

	 731415		A mm	B mm	C mm	D mm	G mm	 mm		 g
RX 8248	0103171	1	143.0	18	10	6	6.7	0.2-0.8	Flush	72

## Rx Series micro tip cutters

## RX 8233

ergo®

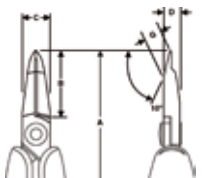

	 731415		A mm	B mm	C mm	D mm	G mm	 mm		 g
RX8233	0113521	1	149.0	22.3	10.6	7.0	7.2	0.1-0.65	Flush	69

## RX 8234

ergo®

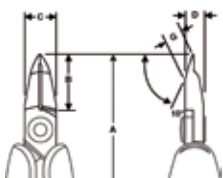

	 731415		A mm	B mm	C mm	D mm	G mm	 mm		 g
RX8234	0113538	1	141.0	14.2	10.6	7.0	3.2	0.05-0.4	Flush	62



# RX Cutters and Pliers

## RX 8237

ergo®

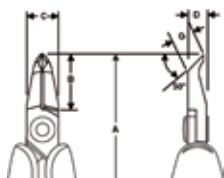

	 731415		A mm	B mm	C mm	D mm	G mm	 mm		 g
RX8237	0113545	1	144.0	17.4	10.6	7.0	4.1	0.1-0.65	Flush	65

### Rx Series holding pliers flat nose pliers

## RX 7490

ergo®

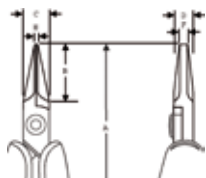

	 731415		A mm	B mm	C mm	D mm	E mm	F mm	 g
RX 7490	0103195	10	146.5	20	9	6.7	1.2	3.2	70

### Rx Series round nose plier

## RX 7590

ergo®

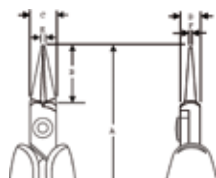

	 731415		A mm	B mm	C mm	D mm	E mm	F mm	 g
RX 7590	0103201	10	146.5	20	9	6.7	1.8	0.9	69

# RX Cutters and Pliers

## Rx Series snipe nose pliers

### RX 7890 / RX 7891

ergo®

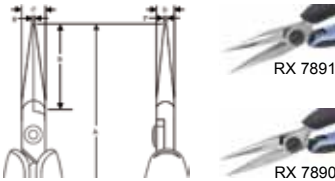

RX 7891

RX 7890

			A mm	B mm	C mm	D mm	E mm	F mm	
RX 7890	0103218	1	158.5	32	9	6	1.2	0.8	72
RX 7891	0103225	10	158.5	32	9	6	1.2	0.8	72

## Rx Series snipe nose plier with bent tip

### RX 7892

ergo®

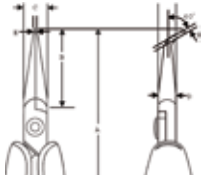

			A mm	B mm	C mm	D mm	E mm	F mm	
RX 7892	0103232	1	155.5	29	9	6.7	1.2	0.8	73

## Rx Series short snipe nose plier

### RX 7893

ergo®

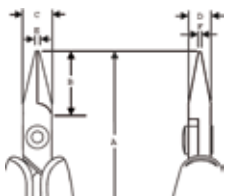

			A mm	B mm	C mm	D mm	E mm	F mm	
RX 7893	0103249	1	146.5	20	9	6.7	1.2	0.8	71

# RX Cutters and Pliers

## Rx Series BIO spring

### RX 01



	 731415		 g
RX 01	0103263	1	5

## Heavy duty cutter

### TRX 8180

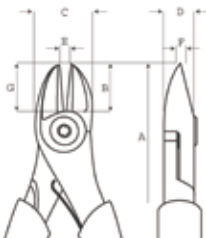

	 731415		A mm	B mm	C mm	D mm	E mm	F mm	G mm				 g
TRX 8180	0112272	5	210	21	29	11	2.5	1.5	21	4.5	3.0	2.5	304

## Plastic cutter

### P6160

ergo® PLASTIC

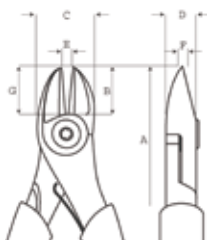

	 731415		A mm	B mm	C mm	D mm	F mm	G mm	 g
P6160	0115075	5	160	18	21.5	10	1.5	18	162

# 80 Series

## LINDSTRÖM 80 Series: TRIED AND TRUE PERFORMANCE FOR THE TRADITIONAL USER

Surpassed only by our own Lindström Rx range, the Lindström 80 Series remains the top choice for the traditional user. This range of cutters offers unsurpassed cutting capacity covering a wide range of wire dimensions and types.

## 1% CARBON/CHROME BALL BEARING GRADE STEEL

Material usually reserved for high stress applications provides incredible impact resistance and resiliency with smoother, cleaner penetration at the cutting edge.

## FORGED COMPONENTS

Grain structure follows profile of the blank to maximize tool strength.

## CNC GRINDING OF FORGED BLANKS

Computer controlled machine grinding guarantees edge angle accuracy and contact which increases tool reliability and consistency.

## 63-65 HRC ON CUTTING EDGES

Precision induction hardening of 1% Carbon/Chrome Ball Bearing Steel allows high Rockwell hardness without brittleness resulting in a longer lasting tool.

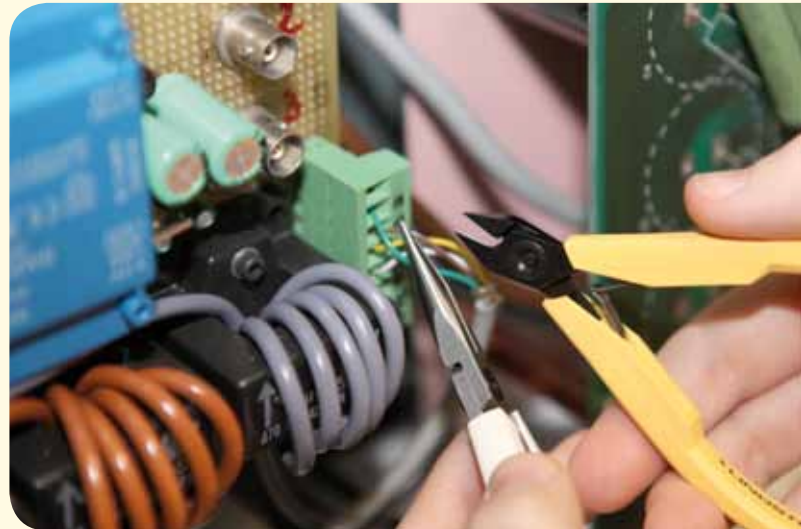

### ESD safety

All Lindström 80 Series pliers are ESD safe. Resins with conductive additives in the handles create a material that safely dissipates electrostatic charges, reducing possibility of damage to sensitive components.

**Warning! Lindström pliers are not 1000V insulated and therefore should never be used on electrified equipment.**

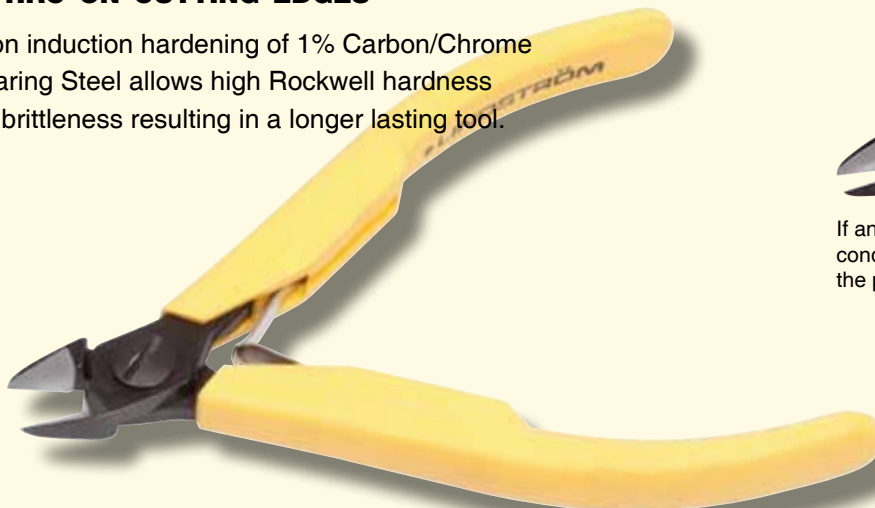

If an 80 Series cutter is desired with conductive handles, then add the suffix CO to the product code. Ex.: 8162 CO

# 80 Series Cutters

## 80 Series diagonal cutters oval head

### 8130-8162

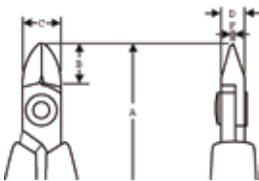

			A mm	B mm	C mm	D mm	F mm			
8130	0050918	10	108.0	8.0	8.0	5	0.8	0.2-1.0	Micro	43
8131	0050925	10	108.0	8.0	8.0	5	0.8	0.1-1.0	Flush	43
8131 CO	0051519	10	108.0	8.0	8.0	5	0.8	0.1-1.0	Flush	43
8132	0050932	10	108.0	8.0	8.0	5	0.8	0.1-0.8	Ultra	44
8140	0050949	10	110.0	10.0	10.0	6	0.8	0.2-1.25	Micro	46
8140 CO	0051533	10	110.0	10.0	10.0	6	0.8	0.2-1.25	Micro	46
8141	0050987	10	110.0	10.0	10.0	6	0.8	0.1-1.25	Flush	45
8141 CO	0051557	10	110.0	10.0	10.0	6	0.8	0.1-1.25	Flush	45
8142	0051007	10	110.0	10.0	10.0	6	0.8	0.1-1.0	Ultra	46
8142 CO	0051564	10	110.0	10.0	10.0	6	0.8	0.1-1.0	Ultra	46
8150	0051113	10	112.5	12.5	12.5	6	1.2	0.3-1.6	Micro	50
8150 CO	0051670	10	112.5	12.5	12.5	6	1.2	0.3-1.6	Micro	50
8150 J	0051137	10	112.5	12.5	12.5	6	1.2	Max 0.5	Micro	50
8151	0051199	10	112.5	12.5	12.5	6	1.2	0.2-1.6	Flush	49
8151 CO	0051694	10	112.5	12.5	12.5	6	1.2	0.2-1.6	Flush	49
8152	0052097	10	112.5	12.5	12.5	6	1.2	0.1-1.25	Ultra	49
8160	0051229	10	125.0	16.0	16.0	8	1.6	0.4-2.0	Micro	88
8160 CO	0051724	10	125.0	16.0	16.0	8	1.6	0.4-2.0	Micro	88
8160 J	0051250	10	125.0	16.0	16.0	8	1.6	Max 0.5	Micro	87
8161	0051328	10	125.0	16.0	16.0	8	1.6	0.3-2.0	Flush	88
8161 CO	0051748	10	125.0	16.0	16.0	8	1.6	0.3-2.0	Flush	88
8162	0051335	10	125.0	16.0	16.0	8	1.6	0.3-1.6	Ultra	88

## 80 Series diagonal cutters tapered head

### 8143-8165

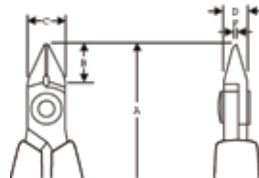

			A mm	B mm	C mm	D mm	F mm			
8143	0051021	10	110.0	10.0	10.0	6	0.8	0.2-1.25	Micro	46
8144	0051045	10	110.0	10.0	10.0	6	0.8	0.2-1.25	Flush	46
8144 CO	0051601	10	110.0	10.0	10.0	6	0.8	0.2-1.25	Flush	46
8145	0051052	10	110.0	10.0	10.0	6	0.8	0.1-1.0	Ultra	46
8153	0051205	10	112.5	12.5	12.5	6	1.2	0.3-1.6	Micro	49
8154	0052103	10	112.5	12.5	12.5	6	1.2	0.2-1.6	Flush	49
8154 CO	0052233	10	112.5	12.5	12.5	6	1.2	0.2-1.6	Flush	49
8155	0052110	10	112.5	12.5	12.5	6	1.2	0.2-1.25	Ultra	49
8163	0051342	10	125.0	16.0	16.0	8	1.6	0.4-2.0	Micro	88
8163 CO	0051762	10	125.0	16.0	16.0	8	1.6	0.4-2.0	Micro	88
8164	0052141	10	125.0	16.0	16.0	8	1.6	0.3-2.0	Flush	88
8165	0052158	10	125.0	16.0	16.0	8	1.6	0.3-1.6	Ultra	88
8165 CO	0052288	10	125.0	16.0	16.0	8	1.6	0.3-1.6	Ultra	88

## 80 Series diagonal cutters tapered and relieved head

### 8146-8158

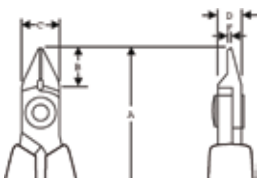

			A mm	B mm	C mm	D mm	F mm			
8146	0051076	10	110.0	10.0	10.0	6	0.8	0.2-1.0	Micro	46
8147	0051083	10	110.0	10.0	10.0	6	0.8	0.1-1.0	Flush	46
8148	0051090	10	110.0	10.0	10.0	6	0.8	0.1-0.8	Ultra	45
8148 CO	0051656	10	110.0	10.0	10.0	6	0.8	0.1-0.8	Ultra	45
8156	0051212	10	112.5	12.5	12.5	6	1.0	0.3-1.25	Micro	49
8157	0052127	10	112.5	12.5	12.5	6	1.0	0.2-1.25	Flush	49
8158	0052134	10	112.5	12.5	12.5	6	1.0	0.2-1.0	Ultra	49

# 80 Series Cutters

## 80 Series tip cutter

8149



	 731415		A mm	B mm	C mm	D mm	E mm	G mm	H mm	 mm		 g
8149	0051106	10	114	14	5	6	5	5	3.2	0.1-0.6	Flush	48

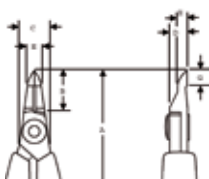

## 80 Series angled cutters 20° short head

8211



	 731415		A mm	B mm	C mm	D mm	G mm	 mm		 g
8211	0101030	1	110	9.5	10	6	4.1	0.2-1.2	Flush	43

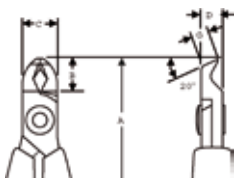

## 80 Series angled cutters 45° long tapered head

8247



	 731415		A mm	B mm	C mm	D mm	G mm	 mm		 g
8247	0051397	1	117.5	18	10	6	6.7	0.2-1.0	Flush	51
8247 CO	0051809	1	117.5	18	10	6	6.7	0.2-1.0	Flush	51

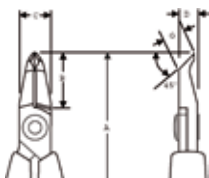

# 80 Series Cutters

## 8248

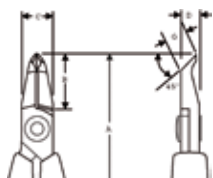

	 731415		A mm	B mm	C mm	D mm	G mm	 mm		 g
8248	0051427	1	117.5	18	10	6	6.7	0.2-0.8	Flush	51
8248 CO	0051823	1	117.5	18	10	6	6.7	0.2-0.8	Flush	51

## 80 Series lead catchers

### 813 - 814



	 731415			 g
813	0055852	1	8130-8132, RX 8130-8132	4
814	0055845	1	8140-8148, RX 8140-8148	4



# Supreme Series

## LINDSTRÖM SUPREME: GOOD PERFORMANCE FOR THE TRADITIONAL USER

Good performing cutters and pliers for general electronics work, repair and fine mechanical work.

All the cutters and pliers in the Supreme Series have an exclusive nut and screw joint. Thanks to the specially designed flush head nut, Lindström's nut and screw joint strikes the perfect balance between the long term performance of the traditional screw joint and perfect tip alignment of the box joint.



### ESD safety

All Lindström Supreme Series pliers are ESD safe. Resins with conductive additives in the handles create a material that safely dissipates electrostatic charges, reducing possibility of damage to sensitive components.

**Warning! Lindström pliers are not 1000V insulated and therefore should never be used on electrified equipment.**



If an Supreme series cutter is desired with conductive handles, then add the suffix CO to the product code. Ex.: 7190 CO





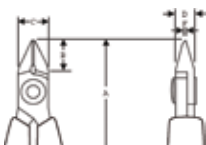

# Supreme Cutters and Pliers

## Supreme Series diagonal cutters tapered head

### 7190, 7191





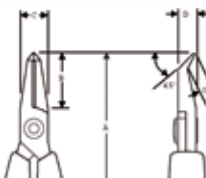

			A mm	B mm	C mm	D mm	F mm			
7190	0052479	10	109	9	9	6	1	0.2-1.0	Micro	50
7190 CO	0052790	1	109	9	9	6	1	0.2-1.0	Micro	50
7191	0052509	1	109	9	9	6	1	0.1-1.0	Flush	50
7191 CO	0052806	1	109	9	9	6	1	0.1-1.0	Flush	50

## Supreme Series Oblique cutters reverse angle

### 7280





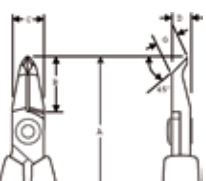

			A mm	B mm	C mm	D mm	G mm			
7280	0052523	1	118	18	9	6	3.5	0.2-08	Flush	54

## Supreme Series angle cutters

### 7285



			A mm	B mm	C mm	D mm	G mm			
7285	0052530	1	120	20	9	6	6.7	0.2-1.0	Flush	56

# Supreme Cutters and Pliers

## 7290,7291



	 731415		A mm	B mm	C mm	G mm	 mm		 g
7290	0052547	1	108	8	10.5	15	0.35-1.25	Micro	56
7291	0052554	1	108	8	10.5	15	0.35-1.25	Flush	56

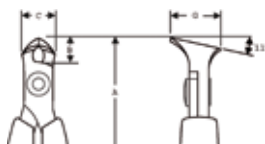

## 7293



	 731415		A mm	B mm	C mm	G mm	 mm		 g
7293	0052592	10	108	8	10.5	8	0.35-1.0	Flush	56

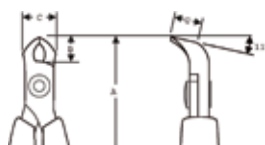

## End cutters

## 7292



	 731415		A mm	B mm	C mm	D mm	E mm	F mm	 mm		 g
7292	0052578	1	115	15	9	6	3.2	4	0.35-0.8	Flush	54

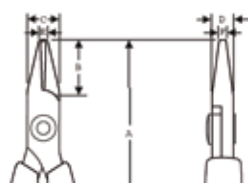

# Supreme Cutters and Pliers

## Supreme Series holding pliers flat nose plier

7490

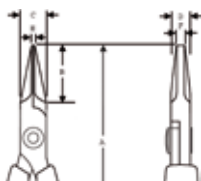



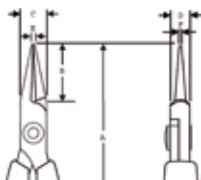

	 731415		A mm	B mm	C mm	D mm	E mm	F mm	 g
7490	0052646	1	120	20	9	6	1.2	3.2	53
7490 CO	0052875	1	120	20	9	6	1.2	3.2	53

## Supreme Series round nose pliers

7590





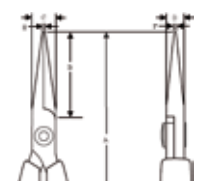

	 731415		A mm	B mm	C mm	D mm	E mm	F mm	 g
7590	0052660	1	120	20	9	6	1.8	0.9	54
7590 CO	0052882	1	120	20	9	6	1.8	0.9	54

## Supreme Series snipe nose pliers

7890, 7891



	 731415		A mm	B mm	C mm	D mm	E mm	F mm	 g
7890	0052691	1	132	32	9	6	1.2	0.8	60
7890 CO	0052899	1	132	32	9	6	1.2	0.8	60
7891	0052714	1	132	32	9	6	1.2	0.8	59
7891 CO	0052905	1	132	32	9	6	1.2	0.8	59

# Supreme Cutters and Pliers

## Supreme Series snipe nose pliers, with bent tip

7892

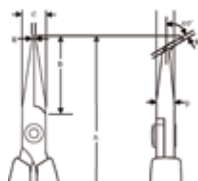

	 731415		A mm	B mm	C mm	D mm	E mm	F mm	 g
7892	0052738	1	129	29	9	6	1.2	0.8	59

## Supreme Series short snipe nose pliers

7893

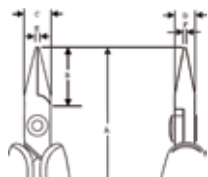

	 731415		A mm	B mm	C mm	D mm	E mm	F mm	 g
7893	0052769	1	120	20	9	6	1.2	0.8	56

# Kevlar Cutter

## Supreme Series short snipe nose pliers

HS6000

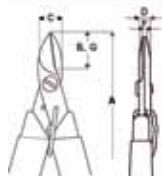

	 731415		A mm	B mm	C mm	D mm	E mm	F mm	 g
HS6000	0113781	1	145.0	29.0	12.7	6.4	2.2	2.0	88

# Tweezers

## LINDSTRÖM TWEEZERS: THE ULTIMATE IN PERFORMANCE AND PRECISION

Lindström tweezers offer perfect balance, tip alignment, and symmetry as well as a wide range of materials to meet your most sophisticated and demanding requirements. In addition to general assembly, our product line includes models specifically designed for surface mounted devices, ESD-sensitive areas, and medical and laboratory applications as well.

**When choosing tweezers, special attention should be given to the following four criteria.**

1. How are the tweezers' tips finished?
2. How symmetrical are the two sides?
3. How delicate do they feel?
4. How easily do they handle small parts?



## MATERIALS

Tweezers can be made from different materials depending on the function it carries out:

- **C:** Carbon Steel was the first material used for watch-making tweezers. The heat treatment provides long life tips (max hardness 57 HRC), but are highly magnetic and have low rust resistance. Not to be used in high temperatures.
- **S:** Magnetizable stainless steel contains slightly higher carbon content than SA which produces a harder tip but could rust under extreme conditions. Not recommended for high temperatures.
- **SA:** Non-magnetic stainless steel which provides excellent resistance to many acids because of the high concentration of molybdenum. "SA" material is our most popular material sold. Suitable for continuous high temperature use.
- **TA:** Titanium is highly resistant to corrosion from nitric acid, chloride, salt water and many other mineral and organic acids. Titanium is 40% lighter than stainless steel. Fully non-magnetic and temperature resistant.

	Hardness	Rust resistance	Magnetism	Others
<b>C:</b> Carbon Steel	High	Low	High	Mechanical application
<b>S:</b> Stainless Steel	High	Low	High	Mechanical application
<b>SA:</b> Special Stainless Steel	Medium	High	Very Low	Very good acid resistance
<b>TA:</b> Titanium	High	Very high	100% anti-magnetic	Great acid resistance

## PRECISION TWEEZERS FOR SUCCESSFUL APPLICATIONS

### ■ HIGH PRECISION TWEEZERS

High precision tweezers are handcrafted to perfect tip symmetry and balance. They have polished edges and are superior non-scratch/antiglare satin finish tweezers. The high precision tweezers are primarily suitable for delicate standard applications and precision work.

### ■ HIGH PRECISION REVERSE ACTION TWEEZERS

These are tweezers especially intended for applications where a high precise self-closing action is required (e.g. microscopy). They permit holding parts without finger pressure.

### ■ BOLEY TWEEZERS

Popular tweezers for general purpose applications.

### ■ GENERAL PURPOSE TWEEZERS

Serrated tip and handles for a secure grip.

## SPECIAL DESIGN TWEEZERS

### ■ COMPONENTS POSITIONING TWEEZERS

Specifically designed tips hold delicate electronic components firmly and safely. These tweezers can handle many types of round components and electronic devices such as resistors and diodes.

### ■ SMD TWEEZERS (SURFACE MOUNT DEVICE)

These tweezers are meant for quick and easy handling and positioning of any type of SMD components. Paddle tip design, different tips and angles, for placing components. Blunted edges prevent damage to printed circuit boards.

## ESD PLASTIC TIPS OR ESD HANDLES TWEEZERS FOR EPA (ELECTROSTATIC-PROTECTED AREA) AND ANTI-SCRATCH APPLICATIONS

### ■ ESD SAFE EASYTOUCH TWEEZERS



Ergonomically shaped soft easy rubber grips reduce the risk of injuries to the hand and early hand fatigue when using tweezers for long periods of time. Soft cushion grip ensure higher user comfort and increased tactile precision. Static dissipative material provides ESD protection. ESD safe packaging protects tweezers on workbench and in tool cases.

### ■ PLASTIC REPLACEABLE TIP TWEEZERS

ESD carbon fibre tips does not leave metal marks and grant a free contamination performance. They also have a very easy and precise tips replacement system.

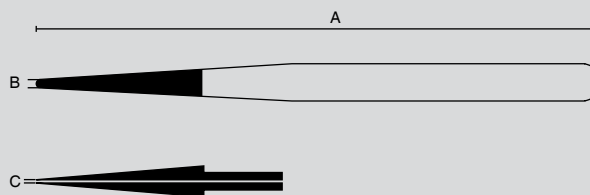

#number	Dimensions	Replaceable tip set
TL259CFR-SA	A 5" 130mm - B 0.025" 0.6mm - C0.04" 1.0mm	TL 259 ACF
TL249CFR-SA	A 5" 130mm - B 0.09" 2.2mm - C0.09" 2.2mm	TL 249 ACF
TL7CFR-SA	A 5" 130mm - B 0.025" 0.6mm - C0.025" 0.6mm	TL 7 ACF
TL2ACFR-SA	A 5" 130mm - B 0.07" 1.8mm - C0.04" 1.0mm	TL 2A ACF
TL5CFR-SA	A 5" 130mm - B 0.02" 0.5mm - C0.025" 0.6mm	TL 5 ACF
TL00CFR-SA	A 5" 130mm - B 0.04" 1.0mm - C0.08" 2.0mm	TL 00 ACF

Replaceable kits come with 2 tips and screws

### ■ PLASTIC TIP – SOFT TIP TWEEZERS

General precision carbon fibre tips tweezers permit handling without metal contact. They do not leave metal marks and are free from metal contamination providing safe handling of delicate parts.

# Tweezers

## Soft touch tweezers, ESD-safe

### TL -ET

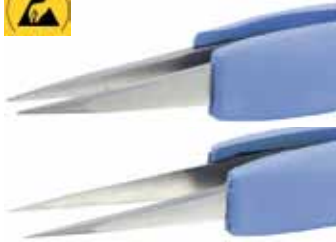

- High quality, precision tweezers with comfortable, soft and “tactile” grips
- Material: Static dissipative material provides reliable ESD protection. Anti-acid, antimagnetic stainless steel for use in many electronic environments
- Flat edges, strong tips
- ESD-safe packaging protects tweezers on workbench and in tool cases

	 731151			 L mm	 g
TL 00-SA-ET	8279219	1	00	120	28
TL 3-SA-ET	8279356	1	3	120	19

## High precision tweezers

### TL 00B-SA



- Flat edges, strong tips. Serrated grips
- Material: stainless steel, anti-magnetic, anti-acid

	 731415			 L mm	 g
TL 00B-SA	0109555	1	00B-SA	120	21

### TL 00D-SA



- Flat edges, strong tips. Serrated tips and grips for secure handling
- Material: stainless steel, anti-magnetic, anti-acid

	 731415			 L mm	 g
TL 00D-SA	0109562	1	00D-SA	120	21

### TL 00-SA



- Flat edge and strong tips
- Material: stainless steel, anti-magnetic, anti-acid
- SL: competitive line

	 731415			 L mm	 g
TL 00-SA	0109579	1	00-SA	120	22
TL 00-SA-SL	0115228	5	00-SA	120	22

## TL 0C9-SA



- Flat edge and strong tips
- Material: stainless steel, anti-magnetic, anti-acid

	 731415			 L mm	 g
TL 0C9-SA	0109586	1	0C9-SA	90	7

## TL 0-SA



- Flat edge, fine tips
- Material: stainless steel, anti-magnetic, anti-acid

	 731415			 L mm	 g
TL 0-SA	0109593	1	0-SA	120	21

## TL 10G-SA



- Fine tips. Serrated tips and grips for secure handling
- Material: stainless steel, anti-magnetic, anti-acid

	 731415			 L mm	 g
TL 10G-SA	0109609	1	10G-SA	110	13

## TL 15AP



- Cutting tweezers with parallel cutting tips for soft copper, gold, silver or magnetic wire from 0.1 to 0.25mm
- Material: carbon steel wire

	 731415			 L mm	 g
TL 15AP	0109630	1	15 AP	115	27

## TL 1-SA



- Strong, accurate tips
- Material: stainless steel, anti-magnetic, anti-acid
- SL: competitive line

	 731415			 L mm	 g
TL 1-SA	0109647	1	1-SA	120	13
TL 1-SA-SL	0115235	5	1-SA	120	13



# Tweezers

## TL 2AB-SA



- Flat, curved, round tips
- Material: stainless steel, anti-magnetic, anti-acid

	 731415			 L mm	 g
TL 2AB-SA	0110094	1	2AB-SA	120	15

## TL 2A-SA



- Strong, round tips
- Material: stainless steel, anti-magnetic, anti-acid
- SL: competitive line

	 731415			 L mm	 g
TL 2A-SA	0110100	1	2A-SA	120	15
TL 2A-SA-SL	0115259	5	2A-SA	120	15

## TL 2-SA



- Strong, sharp tips
- Material: stainless steel, anti-magnetic, anti-acid
- SL: competitive line

	 731415			 L mm	 g
TL 2-SA	0110117	1	2-SA	120	15
TL 2-SA-SL	0115242	5	2-SA	120	15

## TL 3C-SA



- Very sharp tips
- Material: stainless steel, anti-magnetic, anti-acid
- SL: competitive line

	 731415			 L mm	 g
TL 3C-SA	0110148	1	3C-SA	110	7
TL 3C-SA-SL	0115273	5	3C-SA	110	7

## TL 3C-TA



- Very sharp tips
- Material: titanium, anti-magnetic, anti-acid, super light weight

	 731415			 L mm	 g
TL 3C-TA	0110155	1	3C-TA	110	7

## TL 3-SA



- Very sharp tips
- Material: stainless steel, anti-magnetic, anti-acid
- SL: competitive line

	 731415			 L mm	 g
TL 3-SA	0110162	1	3-SA	120	13
TL 3-SA-SL	0115266	5	3-SA	120	13

## TL 4-SA



- Tapered extra fine tips
- Material: stainless steel, anti-magnetic, anti-acid
- SL: competitive line

	 731415			 L mm	 g
TL 4-SA	0110186	1	4-SA	110	13
TL 4-SA-SL	0115280	5	4-SA	110	13

## TL 51S-SA



- Extra fine, double bent tips
- Material: stainless steel, anti-magnetic, anti-acid

	 731415			 L mm	 g
TL 51S-SA	0110209	1	51S-SA	115	13

## TL 5A-SA



- Extra fine tips, lightly curved
- Material: stainless steel, anti-magnetic, anti-acid
- SL: competitive line

	 731415			 L mm	 g
TL 5A-SA	0110216	1	5A-SA	115	13
TL 5A-SA-SL	0115303	5	5A-SA	115	13

## TL 5B-SA



- Extra fine bent tips
- Material: stainless steel, anti-magnetic, anti-acid

	 731415			 L mm	 g
TL 5B-SA	0110223	1	5B-SA	110	13

# Tweezers

## TL 5-SA



- Tapered extra fine tips
- Material: stainless steel, anti-magnetic, anti-acid
- SL: competitive line

	 731415			 L mm	 g
TL 5-SA	0110247	1	5-SA	110	12
TL 5-SA-SL	0115297	5	5-SA	110	12

## TL 5-TA



- Tapered extra fine tips
- Material: titanium, anti-magnetic, anti-acid, super light weight

	 731415			 L mm	 g
TL 5-TA	0110254	1	5-TA	110	7

## TL 65A-SA



- Long, fine curved tips
- Material: stainless steel, anti-magnetic, anti-acid

	 731415			 L mm	 g
TL 65A-SA	0110278	1	65A-SA	140	12

## TL 7A-SA



- Strong, fine, curved tips
- Material: stainless steel, anti-magnetic, anti-acid
- SL: competitive line

	 731415			 L mm	 g
TL 7A-SA	0110285	1	7A-SA	115	14
TL 7A-SA-SL	0115327	5	7A-SA	115	14

## TL 7-SA



- Fine, curved tips
- Material: stainless steel, anti-magnetic, anti-acid
- SL: competitive line

	 731415			 L mm	 g
TL 7-SA	0110292	1	7-SA	115	13
TL 7-SA-SL	0115310	5	7-SA	115	13

# Tweezers

## TL AC-SA



- Strong tips and serrated grips
- Material: stainless steel, anti-magnetic, anti-acid

	 731415			 L mm	 g
TL AC-SA-SL	0115341	5	AC-SA	110	18

## TL SS-SA



- Long, slender and fine tips
- Material: stainless steel, anti-magnetic, anti-acid
- SL: competitive line

	 731415			 L mm	 g
TL SS-SA	0109937	1	SS-SA	140	12
TL SS-SA-SL	0115358	5	SS-SA	140	12

## General purpose tweezers

### TL 124-SA



- Strong, double-bent tips. Serrated grips and tips
- Material: stainless steel, anti-magnetic, anti-acid

	 731415			 L mm	 g
TL 124-SA	0110018	1	124-SA	150	20

### TL 2AX-SA



- Reverse action tweezers, 2A style
- Material: stainless steel, anti-magnetic, anti-acid

	 731415			 L mm	 g
TL 2AX-SA	0110025	1	2AX-SA	120	15

## Strong precision tip tweezers

### TL 475-SA



- Strong blunt tips. Serrated grips and tips
- Material: stainless steel, anti-magnetic, anti-acid

	 731415			 L mm	 g
TL 475-SA	0110032	1	475-SA	140	25

# Tweezers

## TL 648-SA



- Strong and fine tips. Alignment pin. Serrated grips and tips
- Material: stainless steel, anti-magnetic, anti-acid

	 731415			 L mm	 g
TL 648-SA	0110049	1	648-SA	150	25

## TL 649-SA

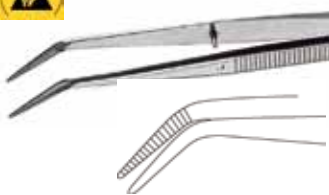

- Strong, fine and bent tips. Alignment pin. Serrated and bent tips
- Material: stainless steel, anti-magnetic, anti-acid

	 731415			 L mm	 g
TL 649-SA	0110063	1	649-SA	150	25

## TL 231-SA



- Strong serrated precision tips
- Material: stainless steel, anti-magnetic, anti-acid

	 731415			 L mm	 g
TL 231-SA	0110087	1	231-SA	120	14

## Precision component handling tweezers

### TL 577-SA

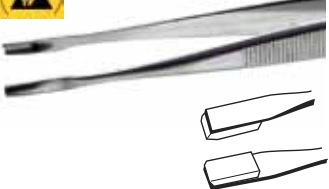

- Tweezers with straight tips, Ø 4 mm, for components Ø2,0 mm with serrated grips
- Material: stainless steel, anti-magnetic, anti-acid

	 731415			 L mm	 g
TL 577-SA	0110421	1	577-SA	115	13

### TL 578-SA

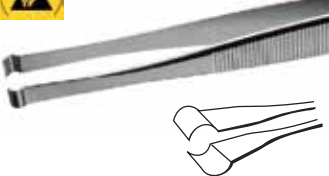

- Tweezers with angled tips 90°, Ø 6 mm, for components Ø 2,0 mm with serrated grips
- Material: Stainless steel, anti-magnetic, anti-acid

	 731415			 L mm	 g
TL 578-SA	0110438	1	578-SA	115	15

### TL 582-SA

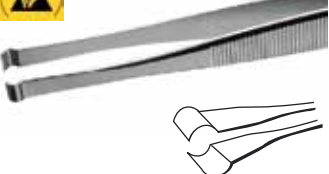

- Tweezers with angled tips 90°, Ø 4 mm, for components Ø 1,0 mm with serrated grips
- Material: Stainless steel, anti-magnetic, anti-acid

	 731415			 L mm	 g
TL 582-SA	0110452	1	582-SA	115	15

## Boley style tweezers

### TL AA-S



- Strong and fine tips
- Material: stainless steel, magnetic, robust tips

	 731415			 mm	 g
TL AA-S	0110544	1	AA-S	130	16

### TL AA-SA



- Strong and fine tips
- Material: stainless steel, anti-magnetic, anti-acid
- SL: competitive line

	 731415			 mm	 g
TL AA-SA	0110551	1	AA	130	17
TL AA-SA-SL	0115334	5	AA	130	17

### TL AA-TA



- Strong and fine tips
- Material: titanium, anti-magnetic, anti-acid, super light weight

	 731415			 mm	 g
TL AA-TA	0110575	1	AA-TA	130	10

### TL MM-SA



- Strong tips
- Material: stainless steel, anti-magnetic, anti-acid
- For industrial application

	 731415			 mm	 g
TL MM-SA-SL	0115365	5	MM-SA	130	15

## Tweezers with fibre tips

### TL 251-SA



- Tweezer with special tip
- Material: stainless steel body and carbon fibre tips
- Tips are 10 mm

	 731415			 mm	 g
TL 251-SA	0110643	1	251-SA	110	17

## TL 252-SA



- Tweezer with special tip
- Material: stainless steel body and carbon fibre tips
- Tips are 6 mm

	 731415			 L mm	 g
TL 252-SA	0110650	1	252-SA	110	17

## TL 253-SA



- Tweezer with special tip
- Material: stainless steel body and carbon fibre tips
- Tips are 2,5 mm

	 731415			 L mm	 g
TL 253-SA	0110667	1	253-SA	110	17

## TL 269CF-SA



- Tweezer with special tip
- Material: stainless steel body and carbon fibre tips
- Tips are 3 mm, 2A style

	 731415			 L mm	 g
TL 269CF-SA	0110735	1	269 CF-SA	130	16

### Tweezers with replaceable carbon fibre tips

## TL 249CFR-SA



- Tweezer with special tip
- Material: stainless steel body and carbon fibre tips
- Tips have flat edge and thick tips

	 731415			 L mm	 g
TL 249CFR-SA	0115143	1	249 CFR-SA	130	17

## TL 259CFR-SA



- Tweezer with special extra fine tips
- Material: stainless steel body and carbon fibre tips

	 731415			 L mm	 g
TL 259 CFR-SA	0115150	1	259CFR-SA	130	19

## TL 00CFR-SA



- Tweezer with flat edge and thick tips
- Material: stainless steel body and carbon fibre tips

	 731415			 L mm	 g
TL 00CFR-SA	0115402	1	00CFR-SA	130	19

## TL 2ACFR-SA



- Tweezer with special flat round tips
- Material: stainless steel body and carbon fibre tips

	 731415			 L mm	 g
TL 2ACFR-SA	0115419	1	2A CFR-SA	130	19

## TL 5CFR-SA



- Tweezer with special extra fine tips
- Material: stainless steel body and carbon fibre tips

	 731415			 L mm	 g
TL 5CFR-SA	0115426	1	5 CFR-SA	130	19

## TL 7CFR-SA



- Tweezer with fine curved special tips
- Material: stainless steel body and carbon fibre tips

	 731415			 L mm	 g
TL 7CFR-SA	0115433	1	7 CFR-SA	130	19

## Replacement tips

### TL 249ACF



- Flat edge and thick tips
- Includes 2 tips and 2 screws in a plastic bag

	 731415			 L mm	 g
TL 249 ACF	0115174	1	249 ACF	40	2



# Tweezers

## TL 259ACF



- Extra fine tips
- Includes 2 tips and 2 screws in a plastic bag

	 731415			 L mm	 g
TL 259 ACF	0115167	1	259 ACF	40	2

## TL 2AACF



- Replacement tips
- Includes 2 tips and 2 screws in a plastic bag

	 731415			 L mm	 g
TL 2A ACF	0115457	1	2A ACF	40	2

## TL 5ACF



- Replacement tips
- Includes 2 tips and 2 screws in a plastic bag

	 731415			 L mm	 g
TL 5ACF	0115464	1	5 ACF	40	2

## TL 7ACF



- Fine curved tips
- Includes 2 tips and 2 screws.

	 731415			 L mm	 g
TL 7ACF	0115471	1	7 ACF	130	19

## SMD tweezers

### TL SM103-SA



- High precision tweezers for handling and positioning 2 and 3 lead SOT packages at 45° angle
- Material: stainless steel, anti-magnetic, anti-acid

	 731415			 L mm	 g
TL SM 103-SA	0110773	1	SM 103-SA	115	15

### TL SM104-SA



- High precision tweezers for handling and positioning 3 lead SOT packages, monolithic chip capacitors, etc.
- Material: stainless steel, anti-magnetic, anti-acid

	 731415			 L mm	 g
TL SM 104-SA	0110780	1	SM 104-SA	120	15

## TL SM105-SA



- High precision tweezers for placing SOT packages vertically

	 731415			 L mm	 g
TL SM 105-SA	0110797	1	SM 105-SA	120	15

## TL SM107-SA



- High precision tweezers for positioning all flat devices at 60° angle
- Material: stainless steel

	 731415			 L mm	 g
TL SM 107-SA	0110810	1	SM 107-SA	120	15

## TL SM108-SA



- High precision tweezers for positioning and soldering 1 mm wide components. Tips are grooved inside
- Material: stainless steel, anti-magnetic, anti-acid
- Tips grooved inside

	 731415			 L mm	 g
TL SM 108-SA	0110827	1	SM 108-SA	120	15

## TL SM109-SA



- High precision tweezers for positioning and soldering 1 mm wide components. Tips are grooved inside
- Material: stainless steel, anti-magnetic, anti-acid
- Tips 45° angle and grooved inside

	 731415			 L mm	 g
TL SM 109-SA	0110834	1	SM 109-SA	120	15

## TL SM110-SA



- High precision tweezers with grooved tips for positioning monolithic chip capacitors
- Material: stainless steel, anti-magnetic, anti-acid

	 731415			 L mm	 g
TL SM 110-SA	0110841	1	SM 110-SA	120	15

## TL SM111-SA



- High precision tweezers for positioning 5 mm monolithic chip capacitors with flat base
- Material: stainless steel, anti-magnetic, anti-acid
- Grooved tips 2 mm long

	 731415			 L mm	 g
TL SM 111-SA	0110858	1	SM 111-SA	120	15

# Tweezers

## TL SM115-SA



- Tweezers with grooved tips at 30° angle for holding and positioning cylindrical devices up to Ø 1 mm
- Material: stainless steel body and carbon fibre tips

	 731415			 L mm	 g
TL SM 115-SA	0110896	1	SM 115-SA	120	15

## TL SM117-SA



- High precision tweezers for positioning SOT packages at 30° angle
- Material: stainless steel, anti-magnetic, anti-acid

	 731415			 L mm	 g
TL SM 117-SA	0110919	1	SM 117-SA	120	15

## Tweezer sets

### 9854



- SMD tweezers set, 7 pcs
- 9854W: empty wallet

	 731415		 mm		 g
9854	0111831	1	180x200x20	TL 5C-SA, TL 5-SA-SL, TL SM 101-SA, TL SM 102-SA, TL SM 107-SA, TL SM 108-SA, TL SM 115-SA	140
9854W	0112760	1	180x200x20		

TL 5C-SA  
115 mm



TL SM 107-SA  
120 mm



TL 5-SA-SL  
110 mm



TL SM 108-SA  
120 mm



TL SM 101-SA  
115 mm



TL SM 115-SA  
120 mm



TL SM 102-SA  
115 mm



### 9855



- High precision tweezer set, 5 pcs
- 9855W: empty wallet

	 731415		 mm		 g
9855	0111848	1	110x200x10	TL SS-SA-SL, TL AA-SA-SL, TL 2A-SA-SL, TL 4A-SA-SL, TL 7A-SA-SL	115
9855W	0112777	1	110x200x10		

TL SS-SA-SL  
140 mm



TL 4-SA-SL  
110 mm



TL AA-SA-SL  
130 mm



TL 7A-SA-SL  
115 mm



TL 2A-SA-SL  
120 mm



# Tweezers

## 9856



- Titanium tweezer set, 4 pcs

	 731415		 mm		 g
9856	0111855	1	110x200x10	TL 3C-SA, TL 3-TA, TL 5-TA, TL AA-TA	75

TL 3C-TA  
110 mm



TL 5-TA  
110 mm



TL 3-TA  
120 mm



TL AA-TA  
130 mm



## 9857



- High precision tweezer set, 5 pcs
- 9855W: empty wallet

	 731415		 mm		 g
9857	0114283	1	110x200x10	TL 00-SA-SL, TL 1-SA-SL, TL 3C-SA-SL, TL 5-SA-SL, TL 7-SA-SL	115
9855W	0112777	1	110x200x10		

TL 00-SA-SL  
120 mm



TL 5-SA-SL  
110 mm



TL 1-SA-SL  
120 mm



TL 7-SA-SL  
115 mm



TL 3C-SA-SL  
110 mm



## 9858



- Fine tip tweezer set, 2 pcs
- 9858W: empty wallet

	 731415		 mm		 g
9858	0111862	1	65x200x8	TL AA-SA-SL, TL SS-SA-SL	60
9858W	0112784	1	65x200x8		

TL AA-SA-SL  
130 mm



TL SS-SA-SL  
140 mm



## 9859



- Strong tip tweezer set, 2 pcs

	 731415		 mm		 g
9859	0113057	1	65x200x8	TL 00B-SA, TL 2A-SA	75

TL 00B-SA  
120 mm



TL 2A-SA-SL  
120 mm



# Torque screwdrivers

## HIGH PRECISION TORQUE CONTROL

With a unique high-precision cam-over torque-limiting design, Lindström's torque screwdrivers eliminate over-application of force reducing the risk of damage and rework costs. Available in micro-adjustable or preset torque versions, Lindström's torque screwdrivers offer comfort with a user-friendly shape and non-slip grip. Built to last and with a non-magnetic bit holder that accepts any standard drive, it is the ideal choice for flexible applications as well as volume production. All models are ESD-safe.

## MICRO-ADJUSTABLE TORQUE SCREWDRIVERS

The micro-adjustable torque screwdriver allows instant change to the torque value with an easy-to-read window scale and a precise pull-to-set, push-to-lock mechanism. Adjustment is easy - just pull the knob, turn to the desired torque, push the knob back in, and it is ready to use.

The micro-adjustable screwdriver series includes three models ranging from 10 to 450 Ncm or 20 in.oz. to 40 in.lbs. Accuracy +/- 6%.

## PRESET TORQUE SCREWDRIVERS

With the same ruggedness, comfort and precision of the micro-adjustable version, the preset torque screwdriver is an excellent choice for volume manufacturing applications.

The desired torque value is easily set using an internal adjustment screw accessible by removing the end cap of the handle. The preset torque driver is available with a torque of 70-100 Ncm or 100 in.oz. Accuracy +/- 6%.



### MA500-1 - MA500-3



	731415				A mm	B mm	C mm	D mm	g
MA500-1	0112395	1	1/4	10-80 cNm	138	18.2	28	9.6	195
MA500-2	0112401	1	1/4	40-200 cNm	157	18.2	28	9.6	260
MA500-3	0112418	1	1/4	50-450 cNm	171	18.2	32	9.6	306

### PS501-2



	731415				A mm	B mm	C mm	D mm	g
PS501-2	0112432	1	1/4	7-70 cNm	141	18.2	28	9.6	187

# Alphanumeric Index

	PAGE		PAGE		PAGE
813	30	8155	28	8154 CO	28
814	30	8156	28	8160 CO	28
7190	32	8157	28	8160 J	28
7191	32	8158	28	8161 CO	28
7280	32	8160	28	8163 CO	28
7285	32	8161	28	8165 CO	28
7290	33	8162	28	8247CO	29
7291	33	8163	28	8248 CO	30
7292	33	8164	28	9854W	50
7293	33	8165	28	9855W	50
7490	34	8211	29	9855W	51
7590	34	8247	29	9858W	51
7890	34	8248	30	HS6000	35
7891	34	9854	50	MA500-1	52
7892	35	9855	50	MA500-2	52
7893	35	9856	51	MA500-3	52
8130	28	9857	51	P6160	26
8131	28	9858	51	PS501-2	52
8132	28	9859	51	RX 01	26
8140	28	7190 CO	32	RX 7490	24
8141	28	7191 CO	32	RX 7590	24
8142	28	7490 CO	34	RX 7890	25
8143	28	7590 CO	34	RX 7891	25
8144	28	7890 CO	34	RX 7892	25
8145	28	7891 CO	34	RX 7893	25
8146	28	8131 CO	28	RX 8130	21
8147	28	8140 CO	28	RX 8131	21
8148	28	8141 CO	28	RX 8132	21
8149	29	8142 CO	28	RX 8140	21
8150	28	8144 CO	28	RX 8141	21
8151	28	8148 CO	28	RX 8142	21
8152	28	8150 CO	28	RX 8143	21
8153	28	8150 J	28	RX 8144	21
8154	28	8151 CO	28	RX 8145	21

# Alphanumeric Index

	PAGE		PAGE		PAGE
RX 8146	21	TL 253-SA	46	TL 649-SA	44
RX 8147	21	TL 259 ACF	48	TL 65A-SA	42
RX 8148	21	TL 259 CFR-SA	46	TL 7ACF	48
RX 8149	22	TL 269CF-SA	46	TL 7A-SA	42
RX 8150	21	TL 2A ACF	48	TL 7A-SA-SL	42
RX 8151	21	TL 2AB-SA	40	TL 7CFR-SA	47
RX 8152	21	TL 2ACFR-SA	47	TL 7-SA	42
RX 8160	21	TL 2A-SA	40	TL 7-SA-SL	42
RX 8161	21	TL 2A-SA-SL	40	TL AA-S	45
RX 8162	21	TL 2AX-SA	43	TL AA-SA	45
RX 8211	22	TL 2-SA	40	TL AA-SA-SL	45
RX 8247	22	TL 2-SA-SL	40	TL AA-TA	45
RX 8248	23	TL 3C-SA	40	TL AC-SA-SL	43
RX8233	23	TL 3C-SA-SL	40	TL MM-SA-SL	45
RX8234	23	TL 3C-TA	40	TL SM 103-SA	48
RX8237	24	TL 3-SA	41	TL SM 104-SA	48
TL 00B-SA	38	TL 3-SA-ET	38	TL SM 105-SA	49
TL 00CFR-SA	47	TL 3-SA-SL	41	TL SM 107-SA	49
TL 00D-SA	38	TL 475-SA	43	TL SM 108-SA	49
TL 00-SA	38	TL 4-SA	41	TL SM 109-SA	49
TL 00-SA-ET	38	TL 4-SA-SL	41	TL SM 110-SA	49
TL 00-SA-SL	38	TL 51S-SA	41	TL SM 111-SA	49
TL 0C9-SA	39	TL 577-SA	44	TL SM 115-SA	50
TL 0-SA	39	TL 578-SA	44	TL SM 117-SA	50
TL 10G-SA	39	TL 582-SA	44	TL SS-SA	43
TL 124-SA	43	TL 5ACF	48	TL SS-SA-SL	43
TL 15AP	39	TL 5A-SA	41	TRX 8180	26
TL 1-SA	39	TL 5A-SA-SL	41		
TL 1-SA-SL	39	TL 5B-SA	41		
TL 231-SA	44	TL 5CFR-SA	47		
TL 249 ACF	47	TL 5-SA	42		
TL 249CFR-SA	46	TL 5-SA-SL	42		
TL 251-SA	45	TL 5-TA	42		
TL 252-SA	46	TL 648-SA	44		

# Conversion tables

## DECIMALS TO MILLIMETERS

inches	decimals	mm
1/64	0.015625	0.397
2/64	0.046875	1.191
3/64	0.078125	1.984
4/64	0.109375	2.778
5/64	0.140625	3.572
6/64	0.171875	4.366
13/64	0.203125	5.159
15/64	0.234375	5.953
17/64	0.265625	6.747
19/64	0.296875	7.541
21/64	0.328125	8.334
23/64	0.359375	9.128
25/64	0.390625	9.922
27/64	0.421875	10.716
29/64	0.453125	11.509
31/64	0.484375	12.303
33/64	0.515625	13.097
35/64	0.546875	13.891
37/64	0.578125	14.684
39/64	0.609375	15.478
41/64	0.640625	16.272
43/64	0.671875	17.066
45/64	0.703125	17.859
47/64	0.734375	18.653
49/64	0.765625	19.447
51/64	0.796875	20.241
53/64	0.828125	21.034
55/64	0.859375	21.828
57/64	0.890625	22.622
59/64	0.921875	23.416
61/64	0.953125	24.209
63/64	0.984375	25.003

1 mm = .03937 inch.  
.001 inch = .0254 mm.

## MILLIMETERS TO DECIMALS

inches	mm	inches	mm	inches	mm
0.1	0.0039	33	12.992	74	29.134
0.2	0.0079	34	13.386	75	29.528
0.3	0.0118	35	13.780	76	29.921
0.4	0.0157	36	14.173	77	30.315
0.5	0.0197	37	14.567	78	30.709
0.6	0.0236	38	14.961	79	31.102
0.7	0.0276	39	15.354	80	31.496
0.8	0.0315	40	15.748	81	31.890
0.9	0.0354	41	16.142	82	32.283
1	0.0394	42	16.535	83	32.677
2	0.0787	43	16.929	84	33.071
3	0.1181	44	17.323	85	33.465
4	0.1575	45	17.717	86	33.858
5	0.1969	46	18.110	87	34.252
6	0.2362	47	18.504	88	34.646
7	0.2756	48	18.898	89	35.039
8	0.3150	49	19.291	90	35.433
9	0.3543	50	19.685	91	35.827
10	0.3937	51	20.079		
11	0.4331	52	20.472		
12	0.4724	53	20.866		
13	0.5118	54	21.260		
14	0.5512	55	21.654		
15	0.5906	56	22.047		
16	0.6299	57	22.441		
17	0.6693	58	22.835		
18	0.7087	59	23.228		
19	0.7480	60	23.622		
20	0.7874	61	24.016		
21	0.8268	62	24.409		
22	0.8661	63	24.803		
23	0.9055	64	25.197		
24	0.9449	65	25.591		
25	0.9843	66	25.984		
26	10.236	67	26.378		
27	10.630	68	26.772		
28	11.024	69	27.165		
29	11.417	70	27.559		
30	11.811	71	27.953		
31	12.205	72	28.346		
32	12.598	73	28.740		



## COMPARISON OF WIRE GAUGES DIAMETER OF WIRE IN INCHES

Gauge No.	Brown & Shap	Stub's or Birmingham	Imperial or Brit. Std.
0000	0.4600	0.454	0.400
000	0.4096	0.425	0.372
00	0.3648	0.380	0.348
0	0.3249	0.340	0.324
1	0.2893	0.300	0.300
2	0.2576	0.284	0.276
3	0.2294	0.259	0.252
4	0.2043	0.238	0.232
5	0.1819	0.220	0.212
6	0.1620	0.203	0.192
7	0.1443	0.180	0.176
8	0.1285	0.165	0.160
9	0.1144	0.148	0.144
10	0.1019	0.134	0.128
11	0.0907	0.120	0.116
12	0.0808	0.109	0.104
13	0.0720	0.095	0.092
14	0.0941	0.083	0.080
15	0.0571	0.072	0.072
16	0.0508	0.065	0.064
17	0.0453	0.058	0.056
18	0.0403	0.049	0.048
19	0.0359	0.042	0.040
20	0.0320	0.035	0.036
21	0.0285	0.032	0.032
22	0.0254	0.028	0.028
23	0.0226	0.025	0.024
24	0.0201	0.022	0.022
25	0.0179	0.020	0.020
26	0.0159	0.018	0.018
27	0.0142	0.016	0.0164
28	0.0126	0.014	0.0149
29	0.0113	0.013	0.0136
30	0.0100	0.012	0.0124
31	0.0089	0.010	0.0116
32	0.0080	0.009	0.0100
33	0.0071	0.008	0.0100
34	0.0063	0.007	0.0092
35	0.0056	0.005	0.0084
36	0.0050	0.004	0.0076
37	0.0045	-	0.0068
38	0.0040	-	0.0060
39	0.0035	-	0.0052
40	0.0031	-	0.0048

## WIRE DIAMETERS

AWG	dia of solid wire (inches)	dia of stranded wire (inches)	dia of solid wire (mm)	dia of stranded wire (mm)
3	0.128	0.145 - 0.149	3.251	3.68 - 3.78
10	0.102	0.116 - 0.119	2.590	2.45 - 3.02
12	0.81	0.091 - 0.093	2.057	2.31 - 2.36
14	0.64	0.072 - 0.074	1.625	1.82 - 1.88
16	0.051	0.058 - 0.060	1.295	1.47 - 1.52
18	0.040	0.047 - 0.049	1.016	1.19 - 1.24
20	0.032	0.038 - 0.040	0.813	0.965 - 1.02
22	0.025	0.029 - 0.030	0.635	0.736 - 0.762
24	0.020	0.024 - 0.025	0.508	0.609 - 0.635
26	0.016	0.019 - 0.020	0.406	0.482 - 0.508
28	0.013	0.016 - 0.017	0.330	0.406 - 0.432
30	0.010	0.012 - 0.013	0.254	0.305 - 0.330

## **WARRANTY**

- 1.** All hand tools in the catalogue are offered with a lifetime warranty; a warranty against material and manufacturing defects for the normal lifetime of the tool in question. "Lifetime" is defined as the period of time a tool can be expected to last under normal use and conditions.
- 2.** Defective product will be repaired, replaced or substituted. SNA Europe does not provide for the transportation cost for repaired, replaced or substituted product.
- 3.** Any product that has been incorrectly used and/or maintained or that is worn from improper use or that has suffered unauthorized modifications is not covered by this warranty.
- 4.** A warranty claim must be submitted within the warranty period. This requires the submission or shipment of the complete tool in question with verification of sale documentation, which must validate the purchase date and the product designation, to the retailer or distributor.
- 5.** Replacement or repair of the product will be carried out as quickly as possible. At the reception of the replaced or repaired product the customer is asked to validate conformity. Replacements and repairs provided under the warranty do not lengthen or renew the warranty period for the tool.

This catalogue comprises our current product assortment. Changes in the assortment as well as change of net shapes, forms, designs and designations are made continuously. No specific information will necessarily be issued to this effect. Illustrations and drawings have been reproduced to be as accurate as possible. For the purposes of a catalogue they may, however, differ from the products themselves, as may the technical specifications.

Indications of weight are to be understood as approximate net weights, and serve primarily to facilitate calculations of freight and postage charges.

This catalogue supersedes all previous specifications and assortment lists.

The intellectual property in this catalogue is the property of SNA Europe. Excerpts, reprints or copies of the contents may be made with our permission.

Ваш поставщик:  
**ООО "КОМПАНИЯ ОПТУЛС"**  
Москва, ул.Иловайская, д.3  
Тел.: +7 (495) 646-00-96  
sale@opttools.ru  
www.opttools.ru



Advanced tools for assembly, rework and repair



[www.lindstromtools.com](http://www.lindstromtools.com)