

Pro'sKit®

Professional Tool Solutions Since 1991



INNOVATION
QUALITY
SERVICE

VOL. 27



Pro'sKit® GLOBAL DISTRIBUTION CHANNEL

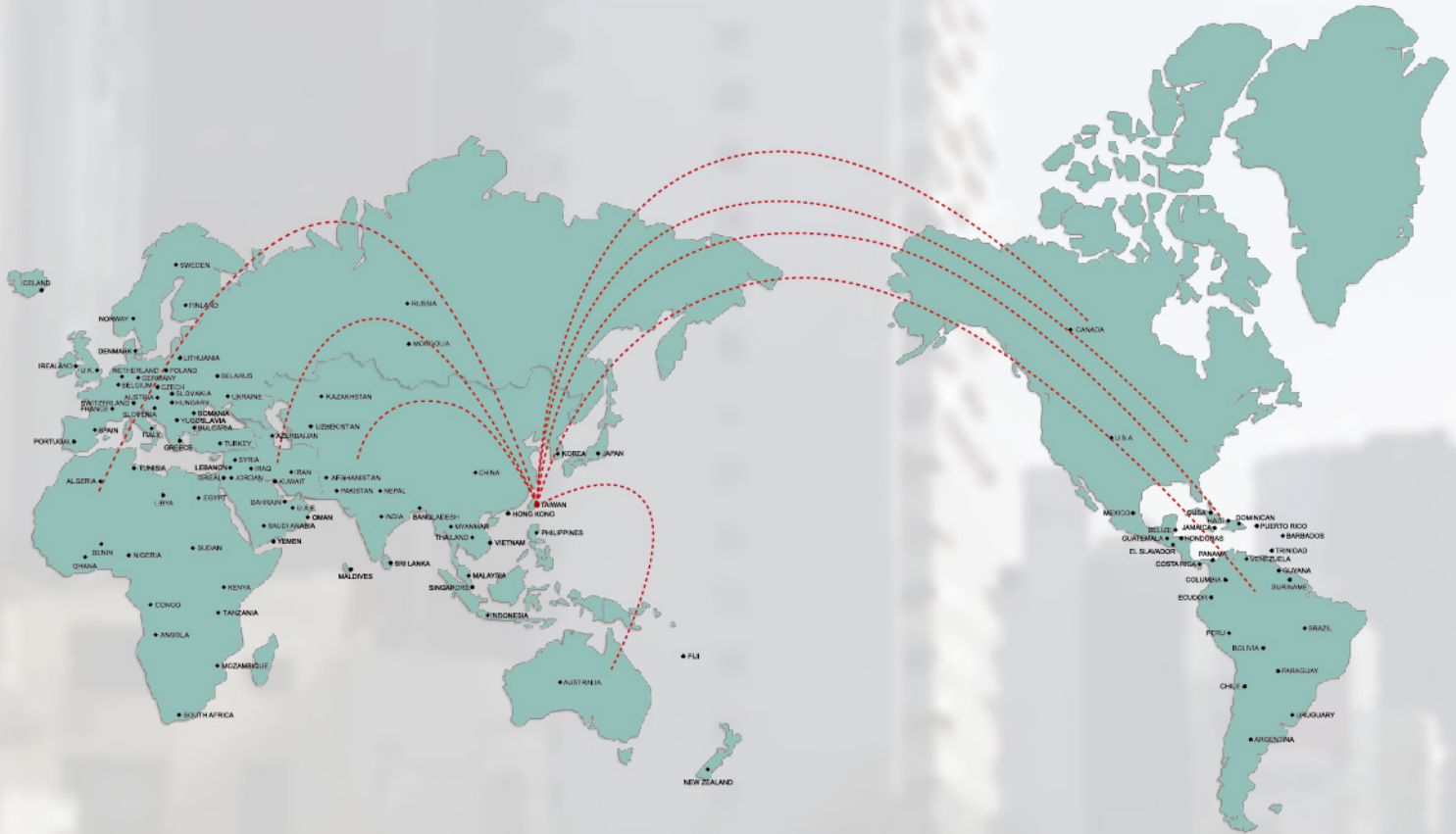



An Elite Brand Not just listen to customers, it solves problems

In the very beginning when **Pro'sKit**[®] was established with 10 sets of tool kits, **Pro'sKit**[®] noticed the market phenomenon—Tools purchasing is tiresome as there was no brand embraced a variety of tools at the time. Since then, **Pro'sKit**[®] decides to be a total solution provider - this is its purpose as well as pledge. More than 26 year has passed, **Pro'sKit**[®] always keeps the faith and makes it happen— **See the market, Listen to the customers, Provide solution, Achieve satisfaction.**

Efficiency – is the key to work smart. **Pro'sKit**[®] develops products with intelligent design for efficient work with satisfactory performance. **Smart SMD Rework Station Series** with intelligent IC provide operators with accurate temperature control, fast heat up and energy saving. **Fiber Optic Tool Series** with Fusion splicing machine, test instruments, and more provide reliable, cost-effective solution to FTTX field. **USB Charging/Powered Series** make wired tools break space limit, which are more convenient and much closer to daily life. **Pro-Deluxe Power Tool Series** helps efficient work with long-lasting motor, powerful metal gear box, and rapid charging Li-ion battery. As a professional total solution provider, **Pro'sKit**[®] does not fulfill demands, it even creates demands. Before the market is aware of its needs, **Pro'sKit**[®] introduces 10 more tool kits with best selected tools to the market. “A friend you can trust” is not a slogan, is just what **Pro'sKit**[®] is!

All rights reserved. Reproduction in whole or in part in any language without permission is prohibited.

Printed in Taiwan, October, 2017. First Edition.

©2017 Prokit's Industries Co., LTD. All rights reserved.

QUALITY CONTROL

Quality is the foundation of the **Pro'sKit**® brand. As an ISO9001:2008 registered manufacturer since 1998, and with continual certification every year since, all **Pro'sKit**® products' quality standards and quality control procedures conform to the strict requirements of the standard.

To enhance **Pro'sKit**® capability in quality control and reliability testing for providing consistent quality product, **Pro'sKit**® has established a quality assurance laboratory since 2007 and continually invested the test equipment as different product requirements every year. **Pro'sKit**® always stresses its quality policy and high standards and will continue to enhance all of its capabilities. There is nothing cannot be further improved.

Quality Assurance System

System Lifetime Test

- Switch Function Device Lifetime Test
- Button Device Function Lifetime Test
- Adapter / Connector Device Lifetime Test
- Dial / Knob Switch Fatigue Test
- Circuit Wire Connector Fatigue Test
- Cutting Edge Lifetime Test

Electrical Reliability and Lifetime Test

- AC Burn-in & Lifetime Test
- Power on and off Cycle Lifetime Test
- High Voltage Insulation Impedance Test
- Maximum AC Voltage Test
- Electrical Signal Analysis Test

Mechanical Aptitude Test

- Torque and Lifetime Test
- Material Hardness Test
- Cutting Force Test
- Tensile and Strength Test
- Crimping Force Test

Mechanical / Transport Test

- Vibration Test
- Bumping Test
- Material Hardness Test
- Packaging Drop Test
- Packaging Bursting Strength Test

AC Burn-in & Lifetime Test



Circuit Wire Connector Fatigue Test



Dial / Knob Switch Fatigue Test



Component Lifetime Test



Vibration Test



QUALITY CONTROL

Product innovation is **Pro'sKit**® permanent mission and policy. **Pro'sKit**® has owned the patents of many products in Taiwan, China or USA and continues to develop new products. Most of **Pro'sKit**® electronic power products are qualified to CE, GS,UL or TUV international standards.

In addition, **Pro'sKit**® takes its responsibility as a member of the global community seriously and has actively taken steps to carry out its green policy. **Pro'sKit**® has been devoted to conforming to RoHS since 2006 per the European Union's regulation that secures **Pro'sKit**® high product quality for its customers throughout the world.



<p>Safety Standards test</p> <ul style="list-style-type: none"> • X-Ray Fluorescence • Restriction of Hazardous Substances • VDE High & Low Temperature Test • VDE Dielectric Strength Test <p>CE, UL, GS, VDE, CSA, ETL, EMC, IP54, ESD, FDA</p>	<p>Environmental Simulation Test</p> <ul style="list-style-type: none"> • Temperature and Humidity Chamber • Salt Spray Test • Waterproof Test • Burn-In Test • Dustproof Test • Anti-Static ESD Test
--	--



Tensile and Strength Test



High Compliance Multi-Product Calibrator

Handheld XRF for RoHS Compliance Test

Torque and Lifetime Test

Temperature and Humidity Chamber

Pro'sKit® Symbols

	Wire spring		Insulated & non-insulated wire ferrules		Hex tamper proof		ESD safe		CONT. LED	Continuity check
	Leaf spring		Non-insulated terminals & lugs		Nut		Non-magnetic		Diode test	
	Flat		Open barrel, non-insulated terminals & lugs		Pozidriv		Magnetic		hFE	Transistor hEF test
	Half-round		D-Sub terminal & Non-Insulated Open Barrel Connectors		Triangle		Safety caution		LED	LED test
	Round		Insulated terminals, Insulated & Uninsulated Flag		Spanner nut		Insulated		Battery check	
	Stripping flat telephone cables		Insulated terminals		Spanner		1KV insulated protection		Backlight	
	Stripping twisted pair round cables		RS-233 D-sub round barrel contact pins or sockets		Torq		Lead free		MAX MIN	Maximum/Minimum value
	2 blade stripping coaxial cables		Insulated & non-insulated wire ferrules		Wing nut driver		Complied with IEC/EN 60529 IP54 test		MAX HOLD	Maximum value hold
	3 blade stripping coaxial cables		Hex type coaxial & fiber optic connectors		Phillips tamper proof		DC voltage		HOLD	Data hold
	Mini bevel		Oval type coaxial & fiber optic connectors		Clutch		AC voltage		AP OFF	Auto power off
	Full flush		Square type coaxial connectors center contact pins		Spline		DC current		Low battery	
	Extra full flush		Crimping pressure adjustment		Square		AC current		0Ω ADJ	Zero-ohm adjuster
	Cross Cut		Ratcheting release knob		TRI-wing		Resistance		OUT	Output terminal
	Serrated		Ratcheting release trigger		Ball hex		Frequency		RS 232C	RS232C connector
	Smooth		Force-saving design		Star		Inductor check		USB	USB connector
	Crosswise serrated		Ratcheting force-saving design		Square tamper proof		Capacitance		RH	Hygrometer
	4 pin(RJ22) telephone handset plugs		Black tip		Torx® plus 5 star		Temperature °C/°F measurement		Air	Thermometer
	6 pin(RJ11/RJ12) telephone plugs		Slotted		Square drive socket		Temperature °C measurement		Lux	Light meter
	8 pin(RJ45) modular plugs		Phillips		Bi-hexagon socket		Duty cycle		dB	Sound level meter
	10 pin(RJ50) modular plugs		Torx®		Needle type bits		Relative reference		RoHS COMPLIANT	RoHS directive
	Telecom splice connectors		Torx tamper proof		Torx® plus socket		Continuity buzzer		REACH COMPLIANT	REACH directive
	Pin terminal, insulated & non-insulated ferrules		Hex		Pantalobe tip		Tri-point tips			

PLUG TYPE

Pro'sKit® Standard plug of power supply cord

• If you have any other issue about power cord, please contact our Sales Team.

Plug Type	Voltage	Plug	Plug Type	Voltage	Plug	Plug Type	Voltage	Plug
A	AC110~120V		D	AC220~240V		G	AC220~240V	
B	AC220~240V		E	AC110~120V		H	AC220~240V	
C	AC220~240V		F	AC220~240V		I	AC220~240V	

TEST INSTRUMENTS

TRUE RMS SERIES

P.4-33

P.16-18



PRECISION PLIERS & CUTTERS

P.34-55



ELECTRICAL PLIERS & CUTTERS

P.56-67



KNIVES & SCISSORS

P.68-71



CRIMPERS

P.72-85



STRIPPERS

P.86-95



PUNCH DOWN TOOLS

P.96-99

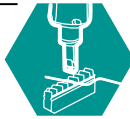

SOLDERING & DESOLDERING

P.100-123

HOBBY & WOOD BURNING KIT P.116-117



ALIGNMENT TOOL & SCREWDRIVERS

P.124-151

3C REPAIR TOOLS

P.148-151



HEX KEY WRENCHES

P.152-155



SOCKET WRENCHES

P.156-163



POWER TOOLS

USB SERIES

P.164-173

P.171



FIBER OPTICS

P.174-183



ESD STATIC PROTECTION

P.184-187



VDE TOOLS

P.188-199



SOLAR TOOLS

P.200-201



PRECISION TWEEZERS

P.202-208



MAGNIFIER & LAMP

P.209-215



MISCELLANEOUS

P.216-229



INSTRUMENT CASES

P.230-235



TOOL CASES

P.236-249



TOOL KITS

P.250-288



TEST INSTRUMENTS



Pro'sKit® provides a variety of test instruments to accurately work- from installation to examination, from personal job to environmental protection.



Pro'sKit®

886-2-22183233
Sales support

pk@mail.prokits.com.tw
E-mail

www.prokits.com.tw
Global website

MT-8100 Butt Set



High-Impedance Monitor

mode for minor noise output while operating.

A Smart Operation

unit for installer, repair technicians and other authorized personnel.

Features

Line Voltage Test • Polarity LED Indicators • Line Continuity Test • Tone and Pulse Operation • Two-way Hands Free Speakerphone • PBX Pause

Electrical	
Loop limit	2 KΩ maximum at 48 VDC (nominal 20 mA minimum loop current)
DC resistance	
Talk mode	300Ω typical
Monitor impedance	39kΩ nominal at 1 kHz
Rotary dial output	
Pulsing rate	10pps+0.8pps
Percent break	61%±2%
Interdigit interval	1000 ms typical
Leakage during break	>50 kΩ
DTMF output	
Tone frequency error	±1.2% maximum
Tone level	-8±2dBm combined (typical)
High versus low tone difference	4 dB maximum
Memory dialing	
Memory capacity	13 memories including M1, last number redialing
Digit capacity	16 digits per memory
PBX pause duration	4 seconds
Line voltage test	5 Phase AC/DC voltage indication (under 24V, 24~100V, 101~150V, 151~200V, more than 200V)
Monitor amplifier	9V transistor; provides 25 hours continuous use, typical
Power source	Continuous use, typical
Automatic power shut off	After 5 min. of no audio signal
Speaker phone levels	Electronically adjustable
Power source	Battery (9V) 6F22 (Not included)
Physical	
Measurement	230 × 82 × 89mm (9-1/16" × 3-15/64" × 3-1/2")
Weight	635g typical
Water resistance	Dust protection & Waterproof tested to an IEC/EN 60529 IP54 rating
Cord sets	Angled bed of nails and RJ11 plug
Environmental	
Temperature	Operating: 0 to 50°C,
Altitude	To 10,000 feet (3,000M) max
Relative humidity	5 To 95%
Individual packing	Color box

IEC/EN 60529 IP54

Water proof and dust proof

Drop Protection

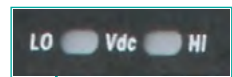

Line Voltage test

Line Continuity Test



Angled Bed of Nails

Electronic Adjustable Volume



MT-8091 In-Line Modular Adapters

4/6/8P 3 in 1

- Allows in-line testing for any plug/jack combination.
- Applied to any brand of butt sets, lan cable testers, or tone generators.

	6 pin Female to 8 pin Male		8 pin to 8 pin 205mm
	4 pin Female to 8 pin Male		8 pin to 6 pin 205mm
			8 pin to 4 pin 205mm
Individual packing		Blister card	

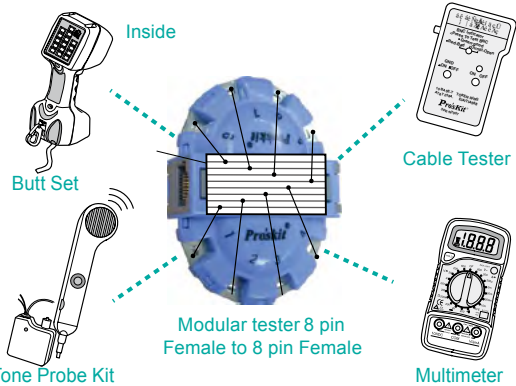

MT-8006B Data Diver

LCD Display



Features

Low Battery Indication • PBX Pause • Backlight • Polarity LED Indicators • Ringer and Voltage Indication • 32 Digits Phone Number Memory of Last Number Redial



Electrical	
Loop limit	2 KΩ maximum at 48 VDC (nominal 20 mA minimum loop current)
DC resistance	
Talk mode	300Ω typical
Monitor impedance	>39kΩ nominal at 1 kHz
Rotary dial output	
Pulsing rate	10pps+0.8pps
Percent break	60/40%±2%
Interdigit interval	1000 ms typical
Leakage during break	>130 kΩ
DTMF output	
Tone frequency error	±1.5% maximum
Tone level	-8±2dBm combined (typical)
High versus low tone difference	4 dB maximum
Memory dialing	
Memory capacity	12 memories
Digit capacity	16 digits per memory
PBX pause duration	1~3.6 seconds
Power source	4pcs 1.5V AAA batteries(Not included)
Physical(Hook included)	
Measurement	218.5 × 69.5 × 49mm (8.6" × 2.7" × 1.9")
Weight	208g typical
Individual packing	Double blister card

MT-8001 Butt Set

Weather Proof

High Impedance Monitor

Advanced PBX Pause
for easy insertion between digits of a stored number.



Electrical

Loop limit	2 KΩ maximum at 48 VDC (nominal 20 mA minimum loop current)
DC resistance	
Talk mode	300Ω typical
Monitor impedance	39kΩ nominal at 1 kHz
Rotary dial output	
Pulsing rate	10pps+0.8pps
Percent break	61%±2%
Interdigit interval	1000 ms typical
Leakage during Break	>50 kΩ
DTMF output	
Tone frequency error	±1.2% maximum
Tone level	-8±2dBm combined (typical)
High versus low tone difference	4 dB maximum
Memory dialing	
Memory capacity	12 memories plus last number redialing
Digit capacity	16 digits per memory
PBX pause duration	4 seconds
Monitor amplifier power source	9V transistor; provides 25 hours continuous use, typical
Speaker levels	Low, medium high
Automatic power shut off	After 5 min. of no audio signal
Speaker phone levels	Low, medium high
Power source	Battery (9V) 6F22 (Not included)
Physical	
Measurement	260 x 70 x 89mm (10-1/4" x 2-3/4" x 3-1/2")
Weight	560g typical
Environmental	
Temperature	Operating: 0 to 50°C Storage : -40 to 66°C
Altitude relative humidity	To 10,000 feet 5 to 95%
Individual packing	Color box

Features

Low Battery Indication • PBX Pause • Backlight • Polarity LED Indicators • Ringer and Voltage Indication • 32 Digits Phone Number Memory of Last Number Redial



▶ MT-7071 LCD Cable Length Toner & Probe Kit



MT-7071
Including transmitter, receiver and standard remote unit, RJ45 cable patch cord, RJ11/12 cable patch cord, alligator clips patch cord, earbud, carrying bag.



MT-7071K
Including standard MT-7071 set. and 8pcs remote unit (ID#1-ID#8).

Features

1-7 Calibration Parameters Setting • Max Support 8 Remote Units • 90~1000V NCV Detection • Current Test • Current Protection <5mA • Voltage Protection AC60V or DC48V • Router Test • Low Battery Display • Auto Power Off • Live Telecommunication Equipment Test

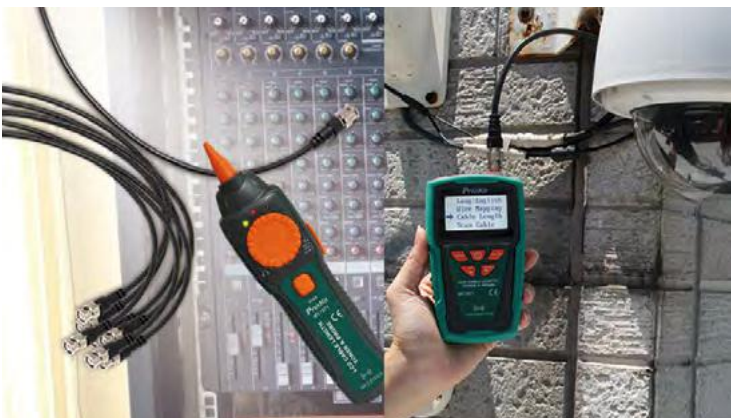

Verify LAN/ Telephone /Coaxial cable condition



Detects AC Voltage

MT-7071 Toner specifications

Cable types tested	RJ45 Lan cable Cat 5、5e、6、(UTP/STP)、RJ11/12 Telephone cable Cat 3 (2/4/6 pin)、Coaxial cable & normal solid/Stranded wire by alligator clips patch cord
Cable test modes	2 note tones for location, wire mapping, open length tested
Measurement technology	Cable capacitance method
Max. distance to open for test	1,200 m (4,000 ft/1,300 yd), approx
Min. distance to open for test	2 meter (6.8 ft/ 2.2 yd)
Typical accuracy of length test	2~10 m (6.8~33 ft/2.2~11yd) for reference 10~610 m (33~2000 ft/ 11~666 yd.): ±5.0% 610~1,200 m (2000~4000ft/666~1300 yd.) for reference, Default measuring Cat.5e cable
Calibration accuracy of length test	10~610 m (33~2,000 ft/11~666 yd) ±3.0%, standard cable:10~50m(33~164 ft/11~55 yd), Default measuring Cat.5e cable
Resolution & unit of length test	0.1 m / ft / yd, Rate:1~3 sec./time
Calibrating parameters memory	1~7 sets, allowing rewrite by new calibrating parameters
Max. distance of transmit	≥3 km (580/1160 Hz) & 610 m (2,000 ft/666 yd)
Min. distance of cable map	Twisted pair:1m (3 ft/1yd), normal wire:1.25m (4ft/1.35yd)
Cable map & shielded indication	LCD 1~8 & G
Battery type	DC 9V(NEDA 1604/6F22)X1pc(Not included)
Dimension (L×W×D)	138×80×35 mm

MT-7071 Receiver specification

Signal status indication	580/1160 Hz
NCV indication & LED illumination	1 LED (AC90~1000V) & 1 LED
Dimension (L×W×D)	203×50×32 mm

MT-7071 Remote unit specifications

Remote unit	1 pc, max. support to 8 pcs
Compatible connectors	RJ45(8 pin), RJ11/12(6 pin), BNC connectors
Remote unit dimension(LxWxD)	90×32×30mm
Individual packing	Color box

▶ MT-7029 Noise-Filtering Network PoE Toner & Probe Kit



Strong Anti-Noise

With EMI filters to eliminate high frequency noise for easy wire tracing.

PoE Switches & STP Wire Tracing
3KM

Cable Mapping Status Indication
300M

▶ MT-7028 Network Toner & Probe Kit



Wire Tracing
3KM

Cable Mapping Status Indication
300M



PoE switches & wire tracing



STP wire tracing



Verify LAN/ telephone cable condition



Wire tracing

Features

- Telephone Line Status Check • 90~1000V NCV Detection • Polarity Indication • Low Battery Display • Router Test • Voltage Protection / DC 48V • Live Telecommunication Equipment Test • Auto Power Off

Features

- 90~1000V NCV Detection • Polarity Indication • Low Battery Display • Router Test • Voltage Protection / DC 48V • Auto Power Off • Live Telecommunication Equipment Test

MT-7029 Transmitter specifications	
Tone frequency	130KHz
Max. distance of transmission & cable map	≥3km&300m
Tone mode	Single tone
Compatible connectors	for RJ45(8 pin)/RJ11(6 pin) cable map test socket/RJ45 SCAN socket : for RJ45 locating Individual wire pairs/RJ11 SCAN socket: for RJ11 locating Individual wire pairs
Cable types tested	RJ45 Lan cable Cat 5 · 5e · 6(UTP/ STP) · RJ11/12 Telephone cable Cat 3 (6P/2C/4C/6C)
Continuity test	1 LED (≤300Ω), Coaxial cable & normal solid/ Stranded wire by alligator clips patch cord
Cable map & shielded indication	8 LEDs Fast/slow dual speed, 1 LED
Phone line polarity indication	1 Dual color LED
Telephone line status indication	1 Dual color LED
Network scan & PoE scan	1 LED&1 LED
EMI filter(network scan & PoE scan)	YES
Battery type	DC 9V(NEDA 1604/6F22) x1pc(Not included)
Dimension (L×W×D)	138×80×35 mm
MT-7029 Receiver specifications	
Frequency	130KHz
Compatible connectors	RJ45(8 pin)/RJ11(6 pin)
Signal status indication	1 dual color LED & buzzer, building ear jack
Cable map & shielded indication	8 LEDs&1 LED
NCV indication	1 LED (AC90~1000V)
LED illumination	1 LED
Battery type	DC 9V (NEDA 1604/6F22) x1 pc (Not included)
Dimension (L×W×D)	203×50×32 mm
Accessories	RJ45 cable patch cords · RJ11 cable patch cords · RJ11 to alligator clips patch cord, earphone, storage bag, user manual
Individual packing	Color box

MT-7028 Transmitter specifications	
Tone frequency	1KHz
Max. distance of transmission & cable map	≥3km&300m
Tone mode	Hi/Low two-note tone
Compatible connectors	RJ45(8 pin)/RJ11(6 pin) compatible connectors, for RJ45(8 pin) · RJ11/12(6P/2C/4C/6C) cable map and RJ45 tone · RJ-11(6 pin) connectors for RJ11/12(6P/2C/4C/6C) tone
Cable types tested	RJ45 Lan cable Cat 5 · 5e · 6 · 7 (UTP/STP) · RJ11/12 Telephone cable Cat 3 (6P/2C/4C/6C)
Continuity test	1 LED (≤300Ω), Coaxial cable & normal solid/ Stranded wire by alligator clips patch cord
Cable map & shielded indication	8 LEDs & 1 LED, Fast/Slow dual speed
Phone line polarity indication	1 Dual color LED
Battery type	DC 9V(NEDA 1604/6F22) x1pc(Not included)
Dimension (L×W×D)	138×80×35 mm
MT-7028 Receiver specifications	
Frequency	1KHz
Compatible connectors	RJ45(8 pin)/RJ11(6 pin)
Signal status indication	1 LED & buzzer, building ear jack
Cable map & shielded indication	8 LEDs & 1 LED
NCV indication	1 LED (AC90~1000V)
LED illumination	1 LED
Battery type	DC 9V (NEDA 1604/6F22) x1 pc (Not included)
Dimension (L×W×D)	203×50×32 mm
Accessories	RJ45 cable patch cords · RJ11 cable patch cords · RJ11 to alligator clips patch cord, earphone, storage bag, user manual
Individual packing	Color box

▶ MT-7059 LCD Multifunction Cable Tester



LCD Display

**Wire Tracing
2KM**

**Cable Mapping
300M**



PoE switches & wire tracing

STP wire tracing

Features

9 Different Tone Mode(Adjustable) • Continuity Test • Low Battery Display • Earphone Function • Volume Adjustment • Illumination

MT-7059 Transmitter specifications	
Indicator	LCD 53X25mm,with back light
Tone frequency	225kHz
Max. distance of transmission	2km
Max. distance of cable map	300m
Max. working current	≤70mA
Compatible connectors	RJ45(8 pin) / RJ11(6 pin) / BNC / USB / IEEE 1394
Max. signal voltage	1.5Vp-p
Function selection	3 Push button & 1 Power switch
Function and faults LCD	LCD display(Wiremap, Tone, Short, No adapter, UTP, STP, Low battery)
Cable map indication	LCD (#1~#8)
Shielded indication	LCD (#9)
Voltage protection	AC 60V / DC 42V
Battery type	DC 9.0V(NEDA 1604/6F22 DC9V) ×1pcs (Not included)
Dimension(LxWxD)	185X80X32mm
MT-7059 Receiver specifications	
Frequency	225kHz
The Max. working current	≤70mA
Battery type	DC 9.0V(NEDA 1604/ 6F22 DC9V×1) (Not included)
Dimension (LxWxD)	218X46X29mm
MT-7059 Receiver specifications	
Compatible connectors	RJ-45(8 pin), RJ-11(6 pin), BNC, USB, IEEE 1394
Dimension (LxWxD)	107X30X24mm
Accessories	Earphone, RJ-45 cable, pouch bag
Individual packing	Color box

▶ MT-7068 All-in-One Toner & Probe Kit



VDV Tester

Telephone and Ethernet Service Detection



Copper cabling detecting, including shielded (STP) and UTP cable

10 Base-T or 10/100 Base-T datacom networks

Features

Powering Telephone Test Set • Low Battery Display • 100V Voltage Protection • 2 Different Tones • Telephone Service, Ethernet Service and Polarity Validation • Earphone Function

MT-7068 Transmitter specifications	
Tone frequency	1kHz
Tone mode	ONE/TWO-note tone
Compatible connectors	RJ-45/RJ-11/USB/F/BNC/RCA/Alligator Clips
Continuity test	<300Ω
Talk battery voltage	6V into 600Ω
Function selection	5-position rotary switch
Cable map indication	8 LED indicators
Battery type	9V (6F22) (Not included)
Dimension (LxWxD)	140x70x30mm
MT-7068 Receiver specifications	
Frequency	1kHz
Compatible connectors	RJ-45/RJ-11/USB/F/BNC/RCA
Signal status indication	8 LED indicators
Cable map indication	8 LED indicators
Low battery display	6.5V
Battery type	9V (6F22) (Not included)
Dimension (LxWxD)	250x52x33mm
Accessories	Zipper bag, RJ-45 cables, BNC connectors, RCA connectors
Individual packing	Color box

▶ MT-7063 ▶ MT-7064 PoE & Lan Cable Tester

2 in 1

PoE Tester Cable Tester

IEEE 802.3 af/at standard Midspan/Endspan

RJ11/RJ12/RJ45



MT-7064
Tests Midspan/Endspan and IEEE 802.3 af / at PoE standard

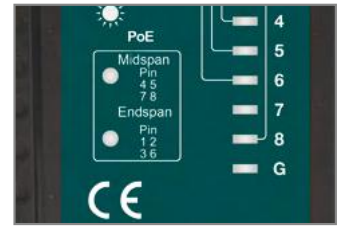

MT-7063
Tests Midspan/Endspan

PoE Tester Features:

- Easily tests ethernet network for power over ethernet existence.
- Quickly detects the type of the power sourcing equipment (either Endspan or Midspan).

Cable Tester Features:

- Automatically runs for cable mapping of RJ11/RJ12/RJ45.
- Cable mapping up to 300M.

Specifications	MT-7064	MT-7063
Max. distance of cable map	300m	
Compatible connectors	RJ45(8 pin) & RJ11(6P/6C/4C/2C) & RJ12 & PoE	
Cable types tested	RJ11/12 Telephone Cable Cat 3 (6P/2C/4C/6C) RJ45 Lan cable Cat 5 · 5e · 6(UTP/STP)	
Cable map indication	8 LED · Fast/Slow dual speed	
Shielded indication	Yes	
Live telecommunication Equipment test and router test	Yes	
Dimension (L×W×D)	Master : 103×66×27 mm , Remote : 103×35×27 mm	
Battery type	DC 9.0V (not included)	
PoE indication(Master)	802.3 af/at PoE standard and Midspan/Endspan	Midspan/Endspan
Individual packing	Blister card	

▶ 3PK-NT023N Tone and Probe Kit



Toner Generator

Probe Amplifier

Basic and Popular Model

For de-energized AC wire, telephone/twisted pair wire, all voice and data category rated cable, virtually any cable or wire!

Features

- Rugged Industrial Design
- Three Selectable Tone Outputs
- Two-ling Polarity Indication
- Continuity Test
- Adjustable Volume Control
- Visual Signal Strength Indication
- Powerful Speaker



Packaged in a soft nylon carrying case

▶ MT-7062 HDMI Cable Tester

19+1 Pin to Pin Wire Map
Loopback Function
3 Test Modes



For HDMI & MINI HDMI cable

Features

- Automatically Fast, Slow Scan or Step by Step Manual Test • Beeper Indication • Low Battery Indication

Cable versions support	HDMI Cables with type A & C connectors conforming to 1.0, 1.1, 1.2, 1.3, 1.3a, 1.3b, 1.3c, 1.4, 1.4a, cat. 1 and cat. 2 cables
Test interface of Master unit	HDMI (type A) ×2, Mini HDMI (type C) ×1
Test interface of Remote unit	HDMI (type A) ×1, Mini HDMI (type C) ×1
Power source	DC 9V ×1 (not included)
Dimensions	Master unit: 103×66×27mm, Remote unit: 103×35×27mm
Individual packing	Blister Card

▶ MT-7057N Cable Sniffer-Remote

UTP/STP LAN Cable Indication
PoE Line Voltage Protection
Cable Test: 500M



Features

- Simple One Touch Operation • Detects Open, Short, Miswired, and Cross-Over Wired • Test for RJ45, RJ11, RJ12, USB, BNC • Visual and Audible Dual Indication

Functions	Test on RJ45 EIA/TIA-568A/B • AT&T258A • RJ11/12 USOC4/6/8 • EthernetT 10BaseT • Token Ring, Telephone • USB • BNC coaxial cable, Phone Net and cabling system. Low battery indication Beeper annunciation
Test distance	500meter(1,640ft)
Power	9V (NEDA 1604/ 6F22) battery x 1(not included)
Accessories	RJ45 to female BNC terminator, Carrying bag x1, Instruction Manual x1
Size	Approach 160 x 85 x 25mm
Individual packing	Color box

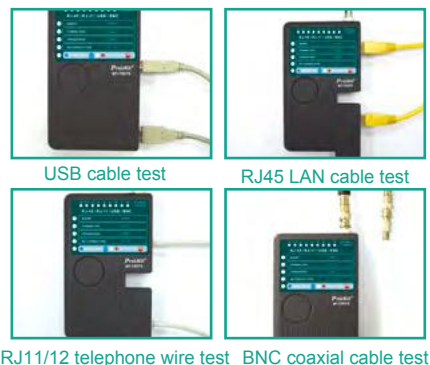

▶ MT-7058 Mini Lan Cable Tester

Cable Test : 300M
One Touch Testing



Features

- Cable Map Indicator • Circuit Protection for Both Unit • Low Battery Indication • Automatically Detect • Visual & Audible Dual Indication • AC60V~240V, 60Hz NCV Detection • Beeper Indicator

Compatible connectors	Ground or shielded test, Test RJ45 TIA568A/B (AT&T 258A), 10 Base-T, Token ring, RJ-11/ RJ-12 USOC and coaxial BNC cable
Size	100×60×24.5 mm
Power	12V AE23 x 1pcs
Accessories	Pouch bag x 1, BNC connector x 1
Individual packing	Blister card

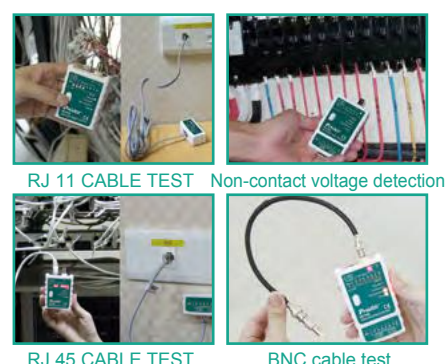

▶ MT-7051N Multi-Modular Cable Tester

For testing RJ45/RJ11/RJ12/BNC Cable



MT-7051N Transmitter specification	
Compatible connectors	RJ45 (8 pin), RJ11 (6 pin), BNC
Cable types tested	UTP, STP, Cat. 5e, Cat. 6, Cat. 7, Cat. 3 telephone line, RG6, RG58, RG59, CATV/CCTV coaxial cable
Test mode	3modes
Cable mapping	8 LEDs
Shielded indication	Yes
Battery	NEDA 1604/ 6F22 DC9V ×1pce(Not included)
Size	105 x 65 x 28mm
MT-7051N Receiver Specification	
Compatible connectors	RJ45 (8 pin), RJ11 (6 pin), BNC
Cable version support	UTP, STP, Cat. 5e, Cat. 6, Cat. 7, Cat. 3 telephone line
Cable mapping	8 LEDs
Size	105 x 38 x 28mm
Accessories	BNC connector x1, zipper bag x1

▶ 3PK-NT005N Multi-Modular Cable Tester

For testing RJ45/RJ11/RJ12 Cable



3PK-NT005N Transmitter specification	
Compatible connectors	RJ45 (8Pin), RJ11(6Pin)
Cable types tested	RJ45 Lan cable Cat. 5e, 6, 7(UTP/STP), RJ11/12 Telephone cable Cat.3
Fault/Functional indicator	1 LED
Cable map	4 LEDs
Power source	DC 9V Battery (Not included)
Dimension(LxWxH)	105x62x26 mm
Weight	75g(Without battery)
3PK-NT005N Receiver Specification	
Compatible connectors	RJ45 (8Pin), RJ11(6Pin)
Cable types tested	RJ45 Lan cable Cat. 5e, 6, 7(UTP/STP), RJ11/12 Telephone cable Cat.3
Cable map	4 LEDs
Dimension(LxWxH)	100x30x26 mm
Weight	30g(Without battery)

▶ 3PK-NT007N Multi-Network Cable Tester

For testing RJ45/BNC Cable



3PK-NT007N Transmitter specification	
Compatible connectors	RJ45 (8Pin), RJ11(6Pin),BNC
Cable types tested	RJ45 Lan cable Cat. 5e, 6, 7(UTP/STP), RJ11/12 Telephone cable Cat.3, Coaxial cable(RG6, RG58, RG59, CATV/CCTV Coaxial cable)
Fault/Functional indicator	2 LEDs
Power source	DC 9V Battery (Not included)
Dimension(LxWxH)	105x62x26 mm
Weight	85g(Without battery)
3PK-NT007N Receiver Specification	
Compatible connectors	RJ45 (8Pin), RJ11(6Pin),BNC
Cable types tested	RJ45 Lan cable Cat. 5e, 6, 7(UTP/STP), RJ11/12 Telephone cable Cat.3
Cable map	4 LEDs
Dimension(LxWxH)	105x30x26 mm
Weight	30g(Without battery)

Test Instruments

Maximum display range and accuracy for digital multimeters and digital clamp meters and environmental meters

rdg(reading)

The value on the digital display, readout.



dgt(digit)

Indicates the least significant digit. It represents the error used for processing fractions when converting from analog to digital.

Maximum display range

MT-1860/1820/1707/1217/1280: the maximum display range is "5999".
 MT-1710/1506/1232: the maximum display range is "3999".
 MT-1705/5211/5110/1509/1508/1132/1210/1270/1250/1233C/1233D : the maximum display range is "1999".

Resistance	Display	
4000kΩ	4.000MΩ	The range is automatically switched so that the display unit is MΩ or kΩ
4000Ω	4.000kΩ	
40Ω	40.00Ω	The reading is display with three digits.

Accuracy

When ACV measurement using the MT-1270, the maximum display value is 199.9V, minimum display value is 0.01V.



Example

The accuracy of the AC200 V reading is $\pm(0.8\%rdg+5dgt)$. when measuring AC100V, the accuracy reading display range is 100.9-99.15.
 $100V \pm (0.8\% + 5dpt)$
 $= 100 + (0.80 + 0.05) - 100 - (0.80 + 0.05)$
 $= 100.9 - 99.15$

SI prefixes

Symbol	Prefixes	Decimal		Units frequently used
		Long Scale	Short Scale	
G	giga	1X1,000,000,00	1X10 ⁹	GHz
M	mega	1X1,000,000	1X10 ⁶	MΩ, MHz
K	kilo	1X1,000	1X10 ³	kΩ, kV, kW, kHz
m	milli	1/1,000	1X10 ⁻³	mV, mA, mW, mF, mH
μ	micro	1/1,000,000	1X10 ⁻⁶	μV, μA, μW, μF, μH
n	nano	1/1,000,000,000	1X10 ⁻⁹	nA, nF, nH
p	pico	1/1,000,000,000,000	1X10 ⁻¹²	pF, pH

USB USB connector



V $\overline{\text{---}}$ DC voltage

V \sim AC voltage

A $\overline{\text{---}}$ DC current

A \sim AC current

Ω Resistance

Hz Frequency

$\overline{\text{---}}$ Capacitance

$\overline{\text{---}}$ Inductor check

°C / °F Temperature °C/F measurement

°C Temperature °C measurement

Hz Duty Duty cycle

REL Relative reference

$\overline{\text{---}}$ Continuity buzzer

CONT. LED Continuity check

$\overline{\text{---}}$ Diode test

hFE Transistor hFE test

LED LED test

$\overline{\text{---}}$ Battery check

Backlight

Maximum/Minimum value

Maximum value hold

Data hold

Auto power off

Low battery

Zero-ohm adjuster

Output terminal

Most of Pro'sKit® test instruments are approved by CE EN61010-1 CATII/ CATIII test.

CAT. II Primary circuits or equipments connected to low voltage facilities, such as a standard wall outlet.

CAT. III Equipment used for measurement in building facilities, distribution boards, and circuit breakers.





PC LINK SYSTEM

The Professional Multimeter Series with USB connector allow you to easily connect to PC for monitor measuring data and recording. An ideal tool in laboratory, factory as well as for radio fans and family.

▶ **MT-1860** 3 5/6 Dual Display DMM w/USB Connector & Key Touching

Endowed with the key touching function instead of the traditional mechanical knobs for quick measurement.



Data Log
Touch Keys
Dual Display
with Analog Bargraph
Auto Range

Features

Duty Cycle • Relative Reference • Backlight • Max. Min. Hold • Data Hold • Continuity Test • Diode Test • Low Battery Indication • Auto Power Off

Specification

DCV	600m/6/60/600V ±(0.5%+4d), 1000V ±(1.0%+4d)
ACV	6/60/600V ±(0.8%+10d), 750V ±(1.0%+6d)
DCA	60m/600mA ±(1.0%+10d), 6/10A ±(1.2%+10d)
ACA	60m/600mA ±(1.5%+10d), 6/10A ±(2.5%+15d)
Resistance	600Ω ±(0.8%+5d), 6k/60k/600k/6MΩ ±(0.8%+4d), 60MΩ ±(1.2%+10d)
Frequency	10/100/1000/10k/100k/1M/20MHz ±(0.3%+2d)
Capacitance	40nF ±(5%+30d), 400n/4μ/40μF ±(3.5%+8d), 200μF ±(5.0%+10d)
Temperature	-20~400°C(0~750°F) ±(1.0%+5d), 400~1000°C(750~1832°F) ±(1.5%+15d)
Power source	AAA(1.5V)×2pcs (Not Included)
Size	185×91×49 mm
Individual packing	Color box
Accessories	Test lead, Temperature probe (K-Thermocouple), PC Interface cable, Software disk, Holster

▶ **MT-1820** 3 5/6 Dual Display DMM w/USB Connector

With dual display enabling user to check intuitively changes in the measured signal as an analog meter.



Data Log
Dual Display
with Analog Bargraph
Auto Range
hFE Test

Features

• Transistor Test • Duty Cycle • Relative Reference • Backlight • Data Hold • Max./Min. Hold • Continuity Test • Diode Test • Low Battery Indication • Auto Power Off

Specification

DCV	600m/6/60/600V ±(0.5%+4d), 1000V ±(1.0%+6d)
ACV	6/60/600V ±(0.8%+10d), 750V ±(1.0%+10d)
DCA	600μ/6000μA ±(1.0%+10d), 60m/600mA ±(1.0%+10d), 6/10A ±(1.2%+10d)
ACA	600μ/6000μA ±(1.5%+10d), 60m/600mA ±(1.5%+10d), 6/10A ±(2.0%+15d)
Resistance	600Ω ±(0.8%+5d), 6k/60k/600k/6MΩ ±(0.8%+4d), 60MΩ ±(1.2%+10d)
Frequency	100/1000Hz ±(0.5%+4d), 10k/100kHz ±(0.5%+4d), 1M/30MHz ±(0.5%+4d)
Capacitance	40nF ±(5%+30d), 400n/4μ/40μF ±(3.5%+8d), 200μF ±(5.0%+10d)
Temperature	-20~400°C(0~750°F) ±(1.0%+5d), 400~1000°C(750~1832°F) ±(1.5%+15d)
Power source	AAA(1.5V)×2pcs (Not included)
Size	192×95×48 mm
Individual packing	Color box
Accessories	Test lead, Temperature probe (K-Thermocouple), PC Interface cable, Software disk, Transistor test accessory

▶ MT-5211 3 1/2 Digital LCR Multimeter

A fully featured multimeter with LCR, utilizing a dual-integral A/D converter. Ideal for a variety of electrical and electronic testing applications.

CAT IV 600V  

Features

- Transistor Test • Backlight • Data Hold • Continuity Test • Diode Test
- Low Battery Indication • Auto Power Off • Overload Indication

Specification	
DCV	200mV/2V/20V/200V±(0.5%+3d), 1000V±(1.0%+5d)
ACV	200mV±(1.2%+3d), 2V/20V/200V±(0.8%+5d), 750V±(1.2%+5d)
DCA	2mA/20mA±(0.8%+3d), 200mA±(1.2%+4d), 20A±(2.0%+5d)
ACA	2mA/20mA±(1.0%+5d), 200mA±(2.0%+5d), 20A±(3.0%+10d)
Resistance	200±(0.8%+5d), 2K/20K/200K/2MΩ±(0.8%+3d), 20MΩ±(1.0%+15d), 2000MΩ±(5.0%(reading-10)+20d)
Capacitance	20nF/200nF/2μF±(2.5%+20d), 20μF/200μF±(5.0%+5d)
Inductance	2mH/20mH/200mH/2H/20H±(2.5%+20d)
Temperature (-20~1000 °C)	<400 °C±(1.0%+4d), ≥400 °C±(1.5%+15d)
Frequency	2K/20K/200K/2000K/10M Hz±(1.0%+10d)
Power source	9V 6F22 battery(Not included)
Size	189×97.5×35mm
Individual packing	Color box
Accessories	Test lead, thermocouple, test socket

LCR Meter Full Function

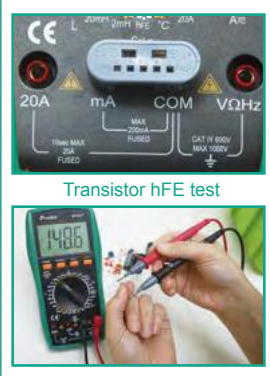

Transistor hFE test



What is LCR?
 LCR meter is a easy way to measure and analyze inductance(L), capacitance(C), and resistance(R) of passive components and material accurately.



Inductance to 20H

Capacitance to 200μF

Resistance to 2000MΩ

▶ MT-5110 3 1/2 Capacitance Meter

A professional capacitance meter with LSI-circuit provides high reliability and durability. Measurements are available even under a strong magnetic field.

CAT III 1000V  

Features

- Backlight
- Low Battery Indication
- Input Overload Protection

Specification	
Capacitance	200pF ±(0.5%+7d), 2n/20n/200n/2μ/20μ/200μF ±(0.5%+5d), 2,000μF ±(2.0%+5d), 20,000μF ±(3.0%+10d)
Zero adjustment	Manual (range:±20pF)
Over-input	Display shows "1"
Sampling time	0~5 second
Power source	NEDA1604/6F22 (9V) x 1pce (Not included)
Size	182x90x46mm
Individual Packing	Color box
Accessories	Test lead (Model. MT-9906)

200pF to 20,000μF Large Capacitance Range

Zero Knob for Low Capacitance Measurement



TRUE-RMS MULTIMETER SERIES

For effective value of AC current or voltage to precise your work.

The need for True-RMS meters keeps growing every day and everywhere, Pro'sKit True RMS Multimeter Series convenient your work effeciently.



Accurate

0.5% best accuracy

Trust worthy

Latest CE certificate

Safe



Overload protection





Why True-RMS?

There are two methods commonly used in Digital Volt Meter (DVM) AC measurements, one is AC average rectified measurement and the other is True RMS measurement. True RMS is a consistent and standard way to measure and compare dynamic signals of all shapes and sizes.

Most meters use an averaging technique for determining the RMS reading of an AC voltage or current. This method gives an accurate reading when measuring an AC voltage with a sinusoidal waveform, but when components in the circuit change the shape of the sine wave, an averaging meter will be inaccurate.

Multimeter Type			
Average Responding	Correct	10% high	5%~10% low
True RMS	Correct	Correct	Correct

Multimeter Type			
Average Responding	5%~10% low	40% low	5%~30% low
True RMS	Correct	Correct	Correct

The need for true-rms meters has grown as non-linear loads are everywhere, such as electrical, lighting, HVAC, mechanical, or industrial. For routinely working in any of these environments, a technician should consider getting a True RMS meter instead of an averaging meter:

- Solid state electronics
- Variable frequency drives (VFD) or variable speed drives (VSD)
- Fan controls •Motor controls
- HVAC systems •Controller boards
- Low-voltage systems •Power supplies
- Industrial motors •Pumps
- Elevators •Conveyors
- Machine tool drives •High-tech/IT-intensive environments
- Any scenario where a linear waveform will be distorted by intermediary

True RMS multimeter will give you better readings. Better readings will pay off in the long run. More accurate readings and fewer diagnostic errors will surely deliver a return quickly on investment.

Pro'sKit[®]

is always here to **check your short.**

Innovation • Quality • Service

▶ MT-1707 3-5/6 True RMS Multimeter

**Auto Range
Live Wire Test**

CAT III 1000V **RoHS COMPLIANT**
CAT IV 600V

Features

- Continuity Test • Duty Cycle • Data Hold • Auto Power Off
- LED Light • Low Battery Indication • Input Alert Protection
- NCV Detection

DCV	600mV/6V/60V/600V/1000V ±(0.5%+3d)
ACV True RMS	6V/60V ±(0.8%+3d), 600V/750V ±(1%+10d) Frequency Response : 40Hz-1KHz
DCA	60uA/6mA/60mA/600mA±(0.8%+3d) 10.00A±(1.2%+3d)
ACA True RMS	60mA/600mA±(1%+3d), 10.00A±(1.5%+3d) Frequency Response : 40Hz-1KHz
Frequency	9.999Hz/99.99Hz/999.9Hz/9.999KHz/ 99.99KHz/999.9KHz/9.99MHz ±(1.0%+3d)
Resistance	600Ω/6kΩ/60kΩ/600kΩ/6MΩ±(0.8%+3d) 60MΩ±(1.2%+3d)
Capacitance	6nF±(4.0%+30d) 60nF/600nF/6uF/60uF/600uF/6mF±(4.0%+3d) 100mF ±(5.0%+3d)
Temperature	-20°C~1000°C/-4°F~1832°F±(1.0%+3d)
Fuse	FF600mA/1000V, FF10A/1000V
Power	4 x 1.5V AA Batteries (Not included)
Weight	340g (Without battery)
Size	192 mm(L)×89 mm(W)×55mm(H)
Individual packing	Color Box
Accessories	Test lead, K-Type thermocouple

100 mF
30 Positions, Full Function

Special design for ACV/ACA True-RMS measurement. Ideal for a variety of electrical and electronic applications.



▶ MT-1710 3 3/4 True RMS Multimeter

**Auto Range
hFE Test
Temperature Measurement**

CAT IV 600V

Features

- Continuity with Beeper • Diode Test • Transistor Test • Duty Cycle
- Relative Reference • Data Hold • Auto Power Off • Low Battery Indication • Input Alert
- LCD Backlight



DCV	400mV/4/40/400V ±(0.5%+4d), 1000V ±(1.0%+6d)
ACV	40~1kHz(sine and triangular wave) and 40~200Hz(other wave): 400mV ±(1.6%+8d), 4/40/400/750V ±(1.0%+10d) 200~1kHz(other wave):400mV/4/40/400/750V ±(8.0%+15d)
DCA	400uA/4000uA ±(1.0%+10d), 40mA/400mA ±(1.2%+8d), 10A ±(1.2%+10d)
ACA	40~1kHz(sine and triangular wave) and 40~200Hz(other wave): 400uA/4000uA/40mA/400mA ±(1.5%+10d), 10A ±(2.0%+15d) 200~1kHz(other wave):400uA/4000uA/40mA/400mA/10A ±(8.0%+15d)
Resistance	400Ω ±(0.8%+5d), 4k/40k/400k/4MΩ ±(0.8%+4d), 40MΩ ±(1.2%+10d)
Frequency	100/1000/10k/100kHz ±(0.5%+10d), 1M/30MHz ±(0.5%+10d)
Capacitance	10n ±(5.0%+20d), 100n/1u/10u/100uF ±(3.5%+8d), 1/10/100mF ±(5.0%+10d)
Temperature	-20~400°C(-4~752°F) ±(1.0%+5d), 400~1000°C (752~1832°F) ±(1.5%+15d)
Power source	9V (NEDA 1640/6F22) battery(Not included)
Size	190×95×45 mm
Individual packing	Color box
Accessories	Test lead, transistor test socket, thermocouple probe

▶ MT-1705 3 1/2 True RMS Multimeter

Economic Type

CAT III 600V **RoHS COMPLIANT**

Features

- Continuity with Beeper • Diode Test • Data Hold • Auto Power Off
- Low Battery Indication • Input Alert • LCD Backlight • Overload Indication



DCV	200mV/2V/20V/200V±(0.5%+3d) ,600V±(1.0%+10d)
ACV	40Hz-200Hz and 200Hz-1kHz sine and triangular wave: 2V/200V±(0.8%+5d), 600V±(1.2%+10d) 200Hz-1kHz other wave: 2V/200V/600V±(8.0%+15d)
DCA	20mA/200mA±(1.2%+8d), 10A±(2.0%+5d)
ACA	40Hz-200Hz and 200Hz-1kHz Sine and triangular wave: 200mA±(1.5%+15d), 10A±(3.0%+10d) 200Hz-1kHz Other wave: 200mA/10A±(8.0%+15d)
Resistance	200±(0.8%+5d), 20k/200k±(0.8%+3d), 20M±(1.0%+25d)
Frequency	10/100/1k/10k/100k/2M Hz±(1.0%+10d)
Capacitance	20nF/200nF/2uF±(3.5%+20d), 20uF/200uF/2000uF±(5.0%+10d)
Temperature	N/A
Power source	3V(1.5VAAA×2)(Not included)
Size	150x73.5x35mm
Individual packing	Color box
Accessories	Test lead

▶ **MT-3112****3 5/8 Smart True-RMS Flex Clamp Meter**CAT IV 600V 

A smart digital flexible clamp meter with dual display enables simultaneous measurement for efficient work.



**7.5mm
Flexible Clamp**

**Simultaneous
Measurement
with Dual Display**

Digital Smart Measurement

- Auto selection
- Auto range

Large Frequency Range

Bandwidth: 40-2000Hz

Simultaneous Measurement

Dual display enables one to show frequency while measuring ACV, ACA; or while measuring ACA simultaneously measured with ACV/DCV and resistance.

Features

- Auto Power Off • Low Battery Indication • Data Hold • LED Light
- Backlight

ACA True-RMS	60A/600A/3000A±(2%+5d) (40Hz -65Hz) 60A/600A/3000A±(3%+5d) (65Hz -200Hz) ≤1000A±(3%+5d), >1000A (200Hz -1000Hz) for reference
ACV True-RMS	6V /60V/600V ±(1.2%+3d) (45Hz~65Hz) 6V /60V/600V ±(2.0%+5d) (40Hz~45Hz, 65Hz~2000Hz)
DCV	6V/60V/600V ±(0.8%+3d)
Resistance	6K/60K/600K/6M ±(1.0%+3d)
Frequency	40~10kHz ±(0.5%+2d)
Power Supply	1.5V AAA x 3
Size	324 x 178 x 30
Individual packing	Color box

▶ **MT-1506****3 3/4 Pocket True-RMS Auto Range Multimeter**

A stable and high performance True-RMS digital multimeter by dual-integral A/D converter. Compact size with full function makes it a great choice to carry-on.

CAT II 600V 

Mini Size
with Multifunction

Easy Store
with Integrated Case
and Built-In Test Lead

Features

- Continuity Test • Diode Test • Duty Cycle • Low Battery Indication
- Auto Power Off • Relative Reference

DCV	400mV, 4/40/400V ±(0.5%+4d), 600V ±(1%+4d)
ACV True-RMS	400mV±(1.5%+6d), 4/40/400V ±(0.8%+6d), 600V ±(1.0%+6d)
Resistance	400Ω ±(0.8%+5d) 4k/40k/400k/4MΩ ±(0.8%+4d), 40MΩ ±(1.2%+5d)
Frequency	100/1000Hz/10k/100k/1MHz/10MHz ±(0.5%+4d)
Capacitance	4nF ±(5%+40d), 40n/400n/4μ/40μ ±(3.5%+8d), 2000μF ±(5%+8d)
Duty cycle	0.1~99.9% ±(0.5%+4d)
Continuity with beeper	50 ±30Ω
Diode test	Range: 0 ~ 1.5V Resolution: 1mV
Power source	2 x 1.5V AAA battery (Not included)
Size	124 x 80 x 20 mm
Individual packing	Color box

▶ MT-1509 **3 1/2 Pocket Autorange Multimeter**

CE CAT III 600V RoHS COMPLIANT

One Touch
Smart Measuring
NCV Detection
Auto Selection



Features

- Continuity Test • Auto Power Off
- Low Battery Indication • Data Hold
- Over Range Indication • Backlight



NCV detection



ACV measurement

DCV	2V/20V/200V±(0.5%+3d), 600V±(0.8%+5d)
ACV	2V/20V/200V±(0.8%+3d), 600V±(1.0%+5d)
Resistance	2kΩ/20kΩ/200kΩ/2MΩ±(1.0%+3d) 10MΩ±(1.2%+15d)
Battery	2x1.5V AAA (Not included)
Weight	140g (Not included battery)
Size	125 x 60 x 26 mm
Individual packing	Color box

▶ MT-1508 **3 1/2 Pocket Autorange Multimeter**

CE CAT III 600V RoHS COMPLIANT

ACA/DCA
Measurement
NCV Detection
Diode Test



Features

- Diode Test • Continuity Test • Auto Power Off
- Low Battery Indication • Data Hold
- Over Range Indication • Backlight



Resistance Measurement



ACV measurement

DCV	200mV/2V/20V/200V±(0.5%+3d), 600V±(0.8%+5d)
ACV	2V/20V/200V±(0.8%+3d), 600V±(1.0%+5d)
DCA	200μA/2000μA/20mA/200mA±(1.8%+5d)
ACA	200μA/2000μA/20mA/200mA±(2.0%+5d)
Resistance	200Ω/2kΩ/20kΩ/200kΩ/2MΩ±(1.0%+3d), 20MΩ±(1.2%+15d)
Battery	2x1.5V AAA (Not included)
Dimension	125 x 60 x 25mm
Weight	152g (not included battery)
Individual packing	Blister card

▶ MT-1632 **3 2/3 Smart SMD Test Tweezer**

CE RoHS COMPLIANT

Special handle stopper and V shape tip design for testing and troubleshooting SMD.



Golden Tip
Auto Range

Features

- Diode Test • Continuity Test • Auto Power Off • Data Hold
- Over Range Indication • Backlight

Resistance	300Ω/3KΩ/30K/300K/3MΩ±(1%rdg+ 2dgt) 30MΩ±(1.2%rdg+3dgt) Resolution: 0.1Ω
Capacitance	3nF/30nF/300nF/3μF/30μF±(2.5%rdg+ 3dgt) 300μF/3mF/30mF±(3%rdg+ 3dgt) Resolution: 1pF
Diode test	Open voltage : 2.8V
Continuity	Testing Current : 2mA
Check	Resistance < 30Ω, Buzzer will sound
Power Source	1 x 3V CR2032 cell (not included)
Dimension	170x32x20mm
Accessories	Carrying case and extra pair of tips
Individual packing	Color box



▶ MT-1630 **3 1/2 Pen-Style Meter**

CE RoHS COMPLIANT

Compact Size
Multifunction
Auto Range

Features

- Diode Test • Continuity Test • Auto Power Off
- Data Hold • Low Battery Indication • Over Range Indication
- Penlight • Fuse protection

DCV	200mV/2V/20V/200V±(0.5%+3d), 600V±(0.8%+5d)
ACV	2V/20V/200V±(0.8%+3d), 600V±(1.0%+5d)
DCA	200μA/2000μA /20mA/200mA±(1.8%+5d)
ACA	200μA/2000μA /20mA/200mA±(2.0%+5d)
Resistance	200Ω/2kΩ/20kΩ/200kΩ/2MΩ±(1.0%+3d), 20MΩ±(1.2%+15d)
Battery	2x1.5V AAA
Weight	152g (not include battery)
Dimension	125mmx60mmx26mm
Individual packing	Blister card



▶ **MT-1217** 3 3/4 Auto Range Digital Multimeter



**Relative Reference Value
Auto Range
Duty Cycle**

CAT III 1000V

Features

- Auto Power Off • Data Hold • Diode Test • Continuity with Beeper • Low Battery Indication • Transistor Test • Frequency • LED Indicator

DCV	400mV/4V/40V/400V ±(0.5%+4d), 1000V ±(1.0%+6d)
ACV	4V/40V/400V ±(0.8%+6d), 750V ±(1.0%+10d)
DCA	400µA/4000µA ±(1.0%+10d), 40mA/400mA ±(1.0%+10d), 4A/10A±(1.2%+10d)
ACA	400µA/4000µA ±(1.5%+10d), 40mA/400mA ±(1.5%+10d), 4A±(2.0%+15d) ; 10 A±(2.5%+15d)
Resistance	400Ω ±(0.8%+5d), 4k/40k/400KΩ/4MΩ±(0.8%+4d), 40MΩ ±(1.2%+10d)
Frequency	400/4K/20KHz ±(0.5%+10d)
Accuracy	0.5% best accuracy
Capacitance	40nF ±(0.5%+30d), 400nF/4µF/20µF ±(3.5%+8d)
Temperature	(-20°C~1000°C) < 400°C±(1.0%+5d) (-20°C~1000°C) >= 400°C±(1.5%+15d)
Battery	9Vx1 (Not included)
Individual packing	Color box Size 182×90×46mm
Accessories	Test lead(MT-9906), transistor test socket, thermocouple probe

▶ **MT-1280** 3 1/2 Digital Multimeter



**20A Large DCA
Measurement**

CAT III 1000V

Features

- Auto Power Off • Data Hold • Diode Test • Continuity with Beeper • Low Battery Indication • Transistor Test • LED Indicator

DCV	200mV/2V/20V/200V ±(0.5%+3d), 1000V ±(0.8%+10d)
ACV	2V/20V/200V ±(0.8%+5d), 750V ±(1.2%+10d)
DCA	200µA/20mA ±(0.8%+10d), 200mA ±(1.2%+8d), 20A ±(2.0%+5d)
ACA	20mA ±(1.0%+5d), 200mA ±(2.0%+5d), 20A ±(3.0%+10d)
Resistance(Ω)	200Ω ±(0.8%+5d), 2K/20K/200KΩ ±(0.8%+3d), 20MΩ ±(1.0%+25d), 200MΩ ±[5.0%(rdg-10)+10d]
Capacitance(µF)	20nF ±(2.5%+20d), 20µF ±(2.5%+20d), 200µF ±(5.0%+20d)
Temperature	-20°C~400°C±(1.0%+5d), 400°C~1000°C±(1.5%+15d)
Battery	9V(6F22) (Not Included)
Individual packing	Color box Size 182×90×46mm
Accessories	Test lead(MT-9906), transistor test socket, thermocouple probe

▶ **MT-1270** 3 1/2 Digital Multimeter



**Frequency
Capacitance
Temperature**

CAT III 1000V

Features

- °C Test • Transistor Test • Auto Power Off • LCD Backlight • Diode Test • Low Battery Indication • Data Hold

DCV	200mV/2V/20V/200V ±(0.5%+3d)1000V ±(0.8%+10d)
ACV	2V/20V/200V ±(0.8%+5d)750V ±(1.2%+10d)
DCA	2mA/20mA ±(0.8%+10d), 200mA ±(1.2%+8d), 10A ±(2.0%+5d)
ACA	20mA ±(1.0%+15d), 200mA ±(2.0%+5d), 10A ±(3.0%+10d)
Resistance	200Ω ±(0.8%+5d), 2K/20K/200K/2MΩ ±(0.8%+3d) 20MΩ ±(1.0%+25d), 200MΩ ±[5.0%(rdg-10)+30d]
Frequency	20K Hz ±(3.0%+18d)
Capacitance	2nF ±(2.5%+20d), 20nF ±(2.5%+20d), 200nF ±(2.5%+20d), 2µF ±(2.5%+20d), 20µF ±(5.0%+30d)
Temperature	(-20°C~400°C)±1.0%+5d, (400~1000°C)±(1.5%+15d)
Battery	9V(6F22) (Not Included)
Size	182 x 90 x 46 mm
Accessories	Test lead(MT-9906), Transistor test socket, thermocouple probe
Individual packing	Color Box

▶ MT-1232 3 3/4 Autorange Digital Multimeter

Professional grade - Ideal for general electrical testing and troubleshooting.

CAT III 600V  

Features

- Diode Test • Continuity Test • Duty Cycle • Relative Value Measurement • Auto Power Off • Data Hold • Low Battery Indication • Backlight

DCV	400mV/4V/40V/400V ±(0.5%+4d), 600V ±(1.0%+4d)
ACV	4V/40V/400V ±(0.8%+6d), 600V ±(1.0%+6d)
DCA	400µA/4000µA ±(1.0%+10d), 40mA/400mA ±(1.0%+10d), 10A±(1.2%+10d)
ACA	400µA/4000µA ±(1.5%+10d), 40mA/400mA ±(1.5%+10d), 10 A±(2.5%+15d)
Resistance	400Ω ±(0.8%+5d), 4k/40k/400K± (0.8%+4d), 4MΩ ±(0.8%+4d), 40MΩ ±(1.2%+10d)
Frequency	1/10/100Hz ±(0.5%+10d), 1K/10K/100KHz ±(0.5%+10d), 1/10MHz ±(0.5%+10d)
Capacitance	4nF ±(0.5%+9d), 40nF/400nF/4µF/40µF ±(3.5%+8d), 100µF ±(5.0%+8d)
Temperature	(-20 C~1000 C) < 400 C±(1.0%+5d), (-20 C~1000 C) >= 400 C±(1.5%+15d)
Fuse	10A/250V
Battery	1.5V AA x 2 (not included)
Size	147 x 78 x 41 mm Individual packing Color box
Accessories	Test lead, Thermocouple

Auto Range All in One

- Frequency
- Temperature
- Capacitance



▶ MT-1132 3 1/2 Digital Multimeter

Features

- Diode Test • Continuity Test • Transistor Test • Battery Test • LED Test • Data Hold • Low Battery Indication • Backlight

DCV	200mV/2V/20V/200V ±(0.5%+2d), 500V ±(0.8%+5d)
ACV	200V ±(1.2%+10d), 500V ±(1.2%+10d)
DCA	200µA/2mA/20mA/200mA ±(1.0%+5d), 10A ±(2.5%+5d)
Resistance	200Ω ±(0.8%+5d), 2K/20K/200K ±(0.8%+5d), 2MΩ ±(1.0%+5d)
Fuse	10A/250V
Battery	1.5V AA x 2
Size	147 x 78 x 41 mm
Accessories	Test lead, Test socket
Individual packing	Color box

Professional Grade Economic Type

CAT III 600V  



▶ MT-1250 Professional 3 1/2 Digital Multimeter

Features

- Diode Test • Continuity Test • Transistor Test • LED Test • Auto Power Off • Data Hold • Low Battery Indication • Backlight

DCV	200mV ±(0.5%+1d), 2/20/200V ±(1.0%+2d), 1000V ±(1.5%+2d)
ACV	200mV ±(1.0%+3d), 2/20/200V ±(1.5%+3d), 750V ±(2.5%+4d)
DCA	200µ/2m/20m/200mA ±(1.2%+2d), 10A±(2.0%+3d)
ACA	200µ/2m/20m/200mA ±(1.5%+3d), 10A±(2.5%+5d)
Resistance	200Ω ±(1.2%+2d), 2k/20k/200k/2MΩ±(1.0%+2d), 20M Ω ±(2.5%+4d)
Battery	NEDA1604/6F22 (9V) x 1pcs(Not included)
Size	147x75x40 mm
Accessories	Test lead
Individual packing	Double blister

Reliable-perfect

Overload Protection with PTC

Diode & 2 Fuses

for both of small current and big current

  CAT III 600V CAT II 1000V  RoHS COMPLIANT



▶ **MT-1210** 3 1/2 Compact Digital Multimeter



Economic Type



1.5V Battery Test



Transistor hFE Test

CAT II 600V

User friendly interface is ideal for students, home use and DIY market.

Features

- Diode Test • Continuity Test • Transistor Test • Data Hold
- Low Battery Indication • Backlight

DCV	200mV/2V/20V/200V ±(1.0%+2d), 500V ±(1.2%+5d)
ACV	200/500V ±(2.5%+10d)
DCA	200µ/2mA/20mA/200mA ±(2.0%+5d) 10A ±(3.0%+5d)
Resistance	200Ω/2K/20K/200KΩ ±(1.0%+5d) 2MΩ ±(1.5%+5d)
Battery	9V(6F22)×1 (Not included)
Size	147 × 74 × 35mm
Accessories	Test lead
Individual packing	Blister card

▶ **MT-1233C** 3 1/2 Digital Multimeter



**Palm Size
Temperature Test**

CAT II 300V

Features

- Diode Test • Continuity Test • Data Hold • Low Battery Indication • Backlight

DCV	200m/2000m/20/200V ±(0.8%+3d), 500V ±(1.0%+3d)
ACV	200/500V ±(1.2%+5d)
DCA	2000µ/20m/200mA ±(1.2%+5d), 10A ±(2.5%+5d)
Resistance	200Ω ±(1.5%+5d), 2000/20k/200kΩ ±(1.0%+3d), 20MΩ ±(1.0%+5d)
Temperature	-40~150°C ±(1.0%+3d), 150~1000°C ±(1.5%+15d)-40~302°F(1.0%+4d), 302~1832°F ±(1.5%+15d)
Battery	1.5V AAA x 2 (Not included)
Size	130 x 72 x 28mm
Accessories	Test lead, Thermocouple probe
Individual packing	Double blister

▶ **MT-1233D** 3 1/2 Digital Multimeter



**Palm Size
High Resistance Test
Square Signal Output**

CAT II 300V

Features

- Diode Test • Continuity Test • Transistor Test Data Hold
- Low Battery Indication • Backlight

DCV	200m/2000m/20/200V ±(0.8%+3d), 500V ±(1.0%+3d)
ACV	200/500V ±(1.2%+5d)
DCA	2000µ/20m/200mA ±(1.2%+5d), 10A ±(2.5%+5d)
Resistance	200Ω ±(1.5%+5d), 2000/20k/200kΩ ±(1.0%+3d), 20MΩ ±(1.0%+5d), 200MΩ ±(1.0%(rdg-10)+10d)
Square signal output	50Hz (5 Vp-p, 50KΩ)
Battery	1.5V AAA x 2 (Not included)
Size	130 x 72 x 28mm
Accessories	Test lead
Individual packing	Double blister

Clamp Meter

What Are Clamp Meters?

Clamp meters are a very convenient testing instrument that permit current measurements on a live conductor without circuit interruption. When making current measurements with the general multimeter, we have to cut wiring and connect the instrument to the circuit for testing, however, we can measure current by simply clamping on a conductor as illustrated with clamp meter as shown in Fig.1. Using a clamping meter is easy way that we can even measure a large current without shutting off the circuit being tested.

Clamp Meter Operation

Clamp meter permit to measure current by simply clamping on a conductor without shutting off the circuit being tested, even measure a large current. When making current measurements by an analogue multimeter or digital multimeter, we have to cut wiring and connect the instrument to the circuit for testing. Using a clamp meter, only one conductor is normally passed through the probe; if more than one conductor were to be passed through, the measurement will be very misleading. For measuring current using a clamp meter, clamp one conductor(wire) to be measured. If two wires(parallel lines) are clamped, current measurement cannot be made. Take a measurement at the center of the core of the clamped portion to minimize measuring errors. A line separator is conveniently used in measuring the consumption current of home electric appliances. There are line separators that can amplify measured current 10 times to allow measurement by amplifying current lower than 1A. When DC current(DCA) is measured using a clamp meter for DC current, the current is indicated in a negative value when the direction of the current is reversed. With this function, you could know what situation of your car battery, charge? Or discharge?

How to Measure DC Current

Clamp on to a conductor just the same way as with AC current measurement using an AC current clamp meter. In the case of DC clamp meters the reading is positive (+) when the current is flowing from the upside to the underside of the clamp meter.



Refer to P18

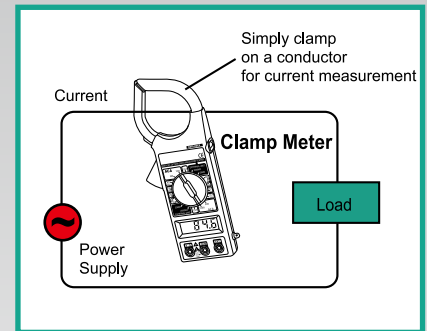

Fig.1 Using clamp meter

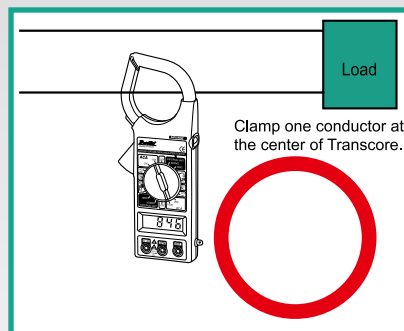

Fig.2 Correct measurement

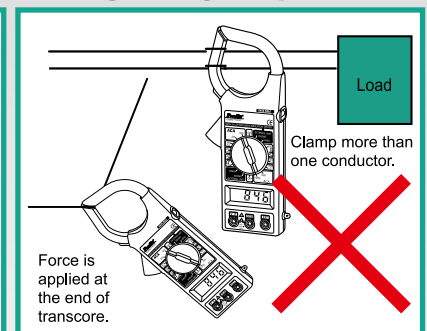
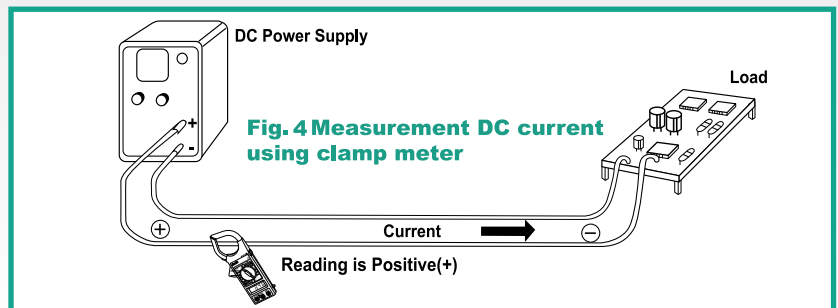

Fig.3 Wrong measurement



▶ MT-3110 3 5/6 Smart Digital Clamp Meter

▶ MT-3109 3 3/4 AC/DC Digital Clamp Multimeter

CAT III 600V  

CAT II 1000V  



Max. jaw opening:
25mm

One Key
measurement

Auto Selection
smart operation

Dual Display

Simultaneous Measurement



Max. jaw opening:
30mm

Capacitance
measurement

Frequency
measurement

**AC/DC Current/
Voltage** Measurement



Non contact ACV detector



Simultaneous measurement



DCA measurement



ACA measurement

Features

- NCV Detection • Diode Test • Continuity Test • Transistor Test • Data Hold • Low Battery Indication • Backlight

ACA	6A /60A/400A±(2.5%+8d), 600A±(3.0%+10d), PEMAX: 900A ±(10%+10d)
ACV	6V /60V/600V ±(0.8%+5d)
DCA	6V /60V/600V ±(0.5%+3d)
Accuracy	0.5% best accuracy
Resistance	6K/60K/600K/6M/10MΩ ±(0.8%+3d)
Frequency	10~1kHz±(1.0%+5d)
NCV	90~1000V 50/60Hz
Extra functions	Data hold, LCD backlight, Low Battery, Auto power off
Battery	1.5V AAx2 (not included)
Size	190 x 68 x 38 mm
Individual packing	Color box
Accessories	Test lead, Carry bag

Features

- Duty Cycle • Diode Test • Continuity Test • Relative Reference • Data Hold • Auto Power Off • Low Battery Indication

DCV	400m/4V ±(1.0%+3d), 40/400V ±(1.0%+1d), 600V ±(1.0%+5d)
ACV	4/40/400V ±(1.2%+5d), 600V ±(1.5%+5d)
DCA	40A ±(2.5%+5d), 400A ±(2.5%+3d)
ACA	40A ±(3.0%+8d), 400A ±(3.0%+5d)
Resistance	400Ω ±(1.2%+5d), 4k/40k/400kΩ ±(1.0%+5d), 4MΩ ±(1.2%+5d), 40MΩ ±(1.5%+5d)
Frequency	10/100/1k/10k/100k/1MHz ±(0.1%+5d), 10MHz (For reference only)
Capacitance	40n/400n/4μ/40μF ±(5.0%+10d), 100μF ±(6.0%+10d)
Accuracy	1.0% best accuracy
Battery	1.5V AAx2 (not included)
Size	203 x 68 x 33 mm
Individual packing	Double blister
Accessories	Test lead, Carry bag

▶ MT-3102 3 1/2 2A Mini Digital Clamp Meter

CAT II 600V  

Mini digital multimeter, easy and simple for one hand operation.

Max. jaw opening:
30mm

2A Small AC Current

Temperature measurement



DCA measurement



ACA measurement

▶ MT-3266 3 1/2 Hand Held Digital Clamp Meter

CAT II DC1000V AC750 V  

A good helper to test appliances with larger DCV, ACV, and ACA.

Max. jaw opening:
50mm

1000A Large current measurement



DCA measurement



ACA measurement

Features

- Diode Test • Continuity Test • Maximum Value Hold • Data Hold • Auto Power Off • Low Battery Indication

ACA	2A ±(3.0%+15d) ≤ 0.4A ±(4.0%+20d), 20A ±(2.0%+10d) ≤ 0.4A ±(3.0%+15d), 200/400A ±(2.0%+5d)
ACV	2/20/200V ±(1.2%+5d), 600V ±(1.5%+5d)
DCV	200mV ±(0.8%+5d), 2/20/200V ±(0.8%+3d), 600V ±(1.0%+5d)
Accuracy	0.8% best accuracy
Resistance	200Ω ±(1.2%+5d), 2k/20k/200kΩ ±(1.0%+3d), 2MΩ ±(1.2%+5d), 20MΩ ±(1.5%+5d)
Temperature	-40~0°C ±(3.0%+4d), 0~400°C ±(1.0%+3d), 400~1000°C ±(2.0%+10d) -40~32°F ±(3.0%+8d), 32~752°F ±(1.0%+6d), 752~1832°F ±(2.0%+18d)
Battery	1.5V AAAx3 (not included)
Size	203 x 68 x 33 mm
Individual packing	Double blister
Accessories	Test lead, Thermocouple probe

Features

- Continuity Test • Data Hold • Low Battery Indication

ACA	200/1,000A ±(3.0%+5d)
ACV	750V ±(1.2%+4d)
DCA	1,000V ±(0.8%+2d)
Accuracy	0.8% best accuracy
Resistance	200Ω ±(1.0%+3d), 20kΩ ±(1.0%+1d)
Battery	NEDA1604/6F22 (9V) x 1pcs(Not included)
Size	230 x 70 x 37 mm
Individual packing	Double blister
Accessories	Test lead

MT-2017 Protective Function Analog Multimeter

Overload Protection, Gilded Test Leads, Null DCV

CAT II 1000V **CAT III 500V** **CE** **RoHS COMPLIANT**



Gilded test leads

Attached 1000V 10A gilded test lead, more stable and reliable

- Comes with foldable stand and hook-up design for convenient use.
- Separately 9V and 1.5V batteries cases, replace battery or fuse more easily.
- Overload protection with two fuses 0.5A & 10A ensures uninterrupted operation and long lifetime.

Features

- Transistor hFE Test • Diode Test • LED Test • Continuity with beeper

DCV	0.1/2.5/10/50/250V ±3.0%FSD, 1000V ±4.0%FSD
Null DCV	DC ± 5V / ±25V ±5.0%FSD
ACV	10/50/250V ±4.0%FSD, 1000V±5.0%FSD
DCA	50μ/2.5m/25m/250mA ±3.0%FSD, 10A ±4.0%FSD
Resistance	×1(0.2~2kΩ) / ×10(2~20kΩ) / ×100(20~200kΩ) / ×1k(200~2MΩ) / ×10k(2k~20MΩ) ±4.0%ARC of scale length
Capacitance	C(R×1k): 2000μF(Approx.) Max
Battery check	1.5V/9V
Battery	1.5V AAA x 2pcs and 9V(NEDA1604) x 1pce (Not included)
Size	171x108x37 mm
Individual packing	Color box

MT-2018 Protective Function Analog Multimeter

CAT II 1000V **CE** **RoHS COMPLIANT**



- Overload and mis-used protection via two fuses, oxide varactor & diodes.
- Robust protective holster alongside.
- 20kΩ/V DC & 9 kΩ/V AC input sensitivity.
- Adjustable back tilt device with hook-up design.
- Ideal for using in the fields of lab, school, home applications.

Features

- Transistor hFE Test • Diode Test • LED Test

DCV	0.1/0.5/2.5/10/50/250V ±3.0%FSD, 1000V ±4.0%FSD
ACV	10/50/250V ±4.0%FSD, 1000V±5.0%FSD
DCmA	50μA/2.5mA/25mA/250mA ±3.0%FSD
Resistance	×1(0.2~2kΩ) / ×10(2~20kΩ) / ×100(20~200kΩ) / ×1k(200~2MΩ) / ×10k(2k~20MΩ) ±4.0%ARC
Capacitance	C1(R×1k): 2000μF(Approx.), C2(×50μA):0.025μF/0.25μF/25μF ±3.0%FSD(Option MT-2007-C)
Battery Check	1.5V/9V
Front Panel Controls	Range selector switch with "OFF" position, 0Ω adjust knob
Power Source	1.5V AA x 2pcs and 9V(NEDA1604) x 1pce (Not included)
Size	160 x 105 x 40 mm
Individual Packing	Color box

MT-9906 / MT-9907 Test Lead

CAT III 1000V **CE** **RoHS COMPLIANT**



- One pair (one red, one black) comfort grip probes with protective cap for user comfort and safety.
- Durable quality PVC insulated test leads with right-angle shrouded banana plugs.
- Needle tip test probe, allowing easy access of hard to reach test points.
- Compatible with most multimeters that accept safety style sheath banana plugs.

Specifications	MT-9906	MT-9907
Probe	Ø2x17mm	Ø2x17mm
Hand piece	146mm	129mm
Lead length	900mm	900mm
Plug	Ø4.2x15mm	Ø4.2x15mm
OAL	1120mm	1100mm
Weight	78.5g	74g
Individual Packing	Blister card	

Ideal for

measuring of mechanical, chemical, pottery, food, metallurgy, electric power, air condition, high- temperature heat treatment.

▶ MT-4606 Infrared Thermometer

-50 to 380°C
Distance Spot Ratio 12:1
0.10 ~ 1.00 emissivity adjustable



Features

- Auto Power Off • Low Battery Indication • Data Hold • Max. Record • Backlight

Temperature range	-50°C~380°C
Accuracy	≥ 100°C ±2%, ≤ 100°C ±2°C
Distance spot ratio	12 : 1
Emissivity	0.1~1.0
Laser class	Class II , <1mW
Response time & Wavelength	500ms / 8-14µm
Repeatability	±2°C or ±2%
Unit selection	°C/°F
Storage temperature	-20 to 50°C(-4 to 122°F)
Operation temperature	0 to 50°C (32 to 122°F)
Operation humidity	10~95%RH
Battery	9V Battery (Not included)
Size	152 x 87 x 40mm
Weight	118g (Not include battery)
Individual packing	Blister card



▶ MT-4612 Infrared Thermometer

Dual Laser for accurate aiming
-50 to 580°C
Distance Spot Ratio 16:1
0.10 to 1.00 emissivity adjustable



Features

- °C/°F Selection • Auto Power Off • Low Battery Indication • Data Hold
- Max./Min./Average/Difference Record • High/Low Temperature Alarm
- Backlight

Temperature range	-50°C~580°C(-58°F ~1076°F)
Accuracy	±2°C or ±2%°C
Laser class	Class II , <1mW
Response time & Wavelength	500ms / 8-14µm
Repeatability	±1°C or ±1%°C
Resolution	0.1°C
data memory	9 memories
Laser target point	Dual Laser / can be selected on / off
Storage temperature	-20-50°C(-4-122°F)
Operating temperature	0~50°C, 10~95%RH
Battery	6F22(9V) (not included)
Size	175 x 130 x 45mm
Weight	204g (Not include battery)
Individual packing	Double blister



▶ MT-4615 Anemometer



Air Velocity and Air Volume Measurement
One Hand Operation

Features

- Analog Bar Graphic • Variety of Units • Backlight
- Max/Min. Value • Low Battery Indication • Auto Power Off • Data Hold

Measuring range	0.8~40m/s
Accuracy	0.8~30m/s, 1.4~108km/h, 1.3~98.5ft/s, 0.8~58.3knots, 0.9~67.2mil/h, 78~5900ft/m, ±(2.0% + 50D)/30~40m/s, 108~144km/h, 98.5~131.2ft/s, 58.3~77.7 knots, 67.2~90mil/h, 5900~7874 ft/m, (only for reference)
Resolution	0.01m/s, 0.01km/h, 0.01 ft/s, 0.01knots, 0.01mile/h, 1ft/m
Unit	Air Velocity : m/s, km/h, mil/h, ft/m, ft/s, knots Air Volume : CMS (m ³ /s), CMM m ³ /min, CFM (ft ³ /min), 30~40m/s only for reference
Sensor	Conventional arm angle to the impeller
Sampling time	0.4s
Auto power off	10 minutes (adjustable)
Low battery indication	<TV
Operation environment	0~85%RH, 0°C~40°C (no condense)
Fan operation environment	0~95%RH, -20°C~80°C (no condense)
Storage environment	0~80%RH, -20°C~80°C (no condense)
Operating altitude	Max. 2000m
Power source	9V 6F22 (not included)
Dimension	170 x 85 x 40mm
Accessories	Pouch bag, user manual
Individual packing	Double blister

▶ MT-4617/MT-4617LED Light Intensity Meter



Quick Sampling Time
One Hand Operation

Features

- Auto and Manual Range • Zero Calibration • Relative Peak Value • Backlight • Max/Min. Value • Low Battery Indication • Auto Power Off • Data Hold • Over-load Indication

MT-4617

For visible light produced by fluorescent lamp, metal halide lamp, and more.

Specifications	MT-4617
Accuracy	±3% (When at 2854K calibrated in accordance with the ordinary incandescent), ±6% (when at other visible light source)
Applications	-

MT-4617LED

For all light produced by all visible colors of LED, fluorescent lamp, metal-halide lamp, and more.

Specifications	MT-4617LED
Accuracy	±3% (calibrated to standard incandescent lamp and LED at 2,854K), ±6% (calibrated at other visible light source)
Applications	For all visible light and LED white, red, yellow, green, blue, purple color

Specifications	MT-4617/MT-4617LED
Range	20, 200, 2000, 20000, 200000 Lux, 20, 200, 2000, 20000 FC
Ring spectral range	320~730nm
Unit selection	Lux, FC (Footcandles)
Sensor	Silicon photodiode
Sampling time	≥2 times/sec.
Auto power off	10 min after no use
Operation sound	Selection
Low battery indicate	<TV
Operation environment	0~85%RH • -10~50°C (no condense)
Storage environment	0~70%RH • -10~50°C (no condense)
Operating altitude	Max. 2000m
Power source	9V (Not included)
Dimension	170x85x45mm
Accessories	Storage bag, instruction manual
Individual packing	Double blister

▶ MT-4616 Temperature / Humidity / Dew Point Meter



Temperature range	-20~60°C(-4°F~140°F)
Temperature accuracy	±1°C(0~45°C), ±1.5°C(-20~0°C, 45~60°C)
Humidity range	0~100%RH
Humidity accuracy	±3%(20%~80%), ±4%(0~20%, 80%~100%)
Wet Bulb temperature range	-20~60°C(-4~140°F)
Wet bulb temperature accuracy	±1°C(0~45°C), ±1.5°C(-20~0°C, 45~60°C)
Dew point range	-50~60°C(-58~140°F)
Dew point accuracy	±1°C(0~45°C), ±1.5°C(-50~0°C, 45~60°C)
Resolution	0.1°C/°F ; 0.1%
Data memory	Max. 99 of data
Unit selection	°C / °F
Auto power off	After 30mins, on/off selection
Power source	AAA 1.5V x 4 (Not included)
Dimension	184 x 60 x 29mm
Accessories	Storage bag, Instruction manual
Individual packing	Double blister

3 Temperature Types Measurement
User-Friendly Design

Features

- 99 Data Memories • °F/°C selection • Max./Min. Value • Low Battery Indication • Auto Power Off • Backlight • Data Hold



▶ MT-4618 Sound Level Meter



Range	30—130dBA, 35—130dBC 30—80db, 40—90db, 50—100db, 60—110db, 70—120db, 80—130db, 30—130 db is auto range
Accuracy	±1.5dB (94dB@1KHz), ±5dB (94dB@8KHz)
Resolution	0.1dB
Response frequency	30Hz — 8KHz
Dynamic sound pressure	50 dB (at each range) FAST 125ms, SLOW 1sec
Frequency weighting	A and C type
Sensor	Polarized condenser microphone
Sampling time	2 times/sec., Analog 20 times/sec.
Operating environment	10~80%RH, 0°C~40°C (Non-condensing)
Storage environment	10~70%RH, -10°C~60°C (Non-condensing)
Low battery indication	<5V
Power source	1.5V AAA battery x 4 (Not included)
Dimension	174 x 60 x 29mm
Accessories	Storage bag, Instruction manual
Individual packing	Double blister

A&C Weighting Network Selection

Wide Range High Accuracy

Features

- Max./Min.value • Data Hold • Auto Range • Auto power off • Backlight • Good Anti-interference Performance



▶ NT-316 Mini Digital Temperature Humidity Meter



5 in 1
multifunctions

Combination of Temperature, Humidity, Clock, Alarm clock, Snooze & Calendar.



Magnetic clip or desk-topstand support

Features

- Large Display with Backlight • 12-Hour/24-Hour Display Selection
- Max./Min. Temp. & Humidity Memory • Magnetic Clip or Desk-Top Stand Support • 8-Minutes Snooze • °C / °F Switch

Temperature range	-10°C to +50°C, +14°F to +122°F, ±1°C (±1.8°F)
Relative humidity range	10% to 95%RH, ±5%RH
Temp. & humidity value capture	10 Secs
Material	ABS
Battery	2 x AAA batteries (not included)
Size	67 x 67 x 28mm
Individual packing	Blister card

▶ NT-311 / NT-312 Digital Temperature Humidity Meter



5 in 1
multifunctions

- Temperature • Humidity
- Clock • Alarm Colck • Calendar

Features

- LCD Display • 12-Hour/24-Hour Display • Max./Min. Temp. & Humidity Memory • Wall Hanging or Desk-Top Stand Support • 8-Minutes Snooze • °C / °F Switch



NT-311
Indoor

NT-312
Indoor & Outdoor

Specifications	NT-311	NT-312
Temperature range	-10°C to +50°C 14°F to +122°F	Indoor: -10°C to +50°C (14°F to +122°F) ±1°C (±1.8°F) Outdoor: -50°C to +70°C (-58°F to +158°F) ±1°C (±1.8°F)
Humidity range	20%RH to 90%RH	
Accuracy	±1°C (±1.8°F) / ±5%RH	
Resolution	0.1°C (0.1°F) / 1% RH	
Battery	1 x AAA battery (not included)	
Dimension	97 x 94 x 23.5mm	
Individual packing	Blister card	

▶ NT-6352 3 in 1 Metal Voltage Stud Detector



Easy, Fast and Accurate
LED & Buzzer Dual Indication

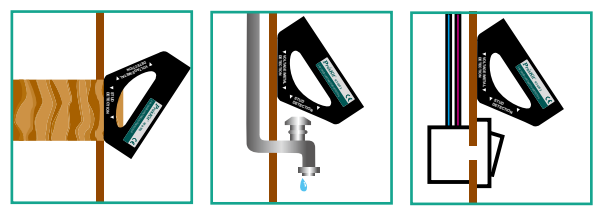

Depth penetration	18~20mm (0.7 to 0.8 inches)
Battery	NEDA1604/6F22 (9V) x 1pcs(Not included)
Size	178 x 120 x 34.7mm
Individual packing	Color box

▶ NT-8540 / NT-8560 / NT-8580 Laser Distance Measurer

Ideal for measuring factory layout, facilities safety area, trench depth for solar installation, building maintenance, ceilings maintenance, road works, water level, sheet rock measurement.



IP54
IEC/EN 60529



80M
measurement



40M
measurement



60M
measurement



Accessory: Pouch bag



Features

- Area, Volume, Pythagorean Measurement • LCD Display • Fold-Out Extension • Auto Power Off • Continuous Measurement • Min/Max Measurement • Low Battery Indication

Integrated Multi-measuring Functions

Area, Volume, Pythagorean measurement allows easy measuring in any different applications.

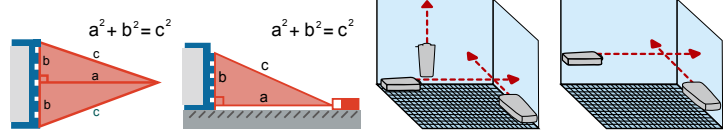

Fold-out Extension

At bottom provides more convenient with reference point.

Extra Side Key

One touch extra side key for using easily and quickly.

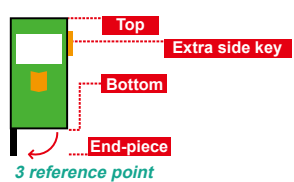

Model No.	NT-8540	NT-8560	NT-8580
Measuring range	0.2~40M	0.2~60M	0.2~80M
Measuring accuracy	±1.5mm		
LCD display	4-line display with backlight		
Measuring functions	Length / Area / Volume		
Pythagorean 1	Yes		
Pythagorean 2	Yes		
Add/Subtraction	Yes		
Data memory	20 record		
Unit selection	M / ft / in / ft+in		
Beep indication	Yes		
Auto laser power off	30s		
Laser class	Class 2		
Laser power	635 nm≤1mW		
Operation temperature	0°C~40°C		
Storage temperature	-10°C~60°C		
Power source	2 x 1.5V AAA batteries (not included)		
Weight	113g (not including battery)		
Dimension	115 x 52 x 32.5		
Individual packing	Color box		

▶ NT-309 Smart Non-Contact Voltage Tester



CAT III 1000V
safety rating
AC 12 -1000 V
Detection



Voltage Level Indication

Features

- Compact Size with Pocket
- Voltage Level Indication
- Non-Conductive Outer Surface
- LED Illumination Light



Neutral test NCV detection LED light

Test Voltage range	12V~1000VAC, 50/60Hz
Auto power off	3 minutes
Alarm system	Flashing LED with Beeper alarm
Power	2 x 1.5V AAA (Not included)
Overall length	156mm
Weight	35g
Individual packing	Blister card

▶ NT-306 Non-Contact Voltage Detector



CAT IV 1000V
safety rating
AC 90 -1000 V
Detection



Features

- Compact Size with Clip Design
- LED Illumination Light
- Non-conductive Outer Surface

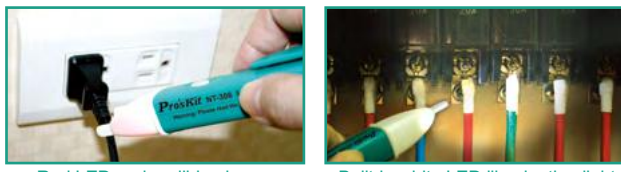

Red LED and audible alarm Built-in white LED illumination light

Test Voltage range	90V-1000V AC voltage
Handle material	ABS
Alarm system	LED light and beeper alarm
Power	2 x 1.5VAAA(not included)
Overall length	153mm
Individual packing	Blister card

▶ NT-303 Non-Contact Voltage Tester



AC 90 -240 V
Detection



Features

- Compact Size with Pocket
- Dual Alarm System

Test voltage range	90V-240V AC voltage
Handle material	ABS
Alarm system	LED light and beeper alarm
Power	2 x 1.5VAAA (not included)
Overall length	150mm
Accessory	Small screwdriver
Individual packing	Blister card

▶ NT-305 Voltage Detector

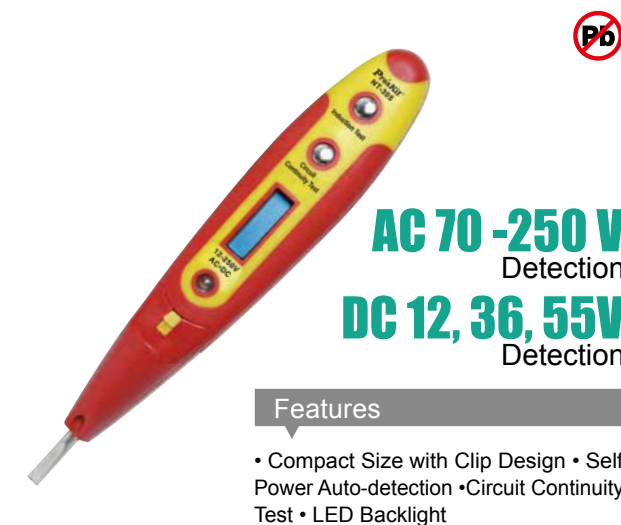

AC 70 -250 V
Detection
DC 12, 36, 55V
Detection



Features

- Compact Size with Clip Design
- Self Power Auto-detection
- Circuit Continuity Test
- LED Backlight

Test voltage range	70V-250V ACV 12, 36, 55 DCV
Handle material	ABS UL 940V-0
Alarm system	LED light
Power	1 x CR927(3V) x 2
Overall length	140mm
Individual packing	Blister card

TE-5305B DC Power Supply

Single Output 30V/5A, Linear Mode

Applicable for school, production line, laboratory, repair center.



Features

- Protective Design • High Quality SMD Process • Two Level Control for Current & Voltage • Auto Temperature & Radiation System Control.

Specification	Power	150W
	Display	3 digits green LED x2set
	Display error of voltage	±0.2%+2 digits
	Display error of current	±1.0%+2 digits
Constant voltage	Input voltage	AC220V ±10%, 50/60 HZ
	Output voltage	0~30V
	Line regulation	≤ 0.01%+3mV
	Load regulation	≤ 0.01%+5mV
Constant current	Ripple voltage	≤ 1.0mV(rms)
	Output current	0~5A
	Line regulation	≤ 0.2%+3mA
	Load regulation	≤ 0.2%+3mA
Others	Ripple current	3.0mA(rms)
	Weight(kg)	5.3kg
	Dimension	280x136x160mm
	Individual packing	Color box



NT-1933/NT-1934 Receptacle Testers

- Tests for correct wiring, open ground, reverse polarity, open hot, open neutral, hot on neutral, hot and ground reversed with open hot and ground fault interruption in 3-wire, 120VAC circuits.
- Proper operation GFI receptacles testing.
- Individual packing : Blister card



Light pattern indicates condition of wiring.

OPEN GROUND Ground contact not connected	OPEN NEUTRAL Neutral contact not connected	OPEN HOT Hot contact not connected
HOT/GRD REVERSE Hot and ground contacts interchanged	OPEN NEUTRAL Hot and neutral contacts interchanged	CORRECT Receptacle is wired correctly

Legend: ● Red is on ● Amber is on ● Light is off

6HP-9060 Series Oscilloscope Probe Kit

- Switchable x1/x10/x100 attenuation with reference switch positions.
- Break-resistant center conductor & wide compensation range.
- Flatter response, sharper leading edges.
- Faster rise time and replaceable cable probe head tip and ground lead.
- Max. input voltage: 300V/600V/1200V (DC-peak AC).
- Includes BNC adapter, IC tip, insulating tip & trimming tool.



Switchable series							
Model no.	Attn.	Readout	Input impedance	Band width	Rise time	Max input	Compensation range
6HP-9060	x1	No	1M ohm 128pF	DC to 6 MHz	58 ns	600V DC	NA
	x10		10M ohm 23pF	DC to 60 MHz	5.8 ns	600V DC	20 to 45 pF
6HP-9100	x1		1M ohm 60 pF	DC to 6 MHz	58 ns	300VDC	N/A
	x10		10M ohm 17 pF	DC to 100 MHz	3.5 ns	600VDC	10 to 35pF
6HP-9150	x1		1M ohm 60 pF	DC to 6 MHz	58 ns	300VDC	NA
	x10		10M ohm 17 pF	DC to 150 MHz	2.3 ns	600VDC	10 to 35pF
6HP-9250	x1		1M ohm 60 pF	DC to 6 MHz	58 ns	300VDC	NA
	X10		10M ohm 17 pF	DC to 250 MHz	1.4 ns	600VDC	10 to 35pF
6HP-9258	x100		100M ohm 5.5 pF	DC to 250 MHz	1.4 ns	1200VDC	10 to 35pF
Readout series							
Model no.	Attn.	Readout	Input impedance	Band width	Rise time	Max input	Compensation range
6HP-9101R	x10	Yes	10M ohm 17 pF	DC to 100 MHz	3.5 ns	600VDC	10 to 35pF



6HP-9XXX Series (Standard type)

6HP-9XXX Series (With readout functions)

PRECISION PLIERS & CUTTERS

Delicate Tool for Precise Work



Pro'sKit[®]

886-2-22183233
Sales support

pk@mail.prokits.com.tw
E-mail

www.prokits.com.tw
Global website

Precision Pliers

All of **Pro'sKit**® pliers are made of high quality steel to ensure excellent performance and long life. A variety of materials are used for **Pro'sKit**® pliers, including: Middle Carbon Steel (S45C, S50C, S55C, SK7, SK5), High Carbon Steel (S60C), High Carbon Tool Steel (SAE 1085), Chrome Vanadium Steel (CrV, SAE 6168, SAE 6150), Chrome-molybdenum Vanadium Steel (SCM 440), Stainless Steel (AISI 420, 410, 420J2, 420K2).

Cutting edge shapes:

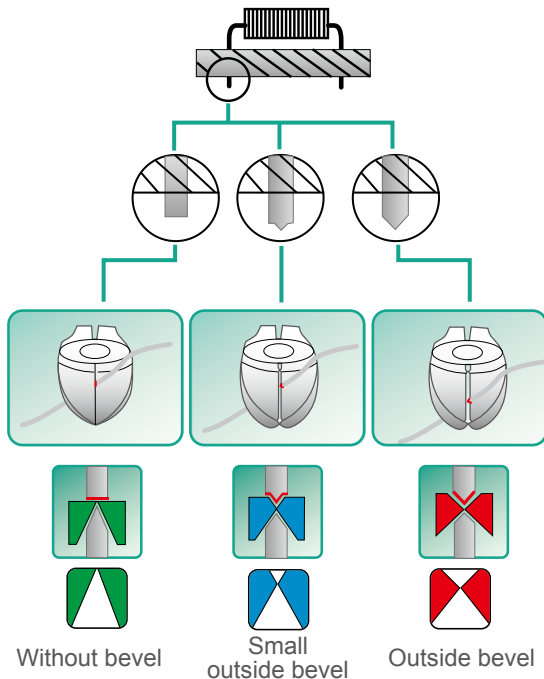

Without bevel

Without bevel: The blades of this kind cutting edge are very sharp, suited for cutting soft wire up to $\varnothing 1.0\text{mm}$ (AWG18).

Small outside bevel

Small outside bevel: The blades of this kind is suited for cutting soft wire, copper wire from $\varnothing 0.6\text{mm}$ to $\varnothing 1.2\text{mm}$ (AWG20 to 16).

Outside bevel

Outside bevel: The blades of this kind is suited for cutting thick copper wire or hard iron wire from $\varnothing 0.8\text{mm}$ to $\varnothing 1.6\text{mm}$ (AWG20 to 14) or heavy duty pins.



Basic shapes of jaws

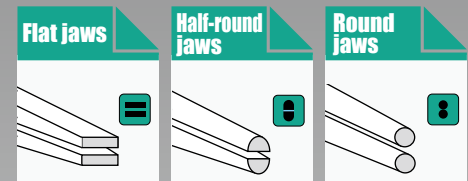

Flat jaws:

For gripping and holding flat or square objects for making angular bends.

Half-round jaws:

For holding objects, pulling wires, and bending wires.

Round jaws:

For making bends, loops, circles, coils from wire or sheet metal.

Gripping surfaces



Serrated:

Provide a good grip; but not suitable for jewelry as it may be marred because of excessive force.

Crosswise serrated:

Provide the best grip, suited for pulling and cutting heavy duty metal wires whatever in horizontal or vertical angles but may cause abrasion under excessive force.

Smooth:

Suited for flattening wire, flattening pins and precision assembly work.

Safety Caution

- When using cutting pliers, please wear protective goggles and gloves and beware of wire ends flying off.
- Each tool should only be used for its specified purpose.
- Only handles marked with the symbol  are insulating.

Pro'sKit®

886-2-22183233
Sales support

pk@mail.prokits.com.tw
E-mail

www.prokits.com.tw
Global website

Micro Cutting Plier

- Particularly made for electronic and precision field
- Clean and smooth cutting
- Light weight for easy operation

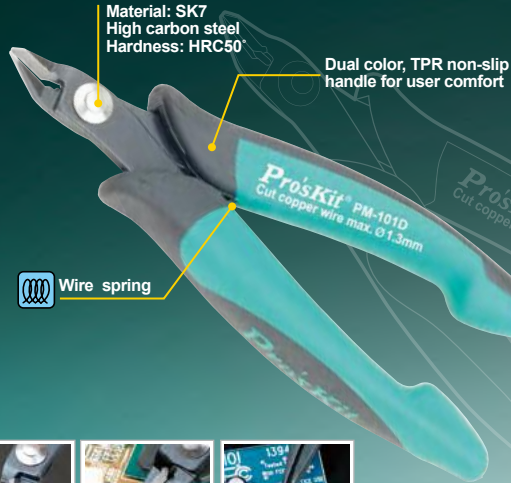

Individual packing: Blister card

PM-25PD Micro Cutting Plier

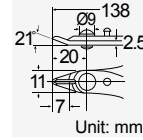

Material	HRC		Application Copper	OAL. (mm)
	Body	Cutting edge		
SK7	50°±3°	50°±3°	Ø 1.3mm	138

PM-25PD-C Micro Cutting Plier



Safety clip

design prevents flying leads.

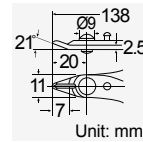

Material	HRC		Application Copper	OAL. (mm)
	Body	Cutting edge		
SK7	50°±3°	50°±3°	Ø 1.3mm	138

PM-30D Micro Cutting Plier

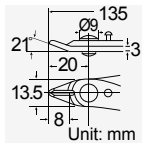

Material	HRC		Application Copper	OAL. (mm)
	Body	Cutting edge		
SK7	50°±3°	50°±3°	Ø 1.6mm	135

PM-101D Micro Cutting Plier

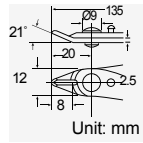

Material	HRC		Application Copper	OAL. (mm)
	Body	Cutting edge		
SK7	50°±3°	50°±3°	Ø 1.3mm	135

PM-5101 Heavy Duty Cutting Plier

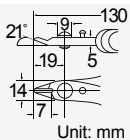

Material	HRC		Application Copper	OAL. (mm)
	Body	Cutting edge		
S50C	50°±3°	50°±3°	Ø 2.0mm	130

PM-5101-C Heavy Duty Cutting Plier



Safety clip

design prevents flying leads.

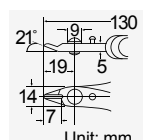

Material	HRC		Application Copper	OAL. (mm)
	Body	Cutting edge		
S50C	50°±3°	50°±3°	Ø 2.0mm	130

CP-3002D Precision Wire Stripper

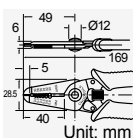

Material	HRC	Application	OAL. (mm)
SK7	50°±3°	AWG:20, 18, 16, 14, 12, 10 / 0.8, 1.0, 1.3, 1.6, 2.0, 2.6mm	169

CP-3001D Precision Wire Stripper

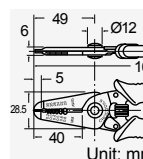

Material	HRC	Application	OAL. (mm)
SK7	50°±3°	AWG:30, 28, 26, 24, 22, 20 / 0.2, 0.3, 0.4, 0.5, 0.6, 0.8mm	169

▶ 8PK-101D Micro Cutting Plier

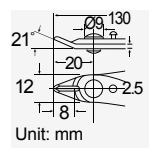

Material	HRC		Application	OAL. (mm)
	Body	Cutting edge		
SK7	50 \pm 3°	50 \pm 3°	Ø 1.3mm	130

▶ 8PK-102D Long Nose Plier

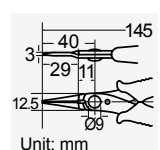

Material	HRC		OAL. (mm)
	Body		
SK7	50 \pm 3°		145

▶ 8PK-104D Flat Nose Plier

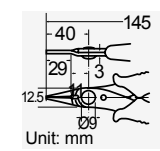

Material	HRC		OAL. (mm)
	Body		
SK7	50 \pm 3°		145

▶ 8PK-25PD-C Micro Cutting Plier



Safety clip

design prevents flying leads.

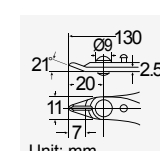

Material	HRC		Application	OAL. (mm)
	Body	Cutting edge		
SK7	50 \pm 3°	50 \pm 3°	Ø 1.3mm	130

▶ 8PK-30D Micro Cutting Plier

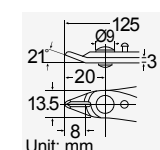

Material	HRC		Application	OAL. (mm)
	Body	Cutting edge		
SK7	50 \pm 3°	50 \pm 3°	Ø 1.6mm	125

Micro Cutting Plier

- Clean and smooth cutting
- Light for easy operation
- Particularly made for electronic and precision field
- Cut copper wire only

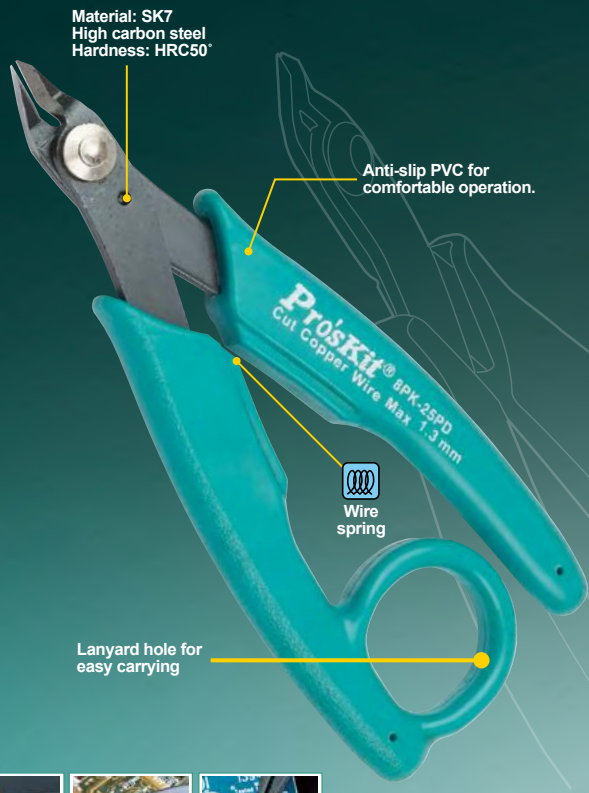

Individual packing: Blister card

▶ 8PK-25PD Micro Cutting Plier

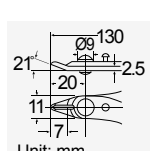

Material	HRC		Application	OAL. (mm)
	Body	Cutting edge		
SK7	50 \pm 3°	50 \pm 3°	Ø 1.3mm	130

▶ 8PK-105D Bent Nose Plier

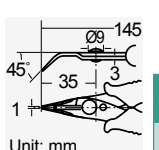

Material	HRC		OAL. (mm)
	Body		
SK7	50 \pm 3°		145

Specialty Electronic Pliers Conductive Handle



- Made from high carbon steel. Accurately machined, these high quality precision tools are designed for fine assembling and adjustment operations on electronic circuits.
- Provide easy work on high density PC board
- Conductive handle



Individual packing: Blister card

▶ 1PK-209 Clean Cut Micro Nipper

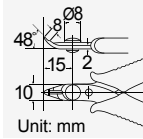

Material	HRC		Application	OAL. (mm)
	Body	Cutting edge		
SK7	50'±3'	50'±3'	Ø 0.6mm Copper	120

▶ 1PK-210 Clean Cut Micro Nipper

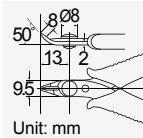

Material	HRC		Application	OAL. (mm)
	Body	Cutting edge		
SK7	50'±3'	50'±3'	Ø 0.6mm Copper	120

▶ 1PK-211 Clean Cut Micro Nipper

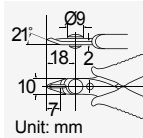

Material	HRC		Application	OAL. (mm)
	Body	Cutting edge		
SK7	50'±3'	50'±3'	Ø 0.8mm Copper	120

▶ 1PK-30-E Micro Cutting Plier

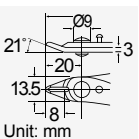

Material	HRC		Application	OAL. (mm)
	Body	Cutting edge		
SK7	50'±3'	50'±3'	Ø 1.6mm Copper	125

▶ 1PK-101-E Micro Cutting Plier

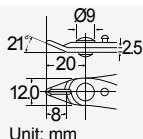

Material	HRC		Application	OAL. (mm)
	Body	Cutting edge		
SK7	50'±3'	50'±3'	Ø 1.3mm Copper	130

▶ 1PK-25P-E Micro Cutting Plier

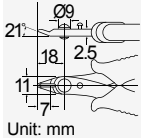

Material	HRC		Application	OAL. (mm)
	Body	Cutting edge		
SK7	50°±3°	50°±3°	Ø 1.3mm	130

▶ 1PK-5101-E Heavy Duty Cutting Plier

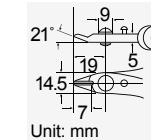

Material	HRC		Application	OAL. (mm)
	Body	Cutting edge		
S50C	50°±3°	50°±3°	Ø 2.0mm	125

▶ 1PK-25P-CE Micro Cutting Plier



Safety clip
design prevents flying leads.

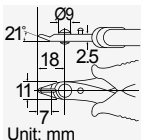

Material	HRC		Application	OAL. (mm)
	Body	Cutting edge		
SK7	50°±3°	50°±3°	Ø 1.3mm	130

▶ 1PK-5101-CE Heavy Duty Cutting Plier



Safety clip
design prevents flying leads.

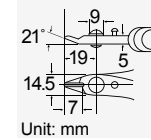

Material	HRC		Application	OAL. (mm)
	Body	Cutting edge		
S50C	50°±3°	50°±3°	Ø 2.0mm	125

▶ 1PK-102-E Long Nose Plier

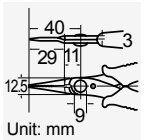

Material	HRC		OAL. (mm)
	Body		
SK7	50°±3°		145

▶ 1PK-105-E Bent Nose Plier

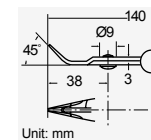

Material	HRC		OAL. (mm)
	Body		
SK7	50°±3°		145

▶ 1PK-104-E Flat Nose Plier

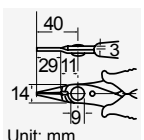

Material	HRC		OAL. (mm)
	Body		
SK7	50°±3°		145

▶ 1PK-5102-E Heavy Duty Long Nose Plier

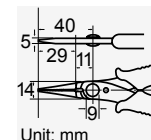

Material	HRC		OAL. (mm)
	Body		
S50C	50°±3°		140

PM-107C/PM-107 Micro Cutting Pliers



- Clean and smooth cutting
- Light for easy operation
- Particularly made for electronic and precision field

Made of high quality carbon steel
Material: SK5
Hardness: HRC50 \pm 3 $^{\circ}$



PM-107C

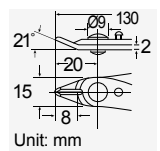

Safety clip
design prevents flying leads.



PM-107

Individual packing: Blister card



Model No.	Material	HRC		Application		OAL. (mm)
		Body	Cutting edge	Soft Steel	Copper	
PM-107	SK5	50 \pm 3 $^{\circ}$	50 \pm 3 $^{\circ}$	Ø0.8mm	Ø1.6mm	130
PM-107C				Ø0.8mm	Ø1.6mm	

8PK-101KL Heavy Duty Cutting Plier

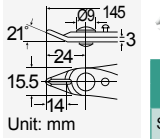

Individual packing: Blister card

Material	HRC		Application		OAL. (mm)
	Body	Cutting edge	Soft steel	Copper	
SAE 1085	55 \pm 3 $^{\circ}$	55 \pm 3 $^{\circ}$	Ø 1.2mm	Ø 2.3mm	145

8PK-101KM Heavy Duty Cutting Plier

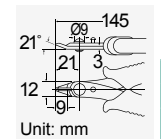

Individual packing: Blister card

Material	HRC		Application		OAL. (mm)
	Body	Cutting edge	Soft steel	Copper	
SAE 1085	55 \pm 3 $^{\circ}$	55 \pm 3 $^{\circ}$	Ø 1.2mm	Ø 2.3mm	145

8PK-101K Micro Cutting Plier

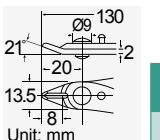

Individual packing: Blister card

Material	HRC		Application		OAL. (mm)
	Body	Cutting edge	Soft steel	Copper	
SK5	50 \pm 3 $^{\circ}$	55 \pm 3 $^{\circ}$	Ø 0.8mm	Ø 1.6mm	130

PM-108 Micro Cutting Plier

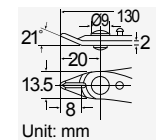

Individual packing: Blister card

Material	HRC		Application		OAL. (mm)
	Body	Cutting edge	Copper		
SK5	50 \pm 3 $^{\circ}$	55 \pm 3 $^{\circ}$	Ø 1.6mm		130

PA-101 Micro Cutting Plier

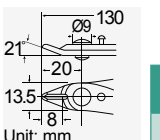

Individual packing: Blister card

Material	HRC		Application		OAL. (mm)
	Body	Cutting edge	Copper		
65Mn	50 \pm 2 $^{\circ}$	50 \pm 2 $^{\circ}$	Ø 1.3mm		130

PA-102 Long Nose Plier

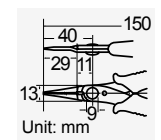

Individual packing: Blister card

Material	HRC	OAL. (mm)
65Mn	Body 48 \pm 3 $^{\circ}$	150

PM-396F Stainless Cutting Plier

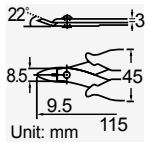

Material	HRC	Application	OAL. (mm)
AISI 420	48 \pm 3 $^{\circ}$	Copper \varnothing 1.3mm	115

PM-396K Stainless Cutting Plier



Super Slim

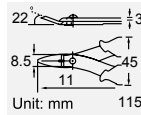

Material	HRC	Application	OAL. (mm)
AISI 420	48 \pm 3 $^{\circ}$	Copper \varnothing 0.1-1.0mm	115

PM-396H Stainless Flat Nose Plier

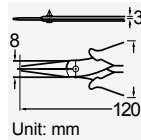

Material	HRC	OAL. (mm)
AISI 420	43 \pm 3 $^{\circ}$	120

PM-396I Stainless Bent Nose Plier

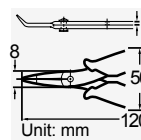

Material	HRC	OAL. (mm)
AISI 420	43 \pm 3 $^{\circ}$	120

Stainless Specialty Electronic Pliers



- Made of AISI 420 stainless steel which assure cleanliness and corrosion-resistance.
- Dual color non-slip TPR handles for user comfort.
- Polyoxymethylene (POM) spring for self-opening action to supply smooth operation.



Individual packing: Blister card

PM-396G Stainless Long Nose Plier

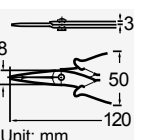

Material	HRC	OAL. (mm)
AISI 420	43 \pm 3 $^{\circ}$	120

Stainless Specialty Electronic Pliers



- Made from high quality stainless steel
- Range of high quality cutter and pliers designed to reliable service in production

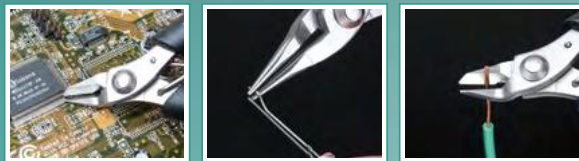

Individual packing: Blister card

▶ 1PK-501B Micro Flat Nose Plier

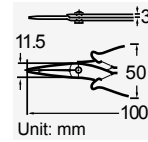

Material	HRC	OAL (mm)
	Body	48 \pm 3 $^{\circ}$

▶ 1PK-501C Micro Bent Nose Plier

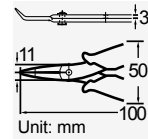

Material	HRC	OAL (mm)
	Body	48 \pm 3 $^{\circ}$

▶ 1PK-501D Micro Round Nose Plier

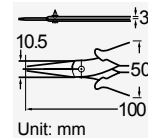

Material	HRC	OAL (mm)
	Body	48 \pm 3 $^{\circ}$

▶ 1PK-501A Micro Cutting Plier

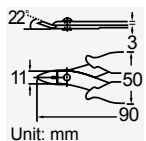

Material	HRC	Application	OAL (mm)
	Body	48 \pm 3 $^{\circ}$	Copper \varnothing 1.3mm

▶ 1PK-501E Micro Long Nose Plier

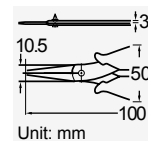

Material	HRC	OAL (mm)
	Body	48 \pm 3 $^{\circ}$

▶ 1PK-396E Straight Nose Plier

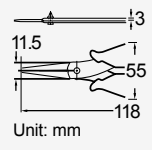

Material	HRC	OAL. (mm)
	Body	
AISI 420J2	48 \pm 3 $^{\circ}$	118

▶ 1PK-396A Cutting Plier

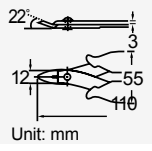

Material	HRC	Application	OAL. (mm)
	Body	Copper	
AISI 420J2	48 \pm 3 $^{\circ}$	\varnothing 1.3mm	110

Stainless Specialty Electronic Pliers



- Made from high quality stainless steel
- Range of high quality cutter and pliers designed to reliable service in production

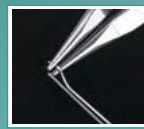

Individual packing: Blister card

▶ 1PK-396B Long Nose Plier

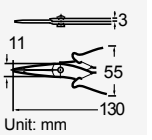

Material	HRC	OAL. (mm)
	Body	
AISI 420J2	48 \pm 3 $^{\circ}$	130

▶ 1PK-066N 2 in 1 Wire Stripper/Cutter



Material	HRC	Application	OAL. (mm)
	Body		
AISI 420J2	48 \pm 3 $^{\circ}$	Cutter: \varnothing 1.2mm Stripper: 0.4~1.6mm 2 (26~14AWG)	130

▶ PM-251 Cutting Plier

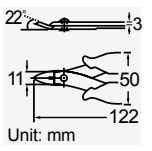

Material	HRC	Application	OAL. (mm)
	Body	Copper	
AISI 420J2	48 \pm 3 $^{\circ}$	\varnothing 1.3mm	122

▶ PM-252 Bent Nose Plier

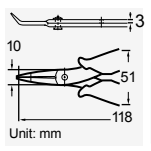

Material	HRC	Application	OAL. (mm)
	Body	Copper	
AISI 420J2	43 \sim 46 $^{\circ}$	\varnothing 1.0mm	118

Precision Stainless Steel Pliers Mirror Polished



- Made of stainless steel with mirror polished.
- Leaf springs are spot welded to the handles to fix the jaws in a comfortable position
- Forged box joint construction gives strength and precision

Induction hardened cutting edges

Mirror polished surface, no flaking, no corrosion

Forged box joint

Double leaf springs are for easy operation and user comfort

High grade alloy steel, hot drop forged, oil hardened and tempered for long life and perfect precision work

Dipped handle for user comfort

Individual packing: Blister card

▶ 1PK-24 Long Nose Plier with Teeth

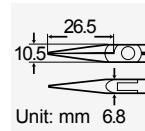

Material	HRC	OAL. (mm)
	Body	
AISI 420	45°±3°	125

▶ 1PK-25 Needle Nose Plier with Serrated

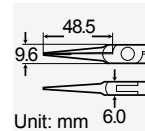

Material	HRC	OAL. (mm)
	Body	
AISI 420	48°±3°	140

▶ 1PK-26 Long Nose Plier with Smooth Jaw

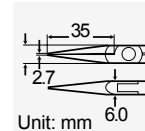

Material	HRC	OAL. (mm)
	Body	
AISI 420	48°±3°	135

▶ 1PK-20 Semi-flush Side Cutter

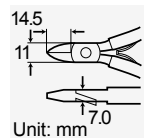

Material	HRC Body	Application			OAL. (mm)
		Hard steel	Soft steel	Copper	
AISI 420	45°±3°	Ø 0.8mm	Ø 1.3mm	Ø 2.0mm	110

▶ 1PK-22 Slim Full Flush Side Cutter

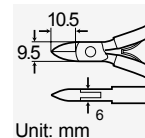

Material	HRC Body	Application			OAL. (mm)
		Hard steel	Soft steel	Copper	
AISI 420	45°±3°	Ø 0.8mm	Ø 1.3mm	Ø 1.6mm	110

▶ 1PK-21 Full Flush Side Cutter

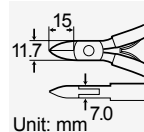

Material	HRC Body	Application			OAL. (mm)
		Hard steel	Soft steel	Copper	
AISI 420	45°±3°	Ø 0.8mm	Ø 1.3mm	Ø 2.0mm	110

▶ 1PK-23 Straight Full Flush Side Cutter

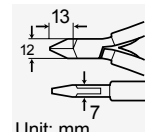

Material	HRC Body	Application			OAL. (mm)
		Hard steel	Soft steel	Copper	
AISI 420	45°±3°	Ø 0.8mm	Ø 1.3mm	Ø 2.0mm	110

▶ 1PK-27 Bent Nose Plier with Smooth Jaw

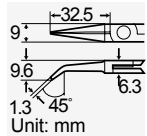

Material	HRC		OAL. (mm)
	Body		
AISI 420	48°±3°		135

▶ 1PK-34 Long Nose Plier with Teeth

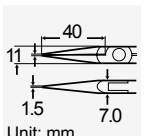

Material	HRC		OAL. (mm)
	Body		
AISI 420	48°±3°		145

▶ 1PK-28 Flat Nose Plier with Smooth Jaw

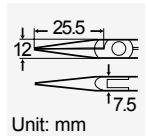

Material	HRC		OAL. (mm)
	Body		
AISI 420	48°±3°		130

▶ 1PK-244 Long Flat Nose Plier

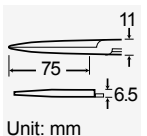

Material	HRC		OAL. (mm)
	Body		
AISI 420	48°±3°		185

▶ 1PK-29 Round Nose Plier

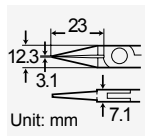

Material	HRC		OAL. (mm)
	Body		
AISI 420	48°±3°		130

▶ 1PK-291 End Flush Oblique Cutting Nipper Long Slim Tips

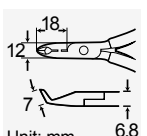

Material	HRC		Application			OAL. (mm)
	Body		Hard steel	Soft steel	Copper	
AISI 420	45°±3°		Ø 0.8mm	Ø 1.0mm	Ø 1.6mm	125

▶ 1PK-243 Long Nose Plier

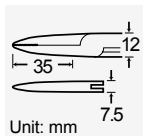

Material	HRC		OAL. (mm)
	Body		
AISI 420	48°±3°		140

▶ 1PK-239 Side Cutting Plier

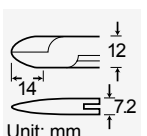

Material	HRC		Application			OAL. (mm)
	Body		Hard steel	Soft steel	Copper	
AISI 420	45°±3°		Ø 0.8mm	Ø 1.6mm	Ø 2.0mm	125

Precision Pliers with Adjustable Screw



• Made of high-quality 65CRM material, precise and durable.

Cutting edge: HRC55 \pm 2

Adjustable screw

Material: 65CRM



Leaf spring
Spring-loaded for self-opening action

Dual color, ergonomic TPR handles



Smooth surface is cut (By PM-721/PM-723)



Adjustable screw



Individual packing: Blister card

PM-720

Diagonal Semi-Flush Cutting Nipper Slim Tips

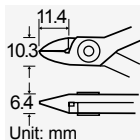

Material	HRC	Application	OAL. (mm)
	65CRM	55 \pm 2*	Copper Ø 1.3mm

PM-721

Diagonal Semi-Flush Cutting Nipper

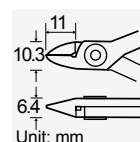

Material	HRC	Application	OAL. (mm)
	65CRM	55 \pm 2*	Copper Ø 1.3mm

PM-723

Diagonal Semi-Flush Cutting Nipper

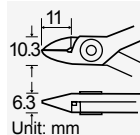

Material	HRC	Application	OAL. (mm)
	65CRM	55 \pm 2*	Copper Ø 1.3mm

1PK-258B Long Nose Plier

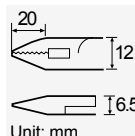

Material	HRC		Application	OAL. (mm)
	Body	Cutting edge	Copper	
S55C	43 \pm 3*	53 \pm 3*	Ø 1.0mm	138

11PK-258A Side Cutter

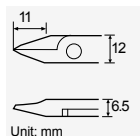

Material	HRC		Application	OAL. (mm)
	Body	Cutting edge	Copper	
S55C	43 \pm 3*	53 \pm 3*	Ø 1.0mm	125

ESD SAFE PLIERS AND CUTTERS

- Made of high-quality carbon steel with nickel plating
- ESD safe, soft touch cushioned handle provides a secure hold and comfort.
- With double leaf springs for self-opening action



PK-ST902

4 PCS Ergonomic ESD Safe Plier and Cutter Kit



9ST-43
size: 130x207x35 mm

PM-023CN Pointed Diagonal Plier

Cutting edge: HRC52'±2'

Material: Carbon steel with nickel plating, Body: HRC 43'±2'



Leaf spring

ESD safe cushioned grips for superior comfort and protection 10⁷~10⁹Ω

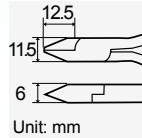

Individual packing Blister card

Material	HRC		Application			OAL. (mm)
	Body	Cutting edge	Hard steel	Soft steel	Copper	
S45C	43'±2'	52'±2'	Ø 0.8mm	Ø 1.3mm	Ø 1.6mm	115

PM-037CN Diagonal Cutting Plier

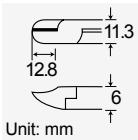

Material	HRC		Application			OAL. (mm)
	Body	Cutting edge	Hard steel	Soft steel	Copper	
S45C	43'±2'	52'±2'	Ø 0.8mm	Ø 1.3mm	Ø 1.6mm	115

PM-036CN Long Nose Plier

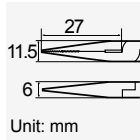

Material	HRC		Application			OAL. (mm)
	Body	Cutting edge	Hard steel	Soft steel	Copper	
S45C	43'±2'	52'±2'	Ø 0.8mm	Ø 1.3mm	Ø 1.6mm	127

PM-029CN Round Nose Plier

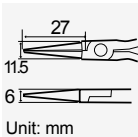

Material	HRC		OAL. (mm)
	Body		
S45C	43'±2'		127

PM-046CN Needle Nose Plier

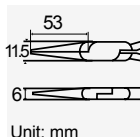

Material	HRC		OAL. (mm)
	Body		
S45C	43'±2'		150

PM-055CN Bent Nose Plier

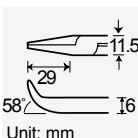

Material	HRC		OAL. (mm)
	Body		
S45C	43'±2'		127

PM-053CN Flat Nose Plier

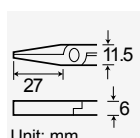

Material	HRC		OAL. (mm)
	Body		
S45C	43'±2'		127

PRECISION PLIERS & CUTTERS

Precision Pliers



- High quality carbon steel S45C forged hardened, finished with nickel plating for corrosion resistance.
- Particularly designed for electronic and precision field.

Cutting edge additionally induction-hardened, hardness of HRC50~55*



Dual color, non-slip TPR handles

Wire spring



Individual packing: Blister card

▶ PM-736 Long Nose Plier

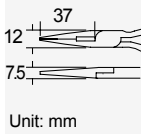

Unit: mm

Material	HRC		Application	OAL. (mm)
	Body	Cutting edge		
S45C	42±3°	50~55°	Ø 1.0mm	135

▶ PM-737 Diagonal Cutting Plier

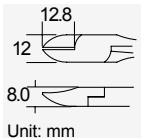

Unit: mm

Material	HRC		Application	OAL. (mm)
	Body	Cutting edge		
S45C	42±3°	50~55°	Ø 1.0mm	115

▶ PM-711 Precision Cutting Plier

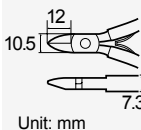

Unit: mm

Material	HRC		Application	OAL. (mm)
	Body	Cutting edge		
AISI 6140	45±3°	61±3°	Ø 2.0mm	120

▶ PM-731 Mini Lineman's Plier

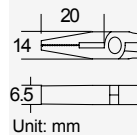

Unit: mm

Material	HRC		Application	OAL. (mm)
	Body	Cutting edge		
S45C	42±3°	50~55°	Ø 1.0mm	120

▶ PM-746 Needle Nose Plier

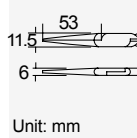

Unit: mm

Material	HRC		OAL. (mm)
	Body		
S45C	42±3°		150

▶ PM-754 Flat Nose Plier

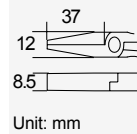

Unit: mm

Material	HRC		OAL. (mm)
	Body		
S45C	42±3°		138

▶ PM-755 Bent Nose Plier

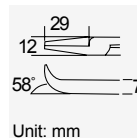

Unit: mm

Material	HRC		OAL. (mm)
	Body		
S45C	42±3°		135

▶ PM-712 Extra Long Nose Plier

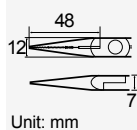

Unit: mm

Material	HRC		Application		OAL. (mm)
	Body	Cutting edge	Hard steel	Copper	
AISI 6140	45±3°	61±3°	Ø 0.8mm	Ø 2.0mm	155

▶ PM-722F Super Slim Diagonal Cutter

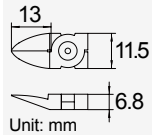

Material		HRC		Application			OAL. (mm)
Body	Handle	Body	Cutting edge	Plastic	Copper	Ø 2.0mm	
S45C	PVC	41°±3°	57°±3°				125

▶ PM-701F Micro Cutting Plier

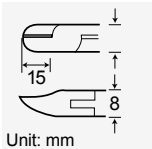

Material		HRC		Application			OAL. (mm)
Body	Handle	Body	Cutting edge	Soft steel	Copper	Ø 2.0mm	
S45C	PVC	41°±3°	57°±3°	Ø 1.3mm			114

▶ 1PK-701 Micro Cutting Plier

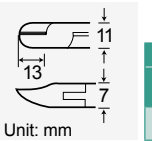

Material		HRC		Application			OAL. (mm)
Body	Handle	Body	Cutting edge	Hard steel	Soft steel	Copper	
S45C	PVC	43°±3°	53°±3°	Ø 0.8mm	Ø 1.3mm	Ø 1.6mm	105

▶ 1PK-705 Diagonal Cutting Plier

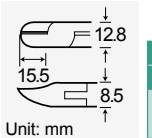

Material		HRC		Application			OAL. (mm)
Body	Handle	Body	Cutting edge	Soft steel	Copper	Ø 2.0mm	
S45C	PVC	41°±3°	57°±3°	Ø 1.3mm			128

▶ 1PK-717 Micro Diagonal Cutting Plier

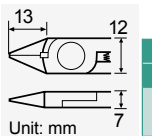

Material		HRC		Application			OAL. (mm)
Body	Handle	Body	Cutting edge	Soft steel	Copper	Ø 2.0mm	
S45C	PVC	41°±3°	57°±3°	Ø 1.3mm			124

Precision Pliers with Plastic Coated Handles

- Quality carbon steel S45C by hot drop forged.
- Cutting edge additionally hardened and tempered.



Individual packing: Blister card

▶ 1PK-702 Long Nose Plier

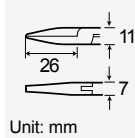

Material		HRC		OAL. (mm)
Body	Handle	Body	Body	
S45C	PVC	45°±3°		115

▶ 1PK-706 Long Nose Plier

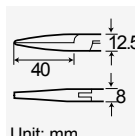

Material		HRC		Application			OAL. (mm)
Body	Handle	Body	Cutting edge	Hard steel	Soft steel	Copper	
S45C	PVC	45°±3°	48°±3°	Ø 0.8mm	Ø 1.3mm	Ø 1.6mm	135

Aerospace Steel Pliers

- Made of 55Cr-Ni steel, the same grade of aerospace steel, which is hardened and tempered for strength and long time use.
- Ergonomically shaped double injected handle for user comfort.



High leverage design
for force-saving

High quality steel
For long service life

Spring loaded
to reduce fatigue

Aerospace Steel

High quality 55Cr-Ni steel, the same grade as aerospace steel.



Individual packing: Blister card

PM-071 Flush Diagonal Cutting Plier

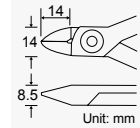

Material	HRC		Application			OAL. (mm)
	Body	Cutting edge	Hard steel	Soft steel	Copper	
55Cr-Ni	43°±3°	60°±5°	Ø 0.8mm	Ø 1.3mm	Ø 1.6mm	117

PM-072 Long Nose Plier

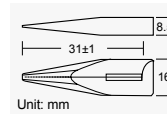
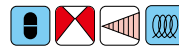

Material	HRC		Application		OAL. (mm)
	Body	Cutting edge	Hard steel	Copper	
55Cr-Ni	43°±3°	60°±5°	Ø 0.8mm	Ø 1.6mm	135

PM-073 Transverse End Cutting Plier



for 90° angle cutting

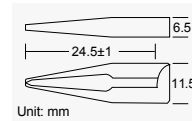

Material	HRC		Application	OAL. (mm)
	Body	Cutting edge	Copper	
55Cr-Ni	43°±3°	60°±5°	Ø 0.8mm	123

PM-905F/PM-905FHC Diagonal Cutting Plier



- Hot drop forged quality carbon steel.
- Cutting edge is additionally hardened and tempered.
- Precision cutting edge for soft wire and hard wire.
- With wire spring for self-opening action provides smooth operation.



PM-905F



Cutting edge: HRC 57°±3°
Soft steel: Ø 1.3mm
Copper: Ø 2.0mm

Wire spring for self-opening

PM-905FHC with cut lead catcher

PVC plastic coated handles

Polish finished Material : S45C Body: HRC 41°±3°

Special design with Cut Lead Catcher



Connection with vacuum

For cutting and control IC pin ends

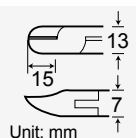

Model No.	Material	HRC		Application			OAL. (mm)
		Body	Cutting edge	Soft steel	Soft steel	Copper	
PM-905F	S45C	41°±3°	57°±3°	Ø0.8mm	Ø1.3mm	Ø2.0mm	128
PM-905FHC							

▶ 1PK-054S Flat Nose Plier

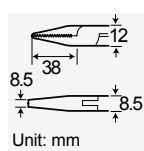

Material	HRC		OAL. (mm)
	Body	Cutting edge	
S45C	43'±3'		135

▶ 1PK-055S Bent Nose Plier

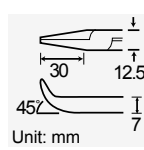

Material	HRC		OAL. (mm)
	Body	Cutting edge	
S45C	43'±3'		130

▶ 1PK-046S Needle Nose Plier

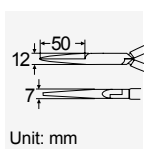

Material	HRC		OAL. (mm)
	Body	Cutting edge	
S45C	43'±3'		150

▶ 1PK-036S Long Nose Plier

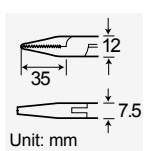

Material	HRC		Application		OAL. (mm)
	Body	Cutting edge	Hard steel	Copper	
S45C	43'±3'	48'±3'	Ø 0.8mm	Ø 1.6mm	136

Non-Slip Handles Precision Pliers



- Clean and smooth cutting
- Lightweight design for easy operation
- Particularly design for electronic and precision field

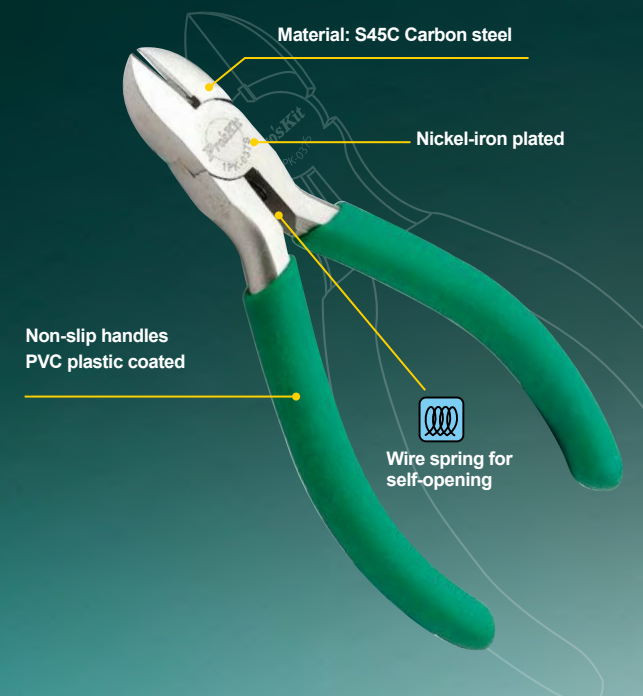

Individual packing: Blister card

▶ 1PK-037S Diagonal Cutting Plier

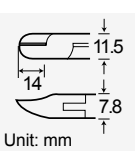

Material	HRC		Application			OAL. (mm)
	Body	Cutting edge	Hard steel	Soft steel	Copper	
S45C	43'±3'	48'±3'	Ø 0.8mm	Ø 1.3mm	Ø 1.6mm	110

▶ PM-808 Plastic Cutting Plier



• Precision design for cutting and assembly electronics, craft, mold and more. Tapered and relieved head, more thin and slim allows reaching to hard to reach area.



Special for Ø 0.3-1.3mm

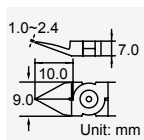

Material	Body	Handle	HRC		Application	OAL. (mm)
			Body	Cutting edge		
S60C		PVC	45'±2'	59'±2'	Ø 0.3-1.3mm	117



Tapered and relieved head super slim.

Anti-Rust Precision Pliers

- Hot drop forged from carbon steel with black oxide to prevent rust
- Hardened and tempered of all cutting edges
- With double leaf springs for self-opening action to supply smooth operation



Material:
S45C
Carbon steel



Individual packing: Blister card

1PK-256A Fine Cutter

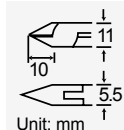

Material	HRC		Application Copper	OAL. (mm)
	Body	Cutting edge		
S45C	48°±3°	48°±3°	Ø 1.6mm	120

1PK-256B Slim Cutter

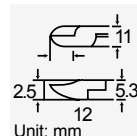

Material	HRC		Application Copper	OAL. (mm)
	Body	Cutting edge		
S45C	48°±3°	48°±3°	Ø 1.6mm	120

1PK-256C Snipe Nose Plier

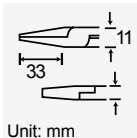

Material	HRC		OAL. (mm)
	Body	Cutting edge	
S45C	48°±3°		135

1PK-5101 Heavy Duty Cutting Plier

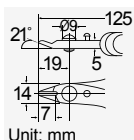

Material	HRC		Application Copper	OAL. (mm)
	Body	Cutting edge		
S50C	50°±3°	50°±3°	Ø 2.0mm	125

1PK-5101-C Heavy Duty Cutting Plier



Safety clip

design prevents flying leads.

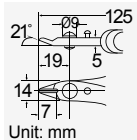

Material	HRC		Application Copper	OAL. (mm)
	Body	Cutting edge		
S50C	50°±3°	50°±3°	Ø 2.0mm	125

▶ 1PK-727 Long Nose Plier

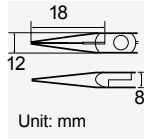
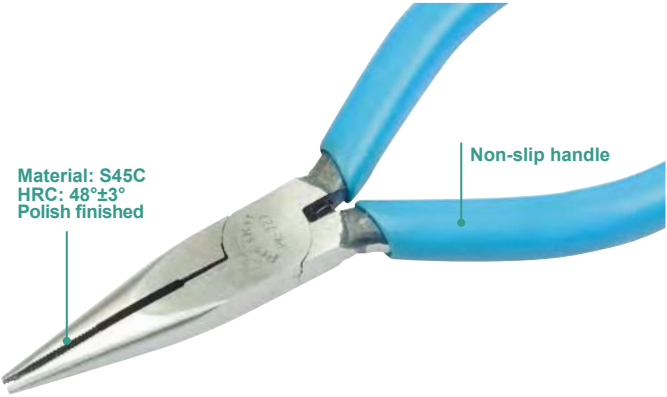

Material	HRC		OAL. (mm)	Individual packing
	Body	Cutting edge		
S45C	48°±3°		130	Blister card

▶ PM-717 Micro Cutting Plier

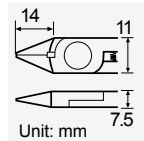
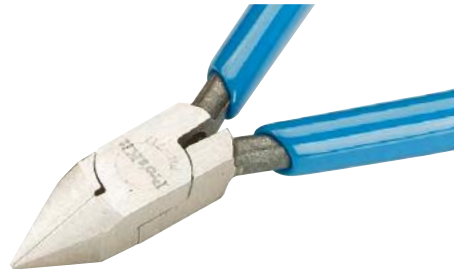

Material	HRC		Application			OAL. (mm)	Individual packing
	Body	Cutting edge	Plano Wire	Soft steel	Ø 1.2 mm		
SAE6140	45°±3°	60°±2°	Ø 1.0mm			108	Blister card

▶ PM-718 Long Nose Plier with Smooth Jaw

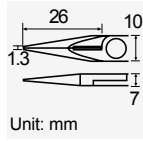

Material	HRC		OAL. (mm)	Individual packing
	Body	Cutting edge		
SAE 6140	45°±3°		118	Blister card

▶ 1PK-705Y Side Cutting Plier

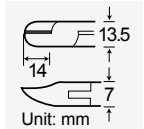

Individual packing: Blister card

Material	HRC		Application			OAL. (mm)
	Body	Cutting edge	Hard steel	Soft steel	Copper	
S45C	48°±3°		Ø 0.8mm	Ø 1.6mm	Ø 2.0mm	125

▶ 1PK-706Y Long Nose Plier

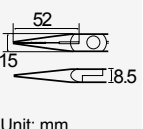

Individual packing: Blister card

Material	HRC		Application			OAL. (mm)
	Body	Cutting edge	Hard steel	Soft steel	Copper	
S45C	48°±3°		Ø 0.8mm	Ø 1.6mm	Ø 2.0mm	160

▶ 1PK-106 Heavy Cutting Plier

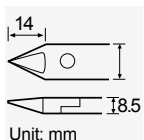

Individual packing: Blister card

Material	HRC		Application			OAL. (mm)
	Body	Cutting edge	Hard steel	Soft steel	Copper	
S45C	48°±3°	53°±2°	Ø 0.8mm	Ø 1.6mm	Ø 2.0mm	125

▶ 1PK-107 Long Nose Plier

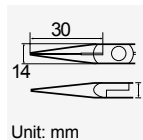
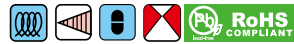

Individual packing: Blister card

Material	HRC		Application			OAL. (mm)
	Body	Cutting edge	Hard steel	Soft steel	Copper	
S45C	48°±3°		Ø 0.8mm	Ø 1.6mm	Ø 2.0mm	135

Tungsten Steel Cutters

5 times longer lifetime than traditional pliers provides

- Tungsten steel cutting edge, hardness of HRC up to 72°±2° provides high durability, long service life and anti-rust.

Tungsten carbide jaws, provide high durability
Hardness: HRC72°±2°



Black oxide finished, anti-rust
Material: SAE 6140
Hardness: HRC 45°±3°

Spring-loaded for self-opening action to supply smooth operation

High quality PVC handle provides user comfort



Individual packing: Blister card

PM-925 Tungsten Diagonal Cutting Plier

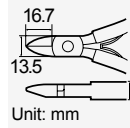

Material	HRC		Application			OAL (mm)
	Body	Cutting edge	Hard steel	Soft steel	Copper	
SAE6140+ Tungsten	45°±3°	72°±2°	Piano wire: Ø0.5mm (under HRC: 50°)	Ø 1.6 mm	Ø 2.0 mm	125

PM-955 Tungsten Diagonal Cutting Plier

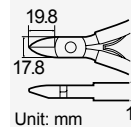

Material	Handle	HRC		Application			OAL (mm)
		Body	Cutting edge	Piano wire	Soft steel	Copper	
SAE6140+ Tungsten	PVC	45°±3°	72°±2°	Ø 0.5mm under HRC: 50°	Ø 1.6 mm	Ø 2.0 mm	130

PM-956 Tungsten Diagonal Cutting Plier

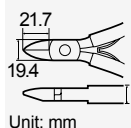
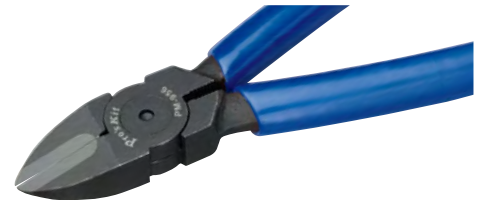

Material	Handle	HRC		Application			OAL (mm)
		Body	Cutting edge	Piano wire	Soft steel	Copper	
SAE6140+ Tungsten	PVC	45°±3°	72°±2°	Ø 0.5mm under HRC: 50°	Ø 1.6 mm	Ø 2.0 mm	160

8PK-906 Long Nose Plier

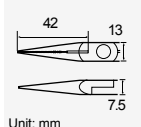

Material	HRC		Application	OAL (mm)	Individual packing
	Body	Cutting edge			
SAE 6140	48°±3°	62°±3°	Piano wire: Ø1.2mm (under HRC: 45°)	140	Blister Card

8PK-905 Cutting Plier

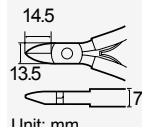

Material	HRC		Application	OAL (mm)	Individual packing
	Body	Cutting edge			
SAE 6140	45°±3°	62°±3°	Piano wire: Ø0.5mm (under HRC: 45°)	125	Blister Card

PM-811 6" Plastic Cutting Plier

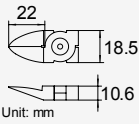

Material		HRC		Application		OAL. (mm)
Body	Handle	Body	Cutting edge	Soft steel	Copper	
CrV	PVC	45°±3°	61°±3°	Plastic	Hard steel: Ø1.2mm	155

PM-805F Plastic Cutting Plier

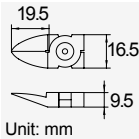

Material		HRC		Application		OAL. (mm)
Body	Handle	Body	Cutting edge	Soft steel	Copper	
S45C	PVC	41°±3°	57°±3°	Ø 1.3mm	Ø 2.0mm	130

PM-806F Plastic Cutting Plier

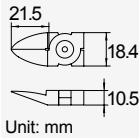

Material		HRC		Application		OAL. (mm)
Body	Handle	Body	Cutting edge	Soft steel	Copper	
S45C	PVC	41°±3°	57°±3°	Ø 1.3mm	Ø 2.0mm	159

PM-806A Plastic Oblique Cutting Plier

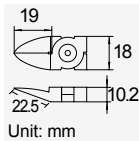

Material	HRC		Application	OAL. (mm)
	Body	Cutting edge		
S55C	45°±3°	61°±3°	Hard steel: Ø0.8mm Copper: Ø2.0mm	150

PM-806B Plastic End Cutting Plier

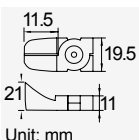
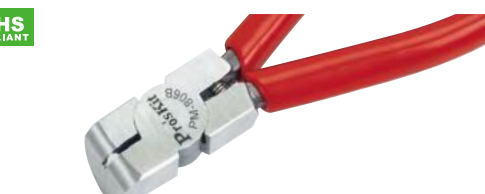

Material	HRC		Application	OAL. (mm)
	Body	Cutting edge		
S55C	45°±3°	61°±3°	Hard steel: Ø0.8mm Copper: Ø2.0mm	150

Plastic Cutting Pliers

- Perfectly mated cutter, hardened and tempered of all cutting edges.
- Specific angle designed for flush cutting sprues off plastic components or soft materials such as lead.
- Wire spring for self-opening action to supply smooth operation.

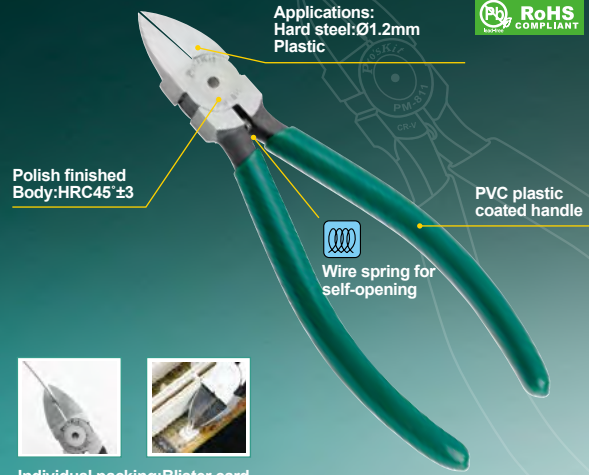

PM-805E Plastic Cutting Plier

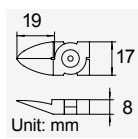

Material	HRC		Application	OAL. (mm)
	Body	Cutting edge		
S55C	45°±3°	55°±3°	Plastic	135

⚠ Plastic Cutting Only

PM-806E Plastic Cutting Plier

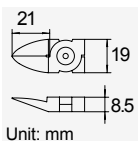

Material	HRC		Application	OAL. (mm)
	Body	Cutting edge		
S55C	45°±3°	55°±3°	Plastic	160

⚠ Plastic Cutting Only

PM-807E Plastic Cutting Plier

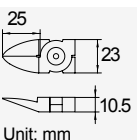

Material	HRC		Application	OAL. (mm)
	Body	Cutting edge		
S55C	45°±3°	55°±3°	Plastic	185

⚠ Plastic Cutting Only

ELECTRICAL PLIERS & CUTTERS



Sturdy, Force-Saving, makes your work easy.



Pro'sKit®

886-2-22183233
Sales support

pk@mail.prokits.com.tw
E-mail

www.prokits.com.tw
Global website

▶ 1PK-708 Side Cutting Plier

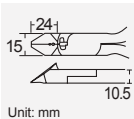
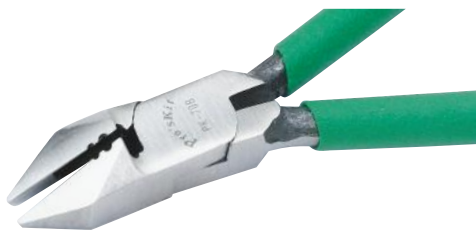

Unit: mm

Material	HRC Body	Application			OAL. (mm)
		Cutting	Stripping		
S60C	48°±3°	Ø1.6mm copper	Ø1.2 & Ø1.6mm copper		150

▶ 1PK-709 Long Nose Plier

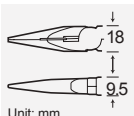

Unit: mm

Material	HRC Body	Application			OAL. (mm)
		Hard steel	Soft steel	Copper	
S60C	48°±3°	Ø1.2mm	Ø2.0mm	Ø2.6mm	160

▶ 1PK-067 Side Cutting Plier

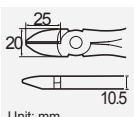

Unit: mm

Material	HRC Body	Application			OAL. (mm)
		Hard steel	Soft steel	Copper	
S60C	48°±3°	Ø1.2mm	Ø2.0mm	Ø2.6mm	160

▶ 1PK-051 Lineman's Plier

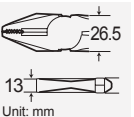

Unit: mm

Material	HRC Body	Application			OAL. (mm)
		Hard steel	Soft steel	Copper	
S60C	48°±3°	Ø1.2mm	Ø2.6mm	Ø3.2mm	210

Side Cutting Pliers

- Made from S60C, drop-forged, hardened and tempered for maximum strength and durability.

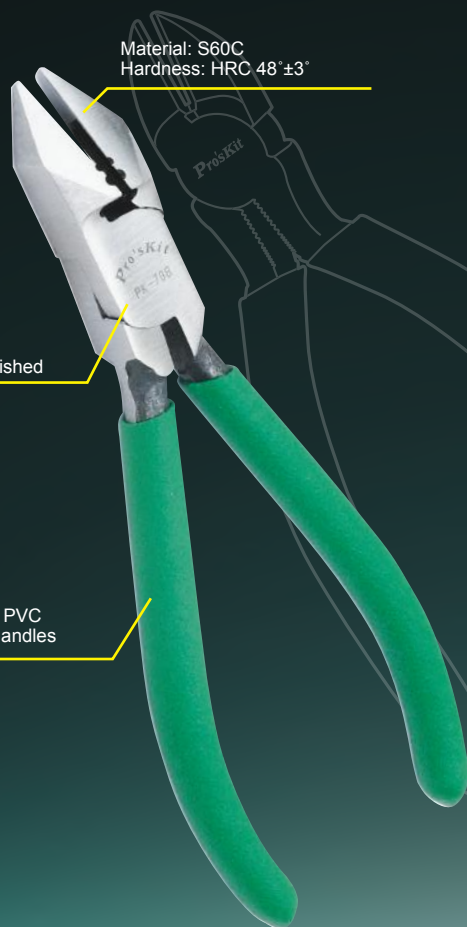

Polish finished

Non-slip PVC coated handles

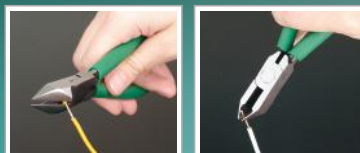

Individual packing: Blister card

▶ 1PK-052 Lineman's Plier

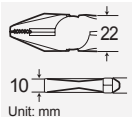
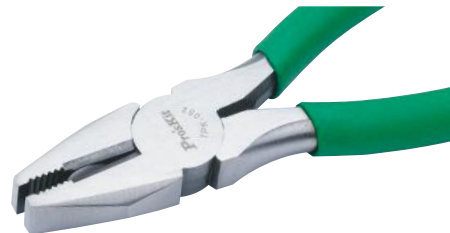

Unit: mm

Material	HRC Body	Application			OAL. (mm)
		Hard steel	Soft steel	Copper	
S60C	48°±3°	Ø1.2mm	Ø2.2mm	Ø3.0mm	165

Dual Color Lineman's Pliers

- Medium carbon steel forged
- High hardness plier mouth
- Most popular type of pliers for engineer use and home use.

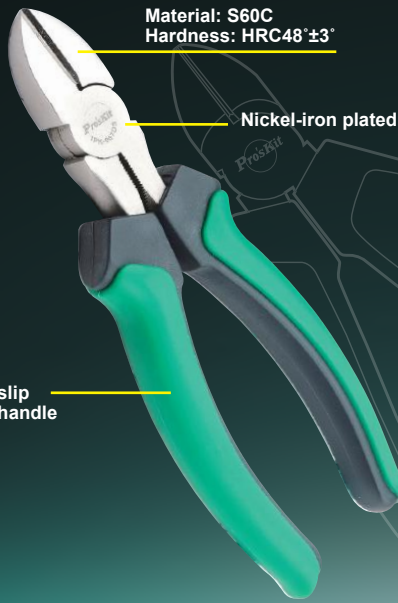

Individual packing: Blister card

▶ 1PK-067DS Dual Color Side Cutting Plier

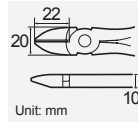

Material	HRC	Application			OAL. (mm)
	Body	Hard steel	Soft steel	Copper	
S60C	48°±3°	Ø 1.2mm	Ø 2.0mm	Ø 2.6mm	165

▶ 1PK-709DS Dual Color Long Nose Plier

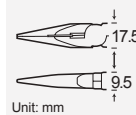

Material	HRC	Application			OAL. (mm)
	Body	Hard steel	Soft steel	Copper	
S60C	48°±3°	Ø 1.2mm	Ø 2.0mm	Ø 2.6mm	165

▶ 1PK-051DS Dual Color Lineman's Plier

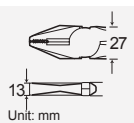
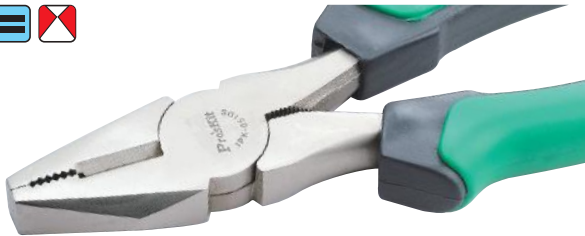

Material	HRC	Application			OAL. (mm)
	Body	Hard steel	Soft steel	Copper	
S60C	48°±3°	Ø 1.2mm	Ø 2.6mm	Ø 3.2mm	210

▶ 1PK-052DS Dual Color Lineman's Plier

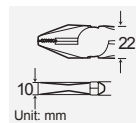
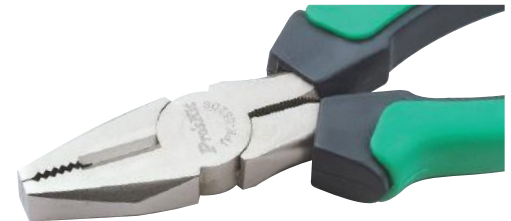

Material	HRC	Application			OAL. (mm)
	Body	Hard steel	Soft steel	Copper	
S60C	48°±3°	Ø 1.2mm	Ø 2.2mm	Ø 3.0mm	165

▶ PM-708Y Side Cutting Plier

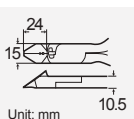

Individual packing: Blister card

Material	HRC		Application		OAL. (mm)
	Body	Cutting edge	Copper		
S55C	45°±3°	555°±5°	Ø 1.6mm		158

▶ 1PK-709Y Long Nose Plier

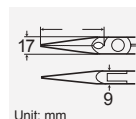

Individual packing: Blister card

Material	HRC		Application			OAL. (mm)
	Body	Cutting edge	Hard steel	Soft steel	Copper	
S55C	45°±3°	555°±3°	Ø 1.2mm	Ø 2.0mm	Ø 2.6mm	165

▶ 1PK-051AS Combination Plier

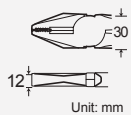

Material	HRC		Application			OAL. (mm)
	Body	Hard steel	Soft steel	Copper		
S60C	48°±3°	Ø 1.2mm	Ø 2.2mm	Ø 3.0mm	200	

▶ 1PK-052AS Combination Plier

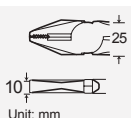

Material	HRC		Application			OAL. (mm)
	Body	Hard steel	Soft steel	Copper		
S60C	48°±3°	Ø 1.2mm	Ø 2.2mm	Ø 3.0mm	160	

▶ 1PK-709AS Snipe Nose Plier

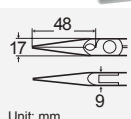

Material	HRC		Application			OAL. (mm)
	Body	Hard steel	Soft steel	Copper		
S60C	48°±3°	Ø 1.2mm	Ø 2.0mm	Ø 2.6mm	160	

▶ 1PK-067AS Side Cutter

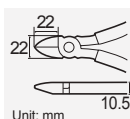

Material	HRC		Application			OAL. (mm)
	Body	Hard steel	Soft steel	Copper		
S60C	48°±3°	Ø 1.2mm	Ø 2.0mm	Ø 2.6mm	160	

▶ PM-908 Side Cutting Plier



- **High leverage** force saving design.
- 2 Skinning notches for stripping insulation wire Ø1.5, 2.0mm.
- TPR Handle for user comfort.

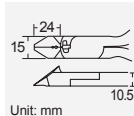

Material	HRC		Application		OAL. (mm)
	Body	Cutting edge	Hard steel		
SAE 6150	45°±3°	60°±2°	Ø 1.4mm		160

Individual packing: Blister card

▶ PM-909 Long Nose Plier



- **High leverage** force saving design
- Long nose plier with coarser-toothed midsection and crosswise serrated for firm gripping and more work application.

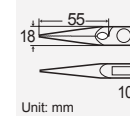

Material	HRC		Application		OAL. (mm)
	Body	Cutting edge	Hard steel		
SAE 6150	45°±3°	60°±2°	Piano wire: Ø1.2mm		170

Individual packing: Blister card

Protective Handles Plier

- Made from S60C, drop-forged, hardened and tempered for maximum strength and durability.
- High visibility molded ergonomic cushion handle provides comfort and safety to the user.

Material: S60C
Hardness: HRC 48°±3°



Nickel-iron plated



Individual packing: Blister card

PM-921 8" High Leverage Lineman's Plier

Aerospace steel
high hardness and good corrosion resistance



High leverage design requires 20% less force than traditional type

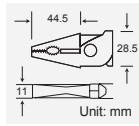

Material	HRC		Application				OAL. (mm)	Individual packing
	Body	Cutting edge	Hard steel	Soft steel	Copper	Piano wire		
55Cr-Ni steel	44°±3°	60°±5°	Ø1.2mm	Ø2.6mm	Ø3.2mm	Ø2.0mm	207	Blister card



Serrated jaw
for firm gripping



Screw/unscrew
specially for stripped thread



Cutting capability
for 2.0mm Piano wire

PM-901 / PM-903 Lineman's Plier

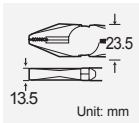

PM-901

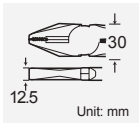

PM-903



- **Quality Cr-V steel** guarantees longer service life time and good cutting performance.
- **High leverage** force saving design.



Model No.	Material	HRC		Application Hard steel	OAL. (mm)	Individual packing
		Body	Cutting edge			
PM-901	SAE6150	45°±3°	60°±2°	Piano wire: Ø2.5mm (under HRC: 45°)	215	Blister card
PM-903					225	

PN-086N/PN-088/PN-080 Slip Joint Plier



PN-086N

PN-088

PN-080



- Slip joint pliers with wire cutter.
- High quality carbon steel drop forged, hardened and tempered.
- With 2-position milled jaws to meet different requirements.
- Plastic coated handles, non-slip.

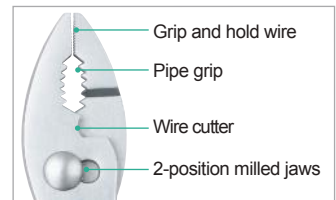

Model No.	Material	HRC		Handle	OAL. (mm)	Individual packing
		Body				
PN-086N				PVC	154	Blister card
PN-088	S45C	38°±3°			204	
PN-080					254	

PN-P110 Raptor 10" Pump Plier

2X Faster Positioning Aerospace Steel Force Saving

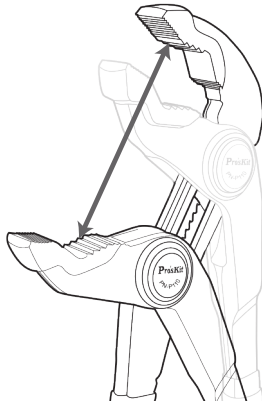
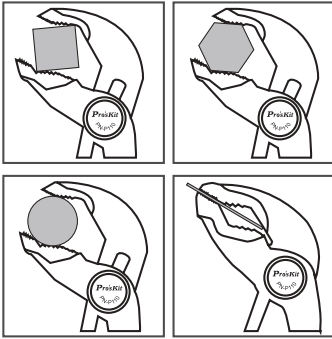

Material	HRC		Jaw open (Max)	Jaw depth (Max)	OAL.(mm)	Individual packing
	Body	Jaw				
55Cr-Ni steel	38°±3°	55°±5°	45mm	37mm	253mm	Blister card



- **Press-n-slide button w/ ratchet design** can quickly adjust jaw opening width 2X faster.
- **High leverage design** for force-saving and firm contact.
- **V-Jaw** with hardened teeth ideal for gripping round, hex, square and flat surfaces.

Powerful, Firm, grip

Max. opening: 45mm

2X Faster Positioning

One hand push button allows quick adjustment.

15 Position

Adjusted by one-way ratchet design.

High Leverage Design

For force saving.



Double Injected Handle

For user comfort.

ELECTRICAL PLIERS & CUTTERS

PN-P008/PN-P010N/PN-P012 Slip-Channel Pump Plier



- Pearl-nickel plated.
- High quality carbon steel drop forged, hardened and tempered.
- Non-slip, plastic coated handle.
- 5-position milled jaws joint with pinch protection.

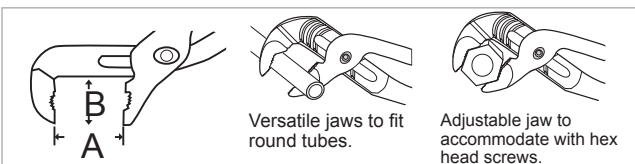
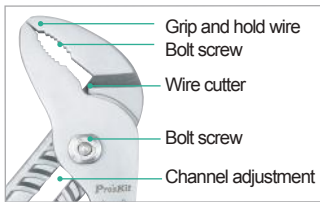

PN-P008

PN-P010N

PN-P012

Model No.	Material	HRC Body	Handle	Channel adjustment	Max jaw open (A)	Max jaw open (B)	OAL. (mm)	Individual packing
PN-P008				5 Position	30mm	27mm	204	Blister card
PN-P010N	S45C	45°±3°	PVC	6 Position	42mm	32mm	254	
PN-P012				7 Position	51mm	42mm	317	

▶ PN-H010/PN-H012 Heavy Duty Pipe Wrench

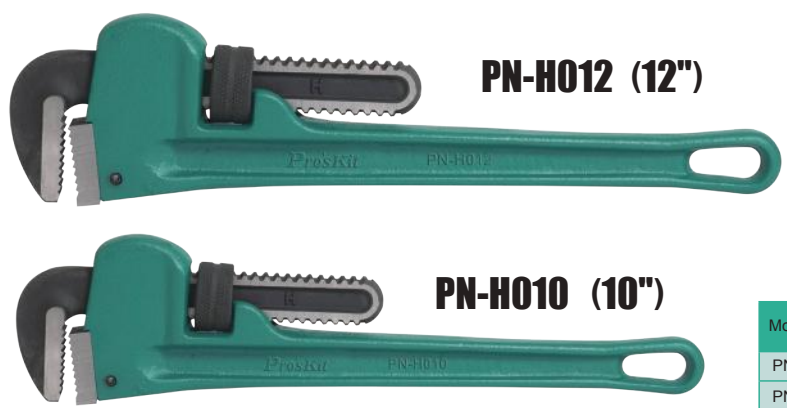

Heavy Duty Firm Grip

- Strong, one-piece cast iron body with straight I-beam handle.
- Forged and hardened steel hook and heel jaws.
- Full floating hook jaw creates a natural ratcheting action for work in tight spaces.

Model No.	Material	Clamping width	OAL (mm)	Individual packing
PN-H010	Clamping head S60 Carbon steel	35mm	242(10")	Hanger
PN-H012		45mm	270(12")	

▶ 8PK-378A/8PK-378C/PN-378D Adjustable Locking Plier (Industrial Grade)



- The forged jaws have an angled tooth pattern for superior grip and built-in wire cutter.
- The handle features a compound action non-slip lock and release lever for one-hand operation.
- With precision-machined jaw adjustment screw to fit work.
- Heavy duty model, provide maximum contact for holds round, flat, square, or hex material securely.



Model No.	Material		HRC Body	Clamping width	OAL (mm)	Individual packing
	Head	Handle				
8PK-378A	SAE 4140 Cr-Mo alloy steel	SAE 4135 Cr-Mo alloy steel	50 ±3*	Round: Ø5.4~24mm, Hex: Ø5.4~20.78mm	140(5")	Double blister
8PK-378C				Round: Ø7.3~37mm, Hex: Ø7.3~32.04mm	180(7")	
PN-378D				Round: Ø8.5~50mm, Hex: Ø8.5~43.3mm	224(10")	

▶ 8PK-378B/PN-378E Long Nose Locking Plier



- Long, straight nose provides easy access in narrow and hard-to-reach places.
- The handle features a compound action non-slip lock and release lever for one-hand operation.
- With precision-machined jaw adjustment screw to fit work.
- Heavy duty model, provides maximum contact for holds round, flat, square, or hex material securely.

Model No.	Material		HRC Body	Clamping width	OAL (mm)	Individual packing
	Head	Handle				
8PK-378B	SAE 4140 Cr-Mo alloy steel	SAE 4135 Cr-Mo alloy steel	50 ±3*	Round: Ø5~19mm, Hex: Ø5~16.45mm	160(6")	Double blister
PN-378E				Round: Ø7.5~41mm, Hex: Ø7.5~35.41mm	225(9")	Blister card

SR-228 Copper Clad Steel Coaxial Cable Cutter

- Made of high quality S45C with black oxide finished for anti-rust.
- Palm-fit ergonomic cushion grip handle provides user comfort.
- Adjustable screw and nut ensures proper fix and durability
- Safety lock for easy storage



For cutting steel center conductor and keeping cable round



Material	HRC Body	Handle	Application	OAL (mm)	Individual packing
S45C	50 \pm 2°	PVC	Copper cable : RG-6, RG-58, RG-59 copper clad steel coaxial cable max. 16mm 2	159	Blister card

608-330 Round Cable Cutter



- Safety lock for easy storage.



Material	HRC Body	Handle	Application	OAL (mm)	Individual packing
S45C	45 \pm 3°	PVC	Cutting multi-conductor cable up to 0.5" (12.7mm) and stranded wire up to 8 AWG (10mm 2)	165	Blister card

808-330A Round Cable Cutter



- Safety lock for easy storage.



Material	HRC Body	Handle	Application	OAL (mm)	Individual packing
S45C	45 \pm 3°	PVC	Cutting thick wire up to 2/0 (70mm 2) cable, 100 pair group telephone cable RG-174/RG-9 coax size	215	Blister card

SR-015 Nibbling Tool

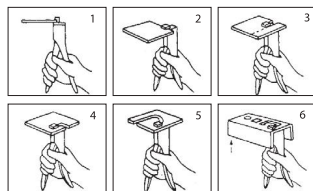
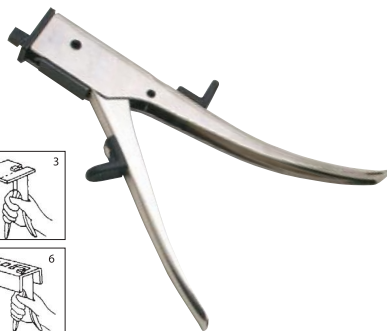

Material	HRC Body	Application	Replacement blade	OAL (mm)	Individual packing
Body:FCD45 Blade:S45C	45 \pm 3°	Cut up to 18AWG soft steel, 1/16" copper, Al and Plastic	9SR-015-B	184	Blister card

8PK-CT006 Wire Rope And Cable Armour Cutter



- Special cutting action for cutting stranded cable armour, electric cable, metal wire and rods.
- Distortion free cut.



Material	Handle	Hardness Body	Application	OAL (mm)	Individual packing
SK5	PVC	55 \pm 3°	Cutting:Ø4mm copper, Wire rope:Ø1.5mm spring wire	190	Poly bag

8PK-249 Snap Ring Plier Set



- 3 convertible tip jaws can be changed easily for 6 different internal-external purposes.

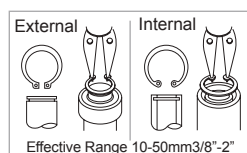

Material	Handle	HRC Body	Application	OAL (mm)	Individual packing
S45C	PVC	43 \pm 3°	Effective range: 10-50mm Hard steel	155	Blister card

CP-311 Strain Relief Bushing Assembly Tool



- Designed to install all sizes of strain relief bushing.
- Close lock and return spring function.



Material	Handle	Hardness Body	Application	OAL (mm)	Individual packing
Low carbon steel	PVC	HR30N58°	Thickness:3mm	170	Blister card

SR-363A/SR-363B 2 in 1 Round Cable Cutter & Stripper



- The stripper is processed by CNC machining process to ensure its accuracy.
- Ideal for cutting multi-conductor round cable up to 10.7mm (Ø 0.42") and stripping wire.

Material:SK5
HRC55^{±3}
black oxide finished

Safety Lock
for easy storage

Stripper wire size:
SR-363A: AWG 14~8

Dual color TPR
grip handle

Bolt cutter: M3

Stripper wire size:
SR-363B: AWG 20~10



SR-363A



SR-363B



Cutting round cable



Stripping

Model No.	Material		HRC	Application	OAL.(mm)	Individual packing
	Handle	Body	Body			
SR-363A	TPR	SK5	54 ^{±3}	Stripping AWG 14/12/10/8 Cutting round cable up to 10.7mm	168	Blister card
SR-363B			54 ^{±3}			

8PK-A202/8PK-A203/8PK-A201A Forged Cable Cutter



- High-leverage jaw with shear-cut blades.
- Do not cut steel or ACSR.
- Plastic coated handle.



Cuts up to 70mm² aluminum
and copper cables
(8PK-A201A)



8PK-A202



8PK-A203



8PK-A201A

Model No.	Material	HRC		Handle	Application		OAL.(mm)	Individual packing
		Body	Cutting edge		Copper cable	Aluminum cable		
8PK-A202	SCM 440	45 ^{±3}	60 ^{±5}	PVC	25mm ² flexible	25mm ² stranded	160	Blister card
8PK-A203					38mm ² flexible	38mm ² stranded		
8PK-A201A					16mm ² solid, 35mm ² stranded, 70mm ² flexible	70mm ² stranded		

SR-255 High-Leverage Cable Cutter (80mm²)

60% Force Saving
Lever Action Design

- Heat-treated, precision ground, shear action blades.
- Body made of high quality SCM440 with black oxide finished for anti-rust.
- Ergonomic PVC non-slip cushion handles provide user comfort.



Cable cutting up to 80mm²

Material		HRC		Application	OAL. (mm)	Individual packing
Body	Handle	Body	Cuttine edge			
SCM440	PVC	45°±3°	54°±2°	Copper cable 80mm ²	255	Blister card



Material:SCM440
HRC45°±3°
black oxide finished

Unique lever mechanism design



ELECTRICAL PLIERS & CUTTERS

6PK-535 Round Cable Cutter



- Ratchet design for force saving.
- Cut up to 350 MCM copper 500 MCM Al-jacketed S.O. cord up to Ø32mm or up to 200 pair communication cable.



SR-536 Round Duty Cable Cutter



- Ratcheted w/safety release.
- Comfortable handle.
- For aluminum and soft copper cables up to ø35mm.



Model No.	Material		Hardness		Handle	Application	Replacement blade	OAL.(mm)	Individual packing
	Body	Blade	Body	Cutting edge					
6PK-535	Low carbon steel	SAE 4340	HR 30N 55°~70°	HRC 45°±3°	PVC	Ø32mm copper & aluminum cable	5PK-535-RB(Moving blade) 5PK-535-FB(Fixed blade)	254	Blister card
SR-536						Ø35mm copper & aluminum cable	5SR-536-RB(Moving blade) 5SR-536-FB(Fixed blade)	250	

SR-539 Open Jaw Cable Cutter

Front-loading Jaw

For confined area.

Quick Release

For fast jaw opening.

Handle Guard
For comfortable and firm grip.

High Leverage



Material: AISI4340

Locking Lever
Ensures safety



New Mechanism, Save time, Save place

- Cuts up to 500MCM copper and 750MCM aluminum cable without burrs or sharp edges.
- Unique open, shear-type jaw reaches around large diameter cable easily.



⚠ Not designed for cutting steel or ACSR

Handle	Material		Application	OAL (mm)	Individual packing
	Blade	Body			
TPR	SAE4340	S50C	500MCM (250mm ²) Copper, 750MCM (400mm ²) Aluminum, Ø30mm Communications Cable(Max.)	313	Blister card

SR-538 Ratchet Cable Cutter



Material: SAE4340
Cutting edge: HRC 46°±2°

Ratchet release trigger

Handle lock

Material: S45C



Cutting cables up to 700MCM (350mm²)

- Unique ratchet mechanism design ensures a non-slip cut, and increases cutting power on tough jobs
- For aluminum and soft copper cables up to Ø52mm

⚠ Not designed for cutting steel or ACSR

Application	OAL (mm)	Individual packing
700MCM(350mm ²) Ø52mm Copper cable, 750MCM(380mm ²) Ø52mm Aluminum cable	335	Blister card

SR-533 Ratchet Round Cable Cutter



Material: SAE4340
HRC46°±1°
Black oxide finished

Safety handle lock for easy storage



Cutting telecom cable up to 600MCM(300mm²)

- Unique ratchet mechanism design ensure a non-slip cut.
- For cutting telecom and power cable up to 600MCM(300mm²).

Handle	Material		HRC Blade	Application	OAL (mm)	Individual packing
	Blade	Body				
TPR	SAE4340	S50C	46°±1°	Telecom & power cable max. 600MCM	280	Blister card

8PK-SR250/8PK-SR500 Cable Cutter



- SCM4 Chromium-Molybdenum-Steel forged, efficient and secure in operation.
- Alloy-aluminum handle, treated by T6 heat, strong durable and handy.

8PK-SR250

8PK-SR500

SCM4 Chromium-Molybdenum steel;
efficient and secure in operation

Aluminum handle with
non-fracture character

Soft rubber sleeves handle



Model No.	HRC	Application	Replacement blade	OAL (mm)	Individual packing
	Blade	Copper cable			
8PK-SR250	52' ±2'	DIN 250mm ² , AWG 500	5PK-SR250-BS	600	Blister card
8PK-SR500		DIN 500mm ² , AWG 1000	5PK-SR500-BS	800	

ELECTRICAL PLIERS
& CUTTERS

KNIVES & SCISSORS



Life is too short with a dull knife. *Pro'sKit*® knives and scissors perfect your work.



Pro'sKit®

886-2-22183233
Sales support

pk@mail.prokits.com.tw
E-mail

www.prokits.com.tw
Global website

SR-366 Ratcheting Plastic Pipe Cutter

V-shaped Blade
Blade Quick Change
Ratchet Action



Capacity
max. 38mm/1.2 inch

V-shaped Blade
for accurate cutting
and force saving.

**Blade quick
change design**

Tool free blade
installation

Blade auto
return with
ratchet quick
release

Lightweight
aluminum frame



Locking clip

Material		Application	Replacement blade	OAL. (mm)	Individual packing
Body	Blade				
Aluminum Alloy Steel	SK5	max.38mm(1.2inch)	5SR-366-B	195	Blister card

SR-331/SR-332 All Purpose Snip

• Cut cable, wire, cloth, carpet, leather, cardboard tin plate, branch, foam rubber and so on.



Leather

Aluminum sheet

Cable



Heavy-duty stainless
steel blade

SR-331

Safety latch for
easy storage

Dual-color , Non-slip handle



SR-332



Model No.	Material	Handle	Application	OAL. (mm)	Individual packing
SR-331	AISI 420	P.P+ T.P.R	Cardboard, PVC Leather, Rubber: thickness < 5mm.	165	Blister card
SR-332			Aluminum sheet, Copper sheet: thickness < 1mm Steel sheet: thickness < 0.5mm Cable, PVC water pipe, plastic tube up to Ø10mm		

SR-330 All Purpose Snip



Stainless steel

Safety lock



Cable



Copper

• Ideal for cutting cable, leather, cardboard, foam rubber and more.

Material	Handle	Application	OAL. (mm)	Individual packing
AISI 410	P.P+ T.P.R	Cardboard, PVC Leather, Rubber: thickness < 3mm. Aluminum sheet, Copper sheet: thickness < 1mm PVC, PET , plastic : thickness < 0.2mm Fixable flat cable: thickness < 0.3mm	165	Blister card

SR-333 Micro Scissor



Safety cap



• Made of stainless steel to resist rust and corrosion.
• Return spring offers more smooth operation.



Material	Handle	Application	OAL. (mm)	Individual packing
AISI 420	ABS+ TPE	Cooper, IC, component pin: thickness < 0.3mm. PVC, PET , plastic : thickness < 0.2mm Fixable flat cable: thickness < 0.3mm	120	Blister card

▶ 8PK-SR007 All Purpose Snip



Material	Handle	Application	OAL. (mm)	Individual packing
AISI 410	P.P+ T.P.R	Cardboard, PVC Leather, Rubber: thickness < 3mm Aluminum sheet, Copper sheet: thickness < 1mm PVC, PET, plastic: thickness < 0.2mm Fixable flat cable: thickness < 0.3mm Carpet: thickness < 10mm	200	Blister card

▶ PD-998 Electrician's Knife



- High quality stainless steel, large curved hawk bill blade offer durability and artistic appearance.



PVC, PE cable stripping



Handle	Blade	OAL.(mm)	Individual packing
ABS	3 Cr 13	190	Blister card

▶ DK-2039 Utility Knife



- Blade in thickness: 0.5mm
- includes 3 pcs blade inside

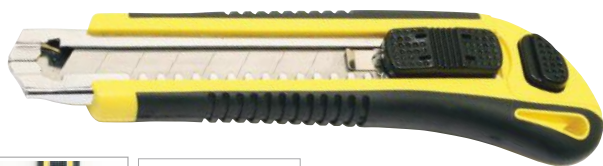

DK-2039-B (6pcs/pack)

Handle	Blade	Replacement blade	OAL.(mm)	Individual packing
ABS+TPR	SK-4	DK-2039-B(6Pcs/Pack)	170	Blister card

▶ DK-2047N Electricians Scissors



Stripping 18 & 22 AWG



- Designed for use in telephone and electrical service applications.
- Scraper and file on side edge of blade.

Material	Handle	Application	OAL. (mm)	Individual packing
AISI 420	Nylon+Filber	Stripping from AWG 18 and 22 wire Cutting up to AWG 16 solid wire and AWG 12 stranded wire	145	Blister card

▶ PD-994 Electrician's Knife



- Extra-large curved slitting-blade (Length: 60mm)



PVC, PE cable stripping



Handle	Blade	OAL.(mm)	Individual packing
Wood	3 Cr 13	185	Blister card

▶ DK-2112 Auto Loading Utility Knife



- Automatic blade reload for effortless and quick blade changes.
- Convenient blade storage compartment holds up to 6pcs blades (blades included)



Blade storage compartment

Handle	Blade	Replacement blade	OAL.(mm)	Individual packing
Zinc Alloy+TPR	SK5	5DK-2112-B(10Pcs/Pack)	165	Blister card

▶ 8PK-BL002 Cable Splicing Knife

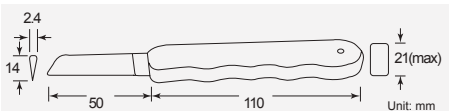

- Short blade for strength.
- Stainless-steel blade for durability and longer lasting blade edge.
- Soft, easy-to-grip handle.



Handle	Blade	OAL.(mm)	Individual packing
TPR	AISI 420	160	Blister card

▶ PD-398 14PCS Alumium Handle Knife Kit

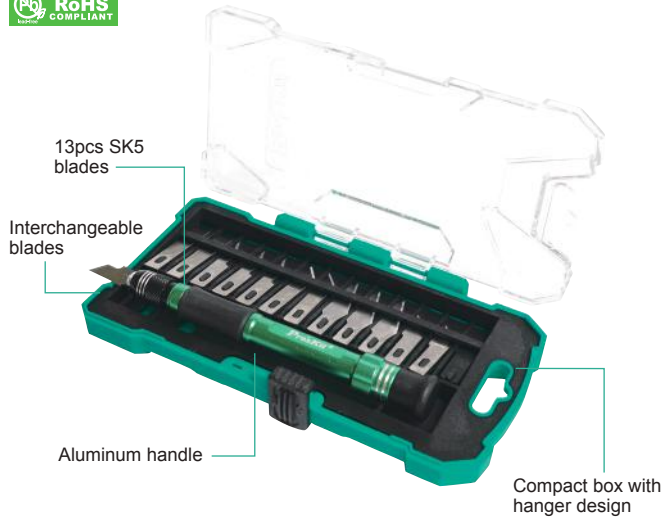

Contents
13pcs SK5 blades
Aluminum alloy handle
Plastic box size: 151x82x25mm
Individual packing
Blister card

▶ PD-395A 30PCS Deluxe Hobby Knife Kit



Contents	
3pcs TPR+PP dual color non-slip handles	
19pcs SK5 carving blades (3pcs in handle)	
2pcs awl blades	1pcs tweezers
4pcs shovel blades	1pcs grind stone
Dual color TPR+PP case (205x132x45mm)	
Individual packing	Blister card

Cover all your daily needed, only one set for all applications, easy and safe to use.

▶ Precision Knife

- Surgically sharp knives with high-impact plastic safety cap.



8PK-394A Ø8mm



8PK-394B Ø11mm



PD-394A Ø8mm



508-394A-B
(10pcs/pack)



508-394B-B
(10pcs/pack)



5PD-394A-B
(10pcs/pack)

Model No.	Handle	Blade	Replacement blade	OAL. (mm)	Individual packing
8PK-394A	Aluminum	SK-5	508-394A-B(10pcs/pack)	145	Blister card
8PK-394B			508-394B-B(10pcs/pack)	150	
PD-394A			5PD-394A-B(10pcs/pack)	145	

▶ PD-392 3D printer Carving Knife set

- Quality constructed, long lasting hardened steel blade.
- Removes ABS and PLA raft and supports from 3D printed objects.



Handle	Blade	OAL.(mm)	Individual packing
PP	SK2	141~145	Blister card

▶ PD-510 Quick Point Snap-Blade Knife



- Includes 2 pcs blade inside
- Locking slide

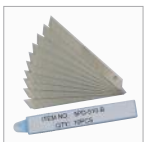

5PD-510-B
(10Pcs/Pack)



Handle	Blade	Replacement blade	OAL.(mm)	Individual packing
ABS	SK-5	5PD-510-B(10Pcs/Pack)	140	Blister card

▶ PD-513 Utility Knife



- Lightweight and durable.



Handle	Blade	OAL.(mm)	Individual packing
ABS	SK4	155	Blister card

CRIMPERS



Best Connection, Less Effort.



Pro'sKit®

886-2-22183233
Sales support

pk@mail.prokits.com.tw
E-mail

www.prokits.com.tw
Global website



































Crimpers

All parts of **Pro'sKit** crimping tools are made of special steel, oil-hardend and tempered. They come with ergonomically designed handles and lever action features the optimum transmission of force for fatigue-reduced operation, & high crimping quality due to precision dies and integral ratcheting mechanism.

Pro'sKit crimping tools use interchangeable die sets to crimp a wide variety of different connectors for twisted pair and flat phone cable, fiber optic cable, coaxial cable, electrical and industrial wire...etc.

Symbols for Crimp die profiles

The **Pro'sKit** crimping dies are made from high precision lost-wax casting technology, providing the high accuracy and long service life.

		4 pin(RJ22) telephone handset plugs
		6 pin(RJ11/RJ12) telephone plugs
		8 pin(RJ45) modular plugs
		10 pin(RJ50) modular plugs
		Telecom splice connectors
		Pin terminal, insulated & non-insulated ferrules
		Insulated & non-insulated wire ferrules
		Non-insulated terminals & plugs
		Open barrel, non-insulated terminals & plugs
		D-Sub terminal & non-Insulated open barrel connectors
		Insulated terminals, insulated & uninsulated flag
		Insulated terminals
		RS-232 D-sub round barrel contact pins or sockets
		Insulated & non-insulated wire ferrules
		Hex type coaxial connectors & fiber optics connectors
		Oval type coaxial connectors & fiber optics connectors
		Square type coaxial connectors center contact pins

Symbols for ratcheting mechanism

Pro'sKit ratcheting crimping tools usually combine crimping pressure adjustment and ratcheting release trigger. The different models have different ratcheting mechanism designs.



Crimping pressure adjustment



Ratcheting release knob



Ratcheting release trigger

Symbols for cutting and stripping

Most of **Pro'sKit** modular crimping tools usually feature cutting and stripping functions.



Symbols for force-saving design

Pro'sKit new design of crimping tools with lever action, features optimum transmission of force for fatigue-reduced operation and comes with the ratcheting mechanism which helps to ensure the crimping quality. This design requires less force than general hand tools.



Force-saving design

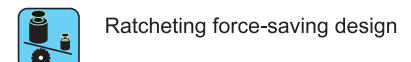

Ratcheting force-saving design

Interchangeable Ratcheting Crimper Series



- Made from high quality carbon steel with black oxide finish for corrosion resistance and durability.
- Energy saving ratcheting mechanism requires less handle force and ensures the crimping quality.
- Ergonomically shaped non-slip handles for user comfort.
- Interchangeable die sets for wide range of applications.

CP-336F Lunar Crimp Frame

Compact Design

Elastomeric resin fitting exactly and double structure. Non-slip. Green: PP Balck: T.P.R

(8.5" 220mm)

Individual packing: Blister card

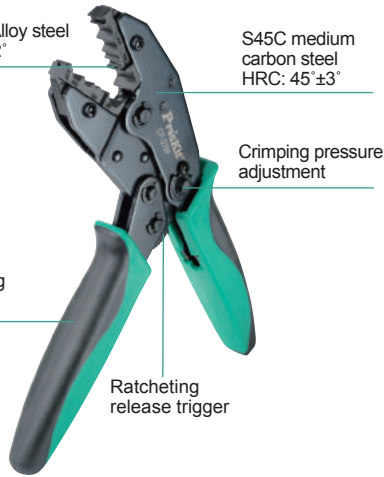

CP-371 CrimpPro Crimp Frame

30% Force Saving

(9" 236mm)

Individual packing: Blister card

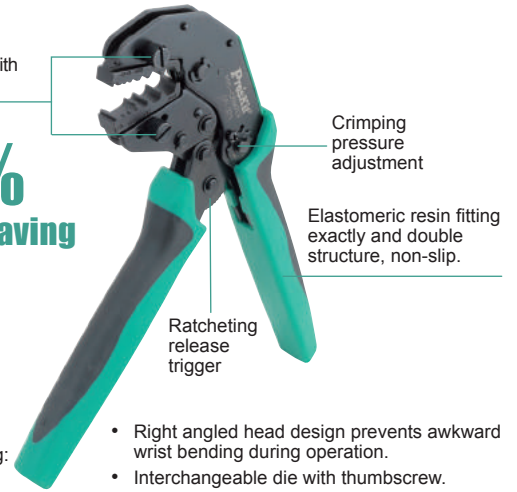

- Right angled head design prevents awkward wrist bending during operation.
- Interchangeable die with thumbscrew.

Replacement die set	Die Set	Crimp die profile	Application	Crimp Size	Terminals
Modular Plug					
CP-236DM5			Molex 8P8C/RJ45 plug & cable O/D around ø5.2 mm		
1PK-3003D11			8P8C/RJ45 keyed modular plugs (excluding AMP)		
1PK-3003D12			6P2C/6P4C/6P6C RJ11/RJ12 modular plugs		
1PK-3003D13			6P2C/6P4C/6P6C RJ11/RJ12 DEC MMJ modular plugs with an offset release tab		
1PK-3003D14			AMP 8P8C/RJ45 modular plugs. Primary strain relief crimp bar is located further back on die/modular plugs		
1PK-3003D16			RJ22 4P2C/4P4C handset modular plugs		
1PK-3003D17			Usable for RJ50, 10 position modular plugs		
1PK3003D17-MA			8P8C/RJ45 keyed or non-keyed modular plugs (excluding AMP)		
1PK-3003D25			8P8C/RJ45 WE/SS modular plugs and RG6/RG6 Quad shield CATV "F" connectors	8P8C/RJ45 WE/SS modular plugs HEX .324", .360" HEX 8.23, 9.14 mm	
Coaxial Connectors					
CP-336DA4			RG58, RG59, RG62, RG174	HEX .068", .187", .213", .255" HEX 1.73, 4.75, 5.41, 6.48 mm	
CP-336DC			RG58, RG59, RG62, RG6	HEX .068", .213", .256", .319" HEX 1.73, 5.41, 6.50, 8.10 mm	
CP-336DC1			RG58, RG59, RG62, RG6	HEX .068", .216", .324", .360" HEX 1.73, 5.49, 8.23, 9.14 mm	
CP-336DI			RG58, RG59, RG6, RG174	HEX .067", .093", .211", .255", .315" HEX 1.70, 2.36, 5.36, 6.48, 8.00 mm	
CP-336DP1			RG type cables 55, 58, 59, 5, 6, 21, 141, 142, 143, 210, 212, 222, 223, 303, 304, 400, Belden: 8279, 8281, 9231 & 9141	HEX .068", .098", .213", .255", .321" HEX 1.73, 2.49, 5.41, 6.48, 8.15 mm	

Replacement die set	Die Set	Crimp die profile	Application	Crimp Size	Terminals
CP-336DY1			RG58 (oval type)	RND .069", .218" RND 1.75, 5.54 mm	
1PK-3003D3			Cambridge CP-88, CP-89 BNC/TNC coax connectors with RG58, RG59, RG62/AU cables	SQ .068", HEX .228", .305", SQ 1.73, HEX 5.79, 7.75 mm	
1PK-3003D6			N-Series and RG8, RG11 Connectors	HEX .080", .100", .429", HEX 2.03, 2.54, 10.90 mm	
1PK-3003D8			RG58, RG6, RG174, Belden type RG8281 cables	HEX .068", .178", .324", HEX 1.73, 4.52, 8.23 mm	
1PK-3003D9			Plenum and teflon cables, RG58, RG59	HEX .042", .068", .190", .213", HEX 1.07, 1.73, 4.83, 5.41 mm	
1PK-3003D10			RG59, RG6, RG8281, F-type CATV Connectors	HEX .255", .320", .350", HEX 6.48, 8.13, 8.89 mm	
1PK-3003D22			AMP RG58 dual crimp BNC/TNC connectors	RND .049", .218" RND 1.24, 5.54 mm	
1PK-3003D28			HDTV true 75-ohm BNC/TNC coaxial connectors: Belden 1855A, 1865A, 1505A, 1505F, 1694A, 1694F	SQ .041", HEX .068", .178", .255", .278" SQ 1.04, HEX 1.73, 4.52, 6.48, 7.06 mm	
1PK-3003D30			HDTV BNC/TNC 3-piece coaxial connectors	SQ .042", HEX .197", .278", SQ 1.07, HEX 5.00, 7.06 mm	
1PK-3003D31			HDTV true 75-ohm BNC/TNC coaxial connectors, RG6, Belden 1694 & 1694A	SQ .042", HEX .068", .275", .278", SQ 1.07, HEX 1.73, 6.99, 7.06 mm	
1PK-3003D32			HDTV true 75-ohm BNC/TNC & CATV "F" coaxial connectors, RG59, RG6, Belden 8281, 1694A & 1505A	SQ .042", .052", HEX .068", .255", .324", SQ 1.07, 1.32, HEX 1.73, 6.48, 8.23 mm	
1PK-3003D33			HDTV BNC/TNC 3-piece coaxial connectors	SQ .042", HEX .178", .275", SQ 1.07, HEX 4.52, 6.99 mm	
1PK-3003D34			HDTV SMA true 75-ohm BNC/TNC & mini UHF RG174, RG59/62, mini coaxial & Belden 1855A	SQ .042", HEX .068", .178", .197", .255" SQ 1.07, HEX 1.73, 4.52, 5.00, 6.48 mm	

CP-3005F

Quick Interchangeable Ratcheting Crimper Frame



Material: AISI 4140
HRC43 \pm 2°

Material: S50C
HRC: 45 \pm 3°

Crimping pressure adjustment

Quick Die Change Design



(9" 226mm)

Individual packing:
Blister card

- Quick release trigger secures die for quick, easy changes without tools

1PK-3003F

Ergo-Lunar Crimper Frame



Change die with thumbscrews.

S45C medium carbon steel, HRC: 45 \pm 3°

Ratchet crimping action provides repeatable and reliable terminations

Ratcheting release trigger

Crimping pressure adjustment

50% Force Saving



PP sleeve handle

(10" 260mm)

Individual packing:
Blister card

- 40%~50% lower crimping force.
- Interchangeable die with thumbscrew.

Replacement die set	Die Set	Crimp die profile	Application	Crimp Size	Terminals
Fiber Optic Connectors					
CP-336DF1			SMA, SRF, SMF fiber optic connectors	SQ .042", HEX .068", RND .133", .162", .195", SQ 1.07, HEX 1.73, RND 3.38, 4.11, 4.95 mm	
CP-336DF2			SMA, SMB, FC Biconic and SC & ST fiber optic connectors, RG58, RG174, Belden8218	SQ.042", HEX .068", .151", .178", .213" SQ 1.07, HEX1.73, 3.84, 4.52, 5.41 mm	
CP-336DF4			For FC, SC, ST, LC, SMA & MT-RJ fiber optic connectors	HEX .139", .151", .178", RND .134", .190" HEX 3.53, 3.84, 4.52, RND3.40, 4.83 mm	
CP-336DG			RG58, RG59, RG62, RG174 fiber optic	SQ .043", HEX .068", .100", .137", .213", .255", SQ 1.09, HEX 1.73, 2.54, 3.48, 5.41, 6.48 mm	
CP-336DJ			RG174, RG179, Belden 8218 fiber optic	SQ .042", HEX .068", .078", .128", .151", .178", SQ 1.07, HEX 1.73, 1.98, 3.25, 3.84, 4.52 mm	
CP-336DK4			RG58, RG174, fiber optic	HEX .100", .128", .190", .213", HEX 2.54, 3.25, 4.83, 5.41 mm	
CP-336DV			SMA, SMB, SMC, MCX	SQ .043", HEX .069", .100", .128", .151", .213", SQ 1.09, HEX 1.75, 2.54, 3.25, 3.84, 5.41 mm	
1PK-3003D4			AMP optimize fiber optic SMA or SFR type connectors	RND .138", .165", .195", RND 3.51, 4.19, 4.95 mm	
Electrical and Industrial Terminals					
CP-236DE			Pin terminal insulated & non-insulated wire ferrules	AWG 22/20/18 16/14/12 DIN 0.5/0.75/1.0/1.5 2.5/4.0 mm ² JIS 0.35/0.5/0.9/1.25 2.0/3.5 mm ²	
CP-236DE1			Pin terminal insulated & non-insulated wire ferrules	AWG 10/8/6 DIN 6.0/10.0/16.0 mm ² JIS 5.5/8.0/14.0 mm ²	
CP-236DF			Insulated flag terminal	AWG 22-18/16-14 DIN 0.5-1.0/1.5-2.5mm ² JIS 0.35-0.9 1.25-2.0 mm ²	
CP-236DF1			Non-insulated flag terminal	AWG 22-18/16-14 DIN 0.5-1.0/1.5-2.5mm ² JIS 0.35-0.9 1.25-2.0 mm ²	

Replacement die set	Die Set	Crimp die profile	Application	Crimp Size	Terminals
CP-236DN			Non-insulated terminal & plugs	AWG 20-18/16-14/12-10/8, DIN 1.5/2.5/6.0/10.0 mm ² JIS 1.25/2.0/3.5-5.5/8.0 mm ²	
CP-236DR			Vinyl insulated W/O copper sleeve	AWG 22-18/16-14/12-10, DIN 0.5-1.0/1.5-2.5/4.0-6.0mm ² JIS 1.25/2.0/3.5-5.5mm ²	
CP-236DU			Non-insulated open barrel connectors & D-SUB V.35 terminal	AWG 22/14 DIN 0.5/2.5 mm ² JIS 0.35/2.0 mm ²	
1PK-3003D1			Insulated terminals/ color coded nests	AWG 22-18/16-14/12-10, DIN 0.5-1.0/1.5-2.5/4.0-6.0 mm ² JIS 1.25/2.0/5.5 mm ²	
1PK-3003D2			Non insulated open barrel connectors, commercial type	AWG 22-18/16-14/12-10, DIN 0.5-1.0/1.5-2.5/4.0-6.0 mm ² JIS 0.35-0.9/1.25-2.0/3.5-5.5 mm ²	
1PK-3003D21			Insulated terminals & plugs for smaller wire barrel terminals	AWG 26-22/22-18/16 DIN 0.1-0.32/0.32-0.82/1.5mm ² JIS 0.1-0.30/0.30-0.75/1.25 mm ²	
1PK-3003D36			Non-insulated open barrel connectors & D-SUB V.35 contact pins	AWG 30-24/22-18 DIN 0.05-0.25/0.50-1.0mm ² , JIS 0.05-0.25/0.35-0.9mm ²	
1PK-3003D42			Insulated Flag	AWG 16-14/12-10 DIN 1.5-2.5/4.0-6.0mm ² JIS 1.25-2.0/3.5-5.5mm ²	
CP-3003D45			Non-insulated open barrel connectors	AWG 22-18/16-14/12-10, DIN 0.5-1.0/1.5-2.5/4.0-6.0 mm ² JIS 0.5-0.9/1.25-2.0/3.5-5.5 mm ²	
CP-3003D46			Non-Insulated open barrel connectors commercial type	AWG 22-18/16-14 DIN 0.5-1.0/1.5-2.5mm ² JIS 0.5-1.0/1.25-2.0mm ²	
CP-3003D47			Non-Insulated open barrel connectors commercial type	AWG 20-18/6-14/12-10, DIN 0.5-1.0/1.5-2.5/4.0-6.0mm ² JIS 0.5-1.0/1.25-2.0/3.5-5.5 mm	
Solar Terminals					
CP-5S1D			For MC 3 solar connector (Multi-Contact) & 2.5/4.0/6.0 mm ² (AWG 14/12/10) solar cable	AWG 14/12/10 DIN 2.5/4.0/6.0mm ²	
CP-5S2D			For MC 4 solar connector (Multi-Contact) & 2.5/4.0/6.0 mm ² (AWG 14/12/10) solar cable	AWG 14/12/10 DIN 2.5/4.0/6.0mm ²	

CP-3006 Series Parallel Action Crimping Tool

For open barrel terminal and solar connectors

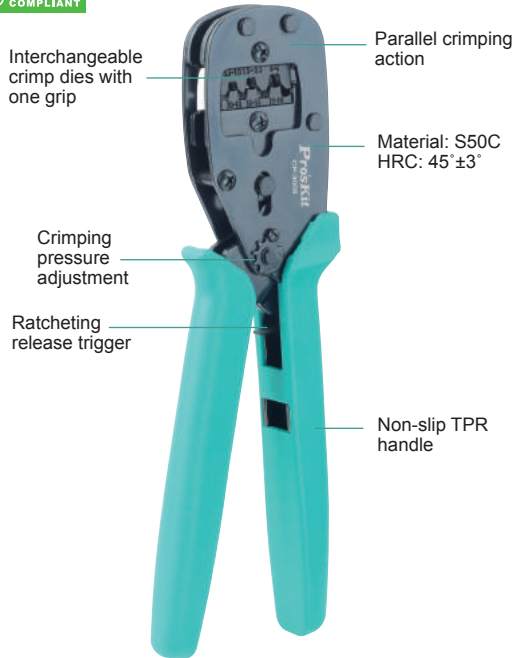

- **Reliable:** Parallel action crimping performance is consistent and accurate
- **Practical:** Safety crimp release helps eliminate rejected terminations due to incorrect positioning.
- **Comfortable:** Ergonomically shaped non-slip TPR handle for comfortable use in all conditions
- **Versatile:** Interchangeable die sets for wide range of applications.

Material		HRC	OAL (mm)	Individual packing
Body	Handle			
S50C	TPR	45° ±3'	254	Blister card

Model No.	DIE Set	Crimp die profile	Application	Terminals
CP-3006FD2			Non insulated open barrel connectors, commercial type AWG 22-18/16-14/12-10 DIN 0.5-1.0/1.5-2.5/4.0-6.0 mm ² JIS 0.35-0.9/1.25-2.0/3.5-5.5 mm ²	
CP-3006FD18			Pin terminal insulated or non-insulated ferrules, cord end terminals AWG 22/20/18/16/14/12 DIN 0.5/0.75/1.0/1.5/2.5/4.0 mm ² JIS 0.35/0.5/0.9/1.25/2.0/3.5 mm ²	
CP-3006FD36			Non-insulated open barrel connectors & D-SUB V.35 contact pins AWG 30-24/22-18 DIN 0.05-0.25/0.50-1.0 mm ² JIS 0.05-0.25/0.35-0.9 mm ²	
CP-3006FD45			Non-insulated open barrel connectors AWG 22-18/16-14/12-10 DIN 0.5-1.0/1.5-2.5/4.0-6.0 mm ² JIS 0.5-0.9/1.25-2.0/3.5-5.5 mm ²	
CP-3006FD46			Insulated open barrel connectors commercial type AWG 22-18/16-14 DIN 0.5-1.0/1.5-2.5 mm ² JIS 0.5-1.0/1.25-2.0 mm ²	
CP-3006FD47			Insulated open barrel connectors commercial type AWG 20-18/16-14/12-10 DIN 0.5-1.0/1.5-2.5/4.0-6.0 mm ² JIS 0.5-1.0/1.25-2.0/3.5-5.5 mm ²	
CP-3006FS1			For MC 3 solar connector (Multi-Contact) & 2.5/4.0/6.0 mm ² (AWG 14/12/10) solar cable AWG 14/12/10 DIN 2.5/4.0/6.0 mm ²	
CP-3006FS2			For MC 4 solar connector (Multi-Contact) & 2.5/4.0/6.0 mm ² (AWG 14/12/10) solar cable AWG 14/12/10 DIN 2.5/4.0/6.0 mm ²	

Crimping Tool

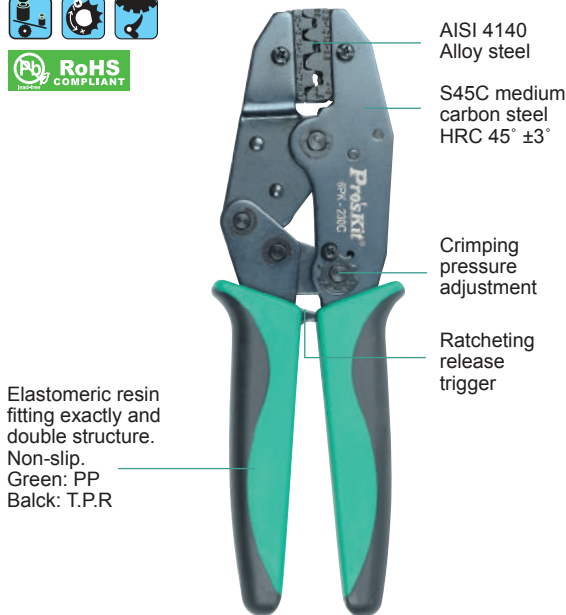

OAL (mm)	Individual packing
220	Blister card

Model No.	Description	Crimping die profile	Application	Crimp Size
6PK-230C	Inter-locking & Non-insulated		Non-insulated terminal or open barrel terminal	AWG 20-18/16-14/12-10 DIN 0.5-1.0/1.5-2.5/4.0-6.0 mm ² JIS 0.5-0.9/1.25-2.0/3.5-5.5 mm ²
6PK-301E	Usable for cord end terminals		Pin terminal insulated & non-insulated wire ferrules	AWG 22/20/18/16/14/12 DIN 0.5/0.75/1.0/1.5/2.5/4.0 mm ² JIS 0.35/0.5/0.9/1.25/2.0/3.5 mm ²
6PK-301H	Insulated terminals/color coded nests		Insulated terminals & lugs	AWG 22-18/16-14/12-10 DIN 0.5-1.0/1.5-2.5/4.0-6.0 mm ² JIS 1.25/2.0/3.5-5.5 mm ²
6PK-301N	Non-insulated terminal		Non-insulated terminal & plugs	AWG 20-18/16-14/12-10/8 DIN 1.5/2.5/6.0/10.0 mm ² JIS 1.25/2.0/3.5-5.5/8.0 mm ²
6PK-301R	Vinyl insulated W/O copper sleeve		Vinyl insulated W/O copper sleeve	AWG 22-18/16-14/12-10 DIN 0.5-1.0/1.5-2.5/4.0-6.0 mm ² JIS 1.25/2.0/3.5-5.5 mm ²
6PK-301S	Usable for cord end terminals		Pin terminal insulated & non-insulated wire ferrules	AWG 10/8/6 DIN 6.0/10.0/16.0 mm ² JIS 5.5/8.0/14.0 mm ²
6PK-301U	Non-insulated open barrel connectors & D-SUB V.35		Non-insulated open barrel connectors & D-SUB V.35 terminal	AWG 22/14 DIN 0.5/2.5 mm ² JIS 0.35/2.0 mm ²
6PK-230PA	Coaxial connectors crimping tool		For crimping RG type cables 55, 58, 59, 5, 6, 21, 141, 142, 143, 210, 212, 222, 223, 303, 304, 400 Belden: 8279, 8281, 9231 & 9141	HEX .068", .098", .213", .255", .321" HEX 1.73, 2.49, 5.41, 6.48, 8.15 mm
8PK-301C	Coaxial crimping tool		RG58, RG59, RG62, RG6	HEX .068", .213", .256", .319" HEX 1.73, 5.41, 6.50, 8.10 mm
8PK-301F1	Fiber optic crimping tool		SMA, SRF, SMF fiber optic connectors	SQ .042", HEX .068", RND .133", .162", .195" SQ 1.07, HEX 1.73, RND 3.38, 4.11, 4.95 mm
8PK-301F2	Fiber optic crimping tool		SMA, SMB, FC Biconic and SC & ST fiber optic connectors, RG58, RG174, Belden8218	SQ .042", HEX .068", .151", .178", .213" SQ 1.07, HEX 1.73, 3.84, 4.52, 5.41 mm
CP-301F4	Fiber optic crimping tool		For FC, SC, ST, LC, SMA & MT-RJ fiber optic connectors	HEX .139", .151", .178", RND .134", .190" HEX 3.53, 3.84, 4.52, RND 3.40, 4.83 mm
8PK-301J	Fiber optic crimping tool		RG174, RG179, Belden 8218 fiber optic	SQ .042", HEX .068", .078", .128", .151", .178" SQ 1.07, HEX 1.73, 1.98, 3.25, 3.84, 4.52 mm



For 6PK-230C



For 6PK-301N



For 6PK-301H



For 6PK-301S



For 6PK-301R



For 6PK-301U



For 6PK-230PA



For 8PK-301F1

For 8PK-301F1 / 8PK-301F2 CP-301F4 / 8PK-301J

CRIMPERS

CP-200/CP-200R/CP-376/CP-376K Professional Modular Crimps Strips & Cuts Tool



Parallel action



Stripping twisted pair round cable

The professional modular crimping tools work for solid and stranded wires and have built-in cutting function on the rear and stripping function on the front. The smooth ratcheting mechanism will ensure positive connections each time and keep the metal frame and its built-in dies rigid and durable.

CP-200 / CP-200R



CP-376 / CP-376K



CP-200



CP-200R
Ratchet Type



CP-376



CP-376K
Ratchet Type

CRIMPERS

Features:

- For crimping modular plugs in parallel action.
- Cuts, strips, and crimps modular plugs without changing modular (DIE) set.
- Smooth ratcheting mechanism ensures positive connections.
- Integrated with round cable stripper for stripping round wires effectively in one operation.
- Middle carbon steel frame, hardened & black oxide finished.
- Lightweight, durable and compact.
- Additional locker for storage after work.
- Strips round cables.
- Patents: CP-200/CP-200R/CP-376/CP-376K: TAIWAN, CHINA, U.S.A



5PK-376K-BLADE
(6pcs/pack)

Model No.	Material	HRC	Handle	Application	Replacement blade	OAL. (mm)	Individual packing
CP-200	S45C	45°±3'	Black:T.P.R Green:PP	10P10C, AMP 8P8C/RJ45, 6P6C/RJ12, 6P4C/RJ11, 4P4C & 4P2C/RJ22 plugs, and RJ11/6P6C DEC-Offset plugs	5PK-376K-BLADE (6pcs/pack)	205	Blister card
CP-200R							
CP-376							
CP-376K							

CP-376UR / CP-376VR Modular Crimping Tool



CP-376UR

- Crimping section: plastic
- Cover plate: Black oxide finish



CP-376VR

- Crimping section: Zinc-aluminum alloy
- Cover plate: Chrome plating



Crimping



Cutting



Round cable stripping

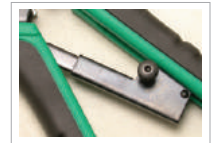

Ratchet system



5CP-376U-BLADE
(6pcs/pack)

Model No.	Material	HRC	Handle	Application	Replacement blade	OAL.(mm)	Individual packing
CP-376UR	S45C	45°±3°	Black:T.P.R Green:PP	8P8C/RJ45 modular plugs	5CP-376U-BLADE (6pcs/pack)	195	Blister card
CP-376VR							

808-376H / 808-376I / CP-376TR Modular Crimping Tool



808-376H

for 6P/8P modular plug



808-376I

for 6P/8P modular plug



Ratchet Type

CP-376TR

for 4P/6P/8P modular plug



Ratchet Type



4/6/8P Crimping



Strips twisted pair wire



Cutting



Strips flat telephone wire

Model No.	Material	Hardness	Handle	Application	Replacement blade	OAL.(mm)	Individual packing
808-376H	Low carbon steel	HR30N 55-65	PP	8P8C/RJ45, 6P2C/6P4C/6P6C RJ11/RJ12 modular plugs	5PK-376C-BLADE (6pcs/pack)	190	Blister card
808-376 I							
CP-376TR	S45C	HRC 45°±3°	Black:T.P.R Green:PP	8P8C/RJ45, 6P2C/6P4C/6P6C RJ11/RJ12 modular plugs, RJ22 4P2C/4P4C handset modular plugs			



5PK-376C-BLADE
(6pcs/pack)

CP-333 Modular Plug Crimping Tool

- For crimping RJ-45 (8P8C) and RJ-11/12 (6P6C/6P4C/6P2C) modular plugs.
- Reliable and consistent steel mechanical design with **Parallel Action** features precise crimping and force saving
- Built-in safety lock and eyelet for safety and convenience.
- Built-in eyelet for a lanyard provides convenient hanging.



**Force Saving
New Mechanism**



Cutting round cable Stripping UTP/STP round cable Crimping 6P/8P

Material		HRC	OAL (mm)	Individual packing
Handle	Body			
PVC	ABS + Carbon Steel	For stripping UTP/STP cable & cutting function For crimping RJ-45 (8P8C), RJ-11/12 (6P6C/6P4C/6P2C) modular plugs	143	Blister card

CP-373 Pro-Crimper Modular Tool



CP-373



5PK-376C-BLADE
(6pcs/pack)



CP-393 Pro-Crimper Modular Tool



CP-393 Economic type



Model No.	Material	Application	Replacement blade	OAL (mm)	Individual packing
CP-373	ABS+carbon steel	8P8C/RJ45, 6P2C/6P4C/6P6C RJ11 modular plugs, RJ-22 4P2C/4P4C handset modular plugs	5PK-376C-BLADE (6pcs/pack)	160	Blister card
CP-393			-		

CP-376M / CP-376ER / CP-376D Modular Crimping Tool



CP-376M

CP-376ER

CP-376D



Stripping

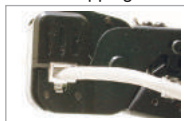

Crimping



Cutting



Safety lock for easy storage



508-376ER-B
(2pcs/pack)



508-376E-B
(2pcs/pack)



Model No.	Material	HRC	Handle	Application	Replacement blade	OAL (mm)	Individual packing
CP-376M	S45C	45±3°	Black:T.P.R Green:PP	8P8C/RJ45, 6P2C/6P4C/6P6C RJ11/RJ12 modular plugs, RJ22 4P2C/4P4C handset modular plugs	508-376ER-B (2pcs/pack)	225	Blister card
CP-376ER				8P8C/RJ45, 6P2C/6P4C/6P6C RJ11/RJ12 modular plugs	508-376ER-B (2pcs/pack)	216	
CP-376D				8P8C/RJ45, 6P2C/6P4C/6P6C RJ11/RJ12 modular plugs	508-376E-B (2pcs/pack)	200	

▶ CP-376E Modular Crimping Tool

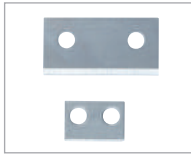

5CP-376E-B
(2pcs/pack)

Material	Application	Replacement blade	OAL (mm)	Individual packing
Low carbon steel	8P8C/RJ45, 6P2C/6P4C/6P6C RJ11/RJ12 modular plugs	5CP-376E-B (2pcs/pack)	210	Blister card

▶ CP-376KX Pro-Crimper Modular Tool

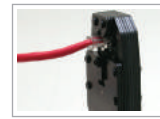

Crimping



Cutting

Material	HRC	Handle	Application	OAL (mm)	Individual packing
Carbon Steel	45°±3°	TPR	8P8C/RJ-45, 6P6C, RJ12, 6P4C/RJ11, 4P4C & 4P2C/RJ22 plugs, & RJ11 / 6P6C DEC-Offset plugs	200	Blister card

▶ CP-376L All In 1 Modular Crimping Tool



Cutting wire

Material	HRC	Handle	Application	OAL (mm)	Individual packing
Zinc Alloy	45°±3°	TPR	8P8C/RJ45, 6P2C/6P4C/6P6C RJ11/RJ12 modular plugs, RJ22 4P2C/4P4C handset modular plugs	205	Blister card

▶ 8PK-376FN Pro-Crimper Modular Tool

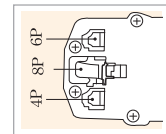

508-376E-B
(2pcs/pack)



Crimping



Stripping



Cutting

Material	Application	Replacement blade	OAL (mm)	Individual packing
Nylon + Fiber	8P8C/RJ45, 6P2C/6P4C/6P6C RJ11/RJ12 modular plugs, RJ22 4P2C/4P4C handset modular plugs	508-376E-B (2pcs/pack)	166	Blister card

▶ 808-376A/808-376B/808-376C Modular Crimping Tool



808-376A



808-376B



808-376C

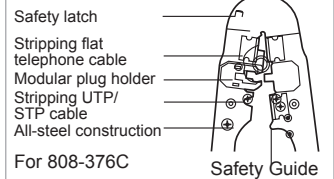

5PK-376C-BLADE
(6pcs/pack)

Model No.	Material	Hardness	Handle	Application	Replacement blade	OAL (mm)	Individual packing
808-376A	Low carbon steel	HR30N 55~65°	PVC	RJ22 4P2C/4P4C handset modular plugs	5PK-376A-BLADE (6pc/pack)	190	Blister card
808-376B				6P2C/6P4C/6P6C RJ11/RJ12 modular plugs		190	
808-376C				8P8C RJ45 modular plugs		200	

▶ CP-315/CP-316 Adjustable Compression Tool



Provides a quick, cost-effective solution to meet the termination needs in CATV, HDTV, satellite system and component video applications.

CP-315



RCA waterproof connectors



BNC waterproof connectors



F waterproof connectors



- For crimping waterproof connector F, BNC, RCA, IEC, MINI F on RG58, RG59, RG6 coaxial cable.
- With body scale to easily adjust plunger from 21 to 46mm.
- Comes with integrated handle lock for easy storage.
- Steel body with black oxide finished.

CP-316



Material	HRC	Handle	Application	OAL (mm)	Individual packing
S45C	45 ±5°	Nylon + Fiber	Connecting waterproof connectors BNC, F, RCA on RG58, RG59, RG6(3C, 4C, 5C) coaxial	120	Blister card

Material	Handle		Application	OAL (mm)	Individual packing
	Body				
ABS	S50C		For crimping connector F, BNC, RCA, IEC, MINI F coaxial cables	146	Blister card

▶ 6PK-508 Waterproof Connector Crimping Tool

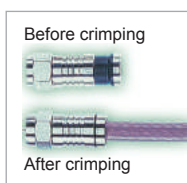

Material	HRC	Handle	OAL (mm)
S45C	45 ±3°	PVC	215
Application		Individual packing	
Connecting waterproof F connectors on RG58, RG59, RG6(3C, 4C, 5C)		Blister card	



▶ CP-313 Adjustable Compression Tool



RCA waterproof connectors



BNC waterproof connectors



F waterproof connectors

- Fast and reliable solution for home theater, CATV, satellite systems & security applications.
- Permanent and best quality connection.
- Universal design works with most compression connectors.



Material	HRC	Handle	Application	OAL (mm)	Individual packing
Carbon steel	40 ±5°	ABS	Connecting waterproof connectors BNC, F, RCA on RG58, RG59, RG6(3C, 4C, 5C) coaxial	152	Blister card

▶ CP-808/CP-806 Waterproof Connector Crimping Tool

CP-808



RCA waterproof connectors



BNC waterproof connectors



F waterproof connectors

- Compression tool for waterproof connectors such as RG-58, RG-59 & RG-6 (F, BNC, RCA) connectors.
- Advanced ratchet mechanism.
- Anti-slip handle for easy operation.



Crimping



Quick change for F, BNC, RCA Type

CP-806



Model No.	Material	Hardness	Handle	Application	OAL (mm)	Individual packing
CP-808	Middle carbon steel	HRC 45 ±3°	PP	Connecting waterproof connectors BNC, F, RCA on RG58, RG59, RG6 (3C, 4C, 5C) coaxial	195	Blister card
CP-806	SS41	HRC 45 ±3°	TPR		205	

CP-418 Copper Clad Steel Coaxial Cable Crimper

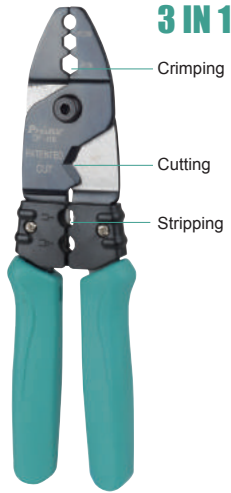

3 IN 1

Crimping

Cutting

Stripping



- All in one design for cutting & stripping & crimping RG6 & RG59 coaxial cable.
- Precision stripping hole for removing inner dielectric insulation.

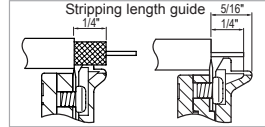
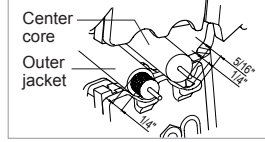

Material		Application	Replacement blade	OAL. (mm)	Individual packing
Body	Handle				
S45C	PVC	RG6, RG59	5CP-418-B	207.5	Blister card

MS-3207 Advanced 3 in 1 Connector Tool



- Comes with 3 different positions: RG-59, RG-6 and F connectors.
- Users can use one end to enlarge space between shield & insulation for RG59, another end for RG6, the other end locks F connector into tool socket and twist it onto a stripped cable end.



Handle	Application	Individual packing
PP	RG59, RG6, F connector	Blister card

CP-148 Telecom Combi-Crimper



4 IN 1



- **Stripper:** 0.8 and 1.4mm stripping holes for AWG 24/22 & 20/18/16 (Ø0.5/0.6/0.8/1.0/ 1.3mm) wires.
- **Pliers:** Long nose design for easy wire bending, pulling and holding.
- **Cutter:** Steel body with black oxide finished.
- **Crimper:** For UR/UY/UG, AMP tel splice connector, 709 series connectors.



UR/UY/UG tel splice connectors (Please refer to P.207)



AMP tel splice connectors



Thomas & Betts, Belden 709 connectors

Material		HRC		OAL (mm)	Individual packing
Body	Handle	Body	Cutting edge		
S55C	PVC	42°-48°	55°-65°	168	Blister card

1PK-CT006 Splice & Crimp Tool



- Designed for UG, UR and UY connectors.
- A special stop behind cutout prevents connectors from damage.



Application	Crimp size
UR / UY / UG connectors	Solid copper wire UR: 19 to 26 AWG UY: 22 to 26 AWG UG: 19 to 26 AWG
O.A.L (mm)	Individual packing
150	Blister card

8PK-CT005 Precision Crimping Tool W/Terminal



Terminal crimper

- Including terminal
- 0.5 x 6mm: 40pcs
 - 0.75 x 6mm: 40pcs
 - 1.0 x 6mm: 30pcs
 - 1.5 x 7mm: 20pcs
 - 2.5 x 7mm: 20pcs

Material	HRC	Handle	OAL. (mm)	Application	Individual packing
S45C	45°±3°	PVC	160	Non-insulated cord end terminals AWG 23/22/20/18/17/15/13 DIN 0.25/ 0.34/0.5/ 0.75/1.0/1.5/2.5 mm ² JIS 0.25/0.3/0.5/0.75/1.0/1.25/2.5 mm ²	Blister card

6PK-214 IDC Crimp Tool



For crimping IDC-type of connectors on ribbon cable.

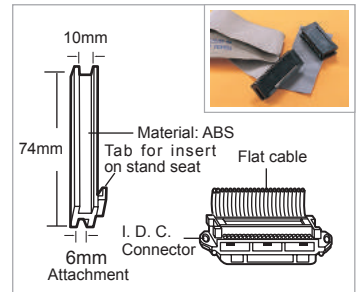

Material	HRC	Handle	Application
Low Carbon steel Handle: PP	45°±3°	PP	IDC-type connectors
Crimp Size	OAL. (mm)	Individual packing	
Height: 6-27.5 mm Width(Max): 55 mm	240	Blister card	

▶ 608-384N D-Sub Contact Crimping Tool



For female & male D-SUB miniature contacts.



Material	HRC	Handle	Crimp die profile	Application	
AISI1050 DIE:AISI4140	45°±3°	PP		Non-insulated open barrel connectors & D-SUB V.35 contact pins	
Crimp size			OAL.(mm)	Individual packing	
AWG 30-24/22-18, DIN 0.05-0.25/0.50-1.0 mm ² JIS 0.05-0.25/0.35-0.9 mm ²			205	Blister card	

▶ CP-462G Wire Ferrule Crimp Tool-Square Crimp



- Adjustable ratchet and lever action construction reduces fatigue degree.
- Special four-mandrel crimping style for square crimp.
- High quality crimping standard ensures repeatable crimping action.



Four-mandrel for square crimp



Material	HRC	Handle	Application	OAL. (mm)	Individual packing
S44C	40°±2°	Nylon	Usable for cord end terminals AWG 26 ~ 10 DIN 0.25 ~ 6.0 mm ² JIS 0.20 ~ 5.5 mm ²	175	Blister card

▶ CP-463 D-Sub Contact Crimping Tool



- Ergonomic handle design provides low-effort operation.
- Superior pull strength results.
- High quality crimping standard ensures repetitive, reliable crimping action.
- Adjustable pin height locator.



4 Way to Crimping

Material	HRC	Handle	Application	OAL.(mm)	Individual packing
SPCC + carbon steel	45°±3°	PVC	Crimping of closed-barrel RS-232 D-sub contacts. AWG 20-12 / DIN 0.5-4.0 mm ² JIS 0.5-3.5 mm ²	165	Blister card

▶ 608-400 4 Way Indent Crimping Tool



- Used to crimp closed barrel, screw machine pin and socket style contacts.
- Performs a simultaneous 4 indent crimp for superior contact retention.

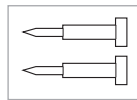

4 Way to Crimping

Material	HRC	Handle	Application	OAL.(mm)	Individual packing
S50C	45°±3°	PVC	Crimping of closed-barrel RS-232 D-sub contacts. AWG 26-20 DIN 0.2-0.5 mm ² JIS 0.2-0.5 mm ²	162	Blister card

▶ 8PK-CT004 Insertion/Extraction Tool



- RS-232 insertion & extraction use
- Red: insertion PIN, White: extraction PIN



Body	Handle	OAL.(mm)	Individual packing
Metal	PP	102	Pouch

▶ 1PK-CT007 Double End Socket Can Wrench



- Uses to place fuses in cable terminals and connect wires to fuses and binding posts.
- 3/8" & 7/16" hex double end. Plastic handle.



Material	Handle	HRC	O.A.L.(mm)	Individual packing
S45C	Plastic	45°±3°	180	Blister card

▶ CP-147 4-In-1 Long Nose Electricians Plier



Aerospace grade steel

Multi-function

Cutting / stripping / crimping / pulling / gripping.



Machined Jaw

Screw/Unscrew

Double Coated Handle

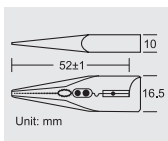

Precise Stripping
Ø1.2mm / 1.6mm copper



Accurate Crimping
1.25mm² non-insulated terminals



Pulling/Rolling
Ø1.6mm/2.0mm copper



Sharp Cutting
Hard steel Ø1.2 mm
Soft steel Ø2.0mm

Material		HRC		Application	OAL (mm)	Individual packing
Body	Handle	Body	Cutting edge			
55Cr-Ni Steel	PVC	43'±3'	60'±5'	Crimping: 1.25mm ² non-insulated terminals. Pulling & rolling: Ø1.6mm and Ø2.0mm copper Stripping: Ø1.2~1.6mm solid wire Cutting: Ø1.2mm hard steel, Ø2.0mm soft steel	163	Blister card

▶ CP-151B/CP-251B/CP-351B/CP-353 Non-Insulated Terminals Ratchet Crimping Tool



- High leverage handles, compound action mechanism provide superior mechanical advantage.
- The accurate crimping mold and self locking / releasing mechanical unit design ensure high crimping quality when crimping repeatedly.
- Ideal for electronics, electrical and home electricity installation purpose.

35% Force Saving
New Mechanism



CP-151B

CP-251B

CP-351B

CP-353

Material: AISI 4140
Hardness:
HRC 40'~42'

Crimping pressure adjustment

Non-slip TPR handles

Material: S45C
Hardness:
HRC 43'~45'
Black oxide finish

Ratcheting release trigger

Energy saving ratcheting design

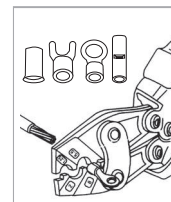

Wire size stamped on terminals

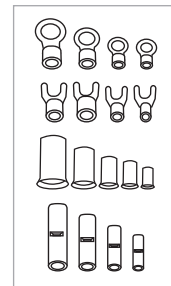

For non-insulated terminals

Model No.	Material	HRC	Handle	Crimper die profile	Application	OAL(mm)	Individual packing
CP-151B	Frame: S45C Die: AISI 4140	40' - 42'	TPR		Non-insulated spade/ring terminals, AWG 22-16/16-14/12/10, JIS 1.25/2.0/3.5/5.5 mm ² DIN 1.5/2.5/4.0/6.0 mm ²	176	Blister card
CP-251B					Non-insulated spade/ring terminals, AWG 22-16/16-14/12-10/8/6, DIN 1.5/2.5/6.0/10/16 mm ² JIS 1.25/2.0/5.5/8.0/14 mm ²	245	
CP-351B					Non-insulated spade/ring terminals, AWG 8/6/4/2, DIN 10/16/25/35 mm ² , JIS 8/14/22/38 mm ²	350	
CP-353					AWG 12-10 / 8 / 6 / 4, DIN 4-6 / 10 / 16 / 25 mm ² , JIS 5.5 / 8.0 / 14 / 22 mm ²	332	

▶ 8PK-CT015 / 8PK-CT016 Ratchet Crimping Tool For Non-Insulated Terminal



- High leverage design.
- Ratcheting mechanical design ensures high quality.

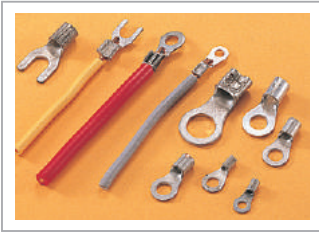

8PK-CT015



8PK-CT016



Model No.	Material	HRC	Handle	Crimper die profile	Application	OAL. (mm)	Individual packing
8PK-CT015	Frame: S45C Die: AISI 4340	40 \pm 2 $^{\circ}$	PVC		Non-insulated Terminal AWG 22-16/16-14/12-10/8 DIN 1.5/2.5/6.0/10 mm 2 JIS 1.25/2.0/5.5/8.0 mm 2	260	Blister card
8PK-CT016		40 \pm 2 $^{\circ}$			Non-insulated Terminal AWG 12-10/8/6/4 DIN 4.0-6.0/10/16/25 mm 2 JIS 5.5/8.0/14/22 mm 2	350	

▶ 8PK-CT150 / 8PK-CT120 Heavy Duty Crimping Tool



For terminating cable lugs from 10mm 2 -95mm 2 with non-ratchet screw adjustment design for aluminum AWG 8 to 4/0 and copper AWG 8 to 250 MCM (8PK-CT120) / 300MCM (8PK-CT150)

- The best crimping solution for heavy duty tinned terminals
- Adjustable crimp nests with clearly marked gauges
- Lightweight and easy for operation
- Rugged cast steel construction for durability
- For terminating insulated and non-insulated cable lugs from AWG 8 to 250MCM copper and AWG 8 to 4/0 Aluminum



8PK-CT120

8PK-CT150



Model No.	Material	Handle	Crimper die profile	Application	OAL. (mm)	Individual packing
8PK-CT120	Body: AISI 1021 Die: SCM440	FCD45		Cable lugs AWG 8, 6, 4, 2, 1/0, 2/0, 3/0, 250 MCM DIN 10, 16, 25, 35, 50, 70, 95, 120 mm 2	570	Color box
8PK-CT150	Body: Aluminum alloy Die: SCM 440	Iron pipe		Cable lugs AWG 8, 6, 4, 2, 1/0, 2/0, 3/0, 4/0, 5/0, 300MCM DIN 10, 16, 25, 35, 50, 70, 95, 120, 150mm 2	670	Inner box + Color label

▶ PM-804 Multi-Crimp Tool

- Wire cutter in nose.
- Plastic-coated handle.
- For crimping non-insulated terminals from 10 to 22 AWG.

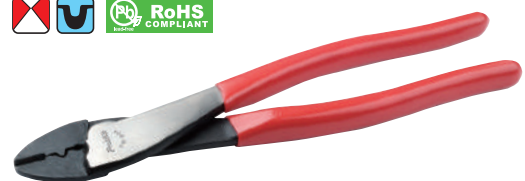
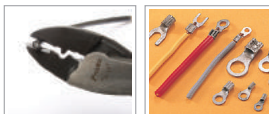

Material	Handle	HRC	Application	OAL. (mm)	Individual packing	
		Body	Hard steel			
S60C	PVC	42 \pm 3 $^{\circ}$	ϕ 1.6mm	Non-insulated terminal 10~22 AWG	248	Blister card

STRIPPERS



Strip Gently, Cut Neatly, Work Perfectly.



Pro'sKit[®]

886-2-22183233
Sales support

pk@mail.prokits.com.tw
E-mail

www.prokits.com.tw
Global website

Strippers

All of Pro'sKit® precision strippers are passed by strict quality control of precision instruments and ensuring accurate stripping with much less effort against injury and long service life. Pro'sKit® offers a complete range of strippers, including precision wire strippers, automatic wire strippers, coaxial cable strippers, round cable slitting & ringing tools, for most applications, such as electrical wire, hook-up wire, multi-conductor cable, flat telephone cable, twisted pair round cables, coaxial cables, fiber optics cables...etc.

Gripping

Mainly used in holding, pulling and bending wires.

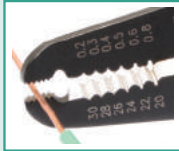

Cutting wires



With cutting edge for soft wires from Ø0.25 to Ø1.2mm (AWG 30 to 16), not for hard or thick objects.

Wire spring



Stripping flat telephone cables

For stripping electronic flat cable, wire width up to 12mm.



Stripping wires

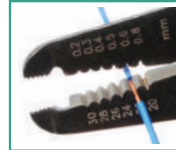

Pro'sKit® precision strippers are processed by CNC lathe to guarantee the accurate size of notches and to accurate stripping without damage.



Pro'sKit® end-action wire stripper comes with V type design and screw adjustment to preset wire size up to 3.9mm.



Pro'sKit® automatic wire stripper requires much less effort to strip wires quickly. The notch size could be custom made upon special request.

The spring design is very important! It lets handles self-opening to make work faster with much less effort.

2 blade stripping coaxial cables

2 blade coaxial cable stripper is usually used in stripping braided shields coaxial cable

3 blade stripping coaxial cables

3 blade coaxial cable stripper is usually used for stripping foil/braided shields coaxial cables

Pro'sKit® coaxial cable strippers and twisted pair round cable strippers are designed with lever action requires much less force and support users operating as effectively as possible. Blades made from special grade steel provide sharp and durable outcome. Especially, some of Pro'sKit strippers come with adjustment wire size function to preset wire size to meet applications requirement.

Cutting wires

For cutting soft wires from Ø0.25 to Ø1.0mm (AWG 30 to 18), not for hard or thick objects.



Stripping flat telephone cables

For stripping flat telephone cable



Stripping wires

For stripping electrical wires



Stripping twisted pair round cables

For stripping twisted pair round cables.



Wire spring



Safety Caution

- Blades are very sharp, please use carefully and keep them out of reach of children.
- Blades are consumables, please choose in addition when being damaged.

CP-3001D / CP-3002D Precision Wire Stripper

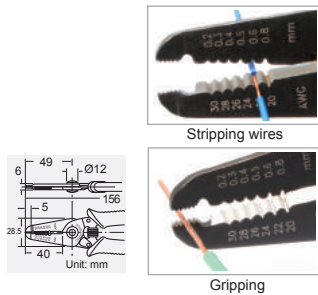

Model No.	Material		HRC	Application	OAL (mm)	Individual packing
	Body	Handle				
CP-3001D	SK7	TPR	50'±3'	AWG: 30, 28, 26, 24, 22, 20 / 0.2, 0.3, 0.4, 0.5, 0.6, 0.8 mm	169	Blister card
CP-3002D				AWG: 20, 18, 16, 14, 12, 10 / 0.8, 1.0, 1.3, 1.6, 2.0, 2.6 mm		

8PK-3001D / 8PK-3002D Precision Wire Stripper

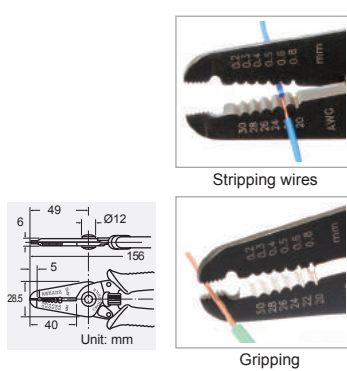

Model No.	Material		HRC	Application	OAL (mm)	Individual packing
	Body	Handle				
8PK-3001D	SK7	PVC	50'±3'	AWG: 30, 28, 26, 24, 22, 20 / 0.2, 0.3, 0.4, 0.5, 0.6, 0.8 mm	156	Blister card
8PK-3002D				AWG: 20, 18, 16, 14, 12, 10 / 0.8, 1.0, 1.3, 1.6, 2.0, 2.6 mm		

CP-301G / CP-302G Precision Wire Stripper



Model No.	Material		HRC	Application	OAL (mm)	Individual packing
	Body	Handle				
CP-301G	S50C	PVC	45'±3'	AWG: 30, 28, 26, 24, 22, 20 / 0.2, 0.3, 0.4, 0.5, 0.6, 0.8 mm	165	Blister card
CP-302G				AWG: 20, 18, 16, 14, 12, 10 / 0.8, 1.0, 1.3, 1.6, 2.0, 2.6 mm		

SR-363A / SR-363B 2 in 1 Round Cable Cutter & Stripper



The stripper is processed by CNC machining process to ensure its accuracy.

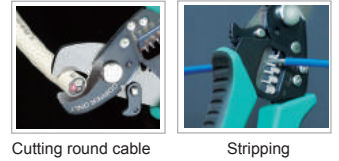

Model No.	Material		HRC	Application	OAL (mm)	Individual packing
	Body	Handle				
SR-363A	SK5	TPR	54'±3'	Stripping AWG 14/12/10/8 Cutting round cable up to 10.7mm	168	Blister card
SR-363B				Stripping AWG 20/18/16/14/12/10 Cutting round cable up to 10.7mm		

1PK-3001E / 1PK-3002E Precision Wire Stripper



Conductive handles
Resistivity: 10⁻³~10⁻⁶

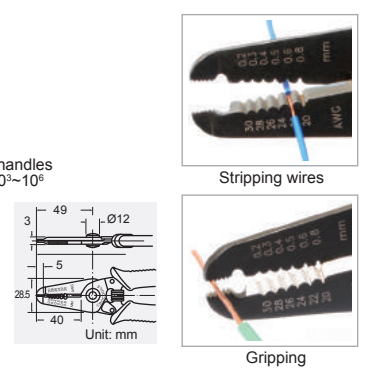

Model No.	Material		HRC	Application	OAL (mm)	Individual packing
	Body	Handle				
1PK-3001E	SK7	TPR	50'±3'	AWG: 30, 28, 26, 24, 22, 20 / 0.2, 0.3, 0.4, 0.5, 0.6, 0.8 mm	156	Blister card
1PK-3002E				AWG: 20, 18, 16, 14, 12, 10 / 0.8, 1.0, 1.3, 1.6, 2.0, 2.6 mm		

8PK-3161 / 8PK-3162 / 8PK-3163 7 In 1 Tool

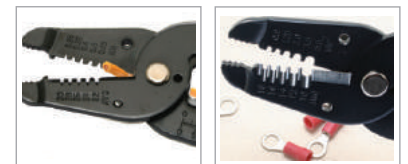

Model No.	Material		Hardness	Application	OAL (mm)	Individual packing
	Body	Handle				
8PK-3161				AWG: 18, 16, 14, 12, 10 / 0.9, 1.25, 2.0, 3.5, 5.5 mm ²		
8PK-3162	Low carbon steel	PVC	HR30N 55-65	AWG: 26-24, 22, 20, 18, 16 / 0.2, 0.35, 0.5, 0.9, 1.25 mm ²	170	Blister card
8PK-3163				AWG: 30, 28, 26, 24, 22 / 0.25, 0.32, 0.4, 0.5, 0.65 mm		

CP-318/CP-319 VVF 1.6/2.0 Wire Stripper



- Stripping & cutting VVF 1.6 & 2.0 mm wire.
- Built-in scale for measuring 2-9cm & 12 mm.
- Serrated jaw which provides firm gripping and bending.
- Ergonomic & Non-slip handles for user comfort.

Model No	Material		Application	OAL. (mm)	Individual packing
	Body	Handle			
CP-318	S45C	PVC	VVF 1.6 & 2.0 mm 2 core wire	192.5	Blister card
CP-319			VVF 1.6 & 2.0 mm 3 core wire		

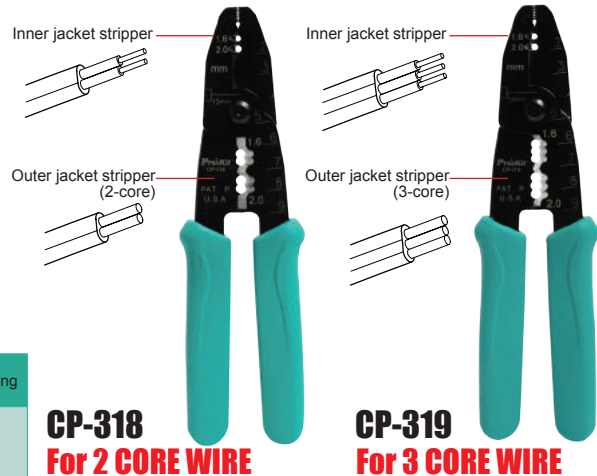

CP-412G / CP-413G Heavy Duty Wire Stripper/Crimper



- Combination of cutting, stripping and crimping function.

Material	Body	Handle	HRC	Individual packing	Applications		
					Bolt cutter	Crimp insulated and non-insulated terminals	Other
S50C		PVC	45°±3°	Blister card			

Model No.	Application			OAL. (mm)
	Wire strip	Bolt cutter	Crimp	
CP-412G	Stranded wire: 24-22, 20, 18, 16, 14, 12 AWG Solid wire: 22-20, 18, 16, 14, 12, 10 AWG	4-40, 6-32, 8-32, 10-24, 10-32	Barrel-type insulated & Non-insulation: 22-18, 16-10 AWG	206
CP-413G	Stranded Wire: 26-24, 22-20, 18, 16, 14, 12, 10 AWG Solid Wire: 22-20, 18, 16, 14, 12, 10, 8 AWG	4-40, 10-32, 10-24, 8-32, 6-32	Insulation: 26-14, 12-10 AWG Non-insulation: 22-10 AWG	215

CP-412G



CP-413G



8PK-033/8PK-313A/8PK-313B Heavy Duty Wire Stripper / Crimper



- Combination of cutting, stripping and crimping function.

Material	Body	Handle	HRC	Individual packing	Applications		
					Bolt cutter	Crimp insulated and non-insulated Terminals	Other
SAE 1008		PVC	45°~64°	Blister card			

Model No.	Application			OAL. (mm)
	Wire strip	Bolt cutter	Crimp	
8PK-033	0.75, 1.0, 1.5, 2.5, 4.0, 6.0mm	M2.6, M3, M3.5, M4, M5	1.5, 2.5, 6mm ²	200
8PK-313A (Inch)	AWG: 22-20, 18, 16, 14, 12, 10	4-40, 6-32, 8-32, 10-24, 10-32	Insulation: 22-18, 16-14, 12-10 Non-insulation: 22-18, 16-14, 12-10 AWG	235
8PK-313B (Metric)	0.75, 1.0, 1.5, 2.5, 4.0, 6.0 mm ²	M2.6, M3, M3.5, M4, M5	Insulation: 1.5, 2.5, 6 mm ² Non-insulation: 1.5, 2.5, 4-6 mm ²	

8PK-033



8PK-313A/B



▶ 8PK-CT009 / 8PK-CT009A Multi-Purpose Crimping Tool



Material		HRC	OAL. (mm)	Individual packing
Body	Handle			
S45C	PVC	45°±3°	210	Blister card

Model No.	Application		
	Wire strip	Bolt cutter	Crimp
8PK-CT009 (Metric)	0.6, 0.8, 1.0, 1.3, 1.6, 2.0, 2.6 mm	M2.6, M3, M3.5, M4, M4.5, M5	Insulated & Non-insulated: 2.6~1.3, 1.0~0.6 mm
8PK-CT009A (Inch)	22, 20, 18, 16, 14, 12, 10, AWG	4-40, 5-40, 6-32, 8-32, 10-32, 10-24	Insulated & Non-insulated: 10~16, 18~22AWG

▶ CP-415 Cutter Stripper And Crimper



Material		HRC	OAL. (mm)	Individual packing
Body	Handle			
SK7	TPR	53°±3°	175	Blister card

Wire strip	Application		Crimp
	Bolt cutter		
30~10 AWG (0.05~5.5mm ²)	Cutter:30~12 AWG(0.25~2.0 mm) Cutter: 30~10 AWG(0.05~5.5 mm ²)	Non-insulated AWG: 22-18/16-14/12-10 JIS: 1.25/2.0/3.5-5.5mm ² DIN: 0.9/2.5/4-6/ mm ²	

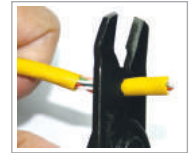

Stripper



Cutter

▶ 6PK-223 Wire Stripper Cutter



Material		HRC	Application	Replacement blade	OAL. (mm)	Individual packing
Body	Handle					
S45C	PVC	45°±3°	Stripping wire From 30~10 AWG (0.5~4mm)	5PK-322-B	127	Blister card

▶ CP-108 Wire Stripper Cutter



Material		HRC	Application	OAL. (mm)	Individual packing
Body	Handle				
AISI 1050	PVC	45°±3°	Stripping wire from 30~10 AWG (0.5~4mm)	127	Blister card

▶ 8PK-208D Wire Stripper / Cutter

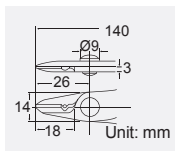

Material		HRC	Application	OAL. (mm)	Individual packing
Body	Handle				
SK7	PVC	50°±3°	Cutting capacity: Ø 1.3 mm / 16 AWG Wire stripper: Ø 0.4 mm / 26 AWG	140	Blister card

▶ CP-367A Self-Adjusting Insulation Stripper



- To adjust length stop of 8-12mm.
- Fully insulated for user comfort.



Material		HRC	Application	OAL. (mm)	Individual packing
Body	Blade				
Nylon	SK5	55°±3°	Stripping: AWG24~10/0.2~6.0mm ² Cutter: under Ø 2.0mm	115	Blister card

CP-380 Automatic Wire Stripper



SPCC Blade For Stranded Wires AWG 16-8



SPCC Blade more durable

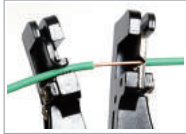

Fast Compound Wire Stripping Action



Precisely Machined Holes



Material			Hardness	Applications	OAL. (mm)	Individual packing
Body	Blade	Handle				
Alloy Zinc Steel	SPCC Steel -Plate-ColdRolled-Coil	TPR	HV500~800	For stripping AWG16-8, JIS 1.25-8mm ²	170	Blister card

CP-246 Solar Cable Stripper



- Reliable stripping without damage, particularly for solar cables (2.5- 6.0 mm²)
- With adjustable length stop for accurate stripping length setting.



Material			HRC	Application	OAL. (mm)	Individual packing
Body	Blade	Handle				
Zinc alloy	SK5	TPR	56 [±] 2 [°]	For 2.5/4/6mm ² (AWG 14/12/10) solar cable	177	Blister card

608-369A / 608-369B / 608-369C Wire Stripping Tool



Material			Hardness	
Body	Blade	Handle		
Zinc alloy	SS 41	PVC	Body: HV 450~800 Blade: HRC 45 [°] ~55 [°]	
Model No.	Application	OAL. (mm)	Individual packing	
608-369A	0.5, 1.2, 1.6, 2.0mm	170	Blister card	
608-369B	1.0, 1.6, 2.0, 2.6, 3.2mm			
608-369C	22, 18-20, 14-16, 12, 10, 8(AWG) for solid wire			



608-369A

0.5, 1.2, 1.6, 2.0mm

608-369B

1.0, 1.6, 2.0, 2.6, 3.2mm

608-369C

22, 18-20, 14-16, 12, 10, 8(AWG)

CP-369AE / CP-369BE / CP-369CE Wire Stripping Tool



Economic type

Material			Hardness	
Body	Blade	Handle		
Zinc alloy	S45C	PVC	Body: HV450~800 Blade: HRC45 [°] ~55 [°]	
Model No.	Application	OAL. (mm)	Individual packing	
CP-369AE	0.5, 1.2, 1.6, 2.0mm	170	Blister card	
CP-369BE	1.0, 1.6, 2.0, 2.6, 3.2mm			
CP-369CE	22, 18-20, 14-16, 12, 10, 8 (AWG) for solid wire			



CP-369AE

0.5, 1.2, 1.6, 2.0mm

CP-369BE

1.0, 1.6, 2.0, 2.6, 3.2mm

CP-369CE

22, 18-20, 14-16, 12, 10, 8 (AWG)

▶ 8PK-371/8PK-371D Automatic Wire Stripper & Crimper



8PK-371



- Made by precision machines for a long-life usage.
- 15N 88~90 (HRC55°~60°) blade cuts wire fast and smoothly.



Stripping



Crimping

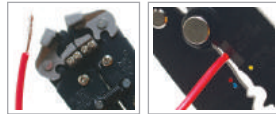

Stripping

Cutting

Material			HRC		OAL (mm)	Individual packing
Body	Blade	Handle	Cutting edge	Blade		
SS 41	Powder metallurgy	PVC	55°~60°	52°~57°	210	Blister card
Application						
Stripper range: (0.2~6.0mm ²) AWG 10-24 For insulated terminals 22-10 AWG (0.5-6.0mm ²) For non-insulated terminals 22-10 AWG (0.5-6.0mm ²) For auto ignition terminals 7-8mm						



8PK-371D



- Micro adjusting the swivel knob to strip electrical wire gauge smaller than AWG24 (0.2mm²)
- Adjustable stopper is swiveled if user does not use this function.



Stripping



Crimping



Micro adjuster knob & wire stopper



Cutting

Material			HRC		OAL (mm)	Individual packing
Body	Blade	Handle	Cutting edge	Blade		
SS 41	Powder metallurgy	ABS+TPR	55°~60°	52°~57°	210	Blister card
Application						
Stripper range: AWG 24-10 gauge (0.2~6.0mm ²). For insulated terminals 22-10 AWG (0.5-6.0mm ²) For non-insulated terminals 22-10 AWG (0.5-6.0mm ²) For auto ignition terminals 7-8mm						

▶ 808-080 Wire Stripping Tool



- ABS handle with S55C blade.
- Precise and durable.



Ideal for flat cable stripping

Material		HRC Blade	Application	OAL (mm)	Individual packing
Body	Blade				
ABS & low carbon steel	S55C	45°~55°	Stripping flexible cable from 0.2~4mm ²	172	Blister card

▶ CP-080E Wire Stripping Tool



- ABS handle with 65Mn blade.



Cutting

Material		HRC Blade	Application	OAL (mm)	Individual packing
Body	Blade				
ABS & low carbon steel	65Mn	45°~55°	Stripping flexible cable from 0.2~4mm ²	172	Blister card

▶ 6PK-501 Wire Stripper Tool

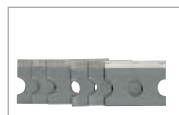

Ideal for flat cable stripping
Replacement blade
5PK-376A-BLADE
(6 pcs/package)

Material		Application	OAL (mm)	Individual packing
Body	Blade			
ABS	SK5	For wire(UTP/STP) or wire & multiconductor cable from ø3.2-9mm max.	112	Blister card

▶ CP-501BN Wire Stripper Tool



- For stripping UTP/STP cable, flat telephone cable and coaxial cable with cutter function.

Material		Application	OAL (mm)	Individual packing
Body	Blade			
ABS	SK5	For wire(UTP/STP) or wire & multiconductor cable from ø3.2-9.5mm max.	112	Blister card

CP-505 Universal Stripping Tool



Black hook and loop for folding back the braided shield



- Reversible stripping UTP/STP cable, flat telephone cable and coaxial cable with cutting function.
- Comes with black hook and loop for folding back the braided shield.

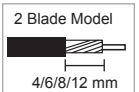

Blade: 5CP-505-B (4pcs/pack)



Cassette: 5CP-505-RG (1pcs/pack)



Material		Application	OAL. (mm)	Individual packing
Body	Blade			
ABS	SK5	Stripping UTP/STP twisted pair round cable, flat telephone cable, RG-59/11/7/6 coaxial cable	125	Blister card

CP-508 Universal Stripping Tool

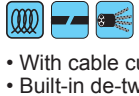

- With cable cutter for round cable and flat cable.
- Built-in de-twisted and straightening wire function.
- Comes with black hook and loop for folding back the braided shield.
- Durable SK5 preset cutting blades provide precise, accurate cable stripping.

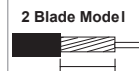

Blade: 5CP-508-B



Cassette: 5CP-508-RG



Material		Application	OAL. (mm)	Individual packing
Body	Blade			
ABS	SK5	UTP/STP, RG-59/6/7/11	135	Blister card

CP-522 Rotary Coaxial Cable Stripper



Black hook and loop for folding back the braided shield

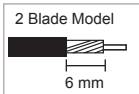

Cassette: 5CP-505-RG (1pcs/pack)

- Designed for stripping 59/6/7/11 coaxial cable.



Material		Application	OAL. (mm)	Individual packing
Body	Blade			
ABS	SK5	coaxial cable RG59 / 6 / 7 / 11	128	Blister card

CP-521 Coaxial Stripping Tool



- Designed for stripping RG-58/59/6/62 coaxial cable.
- Special POM (Polyoxymethylene) structure, easy operation and force saving.



Material		Application	OAL. (mm)	Individual packing
Body	Blade			
POM	SK5	RG-58/59/6/62	115	Blister card

CP-507 Coaxial Cable Stripper & Cutter



- Black Hook and Loop for folding back the braided shield.
- Unique, safe design construction.

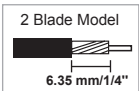

Material		Application	OAL. (mm)	Individual packing
Body	Blade			
ABS	SK5	RG-59/6	111	Blister card

CP-509 Coaxial Stripping Tool

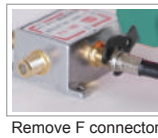

Remove F connector

- With hex wrench for easy installing or removing F connector from splitter.
- Durable SK5 preset cutting blades provide precise, accurate cable stripping.

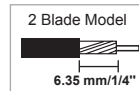

Material		Application	OAL. (mm)	Individual packing
Body	Blade			
ABS	SK5	RG-59/6/7/11	130	Blister card

CP-512 Rotary Coaxial Cable Stripper



- Designed for easy single operation of one step stripping RG-59/6/7/11 coaxial cable.
- Unique & safe design construction to avoid blade exposure and accident.
- Black hook for folding back the braided shield.



Black hook for folding back the braided shield



Quick strips RG59/RG6/RG7/RG11



Replacement blade cassette:5CP-505-RG (1pcs/pack)

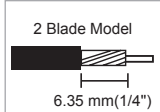

2 Blade Model
6.35 mm (1/4")

Material		Application	OAL. (mm)	Individual packing
Body	Blade			
ABS	SK5	RG-59/6/7/11	94	Blister card

6PK-501N Coaxial Stripping Tool



- Slot "A" for stripping center core.
- Slot "B" for stripping outer jacket. Rotating each by 3 to 5 times in clockwise direction (as arrow)
- Stripping cables by 2 steps.

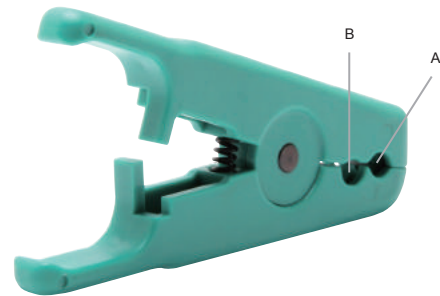

Material		Application	OAL. (mm)	Individual packing
Body	Blade			
ABS	SK5	RG-58/59/62/6	100	Blister card

6PK-332 Rotary Coaxial Cable Stripper

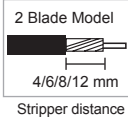

2 Blade Model
4/6/8/12 mm
Stripper distance



Replacement blade :
5PK-3321
(6pcs/pack)



Material		Application	OAL. (mm)	Individual packing
Body	Blade			
ABS	SK5	RG-58/59/62/6/3C2V/4C/5C	98.5	Blister card

6PK-322 Rotary Coaxial Cable Stripper

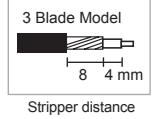

3 Blade Model
8 4 mm
Stripper distance



Material		Application	OAL. (mm)	Individual packing
Body	Blade			
ABS	SK5	Thinnet RG-58/59/6 coax cable & other cable size	108	Blister card

6PK-312B Rotary Coaxial Cable Stripper

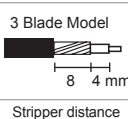

3 Blade Model
8 4 mm
Stripper distance



Replacement blade :
5PK-312B-B
(6pcs/pack)

Material		Application	OAL. (mm)	Individual packing
Body	Blade			
ABS	SK5	RG-58/59/62/3C/4C	105	Blister card

6PK-312S Rotary Coaxial Cable Stripper

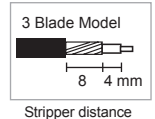

3 Blade Model
8 4 mm
Stripper distance



Replacement blade :
5PK-312B-B
(6pcs/pack)

Material		Application	OAL. (mm)	Individual packing
Body	Blade			
ABS	SK5	For big cable O.D. around ϕ 10.5mm, Such as RG213	105	Blister card

CP-326 / 8PK-325 / 8PK-325B / 8PK-502 Round Cable Slitting And Ringing Tool



8PK-325



8PK-325B



8PK-502



CP-326

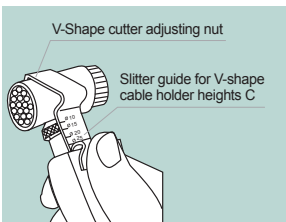

Cable slitting and stripping



Replacement blade:
5PK-325-BL



Replacement blade:
5PK-502-B



Replacement blade:
5CP-326-B

Model No.	Material			Application	OAL. (mm)	Individual packing
	Body	Blade	Blade holder			
8PK-325	ABS + Fiber glass	SK5	Plastic	Strip cables from $\varnothing 4.5-25\text{mm}$ ($\varnothing 0.18''-1.0''$) diameter	150	Blister card
8PK-325B			Metal	Strip cables from $\varnothing 4.5-25\text{mm}$ ($\varnothing 0.18''-1.0''$) diameter	150	
8PK-502	Nylon+Fiber	SWP spring steel		Single or multiple conductor cable up to $\varnothing 1.75''$ ($\varnothing 44.5\text{mm}$) blade can be adjusted for jacket thickness up to $0.125''$ (3.2mm)	140	
CP-326	ABS	Steel 412JZ	-	Strips 4~28mm ($0.16''-1.1''$) cable	140	

8PK-CT001 UTP/STP Cable Stripper



A simple tool for UTP/STP cable. Just stripping 3 circles to extract the jacket of cable. Also a function for 110 punch down tool.

Material	Application	O.A.L.(mm)	Individual packing
poly-Resin	Stripping UTP/STP cable/ 110 Punch down	94	Blister card

CP-511A Universal Stripping Tool



Stripping regular cable



Stripping low volt cable

Material		Application	OAL. (mm)	Individual packing
Blade	Handle			
SK5	ABS + TPR	Regular cable AWG 20/18/16/14/12/10 (0.5/1.0/2.5/4.0/6.0 mm ² , RG59/RG6 coaxial cable, $\varnothing 8-13\text{mm}$ low-volt cable)	125	Blister card

STRIPPERS

PUNCH DOWN TOOLS



Exposed wires can be dangerous and may cause your connections to short out. Pro'sKit punch down tools ensure perfect wires.

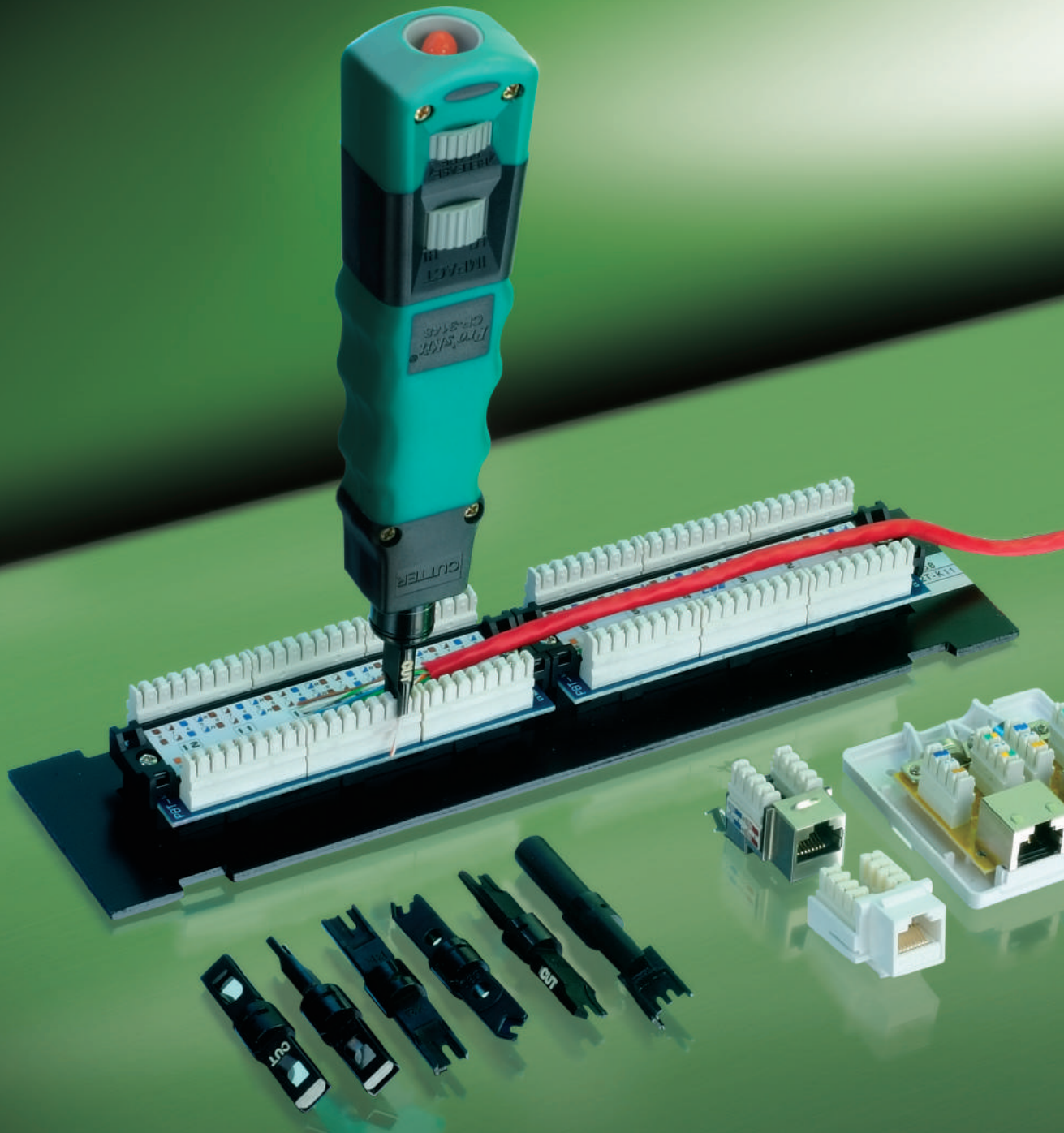

Pro'sKit[®]

886-2-22183233
Sales support

pk@mail.prokits.com.tw
E-mail

www.prokits.com.tw
Global website

CP-3148 / CP-3150 Impact and Punch Down Tool



- Ergonomic cushion grip with duplex color design, molded to shape of hand provides comfort and easy operation, non-slip grip.
- Spare blade storage chamber in handle.
- Increased HI/LOW forces to meet demands of all category cables through Cat6.



Storage for a spare blade



Impact



Round type holder

Model No.	Material		Application	Standard blade type	Optional blade	OAL (mm)	Individual packing
	Blade	Body					
CP-3148	SAE	ABS + TPR	Hi-low adjust pressure (Hi: 40lbs 178N, Low: 30lbs /133N)	110/88 & 66(5CP-16A)	5CP-16 series	162 (w/o blade)	Blister card
CP-3150	4140	TPR		1pcs 110/88 & 1 pcs dual 66 with cut function (5CP-16, 5CP-16B)			

* 40 lbs = 18kg, 30lbs = 13.6kg

PD-3141C Impact and Punch Down Tool



- A built-in combination hook/spudger for tracing and removing wires.
- Twist-lock style holder provides quick, easy blade changes and prevents pullout.
- An additional safe storage for one more spare blade.

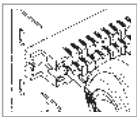

Wire-pull



Wire-push



Impact



Round type holder

Blade	Material		Application	Standard blade type	Optional blade	OAL (mm)	Individual packing
	Blade	Body					
SAE 4140	TPR+PP (Anti-slip) (w/o Blade)		Hi-low adjust pressure(Hi:15±2kg, Low:10±2kg)	110/88	5CP-16 series	168 (w/o blade)	Blister card

PD-3141D Punch Down Tool



- Twist-lock style holder provides quick, easy blade changes and prevents pullout.
- An spare blade storage chamber in handle with cover.
- The rubber grip handle provides easy operation and comfortable use.

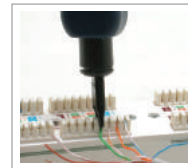

Punch and cut cable terminals



Round type holder

Blade	Material		Application	Standard blade type	Optional blade	OAL (mm)	Individual packing
	Blade	Body					
SAE4140	Rubber (Anti-slip) (w/o Blade)		Anti-slip	110/88	5CP-16 series	115 (w/o blade)	Blister card

5CP-16 Series / 5PK-3140N-BIX Spare Blades



For CP-3148, CP-3150, PD-3141C, PD-3141D punch down tool



Round type



5CP-16



5CP-16A



5CP-16B



5CP-16D



5CP-16BK



5PK-3140N-BIX

Individual packing: Bulk

Model No.	For terminal block
5CP-16	Dual 66 type, one end with cut function
5CP-16A	66, 110/88 type, both end with cut function
5CP-16B	Dual 110/88 type, one end with cut function

Model No.	For terminal block
5CP-16D	Dual 630A phone jack, non-cut function
5CP-16BK	Dual KRONE 110 type, one end with cut function
5PK-3140N-BIX	BIX, with cut function

▶ CP-3151/CP-3152 Impact and Punch Down Tool



- Integral blade storage chamber in handle.
- Increased HI/LOW impact forces to meet demands of all category cables through Cat 6.
- The nonslip handle provides easy operation and user comfort.



Replacement blade :
5CP-3152-110 for 110/88 type
5CP-3152-66 for 66 type



Storage for a spare blade



Punch and cut cable terminals

Model No.	Material		Application	Standard blade Type	OAL. (mm)	Individual packing
	Blade	Body				
CP-3151	40cr	ABS	Hi-Low adjust pressure (High 15±2kg, Low 10±2kg)	1pce 110/88 & 1pce 66 double end blade with cut function	146	Blister card
CP-3152				1pce 110/88 double end blade with cut function		
CP-3152-H	Handle Only					

▶ 8PK-315DR Multi-Pair Impact Tool



- For use on LAN & telecom, seating 5 pairs UTP (24 AWG) at a time.
- Suitable for both 110 type cable side & cross-connect side terminals blocks.
- The termination block heel w/blades are changeable & reversible.
- One end for seating & cut off wires & the other end for seating wires only.



Material	Blade	Body	Application	Standard blade type	Optional blade	OAL. (mm)	Individual packing
SK 5	T.P.R (Anti-slip)		Hi-low adjust pressure (Hi: 15±2kg, Low: 10±2kg)	110 (5PK-15D)	5PK-15B/ 5PK-15C	140 (w/o blade)	Blister card

▶ CP-3140 Punch Down Tool with 110 Blades



Impact



Storage for a spare blade

Economic Type

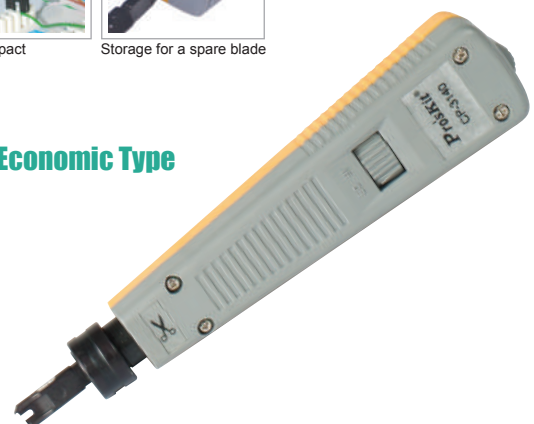

Blade type	Model No.	For terminal block
	5CP-3140-110	Dual 110/88 type, one end with cuts function(Hex type)
	5CP-3140-66	Dual 66 type, one end with cuts function(Hex type)

Material	Blade	Body	Application	Standard blade type	Optional blade	OAL. (mm)	Individual packing
SAE 4140		ABS	Hi-low adjust pressure (Hi: 15±2kg, Low: 10±2kg)	110/88 (5CP-3140-110)	5CP-3140-66	160 (w/o blade)	Blister card

▶ PD-3141EN/PD-3141EBN Mini Punch Down Tool



- Nonslip rubber handle for user comfort.
- Comes with fixed blade and cut function.



▶ CP-3145A / CP-3145B Punch Down Tool



- Rotatable blade holder for easy selection of proper blade type end.
- Perfect for small jobs and the do-it-yourself installer.



- Rotatable blade holder
- Blade on both ends



Model No.	Material		Application	Standard blade type	OAL. (mm)	Individual packing
	Blade	Body				
PD-3141EN	SAE 4140	Rubber (Anti-slip)	Fixed blade, not changable	66(with cutter)	129	Blister card
PD-3141EBN				110/88(with cutter)		

Model No.	Material		Standard blade type	OAL. (mm)	Individual packing
	Blade	Body			
CP-3145A	S45C	ABS	110/88 blade, one end with, one end without cut function	128	Blister card
CP-3145B	110/88 type: S45C 66 type: SAE 4140		66, 110/88 type, both ends with cut function		

▶ CP-3141 Impact Terminal Tool for KRONE

▶ 8PK-3141A Impact Tool

▶ 8PK-3141B Impact Terminal Tool



Economic Type



Model No.	Material		Application	Standard blade type	OAL. (mm)	Individual packing
	Blade	Body				
CP-3141 8PK-3141A 8PK-3141B	S45C	ABS	Combination impact and torque tool function. Both side (screwdriver & wire-pull function)	KRONE	175	Blister card

▶ 8PK-324B Impact and Punch Down Tool



Material		Application	Standard Blade type	Optional blade	OAL. (mm)	Individual packing
Blade	Body					
SAE 4140	ABS+Fiber	Impaction function	110/88(5PK-14B)	5PK-14 series	114 (w/o blade)	Blister card

* 40 lbs = 18kg, 30lbs = 13.6kg



Punch and cut cable terminals



Flat type holder



▶ 5PK-14 Series Spare Blades



For 8PK-324B punch down tool



Flat type holder



5PK-14



5PK-14A



5PK-14B



5PK-14C



5PK-14D



5PK-14BK



5PK-14P

Model No.	For terminal block
5PK-14	Dual 66 type, one end with cut function
5PK-14A	Dual 66 110/88 type, both end with cut function
5PK-14B	Dual 110/88 type, one end with cut function
5PK-14C	Dual 66 110/88 type, both end w/o cut function

Model No.	For terminal block
5PK-14D	Dual 630A phone jack, non cut function
5PK-14BK	Dual KRONE 110 type, one end with cut function
5PK-14P	Dual PANASONIC 110 type, one end with cut function

► SOLDERING & DESOLDERING

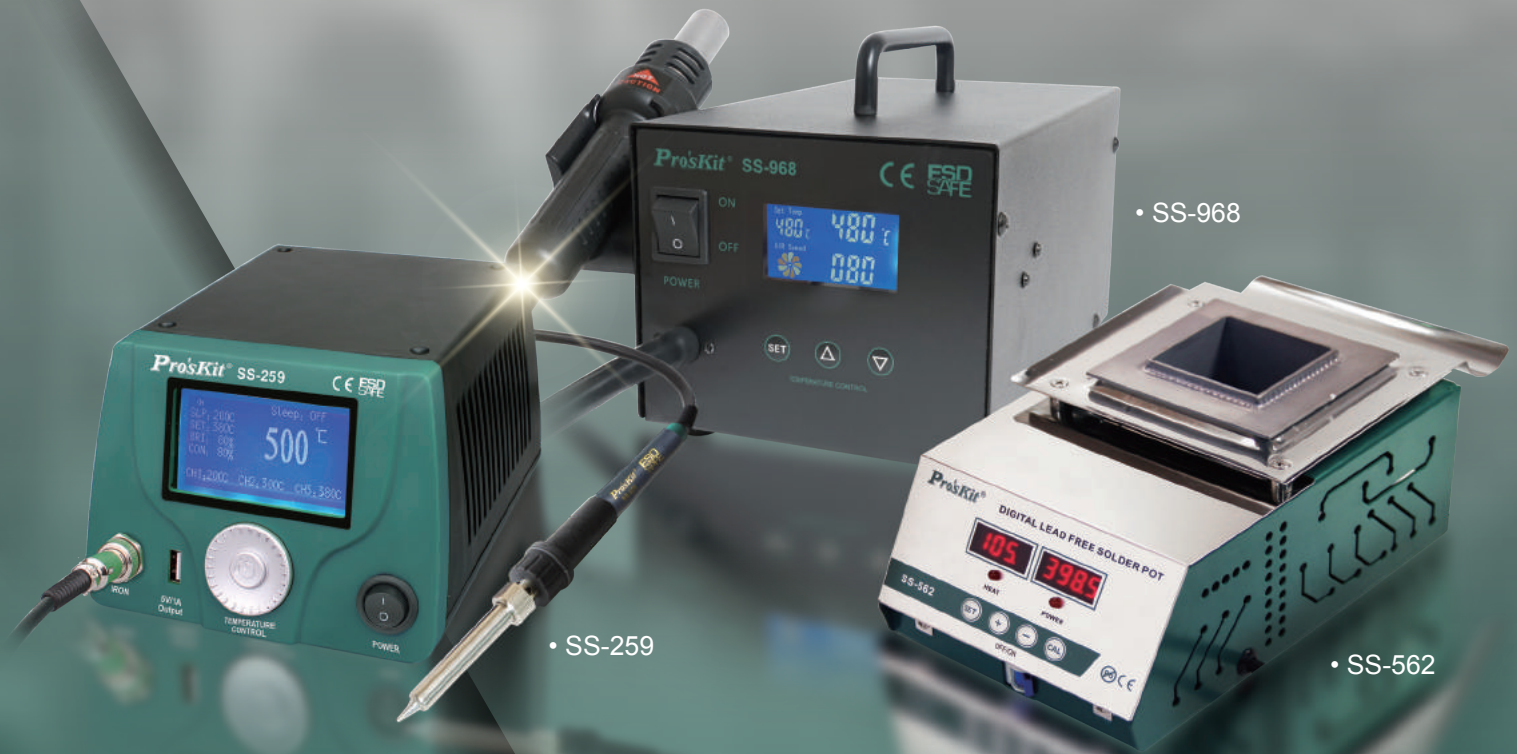

SMD Rework Station

Repair Center 1st Choice. ▼

Microprocessor-controlled with calibration function features accurate temperature control and easy to repair.

LCD Smart Soldering Station

The favorite of professionals. ▼

Smart functions, accurate temperature with high quality heating element.

Solder Pot

Ideal for factory users. ▼

A variety of desoldering model to meet different requirement. From economic type to industrial grade – all you can choose.

Soldering is widely used in most industries, from craft to electronic fields. **Pro'sKit**® provides a variety of soldering products to meet different customer demands.

With accurate temperature control, energy saving design, certified safety standard and more, **Pro'sKit**® soldering series makes your work a breeze.



2 IN 1 SMD Hot Air Rework Station



- **Smart Microprocessor Controlled** with Calibration Function
- **Energy Saving & Fast Heat Up**
36 Second up to 300°C
- **2X Lifetime** than Traditional Type



Power Consumption 700W 480°C **Soldering** 60W 480°C

Features

ESD safe design • Closed circuit sensor • Silicone hand-piece cord wire heat-resistant up to 200°C • AWG 18 UL certified wire • Individual function start • Auto cool off • Interchangeable hot air nozzle and tips with high commonality • All in one PCB design

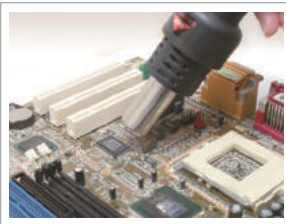

SMD Rework
High work efficiency.

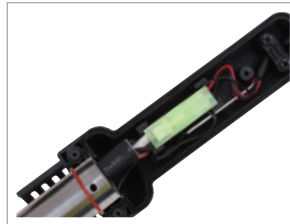

Quick Change
Connectorized design for quick change heater.

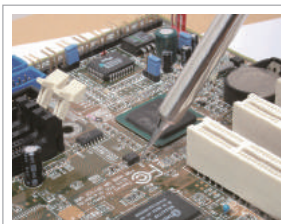

Soldering Iron
Heat fast, 36sec. up to 300°C



Big Air Volume
Diaphragm pump produces uniform air.

Specification	SS-989E	SS-989B
Model No.	SS-989E	SS-989B
Power consumption	700W	
Soldering power	60W	
Soldering iron temperature range	200°C ~ 480°C (392°F ~ 896°F)	
Hot air temperature range	Room temperature ~ 480°C (896°F)	
Heating element	Alumina ceramic heating element	
Hot air heating element	Metal heating core	
Pump/motor type	Diaphragm pump	
Air capacity	24L/min (max)	
Equipment noise	45dB	
Temperature display	LED	
Power input	AC110-120V, 60Hz	AC220-240V, 50Hz
Standard plug		
Dimensions	255(L)x190(W)x140(H)mm	
Weight	4200g	
Accessories		
Soldering Iron (60W)	9SS-900N-SI(AC24V/60W) x 1pcs	
Hot air gun	9SS-900NE-HG (AC110V~120V)	9SS-900NB-HG (AC220V~240V)
Soldering stand	1pce	
Nozzle	9SS-900-A1 (Ø2.2mm) x 1pcs 9SS-900-A2 (Ø6.6mm) x 1pcs 9SS-900-A3 (Ø8.5mm) x 1pcs	
Individual packing	Color box	

Replacement Tips:

Please refer to 5SI-216N series Soldering tip on page.106

Replacement Accessories:

- Soldering Iron : 9SS-900N-SI
- Hot Air Gun : 9SS-900NE-HG(AC110~120V)
9SS-900NB-HG(AC220~240V)
- Soldering Iron Heater : 9SS-900N-HT
- Hot Air Gun Heater : 5SS-989NE-H(AC 110~120V)
5SS-989NB-H(AC 220~240V)

IC Package	IC(mm)	Model No.
Single 		9SS-900-A1
		9SS-900-A2
		9SS-900-A3
QFP (Quad Flat Pack) 	10x10	9SS-900-B
	14x14	9SS-900-C
	17.5x17.5	9SS-900-D
	14x20	9SS-900-E
	27x28	9SS-900-F
SOP (Small Outline Package) 	4.5x11.8	9SS-900-H
	5x14	9SS-900-I
	5.5x15	9SS-900-J
	7.5x18	9SS-900-K
PLCC (Plastic Leaded Chip Carrier) 	17.5x17.5	9SS-900-L
	20x20	9SS-900-M
	25x25	9SS-900-N
	30x30	9SS-900-O

Smart Rework Station With Vacuum Pickup

Power Consumption
600W 480°C



- Smart Microprocessor Controlled with Calibration Function
- Excellent Suction Capacity 100g
- Auto Cool Off and Auto Sleep & Work Mode for Energy Saving

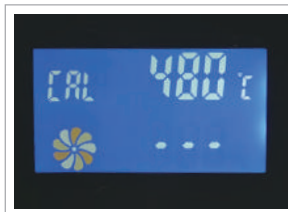

Accurate
Smart station with calibration function

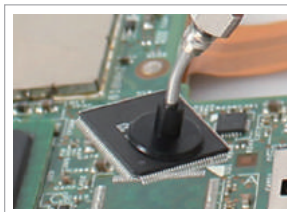

100g Suction Power
with different accessories to meet more demands.



All in 1 PCB
Metal screws fixed.

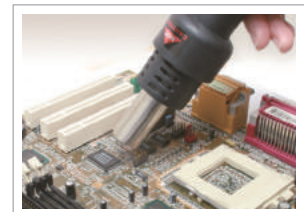

SMD Rework
High work efficiency.

Features

ESD safe design • Closed circuit sensor • Large LCD display
• Silicone hand-piece cord wire heat-resistant up to 200°C • AWG 18 UL certified wire • Individual function start • All in one PCB design • Interchangeable hot air nozzles with high commonality

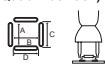
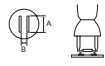
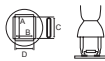
IC Package	IC(mm)	Model No.
Single 		9SS-900-A1
		9SS-900-A2
		9SS-900-A3
QFP (Quad Flat Pack) 	10x10	9SS-900-B
	14x14	9SS-900-C
	17.5x17.5	9SS-900-D
	14x20	9SS-900-E
	27x28	9SS-900-F
SOP (Small Outline Package) 	4.5x11.8	9SS-900-H
	5x14	9SS-900-I
	5.5x15	9SS-900-J
	7.5x18	9SS-900-K
PLCC (Plastic Leaded Chip Carrier) 	17.5x17.5	9SS-900-L
	20x20	9SS-900-M
	25x25	9SS-900-N
	30x30	9SS-900-O

Specification	SS-956E	SS-956B
Model No.	SS-956E	SS-956B
Power consumption	600W	
Temperature range	Room temperature~480°C(896°F)	
Heating element	Metal heating core	
Temperature calibration	0~699°C(0~999°F), adjustable	
°C/°F switch	Yes	
Pump / Motor type	Diaphragm pump	
Air capacity	24L/min(Max)	
Auto sleep function	YES	
Auto cooling function	YES	
Equipment noise	<50dB	
Suction capacity	100g	
Temperature display	LCD (60mm x 35mm, Backlight)	
Power input	110V-120V~ 60Hz	220V-240V~ 50Hz
Standard plug		
Dimensions	250(L) x 230(W) x 170(H)mm (Handle, Holder for hot air gun & suction are included)	
Weight	3200g	
Accessories		
Heating element model	5SS-989NE-H	5SS-989NB-H
Hot air gun	9SS-968E-HG (AC110V~120V)	9SS-968B-HG (AC220V~240V)
Suction cup	Ø12.5mm / Ø10mm / Ø6.5mm / Ø3mm x 1 pc	
Opening lever(width)	15mm / 20mm x 1 pc	
Nozzle	Nozzles:9SS-900-A1 (Ø2.2mm) x 1pc 9SS-900-A2 (Ø6.6mm) x 1pc 9SS-900-A3 (Ø8.5mm) x 1pc Suction Cup:Ø12.5mm / Ø10mm / Ø6.5mm / Ø3mm x 1 pc Opening Lever(Width):15mm / 20mm x 1 pc	
Individual packing	Color box	

SOLDERING & DESOLDERING

▶ SS-968E / SS-968B LCD Smart Hot Air Rework Station



Features

ESD safe design • Closed circuit sensor • Large LCD display • Silicone hand-piece cord wire heat-resistant up to 200°C • AWG 18 UL certified wire • Interchangeable hot air nozzles with high commonality • Button adjustment • All in one PCB design

Specification		
Model No.	SS-968E	SS-968B
Power consumption	600W	
Temperature range	Room temperature~480°C(896°F)	
Heating element	Metal heating core	
Temperature calibration	0~699°C(0~999°F) , adjustable	
°C/°F switch	Yes	
Pump/Motor type	Diaphragm pump	
Air capacity	24L/min(Max)	
Auto sleep function	YES	
Auto cooling function	YES	
Equipment noise	<50dB	
Temperature display	LCD (60mm x 35mm, Backlight)	
Plug type	E	B
Dimensions	250(L) x 215(W) x 170(H)mm	
Weight	3200g	
Accessories		
Hot air gun	9SS-968E-HG AC(110~120V)	9SS-968B-HG (AC220~240V)
Nozzle	9SS-900-A1 (ID:Ø2.2mm) x 1pc 9SS-900-A2 (ID:Ø6.6mm) x 1pc 9SS-900-A3 (ID:Ø8.5mm) x 1pc	
Individual packing	Color box	

Smart Microprocessor Controlled
Auto Cool Off & Auto Sleep & Work Mode
Quiet operation

600W
480°C



Accurate
Smart station with calibration function

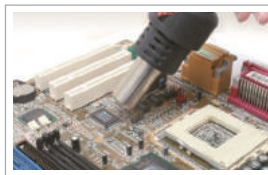

SMD Rework
High work efficiency.

Replacement Nozzles:

Please refer to 9SS-900 series soldering nozzles on page.101

▶ SS-969E / SS-969B SMD Rework Station



Features

Closed circuit sensor • Silicone hand-piece cord wire heat-resistant up to 200°C • AWG 20 (0.5 mm²) UL certified wire • Interchangeable hot air nozzles with high commonality • Knob adjustment • All in one PCB design

Specification		
Model No.	SS-969E	SS-969B
Power consumption	700W	
Temperature range	100~450°C(212~842°F)	
Heating element	Metal heating core	
Equipment noise	<45dB	
Temperature display	LED	
Air volume	120L / min (Max.)	
Fuse type	250V / 8A	250V / 5A
Input voltage	AC110V~120V, 60Hz	AC220V~240V, 50Hz
Plug type	E	B
Machine size	170 x 170 x 140mm	
Overall package	280 x 185 x 170mm	
Weight	1.6 kgs	
Accessories		
Heat air gun	5SS-969NE-HG AC(110~120V)	5SS-969NB-HG (AC220~240V)
	(225 x 60 x 40mm / wire length 140cm)	
Nozzle	9SS-969-A1 x 1pcs (ID: Ø 4.3mm) 9SS-969-A2 x 1pcs (ID: Ø 7.4mm) 9SS-969-A3 x 1pcs (ID: Ø 11.2mm)	
Individual packing	Color box	

Microprocessor Controlled
Auto Sleep & Work Mode
Quiet operation

700W
450°C



Quick change: Connected design for quick change heater



SMD Rework
High work efficiency.

SOLDERING
& DESOLDERING

▶ SS-602E / SS-602B Hot Air SMD Rework Tool



300W
500°C

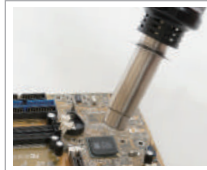

Compatible with 9SS-900 series nozzles

Microprocessor Controlled 3 Ranges Air Volume LCD Digital Setting

Features

Portable • Temp. 200°C~500°C • °C/°F selection • Anti- return air protection • Can be used for FP, SOP and PLCC SEM ICs

Specification		
Model No	SS-602E	SS-602B
Voltage	110~120V	220~240V
Power consumption	300W	
Air volume	For 3 ranges, max. 22L/min(Max)	
Temperature	200°C~500°C	
Power plug	E	B
Standard nozzle	ø5mm, ø8mm, ø12mm	
Accessories		
Nozzle	9SS-602-A1 x 1pcs (ID: Ø 5mm) 9SS-602-A2 x 1pcs (ID: Ø 8mm) 9SS-602-A3 x 1pcs (ID: Ø 12mm)	
Replacement heater	9SS-602E-H	9SS-602B-H
Individual packing	Color box	

▶ SS-331E/SS-331B LCD Desoldering Station



140W
480°C



Microprocessor Controlled Fast Heat Up with Ceramic Heater Desolder & Pick-up 2 in 1

Features

Large LCD display • Built-in high power 600mm Hg air pump • Vacuum indicator • °C and °F selection • Transparent solder tube

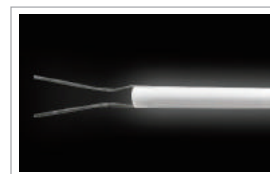

Comes with ceramic heater which provides fast heat up



Complete accessories

Specification		
Model No	SS-331E	SS-331B
Voltage	120V~ 60Hz	220V-240V~ 50Hz
Soldering power	90W	
Power consumption	140W	
Temperature range	160°C ~ 480°C	
Control system	Microprocessor	
Vacuum pump system	Air pump motor	
Vacuum pressure	>600mm hg	
Heating element	Ceramic heater	
Connecting cord/ Hose length	105cm	
Power cord length	1.2m(3 core cord ground plug)	
Power plug	E	B
Station size	172 x 135 x 190mm	
Accessories		
Nozzle	5SS-331N-NZ1 x1 pc (ID: Ø 1.0mm) 5SS-331N-NZ2 x1 pc (ID: Ø 1.2mm) 5SS-331N-NZ3 x1 pc (ID: Ø 1.5mm)	
Accessories	Cleaning tool x 3 (Ø0.7 / Ø0.9 / Ø1.2mm) Filter sponge x 4 (Ø20.8x1+Ø16.8x3)	
Individual packing	Color box	

Replacement Accessories:

Desoldering Gun : 5SS-331N-DG
Heater : 5SS-331N-H
Nozzle Set : 5SS-331N-NZ

LCD SMART

- Microprocessor controlled -



SOLDERING STATION

- **Resettable Fuse Protection**
- **Temperature Calibration Function**
- **USB Power Output**
- **Shuffle Knob Design for Quick Setting**
- **High Performance**
- **3 Data Memories**
- **Auto Sleep and Wake Up Function**

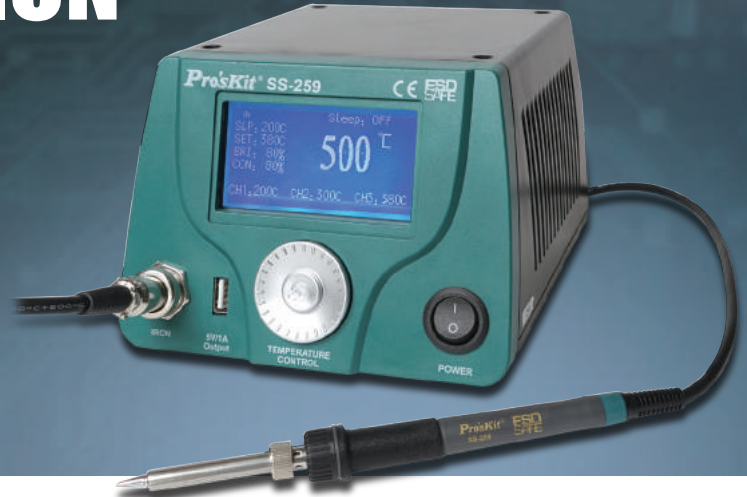

Performance Graph

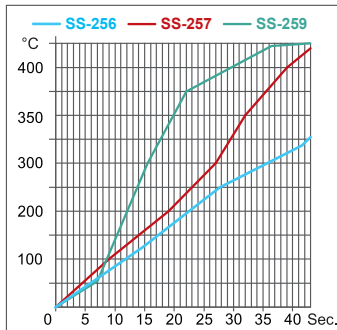

▶ SS-256E/B



60W 480°C

Standard model

- Alumina ceramic heater

▶ SS-257E/B



75W 500°C

Advanced model

- High end quad-wire heater
- 30 sec. reach 300°C

▶ SS-259E/B



90W 500°C

Professional model

- High end silver alloy heater
- Heat fast, 19 sec. reach 300°C

SS-256/257 Replacement Tips:
Please refer to 5SI-216N series soldering tip on page.106

SS-259 Replacement Tips:

5SI-259 series	
5SI-259-B	
5SI-259-I	
5SI-259-C	
5SI-259-D	
5SI-259-K	



Model No.	SS-256E	SS-256B	SS-257E	SS-257B	SS-259E	SS-259B
Power consumption	60W		75W		90W	
Input voltage	AC 110~120V 60Hz	AC 220~240V 50Hz	AC 110~120V 60Hz	AC 220~240V 50Hz	AC 110~120V 60Hz	AC 220~240V 50Hz
Temperature range	200~480°C(392°F~896°F)		30~500°C±10°C(86~932°F±50°F)		30~500°C±10°C(86~932°F±50°F)	
Temperature calibration	100~699°C(212~1290°F) Adjustable		0~699°C(32~1290°F) Adjustable		0~699°C(32~1290°F) Adjustable	
Heating element	Alumina ceramic		High end stainless Cr-Ni heater		High end silver alloy heater	
Sleep mode	OFF/1~240min adjustable		OFF, 1~360min adjustment		OFF & 1~360min adjustment	
Output voltage	24VAC		25VAC		25VAC	
Temperature of sleep mode	200°C(392°F)		30~400°C(86~752°F)		30~400°C(86~752°F)	
Replacement heater	9SS-900N-HT		9SS-257-HT		9SS-259-HT	
Soldering iron	9SS-256-SI		9SS-257-SI		9SS-259-SI	
Replacement tips	5SI-216N		5SI-216N		5SI-259 series	
Display	LCD 73mmX40mm, Backlight					
Control system	Microprocessor-controlled					
Temperature stability	±2°C/±36°F (no load)					
USB port output	DC 5V/1A					
Memory	3 sets					
Tip-to-Ground resistance/potential	≤2Ω / ≤2mV					
Individual packing	Color box					

SOLDERING & DESOLDERING

Temperature-Controlled Soldering Station



Power Consumption

60W 480°C

- UL Certified Wires and Components
- Ceramic Heater , Long Service Life Time
- Lead Free Process
- Compact Size



Product Video



Analog Type



Digital Type

Features

IC modular design • Temperature range 200°C ~ 480°C • Heat resistant hand-piece • Aerospace grade metal plug • °C and °F setting

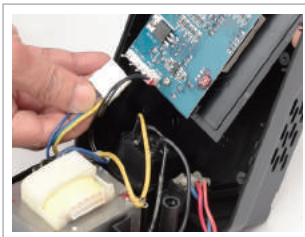

Modular design for easy repair



High quality assembly

Replacement tips:



OAL:43mm I.D.: 4.0mm O.D: 6.3mm



Specification				
Model No.	SS-206B	SS-206E	SS-207B	SS-207E
Power consumption	60W			
Output voltage	24VAC			
Display	Analog		Digital	
Heater	Alumina ceramic heating element			
Temperature range	200°C- 480°C (392°F-896°F)			
Station size	145 x 90 x 120mm			
Voltage	220~240V 50Hz	110~120V 60Hz	220~240V 50Hz	110~120V 60Hz
Standard plug	B	E	B	E
Accessories				
Replacement heater	9SS-900N-HT			
Soldering iron	9SS-900N-SI			
Individual packing	Color Box			

	5SI-216N-B		5SI-216N-3.2D
	5SI-216N-B1.0		5SI-216N-1C
	5SI-216N-BC		5SI-216N-2C
	5SI-216N-0.8D		5SI-216N-3C
	5SI-216N-1.2D		5SI-216N-4C
	5SI-216N-1.6D		5SI-216N-I
	5SI-216N-2.4D		5SI-216N-K

SOLDERING & DESOLDERING

▶ SS-202A / SS-202F Mini Soldering Station



Features

- Super slim pen-like style soldering iron.
- Ceramic heating element for fast heating up.

Specification

Model No.	SS-202A	SS-202F
Input voltage	110~120V	220~240V
Power consumption	10W	
Output voltage	AC12V	
Temperature	100°C~450°C (212~842°F)	
Heating element	Ceramic heater	
Plug	A	F
Accessories		
Replacement iron	9SS-202-SI	
Replacement tip	9SS-202-R0.3	
Station size	115x64x70mm	
Weight	570g	



Palm size, easy to carry

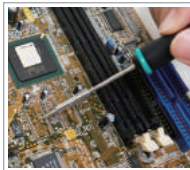

For precision soldering/ desoldering work

Palm Size • Low Power Consumption

10W 450°C



▶ SS-595A / SS-595B Smoke Absorber



Features

Long service life • Stepless air volume • 9 Adjustable angles • Easy-to-change filter design • 2 ways placement

Specification

Model No.	SS-595A	SS-595B
Power supply	110-120V~ 60HZ	220-240V~ 50HZ
Power consumption	8~23W (Adjustable)	
Power code	A 1.3M	B 1.3M
Capacity	0.2~1m³/min (Adjustable)	
Dimension	220 x 220 x 145mm	
Weight	1200g	
Accessories		
Activated-carbon filter	5SS-593-F x 1pce, 130x130x10mm	
Individual packing	Color box	

2 IN 1 Absorber / Fan



Fan: to cool down objects



Absorber: remove smoke

9 Adjustable angles • 23W Brushless Motor
Adjustable Air Volume • Dual Function



▶ SS-593A / SS-593B Smoke Absorber



Features

Fully adjustable fan • Portable and desktop design • Low noise operation

Specification

Model No.	SS-593A	SS-593B
Power supply	110-120V~ 60HZ	220-240V~ 50HZ
Power consumption	23W	
Plug	A 1.3M	B 1.3M
Capacity	1m³/min(max)	
Dimension	220 x 270 x 168mm (O.D.)	
Accessories		
Activated-carbon filter	5SS-593-F x 2pcs, 130x130x10mm	
Individual packing	Color box	



5SS-593-F

Filter is made of urethane foam with refined, activated, high absorption carbon

23W Brushless Motor • Classical Type



SS-562B Digital Lead Free Solder Pot **SS-571B Digital Preheat Platform**

**PID Controlled with Temperature Compensation
Industrial Grade • Dual Digital Display**

350W 550°C

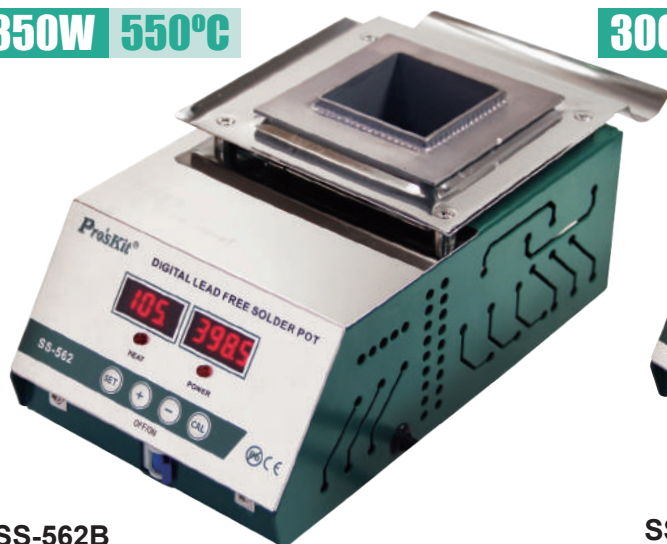

300W 400°C



**SS-562B
Rugged 2mm Titanium Crucible
Ceramic Heater**

**SS-571B
Aluminum Alloy Platform
Infrared Heater**

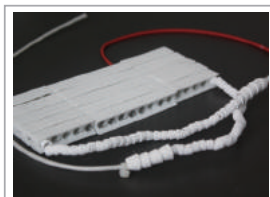

Iron chromium aluminum wire heater with Ceramic heater insulated tube for quick heat up

Model No.	SS-562B	SS-571B
Power consumption	350W	300W
Temperature range	Room temp. ~550°C	Room temp. ~400°C
Temperature accuracy	±5°C	±5°C
Control system	PID Control	PID Control
Temperature compensation setting	-200~400°C	-200~400°C
Crucible size	Square type 55x55x45 (mm)	100x100x15 (mm)
Crucible material	2.0mm Titanium board	Aluminum alloy
Melting time (temp. 280°C)	Approx. 10 mins	-
Solder capacity	1.3Kg	-
Voltage	220V~240V 50/60Hz	220V~240V 50/60Hz
Standard plug	B	
Dimension (LxWxH)	280x145x115 (mm)	280x145x115 (mm)

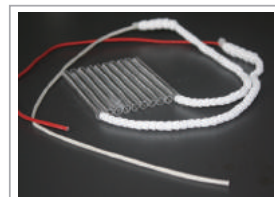

Infrared heater with ceramic insulated tube

Individual packing : Color box

SS-55 Series Solder Pot

**Electronic Control Board
Fight to Value Type**



Individual packing : Color box



SS-551B



SS-552B



SS-553B



SS-554B



Ceramic heater insulated tube



Aluminosilicate heat preservation material

Model No.	SS-551B	SS-552B	SS-553B	SS-554B
Power consumption	150W	200W	250W	300W
Temperature range	250°C~550°C	250°C~550°C	230°C~450°C	230°C~450°C
Crucible size	Ø38x35Hmm	Ø50x35Hmm	Ø80x40Hmm	Ø100x40Hmm
Crucible material	Stainless steel with titanium plating			
Melting time (Max.setting)	Approx. 10mins	Approx. 10mins	Approx. 20mins	Approx. 20 mins
Solder capacity	0.3kg	0.5kg	1.6kg	2.2kg
Voltage	220V~240V 50/60Hz			
Standard plug	B			
Dimension (LxWxH)	150x90x60mm	150x90x60mm	210x140x65mm	210x140x65mm

SOLDERING & DESOLDERING

▶ SI-131B 80W Temperature Controller Soldering Iron

Features

Stainless steel barrel • Ventilation hole • K type temperature control sensor • Ceramic heating element • Long life soldering tip



Adjustable Temperature 200~450°C
Fast Thermal Recovery

80W 450°C

Replacement Tip: Offered by 10 pcs in a bag

	5SI-131-3C		5SI-131-2C
	5SI-131-B		5SI-131-K

Power consumption	Temperature range	Heating element	Standard plug	Replacement heater	OAL.
80W(±10%)	200°C ~ 450°C (±40%)	Ceramic	B	5SI-131-HT	240mm

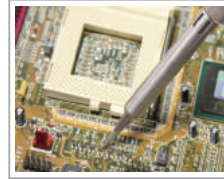

▶ SI-130A-20/SI-130B-20/SI-130A-25/SI-130B-25 Ceramic Soldering Iron

Features

Stainless steel barrel • Ceramic heating element • Long life soldering tip • Supplied with iron support • Come with silicone protection cap



Energy Saving 60% than traditional type

12W 410°C SI-130-20



14W 450°C SI-130-25



Model No.	Voltage	Consumption	Temperature	Heater	Handle color	Standard plug	OAL.	Individual packing
SI-130A-20	110-120V	12W	410°C±10%	Ceramic heater	Green	A	170mm	Blister card
SI-130B-20	220-240V					B		
SI-130A-25	110-120V	14W	450°C±5%		Orange	A		
SI-130B-25	220-240V					B		

SI-130 Performance comparison graph

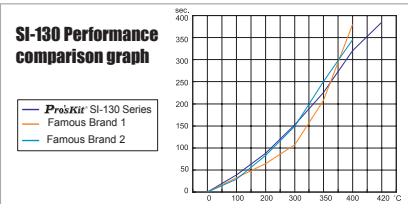

Replacement tips: Please follow up 5SI-216N series soldering tips.(as page.106)

▶ SI-129B-30/SI-129B-40/SI-129B-60 Soldering Iron

Features

Working indicator • Dual construction heater for better protection • Long life soldering tip • PA66 handle



Replacement Tip:
Offered by 10 pcs in a bag

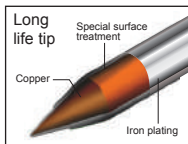

30W 400°C SI-129B-30



40W 450°C SI-129B-40



60W 500°C SI-129B-60



Power	Tip Diagram	Model	Tip Diagram	Model
30W		SI-S120T-4B (Standard)		SI-S120T-4C
		SI-S120T-4SB		SI-S120T-4BC
40W		SI-S120T-5B		SI-S120T-5C
		SI-S120T-5BC		SI-S120T-5SB
60W		SI-S120T-6B (Standard)		SI-S120T-6C
		SI-S120T-6SB		SI-S120T-6BC

Model No.	Consumption	Temperature	Handle color	Heating element	Standard Plug	OAL (mm)	Individual packing
SI-129B-30	30W	400°C	Green	Ni-Cr	B	215	Blister card
SI-129B-40	40W	450°C	Orange			225	
SI-129B-60	60W	500°C	Yellow			234	

SI-124B Series Soldering Iron

Ergonomically Triangular Shaped Handle
Long Service Life Tip



Features

Durable & non-slip handle • Seamless stainless barrel • Ni-Cr heating element • Long life tip

Model No.	Consumption	Temperature	OAL.
SI-124B-30	30W	400°C±10%	225mm
SI-124B-40	40W	420°C±10%	245mm
SI-124B-60	60W	450°C±10%	260mm
SI-124B-100	100W	500°C±10%	275mm
Voltage	Standard plug		Individual packing
230V	B		Blister card

Replacement tips:

Please follow up SI-S120T series soldering tips. (as page.110)

8PK-S120N Series Soldering Iron

Ergonomic Handle • Long Service Life Tip



Features

Beehive heat sink aperture • Terminals added design • Ni-Cr heating element • PA66 handle



Beehive heat sink aperture

Replacement tip: 30W/40W

	SI-S120T-4B (Standard)
	SI-S120T-4BC
	SI-S120T-4C
	SI-S120T-4SB

• offered by 10 pcs in a bag

60W

	SI-S120T-6B (Standard)
	SI-S120T-6BC
	SI-S120T-6C
	SI-S120T-6SB

• offered by 5 pcs in a bag

Note:

8PK-S120 Series 30W/40W replacement tip, please refer to 30W replacement tip.

Model No.	Voltage	Consumption	OAL(mm)	Temperature	Standard plug	Replacement heater	Individual packing
8PK-S120NAD-30	110~120V	30W	250	440°C±10%	E	5PK-S120NA-30H	PVC folding box W/2 pcs tips (B & SB type)
8PK-S120NAD-40		40W		480°C±10%		5PK-S120NA-40H	
8PK-S120NAD-60		60W		520°C±10%		5PK-S120NA-60H	
8PK-S120NB-30	220~240V	30W	250	440°C±10%	B	5PK-S120NB-30H	PVC folding box
8PK-S120NB-40		40W		480°C±10%		5PK-S120NB-40H	
8PK-S120NB-60		60W	280	520°C±10%		5PK-S120NB-60H	
8PK-S120NBD-30		30W	250	440°C±10%		5PK-S120NB-30H	PVC folding box W/2 pcs tips (B & SB type)
8PK-S120NBD-40		40W		480°C±10%		5PK-S120NB-40H	
8PK-S120NBD-60		60W		520°C±10%		5PK-S120NB-60H	

▶ SI-168U Portable USB Soldering Iron

Features

Auto sleep mode • 480°C high temperature • Replaceable long life tip • Metal touch switch control • Working indicator



Auto sleep mode	Indicator	USB length	Accessories		
25 sec.	LED light	1.5M	USB wire, cap, solder stand & solder wire		
Power supply	Power consumption	Temperature	Replacement tip	Dimension	Individual packing
USB Input DC5V	8W	480°C ± 10%	9SI-B162-T	Ø19x163mm	PET folding box

CE **8W 480°C**

8W Power Consumption
15 sec. Fast Heat up
USB 5V Powered



▶ 8PK-S118 Series Soldering Iron

Features

Seamless stainless pipe • Long life tip • Heat isolated tube • Wire protection boot • Come with protection cap

Economic Type **30W 400°C**
40W 440°C

Replacement tips:

Please follow up 30W/40W SI-S120T-4 series soldering tip. (as page.110)

Model No.	Voltage	Consumption	Temperature	OAL.	Standard plug	Individual packing
8PK-S118A	110~120V	30W	400°C±10%	235mm	A	Blister card
8PK-S118B	220~240V				F	
8PK-S118A-40	110~120V	40W	440°C±10%		A	
8PK-S118B-40	220~240V				F	



▶ SI-125A-20 Mini Soldering Iron

Features

Ceramic heater • Ergonomic triangle shaped handle • Light weight • Safe stopper design • Come with iron holder

20W 410°C

Replacement tip:

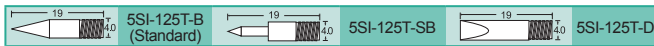

Voltage	Consumption	Temperature	Heater	Handle color	Standard plug	OAL.	Individual packing
110~120V	20W	410°C±10%	Ceramic heater	Orange	A	168mm	Blister card



▶ 1PK-SC109NB Quick-heat Ceramic Soldering Iron

Features

- 20W/40W instant heat up control.
- Ideal for professional service or light electrical work.

20/40W 400°C

Replacement tip:

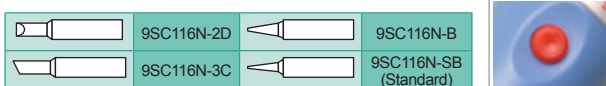

Voltage	Consumption	Temperature	OAL.	Standard plug	Individual packing
220~240V	20/40W	400°C±10%	Ø28x260mm	B	Blister card



SOLDERING & DESOLDERING

▶ SI-B162 Battery Operated Soldering Iron

8W 450°C



**Safety Cap Detent
Fast Heat Up**



Temperature up to 450°C / 840°F, maintains soldering temperature at least 300°C / 600°F for one hour (with alkaline battery)

Features

Work indicator • Comes with protection cap • safety slide switch



**Auto power off
when cap attached**

Battery	Accessories
3x1.5V alkaline AA (not included)	Lead free solder wire: 9SI-B162-W Replacement tip: 9SI-B162-T

Consumption	Temperature	Time to reach operating temp.	OAL.	Individual packing
Max. 8W	Max. 450°C (with alkaline battery)	15-20 seconds (with alkaline battery)	178mm (w/o cap)	Blister card

▶ SI-B161 Battery Operated Soldering Iron

9W 450°C



Fast Start Up, 12 sec. 185°C



160 joints capacity with fully batteries.

Features

30 min. continuous use • Work indicator • Come with protection cap • Long life tip

Battery	Approx. nos. of solder joints intermittently	Replacement tip
1.5V alkaline AAx3 pcs (not included)	160 joints using new batteries	9SI-B161-T

Consumption	Temperature	Time to reach operating temp.	OAL.	Individual packing
9W (max)	450°C (840°F)	185°C / 365°F in 12 seconds	190 x 38.3 x 21.8 mm (w/o cap)	Blister card

▶ 8PK-SC116NB Convertible Soldering Iron/Gun

20/40W 400°C



- Wide range of applications from sheet metal to PC board.
- 20W/40W instant heat up control.



Replacement tips:

Plase follow up 9SC116N series soldering tips. (as page.111)

Voltage	Consumption	Temperature	OAL(mm)	Standard plug	Individual packing
220~240V	20/40 W	400°C±10%	185x110x23	B	Blister card

▶ SI-S106A / SI-S106B Convertible Soldering Iron/Gun

30W 450°C

CB

- Converts easily from pen to gun configuration.
- Handle can be cover for tip protection when not in use.

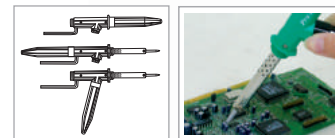

Replacement tips:

Plase follow up 30W SI-S120T-4 series soldering tips. (as page.110)

Model No.	Voltage	Consumption	Temperature	Heater	OAL.	Standard plug	Individual packing
SI-S106A	110~120V	30W	400°C±10%	5SI-S106A-H	187x 35x 25mm		Blister card
SI-S106B	220~240V			5SI-S106B-H			

▶ 8PK-101-2 Portable Soldering Tool Kit

Features

See-through fuel window • Come with soldering tip and soldering head • More optional tips are available.



Flammable cotton thread

Soldering temperature	Hot blow temperature	Torch temperature	Fuel cap.	Time	Size	Replacement parts	Individual packing
370 °C	500 °C	1300 °C	6 ml	30~45 min	130×Ø 23 mm	5MT-T series	Blister card

▶ GS-210 Professional Soldering Iron & Gas Torch

Features

See-through fuel window • Adjustable flame control • Built-in stand • Come with needle soldering tip and soldering head • More optional tips are available



Auto Ignition



Soldering temperature	Hot blow temperature	Torch temperature	Fuel cap.	Time	Gas soldering Size	Replacement parts	Individual packing
370 °C	500 °C	1300 °C	7 ml	30~40 min	170×Ø 24 mm	5MT-T series	Blister card

▶ 1PK-GS003 Portable Gas Soldering Tool Kit Series

Features

Long lasting catalytic tip • See-through fuel window • Adjustable flame control • Come with soldering tip and soldering head



Soldering temperature	Hot blow temperature	Torch temperature	Fuel cap.	Time	Gas soldering size	Individual packing
210~400 °C	650 °C	1300 °C	8 ml	80 min	170×Ø24 mm	Blister card

▶ 5MT-T Series Soldering Tip

• For GS-210 / 8SL-2000N / 8PK-101-2



Model No.	Replacement parts	Model No.	Replacement parts
5MT-T-005N	Solder head (For 8PK-101-2/8SL-2000N/GS-210)	5MT-T-010	Soldering tip hot knife type (For 8PK-101-2/8SL-2000N/GS-210)
5MT-T-007	Soldering tip needle type (For 8PK-101-2/8SL-2000N/GS-210)	5PK-101-2T	Solder head W/S-2.4mm Tip (For 8PK-101-2/8SL-2000N/GS-210)
5MT-T-008	Soldering tip 2.4 type (For 8PK-101-2/8SL-2000N/GS-210)	5GS-210-H	Hot blower (Only for GS-210)
5MT-T-009	Soldering tip double sharp type (For 8PK-101-2/8SL-2000N/GS-210)		

GS-200K Gas Soldering Iron Kit-Auto Ignition



Auto Ignition • 11 in 1 Kit

Features

See-through fuel window • Adjustable flame control



Accessories:

Blow pen torch, protection cap, soldering head, needle soldering tip, 2.4mm soldering tip, double sharp tip, hot knife tip, hot air blower, polyfoam cutter, solder, tip-cleaning sponge with safety stand.

Soldering temperature	Hot blow temperature	Torch temperature	Fuel cap.	Time	Gas soldering size	Case size	Individual packing
400 °C	500 °C	1300 °C	26 ml	100 ~ 120 min	220×Ø 30mm	252 x 138 x 54mm	Color box

GS-23K Gas Soldering Iron Kit-Auto Ignition

TÜV RoHS COMPLIANT



Fight to Value Model • Auto Ignition • 7 in 1 Kit

Features

Complies with CPSC • TR90 nylon gas tank • See-through fuel window • Ceramic heater • Adjustable flame control

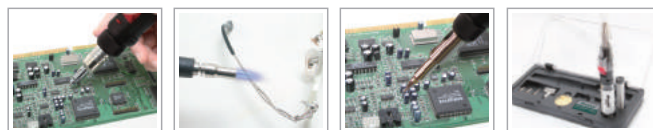

Soldering temperature	Hot blow temperature	Torch temperature	Fuel cap.	Time	Gas soldering size	Case size	Individual packing
500 °C	600 °C	1300 °C	15 ml	90 min	245×Ø29 mm	300 x 138 x 46mm	Color box

8SL-2000N Portable Gas Soldering Tool Kit



6 in 1 Kit

Features

Long lasting catalytic tip • Quick and easy refill



Replacement parts: 5MT-T series(P.113)

Soldering temperature	Hot blow temperature	Torch temperature	Fuel cap.	Time	Gas soldering size	Case size	Individual packing
370 °C	500 °C	1300 °C	11 ml	45-60 min	160×Ø23 mm	200x 85x 48mm	Color label shrink packing

▶ SS-621B Heat Gun with LCD Display



Features

Overheat protection • Dual air volume • Auto cool air flow • Ceramic heater • Double insulated

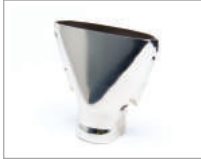

Deflector Nozzle:
82x14mm



Air Reduction Nozzle:
Ø 17mm



Large LCD display



Shrinking packaging



Forming plastic



Comes with Mabuchi Motor

Accessories: Hook nozzle, slit nozzle, deflector nozzle, air concentration nozzle, scraping tool.

Voltage	Watt	Temperature	Air volume	Standard plug	Individual packing
240V 50Hz	2000W	100°C ~650°C	I: 200 L/min II: 500 L/min	B	Color box

Adjustable Temperature 100~650°C
Long Lifetime Mabuchi Motor
LCD Display

2000W 650°C



▶ SS-611A / SS-611B Heat Gun Set



Features

Overheat protection • Dual air volume • Ceramic heater • Double insulated



Accessories: Hook nozzle, slit nozzle, deflector nozzle, air concentration nozzle, scraping tool

Model No.	Voltage	Power	Air volume	Temperature range	Case size	Standard plug	Individual packing
SS-611A	110~120V 60Hz	I-750W II-1500W	I: 280L/min	I-300°C II-500°C	300 x 280 x 90mm	A	Blowing case + Color sleeve shrink
SS-611B	230~240V 50Hz	I-750W II-1500W	II: 480L/min	I-300°C II-500°C	300 x 280 x 90mm	B	Blowing case + Color sleeve shrink

⚠ Caution:

- For safety, after using this product for one hour, please shut-off for 10 minutes to cool down temperature
- If this product is overheating after shut-off, the protection function will be coercively booted and make this appliance off for 10 minutes. To prevent any overheating problem, never put the appliance down on its air outlet nozzle. Always keep its outlet nozzle upward or put it on one of its sides.

Dual Temperature • Auto Cool Air Flow

1500W 500°C



Paint and varnish removal

SOLDERING
& DESOLDERING

SI-132A/SI-132B Wood Burning Hobby Kit

21 IN 1

Ergonomic Design
Fast Heat Up



Ideal for **woodburning, embossing, leather working and home DIY soldering repair.**



25W 360°C

Features

Nickel-chrome heating element • Heat shields x2 for better protection



Leather working

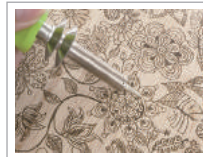

Woodburning

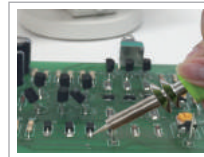

Soldering repair

Model No.	Voltage	Power	Temperature	Plug	Accessories	Individual packing
SI-132A	110V~120V	25W	360°C	A	Solder tip x1, Blade x1, Wood burning tips x8, Embossing tips x11	Sleeve+ carrying case
SI-132B	220V~240V			B		

Solder tip	Universal Point		Tapered Point	
	Mini Universal Point		Dot Point	
Blade	Calligraphy Point		Flow Point	
	Shading Point		Mini Flow Point	

SI-138A/SI-138B Wood Burning & Crystal Hotfix Kit

26 IN 1

Ergonomic Design
Fast Heat Up



Dual Watt

10W / 200°C for hot fix rhinestones
30W / 400°C for woodburning, embossing



10W 200°C 30W 400°C

Features

Nickel-chrome heating element • Heat shields x2 for better protection

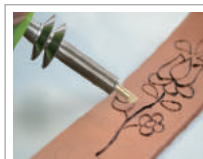

Leather working

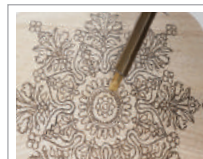

Woodburning

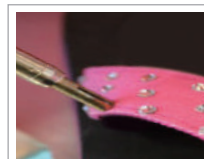

Hot fix rhinestone

Model No.	Voltage	Power	Temperature	Plug	Accessories	Individual packing
SI-138A	110V~120V 60HZ	10W / 30W	200°C / 400°C	A	Solder tip x1, Blade x1, Crystal hot fix tips x5, Wood burning tips x8, Embossing tips x11	Sleeve+ carrying case
SI-138B	220V~240V 50HZ			B		

Solder tip	Universal Point		Tapered Point	
Blade	Mini Universal Point		Dot Point	
Crystal hot fix tips	Calligraphy Point		Flow Point	
	Shading Point		Mini Flow Point	

▶ GK-361U 3.6V Li-ion USB Glue Gun



1.5h Longtime Operation
Palm Size, USB Charging
Non-Drip, Quick Warm Up
2000mAh Li-ion

8W 130°C

Features

Antidrip design • Built-in stand • Working indicator •
 Circuit protection • Low consumption • Lightweight



Power	Input Voltage	Preheat time	Glue stick	Flow of glue	Free running time	Melt temperature	Charging time	Battery	Accessory	Individual packing
8W	DC 5V	2-5min	Ø7mm	3g/min	1.5h	130°C	200min (5V/2A)	2000mAh Li-ion	USB power cord	Double blister

▶ GK-389B/GK-390B Professional Hot Melt Glue Gun

CE, RoHS, PTC heating system • Non-Drip • Large Flow Amount • Quick warm up

80W 150°C

GK-390B

Ideal for DIY



100W 200°C

GK-389B

Ideal for Production Line



Model No.	Input voltage	Power	Melt temperature	Heating element	Preheat time	Flow of glue	Standard plug	Replacement glue stick	Individual packing
GK-389B	110~240V	100W	170°C (200°C)	PTC	2-5 min	15-25g /min	B	Model No. 61103 Ø11mm	Blister Card
GK-390B		80W	150°C		3-6 min	15-20g /min			

▶ GK-380A/GK-380B Hot Melt Glue Gun



Features

Force-saving trigger • LED indicator • Spring-tensioned nozzle • Silicone sleeve



Models



Decoration model and more



▶ GK-368 Battery Operated Glue Gun



Cordless Design
LED Light
Quick Warm Up



Model No.	Voltage	Power	Preheat time	Flow of glue	Standard plug	Replacement glue stick	Individual packing
GK-380A	120V	30-80W	10 min	14-16g / min	A	Model No. 61103 Ø11mm	Blister card
GK-380B	230V	15-80W			F		

Power	Preheat time	Replacement glue stick	Flow of glue	Power source	Running time	Individual packing
7W/6V	3-4 minutes	Ø 7.5x100mm (3pcs/pack)	3g /min	1.5V AA battery x 4(not included)	45 minutes (Alkaline type)	Blister card

▶ 61103 Glue Stick



• Unit:1kg, 1kg=33pcs



▶ SS-803F Digital Ultrasonic Cleaner

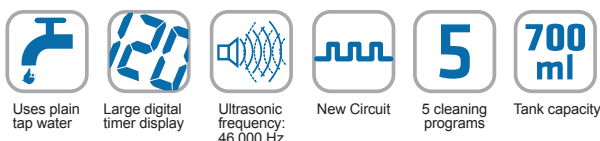

15% Better Cleaning & 10% Longer Product Life

Features

- Green cleaning – No harmful chemicals.
- To make item cleaning easy and safe by using only tap water.
- Use ultrasonic bubbles to break down dirt (46,000Hz)
- Digital operation with 5 cleaning programs.
- Use separately-excited circuit to generate steady oscillation.

Specification	
Voltage	AC 220-240V 50Hz
Power	50W
Timer Setting	5 cleaning programs → 180s → 300s → 480s → 90s → 600s
Ultrasonic Frequency	46,000Hz (46 KHz)
Material of Tank	Stainless steel SUS304
Tank Capacity	700ml (Max: 600ml)
Material of Housing	ABS
Gross Weight (G.W.)	1.4Kg / 3.08lb
Weight (N.W.)	1.0Kg / 2.2lb
Dimensions (LxWxH)	228 x 172 x 143mm (9.0"x 6.8"x 5.6")
Individual packing	Color box
Accessories: Disk Holder / Watch Stand / Basket	



▶ SS-820B Digital Ultrasonic Cleaner



15% Better Cleaning & 10% Longer Product Life Industrial Grade

Features

- Large tank particularly designed for professional cleaning.
- 1 to 30-minute full range timer.
- Advanced ceramic heater, safe and efficient.
- Cooling device improves heat dissipation for prolonged operation.
- Overheat protector prevents overheating and effectively prolongs the product life.
- Heater automatically shuts off after 45 minutes to ensure safety.
- Degas feature dissolves the solution quickly.

Specification	
Voltage	AC 220-240V 50Hz
Power	160 W
Timer Setting	1 to 30-minute full range time
Ultrasonic Frequency	35,000Hz (35 KHz)
Material of Tank	Stainless steel SUS304
Tank Capacity	2000ml (Max: 1700ml, Min:550ml)
Material of Housing	ABS
Gross Weight (G.W.)	2.9 kg / 6.4lb
Weight (N.W.)	2.2 kg / 4.9lb
Dimensions (LxWxH)	265x230x180 mm(10.4" x 9.1" x 7.1")
Individual packing	Color box
Accessories: Basket	



▶ 8PK-366NA / 8PK-366N-B / 8PK-366N-G



8PK-366NA

8PK-366N-B

8PK-366N-G



Model No.	Material	Suction capacity	OAL.	Individual packing
8PK-366NA	ABS	30cm-Hg	205mm	Blister card
8PK-366N-B				
8PK-366N-G				



5PK-366NA-T

▶ 8PK-366N-O / 8PK-366N-S / 8PK-366N-Y



8PK-366N-O

8PK-366N-S

8PK-366N-Y

Model No.	Material	Suction capacity	OAL.	Individual packing
8PK-366N-O	ABS	30cm-Hg	205mm	Blister card
8PK-366N-S		35cm-Hg		
8PK-366N-Y		30cm-Hg		



5PK-366N-T

Desoldering Pump

- Piston with double oil seals: no air leakage guarantee
- Anti-rust lasting spring and easy replaceable tip
- Special cushion structure decreases 40% of the back attack force

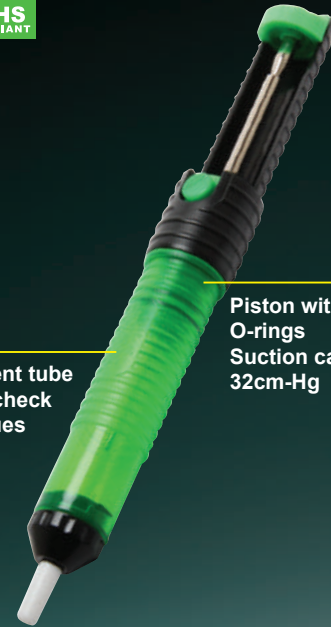

Piston with double O-rings
Suction capability: 32cm-Hg

Transparent tube to easily check the residues



Piston with double O-rings avoids air leakage



Detachable pump is simple to clear solder residues



Transparent tube is easy to check solder residue

▶ 8PK-366D

▶ 908-366A

▶ DP-366C

▶ DP-366D

▶ DP-366J

▶ DP-366P



508-366D-T



508-366A-T



508-366C-T



5DP-366D-T



5DP-366J-T



5PK-366PN-T

Model No.	Material	Suction capacity	OAL.	Individual packing
8PK-366D	Aluminum	30cm-Hg	163mm	Blister card
908-366A		32cm-Hg	195mm	
DP-366C		34cm-Hg	195mm	
DP-366D	ABS	32cm-Hg	210mm	
DP-366P		40cm-Hg	330mm	
DP-366J	PC	32cm-Hg	210mm	

▶ SN-390 Adjustable Soldering Clamp Holder

**Max. Open 200mm
Allow 360° Rotation**

Features

Rigid metal structure • Rubber pad
• 2 adjustable ABS grip • 4 different thicknesses • Lightweight design



4 different thickness holders



Allows 360 degrees rotation and can be secured in any position

Material	Max. circuit board size	Circuit board thick	Dimensions	Individual packing
ABS arm + metal base	20 x 14 cm	1.2 / 1.8 / 2.0 / 3.0mm	30 x 16.5 x 12.5 cm	Color box

▶ SN-396 Soldering Helping Hand with LED Magnifier



**16 SMD LEDs
Magnifiers**



Magnifying lens size	Ø90mm & Ø20mm	
Magnification	2.5X(6D) + 6.25X(21D)	
Magnification material	Acrylic	
Light source	16 pcs SMD LEDs	
Neck length (for magnifier)	265mm	
Neck length (for alligator clips)	250mm	
Base size	190x170mm	
Power	Battery	1.5V AA x 4pcs batteries (not included)
	Adaptor	DC 6V 0.5A adaptor input (not included)
Individual packing	Color box	

Accessories:
Sponge size(30 x 50mm), Solder flux x10g, Brass tip cleaner x17g

▶ SN-394 Helping Hands Octopus Clamp Kit

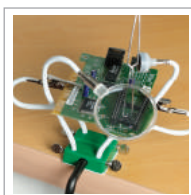

Multi function

- Maximum thickness of table or bench edge: 1.5"(40mm)
- Including magnifier arm x1, magnet arm x1, stayput arms x4
- Individual packing: Blister card

▶ SN-392 Helping Hands



- The practical helper for electronics and model-making.
- Holding clamps adjustable in many ways, complete with magnifying glass Ø 3.5"(90mm), magnification:2.5X.
- Individual packing: Blister card.

Helping Hands

▶ 608-391A



▶ 608-391E



▶ 608-391B

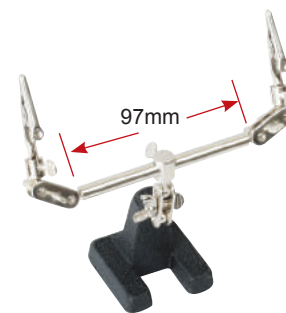

Model No.	Material			Magnification	Base OAL.	Individual packing
	Magnifier	Arm	Base			
608-391A	Acrylic	Low carbon steel	Cast-iron	Ø 50mm 6D(2.5X)	54x54x57mm	Color box
608-391E	Glass			Ø 60mm 7.5D(3X)	55x55x35mm	
608-391B	Non			Non	54x54x57mm	

▶ 8PK-362 Soldering Stand



Individual packing
Color box

▶ 6S-2 ▶ SN-002 Soldering Stand

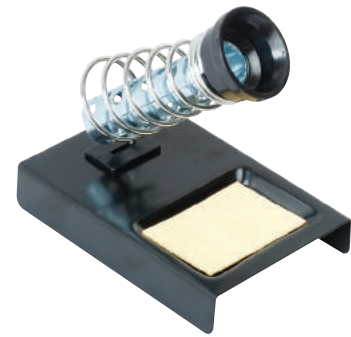

Model No.	Individual packing
6S-2	Color box
SN-002	Blister card

▶ 8PK-362A Soldering Stand



Individual packing
Color box

▶ 8PK-033ST Solder Reel Stand

- Holds up to 1kg roll of solder wire.
- Keep benches neat and draw out solder wire smoothly.



(Solder is not included)

Shaft diameter	OAL.	Individual packing
15mm	86x14x78mm	Color box

▶ 8PK-362S Mini Soldering Stand



- 2 position iron holder stand
- Built-in sponge tray



Individual packing
Color box (2pcs/pack)

▶ SH-1025 Soldering Tip Cleaner



- No water necessary.
- Anti-slip pad.
- Made of low abrasive brass shavings.
- Cleans better than conventional sponges.
- No temperature drop as in conventional sponges.

Model No.	Description	Spec	Individual packing
SH-1025	#62 copper cleaner with iron base	ø83 x 27mm	Blister card
SH-1025-B	#62 copper cleaner	25g x 5 pcs	Hanger (5 pcs/pack)

▶ 1PK-362D Soldering Tool Stand



Anti-Slip Bottom • 3 Angles • Durable



Individual packing
Blister card

▶ SH-4020 Soldering Iron Box



- Made by punched steel plate into an easy-carrying soldering tool box.

Material	OAL.	Individual packing
Iron	273 x 78 x 43mm	Color sleeve

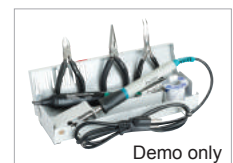

▶ 1PK-3616 Solder Aid Tools

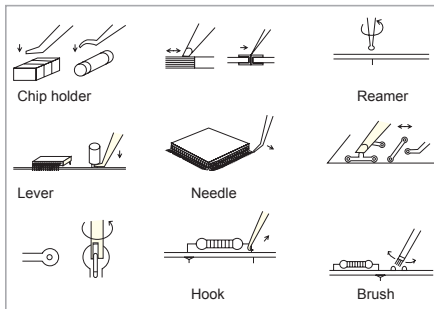

Individual packing
Blister card

▶ SH-4017 Solder Aid Tools



- Quick-bend function 0.5"/0.6"/0.7" pitch (5/6/7-hole)
- 30° incline design
- The heat sink: Help doing wire layout for work smart and efficiently.

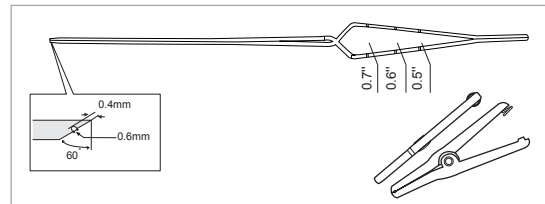
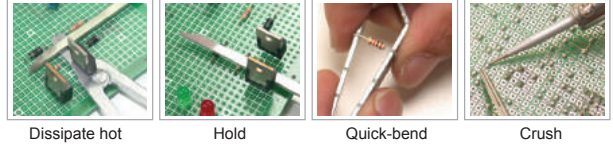

▶ DP-3616 Solder Aid Tools

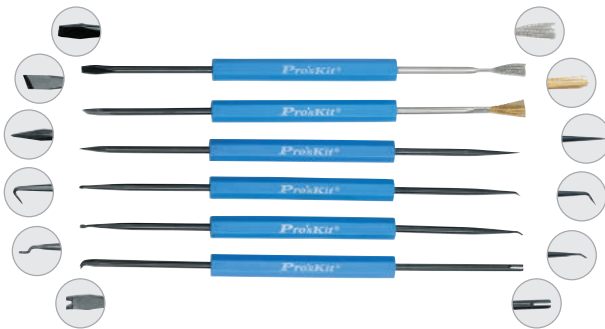

Individual packing
Blister card

▶ 108-361 Solder Aid Tools

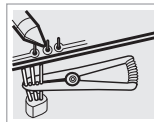

Individual packing
Blister card



▶ 1PK-H074/9H084/9H085/9H086 Solder Aid Tools

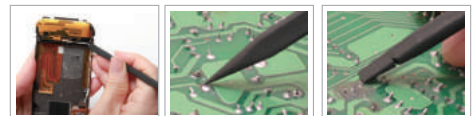

Model No.	Material	OAL.(mm)	Individual packing
1PK-H074	Nylon+Fiber	150	Blister card
9H084		155	Polybag
9H085		140	
9H086		173	

▶ 8PK-033 Series Solder



Model No.	Weight(g)	Ingredients	Dia(mm)	Model No.	Weight(g)	Ingredients	Dia(mm)
8PK-033D	100	63% Sn	0.8	8PK-033K	250	63% Sn	1.0
8PK-033DD	100	2% Ag	0.8	8PK-033KD	250	2% Ag	1.0
8PK-033DDS	100	2% Ag	0.6	8PK-033L	250	63% Sn	1.2
8PK-033DS	100	63% Sn	0.6	8PK-033LD	250	2% Ag	1.2
8PK-033E	100	63% Sn	1.0	8PK-033P	500	63% Sn	0.8
8PK-033ED	100	2% Ag	1.0	8PK-033PD	500	2% Ag	0.8
8PK-033F	100	63% Sn	1.2	8PK-033PDS	500	2% Ag	0.6
8PK-033FD	100	2% Ag	1.2	8PK-033PS	500	63% Sn	0.6
8PK-033J	250	63% Sn	0.8	8PK-033Q	500	63% Sn	1.0
8PK-033JD	250	2% Ag	0.8	8PK-033QD	500	2% Ag	1.0
8PK-033JDS	250	2% Ag	0.6	8PK-033R	500	63% Sn	1.2
8PK-033JS	250	63% Sn	0.6	8PK-033RD	500	2% Ag	1.2

▶ DP-033 Series Anti-Hot Desoldering Wick

- Anti-scald Design
- Stainless Steel Mouth
- High Quality Desoldering Braid with unique no clean flux.

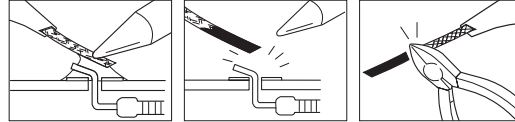

Model No.	Width	Length	Dimension
DP-033A	1.5mm	2m	101 x 47.5 x 18.5mm
DP-033B	2.0mm	2m	
DP-033C	2.5mm	2m	
DP-033D	3.0mm	1.5m	
DP-033E	3.5mm	1.5m	

▶ 9S001/9S002/9SN-310G Solder



9SN-310G

9S002

9S001

Model No.	Weight(g)	Ingredients	Dia (mm)	Individual packing
9S001	17	63% Sn	1.0	Inner box
9S002	17	2% Ag	0.8	
9SN-310G	15	Sn 99.3%, Cu0.7%	1.0	

▶ 8S005 Solder Paste



- Composed of metal powder activated flux and blending agents.
- The paste has a good diffusion and non-corrosion.
- No spot appears in non-soldered area.



Individual packing
Polybag

▶ 8PK-031A/8PK-031B/ 8PK-031C/DP-032B Desoldering Wick



- High quality desoldering braid with unique no clean flux.
- Pure oxygen-free copper wire.



- With dust free cover
- 2mm x 30M

▶ DP-032B

Model No.	Width(mm)	Length(M)	Individual packing
8PK-031A	1.5	1.5	Inner box
8PK-031B	2.0	1.5	
8PK-031C	2.5	1.5	
DP-032B	2.0	30	Blister card

ALIGNMENT TOOL & SCREWDRIVERS



The screwdriver is a basic tool that every man should have in his toolbox. *Pro'sKit*® screwdriver series serves all your needs.



Pro'sKit®

886-2-22183233
Sales support

pk@mail.prokits.com.tw
E-mail

www.prokits.com.tw
Global website

Alignment Tool & Screwdrivers

Pro'sKit® screwdrivers with the ergonomic handle, high quality blades and super hardened finished tip feature the maximum torque and user comfort.

Handle styles:

Pro'sKit® screwdrivers with various handle styles to meet the requirements for most of applications, including PVC, ABS, dual color non-slip ABS&TPR, ESD safe handles.

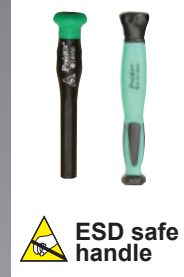

Ratchet types:



Pro'sKit® screwdrivers have a variety of styles. Some come with ratchet mechanism design, and some are articulated handles. Ratchet screwdriver requires less force but more torque than conventional handles. It comes with 3 positions adjustment: forward, reverse rotation and fixed. The articulated handles allow to adjust the angle up to 180° for quick screwing, especially in the narrow working space.

Material of bits and blades:

Pro'sKit® screwdriver blades and bits are made from high grade steel to meet the most of applications, including Chrome-Vanadium steel (Cr-V), Chrome-Molybdenum Vanadium steel (Cr-Mo-V), S2 alloy steel (S2). Tip with special hardened finished for perfect fit in screw slots and lasting durability.

Black tip



Black tip with hardened finished guarantees a long service life and increases corrosion protection.

Magnetic



Magnetic tip is for greater fastener control and guarantees a perfect fit every time.

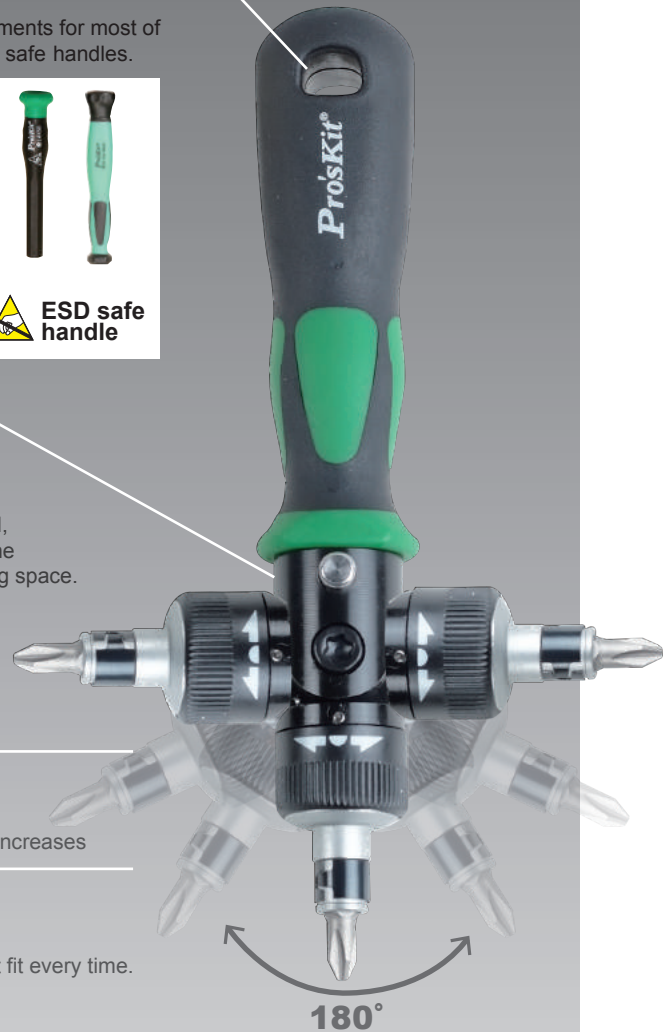

Symbols for blade and bit shapes

Pro'sKit® screwdrivers combination with many bit specifications for applying most screws.

		Tri-point tips			Needle type bits			Pantalobe	→ For Apple product (P.140/P.148-150)	
		Slotted			Spanner			Clutch		Wing nut driver
		Phillips			Phillips tamper proof			Pozidriv		Torq
		Torx®			Torx® tamper proof			Star		Spline
		Hex			Hex tamper proof			Ball hex		Nut
		Square			Square tamper proof			Triangle tip		TRI-wing tip
		Bi-hexagon socket			Square drive socket (for adapter)					

⚠ Safety Caution Don't use tools on live or energized circuits or equipment.

* Torx® is a trademark of Camcar Textron

▶ 9SD-2 Series Pro-soft Screwdriver

Elastomer resin fitting exactly and double structure. Non-slip.

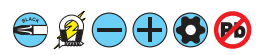

New design fits in well with your hand in shape, providing comfort and power

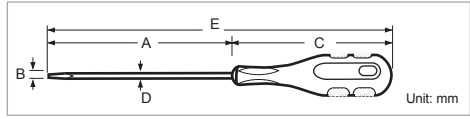
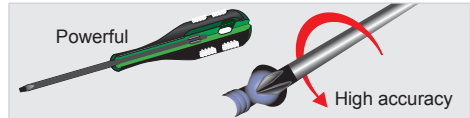

High grade AISI 8660 chrome-molybdenum vanadium steel.

Exactly fit to screws and high accuracy hardened finished.



Model No.	A	B	C	D	E
9SD-201B	75	⊕ #0	88	3.0	163
9SD-202B	75	⊕ #1	109	5.0	184
9SD-205B	100	⊕ #0	88	3.0	188
9SD-207B	100	⊕ #2	121	6.0	221
9SD-210B	100	⊕ #1	109	5.0	209
9SD-213B	150	⊕ #2	121	6.0	271
9SD-214B	200	⊕ #2	121	6.0	321
9SD-216B	150	⊕ #1	109	5.0	259
9SD-217B	250	⊕ #2	121	6.0	371
9SD-220B	40	⊕ #2	58	6.0	98
9SD-222B	150	⊕ #3	121	8.0	271

Individual packing: Inner box

Model No.	A	B	C	D	E	
9SD-201A	75	⊖	3.0	88	3.0	163
9SD-202A	75	⊖	5.0	109	5.0	184
9SD-205A	100	⊖	3.0	88	3.0	188
9SD-207A	100	⊖	6.0	121	6.0	221
9SD-210A	100	⊖	5.0	109	5.0	209
9SD-213A	150	⊖	6.0	121	6.0	271
9SD-214A	200	⊖	6.0	121	6.0	321
9SD-220A	40	⊖	6.0	58	6.0	98
9SD-222A	150	⊖	8.0	121	8.0	271

Individual packing: Inner box

Model No.	A	B	C	D	E
9SD-200-T05H	50	⊗ T5H	88	3.0	159
9SD-200-T06H	50	⊗ T6H	88	3.0	159
9SD-200-T07H	50	⊗ T7H	88	3.0	159
9SD-200-T08H	50	⊗ T8H	88	3.0	159
9SD-200-T09H	50	⊗ T9H	88	3.0	159
9SD-200-T10H	75	⊗ T10H	88	3.0	184
9SD-200-T15H	75	⊗ T15H	88	4.0	184

Individual packing: Inner box

▶ SD-2301/SD-2302 Pro-soft Screwdriver Set



SD-2301



SD-2302

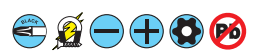

Model No.	Contents	Individual packing	
SD-2301	<ul style="list-style-type: none"> ⊖ 3.0x75mm ⊖ 5.0x75mm ⊖ 6.0x100mm 	<ul style="list-style-type: none"> ⊕ #0x75mm ⊕ #1x75mm ⊕ #2x100mm 	Color box
SD-2302	<ul style="list-style-type: none"> ⊗ T5HX50mm ⊗ T6HX50mm ⊗ T7HX50mm ⊗ T8HX50mm 	<ul style="list-style-type: none"> ⊗ T9HX50mm ⊗ T10HX75mm ⊗ T15HX75mm 	Color box

ALIGNMENT TOOL & SCREWDRIVERS

SD-2393K/8PK-403S 93 PCS Pro-soft Screwdriver Set w/Display Rack

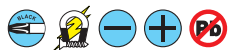

Model No.	Pcs
9SD-201A	10
9SD-201B	10
9SD-202A	4
9SD-202B	8
9SD-205A	5
9SD-205B	5
9SD-207A	3
9SD-207B	6
9SD-210A	4
9SD-210B	8
9SD-213A	3
9SD-213B	3
9SD-214A	3
9SD-214B	3
9SD-216B	3
9SD-217B	3
9SD-220A	3
9SD-220B	3
9SD-222A	3
9SD-222B	3

Individual packing: Plain box



Empty rack : 8PK-403S

Display rack size:520x275x358mm

SW-2128/8PK-401S 116 PCS Pro-soft Screwdriver Set w/Display Rack



Model No.	Pcs
89400-T05H	5
89400-T06H	5
89400-T07H	5
89400-T08H	5
89400-T09H	5
89400-T10H	5
89400-T15H	5
89400-T20H	5
89401A	5
89401B	5
89402A	4
89402B	4
89405A	5
89405B	5
89407A-L	6
89407B-L	6
89410A	4
89410B	4
89412A	4
89412B	4
89413B	3
89414B	3
89416A	4
89416B	4
9SD-220A	3
9SD-220B	3

Individual packing: Plain box



Empty rack : 8PK-401S

Display rack size:520x275x358mm

ALIGNMENT TOOL & SCREWDRIVERS

894 Series Pro-Soft Screwdrivers



- The molded propylene handles feature insert molded blades for improved grip.



Molded propylene handle

High grade AISI 8660 Ni-Cr-Mo

Satin finished and black oxide tip



Special inlayed blade insert; safe and durable

Model No.	A	B	C	D	E	
89401A	75	⊖	3.2	85	3.2	160
89402A	75	⊖	5.0	110	5.0	185
89405A	100	⊖	3.2	85	3.2	185
89407A	100	⊖	6.0	110	6.0	210
89407A-L	57	⊖	6.0	153	6.0	210
89410A	100	⊖	5.0	110	5.0	210
89412A	250	⊖	5.0	110	5.0	360
89413A	107	⊖	6.0	153	6.0	260
89414A	157	⊖	6.0	153	6.0	310
89416A	150	⊖	5.0	110	5.0	260
89417A	207	⊖	6.0	153	6.0	360

Individual packing: Inner box

Model No.	A	B	C	D	E	
89401B	75	⊕	#0	85	3.2	160
89402B	75	⊕	#1	110	5.0	185
89405B	100	⊕	#0	85	3.2	185
89407B	100	⊕	#2	110	6.0	210
89407B-L	57	⊕	#2	153	6.0	210
89410B	100	⊕	#1	110	5.0	210
89412B	250	⊕	#1	110	5.0	360
89413B	107	⊕	#2	153	6.0	260
89414B	157	⊕	#2	153	6.0	310
89416B	150	⊕	#1	110	5.0	260
89417B	207	⊕	#2	153	6.0	360

Individual packing: Inner box

19400-M Series Electronic Hex Nut Drivers



- Extra-thin walled, with duplex color rubber handles for hexagon nuts and bolts.



Molded propylene handle

High grade AISI 8660 Ni-Cr-Mo

SUM24L

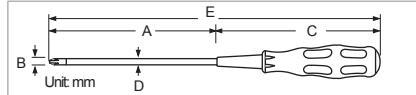

Model No.	A	B	C	D	E	
19400-M3	70	⊙	3.0	85	4.0	155
19400-M3.5	70	⊙	3.5	85	4.0	155
19400-M4	70	⊙	4.0	85	4.0	155
19400-M4.5	70	⊙	4.5	85	4.0	155
19400-M5	70	⊙	5.0	85	4.0	155
19400-M5.5	70	⊙	5.5	85	4.0	155
19400-M6	70	⊙	6.0	85	4.0	155

Individual packing: Blister card

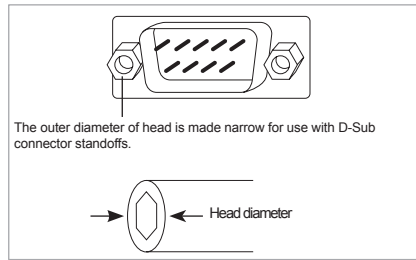

1PK-9401 8 PCS Pro-soft Screwdriver Set



Contents

89401A, 89401B, 89402A, 89402B, 89407A, 89407B, 9SD-220A, 9SD-220B

Case: 310x230x50mm

Individual packing: Inner box + Color label shrink

1PK-9402 7 PCS Electronic Hex Nut Driver Set



Contents

19400-M3, 19400-M3.5, 19400-M4, 19400-M4.5, 19400-M5, 19400-M5.5, 19400-M6

Individual packing: Pouch

89400 Series Pro-Soft Screwdrivers



- Tamper-proof holes are provided for screws such as torx screws with a projection in the screw head.
- These screws are used in cases where tampering could be a problem.
- Select the size for working with mobile telephones, communication equipments, radios and precision equipments.

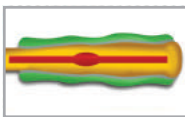

Special inlaid blade insert; safe and durable



Star Screwdriver Includes Tamper Proof Holes

Blade material: S2 Steel

Model No.	A	B	C	D	E
89400-T05	50	T5	85	4.0	135
89400-T06	50	T6	85	4.0	135
89400-T07	50	T7	85	4.0	135
89400-T08	80	T8	85	4.0	165
89400-T09	80	T9	85	4.0	165
89400-T10	80	T10	85	4.0	165
89400-T15	80	T15	85	4.0	165
89400-T05H	50	T5H	85	4.0	135
89400-T06H	50	T6H	85	4.0	135
89400-T07H	50	T7H	85	4.0	135
89400-T08H	80	T8H	85	4.0	165
89400-T09H	80	T9H	85	4.0	165
89400-T10H	80	T10H	85	4.0	165
89400-T15H	80	T15H	85	4.0	165
89400-T10HL	100	T10H	85	4.0	185
89400-T15HL	100	T15H	85	4.0	185
89400-T20HL	100	T20H	85	4.0	185
89400-T10HLX	150	T10H	85	4.0	235

Individual packing: Inner box

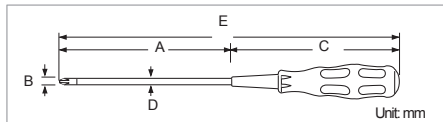

Hex Socket Type Screwdriver

Model No.	A	B	C	D	E
89400-H1.5	90	1.5	85	1.5	175
89400-H2	90	2.0	85	2.0	175
89400-H2.5	90	2.5	85	2.5	175
89400-H3	90	3.0	110	3.0	200

Individual packing: Inner box

Tri-wing Type Screwdriver

Model No.	A	B	C	D	E
89400-TRI	50	3.2	85	3.2	135

Individual packing: Blister card



Molded propylene handle

Alloy tool steel

Satin finished and black oxide tip

SW-2125 / SW-2125H 5 PCS Star Screwdriver Set



Model No.	Contents
SW-2125	89400-T05, 89400-T06, 89400-T07, 89400-T08, 89400-T09
SW-2125H	89400-T05H, 89400-T06H, 89400-T07H, 89400-T08H, 89400-T09H

Individual packing: Blister card



ALIGNMENT TOOL & SCREWDRIVERS

891 Series High Quality Line Color Screwdriver

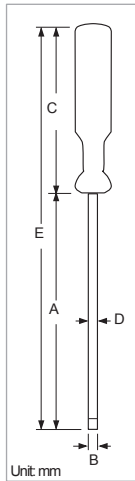

Model No.	A	B	C	D	E
89101A	75	⊖ 3.2	56	3.2	131
89102A	75	⊖ 5.0	80	5.0	155
89105A	100	⊖ 3.2	56	3.2	156
89106A	150	⊖ 3.2	56	3.2	206
89107A	100	⊖ 6.0	90	6.0	190
89110A	100	⊖ 5.0	80	5.0	180
89112A	250	⊖ 5.0	80	5.0	330
89113A	150	⊖ 6.0	90	6.0	240
89114A	200	⊖ 6.0	90	6.0	290

Model No.	A	B	C	D	E
89101B	75	⊕ #0	56	3.2	131
89102B	75	⊕ #1	80	5.0	155
89105B	100	⊕ #0	56	3.2	156
89106B	150	⊕ #0	56	3.2	206
89107B	100	⊕ #2	90	6.0	190
89110B	100	⊕ #1	80	5.0	180
89112B	250	⊕ #1	80	5.0	330
89113B	150	⊕ #2	90	6.0	240
89114B	200	⊕ #2	90	6.0	290

Model No.	A	B	C	D	E
89115A	200	⊖ 5.0	80	5.0	280
89116A	150	⊖ 5.0	80	5.0	230
89117A	250	⊖ 6.0	90	6.0	340
89118A	200	⊖ 3.2	56	3.2	256
89119A	300	⊖ 5.0	80	5.0	380
89120A	38	⊖ 6.0	45	6.0	83
89121A	300	⊖ 6.0	90	6.0	390
89122A	150	⊖ 8.0	100	8.0	250
89123A	200	⊖ 8.0	100	8.0	300

Model No.	A	B	C	D	E
89115B	200	⊕ #1	80	5.0	280
89116B	150	⊕ #1	80	5.0	230
89117B	250	⊕ #2	90	6.0	340
89118B	200	⊕ #0	56	3.2	256
89119B	300	⊕ #1	80	5.0	380
89120B	38	⊕ #2	45	6.0	83
89121B	300	⊕ #2	90	6.0	390
89122B	150	⊕ #3	100	8.0	250
89123B	200	⊕ #3	100	8.0	300

Individual packing: Inner box

SW-9106 Line Color Screwdriver Set (6 pcs)



Contents	
⊖	89101A
⊖	89102A
⊖	89107A
⊕	89101B
⊕	89102B
⊕	89107B

Individual packing: Blister card

SW-9109D 10 In 1 Double End Reversible Screwdriver Set



Contents		
1pc PVC handle with 1/4" bits holder, length: 100mm		
6 bits, material: AISI 6150 Cr-V, HRC 52 ^{±2} °		Length
⊕ #2	⊖ 6.0	110mm
⊕ #2	⊕ #2	110mm
⊕ #2	⊕ #2	65mm
⊕ #2		100mm
⊕ #1		100mm
⊕ #2	⊕ #2	150mm

Individual packing: Blister card

ALIGNMENT TOOL & SCREWDRIVERS

SD-51 Series Line Color Screwdriver



Model No.	A	B	C	D	E	
SD-5101A	75	⊖	3.0	57	3.0	132
SD-5102A	75	⊖	5.0	80	5.0	155
SD-5105A	100	⊖	3.0	57	3.0	157
SD-5106A	150	⊖	3.0	57	3.0	207
SD-5107A	100	⊖	6.0	90	6.0	190
SD-5110A	100	⊖	5.0	80	5.0	180
SD-5112A	250	⊖	5.0	80	5.0	330
SD-5113A	150	⊖	6.0	90	6.0	240
SD-5114A	200	⊖	6.0	90	6.0	290
SD-5116A	150	⊖	5.0	80	5.0	230
SD-5117A	250	⊖	6.0	90	6.0	340
SD-5119A	300	⊖	5.0	80	5.0	380
SD-5120A	38	⊖	6.0	45	6.0	83
SD-5121A	300	⊖	6.0	90	6.0	390

Model No.	A	B	C	D	E	
SD-5101B	75	⊕	#0	57	3.0	132
SD-5102B	75	⊕	#1	80	5.0	155
SD-5105B	100	⊕	#0	57	3.0	157
SD-5106B	150	⊕	#0	57	3.0	207
SD-5107B	100	⊕	#2	90	6.0	190
SD-5110B	100	⊕	#1	80	5.0	180
SD-5112B	250	⊕	#1	80	5.0	330
SD-5113B	150	⊕	#2	90	6.0	240
SD-5114B	200	⊕	#2	90	6.0	290
SD-5116B	150	⊕	#1	80	5.0	230
SD-5117B	250	⊕	#2	90	6.0	340
SD-5119B	300	⊕	#1	80	5.0	380
SD-5120B	38	⊕	#2	45	6.0	83
SD-5121B	300	⊕	#2	90	6.0	390

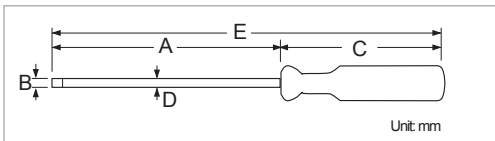

Individual packing: Inner box



SW-9107D Double-end Reversible Screwdriver

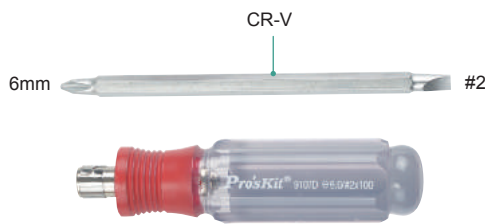

Material	HRC	Handle	Blade	Working length	Individual packing
AISI 6150	52'±2'	95mm	126mm	100mm	Blister card

SD-5107D Double-end Reversible Screwdriver

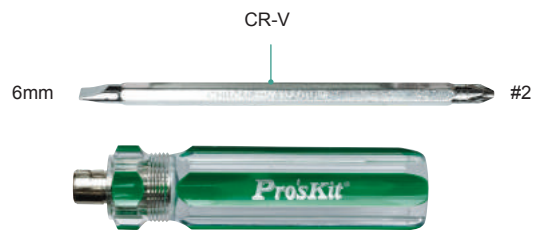
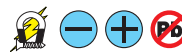

Material	HRC	Handle	Blade	Working length	Individual packing
AISI 6150	48'±3'	108 mm	125 mm	100 mm	Blister card

ALIGNMENT TOOL & SCREWDRIVERS

SD-2800 Series Dual Color Grip Nut Driver

Dual color PP+TPR cushion grip handle



Chrome plated anti corrosion finished

Material: AISI50BV30 Boron steel

Heavy duty deep head blade



- Dual color, ergonomic cushion grip handles for maximum comfort.
- The handle is molded directly onto the blade for permanent bonding.
- Heavy duty deep head blades, hardened for maximum torque and wear resistance
- Precision heads for accurate fastener fit
- Handle end comes with screw type mark for easy identification



Model No.	Nut size & depth	Blade length	OAL
SD-2800-M4	4 x 2 mm	125 mm	235 mm
SD-2800-M5	5 x 25 mm	125 mm	235 mm
SD-2800-M5.5	5.5 x 25 mm	125 mm	235 mm
SD-2800-M6	6 x 25 mm	125 mm	235 mm
SD-2800-M7	7 x 25 mm	125 mm	235 mm
SD-2800-M8	8 x 25 mm	125 mm	235 mm
SD-2800-M9	9 x 25 mm	125 mm	235 mm
SD-2800-M10	10 x 25 mm	125 mm	235 mm
SD-2800-M11	11 x 25 mm	125 mm	245 mm
SD-2800-M12	12 x 25 mm	125 mm	245 mm
SD-2800-M13	13 x 25 mm	125 mm	245 mm

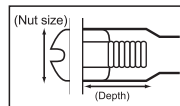

Individual packing: Double blister card

SD-2400 Series Spanner Type Security Screwdriver

Fast turning swivel cap for easy operation



Dual color TPR and PP non-slip handle

Made of AISI 8660 Cr-Mo-V steel with Cr plated for antirust HRC:55'±2'



- Made of Cr-Mo-V steel with chromium (Cr) plating for anti-rust
- Special inlayed blade molded into handle provides high torque and user comfort.

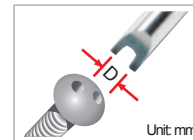

Model No.	D	OAL (mm)
SD-2400-S4	1.5	186
SD-2400-S6	2.3	186
SD-2400-S8	2.5	186
SD-2400-S10	3.1	186
SD-2404	Contents: 4pcs Security Screwdriver Set. SD-2400-S4, SD-2400-S6, SD-2400-S8, SD-2400-S10	

Individual packing: Blister card



SD-9701M 20 IN 1 T-handle Driver Sockets & Bits Set

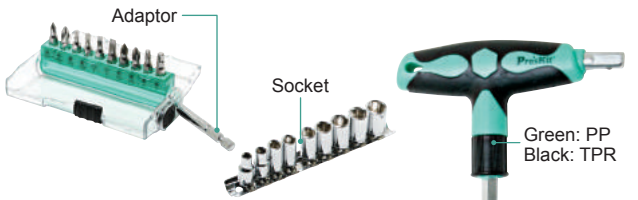

Contents	
TPR non-slip T handle with bits holder (182mm)	
10pcs hex bits: $\phi 1/4"$ x 25mm, Material: SAE 6150 Cr-V steel	
#1, #2	PZ1, PZ2
4.0, 5.0mm	4.0, 5.0mm
9 pcs $\phi 1/4"$ DR. Socket bits, Material: SAE 6150 Cr-V steel	
5, 6, 7, 8, 9, 10, 11, 12, 13mm (3/16", 1/4", 9/32", 5/16", 11/32", 3/8", 7/16", 1/2", 9/16")	
65mm Adaptor Carrying case: 115x55x17mm	

Individual packing: Blister card

Green: PP
Black: TPR

Magnetized carbon steel bits holder for 1/4" bits

SD-9816 16-IN-1 Reversible Ratchet Precision Screwdriver Set



- Click-stop ball clamp guarantees a secure hold and daily use comfort
- Reversible blades ensure perfect fit every time.
- Flexible, adjustable blade length.
- Hex retainer design for easy assembling.

Contents	
3 position ratchet handle, length: 155mm	
8pcs double end hex bits : $\phi 1/4"$ x 175mm Material: S2 Alloy steel	
4.0, 5.0	6.0, 7.0
T20, T30	T25, T40
H5.0, H6.0	HB5.0, HB6.0
#1	#2
PZ1	PZ2

Individual packing: Blister card



SD-2313 30-Pcs Do-It-All Kit



- Triangle magnetic bits storage case with a hanger.
- Magnetic extension handle.
- Compact and versatile set of bits.

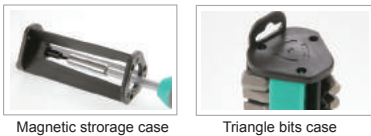

Magnetic storage case

Triangle bits case

Bits	
TPR non-slip handle with bits holder, 30pcs hex bits: $\phi 1/4"$ x 25mm, Material: SAE 6150 Cr-V steel	
SQ1, SQ2	
#0, #1, #2, #3	
PZ0, PZ1, PZ2, PZ3	
SL3.5, 4.5, 5.5, 6, 8	
H2, 2.5, 3, 4, 5, 6, 8	
T5, T6, T7, T8, T10, T15, T20, T35	

Individual packing: Hanger



1PK-SD006 6 in 1 Magnetic Quick Change Screwdriver



- Industrial quality with maximum versatility.
- Shock proof T.P.R + P.P.
- OAL.: 200mm

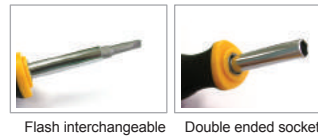

Flash interchangeable

Double ended socket

Contents	
Dual color TPR non-slip handle 125mm	
3pcs double end bits and socket:	
8mm socket x115mm	
6mm socket x115mm	
3/16", 1/4" x75mm	
#1, #2 x75mm	

Individual packing: Blister card



SD-9817 6 In 1 Ratchet Screwdriver Set



- Pivoting head locks in 3 operating positions allowing better control & access to confined areas
- Ergonomic dual color TPR+PP handle with bits storage inside
- Magnetized hex opening holds all standard driver bits, and allows quick removal and replacement
- 3 position ratchet features forward, reverse and locked for efficient work

Contents	
1pce 3-way ratchet screwdriver handle	
6 pcs 1/4" Bits: 4, 5, 6mm #1, #2, #3	

Individual packing: Blister card



8PK-SD010 12-In-1 Ratchet Screwdriver Set

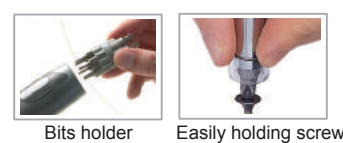

Bits holder

Easily holding screw

Contents	
Dual color TPR non-slip ratchet handle	
12pcs $\phi 1/4"$ x 30mm bits:	
T6, T7, T8, T9, T10, T15	
#0, #1, #2	
3, 4, 7, 6.3	

Individual packing: Blister card

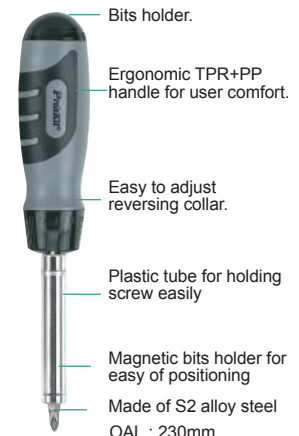

Bits holder.

Ergonomic TPR+PP handle for user comfort.

Easy to adjust reversing collar.

Plastic tube for holding screw easily

Magnetic bits holder for easy of positioning

Made of S2 alloy steel OAL.: 230mm

SD-2320M 18-IN-1 Mini T-handle Ratchet Set



T-handle with ratchet design
Quick release chuck
3 extension length adjustment



3 Extension Length Adjustment Ratchet and Quick Release Design

- Made from quality steel and rubber for better strength and durability.
- The T-handle with ratchet design provides greater force and comfort.
- The unit comes with essential bits and sockets, it is a must have for home, car and office.

Contents			
9pcs 1/4" bits, Material: Cr-V			
⊖ 3.0 / 5.0 / 6.0mm	⊕ PH1 / PH2 / PH3	⊗ T10 / T15 / T20	
6pcs 1/4" drive sockets, Material: Carbon steel			
⊖ 5.0 / 6.0 / 7.0 / 8.0 / 9.0 / 10.0mm			
1pce Mini T-Handle ratchet driver	1pce Extension bar	1pce Adapter	

Individual packing: Blister card

SD-2314M 25-IN-1 Reversible Ratchet Screwdriver w/Bits & Sockets Set

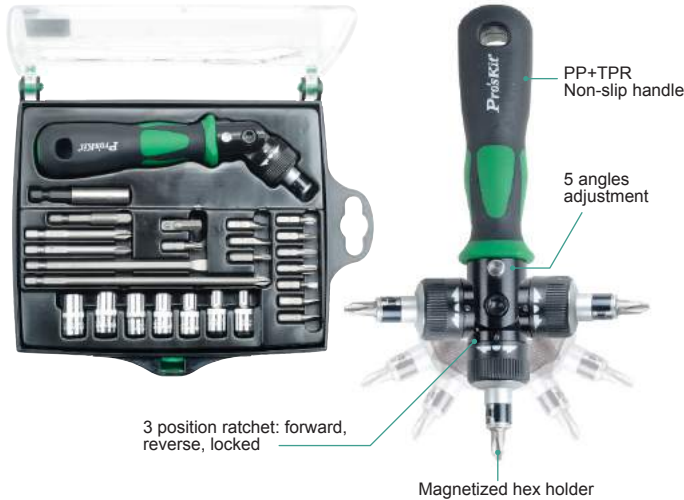

PP+TPR Non-slip handle
5 angles adjustment
3 position ratchet: forward, reverse, locked
Magnetized hex holder



- Pivoting head locks in 5 operating positions for adjustment up to 180 degree angle to meet application requirements.
- Ergonomic dual color TPR handle provides more comfortable operation, nonslip.

Contents			
3 position ratchet T handle			
22pcs hex bits and socket : ø1/4" Material: S2 Alloy steel			
⊖ 3, 4, 5, 6, 7	⊕ #0, #1, #2, #3	⊗ T15, T20	
⊖ 4, 5, 6, 7, 8, 9, 10	⊕ #2 x 65mm x 2 pcs	⊖ 7.0 x 110 mm	
⊕ #2 x 150 mm			
1/4" x25mm Adaptor, 1/4"x50mm Adaptor, ø1/4" x 60mm bits holder			
Carrying case: 195x184x28mm			

Individual packing: Shrink

SD-2319M 22PCS Palm Ratchet Wrench & Socket Set



- Faster than a ratcheting wrench, the palm ratchet for easy operation in limited areas
- Combining with ergonomic aluminum handles to provide maximum speed and torque
- Covering most common use bits and sockets to meet most applications



Contents			
5pcs 1/4" Drive socket: ⊖ 5, 6, 7, 8, 10mm			
14pcs 1/4" Bits:			
⊖ 3.0, 4.0, 6.0mm	⊕ #1, #2, #3		
⊗ T10, T15, T20			
⊖ H2.5, H3.0, H4.0, H5.0, H6.0			
1/4" Hex(male) to 1/4" socket(male) adaptor			
Extension handle for palm ratchet			
1/4" Drive aluminum palm ratchet			
Plastic case 126x82x30mm			

Individual packing: Color box

8PK-2066 Interchangeable Screwdriver Set (7 PCS)



- Shock proof cellulose acetate plastic handle with circuit testing lamp.
- Range: AC 100~250V.



Contents	
Circuit testing handle, length: 120mm	
6 pcs bits, length: 125mm	
Material: AISI 6150 Cr-V Alloy steel	
⊖	5, 6
⊕	No.1, No.2
⊗	5.5
⊖	AWL

Individual packing: Plastic box+Color label

SD-9810A 10 IN 1 Auto Loading Ratchet Screwdriver Set

10 in 1 Change Bits in Seconds

- Precision screwdriver features 3 ways gearless ratchet with twist reverse for efficient operation.
- Pump-action design for easily and quickly auto-loading bits exchange.
- Includes 10 pcs of high quality AISI 8660 Cr-Mo-V alloy steel bits with satin finished.

Contents	
25pcs in a display box Display color box:219x217x173mm	
Each screwdriver includes:	
3 position ratchet handle	
10pcs hex bits :ø4 x 28 mm Material: AISI8660 Cr-Mo-V Alloy steel	
+	#00,#0,#1
-	1.5, 2.0, 3.0mm
⊕	T5, T6, T8, T10



Display color box 219x217x173mm (open)

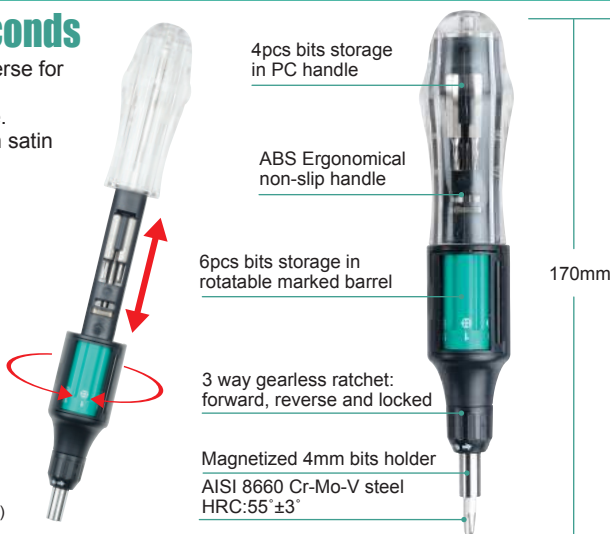

1PK-212 Twin Wrench Driver Set



Contents	
Both end handle 110mm	
10pcs ø1/4"x30mm AISI 6150 Cr-V steel bits:	
-	4, 5, 6
+	PZ1, PZ2
⊕	#1, #2
⊕	T10, T15, T20

Individual packing: Blister card



Design with tips at both ends for horizontal and vertical use.

1PK-212H Twin Wrench Driver Set



Contents	
Both end handle 110mm	
8pcs ø1/4"x30mm AISI 6150 Cr-V steel bits:	
⊕	T6
⊕	T8H, T10H, T15H, T20H, T25H, T27H, T30H
2pcs ø1/4"x37mm AISI 6150 Cr-V steel double end bits:	
⊕ #1 -	4.5
⊕ #2 -	6.0

Individual packing: Blister card

T6 to T30H have tamper proof holes for preventing tampering for cordless tele-phones and wireless equipment.

1PK-201 Flexible Ratchet Driver Set



Contents	
10pcs ø1/4"x30mm AISI 6150 Cr-V steel bits:	
-	4, 5, 6
+	#1, #2
⊕	PZ1, PZ2
⊕	T10, T15, T20
Flexible shaft (190mm)	
Mini ratchet handle	

Individual packing: Blister card



Flexible shaft gets into hard to reach areas.

8PK-SD009 8PK-SD009E 33PCS Security Bit Kit

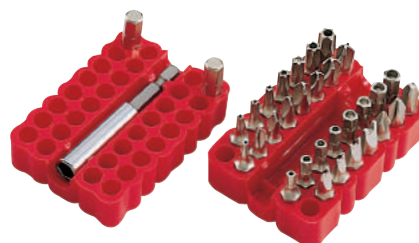

Contents	
1/4" Magnetic extension bar 60mm	
32pcs ø1/4"x30mm bits:	
Spec.	
⊕ 5/64", 3/32", 7/64", 1/8", 9/64", 5/32", 3/16", 1/4"	⊕ 4, 6, 8, 10
⊕ T8H, T10H, T15H, T20H, T25H, T27H, T30H, T35H, T40H	⊕ 1, 2, 3, 4
	⊕ 6, 8, 10
	⊕ 1, 2, 3, 4

Individual packing: Blister card

• 8PK-SD009E
Material: SAE6150 CR-V steel

• 8PK-SD009
Material:
S2 alloy steel bits

SD-2318M 27PCS 1/4" Drive Socket & Screwdriver Set



Socket meet DIN standard

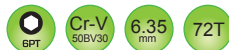

- High quality 5u plating thickness specification sockets
- Mini size gets into smaller and tighter spots easily
- Covering most common use bits and sockets
- Compact box with hanger design for easy carrying and storage



Bits with color ring for easy spec' identification



Screwdriver end for easy bits change



72 teeth 2-way ratchet stainless steel handle

Contents	
5pcs 1/4" Drive socket:	6, 7, 8, 10, 12mm
18pcs 1/4" Bits:	
3.0, 4.0, 5.0, 6.0mm	#1, #2, #3
PZ1, PZ2, PZ3	H3.0, H4.0, H5.0, H6.0
T10, T15, T20, T25	
Magnetic bit adaptor: 60mm(L)	
1pce 1/4" Hex(male) to 1/4" socket(male) adaptor	
1/4" square drive(female) to 1/4" hex bit holder	
1/4" 72 Teeth stainless reversible ratchet handle	
Plastic case 130x90x40mm	

Individual packing: Color box

SD-2610M Stainless Ratchet Bit Set



Mini Style, High Torque

2-way ratchet design for forward and reverse rotation, provide high torque: 200kgf-cm
Material: AISI 316C

Material: AISI 304
1/4" extension bar



- Made of stainless steel, which assure cleanliness and corrosion-resistance.
- Mini ratchet wrench gets into smaller and tighter spots easily.
- The stainless bits can be connected with power tools as well as pneumatic tools.
- Compact nylon holder with belt clip for easy carrying and storage.
- All materials fulfill Environmental Protection Requirement.

Contents	
Extension bar 60mm (L)	2-way ratchet handle 108mm
9pcs ϕ 1/4"x25mm AISI 420 stainless bits:	
4, 5, 6	#1, #2 3.0, 4.0, 5.0, 6.0

Individual packing: Blister card

1PK-202A 1PK-202B 17 PCS Offset Ratchet & Socket Drivers Set



2-way ratchet design for forward and reverse rotation.



Double end design and a direction switch for clockwise or counter-clockwise.

Model No.	Contents
1PK-202A	1pce 2-way ratchet handle, 6pcs sockets (ϕ 1/4" x 25mm, AISI 6150 Cr-V) 5, 6, 7, 8, 9, 10 (Metric size) 10pcs bits (ϕ 1/4" x 30mm, AISI 6150 Cr-V): 4, 5, 6mm #1, #2 PZ1, PZ2 T10, T15, T20
	1pce 2-way ratchet handle, 6pcs sockets (ϕ 1/4" x 25mm, AISI 6150 Cr-V): 3/8", 11/32", 5/16", 1/4", 7/32", 3/16" (Inch size) 10pcs bits (ϕ 1/4" x 30mm, AISI 6150 Cr-V): 4, 5, 6mm #1, #2 PZ1, PZ2 T10, T15, T20

Individual packing: Blister card

SD-205 62 PCS Security Bit Set



- Ratchet force saving design
- Materials: SAE 6150 Cr-V Steel
- Light weight design: 575g

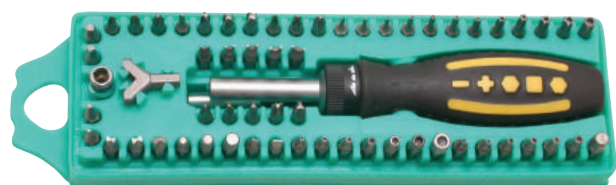

Contents			
58 pcs ϕ 1/4" x 25mm bits:			
M5, M6, M8	C1, C2, C3	1/8", 3/16"	
2mm x 2mm x 2mm	S0, S1, S2, S3	1, 2, 3, 4, 5	
#0, #1, #2	Wing nut driver	6, 8, 10	
PZ0, PZ1, PZ2	4, 6, 8, 10, 12		
T5H, T6H, T7H, T8H, T9H, T10H, T15H, T20H, T25H, T27H, T30H, T40H			
2mm, 2.5mm, 3mm, 4mm, 5mm, 6mm, 8mm, 5/64", 3/32", 7/64", 1/8", 9/64", 5/32"			
1 pce 1/4" x 60mm magnetic bits holder		1 pce bits holder socket	
1 pce socket adapter		1 pce dual color TPR non-slip ratchet screwdriver (190mm)	
Case : 256x80x43mm			

Individual packing: Shrink packing

8PK-204A 33 PCS Reversible Ratchet Screwdriver W/Bits & Sockets Set

Contents		
21 pcs ø1/4" x25mm bits:		
⊖ 4, 5, 6 mm	⊕ #1, #2, #3	
⊖ T10, T20, T30, T40	⊕ PZ1, PZ2, PZ3	
1.5, 2, 2.5, 3, 4, 5, 5.5, 6 mm		
7 pcs 1/4" DR. sockets: 4.5, 5, 6, 7, 8, 9, 10mm		
1 pce reversible ratchet screwdriver		
1 pce flexible extension (145mm)		
1 pce magnetic bit holder (100mm)		
1 pce socket adapter (25mm)		
Case: 227x71x46mm		

Individual packing: Shrink packing



- Ratchet force saving design
- Materials: SAE 6150 Cr-V Steel
- Light weight design: 575g



8PK-227 40 PCS Socket & Screwdriver Set

Contents		
14 pcs 1/4" DR sockets:		
4, 5, 6, 7, 8, 9, 10, 11, 12, 13, 14, 15, 17, 19mm		
20 pcs ø1/4" x 25 bits:		
⊖ 2.5, 3, 5, 6, 8	⊕ #0, #1, #2, #3	
⊖ 3, 4, 5, 6, 8	⊕ T10, T15, T20, T25, T30, T40	
Ratchet handle	Handle driver	
16 mm spark plug socket	Extension bar	
Hexagon bit holder	Adaptor	
Case: 273x97x46mm		

Individual packing: Shrink packing



- Ratchet force saving design
- Materials: SAE 6150 Cr-V Steel
- weight: 2400g

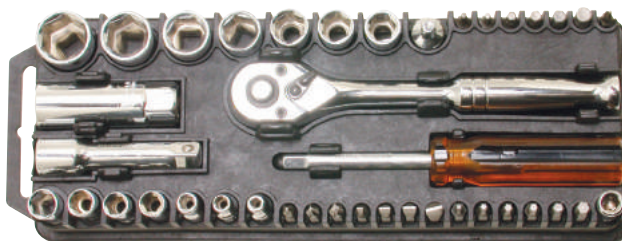

SD-2309 40 PCS Reversible Ratchet Screwdriver W/Bits & Sockets Set

Contents		
11 pcs 1/4" DR sockets:		
4mm, 5mm, 5.5mm, 6mm, 7mm, 8mm, 9mm, 10mm, 11mm, 12mm, 13mm		
26 pcs ø1/4" x 25mm bits:		
⊕ #0, #1, #2, #3		
⊖ 3mm, 4mm, 5mm, 6mm, 8mm		
⊖ 2mm, 2.5mm, 3mm, 4mm, 5mm, 6mm, 7mm		
⊖ T10, T15, T20, T25, T30, T40		
⊕ PZ0, PZ1, PZ2, PZ3		
1 pce adapter	1 pce magnetic bit holder 100mm	
1 pce 3-position reversible ratchet screwdriver		
Case: 228x72x45mm		

Individual packing: Color sleeve + Shrink packing



- Articulated handle allows adjusting angle up to 180 degree
- Ratchet force saving design
- Materials: SAE 6150 Cr-V Steel
- Light weight design: 679g

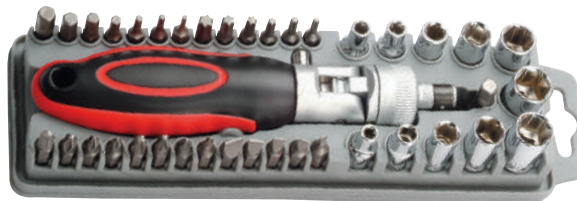

SD-2310 100 PCS Assorted Power Bits Set

Contents		
96 pcs ø1/4" x 25mm bits:		
⊕ #1, #2	⊕ S2: #0, #1, #2, #3	
⊖ C1, C2, C3	⊖ S0, S1, S2, S3	
⊕ 1, 2, 3, 4, 5	⊕ 6, 8, 10	
⊕ PZ0, PZ1, PZ2, PZ3	⊕ 2mm x 2mm x 2mm	
⊖ M5, M6, M8	⊖ 2mm, 3mm, 5mm	
⊖ 4, 6, 8, 10, 12	⊖ Wing nut driver	
1.5mm, 2mm, 2.5mm, 3mm, 4mm, 4.5mm, 5mm, 5.5mm, 6mm, 7mm, 8mm, 1/16", 5/64", 3/32", 7/64", 1/8", 9/64", 5/32", 3/16", 7/32", 1/4"		
2mm, 3mm, 4mm, 5mm, 6mm, 7mm, 8mm, 5/64", 3/32", 7/64", 1/8", 9/64", 5/32", 3/16", 7/32", 1/4"		
T5H, T6H, T8H, T10H, T15H, T20H, T25H, T27H, T30H, T35H, T40H		
T5, T6, T8, T10, T15, T20, T25, T27, T30, T40		
1 pce sockets adapter	1 pce dry wall stopper	
1 pce bits holder	1 pce magnetic bit holder	
Case: 212x64x31mm		

Individual packing: Color sleeve + Shrink packing



- Materials: SAE 6150 Cr-V Steel
- Light weight design: 699g

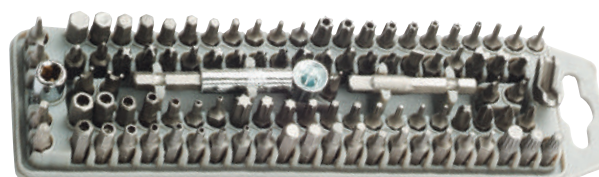

SD-9857M 57 in 1 Driver Kit



Fast turning swivel cap

Non-Slip TPR Handle



Quick release chuck

3 extension length adjustment

1/4" to 4.0mm adaptor

4mm & 1/4" bits set contains most type of bits you need

- **Adjustable 3-length extension bar**, up-to-115mm long, ideal for adjusting and accessing fasteners in narrow areas.
- **1/4" to 4.0mm adaptor**, easy to match most screwdriver bits for all repair requirements.
- **24 pcs 1/4" electrical bits**, for electronic and electrical field, suited for home, office, PC and bike and more.
- **30 pcs 4mm precision bits**, repair cell phones, game consoles, wearables, laptops, desktops, tablets, small appliances, and much more

Contents					
24pc Cr-V Ø1/4" bits			30pc Cr-V Ø4mm bits		
⊖	4.0-5.0-6.0-7.0mm	⊕	PH00, PH0, PH1, PH2	⊖	1.5, 2.0, 2.5, 3.0, 3.5, 4.0mm
⊕	PH0, PH1, PH2, PH2, PH3	⊖	1.5, 2.0, 2.5, 3.0, 3.5, 4.0mm	⊖	T4, T5, T6, T7, T8, T10, T15, T20
⊖	3.0-4.0-5.0-6.0mm	⊖	S1, S2	⊖	0.9, 1.3, 1.5, 2.0, 2.5, 3.0mm
⊕	PZ0, PZ1, PZ2, PZ3	⊖	2.6mm	⊖	1.0
⊖	T25, T27, T30, T40	⊖	3.0	⊖	3.0
100mm 1/4" Extension bar			⊖	2.6mm	⊖
1/4" to 4.0mm adaptor					

Individual packing: Blister card

SD-2317M 38PCS 1/4" Drive Socket & Screwdriver Set



**Durable
Convenient
Efficient**



- 1/4" drive ratchet handle with quick release design for socket change easily and efficiently
- Ergonomic, non-slip TPR+PP, high quality ratchet screwdriver handle provide optimum torque and user comfort
- Bits come with color ring for easy specification identification
- Ideal for carpenter, electrician, auto mechanic or home DIY repair and more

Contents					
12pcs 1/4" Drive socket: 5u plating					
⊖	4, 4.5, 5, 5.5, 6, 7, 8, 9, 10, 11, 12, 13mm				
20pcs 1/4" Bits:					
⊕	#1, #2, #3	⊖	H3.0, H4.0, H5.0, H6.0	⊕	PZ1, PZ2, PZ3
⊖	T10, T15, T20, T25, T30, T8	⊖	3.0, 4.0, 5.0, 6.0mm		
1/4" Universal Joint			Magnetic Bit Adaptor:60mm(L)		
1pc 1/4" Hex(male) to 1/4" socket(male) adaptor					
1/4" square drive(female) to 1/4" hex bit holder					
1/4" Drive Ratchet handle w/quick release			Ratchet Screwdriver Handle		
Plastic case 225x 125x50mm					

Individual packing: Color box

SD-2316M 26PCS 1/4" Drive Socket & Screwdriver Set

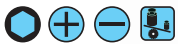

**Durable
Convenient
Efficient**



- Comes with 3-way ratchet screwdriver allowing 3 operating positions
- Ergonomic, non-slip handle with bits storage chamber for user convenience
- Additional 1/4" drive ratchet handle with quick release design for socket change easily and efficiently
- Ideal for carpenter, electrician, auto mechanic or home DIY repair and more

Contents					
10pcs 1/4" Drive socket: 4.5, 6, 7, 8, 9, 10, 11, 12, 13mm					
12pcs 1/4" Bits:					
⊖	3, 4, 5, 5, 6, 7mm	⊕	#0, #1X2pcs, #2X2pcs, #3		
1pc 1/4" Drive Ratchet handle w/quick release					
1pc 1/4" Hex(male) to 1/4" socket(male) adaptor					
1pc 3-way ratchet screwdriver handle			1pc 1/4" Drive extension bar		
Plastic case 225x125x50mm					

Individual packing: Color box

SD-083 Series ESD Precision Screwdriver



ESD-Safe for maximum protection of static sensitive components

Pro'sKit Precision ESD Safe Screwdrivers are tested in accordance with ESD Association standard; meet the requirements for tools used in static sensitive areas. Surface resistance of handles is $10^7 \sim 10^9 \Omega$

Rotating Cap for precise control and screw turning with fingertip.
 Square shape handle with rubberized non-slip grip for efficient work.
 Tapered handle allows rapid rotation.
 Blade made of strong chrome molybdenum vanadium steel.
 Black oxide tip, precision ground for exact fit.



Model No.		B	D	Model No.		B	D	Model No.		B	D
SD-083-A1	⊕	1.9	3.0	SD-083-S4	⊖	2.4	2.4	SD-083-T6H	T6H	3.0	
SD-083-A2	⊕	2.9	3.0	SD-083-S5	⊖	3.0	3.0	SD-083-T7H	T7H	3.0	
SD-083-H1.5	⊙	1.5	2.0	SD-083-P2	⊕	#00	2.0	SD-083-T8H	T8H	3.0	
SD-083-H2.0	⊙	2.0	2.4	SD-083-P3	⊕	#0	2.4	SD-083-T9H	T9H	3.0	
SD-083-H2.5	⊙	2.5	3.0	SD-083-P4	⊕	#1	3.0	SD-083-T10H	T10H	3.0	
SD-083-H3.0	⊙	3.0	4.0	SD-083-T4	⊙	T4	3.0	SD-083-T15H	T15H	4.0	
SD-083-S3	⊖	2.0	2.0	SD-083-T5H	⊙	T5H	3.0	SD-083-T20H	T20H	4.0	

Individual packing: Blister card

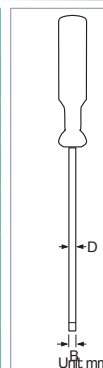

SD-0839 ESD Precision Screwdriver Set



- ESD Safe dissipative.
- Safety ergonomic soft handle.
- Exact fit machined tips.

Contents	
⊕	SD-083-P2, SD-083-P3, SD-083-P4
⊖	SD-083-S3, SD-083-S4, SD-083-S5,
⊙	SD-083-T4
⊙	SD-083-T5H, SD-083-T6H

Individual packing: Pouch

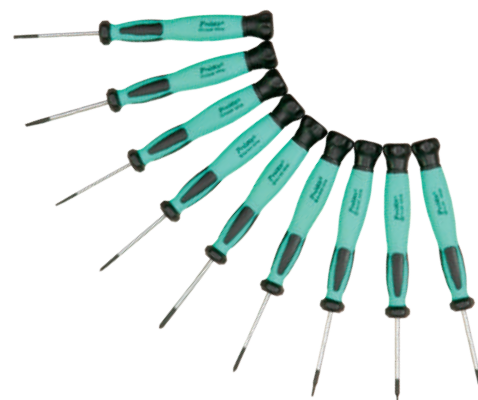

ALIGNMENT TOOL & SCREWDRIVERS

SD-081 Series Precision Screwdriver/Nut Driver

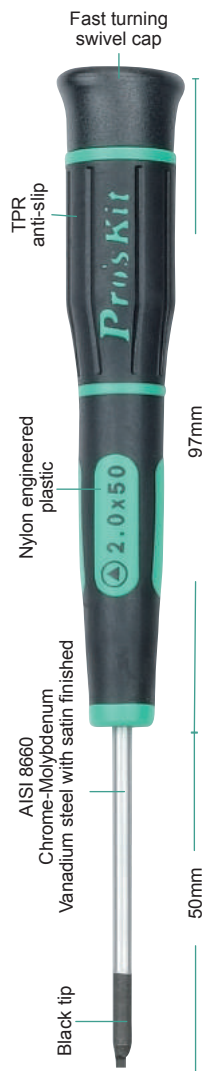

Model No.	Spec.	Working length	Model No.	Spec.	Working length	Model No.	Spec.	Working length			
SD-081-S1	⊖	1.0	50	SD-081-T1	⊗	T1	50	SD-081-H1	⊙	0.7	50
SD-081-S2	⊖	1.6	50	SD-081-T2	⊗	T2	50	SD-081-H2	⊙	0.9	50
SD-081-S3	⊖	2.0	50	SD-081-T3	⊗	T3	50	SD-081-H3	⊙	1.3	50
SD-081-S4	⊖	2.4	50	SD-081-T4	⊗	T4	50	SD-081-H4	⊙	1.5	50
SD-081-S5	⊖	3.0	50	SD-081-T5	⊗	T5	50	SD-081-H5	⊙	2.0	50
SD-081-S6	⊖	2.4	75	SD-081-T6	⊗	T6	50	SD-081-H6	⊙	2.5	50
SD-081-S7	⊖	3.0	100	SD-081-T7	⊗	T7	50	SD-081-H7	⊙	3.0	50
SD-081-S8	⊖	4.0	150	SD-081-T8	⊗	T8	50	SD-081-Z1	⊕	#000	50
SD-081-P1	⊕	#000	50	SD-081-T9	⊗	T9	50	SD-081-Z2	⊕	#00	50
SD-081-P2	⊕	#00	50	SD-081-T10	⊗	T10	50	SD-081-Z3	⊕	#0	50
SD-081-P3	⊕	#0	50	SD-081-T15	⊗	T15	50	SD-081-Z4	⊕	#1	50
SD-081-P4	⊕	#1	50	SD-081-T20	⊗	T20	50	SD-081-M3	⊙	M3.0	72
SD-081-P5	⊕	#0	75	SD-081-T5H	⊗	T5H	50	SD-081-M3.5	⊙	M3.5	72
SD-081-P6	⊕	#1	100	SD-081-T6H	⊗	T6H	50	SD-081-M4	⊙	M4.0	72
SD-081-P7	⊕	#1	150	SD-081-T7H	⊗	T7H	50	SD-081-M4.5	⊙	M4.5	72
SD-081-TA20	⬆	2.0	50	SD-081-T8H	⊗	T8H	50	SD-081-M5	⊙	M5.0	72
SD-081-TA23	⬆	2.3	50	SD-081-T9H	⊗	T9H	50	SD-081-M5.5	⊙	M5.5	72
SD-081-TA27	⬆	2.7	50	SD-081-T10H	⊗	T10H	50	SD-081-M6	⊙	M6.0	72
SD-081-TRI000	⬆	#000	50	SD-081-T15H	⊗	T15H	50				
SD-081-TRI00	⬆	#00	50	SD-081-T20H	⊗	T20H	50				
SD-081-TRI0	⬆	#0	50	SD-081-A1	⊛	A1	50				
SD-081-TRI1	⬆	#1	50	SD-081-A2	⊛	A2	50				

Individual packing: Blister card

SD-081-TS1/ SD-081-PL5/ SD-081-PL6/SD-0810-TRIY06 Precision Screwdrivers for Apple Series

Especially designed for Apple products



Pentalobe tips
for Apple products



Model No.	Spec.	Working length
SD-081-TS1	⊛	TS1 50mm
SD-081-PL5	⊛	P5 50mm
SD-081-PL6	⊛	P6 50mm

Individual packing: Blister card

Tri-Point tips
for iPhone7, iPhone watch



Model No.	Spec.	Working length
SD-081-TRIY06	⊙	TRIY06 50mm

Individual packing: Blister card

SD-081F 3PCS Triangle Precision Screwdriver Set



Contents
 SD-081-TA20,
 SD-081-TA23,
 SD-081-TA27

Individual packing: Blister card



SD-081G 4PCS TRI-wing Precision Screwdriver Set



Contents
 SD-081-TRI000,
 SD-081-TRI00,
 SD-081-TRI0,
 SD-081-TRI1

Individual packing: Blister card



SD-081A 7 PCS Electronic Set



Contents
 AISI 8660 Cr-Mo-V alloy steel with TPR handle screwdriver x 7pcs (OAL:147mm)

⊖ 1.6x50, 2.0x50, 2.4x50, 3.0x50
⊕ #00x50, #0x50, #1x50

Carrying case: 170x139x23mm

Individual packing: Plastic box + Color box

SD-081B 14 In 1 Reversible Screwdriver Set

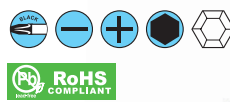

Contents
 TPR non-slip handle: 112mm
 7pcs hex ø4 x 120mm, Material: AISI 8660 Cr-Mo-V steel

⊖2.0 - ⊕#00	⊖4.0 - ⊕#1	⊕#1 - ⊕#0	⊕#0 - ⊖3.0
⊖1.5 - ⊖3.0	⊙H2.5 - ⊖2.5	⊙H2 - ⊖2	

Carrying case: 170x139x23mm

Individual packing: Plastic box + Color box



SD-9803 33 PCS Screwdriver Set w/Bits



Contents
 TPR non-slip handle with bits holder
 30pcs hex ø4 x 28mm, Material: AISI 8660 Cr-Mo-V steel

⊕ PH000, PH00, PH0, PH1
⊖ SL1.0, SL1.5, SL2.0, SL2.5, SL3.0, SL3.5, SL4.0
⊙ T4, T5, T6, T7, T8, T9, T10, T15, T20
⊙ H0.7, H0.9, H1.3, H1.5, H2.0, H2.5, H3.0, H4.0
⊕ PZ1, PZ0

2 pcs ø4mm socket, material: AISI 6150 Cr-V steel
 Ⓞ Socket: M5, M6

Carrying case: 170x139x23mm

Individual packing: Plastic box + Color Label



SD-081E 12 IN 1 Precision Screwdriver Set w/Bit



Contents
 TPR non-slip handle with bits holder
 12pcs hex ø4 x 28mm, Material: AISI 8660 Cr-Mo-V steel

⊖ SL2.0, 2.5, 3.0, 4.0	⊕ #000, #00, #0, #1	⊙ T6, T7, T8, T9
------------------------	---------------------	------------------

Carrying case: 134x65x25mm

Individual packing: Plastic box + Shrink

ALIGNMENT TOOL & SCREWDRIVERS

SD-086 Series Precision Screwdriver

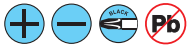

SD-086 Series contains useful Phillips and Slotted tips to satisfy electronic and electrical applications.

- With fast turning swivel cap for better control and quick fastening.
- Precision blade is made of high quality chrome vanadium steel ensures perfect fit every time.
- Ergonomic TPR and PP non-slip handle for easy operation.

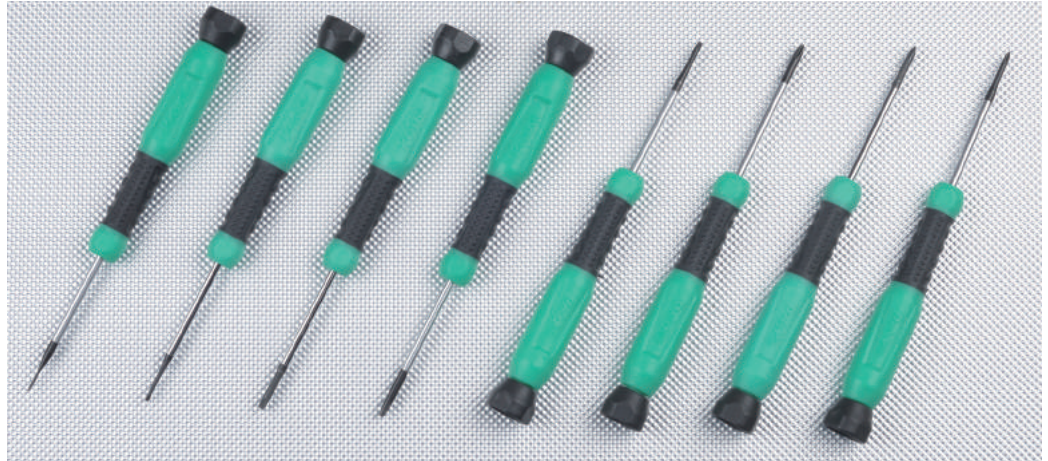

Model No.	Spec.	Working length
SD-086-P1	⊕ #000	50
SD-086-P2	⊕ #00	50
SD-086-P3	⊕ #0	50
SD-086-P4	⊕ #1	50
SD-086-P5	⊕ #0	75
SD-086-P6	⊕ #1	100
SD-086-P7	⊕ #1	150

Model No.	Spec.	Working length
SD-086-S1	⊖ 1.0	50
SD-086-S2	⊖ 1.6	50
SD-086-S3	⊖ 2.0	50
SD-086-S4	⊖ 2.4	50
SD-086-S5	⊖ 3.0	50
SD-086-S6	⊖ 2.4	75
SD-086-S7	⊖ 3.0	100

Individual packing: Blister card

SD-9824 24-IN-1 Screwdriver Set

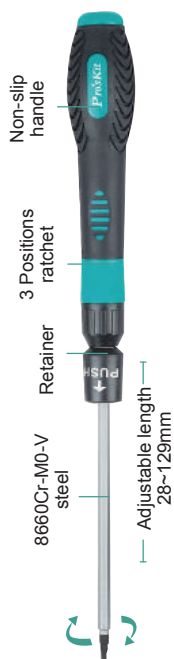

Contents	
3 position ratchet handle: 130mm	
12pcs double end hex bits: ø4 x 160mm	
⊕ PZ1	⊕ PZ0
⊕ H2.5	⊕ H4.0
⊕ H3.0	⊕ H3.5
⊕ H1.5	⊕ H3.0
⊕ #1	⊕ #00
⊕ #0	⊕ #000
Carrying case :192x130x26mm	

Individual packing: Plastic box + Color box

SD-9312 14 PCS Ratchet Precision Screwdriver Set



Contents	
3 position ratchet handle: 135mm	
10pcs hex bits: ø4 x 28mm, Material: AISI 8660 Cr-Mo-V steel	
⊕ #00, #0, #1	⊖ 1.0, 1.5, 2.5
⊕ T5, T6, T7, T8	
2Pcs socket: ø4x32mm, Material: AISI 6150 Cr-V steel	
⊕ 4.0, 5.0	
Extension blade: 120mm	
Carrying case : 137x104x26mm	

Individual packing: Color sleeve

SD-9316 23 IN 1 High Performance Screwdriver Set



• Ideal for mobile phone, PDA, PC & other applications.



Contents			
H2/H3/H4/H5	PH1/PH0/PH00	4mm	
T15H/T20H/T25H	1.5/2.0/2.5		
6/8/10	T4/T5/T6/T7		
Extension bars: 4mm x 70mm, 1/4" x 70mm			
1pc Anodized aluminum alloy handle			
Carrying case: 130x86x29mm			

Individual packing: Blister card



SD-9315 22 IN 1 Precision Screwdriver Set



• Ideal for mobile phone, PDA, PC & other applications.

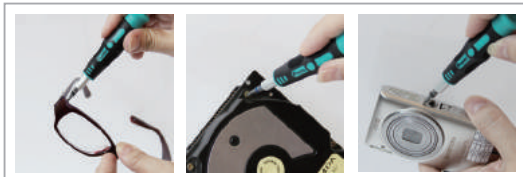

Contents			
2.5/3.0/3.5/4.0/4.5/5	PH1/PH0/PH00/PH000	4mm	
1.0/1.5/2.0/2.5 /3.0	T4/T5/T6/T7/T8		
Extension bar: 4mm x 70mm			
1pc Dual color PP+TPR handle			
Carrying case: 130x86x29mm			

Individual packing: Blister card

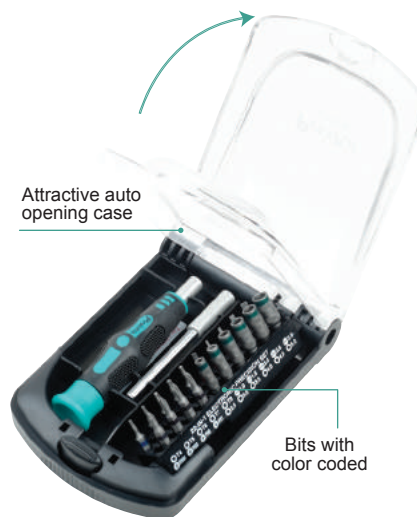

SD-9812 12-In-1 Reversible Ratchet Precision Screwdriver Set



Ratchet action with 3 positions: forward, reverse and lock

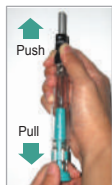

Contents			
3 position ratchet handle with bits holder : 155~205mm			
6pcs double end bits: ø4 x 30mm, Material: AISI 8660 Cr-Mo-V steel			
T4	T8		
T6	T10		
T7	T15		
1.5	#000		
2.0	#00		
2.5	#0		

Individual packing: Blister card

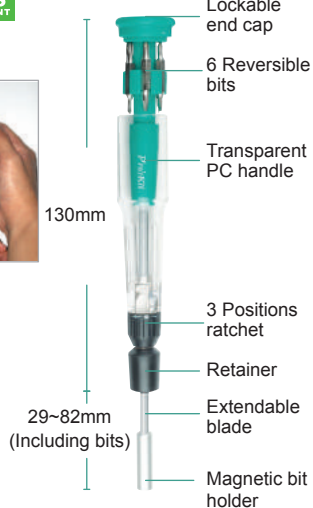

SD-9814 9 IN 1 Aluminum Handle Precision Screwdriver Set



Contents	
Anodized aluminum alloy steel handle: 110mm	
9pcs hex bits: ø4 x 28mm, Material: AISI 6150 Cr-V steel	
#000, #00, #0, #1	
2.0, 3.0mm	
T4, T5, T6	

Individual packing: Blister card



Comes with 9 Chrome Vanadium driver bits

SD-9802 31 IN 1 Precision Electronic Screwdriver Set



- Smooth rotating cap for quick and easy screw/unscrew without lifting from screw
- Keyless chuck for easy adjustment of bits holder extension bar
- Adjustable bit holder design for easy work inside narrow or hard to reach places
- A versatile set for driving and retrieving very small screws

Contents	
TPR non-slip handle: 115mm	
Extension bar :110mm	
30pcs hex bits:ø4 x 28mm, Material: S2 steel	
⊕ #00, #0, #1, #2	● 0.9, 1.3, 1.5, 2.0, 2.5, 3.0,4.0mm
⊕ T4, T5, T6, T7, T8, T10, T15,T20	★ 2mm , Pin 1.0mm
⊖ 1.5, 2, 2.5, 3, 3.5, 4mm	Extension bar: 110mm
⊕ 3mm, ⊖ 2.6mm, ⊕ 3mm	TPR non-slip handle:115mm
Carrying case: 212 x 142 x 30mm	
Individual packing: Double blister	

SD-9804 15 IN 1 Precision Electronic Screwdriver Set

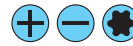

- Ergonomic designs with non-slip and dual color TPR handle for operation comfort.
- 14pcs interchangeable precision bits made of high quality chrome vanadium steel.
- with extension bar design, ideal for accessing fasteners in tight areas.



Contents	
TPR non-slip handle: 110mm	
Extension bar:110mm	
14pcs hex bits:ø4 x 28mm, Material: AISI 6150 Cr-V steel	
⊕ #000, #00, #0, #1	⊖ 1.5, 2.0, 2.5, 3.0, 4.0mm
● T5, T6, T7, T8, T9	
Carrying case: 147x95x24mm	
Individual packing: Blister card	

SD-9608 30 pcs Aluminum Handle Precision Screwdriver Set



- Aluminum handle with rubber grip provides user comfort
- Linkage structure of bits tray for easy bits change and storage
- Covering most common use bits in a compact box

Contents		4 mm
⊕ PH000,PH00,PH0,PH1	⊖ 1.0,1.2,1.5,1.8	
⊕ PZ000,PZ00,PZ0,PZ1	● 0.7,0.9,1.3,1.5,2.0	
⊕ T4,T5,T6,T7	⊕ P2	
⊕ 2.0mm	⊖ 2.6	
S0, Needle Type bits 1.0mm		
Extension bar : 4mm x 70mm		
Aluminum alloy handle		
Carrying case : 148x74x28mm		
Individual packing: Color box		

SD-9302 Miniature Electronic Screwdriver Set



- Slender handle molded to blade and a finger tip swivel top for better control and quick fastening
- Material (Blade): AISI 8660 Cr-Mo-V alloy steel

Contents		159
⊖ 1.6x65, 2.4x65, 2.0x65		
⊕ #0x65, #00x65, #000x65, #1x65		
⊕ T5x65, T6x65		
Carrying case:195x184x28mm		
Individual packing: Shrink		

SW-0118 15 PCS Precision Screwdriver Set



Contents	
⊖	1.0x40, 2.0x40, 3.0x40, 3.5x40
⊕	#000x40, #00x40, #0x40
⊖	1.5x40, 2.0x40, 2.5x40, 3.0x40
⊖	T6x40, T8x40, T10x40, T15x40
Carrying case: 262x183x43mm	



Individual packing: Plastic box + Color label

SD-9829M 18 In 1 Precision Screwdriver Set

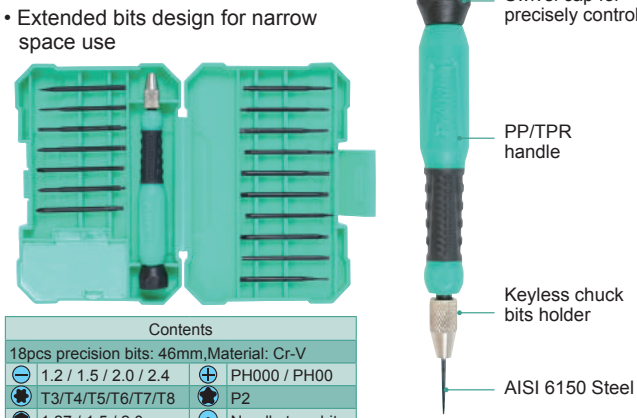

Contents	
18pcs precision bits: 46mm, Material: Cr-V	
⊖	1.2 / 1.5 / 2.0 / 2.4
⊕	PH000 / PH00
⊖	T3/T4/T5/T6/T7/T8
⊖	1.27 / 1.5 / 2.0mm
⊖	Needle type bits
Carrying case: 125.5 x 86 x 25mm	

Individual packing: Blister card

SD-9815 Precision Screwdriver Set

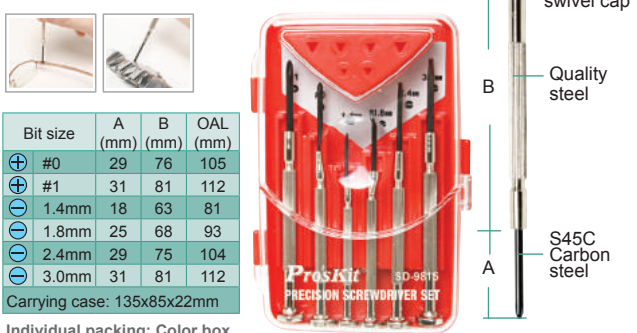

Bit size	A (mm)	B (mm)	OAL (mm)
⊕ #0	29	76	105
⊕ #1	31	81	112
⊖ 1.4mm	18	63	81
⊖ 1.8mm	25	68	93
⊖ 2.4mm	29	75	104
⊖ 3.0mm	31	81	112

Carrying case: 135x85x22mm

Individual packing: Color box

SD-9819 Precision Screwdriver Set

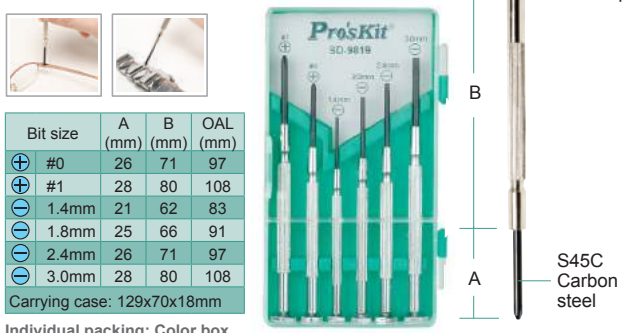

Bit size	A (mm)	B (mm)	OAL (mm)
⊕ #0	26	71	97
⊕ #1	28	80	108
⊖ 1.4mm	21	62	83
⊖ 1.8mm	25	66	91
⊖ 2.4mm	26	71	97
⊖ 3.0mm	28	80	108

Carrying case: 129x70x18mm

Individual packing: Color box

SD-9811 18-IN-1 Precision Screwdriver Set

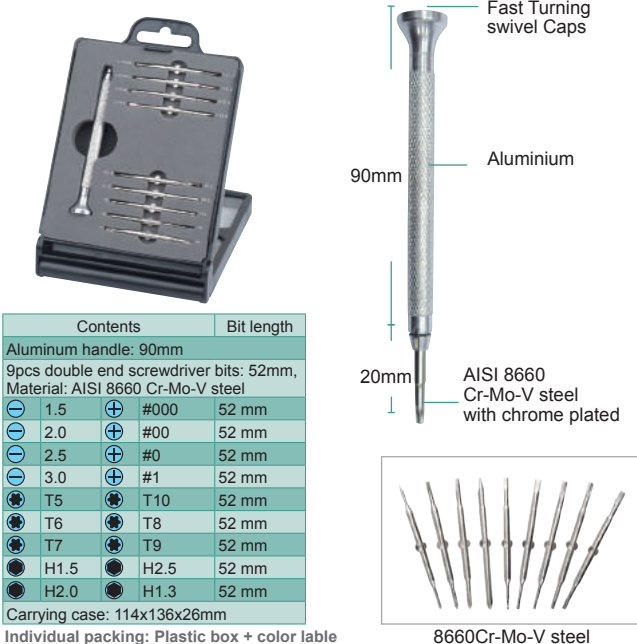

Contents		Bit length
Aluminum handle: 90mm		
9pcs double end screwdriver bits: 52mm, Material: AISI 8660 Cr-Mo-V steel		
⊖ 1.5	⊕ #000	52 mm
⊖ 2.0	⊕ #00	52 mm
⊖ 2.5	⊕ #0	52 mm
⊖ 3.0	⊕ #1	52 mm
⊖ T5	⊖ T10	52 mm
⊖ T6	⊖ T8	52 mm
⊖ T7	⊖ T9	52 mm
⊖ H1.5	⊖ H2.5	52 mm
⊖ H2.0	⊖ H1.3	52 mm

Carrying case: 114x136x26mm

Individual packing: Plastic box + color label



SD-9808N 58-piece Precision Electronic Screwdriver Set

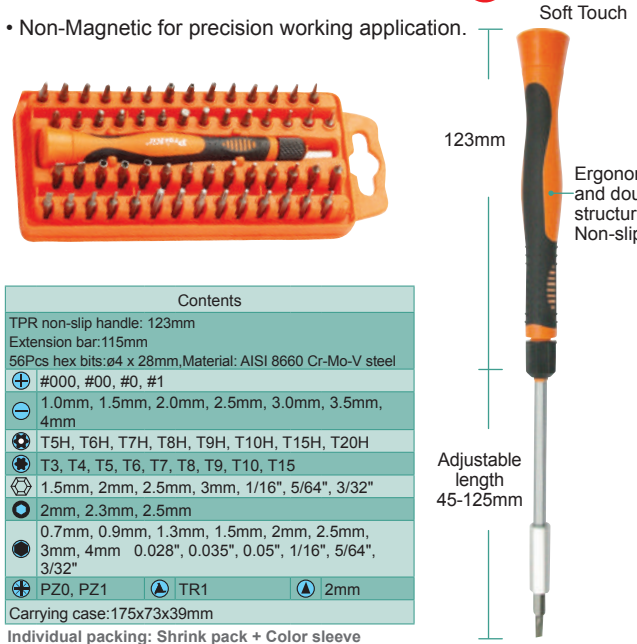

Contents	
TPR non-slip handle: 123mm	
Extension bar: 115mm	
56Pcs hex bits: $\phi 4 \times 28$ mm, Material: AISI 8660 Cr-Mo-V steel	
⊕	#000, #00, #0, #1
⊖	1.0mm, 1.5mm, 2.0mm, 2.5mm, 3.0mm, 3.5mm, 4mm
⊖	T5H, T6H, T7H, T8H, T9H, T10H, T15H, T20H
⊖	T3, T4, T5, T6, T7, T8, T9, T10, T15
⊖	1.5mm, 2mm, 2.5mm, 3mm, 1/16", 5/64", 3/32"
⊖	2mm, 2.3mm, 2.5mm
⊖	0.7mm, 0.9mm, 1.3mm, 1.5mm, 2mm, 2.5mm, 3mm, 4mm 0.028", 0.035", 0.05", 1/16", 5/64", 3/32"
⊕	PZ0, PZ1
⊖	TR1
⊖	2mm

Carrying case: 175x73x39mm

Individual packing: Shrink pack + Color sleeve

ALIGNMENT TOOL & SCREWDRIVERS

SD-3502 6 PCS Star Screwdriver Set



Contents		Blade length
	T4	20 mm
	T5H, T6H, T7H, T8H, T9H	20 mm

Carrying case: 121x93x18mm
Individual packing: Plastic box+Color box

8PK-2061 6 PCS Electronic Screwdriver Set



Contents		Blade length
	#00, #0, #1	20 mm
	1.4, 1.8, 2.4	20 mm

Carrying case: 121x93x18mm
Individual packing: Plastic box+Color box

8PK-2062 6 PCS Electronic Screwdriver Set



Contents		Blade length
	1.4, 1.6, 1.8, 2.0, 2.4, 3.0	20 mm

Carrying case: 121x93x18mm
Individual packing: Plastic box+Color box

8PK-2063 5 PCS Electronic Screwdriver Set



Contents		Blade length
	#0-4, #0-3, #00, #0, #1	20 mm

Carrying case: 121x93x18mm
Individual packing: Plastic box+Color box

8PK-5141N 7 PCS Electronic Screwdriver Set



• Material: Blade: AISI 6150 Cr-V steel

Contents		Bit length
6pcs Screwdrivers		
	#1	150 mm
	#0	100 mm
	#0 (Ø 2)	75 mm
	2.4	75 mm
	3.0	100 mm
	4.0	150 mm

1PK-501A Stainless micro cutting plier

Carrying case: 325x128x21mm

Individual packing: Plastic box + Color label

8PK-509 6 PCS Precision Screwdriver Set



- A 6 piece screwdriver set with 3 flat blades and 3 philips screwdrivers.
- The screwdrivers have long shafts and are ideal for reaching recessed screws in electronic equipment.
- Handles are made from molded plastic and incorporate finger grips.
- Shafts are made from AISI 6150 Cr-V steel

Contents		Bit length
	#0 (Ø 2.4)	75 mm
	#1 (Ø 3.0)	100 mm
	#1 (Ø 3.8)	150mm
	2.4	75mm
	3.0	100mm
	3.8	150mm

Individual packing: Blister card

8PK-SD002N 8 PCS Screwdriver Set

High Torque



- Especially designed for both service and production use.

Contents		Blade length
	#0, #00, #1	60 mm
	2.0, 2.5, 3.0, 3.5, 4.0	60 mm

OAL: 163mm
Individual packing: Plastic box + Color box

SD-803 4-In-1 Screwdriver Set



- Two double-ended, reversible tips
- Material: Blade: AISI 6150 Cr-V steel
- HRC: 52°±3°
- Handle: ABS

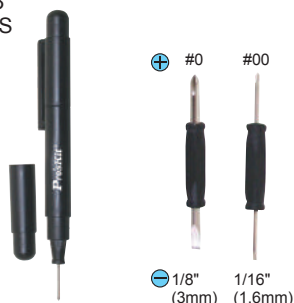

Offered in 50pcs display pack

Contents		O.A.L (mm)
⊖ 1/16", 1/8"	⊕ #00, #0	131
Display box: 213x123x144mm		
Individual packing: Display box		

SD-804 5-In-1 Screwdriver Set



- Two double-ended, reversible tips
- Material: Blade: AISI 6150 Cr-V steel
- HRC: 52°±3°
- Handle: ABS



Offered in 50pcs display pack

Contents		O.A.L (mm)
⊖ 1/16", 1/8"	⊕ #00, #0	135
Display box: 213x123x144mm		
Individual packing: Display box		



LED light

1PK-034 Series Ceramic Driver



- No electromagnetic induction
- No eddy current loss in high frequency (HF)
- Electrically and thermally insulated
- Non-magnetic • Non-static
- Resistant to acid. (except hydrofluoric)



Handle: ABS

Bit: Zirconia

1PK-034NA	⊖ 0.4x0.9mm	1PK-034NE	⊖ 0.4x2.4mm
1PK-034NB	⊖ 0.4x1.2mm	1PK-034NF	⊖ 0.7x2.4mm
1PK-034NC	⊖ 0.4x1.8mm	1PK-034NG	⊕ PH0
1PK-034ND	⊖ 0.4x2.0mm	1PK-034NH	⊕ PH1.7

Individual packing: Display blister

908-607 908-607S Alignment Tool



Ideal for handyman and TV technicians, this plastic screwdriver has a steel spring tip. Suitable for trimmers.



Stainless

Model No.	Material	Blade diameter	Length
908-607S	Tip: Stainless Body: K-glass Handle: PE	⊖ 2.0	150
908-607		⊖ 2.0	200

Individual packing: Bulk

1PK-A001 10 PCS Trimming Tool Set



A set of 10 trimming tools with moulded plastic tips, including slotted, hexagonal and square types.



Material	Spec.	OAL.(mm)
PC	As sketch	115

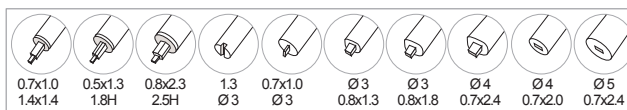

Individual packing: Blister card

1PK-606A 3 PCS Anti-Static Alignment Tool Kit



- For protection of sensitive components
- Duplex, trimmer and square/hex tool
- Conductive nylon-avoid high voltage

Conductive handle resistivity: 10⁶~10⁹



Material	Spec.
Conductive nylon	As sketch

Individual packing: Blister card



3C Product Repair Tools

A “Real Friend” always know what you need

Nowadays, almost everyone cannot live without consumer electronics (3C) products, for which the integrated electronics are making it harder to fix things. Manufacturers of those electronic products keep restricting access to service documentation, parts, and software—which forces consumers into more expensive ‘manufacturer-authorized’ repairs or even purchase new ones alternatively. However, it is unreasonable to turn the consumer products into “often-consumable” products. Being a leading tool brand as **Pro’sKit**® as well as a friend of all **Pro’sKit**® fans, we decide to offer a fair shake: access and solution for basic maintenances.

A “Real Solution Provider” makes nothing impossible

There are many brands of consumer electronics in the market, and “Apple” is the most popular brand among them. However, Apple’s products are notoriously difficult to open and repair. Apple parts and accessories are different from general ones – they are bizarre, and they even looks different between different Apple series. Here, according to **Pro’sKit**® Apple Repair Series, is what’s going down.

Pro’sKit® develops the special screwdrivers and bits to tackle the hard tasks and make Apple repairs possible.



1PK-3179 5 PCS Spudger/Prying Tool Assortment



- Ideal for most brands of smart phones, video games, notebooks, electronic devices.
- Opening and prying disconnecting small electronic components without damaging housing or parts.



Contents
1 pce Double-ended metal spudger OAL:185mm
1 pce Nylon aid tool, OAL:150mm
2 pcs Polyoxymethylene (POM) opening levers, OAL:84.4mm, 88.7mm
1 pce Prying paddle, 30.5x30.5x30.5mm
Individual packing :Blister card

SD-9314 17 IN 1 Tool Kit For Apple Products



Contents
Dual color precision screwdriver handle: 110mm
12pcs 4mm precision screwdriver bits: ø4x28mm,material: AISI 8660 Cr-Mo-V steel
⊕P2, ⊕PH000, ⊖1.5mm, ⊕T4, T5, T6, T8, T10, T15, T20 ⊕H2.0mm, H1.5mm
Needle type bits for iPhone / iPad SIM card tray ejection
Polyoxymethylene (POM) opening lever x 2 OAL: 84.4mm, 88.7mm
Suction cup Ø36mm
Prying paddle 30.5mm x 30.5mm x 30.5mm
Individual packing: Plastic box + Sleeves + Shrink



Carrying case :135x94x30mm

SD-9806 9 PCS Cellular Phone Maintenance Kit



Contents
9pcs screwdrivers: 146mm, Material: AISI 8660 Cr-Mo-V steel
⊕T4
⊕T5H, T6H, T7H, T8H
⊕1.9, 2.9
⊕#00
⊕TR11
Carrying case:205x126x34mm
Individual packing: Shrink

MS-3176 4 PCS Open Repair Tool Set



- Ideal for most brands of smart phones, video games, notebooks, electronic devices.
- Opening and prying disconnecting small electronic components without damaging housing or parts.



Contents
Metal spudger tool (123 mm)
Point-blade solder aid tools (155 mm)
Spudger solder aid tools (140 mm)
Fork-blade solder aid tools (173 mm)
Individual packing :Blister card

PK-9110 6 PCS iPhone Series Disassemble Set



Contents
⊕P2X40mm : OAL91.5mm
⊕#00X40mm : OAL91.5mm
Polyoxymethylene (POM) opening lever x 2 OAL: 84.4mm, 88.7mm
Suction cup Ø36mm
Prying paddle 30.5mm x 30.5mm x 30.5mm
Individual packing: Blister card

8PK-2065 7 PCS Cellular Phone Opener Set



Contents
7pcs screwdrivers: 140mm, Material: AISI 8660 Cr-Mo-V steel
⊕#0, ⊕T5, T6, T7,
Back panel opener
Folding cover opener
⊖ Security screwdriver
Carrying case:170x132x21mm
Individual packing: Plastic box+Color box

ALIGNMENT TOOL & SCREWDRIVERS

SD-9828 58 PCS Driver Kit



Fast turning swivel cap
Non-slip handle
Adjustable length 45~130mm
AISI8660

P2 / P5 / P6 pentalobe tips are special for Apple products.
TS3.8 / TS4.5 Torx plus® are special for Nintendo, SEGA products.

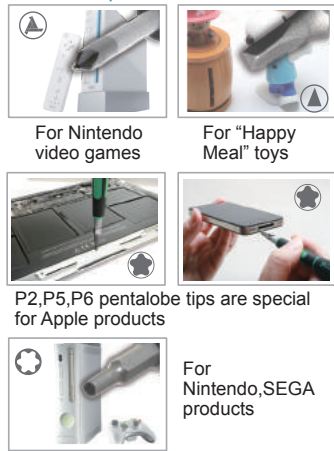

Ideal for smartphone opening of tablets, notebooks, electronic device cases and most branded video games such as Apple, HTC, Samsung, LG, Nokia, Sony, Sega, Microsoft, Nintendo and more.

Contents	
42 pcs Ø4.0×28 mm, material : AISI 8660 Cr-Mo-V steel	
⊕ #000, #00, #0, #1, #2	⊖ #0, #1, #2
⊖ 1.0, 1.3, 1.5, 2.0, 2.5, 3.0, 3.5, 4.0 mm	⊕ T3, T4
⊕ 5H, T6H, T7H, T8H, T9H, T10H, T15H, T20H	
⊕ 0.7, 0.9, 1.3, 1.5, 2.0, 2.5, 3.0, 3.5, 4.0 mm	
⊕ #0, #1	⊖ 3.0 mm
⊕ 3.0 mm	⊕ 3.0 mm
Pentalobe	⊕ P2, P5, P6 (iPhone, MacBook Air, MacBook Pro)
6 pcs Ø4.0×30 mm, material : 50BV30 Cr-V steel	
⊕ 2.5, 3.0, 3.5, 4.0, 4.5, 5.0 mm	
5 pcs Ø1/4"(6.3)×25 mm, material : AISI 6150 Cr-V steel	
⊕ #2	⊖ 6.0 mm
⊖ 6.0 mm	⊕ 4.5, 5.0, 6.0 mm
2 pcs Ø1/4"(6.3)×38mm, material : AISI 6150 Cr-V steel	
Torx plus® socket	
⊕ TS3.8, TS4.5	
1 pc Ø4.0mm to Ø1/4" adaptor 50 mm	
1 pc Ø4.0×125 mm extension bar	
1 pc TPR non-slip handle	
Individual packing : Plastic box+color sleeve	

SD-9326M Consumer Electronic Equipment Repair Kit

P2 / P5 / P6 pentalobe tips are special for Apple products.

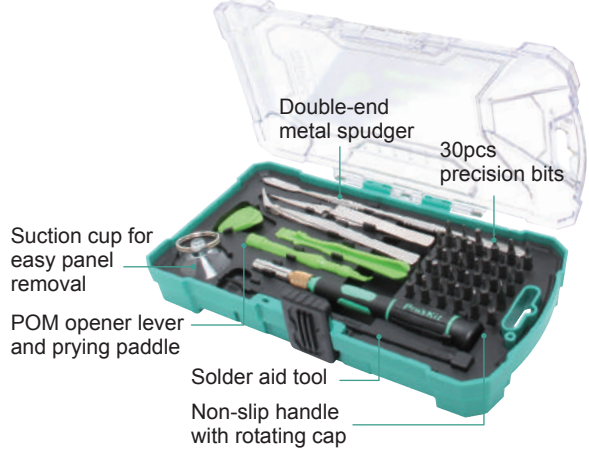

Double-end metal spudger
30pcs precision bits
Suction cup for easy panel removal
POM opener lever and prying paddle
Solder aid tool
Non-slip handle with rotating cap



- Allows opening the most of branded smart phone, video game, notebook, electronic devices and more.
- Including P2, P5, P6 pentalobe bits for Apple products
- Features 30pcs selected bits and 10 pcs essential repair tools are available in an elegant and durable carrying case

Contents	
Non-slip handle with rotating cap	
⊕ P2, P5, P6, #000, #00, #0, #1	
⊖ 2.0mm, 2.5mm, 3.0mm, 4.0mm, 4.0mm, H0.7mm, H1.5mm, H2.0mm, H3.0mm	
⊕ PZ1, PZ0	
⊖ Spanner 2.6	
⊕ T4, T5, T6, T8, T10, T15, T20	
⊕ TA2.0	
⊕ TRI00, TRI01, TRI1	
1 pce double-ended metal spudger OAL:185mm	
1 pce nylon aid tools, OAL:150mm	
2 pcs polyoxymethylene (POM) opening levers, OAL:84.4mm, 88.7mm	
1 pce prying paddle, 30.5x30.5x30.5mm	
Suction cup OAL:36mm	
Plastic case:135x94x30mm	
Individual packing: Plastic box+color sleeve	

SD-9313 30 In 1 Video Game Screwdriver Set

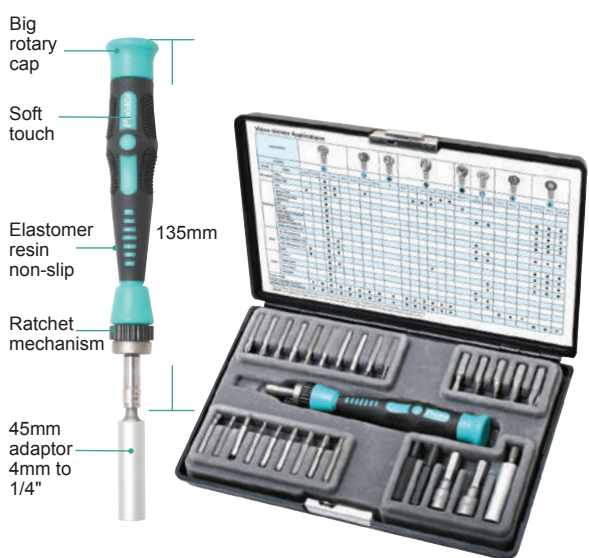

Big rotary cap
Soft touch
Elastomer resin non-slip
Ratchet mechanism
45mm adaptor 4mm to 1/4"



Essential for Wii, SNES, Nintendo handhelds video games
Work on most of "Happy Meal" toys
Perfectly fit for Nintendo, Sony, Sega video games



A complete kit allows opening the most of branded video game systems and happy meal toys without any damage such as Nintendo, Sony, Sega handhelds, video games and more.

Contents	
19pcs hex bits: ø4 x 28mm, Material: AISI 8660 Cr-Mo-V steel	
⊕ #000, #00, #0	⊖ 2.0, 3.0, 5.0mm
⊕ T5H, T6H, T8H, T10H, T15H, T20H	
⊕ T4	⊕ H0.7
⊕ TRI 1, TRI 0, TRI 00	
⊕ 1.7, 2.0, 2.3mm	
5pcs hex bits: ø1/4" x 25mm, Material: SAE 6150 Cr-V steel	
⊖ 4.0, 5.0, 6.0mm	
⊕ #1, #2	
4pcs Nut & Torx plus socket, Material: SAE 6150 Cr-V steel	
⊕ TS3.8, TS4.5(L:38mm)	
⊕ 6mm, 8mm (L:36mm)	
3 position ratchet handle: 135mm	
ø4mm to ø1/4" adaptor: 45mm	
Extension bar: 115mm	
Carrying case : 205x126x34mm	
Individual packing: Color box	

ALIGNMENT TOOL & SCREWDRIVERS

**PK-9116**

Apple Repair Technician Tool Kits

Designated kit by Apple repair center in Taiwan

Tackle all Apple products- From iPhone3 to iPhone7 as well as other Apple series. No screw is special anymore!

Contents	
SD-081-P1	⊕ Precision screwdriver (No.000 x 50mm)
SD-081-P2	⊕ Precision screwdriver (No.00 x 50mm)
SD-081-P4	⊕ Precision screwdriver (No.1 x 50mm)
SD-081-S2	⊖ Precision screwdriver (1.6 x 50mm)
SD-081-S3	⊖ Precision screwdriver (2.0 x 50mm)
SD-081-T5H	⊕ Precision screwdriver for star type w/ temper proof T5H
SD-081-T6H	⊕ Precision screwdriver for star type w/ temper proof T6H
SD-081-T8H	⊕ Precision screwdriver for star type w/ temper proof T8H
SD-081-T10	⊕ Precision screwdriver for star type w/o temper proof T10
SD-081-T20	⊕ Precision screwdriver for star type w/o temper proof T20
SD-081-TS1	⊕ Precision screwdriver TS1x50mm
SD-081-PL5	⊕ Precision screwdriver (PL5 x 50mm)
SD-081-PL6	⊕ Precision screwdriver (PL6 x 50mm)
SD-081-TRIY06	⊕ Precision screwdriver for Tri-point 0.6mm Y type (iPhone 7 / Apple Watch)
1PK-101T	Insulated tweezer (120mm)
1PK-102T	Super fine tip straight tweezer (120mm)
1PK-104T	Fine tip curved tweezer (120mm)
8PK-611W	Replaceable cordless wrist strap
AS-501A	Long handle static brush (40mm)
MS-153C	Ø56mm bulb blower w/brush
8PK-394A	Precision knife (small)
9PK-9110A	Prying paddle 30.5x30.5x30.5mm
9PK-9110B	Open lever(POM)
9PK-9110C	Open lever(POM)
9PK-9110D	Suction cup
9MS-9327	Metal spudger tool
9H085	Squdger solder aid tools(140mm)
MS-161	Heavy-duty suction cup
9ST-23	Tool bag(340x222.5x60mm)

- Bag size: 340x222.5x60 (mm)
- Individual packing: inner box & color label shrink

**PK-9112**

RepairPro Tool Kit

Ideal for opening, refurbishing, repairing smart phone, PAD, notebook, camera and video games

A complete, comprehensive kit includes the essential tools for 3C repair and refurbish market. It allows opening of tablets, notebooks, electronic device cases and most branded video games such as Apple, HTC, Samsung, Sony, Microsoft, Nintendo, Sega and more.

Contents	
9PK-9110A	Prying paddle 30.5x30.5x30.5 mm
9PK-9110B	Open lever (POM) 88.7mm
9PK-9110C	Open lever (POM) 84.4 mm
9PK-9110D	Suction cup Ø36 mm
9H084	Point-blade solder aid tools (155 mm)
9H085	Squdger solder aid tools (140 mm)
9H086	Fork-blade solder aid tools (173 mm)
9MS-9326	Double-end metal spudger (185mm)
9MS-9327	Metal spudger tool (123x12mm)
TZ-202N	Ergo-grip tweezers (super fine tip straight) 120.5 mm
TZ-204N	Ergo-grip tweezers (fine tip curved)120.5 mm
TZ-225N	Ergo-grip tweezers (super fine tip straight) 120.5 mm
9R006	Steel ruler 6"
8PK-394B	Precision knife
AS-611	Wrist strap 10ft
SD-9828	58Pcs Driver kits
9ST-33	Tool bag (255x180x50 mm)

- Bag size: 255x180x50 (mm)
- Individual packing: inner box & color label shrink



The **P2 / P5 / P6** pentalobe tips are special for Apple products.

The **TS3.8/TS4.5** Torx Plus® sockets are for Nintendo, SONY, SEGA.

Reinforced nylon spudger is designed for prying, poking, scraping, routing, flipping, detaching, attaching and opening devices.

HEX KEY WRENCHES



Pro'sKit® provides a one-stop shopping experience for the handyman and his or her hex key wrench needs.



Pro'sKit®

886-2-22183233
Sales support

pk@mail.prokits.com.tw
E-mail

www.prokits.com.tw
Global website

▶ 8PK-021N/8PK-021NA 7 PCS Folding Hex Key Set



Model No	Contents	
8PK-021N	● 1.5, 2, 2.5, 3, 4, 5, 6mm (Metric size)	
8PK-021NA	● 1/16", 5/64", 3/32", 1/8", 5/32", 3/16", 1/4" (Inch size)	
Key material	Case	Individual packing
SAE6150 with satin finished	Green lacquered	Blister card

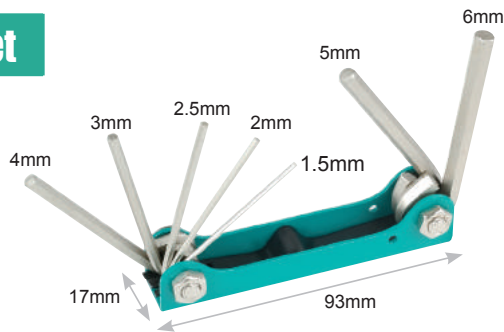
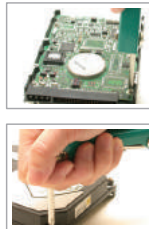

▶ 8PK-021T 8 PCS Folding Tamper-proof Star Key Wrench Set



- Key material : SAE 6150 with satin finished
- Case: Green lacquered

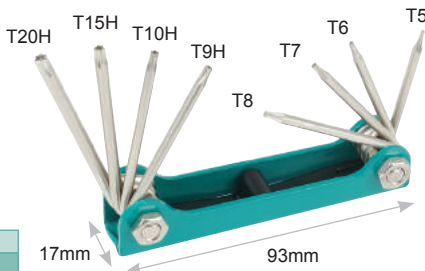

Contents
● T5, T6, T7, T8
● T9H, T10H, T15H, T20H

Individual packing: Blister card

▶ 8PK-021L 8 PCS Folding Star Key Set



- Key material : SAE 8660 with satin finished
- Case: Green lacquered

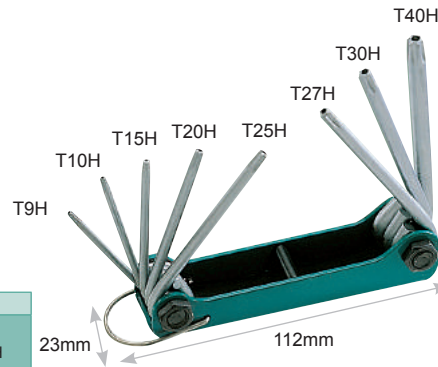

Contents
● T9H, T10H, T15H, T20H, T25H, T27H, T30H, T40H

Individual packing: Blister card

▶ HW-121L 8 PCS Folding Star Key Set



- Key material : SAE 6150 with satin finished
- Case: T.P.R. Anti-slip
- OAL.: 109x43x23 mm

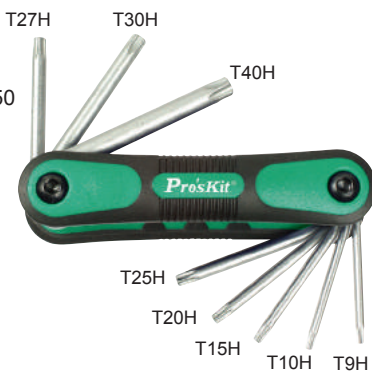

Contents
● T9H, T10H, T15H, T20H, T25H, T27H, T30H, T40H

Individual packing: Hanger

▶ HW-121M 8 PCS Folding Hex Key Set



- Key material : SAE 6150 with satin finished
- Case: T.P.R. Anti-slip
- OAL.: 109x43x23 mm

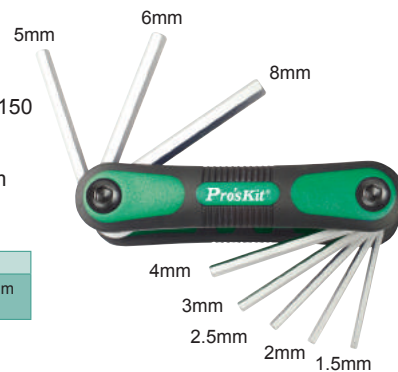

Contents
● 1.5, 2, 2.5, 3, 4, 5, 6, 8mm (Metric Size)

Individual packing: Hanger

▶ HW-221L 8 PCS Folding Star Key Set



- Key material : SAE 6150 with satin finished
- Case: Lacquered finished
- OAL.: 109x30x25mm

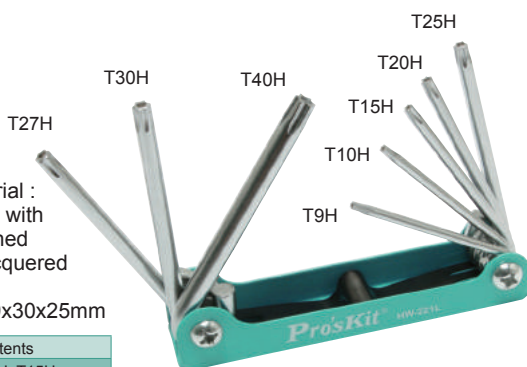

Contents
● T9H, T10H, T15H, T20H, T25H, T27H, T30H, T40H

Individual packing: Blister card

▶ HW-221M 8 PCS Aluminum Case Folding Hex Key Set



- Key material : SAE 6150 with satin finished
- Case: Adnodox aluminum
- OAL.: 104x36x22mm

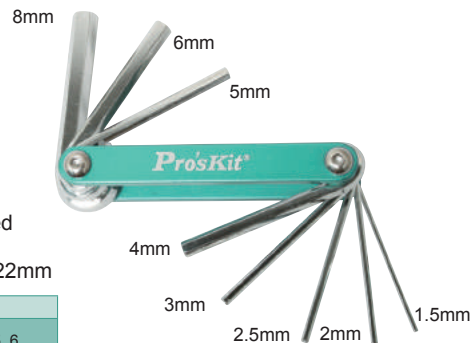

Contents
● 1.5, 2, 2.5, 3, 4, 5, 6, 8mm (Metric size)

Individual packing: Blister card

HW-322M Multi Bicycle Tool Set



Spoke wrench
13/14/15/16G

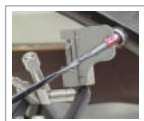

Tighten spoke
nipple

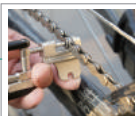

Chain cutter /
Bottle opener

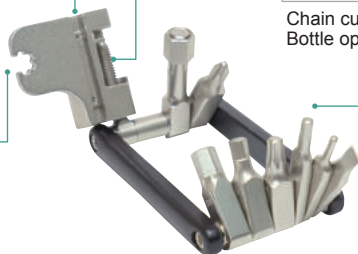

Great for tightening and adjusting bicycle handlebars, stem, seat, chain ring bolt, derailleur and more!

- Stunning ergonomic design and finish, feels great in your hand.
- Bits are made of forged and machined chrome vanadium steel for strength and long-lasting durability.

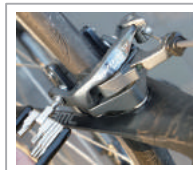

Material		Contents
Key	Case	Hex 2 / 3 / 4 / 5 / 6 / 8 mm, T25, - 5, #2, Spoke Wrench 13/14/15/16G, Mavic Spline, Bottle Opener, Chain Tool
Cr-V	Aluminum	Individual packing: Blister card

8PK-022 7 PCS Miniature L Shaped Hex Key Set



- Size range from 0.7~3 mm
- Key material:SAE 6150 with blackened finished



For hexagon
screws

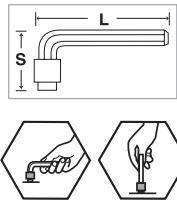

Tip Size (mm)	(mm)						
	0.7	0.9	1.3	1.5	2	2.5	3
S	8	10	12	14	17	19	20
L	35	38	41	45	50	56	65

Individual packing: Blister card

HW-023 8 PCS Ring Type Hex Key Set



- Long arm type
- Key material:SAE 6150 with blackened finished



Tip Size (mm)	(mm)							
	1.5	2	2.5	3	4	5	5.5	6
S	15	17	20	22	28	33	35	37
L	45	52	58	66	73	85	91	96

Individual packing: Blister card

HW-0221 16 PCS Hex Key Wrench Set



- Portable packaging
- Case can be hung for storage or display
- Key material:SAE 6150with satin finished (Inch) and blackened finished (Metric)

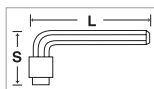

Tip size (inch)	S (mm)	L (mm)	Tip size (mm)	S (mm)	L (mm)
1/16"	15	46	1.5	15	46
5/64"	18	52	2	17	52
3/32"	18	53	2.5	20	59
1/8"	21	58	3	23	66
5/32"	26	68	4	29	73
3/16"	28	74	5	32	84
7/32"	31	81	5.5	34	89
1/4"	34	89	6	38	96

Case size 127x87x20 mm

Individual packing: Blister card

8PK-027 30 PCS Metric & Inch Combination Hex Key Set



- Portable packaging
- Case can be hung for storage or display
- Key Material :SAE 6150 with blackened finished

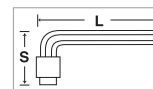

Tip size (inch)	S (mm)	L (mm)	Tip size (mm)	S (mm)	L (mm)	Tip size (inch)	S (mm)	L (mm)	Tip size (mm)	S (mm)	L (mm)
0.028"	8	65	0.7	8	35	9/64"	23	105	4.5	30	79
0.035"	11	69	0.9	11	39	5/32"	24	108	5	32	85
0.050"	13	73	1.3	13	42	3/16"	28	118	5.5	34	90
1/16"	15	78	1.5	15	46	7/32"	31	129	6	37	95
5/64"	16	84	2	18	52	1/4"	34	141	7	40	102
3/32"	19	90	2.5	20	58	5/16"	39	159	8	43	107
7/64"	21	95	3	23	66	3/8"	43	179	10	49	121
1/8"	22	99	4	29	73	Case Size	132x93x32 mm				

Individual packing: Blister card

▶ HW-024 9 PCS Long Arm Hex Key Set

- Long arm type
- Key material : SAE 6150 with blackened finish

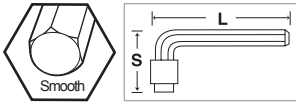

Tip Size (mm)		
(mm)	S	L
1.5	15	78
2	18	84
2.5	20	91
3	22	101
4	28	108
5	32	121
6	36	145
8	42	166
10	48	178

Individual packing: Blister card



▶ HW-129 9 PCS Long Arm Hex Key Set



- Key material : SAE 6150 with satin finished

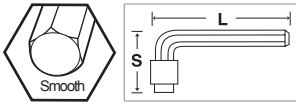

Tip Size (mm)		
(mm)	S	L
1.5	15	79
2	18	84
2.5	20	91
3	22	101
4	28	108
5	32	121
6	37	144
8	43	166
10	49	178

Individual packing: Blister card



▶ 8PK-028 9 PCS Ball-Point Hex Key Set



- Key material : S2 alloy steel with blackened finished

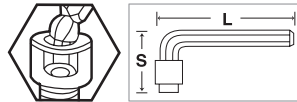

Tip Size (mm)		
(mm)	S	L
1.5	16	79
2	18	86
2.5	21	93
3	23	99
4	29	109
5	32	119
6	37	140
8	43	162
10	50	180

Individual packing: Blister card



▶ HW-229B 9PCS Ball Point Long Arm Hex Key Set



- Key material : SAE 6150 with satin finished

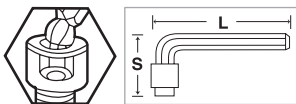

Tip Size (mm)		
(mm)	S	L
1.5	15.5	63.5
2	18	76
2.5	20.5	85.5
3	23	91
4	29	102
5	33	118
6	38	139
8	44	155
10	50	177

Individual packing: Blister card



▶ HW-229BL 9PCS Extra Long Long Arm Ball Point Hex Key Set



- Key material : SAE 6150 with satin finished

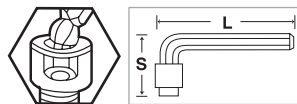

Tip Size (mm)		
(mm)	S	L
1.5	15.5	90.5
2	18	101
2.5	20.5	112.5
3	23	127
4	29	142
5	33	163
6	38	184
8	44	205
10	50	231

Individual packing: Blister card





SOCKET WRENCHES



You may think you're strong with a wrench, but a socket wrench can twist the head of a bolt right off.

Pro'sKit® socket wrenches make tightening and removing bolts incredibly easy.

Pro'sKit®

886-2-22183233
Sales support

pk@mail.prokits.com.tw
E-mail

www.prokits.com.tw
Global website



HW-T Series

Adjustable Torque Wrench With Reversible Ratchet

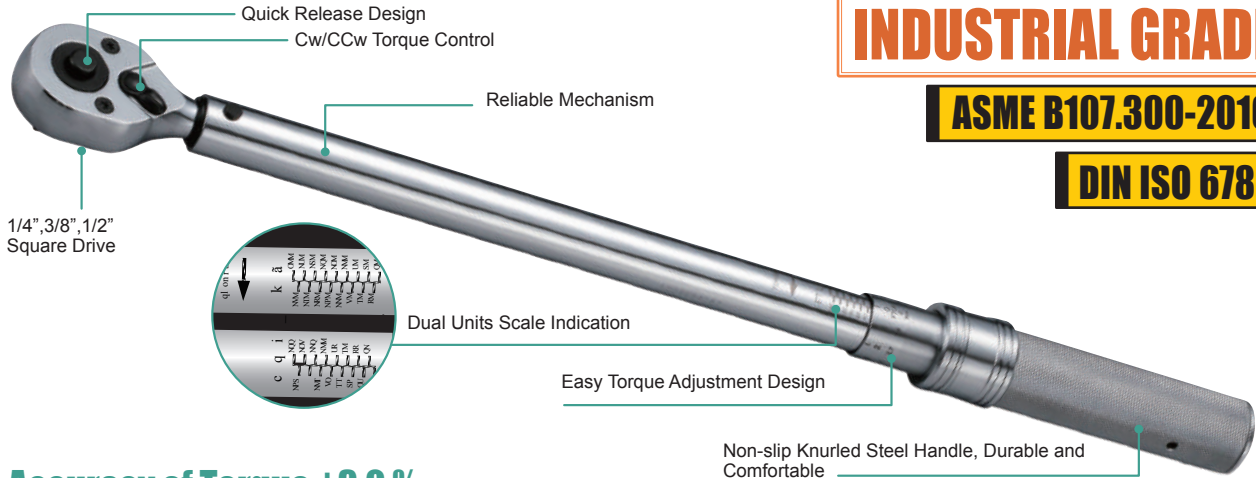

INDUSTRIAL GRADE

ASME B107.300-2010

DIN ISO 6789

SOCKET
WRENCHES

• Accuracy of Torque $\pm 3.0\%$

Each torque wrench laser serial no. and calibration certificate for future tracing.

• Dual Units Scale Indication

Dual units N-m and lbf.in or lbf.ft scale indication.

• CW/CCW Torque Control

Applied to both clockwise and counter clockwise bi-directional torque control. Signals by impulse when torque setting is reached.

• Easy Torque Adjustment

Easy torque-adjusting design brings energy-saving benefit. Positive locking mechanism avoids accidental setting alterations.

• Quick Release Design

Comes with quick release design, allows changing socket quickly.

• Reliable Mechanism

Quality meets DIN ISO 6789 & ASME B107.300-2010.

Idea for motorcycles, bicycle, automobile, truck, heavy machinery, ships, cruise, aerospace industry, high-speed rail and more.

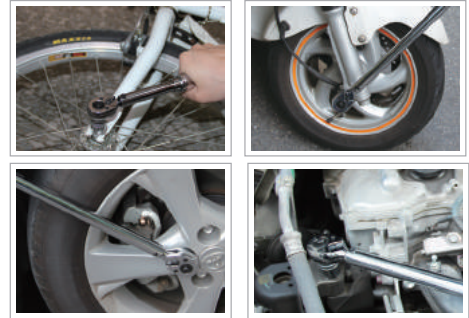

Spec.	HW-T41-315	HW-T41-525	HW-T83-20100	HW-T21-40200	HW-T21-60340
Drive	1/4"/6.35mm Square	1/4"/6.35mm Square	3/8"/9.53mm Square	1/2"/12.70mm Square	1/2"/12.70mm Square
Unit	N-m/lbf.ft Dual units	N-m/lbf.ft Dual units	N-m/lbf.ft Dual units	N-m/lbf.ft Dual units	N-m/lbf.ft Dual units
Torque range	3.0~15 N-m 31~128 lbf.ft	5.0~25 N-m 53~212 lbf.ft	20~100 N-m 16.6~71.9 lbf.ft	40~200 N-m 33~144 lbf.ft	60~340 N-m 52~243 lbf.ft
Accuracy	$\pm 3.0\%$	$\pm 3.0\%$	$\pm 3.0\%$	$\pm 3.0\%$	$\pm 3.0\%$
Graduation	0.1 N-m	0.2 N-m	0.5 N-m	1.0 N-m	2.0 N-m
Gear teeth	64 T	64 T	32 T	32 T	32 T
OAL	210 mm (8.3")	248 mm (9.8")	433 mm (17")	530 mm (21")	610 mm (24")

Individual packing: Plastic box + Color Label



HW-T716-3

7/16" Preset Torque Spanner



- Proper connections at "F" connector interface with preset torque setting 30 lbf-in(3.4N-m).
- Narrow head design helps work in tight density space.
- Audible click sound alerts user when full pressure has been applied.
- Ergonomic & cushion handle for comfort and protection.



Material		Torque range	Drive	OAL(mm)
Handle	HEX			
TPR	ANSI4140	30 lbf-in(3.4N-m)	7/16"(11.1mm)	163

Individual packing: Blister card

▶ SD-T635 Series Adjustable Torque Screwdriver

ASME B107.300-2010

DIN ISO 6789

INDUSTRIAL GRADE

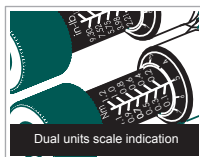

• Accuracy of Torque ±6.0 %

Each torque wrench laser serial no. and calibration certificate for future tracing.

• Dual Units Scale Indication

Dual units N.m and lbf.in or lbf.ft scale indication.

• CW/CCW Torque Control

Applied to both clockwise and counter clockwise bi-directional torque control. Signals by impulse when torque setting is reached.

• Easy Torque Adjustment

Easy torque-adjusting design brings energy-saving benefit. Positive locking mechanism avoids accidental setting alterations.

• Reliable Mechanism

Quality meets DIN ISO 6789 & ASME B107.300-201

Model No.	SD-T635-0112	SD-T635-16	SD-T635-510
Drive Unit	1/4"/6.35mm hexagon N-m/lbf.in dual units		
Torque Range	0.1~1.2 N-m 1.33~10.18 lbf-in	1.0~6.0 N-m 13.28~48.68 lbf-in	5.0~10 N-m 48.68~84.08 lbf-in
Accuracy	±6.0 %		
Graduation	0.01 N-m	0.1 N-m	
OAL	180 mm	200 mm	

Individual packing: Plastic box + Color Label

▶ SD-T636 12 PCS Torque Screwdriver Set



• Ergonomic Handle

Torque adjustable 1 - 6 N-m. Includes torque adjusting tool for torque setting easily.

• Bits

Includes 10pcs double end bits, common use 20 bits size to satisfy most applications. Made by AISI 8660 Cr-Mo-V steel.

• Application

For controlled fastening on electrical engineering installation and maintenance, and more.

• Durable Bag

Arranged properly in a high quality and rugged bag, could be used as convenient storage bag and waist working bag.



Quick release design for speedy interchanging bit



Accurately torque adjustable 1 - 6 N-m

Specification
Torque adjustable: 1~6 N-m, accuracy±6%, recommend calibration after 5000 cycle
Contents:
Dual Color PP/TPR/POM Handle, length:137mm
10pcs AISI 8660 double end hex bits, length:175mm: ⊖ SL3.0+SL4.0, SL5.5+SL6.35, PH0+PH1, PH2+PZ2, ⊕ PZ0+PZ1, ⊕ T10H+T15H, T20H+T25H, ⊕ H2H+H3H, H4HxH5H ⊕ PZ/FL1+PZ/FL2
Square 8mm torque adjusting tool, length:99mm/40mm

Individual packing: Color box

▶ HW-6509B/6514B Combination Wrench



Tools Meet DIN Standard

Corrosion resistant

Forged from highest quality alloy steel.

Box ends have 15° angle offset to provide clearance over obstructions.

Open ends are offset at standard 15° angle for confined working areas.

Open-end and box wrenches have the same size opening on each end.



Tool pouch

- Made of chrome vanadium steel with mirror finished, providing corrosion resistance
- Compact size for easy access in confined spaces
- Slim line spanners reduce problems with hard to reach nuts
- Complete set for automotive, industry, home use and more
- Comes with tool pouch for easy carrying and storage

HW-6509B



9PCS Combination Wrench (Metric)

Model No.	Spec.
HW-6509B	8, 10, 11, 12, 13, 14, 15, 17, 19mm

Individual packing: Color box

HW-6514B



14PCS Combination Wrench (Metric)

Model No.	Spec.
HW-6514B	8, 9, 10, 11, 12, 13, 14, 15, 16, 17, 18, 19, 22, 24mm

Individual packing: Color box

▶ HW-7509B/7513B Double Open End Wrench



Tools Meet DIN Standard

Corrosion resistant

Forged from highest quality alloy-steel.

Different size opening on each end of wrench.

Ends are offset at 15° angle for clearance over obstructions.



Tool pouch

- Made of chrome vanadium steel with mirror finished, providing corrosion resistance
- Compact size for easy access in confined spaces
- Slim line spanners reduce problems with hard to reach nuts
- Complete set for automotive, industry, home use and more
- Comes with tool pouch for easy carrying and storage

HW-7509B



9PCS Double Open End Wrench (Metric)

Model No.	Spec.
HW-7509B	6x7, 8x10, 11x13, 12x14, 14x17, 17x19, 21x23, 22x24, 24x27mm

Individual packing: Color box

HW-7513B



13PCS Double Open End Wrench (Metric)

Model No.	Spec.
HW-7513B	6x7, 8x10, 10x12, 11x13, 12x14, 14x17, 17x19, 19x21, 21x23, 22x24, 24x27, 27x30, 30x32mm

Individual packing: Color box

▶ 1PK-H Series Adjustable Wrenches



- Precision machined jaws for exact fit and smooth adjustment
- Drop forged carbon steel construction, rust resistant polished chrome finished
- The hex jaw design allows for a more secure fit and reduces slippage
- PVC coated handles
- Handle hole for easy hanging or storage

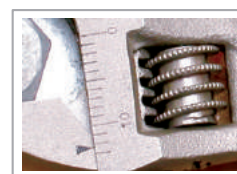

Model No.	Material	Jaw open (Max)	OAL.
1PK-H024	S45C	1/2"(13mm)	4"(100mm)
1PK-H026	S45C	1-3/16"(19mm)	6"(150mm)
1PK-H028	S45C	1"(25mm)	8"(200mm)
HW-010	S45C	1-3/16"(30mm)	10"(250mm)
HW-012	S45C	1-7/16"(36mm)	12"(300mm)

Individual packing: Blister card

▶ HW-008N 8" Adjustable Wrenches



Made by S50C drop forged

Handle hole for easy hanging

Model No.	Material	Jaw open (Max)	OAL.
HW-008N	S50C	1"(25mm)	8"(200mm)

Individual packing: Blister card

▶ HW-609A HW-609B 10 PCS Electronic Combination Wrenches



- 10 pcs electronic combination wrench set. Open boxend wrench made from AISI 1045, drop forged heat-treated.



Model No.	Spec.
HW-609A (Inch Size)	Close end 7/16", 11/32", 3/8", 9/32", 5/16", 1/4", 15/64", 7/32", 5/32", 3/16"
	Open end 3/8", 5/16", 11/32", 1/4", 9/32", 15/64", 7/32", 13/64", 3/16", 5/32"
HW-609B (Metric Size)	Close end 11, 10, 9, 8, 7, 6, 6, 5.5, 4.5, 4mm
	Open end 10, 9, 8, 7, 6, 5.5, 5, 4, 4.5mm

Individual packing: Pouch



HW-312S / HW-312B / HW-5912E

12 in 1 Type Ratcheting Box End Reversible Wrench



- 12 sizes in one reversible ratcheting wrenches for superior versatility and ease of use
- 72-teeth gear design delivers 5 degree effective swing arc, which makes work more efficient in limited areas
- Made of heat treated Cr-V steel with full polished for durability
- High torque capacity
- With forward, fixed and reversible function for easy operation



72-teeth gear, only 5° space for each turn



12 in 1

Long bolts and threaded rods are not a problem for the 12 in 1 wrench.

Model No.	Spec.	OAL.(mm)
HW-312S	8, 10, 11, 13mm	160
	5/16", 3/8", 7/16", 1/2"	
	E10, E12, E14, E16	
HW-312B	14, 16, 17, 19mm	230
	9/16", 5/8", 11/16", 3/4"	
	E18, E20, E22, E24	
HW-5912E	Contents: HW-312S, HW-312B	160/230

Individual packing: Blister card



HW-312S



HW-312B



HW-5907M

Flex Head Ratcheting Wrench



- Ratcheting box end set at 0°~180°
- Open end set at 15°
- Material: AISI 1045

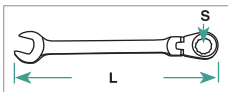

S(mm)	L(mm)
8	139
10	157
11	175
13	194
14	212
17	231
19	250

Individual packing: Plastic Box



8PK-SD016

23 PCS 1/4" Driver Socket Set



Contents	
18 pcs 1/4" DR 4, 5, 6, 7, 8, 9, 10, 11, 12mm 3/16", 7/32", 1/4", 9/32", 5/16", 11/32", 3/8", 7/16", 1/2"	
140mm ratchet handle	
Adaptor: 70, 150mm	
Steel box (214x84x44mm)	

Individual packing: Color sleeve shrink



INDUSTRIAL GRADE Tools meet DIN standard

SOCKET
WRENCHES

SK-22401M 24PCS 1/4" Drive Socket Tool Set



Universal joint Spinner T handle Extension bar w/2 way

13pcs hand socket 4,4.5,5,5.5,6,7,8,9,10,11,12,13,14mm		
5pcs hand deep socket 8,10,11,12,13mm	Extension bar 55mm	
Extension bar w/wobble 2 way 100mm	Sliding T handle 115mm	
Universal joint	Spinner handle	
72 teeth reverse flat ratchet handle w/quick release		
Metal case 245x120x35mm		

Individual packing : Color sleeve shrink

SK-22301M 23PCS 1/4" Drive Socket Tool Set



Teeth reverse flat ratchet handle Extension bar with quick release Spinner T handle

13pcs hand socket 1/4", 4,4.5,5,5.5,6,7,8,9,10,11,12,13mm		
2pcs hand deep socket 8,10mm	Extension bar 55mm	
Extension bar w/wobble 2 way 100mm	Extension bar w/quick release 150mm	
Sliding T handle 115mm	F type handle 145mm	Universal joint
Adaptor 3/8"Fx 1/4" M	72 teeth reverse flat ratchet handle w/quick release	
Metal case 245x120x35mm		

Individual packing : Color sleeve shrink

SK-23801M 38PCS 1/4" Drive Socket Tool Set



Universal joint Spinner handle Extension bar w/2 way

13pcs hand socket 4,4.5,5,5.5,6,7,8,9,10,11,12,13,14mm		
18pcs hand bits socket T10,T15,T20,T25,T30,T40,H3,H4,H5,H6,H8,PH1,PH2,PZ1,PZ2,SL4,SL5.5,SL6.5		
Extension bar 55mm	Extension bar w/wobble 2 way 100mm	
Sliding T handle 115mm	Universal joint	Adaptor 3/8" F x 1/4" M
Spinner handle	72 teeth reverse flat ratchet handle w/quick release	
Metal case 280x130x40mm		

Individual packing : Color sleeve shrink

SK-42401M 24PCS 1/2" Drive Socket Tool Set



F type handle Universal joint Teeth reverse flat ratchet handle

18pcs hand socket 10,11,12,13,14,15,16,17,18,19,20,21,22,23,24,27,30,32mm		
Extension bar 125mm	Extension bar 250mm	Sliding T handle 250mm
F type handle 375mm	Universal joint	
72 teeth reverse flat ratchet handle w/quick release		
Metal case 440x185x45mm		

Individual packing : Color sleeve shrink

SK-42601M 26PCS 1/2" Drive Socket Tool Set



- 14pcs hand socket 10,12,13,14,15,16,17,18,19,22,24,27,30,32mm
- 4pcs hand deep socket 12,14,17,19mm
- 2pcs spark plug socket w/magnetic 16,21mm
- Extension bar w/quick release 125mm
- Extension bar w/quick release 250mm
- Sliding T handle w/quick release 250mm
- LED light adaptor
- Universal joint
- 72 teeth reverse
- Flat ratchet handle w/quick release
- Metal case 445x185x50mm

Individual packing : color sleeve shrink



Extension bar with quick release



Teeth reverse flat ratchet handle



Spark plug socket



Sliding T handle with quick release

SK-612401M 124PCS 1/2" . 1/4" Drive Socket Tool Set



The SK-612401M 124pcs 1/2"-1/4" Dr. Socket tool set comes in an aluminum frame 3 drawers tool case for easy tool organization and contains most of popular tools to capability round out this versatile set.

- Top Layer : 0TR-612401MEVA-1**
- 23pcs 1/2" hand socket 8,9,10,11,12,13,14,15,16,17,18,19,20,21,22,23, 24,25,27,28,29,30,32mm
 - 8pcs 1/2" hand deep socket 10,11,12,13,14,17,19,22mm
 - 1/2" extension bar w/quick release 125mm
 - 1/2" Extension bar w/quick release 250mm
 - 1/2" Sliding T handle w/quick release 250mm
 - 1/2" LED light adaptor
 - 1/2" Universal joint
 - 1/2" 72 Teeth reverse flat ratchet handle w/quick release
- Drawer 1 : 0TR-612401MEVA-2**
- 14pcs 1/4" hand socket 1/4",4,4.5,5,5.5,6,7,8,9,10,11,12,13,14mm
 - 13pcs 1/4" hand deep socket 4,4.5,5,5.5,6,7,8,9,10,11,12,13,14mm
 - 18pcs 1/4" hand bits socket : T10, T15, T20, T25, T30, T40, H3, H6, H4, H5, H8, PH1, PH2, PZ1, PZ2, SL4, SL5, SL6, 5
 - 2Pcs 1/2" spark plug socket w/magnetic 16,21mm
 - 1/4" extension bar w/wobble 2 way 52mm
 - 1/4" extension bar w/wobble 2 way 100mm
 - 1/4" extension bar w/quick release 150mm
 - 1/4" sliding T handle 115mm
 - 1/4" universal joint
 - 1/4" spinner handle
 - 1/4" 72 teeth reverse flat ratchet handle w/quick release
- Adaptor 3/8" F x 1/4" M Multi-purpose box (OD 99x66x36mm)
- Drawer 2 : 0TR-612401MEVA-3**
- 9pcs ball-point long arm hex key 1.5,2,2.5,3,4,5,6,8,10mm
 - 7pcs flex head gear wrench 8,10,11,13,14,17,19
- Drawer 3 : 0TR-612401MEVA-4**
- 2pcs go-through screwdriver SL8x150mm, PH3x150mm
 - 6pcs pro-soft screwdriver SL6x100mm, SL6x40mm, SL6x200mm, PH2x100mm, PH2x40mm, PH2x250mm
 - Telescopic magnetic pick up tool
- Cover:**
- 3 1/2 compact digital multimeter
 - 8.5" high leverage combination cutting plier
 - 8" high leverage diagonal cutting plier
 - 8" high leverage long nose plier
 - 2pcs adjustable locking plier 7", 9" (long nose)
 - Aluminum frame 3 drawers tool case 485x260x333mm
- Individual packing : Color box

3 1/2 Compact Digital Multimeter for DCV, ACV, DC current, resistance, diode and transistor hFE test.



High leverage pliers new mechanical design, up to 50% cutting force saving than regular pliers

Locking pliers features a compound action, non-slip lock and release lever for one-hand operation

Top Layer



Drawer 1

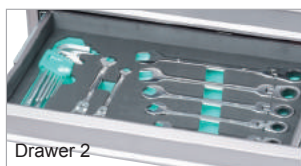

Drawer 2



Drawer 3



POWER TOOLS



Make anything possible, it's all the power you need!



Pro'sKit[®]

886-2-22183233
Sales support

pk@mail.prokits.com.tw
E-mail

www.prokits.com.tw
Global website

18V Li-ion Pro-Deluxe System

To provide more convenient work condition,
Pro'sKit® develops brand new series of power tool.

- ★ **Durable**
Long Lasting Motor
- ★ **Powerful**
Metal Gear Box
- ★ **Rapid**
1 Hour Charging Only



350/1200rpm
19200ipm
22/35N.M

PT-1801
Li-Ion Impact
Cordless Drill Driver



x 2

1 Hour
quick charging time

The Li-ion battery is known to have strong power, stable current, light weight and eco-friendly.

- Long lasting service life
- No memory effect. Charge-discharge anytime.



8000rpm

PT-1806
18V Li-Ion Cordless Angle Grinder



2200rpm
3000ipm
150N.M

PT-1802
Li-Ion Impact Cordless Driver



2600spm
6 gears

PT-1805
18V Li-Ion
Cordless Jig Saw

POWER TOOLS





230 x 220 x 95mm

Accessories :

5PT-1801-DRI : HSS drills : 2.0,2.5,3,4,5,6 mm Concrete drill bits
5PT-1206-BIT : CRV bits: PH1, PH2, PZ1, PZ2, SL5, SL 6
(L : 25mm) 60mm magnetic insert bits holder x1
5PT-1801-BIT1 : SL6-PH2 double end driver bits x1
5PT-1801-BAT : Battery x2

▶ PT-1801 18V Li-ion Impact Cordless Drill Driver

High Impact Force 19,200 ipm
Max. Torque 35N.m.

- Dual gear speed 0-350/0-1200rpm with stepless control for greater versatility.
- 16 torque setting with 3 rotary mode (screw/drill/impact).
- LED working light for improved visibility.
- Stepless variable speed.



Specifications	PT-1801A	AC 120V/60Hz
	PT-1801F	AC 230V/50Hz
Rated no load speed	0-350/0-1200 rpm/min	
Impact / min	0~19200 ipm/min	
Torque setting	16 torques	
	3 modes : screw/drill/impact	
Output torque	35N.M/22N.M	
Drive	1/2" keyless chuck	
Special function	2 gear speed switch forward & reverse switch, LED light	
Range of drill bit sizes	Ø2.0 ~Ø13mm	
	Steel: 8 mm	Wood: 20 mm
Max. drilling capacity	Concrete : 10 mm	
	Includes 2pcs 18V 1500mAh/pce	
Battery capacity	Colox box	



220 x 175 x 95mm

Accessories :

5PT-1802-SOC : CRV Socket 6,8,10,12mm, 50mm long socket adaptor, CRV PH2 bits
5PT-1801-BAT : Battery x2

▶ PT-1802 18V Li-ion Impact Cordless Driver

High Speed 2200 rpm
High Torque 150N.m.
Max Impact Force 3000 ipm

- Stepless variable speed features great speed control.
- LED working light for improved visibility.



Specifications	PT-1802A	AC 120V/60Hz
	PT-1802F	AC 230V/50Hz
Rated no load speed	0-2200 rpm/min	
Impact force	0~3000 ipm/min	
Output torque	150 N.M	
Drive	1/4" HEX keyless chuck	
Special function	Forward & reverse switch, LED light	
Battery capacity	Includes 2pcs 18V 1500mAh/pce	
Individual packing	Colox box	



▶ 5PT-1801-BAT Battery Pack

- 18V 1500mAh Li-ion battery complies with latest safety standard.
- 1 hour quick charge enables efficient work.
- No memory effect allows charge and discharge anytime.
- Compatible for 18V Cordless Power Tool series.
- Output voltage : DC18V 1.5A
- Individual packing : Color box



220 x 220 x 75mm

Accessories :

5PT-1805-HK : Hex key

5PT-1805-BLA : T shank wood cutting blade,
T shank metal cutting blade

5PT-1801-BAT : Battery x2

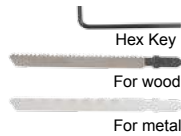

▶ PT-1805 18V Li-ion Cordless Jig Saw

6 Pendulum Selections Adjustable Bevel Angel Tool-Less Blade Change

- 0-2600 spm variable speed control.
- Adjustable bevel angle offers versatility for libration and debase noises.
- Lock-off design for on/off switch offers long working hours in safe condition.

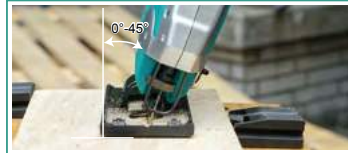

Specifications	PT-1805A	AC 120V/60Hz
	PT-1805F	AC 230V/50Hz
No load speed	0~2600 spm (Strokes per minute)	
Blade clamp	Quick release	
Pendulum action setting	6 Gears	
Stroke length	14mm	
Cutting depth	Wood:60mm, Steel:6mm	
Bevel angle adjustment	0°~45°	
Jig saw blade type	T shank	
Battery capacity	Includes 2pcs 18V 1500mAh/pce	
Individual packing	Colox box	

POWER TOOLS



350 x 250 x 110mm

Accessories :

5PT-1806-WHE : 115mm Grinder wheel

5PT-1801-BAT : Battery x2

▶ PT-1806 18V Li-ion Cordless Angle Grinder

High Speed 8000 rpm 2 Step Power Control

- Detachable handle for 3 position for better handing and less operation fatigue.
- Adjustable wheel guard allows to fit different application.
- Spindle lock allows to change accessory quickly.

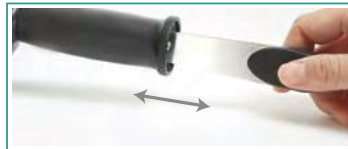

Specifications	PT-1806A	AC 120V/60Hz
	PT-1806F	AC 230V/50Hz
Rated no load speed	8000 rpm/min	
Spindle thread	M14	
Wheel diameter	max. 115mm	
Spindle diameter	22mm	
Battery capacity	Includes 2pcs 18V 1500mAh/pce	
Individual packing	Colox box	



▶ 5PT-1801-ADA/ADF

Charging Adaptor

Model No.	Input voltage	Ouput voltage	Plug
5PT-1801-ADA	AC120V/ 60Hz	DV18V 1.5A	A
5PT-1801-ADF	AC 230V 50Hz		F

• Individual packing: Color box

12V Li-ion Pro-Deluxe System

To provide more convenient work condition,
Pro'sKit® develops brand new series of power tool.

- ★ **Durable**
Long Lasting Motor
- ★ **Powerful**
Metal Gear Box
- ★ **Rapid**
1 Hour Charging Only



350/1300rpm
19+1 Torque
22/15N.M

PT-1206
Li-ion Cordless
Drill Driver



1 Hour
quick charging time

The Li-ion battery is known to have strong power, stable current, light weight and eco-friendly.

- Long lasting service life
- No memory effect. Charge-discharge anytime.



5000-15000ipm
Quick release
6 Gear speed

PT-1210
Li-ion Cordless Multi-function Tool



2000rpm
3000ipm
90N.M

PT-1207
Li-ion Impact
Cordless Driver

POWER TOOLS





185 x 185 x 55mm

▶ PT-1206 12V Li-ion Cordless Drill Driver

- Dual gear speed tackles all common drilling & driving applications.
- Stepless speed control for enhancing handling safety and high efficiency.
- 22N.m/15N.m enough torque to drive most common fasteners and drill bits.
- Keyless chuck for fast, one-handed bit changes.

Accessories :
 5PT-1206-DRI : HSS drills : 1.5,2.5,3,4,5,6mm
 5PT-1206-BIT : CRV bits : PH1, PH2, PZ1, PZ2, SL5, SL6 (L:25mm), 60mm magnetic insert bits holder
 5PT-1206-BAT : Battery x1

Specifications	PT-1206A	AC 120V/60Hz
	PT-1206F	AC 230V/50Hz
Rated no load speed	0-350/0-1300 rpm/min	
Torque setting	19 (drive)+1(drill)	
Output torque	22N.M/15N.M	
Drive	3/8" keyless chuck	
Special function	2 gear speed switch forward & reverse switch, LED light	
Battery capacity	12V 1300mAh	
Range of drill size	Ø0.8-Ø10mm	
Max. drilling capacity	steel-Ø6mm, wood-Ø18mm	
Individual packing	Colox box	



185 x 170 x 55mm

▶ PT-1207 12V Li-ion Impact Cordless Driver

- Long lasting motor delivers 90N.m of max torque in compact size for convenient work.
- Stepless speed control for enhancing handling safety and high efficiency.
- Keyless chuck for fast, one-handed bit changes.

Accessories :
 5PT-1207-SOC : CRV Socket 6,8,10,12mm, 50mm socket adaptor
 5PT-1206-BAT : Battery x1

Specifications	PT-1207A	AC 120V/60Hz
	PT-1207F	AC 230V/50Hz
Rated no load speed	0-2000 rpm/min	
Torque setting	0~3000 ipm/min	
Output torque	90N.m	
Drive	1/4" Hex keyless chunk	
Special function	Forward & reverse switch, LED light	
Battery capacity	12V 1300mAh	
Individual packing	Colox box	



265 x 95 x 50mm

▶ PT-1210 12V Li-ion Cordless Multi-function Tool

- High impact 5000~15000 ipm
- 6 Gear speed for best working results at different materials.
- Quick release locking lever design for convenient work.

Accessories :
 PT-1210-SP : 3pcs Sanding paper
 5PT-1210-PAD : Sanding pad
 5PT-1210-SB : Scraper blade
 5PT-1210-CB : Cutting blade
 5PT-1206-BAT : Battery x1

Specifications	PT-1210A	AC 120V/60Hz
	PT-1210F	AC 230V/50Hz
Impact force	5000~15,000 ipm/min	
Speed control knob	6 Gears	
Oscillati on angle on left/right	2.8°	
Chuck	Locking Lever	
LED light	Yes	
Battery capacity	12V 1300mAh	
Individual packing	Colox box	



▶ 5PT-1206-BAT Battery Pack

- 12V 1300mAh Li-ion battery complies with latest safety standard.
- 1 hour quick charge for efficient work.
- No memory effect allows charge and discharge anytime.
- Compatible for 12V Cordless Power Tool series.

▶ 5PT-1206-ADA/ADF Charging Adaptor

Model No.	Input voltage	Plug
5PT-1206-ADA	AC120V/ 60Hz	A
5PT-1206-ADF	AC 230V 50Hz	F

- Output voltage: DC12V 1.5A
- Individual packing: Color box



▶ PT-1201 12V Cordless Drill Driver

- 16 adjustable torque setting with drill function.
- Stepless speed trigger for complete control.
- Keyless chuck for fast, one-handed bit changes.
- Switch for forward or reverse rotation extra.



Model No.	PT-1201A/F
Main body	Max. drilling capacity Steel: Ø6mm Concrete: ø8mm Wood: Ø10mm Rated no load speed One gear speed: 0-550rpm Output torque 6Nm (61.2 kgf-cm / 53.11 lbf-in) Drive (Collet) 3/8" (10mm) Keyless Chuck Overall length 225mm x 245mm
Battery	Model No 5PT-1201-BAT Battery type Ni-Cd Battery voltage 12V Battery capacity 1000mAh Charging time 3-5 hours Free running time 35min
Optional bits set	5PT-1080-P1 (13 pcs/set)
Individual packing	Color sleeve shrink

Adaptor specifications	
Model No.	5PT-1201-ADA
Input voltage	120V AC 60Hz
Output voltage	DC 15V 400mA
Adapter plug	A
Model No.	5PT-1201-ADF
Input voltage	230V AC 50Hz
Output voltage	DC 15V 400mA
Adapter plug	F

Charger specification	
Model No.	5PT-1201-CH
Voltage	DC 15V 400mA

Accessories :

- 5PT-1801-P1 : Drills x 6 : Ø 1.5, 2.5, 3, 4, 5, 6mm, 25mm driver bits x 6 : 5.0, 6.0 #1, #2 PZ#1, PZ#2, Magnetic bits holder x 1
- 45mm double ends driver bits x 2 : #2, 6.0, #1, 5.0
- Adaptor and charger x1



▶ PT-0721 7.2V Cordless Pocket Screwdriver

- Dual gear speed: 0-200rpm/0-400rpm
- 15+1 adjustable torque setting
- Over charge and discharge protection
- 1300mAh Li-ion battery, long life and anti-pollution.



Model No.	PT-0721A/F
Main body	Torque setting 15+1 Position Rated no load speed Two gear speed: 0-200rpm/0-400rpm Output torque 5Nm (51 kgf-cm / 44.26 lbf-in) Drive (Collet) 1/4 quick release chuck Special function Switch for forward or reverse rotation, quick release chuck, LED light, battery power indicator
Battery	Overall length 160mm x 180mm Battery type Li-ion Battery voltage 7.2V Battery capacity 1300mAh Charging time 3-5 hours Free running time >70 min
Standard accessories	5PT-1361-P1
Individual packing	Double blister card

Adaptor specifications	
Model No.	5PT-0721-ADA
Input voltage	120V AC 60Hz
Output voltage	DC 9V 300mA
Adapter plug	A
Model No.	5PT-0721-ADF
Input voltage	230V AC 50Hz
Output voltage	DC 9V 300mA
Adapter plug	F

Accessories :

- 5PT-1361-P1 : 50mm driver bits x 4: 5.0, 6.0 #1, #2
- Adaptor x1



▶ PT-1361 3.6V Li-ion Cordless Screwdriver

- Complete Set, satisfy most of precision work.
- LED illumination provides visibility when working in dark area.



Model No.	PT-1361A/F
Main body	Torque setting 6+1 positions Rated no load speed 200 rpm Output torque 3 Nm (30.6 kgf-cm/26.55 lbf-in) Drive (Collet) Hex 1/4 (6.3mm) quick release chuck Special function Switch for forward or reverse rotation, 2 different angle settings LED Battery Power Status Indicator
Battery	Overall length: Straight 235mm(L) Overall length: Angled 170(L)x145(H)mm Battery type Li-ion Battery voltage 3.6V Battery capacity 1300mAh Charging time 3-5 hours Free running time 60 min
Standard accessories	5PT-1361-P1 (4pcs/set)
Individual packing	Double blister card

Adaptor specifications	
Model No.	5PT-1361-ADA
Input voltage	120V AC 60Hz
Output voltage	DC 6V 300mA
Adapter plug	A
Model No.	5PT-1361-ADF
Input voltage	230V AC 50Hz
Output voltage	DC 6V 300mA
Adapter plug	F

Accessories :

- 5PT-1361-P1 : 50mm driver bits x 4: 5.0, 6.0 #1, #2
- Adaptor x1



- Compact and Cordless
- USB Charging
- 3 Speed



PT-5205U Intertek **GS** **CE** **RoHS COMPLIANT**
3.7V USB Li-ion Mini Grinder set

- USB Charging- easy to use in anywhere.
- Compact and Cordless- break space limit.
- 3 Speed- 5000/1000/15000rpm for selection.

Model.No	PT-5205U
Rated no load speed	5000/10000/15000 rpm
Drive	Φ 2.4/ 3.2 mm
Battery	Rechargeable 3.7V 600mAh LI-ion
Charging Port	Micro USB
Battery charging indicator	Yes
Charging time	~2h (5V/0.5A)
Free running time	~100 min
Size	145x31mm
Weight	90g
Individual packing	PET folding box

Accessories : Sanding band x2, Diamond bits x2, Grinding stones x2, Engraving bit x1, Nylon brush x1, Mandrel for sanding band x1, Ø 2.4mm collet x1, Ø3.2mm collet x1

- LED Illumination
- Complete Set
- USB Charging



PT-036U **LED light** **CE** **RoHS COMPLIANT**
3.6V USB Li-ion Cordless Screwdriver

- Complete Set, satisfy most of precision work.
- USB charging, easy to use in anywhere
- LED illumination provides visibility when working in dark area.

Model.No	PT-036U
Rated no load speed	100 rpm/min
Output torque	0.4n.m
LED illumination	3 LED light
Battery	Rechargeable Li-ion battery 3.6V 350mAh
Charging time	1.5~2h(5V/0.5A~1A)
Free running time	30 min(unloading)
Dimension	160x25x22.5mm
Weight	60g
Individual packing	PET folding box

Accessories : 4mm bits x 7:#000, #00, #0,SL2.0,SL2.5, T5, T6, Miro USB charging cord x 1

- Full Metal Gear Box
- Japan SANYO Li-ion Battery
- USB Charging



PT-1362U **LED light** **CE** **FC** **RoHS COMPLIANT**
3.6V USB Li-ion Cordless Screwdriver

- USB charging, easy to use in anywhere.
- Full metal gear box, durable and not easy to wear.
- Japan SANYO Li-ion battery offers high performance and service life.

Model.No	PT-1362U
Rated no load speed	350 rpm
Output torque	3 Nm (31 kgf-cm/26.9 lbf-in)
Special function	LED charging indicator
Overall length	140(L)x110(H) mm
Battery	Li-ion 3.6V 1100 mAh
Charging time	1.5~2 hours (5V/2A)
Free running time	30 min
Individual packing	Double blister

Accessories : 50mm bits x 5:#1, #2,SL6.0,Hex3.0,4.0, Miro USB charging cord x 1

POWER TOOLS



▶ PT-1136 3.6V Cordless Lighted Screwdriver

- Adjustable 3 different angle to meet different application demands.
- LED illumination provides visibility when working in dark area.



Model No.	PT-1136A/F
Torque setting	None
Rated no load speed	200 rpm
Output torque	2.5 Nm(25.5 kgf-cm/ 22.13 lbf-in)
Drive (collet)	6.35mm (1/4") Hex Bit Shank
Special function	Switch forward or reverse rotation, LED light Handle can be used in 3 different position
Overall length: Straight	270mm (10-13/16")
Overall length: Angled	210×140mm (7-23/32")
Battery type	Ni-cd
Battery voltage	3.6V
Battery capacity	800mAh
Charging time	5-7 hours
Free running time	30-35 min. (unload speed)
Individual packing	Double blister card

Adaptor specifications	
For PT-1136A	
Input voltage	120V AC 60Hz
Output voltage	DC 6V 300mA
Adapter plug	A
For PT-1136F	
Input voltage	230V AC 50Hz
Output voltage	DC 6V 300mA
Adapter plug	F

Accessories : Magnetic bits holder x 2, 25mm bits x 11: 3.0, 4.0, 5.0, 6.0, 7.0, #1, #2, #3 T10, T15, T20, Adapter x 1

▶ PT-5501 Variable Speed Rotary Tool Kit

10,000 to 32,000RPM
variable speed.



- 40-piece accessories to meet most applications.
- Flexible shaft and cable attachment allows precision work.



Model No.	PT-5501A	PT-5501I
Maximum output	135 W	
No load speed	10,000-32,000 rpm	
Collet chuck capacity	3.2mm and 2.5mm	
Voltage	120V, 60Hz	230V, 50Hz
Plug	A	I
Carrying case size	285x235x80(mm)	
Individual packing	Color sleeve shrink	

Accessories : Round needle tip x1, Flat tip x1, Mandrel for polishing felt x1, Diamond bits x10, Grinding bits x2, Mandrel for grinding wheel x1, Sanding wheel x8, Sanding paper x3, Hex key wrench x1, Polishing felt (Ø 12mm, Ø 21mm) each x2, Mandrel for sanding band x1, Sanding band x4, Collet (Ø 2.5, Ø 3.2) each x1, High speed drill (Ø 3.2, Ø 2.3) each x1, Whetstone x1, Wrench x1



Comes with flexible shaft



Polishing

▶ PT-5203 Electric Engraver

Speed 7,100 spm
9 Position Stroke Setting



- LED light allows operating even in dark area.
- Ideal for engraving or decorating metal, glass, stone and more.

Model No.	PT-5203A	PT-5203I
Voltage	AC 120V 60Hz	AC 220V~240V 50Hz
Consumption	10 W	
Speed	7,100 spm	
Stroke setting	9 Position	
Engraver point holder	Φ3.0 mm	
Standard plug	A	I
Individual packing	Double blister card	

Accessories:
2 solid carbide tips Φ3.0×20 mm and 1 hex wrench included
1. A round needle tip for deep or thread engraving.
2. A flat tip for general and large area engraving.



▶ PT-5202 Mini Grinder Set



- Build-in LED light provides illumination during use.
- Includes 19 accessories and 2 stencils for most tasks.
- Durable plastic storage case for easy organized.

Model No.	PT-5202A	PT-5202F
Main body	Collet size	Max. Ø 3.2mm
	No-load speed	15,000 rpm
	Working voltage	18V DC
	Acoustic pressure	< 70dB
	Overall length	Ø43×127 mm
	Weight	123 g
Switch adapter	Input voltage	100~240VAC 50/60Hz 0.5A Max.
	Output voltage	18V DC 400mA
	Adaptor plug	A [I] F [↔]
	Certificate	UL US CE GS
Accessories	19 accessories and 2 stencils	
Carrying case	142x137x57mm (5.6"x5.4"x2.3")	



Storage case



Engraving



▶ 1PK-500 Series Super Drill Set

Low Vibration
High Torque
Lightweight



1PK-500-1

Contents:

- 5 pcs high speed steel drills (Ø0.5, 1.0, 1.5, 2.5, 3.0mm)
- 5 pcs brass collets (Ø0.5, 1.0, 1.5, 2.5, 3.0mm)
- Adaptor output: DC 12V/0.8A ⊕ ⊖ D/J Ø 5.5 / Ø2.1



1PK-500A-2 / 1PK-500C-2

Contents:

- 5 pcs high speed steel drills (Ø 0.5, 1.0, 1.5, 2.5, 3.0mm)
- 5 pcs brass collets (Ø 0.5, 1.0, 1.5, 2.5, 3.0mm)
- 4 pcs grindstones with arbour
- 1 pce super thin grinding wheel
- Adaptor output: DC 12V/0.8A ⊕ ⊖ D/J Ø 5.5 / Ø2.1



1PK-500B-2

Model No.	Chuck	Torque	No-load speed	Adaptor					Case(mm)	Individual packing
				Model No.	Input voltage	Output voltage	Plug	certificate		
1PK-500-1	Ø0.5-Ø3.0mm	530 gf-cm	9000~11000 rpm	-	-	-	-	-	165x120x45	Color label shrink
1PK-500A-2				9500-012A	120V AC 60Hz	DC 12V 800mA	A [I]	UL		
1PK-500B-2				9500-013B	100~240V AC 50/60Hz	DC 13V 800mA	F [↔]	CE		
1PK-500C-2				9500-012C	240V AC 50Hz	DC 12V 800mA	C [E]			

▶ 1H055-T Accessories

High speed steel drill bits designed for precision drilling applications in wood, non-ferrous metals and plastics. Available in pack, each containing 5 different drill sizes.



▶ PT-5201 Mini Grinder

- Naturally and comfortable operation body shape.
- The quick-change chuck is ideal for drilling, polishing, engraving, routing, shaping, sanding and milling.
- Low vibration, high torque & lightweight ergonomically design.



Model No.	Size (mm)
1H055-T (5pcs/set)	Ø 0.5
	Ø 1.0
	Ø 1.5
	Ø 2.5
	Ø 3.0

Individual packing : Blister card



Model No.	PT-5201A	PT-5201B
Max. diameter	Ø 3.2mm	
No load speed	8000~18000 rpm adjustable	
Adaptor voltage	Output: DC 18V 400mA Input: AC 120V 60Hz	Output: DC 18V 400mA Input: AC 230V 50Hz
Adaptor plug	A [I]	F [↔]
Replacement accessories	9PT-5201-P2 (10 pcs/set)	
Replacement adaptor	9PT-5201A-P	9PT-5201B-P
Individual packing	Double blister card	

- Accessories:
Contents (10 pcs/set): 2 pcs diamond bits, 2 pcs grinding stones, 2 pcs sanding bands, 1 pc collet (Ø 2.4/ Ø 3.2 mm), 1 pc nylon brush, 1 pc engraving bit, 1 pc connective post for sanding band



FIBER OPTICS



From simple installation tools to advanced trouble shooting equipment, **Pro'sKit**® total solution always got your back.



Pro'sKit®

886-2-22183233
Sales support

pk@mail.prokits.com.tw
E-mail

www.prokits.com.tw
Global website

Fiber Optic Break Point Check and Repair



FTTX Solution

Pro'sKit® is a leading supplier of fiber optic tools and accessories. The Pro'sKit® one-stop shop provides complete solution for fiber optic termination tools.



▶ TE-8202A/F Fiber Optic Fusion Splicing Machine Kit

A complete kit contains all of the necessary tools required for optical fusion splicing, in a durable tool case for easy carrying and storage.



• 3 Working Mode

Manual/Semi-Auto/Full Auto

• Core to Core Alignment

• 10 Sec. Splicing Time

Heating Shrink Protection

- Suitable for 20/40/60mm tube
- Average tube-heat time: 30 second

Hi-resolution Output

- 5" colorful LCD display.
- Separately X or Y axis views with 300 times magnification.
- Cutting-edge technology for image processing.

Store 6000 Data

of latest splicing results



USB Port B Type

For updates & result transfers

Removable and Rechargeable Li-ion Battery (12V 5.2AH)

TE-8202A/F-W Fiber Optic Fusion Splicing Machine with rigid carrying box

TE-8202A/F Fiber Optic Fusion Splicing Machine Kit

contains fusion splicer, fiber cleaver, fiber stripper, leak proof dispenser in a rigid carrying box to satisfy terminal procedure as below.

STEP 1
Refer to P.180

Stripping
PVC jacket
8PK-326

STEP 2
Refer to P.180

Cutting
Fiber
FB-1688C

STEP 3
Refer to P.228

Cleaning
Fiber
MS-018

STEP 4

Fusion
Splicing
TE-8202

Model. No	TE-8202A	TE-8202F
Applicable fibers	SM, MM, NZDS, EDF	
Average splice loss	0.02dB(SM), 0.01dB(MM), 0.04dB(NZDS), 0.04dB(EDF)	
Splice time (sec.)	10 sec. (for SM fiber)	
Return loss	≥60dB	
Diameter of fiber optic	Cladding diameter:80-150μm, Coating diameter:100-1000μm	
Tension test	2.0N(200gf)(Standard)	
Splicing program	50 groups	
Heat shrinkable tube	20mm, 40mm, 60mm	
Memory capacity	6000 memories	
Battery low indication	4pcs led light indication	
Environmental conditions	-10~+50°C (operation temperature), 0~95% RH(humidity), 0~5000m(altitude)	
Standard package	Fusion splicing machine, Fiber cleaver, Fiber stripper, Leak proof dispenser, AC adaptor, Battery(in the machine), Spare electrodes, 60mm Shrinkable tube 25pcs, Cooling tray, Quick reference guide, Carrying case with carrying strap	
Power supply	AC adaptor: 100~240V input voltage, 50/60Hz; 15V, 4A	
Standard plug	A	F
Battery	12V 5.2AH	
Dimensions	130(W) x 135(D) x 130(H) mm	
Weight	2480g (battery included)	
Individual packing	Label	

▶ MT-7610A/F Optical Time Domain Reflectometer



Automatic One-Button Testing

wavelength support 1310, 1550nm.

Visually Locate Events

to help quickly troubleshooting.

Accurate Detection

for short dead zone event.

High Speed

signal processing, short test time and fast analysis.

Features

- Palm design and lightweight for easy carrying
- High contrast 3.5 inch color TFT LCD • USB port connect to PC for software update and data output
- Built-in visual fault locator • Rechargeable Li- Po battery, supporting max. 8 working hours • Auto power off • Backlight



Visually locate events to help quickly troubleshooting



Accessories



FIBER OPTIC

Measurement Interface

There are 10x10 grid in waveform region, horizontal grids mean distance, vertical grids mean dB value. As shown in figure, each horizontal grid represents 0.2KM, each vertical grid represents 4dB.



Event List

Event List					
No.	Dis.	Loss	Ref.	dB/Km	C.Loss
1/6	0.000	0.00	-51.74	---	0.00
2/6	0.940	0.08	-51.74	0.24	0.26
3/6	4.301	0.12	-54.87	0.28	1.18
4/6	5.589	---	---	---	---
5/6	18.712	-0.05	-41.03	0.22	4.07
6/6	39.809	---	-46.02	0.21	9.41

- Optic fiber start
- Merged event
- Reflection event
- Gain event
- Attenuation event
- Optic fiber ending

Model. No	MT-7610A	MT-7610F
Optical fiber type	SM optical fiber	
Dynamic range	24dB(1310nm) / 22dB(1550nm)	
Wavelength	1310nm±20nm, 1550nm±20nm	
Fiber optic connector	SC/PC (FC/PC,ST/PC Optional)	
Display resolution	320x240	
Measuring distance (km)	0.37~80	
Distance uncertainty (m)	±(0.8+0.005% x distance+Sampling resolution)	
Pulse width	10ns~10us	
Measurement time	5s~180s	
Attenuation blind area	15m(@minimum plus width)	
Event blind area	3m(@minimum plus width)	
Loss threshold (db)	0.05dB	
Loss resolution (db)	0.01dB	
Sampling resolution (m)	0.4 to 1.6	
Sampling points	Up to 70866	
Typical real-time refresh (hz)	2	
Data storage	4GB micro SD card included, support 16GB, 25000records	
Communication connector	Mini USB	
VFL power	1mW(650nm±10nm)	
Power source	Rechargeable Lithium Polymer battery 7.4v 3100mAh	
Battery working time	Standby>15hours, continuous measuring>8 hours	
Adaptor input	AC 100~240 50/60Hz	
Adaptor output	DC 12V/2A	
Plug	A	F
Low battery warning	Indication for low battery energy	
Operation temperature	0~+50°C; <90%RH	
Storage temperature	-20~+70°C; <90%RH	
Size	195mm x 110mm x 60mm	
Individual packing	Color box	

▶ MT-7603 Fiber Optical Power Meter

CE



Additional : Pouch bag

- 850-1625nm Multi Wavelength Support
- PC Link System
- 39 Data Memories

Features

- Universal interface for FC/PC
- LCD backlight
- Auto power off
- USB port for updates & result transfers
- Low battery indication
- New REF user-defined
- Visual fault locator
- Protective rubber boot
- Wavelength measurement calibration
- Modulation detection



Fiber optic power test

Detector type	InGaAs
Optical connector	FC / PC
Measurement range	+8 ~ -70dBm
Measurement wavelengths	850,1300,1310,1490,1550,1625nm
Resolution	0.01dB
Accuracy	±0.2dB
Measurement linearity	±2.0%
Display resolution	+8~-60dBm: 0.01dB, -60~-70dBm: 0.1dB
Power display units	dBm, mW, uW, nW,
Communication connector	USB
Data storage	39 group
Modulation detection	270Hz,1kHz,2kHz
Visual fault locator	1mW
Auto power Off	10 min (can be cancelled)
Low battery warning	Low battery energy
Battery life	> 160 hours
Operation temperature	-10~+60°C; <90%RH
Storage temperature	-20~+70°C; <90%RH
Power source	AA/LR6 1.5V X2 (not include)
Size	170mm×97mm×38mm
Weight	330g
Optional accessory	LC adaptor (5MT-7601-LC), SC adaptor (5MT-7601-SC)
Individual packing	Color box

▶ MT-7601 Fiber Optical Power Meter

CE



Additional : Pouch bag

- 850-1625nm Multi Wavelength
- Easy to use for Telecommunication networks & FTTx applications.
- Adapts to FC/SC/ST Connectors

Features

- New REF user-defined
- Battery indication
- Auto power off
- LCD backlight
- Protective rubber boot
- Body protection
- Operation voice prompts
- Reference comparison value



Fiber optic power test

Detector type	InGaAs
Optical connector	FC/SC/ST& 2.5mm Universal
Calibrated wavelengths	850, 1300, 1310, 1490, 1550,1625
Measurement range	+6 ~ -70 dBm
Accuracy	(1550nm, 1310nm)±0.2dB/(1490nm, 1625nm)±0.3dB/(850nm, 1300nm)±0.4dB
Power measurement linearity	±2.0%
Display resolution	+6~-60dBm:0.01 dB(-60~-70dBm:0.1 dB)
Power display units	dBm, mW, uW, nW
Modulation detection	270Hz, 1kHz, 2kHz (850, 1300, 1310, 1490, 1550, 1625)
Automatic power off	10 min.(Can be cancelled)
Low battery warning	Low battery energy
Battery life	> 160 hours
Operation temperature	-10 ~ +60 °C, < 90%
Storage temperature	-20 ~ +70°C, < 90%
Power source	AA/LR6 1.5V×2 (not included)
Size	165×80×35 mm
Weight	180g (w/o battery)
Optional accessory	LC adaptor (5MT-7601-LC)
Individual packing	Color box

▶ MT-7602 4 In 1 Fiber Optic Power Multimeter

CE FDA LED light

4 IN 1

- 1.Fiber Power Meter
- 2.Visual Fault Locator
- 3.Cable Tester
- 4.LED Flashlight



Fiber optic power test



Break in fiber test



Cable tester



LED flashlight

Features

- Battery indication
- Auto power off
- Built-in USB charging port
- Reverse battery protection

Detector type	InGaAs
Optical connector	ST/SC/FC & 2.5mm Universal
Calibrated wavelengths	850/1300/1310/1490/1550/1625 nm
Measurement range	+6 ~ -70 dBm
Accuracy	(1550nm, 1310nm)±0.2dB/(1490nm,1625nm)±0.3dB/(850nm,1300nm)±0.4dB
Power measurement linearity	±2%
Display resolution	+6~-60dBm(0.01dB)/-60~-70dBm(0.1dB)
Power display units	dBm, uW, mW
Output power	<1mW
Range	3~5 km @SM
Connector	ST/SC/FC & 2.5mm Universal
Laser safety rating	Class 2
Wavelength	650nm±20nm
Output modes	Continuous (CW), 2 Hz pulsed
Lan Connector	RJ45 & RJ11
Cable	UTP LAN cable(8P8C), Telecom cable(6P2C/6P4C/6P6C)
Tester	Measuring length max. 600 meter
Automatic power off	10 min.(Can be cancelled)
Low battery warning	Low battery energy
Battery life	>160H (Only OPM use alkaline battery)
Power source	Size AA x 2 (Not included)
Size	105×52×34 mm
Optional accessory	LC adaptor (5MT-7601-LC)
Individual packing	Color box

▶ MT-7801/MT-7802/MT-7803 Fiber Optical Light Source

Multi-Range Supply

- MT-7801 for 1310/1550 single mode
- MT-7802 for 850/1300 multi mode
- MT-7803 for 1310/1490/1550 single mode

WAVE ID helps to identify the wavelength automatically.
Supports SC/PC

Model. No	MT-7801	MT-7802	MT-7803
Wavelength ±10nm	1310/1550nm	850/1300nm	1310/1490/1550nm
Power stability	±0.05dB / 1hr : ±0.1dB / 8hrs		
Output power	>-5dBm	>-10dBm	>-5dBm
Optical connector	SC/PC		
Modulation	270Hz, 1kHz, 2kHz		
Auto power off	10 minutes (could be reset)		
Battery charge	Yes (when use rechargeable battery), by DC 5V power jack		
Low battery indication	Yes		
Storage temperature	-20~+70°C; <90%RH		
Operation temperature	-10~+60°C; <90%RH		
Power source	2 x 1.5V AA batteries (Not included)		
Dimension	165x 80 x 35mm		
Weight	280g		
Individual packing	Color box		

Features

- LCD backlight • Auto power off • 3 modulations selection
- Single key for wavelength switch • DC5V power jack for rechargeable battery charging
- Protective rubber boot



Fiber optic power test



Additional : Pouch bag



▶ MT-7501/MT-7505/MT-7510 Fiber Optical Visual Fault Locator

1 Sec. Quick Illumination

To make checking work convenient

2 Operation Modes

To locate fault accurately

3 Supported Connectors

To give more versatile choice (FC/SC/ST)

Features

- Portable and durable • Both continuous and flashing mode • Supports 2.5mm universal connectors • Dust proof & crash proof cap

Model No.	MT-7501	MT-7505	MT-7510
Wavelength		650 nm±10 nm	
Output power	1 mW	5 mW	10 mW
Light source	CLASS II	CLASS IIIA	CLASS IIIB
Tested fiber length	3-5KM	6-7KM	8-10KM
Power (batteries)	AA (1.5 V) x 2 (Not included)		
Connector	2.5mm universal connector for FC, ST and SC		
OAL	175mm		
Operation temperature	-10~55°C		
Storage temperature	-10~70°C		
Optional accessory	LC adaptor (5MT-7601-LC)		
Individual packing	Color box		



Continuity test



Locate break point



Accessory



Compatible connectors (LC with optional adaptor)



ST

FC

SC

▶ MT-7508 / MT-7509 Fiber Optical Visual Fault Locator

Measuring Distance : 8KM



Model No.	MT-7508	MT-7509
Connector type	2.5mm (FC/SC/ST)	1.25mm (LC)
Light source	Class 3A laser diode	
Nominal wavelength	650±10nm	
Battery	1.5V AAA x2 (Not included)	
OAL(mm)	ø13.5x160	
Individual packing	Color box with black EVA inner case	



MT-7508
for testing ST, SC,
FC connectors



Compatible connectors (LC with optional adaptor)

ST

FC

SC



MT-7509
for testing
LC connectors



LC

▶ FB-1688 Fiber Cleaver

Blade lifetime up to
48000 Cleaves
(3000 x 16-fiber cleaves)

4 in 1 Fiber Holder

for 125µm cladding,
250µm -900µm coating,
patch cord and
FTTH drop cable

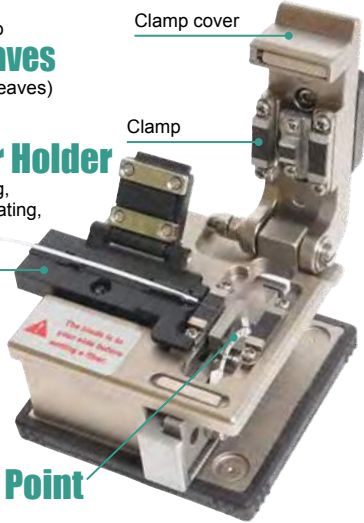

16 Cutting Point

for each blade

- Standard precision single mode fiber cleaver.
- Simple and easy replacement of blade.
- Replacement blade is available, model No:5FB-1688-BLADE.



Cladding diameter	Fiber count coating diameter	Cleave length	Dimensions	Cleaver blade (5FB-1688-BLADE)	Individual packing
125 µm	Single fiber 250µm & 900µm	5-20 mm	62x60x56 mm	16 cutting points material: Tungsten steel	Color box

▶ CP-FB01 FTTH Drop Cable Stripper

- Universal Stripper for 3.1x2.0mm FTTH drop cables with steel wire or FRP strength member.
- Improve cable splicing, more efficient and easy to use.



Body	Blade	Applications	OAL(mm)	Individual packing
Zinc alloy	CR12, HRC:60-63	For stripping FTTH drop cable, fiber cladding diameter: 125 µm	30x110x20	Blister card

▶ DK-2026N Carbide Fiber Scribe

- Flat, chisel geometry tip.
- Carbide tip material perfect for scribing glass fiber.
- Light weight, pen-size with pocket clip design.



OAL(mm)	Individual packing
Ø 12x138	Blister card



▶ 8PK-326 Fiber Optic Stripper



Strips 125 micron glass fiber with 250 micron buffer coating without scratching or nicking glass fiber.



- Strips the 1.6-3.0mm fiber jacket down to the 600-900 micron buffer coating.
- Strips the 600-900 micron buffer coating down to the 250 micron coating.
- Strips the 250 micron cable down to the glass fiber without nicks or scratches.

1.6-3.0mm 600-900µm
600-900µm 250µm
250µm 125µm



Material	HRC	OAL(mm)	Individual packing
S50C	48±2°	148	Blister card

▶ DK-2043 Fiber Optic Kevlar Cutter



- Serrated blade for gripping materials.
- Specially designed for cutting Kevlar materials.



For cutting Kevlar fiber optic cable



Micro serrated

Handle material	Blade HRC	Hardness (Cutting edge)	OAL (mm)	Individual packing
TPR	60°-62°	HV1200	160	Blister card

▶ **FB-C010** Fiber Optic Connector Cleaner

Refillable Cleaning Tape Full Cleaning

for SC , FC, MU, LC, ST, D4, DIN connectors

- Offering over 500 cleans for SC, FC, MU, LC, ST, D4, DIN connectors
- Special non-alcohol high density textile fiber type eliminates the need for solvents
- Indication see-through window for easy checking



The refillable cleaning tape:
Model No.5FB-C010-RPM



Material	Cleaning times	Applications	Dimensions	Individual packing
High density textile fibers	500/per box	For cleaning SC , FC , ST, MU, LC, D4, MT, DIN connector	115×79×32 mm	Blister card

▶ **8PK-MA009** Fiber Optic Viewing Scope Kit

- This fiber optic viewing scope kit makes it simple to view ST/SC/FC.
- Pre-encapsulated FDDI, and the ends of fiber before and after cleaving operations.



Magnification	Light source	Battery	OAL (mm)	Optional	Individual packing
200X Adjustable	Bulb 2.25V/0.25A	1.5V AAx2pcs (not included)	148x46x25	9MA009-LC	Blister card

▶ **1FB-ST/1FB-SC/1FB-LC1** ST/SC/LC Polishing Disk



- Inserts connector into polishing disk
- Polish using a figure 8 motion on sandpaper sheet (not included)
- Made from aluminum with hard oxygen treatment for durability.



1FB-ST



1FB-SC



1FB-LC1

▶ **8PK-C002** Foam Swabs Cleaning Kit



Model No.	OAL(mm)	Individual packing
1FB-ST	32.8	Blister card
1FB-SC	37.8	
1FB-LC1	32.8	

For clean up of organic & inorganic residue in clean room and other areas. Ideal for fiber optic clean work.

Individual packing

Blister card

▶ PK-9460/ PK-9461/ PK-9462 Basic Fiber Optic Cleaning Kit



9Z-940KP Zipper carrying bag (280x197x70mm)

Individual packing: Label

- MT-7601 Fiber Optic Power Meter**
Tests for 850nm- 1625nm wavelengths. Refer to p.178
- FB-C008/ FB-C009 Fiber Optic One Click Cleaner**
• 600 cleans for FC/PC, ST, SC or LC MU connectors
• 180° rotating cleaning system • Extendable nozzle
- FB-C010 Fiber Optic Connector Cleaner**
Full cleaning for SC , FC, MU, LC, ST, D4, DIN connectors. Refer to p.181
- 8PK-MA009 Fiber Optic Viewing Scope Kit**
Simple to view ST / SC / FC. Refer to p.181

Model	Product Name	PK-9460	PK-9461	PK-9462
MS-153A	Bulb blower (Ø42mm)	•	•	•
FB-C008	2.5mm fiber optic One click cleaner	•	•	•
FB-C009	1.25mm fiber optic one click cleaner	•	•	•
FB-C010	Fiber optic cleaning cassette	•	•	•
FB-C011	Lint free wiper	•	•	•
9C003	Cleaning liquid	•	•	•
8PK-MA009	Fiber optic viewing scope kit		•	•
MT-7601	Fiber optic power meter			•



Fiber optic power test



2.5mm For FC/PC, ST & SC connectors



1.25mm LC connectors



Refillable cleaning tape



200X magnification

▶ PK-6942 Fiber Optic Tool Kit



- 8PK-326 Fiber Optic Stripper**
Accurately strip 125 micron glass fiber with 250 micron fiber coating. Refer to p.180
- DK-2026N Carbide Fiber Scribe**
Lightweight, pen size. Perfect for scribing glass fiber. Refer to p.180
- MT-7508 Fiber Optic Visual Fault Locator**
For testing ST, SC, FC connectors. Refer to p.179

Contents	
MT-7058	Fiber optic visual fault locator (For FC/SC/ST)
8PK-326	Fiber optic stripper
DK-2043	Fiber optic kevlar cutter
DK-2026N	Carbide fiber scribe
CP-301F4	Fiber optic crimping tool
8PK-MA009	Fiber optic viewing scope kit(200x)
8PK-C002	Foam swabs cleaning kit
9G100N	Syringe(2.5ml)
903-133	Utility component storage box
1FB-LC1/SC/ST	Sc/st/lc polishing disk 32.8mm
Individual packing	Inner box + color label shrink



▶ 1PK-940KN Fiber Optic Tool Kit



This tool kit provides a complete fiber optic termination tools such as strippers, crimpers, kevlar cutters, viewing scope and cleaning kit for easy and quick termination.

Contents	
103-132C	Utility component storage box
1FB-SC	SC polishing disk
1FB-ST	ST polishing disk
1PK-258A	Side cutter 125mm
8PK-301F1	Fiber optic crimping tool
8PK-326	Fiber optic stripper
8PK-C002	Foam swabs cleaning kit
8PK-MA009	Fiber optic viewing scope kit
9G100N	Universal syringe 2.5ml
DK-2026N	Carbide fiber scribe
DK-2043	Fiber optic kevlar cutter
9Z-940KP	Carrying zipper bag (280x197x70mm)
Individual packing	Inner box + color label shrink

PK-9456 FTTH Fiber Optic Tool Kit

This tool kit is designed for especially used in the FTTH installation, it is simple, convenient and economic. This kit contains the essential tools for FTTH project, such as drop cable stripper, cleaver, cleaning tools and power meter.

Contents	
SB-1592	Component storage box (145x92x40mm)
1PK-067DS	6" Dual color side cutting plier
1PK-709DS	6" Dual color long nose cutting plier
8PK-326	Fiber optic stripper
SD-207A	Pro-soft screwdriver (-6 6x100mm)
SD-207B	Pro-soft screwdriver (+#2 6x100mm)
CP-FB01	FTTH Drop cable stripper
PD-513	Utility knife
FB-1688	Fiber cleaver
MS-018	Leak proof dispenser pump bottle
MT-7501	10mW Fiber optic visual fault locator
MT-7601	Fiber Optic power meter
9ST-7610-BAG	MT-7610 Bag
Individual packing	Color box



PK-9458 FTTH Fiber Optic Tool Kit

8PK-326 Fiber Optic Stripper

- Strips 125 micron glass fiber with 250 micron buffer coating.
- Material : S50C



Refer to p.180

CP-376TR 4P/6P/8P Telecom Crimping Tool

- Body: S45C
- Handle: Black:T.P.R Green:PP

Refer to p.78

FB-1688 Fiber Cleaver

16 cutting location for each blade.
Blade life up to 48000 times

- Blade: Tungsten
- Cladding Diameter:125 μm
- Cleave length:10~20 mm
- Cleave angle: ≤ 0.8°



Refer to p.180



FB-C008/FB-C009 1.25/2.5mm One Click Cleaner

600 cleans for FC/PC, ST, SC or LC Connectors

- Easy pushing motion
- 180° rotates cleaning system
- Extendable nozzle
- Indication window



MT-7602 4 in 1 Fiber Optic Power Multimeter

Refer to p.178

- Fiber optic power meter
- Cable tester
- Visual fault locator
- LED flashlight



Contents	
MT-7602	4 in 1 fiber optic power multimeter
FB-C008/FB-C009	1.25/2.5mm one click cleaner
FB-1688	Fiber cleaver
CP-376TR	4P/6P/8P Telecom crimping tool
CP-FB01	FTTH drop cable stripper
8PK-326	Fiber optical stripper
1PK-067DS	Dual color side cutting plier (165mm)
9SD-207B	Pro-soft screwdriver (+#2 6x100mm)
9SD-201A	Pro-soft screwdriver (-3.0 3.0X75mm)
DK-2043	Fiber optic kevlar cutter

DK-2060	Auto stop measuring tape
MS-018	Leak proof dispenser pump bottle
FL-528	1W LED head light
PD-2612	8 Oz curved claw hammer
SB-1592	Component storage box(145x92x40mm)
MS-153A	Bulb blower (φ42mm)
8PK-C002	Foam swabs cleaning kit
5MT-7601-LC	Fiber optical power meter LC adaptor
9PK-153	Brush
9TC-752	Aluminium frame tool case (400x280x134mm)
Individual packing	Color box

ESD STATIC



Pro'sKit® ESD series help you to get rid of static electricity problems.



Pro'sKit®

886-2-22183233
Sales support

pk@mail.prokits.com.tw
E-mail

www.prokits.com.tw
Global website

ESD Tools Solution

What is static electricity? How to prevent?

Static electricity is the imbalance of positive and negative electric charge. When two different materials contact, it will cause the rubbing. The more electrons move, the larger the static charge builds up. On production lines of electronic equipment, electronic components such as ICs will get damaged by such static charges. For static control in work areas, you can use anti-dissipative mats on floors and tables, and have people wear anti-static wrist strap, heel straps.

The resistance and decay time of conductor, static control products and insulator

Conductor means the materials which have the electrons held loosely and the electrons can move easily, most of metals are good conductors.

Static control product means the products designed for static control or elimination to protect electronic components and human body against injury.

Insulator means the materials which have the electrons held tightly and the electrons don't move well. Plastic, cloth, glass and dry air are good insulator.

	CONDUCTOR	STATIC CONTROL PRODUCT	INSULATOR
Resistance(Ω)	10^5	10^8	10^{12}
Decay time(SEC)	10^{-6}	10^{-3}	10^0

ESD Products Test Method

Pro'sKit® ESD series products are tested in accordance with ESD Association standard as following EPA (ESD protected areas) ESD Control Program Plan

ESD Control Item	Product Qualification ¹	
	Test Method	Required Limit(s) ²
Work Surface	ANSI/ESD S 4.1 and or ANSI/ESD STM 4.2	< $1 \times 10^9 \Omega$ and/or < 200 volts
Wrist Strap Cord	ANSI/ESD S1.1	0.8×10^6 to $1.2 \times 10^6 \Omega$
Wrist Strap Cuff	ANSI/ESD S1.1	Interior < $1 \times 10^5 \Omega$ Exterior > $1 \times 10^7 \Omega$
Wrist Strap Cord Bending Life	ANSI/ESD S1.1	> 16,000 cycles
Foot Grounders	ESD SP9.2	< $1 \times 10^9 \Omega$
Flooring	ANSI/ESD S7.1	< $1 \times 10^9 \Omega$
Mobile Equipment (Working Surfaces)	ANSI/ESD S4.1	< $1 \times 10^9 \Omega$

* This table is quoted from ESD Association standard ANSI/ESD S20.20-2007

Pro'sKit® ESD products applications

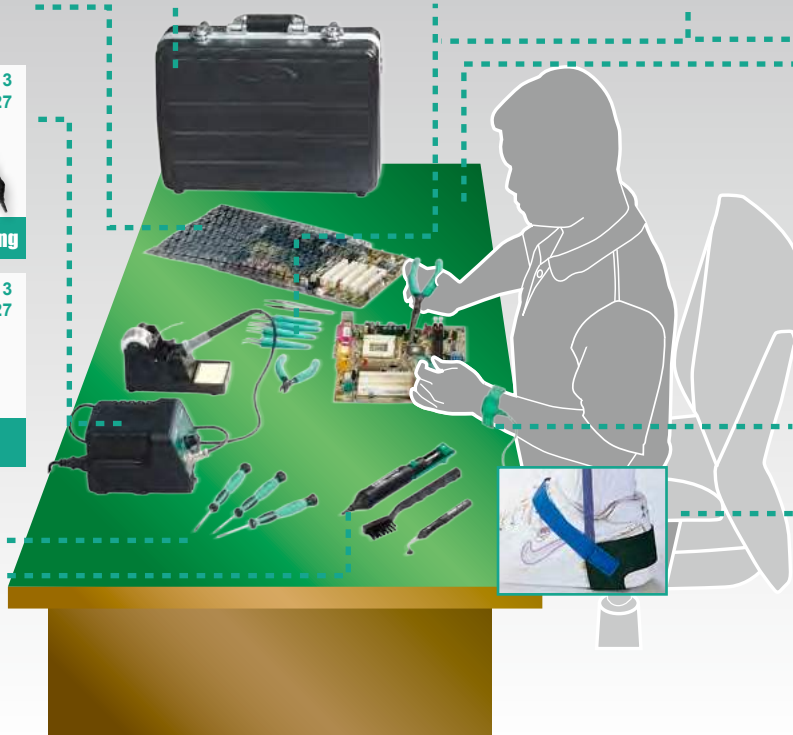
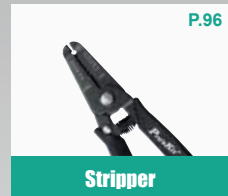

▶ AS-611/AS-611-6 Wrist Strap



Model No.	Band resistivity	Wrist strap resistivity	Band size	Cord size (feet)	Individual packing
AS-611	10 ³ ~10 ⁵ Ω	10 ⁶ Ω	Fixed	10 (3M)	Blister card
AS-611-6				6 (1.5M)	

▶ 8PK-611/908-611-6 Wrist Strap



Model No.	Band resistivity	Wrist strap resistivity	Band size	Cord size (feet)	Individual packing
8PK-611	10 ³ ~10 ⁵ Ω	10 ⁶ Ω	Fixed	10 (3M)	Blister card
908-611-6				6 (1.5M)	

▶ 8PK-611D/8PK-611D-6 Wrist Strap



Model No.	Band resistivity	Cord resistivity	Band size type	Cord size (feet)	Individual packing
8PK-611D	10 ³ ~10 ⁵ Ω	10 ⁶ Ω	Adjustable	10 (3M)	Blister card
8PK-611D-6				6 (1.5M)	

▶ 608-611C/608-611C-6 Wrist Strap

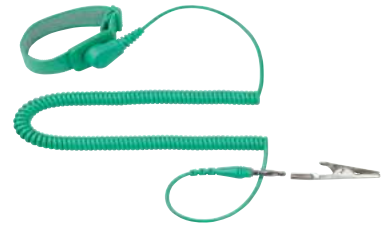

Model No.	Band resistivity	Cord resistivity	Band size type	Cord size (feet)	Individual packing
608-611C	10 ³ ~10 ⁵ Ω	10 ⁶ Ω	Adjustable	10 (3M)	Blister card
608-611C-6				6 (1.5M)	

▶ AS-611F Quick-Fasten Wrist Band



PATENT :
TAIWAN PAT.186074
GERMANY PAT.201 00 860.2
CHINA PAT.002 67509.9

- Material: T.P.R. plastic.
- Application: Class 100~1000 (clear room)
- Molding: Snap and plug-PVC molding



Band resistivity	Cord resistivity	Band size type	Cord size (feet)	Individual packing
10 ³ ~10 ⁵ Ω	10 ⁶ Ω	Adjustable	6 (1.5M)	Blister card

▶ 608-611B/608-611B-6 Wrist Strap



Model No.	Band resistivity	Cord resistivity	Band size type	Cord size (feet)	Individual packing
608-611B	10 ³ ~10 ⁵ Ω	10 ⁶ Ω	Adjustable	10 (3M)	Blister card
608-611B-6				6 (1.5M)	

▶ 8PK-611W Replaceable Cordless Wrist Strap



- Cordless operation is not recommended for low humidity environment.
- For high humidity environment.



Band resistivity	Band size type	Individual packing
10 ³ ~10 ⁵ Ω	Adjustable	Blister card

▶ AS-501 Series Long Handle Static Brush



- Handle : Conductive p.p
- Resistivity : 10³~10⁹Ω
- Individual packing : Blister card



8PK-AS07-1 Field Service Kit



Model No.	8PK-AS07-1
Material	Conductive PVC
Resistivity	$10^9 \sim 10^{11} \Omega$
Wrist belt	With 6ft wrist strap and 10ft grounding wire w/bottom
Size(mm)	650x600
Individual packing	Color box

8BM-401A/8BM-405A/8BM-612A Static-Dissipative Mat

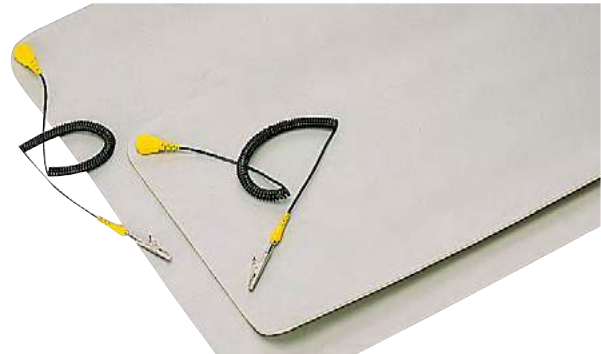

Model No.	8BM-401A	8BM-405A	8BM-612A
Material	Face layer: 0.2mm laminated PVC, Center layer: 1.7mm PVC foam, Bottom layer: 0.1mm PVC foam, Combination layer: conductive drug		
Resistivity	Face & Center & Bottom, Layers: $10M \sim 1KM \Omega/SQ$ Combination layer: $1K \sim 1M \Omega/SQ$, Static decay time: less than 0.5sec		
Description	Static dissipative mat for CPU	Static dissipative mat for keyboard & mouse & touch	Static dissipative mat for OA desk-top
Size(mm)	500x600	600x600	600x1200
Individual packing	Color box		

808-Q05 Foot & Heel Ground



These versatile heel grounders have a specially designed dual-layered cup construction for superior floor contact.



Polyester+
conductive fiber

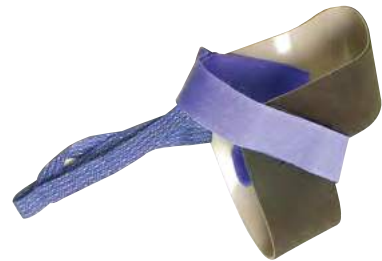

Resistivity	Wrist belt	Individual packing
$1 \sim 2 \times 10^9 \Omega$	Adjustable	Blister card

808-Q03-1 Anti-Dissipative Table Mat

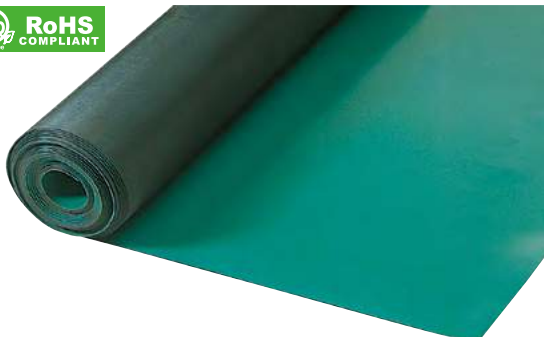

808-Q04-1 Static-Dissipative Floor Mat

Material	Resistivity	Size	Individual packing
Rubber	Top layers: $10^9 \sim 10^{10} \Omega$ Bottom layer: $10^4 \sim 10^6 \Omega$	10M x 1M Thickness: 2mm	Bulk

Material	Resistivity	Size	Individual packing
PVC	Top layers: $10^9 \sim 10^{11} \Omega$ Bottom layer: $10^4 \sim 10^6 \Omega$	10M x 1M Thickness: 2mm	Bulk

ESD STATIC PROTECTION

VDE INSULATION TOOLS



The great ability comes great responsibility. *Pro'sKit*® VDE series are nothing but trust-worthy.



Pro'sKit®

886-2-22183233
Sales support

pk@mail.prokits.com.tw
E-mail

www.prokits.com.tw
Global website

VDE 1000V Insulated Tools



Dielectric Strength Test

Individual immersion test at 10,000 Volt to guarantee safety working up to 1000 Volt.

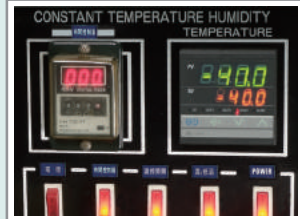

Low-temperature Impact Test

When the tools are cooled down to -40°C , proceed the insulated part with impact test. The insulation must retain the tough against breaking.

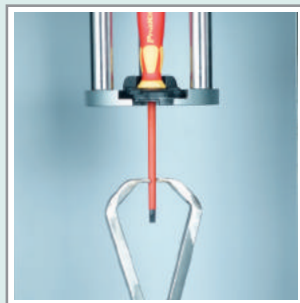
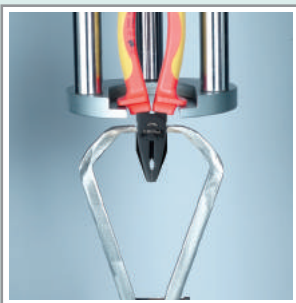

High-temperature Adhesive Power Test

After storage for 168 hours at 70°C , pull the insulated part with tensile force of 500Nm for 3 minutes. This test ensures that the insulation still stays firm and remain snug against the tool body.



Burning Behavior Test

Pro'sKit[®] insulated tools use flame-resistant plastics for insulation to protect users.

Pro'sKit[®] Insulation VDE Series come with high visibility molded ergonomic cushion handles for maximum comfort to ensure full force transfer through the grip. They also have been tested for dielectric strength under 10,000 Volt in a water bath in accordance with DIN EN 60900 (IEC 60900:2012) to encourage the users to trust a reliable insulation when live working up to 1000 Volt.

VDE tools are often used under extreme conditions, such as very low or very high temperature. Pro'sKit Insulation VDE Series are made from high grade materials, which have been tested by low-temperature impact test, high-temperature adhesive power test and burning test to offer more safety to users.



Safety Caution



- Please keep your insulated tools dry and clean.
- Wear protective goggles and gloves when working.
- Do not touch the non-insulated parts when working live.

VDE TOOLS

Insulated VDE Pliers



- Certified to IEC 60900, VDE, DIN 1,000V safety standards and bear GS sign.
- High visibility molded ergonomic cushion handle for maximum comfort.
- Hard chrome finished with PTFE coating for anti-rust protection.
- Drop forged from special tool steel.

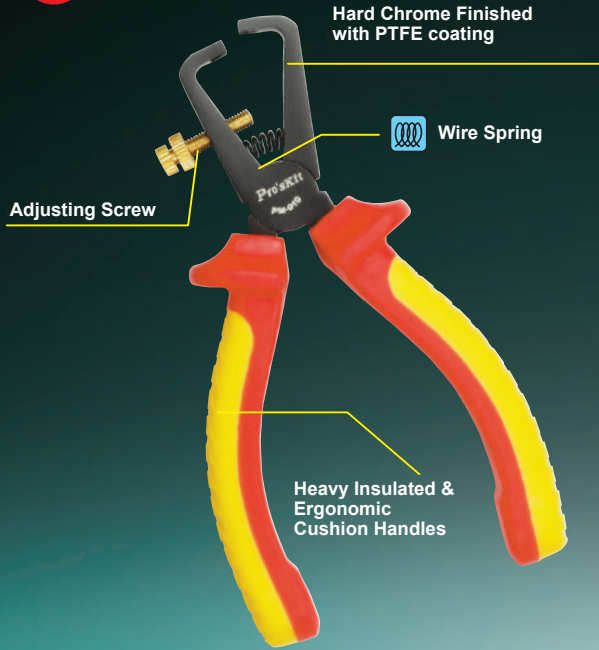

Individual packing: Blister card

▶ PM-918 Insulated Long Nose Plier



Material	HRC	Application		OAL. (mm)
	Body	Hard steel	Soft steel	
AISI 6150	46°±4°	Ø2.2mm	Ø3.2mm	200

▶ PM-919 Insulated Long Nose Plier



Material	HRC	Application		OAL. (mm)
	Body	Hard steel	Soft steel	
AISI 6150	46°±4°	Ø1.6mm	Ø2.5mm	170

▶ PM-910 Insulated Wire Stripping Plier



Material	HRC	Application		OAL. (mm)
	Body	Hard steel	Soft steel	
AISI 6150	46°±4°	Adjustable to accept conductors up to 10mm ² overall diameter		160

▶ PM-917 Insulated Side Cutter



Material	HRC	Application		OAL. (mm)
	Body	Hard steel	Soft steel	
AISI 6150	46°±4°	Ø2.0mm	Ø2.8mm	165

▶ PM-916 Insulated Heavy Duty Side Plier



Material	HRC	Application		OAL. (mm)
	Body	Hard steel	Soft steel	
AISI 6150	46°±4°	Ø2.7mm	Ø3.8mm	190

▶ PM-911 Insulated Combination Plier



Material	HRC	Application		OAL. (mm)
	Body	Hard steel	Soft steel	
AISI 6150	46°±4°	Ø2.5mm	Ø3.8mm	195

▶ PM-912 Insulated Combination Plier



Material	HRC	Application		OAL. (mm)
	Body	Hard steel	Soft steel	
AISI 6150	46°±4°	Ø2.0mm	Ø3.1mm	175

SR-V206 VDE 1000V Insulated Cable Cutter



- Precision ground, hardened blades.
- Chrome molybdenum alloy steel, forged, oil-hardened.

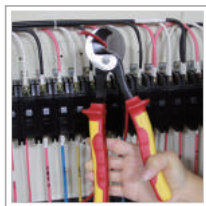

SR-V537 VDE 1000V Insulated Ratchet Cable Cutter



- Precision ground, hardened blades.
- High-grade carbon steel, forged, oil-hardened.
- Clean and smooth cutting without crushing and deformation.
- Ratcheted with safety release for force saving.



Ratchet drive for easier cutting

Model No.	Material	HRC		Application: for cutting copper and aluminum cables.			OAL. (mm)	Individual packing
		Body	Cutting edge	Diameter	Cross-sectional area	AWG		
SR-V206	Cr-Mo	43°±3°	50°±2°	Φ5.2 mm	22mm ²	4	150	Blister card
SR-V210	Cr-Mo	43°±3°	50°±2°	Φ10.0 mm	80mm ²	3/0	250	
SR-V537	65Mn	38°~43°	48°~52°	Φ32 mm	240mm ²	500	240	

SR-V336 VDE 1000V Insulated Electricians Scissors



- Dual color, non-slip, insulating ergonomic handle for maximum comfort.
- Stainless steel, oil-hardened.

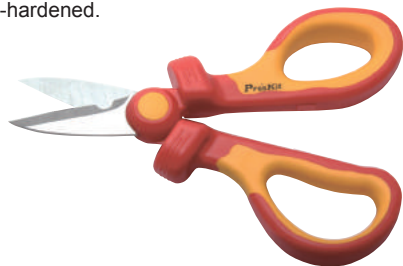

Material	HRC	Blade length	OAL.	Individual packing
AISI 420J2	48°~52°	47mm	160mm	Blister card

MS-V001 VDE 1000V Insulated Tape



Material	Width	OAL.	Individual packing
PVC	20mm	10m	Blister card

SD-800 Series Insulated VDE Screwdrivers / NUT Driver



- The insulation of the handle is molded directly onto the blade for permanent bonding.



High visibility molded ergonomic cushion grip handles



Heavy insulated shank

AISI 8660 Cr-Mo-V alloy steel
HRC:55'±2'

Model No.	Spec.	Blade length(mm)
SD-800-S2.5	⊖ 0.4x2.5	75
SD-800-S3.0	⊖ 0.5x3.0	100
SD-800-S4.0	⊖ 0.8x4.0	100
SD-800-S5.5	⊖ 1.0x5.5	125
SD-800-S6.5	⊖ 1.2x6.5	150
SD-800-S8.0	⊖ 1.2x8.0	175
SD-800-P0	⊕ #0	60
SD-800-P1	⊕ #1	80
SD-800-P2	⊕ #2	100
SD-800-P3	⊕ #3	150
SD-800-Z0	⊕ PZ0	60
SD-800-Z1	⊕ PZ1	80
SD-800-Z2	⊕ PZ2	100
SD-800-Z3	⊕ PZ3	150

Individual packing: Double blister card

Model No.	Spec.	Blade length(mm)
SD-800-M4.0	⊙ 4x2	125
SD-800-M5.0	⊙ 5x25	125
SD-800-M5.5	⊙ 5.5x25	125
SD-800-M6.0	⊙ 6x25	125
SD-800-M7.0	⊙ 7x25	125
SD-800-M8.0	⊙ 8x25	125
SD-800-M9.0	⊙ 9x25	125
SD-800-M10	⊙ 10x25	125
SD-800-M11	⊙ 11x25	245
SD-800-M12	⊙ 12x25	245
SD-800-M13	⊙ 13x25	245

Individual packing: Double blister card

Heavy insulated shank

Heavy duty deep head blade

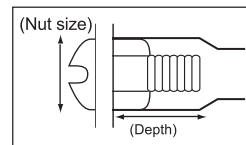

SD-8011 Insulated Screwdrivers Set

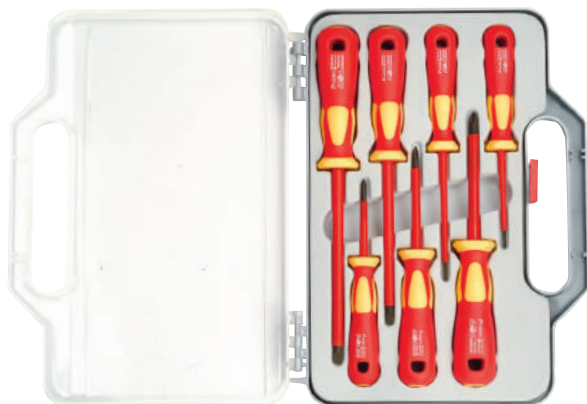

- 7 pieces set. VDE safety screwdriver set with Cr-Mo-V alloy.
- Steel AISI: 8660 blade.
- This essential kit is a must when working with electrical items.

Contents
⊖ SD-800-S2.5, SD-800-S3.0, ⊖ SD-800-S5.5, SD-800-S6.5, ⊕ SD-800-P0, SD-800-P1,SD-800-P2
Carrying case : 310x230x50mm
Individual packing: Inner box+Color label shrink

SD-T860 12 PCS VDE Torque Screwdriver Set



• VDE Handle

Dual color VDE torque handle, torque adjustable 1-6 Nm, Includes torque adjusting tool for torque setting easily. Insulated metal bit holder locks all bits reliably.

• 10 pcs Bits

Individually tested protective insulation 1000 VAC, VDE and GS tested. Includes 10pcs common use bits to satisfy most applications. Made by AISI 8660 Cr-Mo-V steel.

• Application

For controlled fastening on live cable or parts up to 1000VAC, such as power plants, refrigeration and air conditioning systems, electrical engineering installation and maintenance...etc.

• Durable Bag



Quick release design for speedy interchanging bit



Accurately torque adjustable 1 - 6 Nm

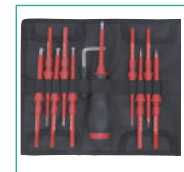

Rugged storage bag

Contents	
Torque adjustable: 1~6Nm, Accuracy±6%, recommend calibration after 5000 cycle	
Dual color PP/TPR/POM handle, length:127mm	
10pcs AISI 8660 Bits, length:195mm: ⊖ SL2.5, SL3.0, SL4.0, SL5.5, SL6.5, ⊕ PH0, PH1, PH2, ⊕ PZ0, PZ1	
Square 8mm torque adjusting tool, length:99mm/40mm	
Individual packing: Color box	

SD-315A Insulated Screwdriver Set



Blade material:
Slotted: AISI 6150 Cr-V steel.
Phillips: AISI 8660 Cr-Mo-V steel.

Contents	
⊖ 2.5x75	⊕ #0x75
⊖ 4.0x100	⊕ #1x100
⊖ 5.5x125	⊕ #2x100
⊖ 6.5x150	
Circuit testing screwdriver 190mm (100-250V)	
Individual packing: Color box	



8PK-8100E Insulated Screwdrivers Set

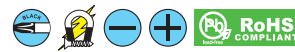

• Blade material: AISI 8660 Cr-Mo-V steel.

Contents	
⊖ 0.4x2.5x85	
⊖ 0.8x4.0x100	
⊖ 1.0x5.5x125	
⊖ 1.2x6.5x150	
⊕ #0x75	
⊕ #1x100	
⊕ #2x100	
Individual packing: Color box	



SD-9805 Insulated Precision Screwdriver Set



- Provide shock protection to 1000V AC.
- Meet VDE standards for safety to 1000V AC.
- Come complete with a plastic storage case.
- Material (Blade): AISI 8660 Cr-Mo-V steel.

Contents	O.A.L.(mm/inch)
⊖ 0.4x2.0x65mm(2.6")	165/6.5"
⊖ 0.23x1.5x65mm(2.6")	165/6.5"
⊖ 0.4x2.5x65mm(2.6")	165/6.5"
⊕ PH00x65mm(2.6")	165/6.5"
⊕ PH0x65mm(2.6")	165/6.5"
⊕ PH1x65mm(2.6")	165/6.5"
Carrying case : 195x184x28mm	
Individual packing: Shrink	



TZ-V3 Series VDE 1000V Insulated Tweezers



- Stainless steel with magnetic.



TZ-V302A Sharp tip

Gripping surfaces with matt finished for optimum grip



TZ-V302B Curved tip

Gripping surfaces with fine transverse serration



TZ-V302C Round point

Gripping surfaces with fine transverse serration



TZ-V302D Wide tip

Gripping surfaces with fine transverse serration

Model No.	Material	HRC	Width (mm)	OAL (mm)	Individual packing
TZ-V302A	AISI 304	35°~45°	15.6	134	Blister card
TZ-V302B			13.0	159	
TZ-V302C			13.0	160	
TZ-V302D			15.0	145	

HW-V6 Series VDE 1000V Insulated Adjustable Wrench



- Parallel smooth gripping jaw.
- With scaling for easy presetting.
- Chrome vanadium steel, forged, oil-hardened.



Model No.	Material	Jaw open (Max.) mm	Jaw depth (mm)	Jaw thickness (mm)	OAL (mm)	Individual packing
HW-V608	50CrV	30	25	12~8	200	Blister card
HW-V610		34	30	14~9	250	
HW-V612		41	36	17~11	300	

PD-V Series VDE 1000V Insulated Cable Knife



- Stainless steel, oil-hardened.
- Suitable for round cables and sector cables.
- Including protective cap for safe storage.



PD-V003A Straight blade type



PD-V003B Hook blade type



PD-V003C Sickle blade type



PD-V003D Hook blade sickle shaped type

Plastic coating the back of blade to avoid short circuits



PD-V004A Straight blade type

Plastic coating the back of blade to avoid short circuits

Model No.	Material	HRC	Blade length (mm)	Radius (mm)	OAL (mm)	Individual packing
PD-V003A	3Cr13	50°~58°	54	-	186	Blister card
PD-V003B			33	7	170	
PD-V003C			55	40	186	
PD-V003D			51	23.5	185	
PD-V004A			54	-	185	

HW-V8 Series VDE 1000V Insulated Hex Key Wrench



- Metric insulated Hex L-keys.
- S2 alloy steel, forged, oil-hardened.

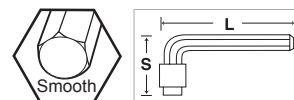
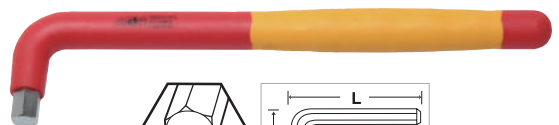

Model No.	Material	Tip Size (mm)	S±2 mm	L±2 mm	Individual packing
HW-V803	S2	3	25.0	130	Blister card
HW-V804		4	40.0	140	
HW-V805		5	45.5	160	
HW-V806		6	47.0	180	
HW-V808		8	50.5	200	
HW-V810		10	52.0	235	
HW-V812		12	60.0	260	

▶ HW-V1 Series VDE 1000V Insulated Single Open End Wrench



- 15° angled jaw.
- Chrome vanadium steel, forged, oil-hardened.

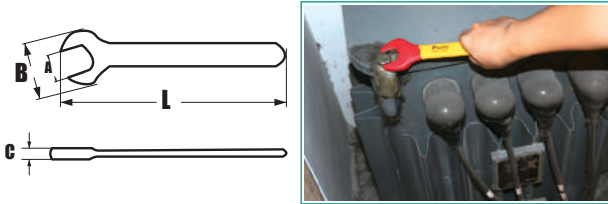

▶ HW-V2 Series VDE 1000V Insulated Single Box End Wrench



- Chrome vanadium steel, forged, oil-hardened.
- Cranked.

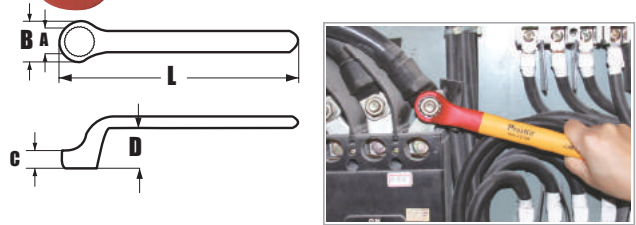

Model No.	Material	(A) Width across flats mm	(B) Head width Max. mm	(C) Head thickness Max. mm	(L) OAL ±2 mm	Individual packing
HW-V106B	50CrV	6	23	7.2	90	Blister card
HW-V107B		7	25	7.2	90	
HW-V108B		8	27	7.7	100	
HW-V109B		9	29	7.7	100	
HW-V110B		10	31	8.2	110	
HW-V111B		11	34	8.7	110	
HW-V112B		12	36	8.7	130	
HW-V113B		13	39	10.5	135	
HW-V114B		14	40	10.5	145	
HW-V115B		15	42	11.5	150	
HW-V116B		16	43	11.5	160	
HW-V117B		17	47	12.5	160	
HW-V118B		18	50	13.0	175	
HW-V119B		19	53	14.0	175	
HW-V121B		21	55	14.0	195	
HW-V122B		22	58	14.0	195	
HW-V124B		24	62	16.5	225	
HW-V127B	27	69	18.0	250		
HW-V130B	30	75	19.0	290		
HW-V132B	32	79	20.0	310		

Model No.	Material	(A) Width across flats mm	(B) Head width Max. mm	(C) Head thickness Max. mm	(D) Depth of crank mm	(L) OAL ±2 mm	Individual packing
HW-V206B	50CrV	6	16.0	6.8	25	150	Blister card
HW-V207B		7	18.0	7.0	25	150	
HW-V208B		8	19.0	7.4	27	155	
HW-V209B		9	20.0	8.3	27	155	
HW-V210B		10	21.0	8.8	30	170	
HW-V211B		11	22.5	8.9	30	170	
HW-V212B		12	22.5	9.8	32	190	
HW-V213B		13	26.5	10.0	32	190	
HW-V214B		14	28.0	11.0	34	205	
HW-V215B		15	29.0	11.1	34	205	
HW-V216B		16	31.0	11.5	36	215	
HW-V217B		17	32.0	12.3	36	215	
HW-V218B		18	35.0	12.7	37	230	
HW-V219B		19	36.0	13.2	37	230	
HW-V221B		21	39.0	13.9	41	245	
HW-V222B		22	41.0	13.9	41	245	
HW-V224B		24	44.0	16.0	42	265	
HW-V227B	27	48.0	16.4	42	290		
HW-V230B	30	52.0	16.8	45	310		
HW-V232B	32	55.0	17.5	45	310		

▶ PK-2811M 15 PCS 1000V Insulated Single Open End Wrench Set



- Contents: 15pcs single open end wrenches 6.7.8.9.10.11.12.13.14.15.16.17.19.22.24mm.
- Made of Chrome Vanadium Steel.
- With 600D tool roll bag.
- Complete set for power plant, HVAC, automotive, military, aircraft field applications and more.



600D tool roll bag:
305x635mm

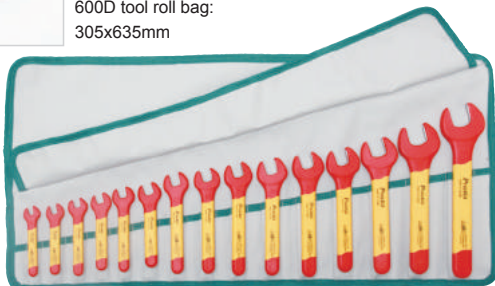

Individual packing: Color sleeve

▶ PK-2812M 15 PCS 1000V Insulated Single Box End Wrench Set



- Contents: 15pcs single box end wrenches 8.9.10.11.12.13.14.15.17.19.22.24.27.30.32mm.
- Made of Chrome Vanadium Steel.
- With 600D tool roll bag.
- Ideal for power plant, HVAC, automobile, military, aircraft field applications.



600D tool roll bag:
330x780mm

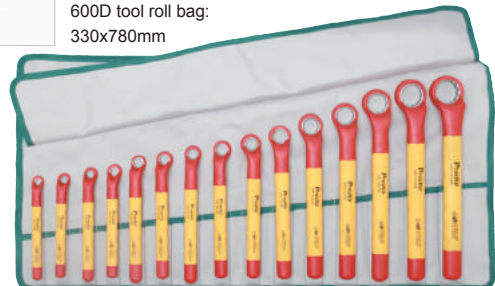

Individual packing: Color sleeve

HW-V708 HW-V710 VDE 1000V Insulated Reverse Flat Ratchet Handle



- Reversible for clockwise and anti-clockwise directions.
- Extremely smooth action.
- Quick, easy and reliable locking of attached sockets.
- Chrome vanadium steel, forged, oil-hardened.



Model No.	Material		Square drive	Teeth	OAL. (mm)	Individual packing
	Body	Square drive				
HW-V708	AISI 6140	42CrMo	3/8"	36	200	Blister card
HW-V710			1/2"	36	250	

SK-V3 Series VDE 1000V Insulated 3/8" Drive Socket



- 3/8" Square Drive.
- For metric hexagonal head screws.
- Chrome Vanadium steel.



Model No.	Material	Width across flats mm	Outside diameter Max. mm	Length mm	Individual packing
SK-V308B	50BV30	8	15.1	28.0	Blister card
SK-V310B		10	18.7	28.0	
SK-V311B		11	20.0	28.0	
SK-V312B		12	21.2	28.0	
SK-V313B		13	22.5	28.0	
SK-V314B		14	23.7	28.0	
SK-V316B		16	26.2	28.0	
SK-V317B		17	27.5	28.0	
SK-V318B		18	28.7	28.0	
SK-V319B		19	30.0	30.0	
SK-V321B		21	32.5	30.0	
SK-V322B		22	33.7	30.0	

SK-V732 SK-V752 VDE 1000V Insulated T Handle



- Quick, easy and reliable locking of attached sockets.
- Chrome vanadium steel, forged, oil-hardened.



Model No.	Material	Square drive	Handle length (mm)	Drive length (mm)	Individual packing
SK-V732	50BV30	3/8"	160	200	Blister card
SK-V752		1/2"	160	200	

SK-V8 Series VDE 1000V Insulated Extension Bar



- With internal and external square.
- Quick, easy and reliable locking of attached sockets.
- Chrome vanadium steel, forged.



Model No.	Material	Square drive	OAL. (mm)	Individual packing
SK-V831	50BV30	3/8"	125	Blister card
SK-V832		3/8"	250	
SK-V851		1/2"	125	
SK-V852		1/2"	250	

SK-V4 Series VDE 1000V Insulated 1/2" Drive Socket



- 1/2" Square Drive
- For metric hexagonal head screws.
- Chrome Vanadium steel.



Model No.	Material	Width across flats mm	Outside diameter Max. mm	Length mm	Individual packing
SK-V410B	50BV30	10	19.5	38.0	Blister card
SK-V411B		11	20.7	38.0	
SK-V412B		12	22.0	38.0	
SK-V413B		13	23.2	38.0	
SK-V414B		14	24.5	38.0	
SK-V416B		16	27.0	38.0	
SK-V417B		17	28.2	38.0	
SK-V418B		18	29.5	38.0	
SK-V419B		19	30.7	38.0	
SK-V421B		21	33.2	38.0	
SK-V422B		22	34.5	38.0	
SK-V424B		24	37.0	38.0	
SK-V427B		27	38.8	42.0	
SK-V430B		30	42.8	42.0	
SK-V432B	32	44.8	42.0		

PK-2801 1000V Insulated Screwdriver & Plier Set



Contents	
SD-800-S2.5	⊖ 0.4x2.5x75mm
SD-800-S3.0	⊖ 0.5x3.0x100mm
SD-800-S5.5	⊖ 1.0x5.5x125mm
SD-800-P1	⊕ PH1x80mm
SD-800-P2	⊕ PH2x100mm
PM-910	Insulated wire stripping plier (160mm)
PM-917	Insulated side cutter (160mm)
PM-919	Insulated long nose plier (160mm)
9ST-33	Tool bag (255x172.5x55mm)
Individual packing	Inner box & Color label shrink



PK-2802 1000V Insulated Plier & Screwdriver Set



Contents	
SD-800-S2.5	⊖ 0.4x2.5x75mm
SD-800-S4.0	⊖ 0.8x4.0x100mm
SD-800-S5.5	⊖ 1.0x5.5x125mm
SD-800-S6.5	⊖ 1.2x6.5x150mm
SD-800-P0	⊕ PH0x60mm
SD-800-P1	⊕ PH1x80mm
SD-800-P2	⊕ PH2x100mm
PM-911	Insulated combination plier (200mm)
PM-917	Insulated side cutter (160mm)
PM-918	Insulated long nose plier (200mm)
PM-919	Insulated long nose plier (160mm)
9Z-PK2802	Zipper carrying bag (294x240x50mm)
Individual packing	Inner box & Color label shrink



PK-2809M 1000V Insulated Metric Tool Kit



PK-2809M tool kit is equipped with a range of 26pcs 1000V insulated single open end wrenches, screwdrivers, pliers and cutters, T handle and 1/2" sockets in a durable tool box. Ideal for power plant, HVAC, automotive, military, aircraft field applications and more

Contents	
PM-911	Insulated combination plier (195mm)
PM-917	Insulated side cutter(165mm)
HW-V110B	Insulated single open end wrench 10mm
HW-V111B	Insulated single open end wrench 11mm
HW-V112B	Insulated single open end wrench 12mm
HW-V113B	Insulated single open end wrench 13mm
HW-V114B	Insulated single open end wrench 14mm
HW-V117B	Insulated single open end wrench 17mm
HW-V119B	Insulated single open end wrench 19mm
SD-800-S2.5	⊖ Insulated screwdriver(-2.5x75)
SD-800-S3.0	⊖ Insulated screwdriver(-3.0x100)
SD-800-S4.0	⊖ Insulated screwdriver(-4.0x100)
SD-800-S5.5	⊖ Insulated screwdriver (-5.5x125)
SD-800-P0	⊕ Insulated screwdriver (#0x60)
SD-800-P1	⊕ Insulated screwdriver (#1x80)
SD-800-P2	⊕ Insulated screwdriver (#2x100)
SK-V752	Insulated 1/2" drive T handle 200mm
SK-V410B	Insulated 1/2" drive socket 10mm
SK-V411B	Insulated 1/2" drive socket 11mm
SK-V412B	Insulated 1/2" drive socket 12mm
SK-V413B	Insulated 1/2" drive socket 13mm
SK-V414B	Insulated 1/2" drive socket 14mm
SK-V417B	Insulated 1/2" drive socket 17mm
SK-V419B	Insulated 1/2" drive socket 19mm
PD-V003A	Insulated straight blade cable knife 50x180mm
PD-V003B	Insulated hook blade cable knife 28x155mm
9SB-3935	Plastic tool box (390x350x90mm)
Individual packing	Color sleeve



PK-2803AM / PK-2803BM 1000V Insulated Tool Kit



Model No.	Soldering voltage	Standard plug
PK-2803AM (Metric)	110V	A
PK-2803BM(Metric)	220~240V	B

Contents	
MT-1250	Professional 3-1/2 digital multimeter
8PK-366N-G	Desoldering pump
PM-912	Insulated combination plier (160mm)
PM-917	Insulated side cutter (160mm)
PM-919	Insulated long nose plier (160mm)
HW-121M	8 pcs folding hex key set
9IT	PVC insulated tape
1PK-362D	Soldering stand-single spring
SD-800 Series	⊕ VDE 1000V insulated screwdriver (PH0x60) , (PH1x80), (PH2x100)
	⊖ VDE 1000V insulated screwdriver (2.5x75), (4.0x100), (5.5x125), (6.5x150)
9SD-9805 Series	⊕ Insulated precision screwdriver (PH0x65), (PH00x65), (PH1x65)
	⊖ Insulated precision screwdriver (0.23x1.5X65), (0.4x2.0x65), (0.4x2.5x65)
SI-130A-20 SI-124B-30	Ceramic Soldering iron 120V or 220V
9SN-310G	Lead free solder wire (Sn 99.3, Cu 0.7)
SD-328H	Screwdriver probe voltage tester (AC110~250V)
ST-13S	Tool bag (385x295x65mm)
Individual packing	Inner box & Color label shrink

PK-2807A/PK-2807B 1000V Insulated Tool Kit



Model No.	Soldering voltage	Standard plug
PK-2807A	110V	A
PK-2807B	220~240V	B

PK-2807A /PK-2807B contents	
1PK-H026	Adjustable wrench-6"
203-132E	Utility component storage box (O.D.:200x135x39mm)
8PK-025	7pcs Ball-point hex key set (2.5,3,4,5,6,8,10mm)
8PK-366NA	Desoldering pump
908-T301	2Pcs tweezer set
DK-2039	Utility knife (3 Blades Self Loading)
DK-2047N	Electrician's scissors (145mm)
MT-1232	3 3/4 Autorange digital multimeter
PM-910	Insulated wire stripping plier (160mm)
PM-911	Insulated combination plier (195mm)
PM-917	Insulated side cutter (165mm)
PM-918	Insulated long nose plier (200mm)
SD-328H	Screwdriver probe voltage tester (AC 110~250V)
SD-800 Series	⊕ VDE 1000V insulated Screwdriver (#1x80), (#2x100)
	⊖ VDE 1000V insulated Screwdriver (-3.0x100), (-5.5x125)
SH-1025	Soldering tip cleaner
SI-130A-20 SI-130B-20	Ceramic Soldering Iron (110V or 220V)
9ST-13	Tool bag (385x300x55mm)
Individual packing	Inner box & color label shrink

PK-2813M 1000V Insulated Roll Tool Set



Contents	
PM-911	Insulated combination plier (195mm)
PM-917	Insulated side cutter(165mm)
PM-910	Insulated wire stripping plier (160mm)
PM-918	Insulated long nose plier(200mm)
SR-V206	Insulated cable cutter 150mm (22mm ²)
HW-V110B	Insulated single open end wrench 10mm
HW-V113B	Insulated single open end wrench 13mm
HW-V114B	Insulated single open end wrench 14mm
HW-V117B	Insulated single open end wrench 17mm
HW-V119B	Insulated single open end wrench 19mm
SD-800-S2.5	⊖ Insulated screwdriver(-2.5x75)
SD-800-S4.0	⊖ Insulated screwdriver(-4.0x100)
SD-800-S5.5	⊖ Insulated screwdriver (-5.5x125)
SD-800-S6.5	⊖ Insulated screwdriver (-6.5x150)
PD-V003A	Insulated straight blade cable knife 50*180mm
9Z-PK2813	Tool roll bag
Individual packing	Color sleeve

PK-2836M 1000V Insulated Metric Tool Kit



PK-2836M tool kit is equipped with a range of 41pcs 1000V insulated single open end wrenches, single box end wrenches, adjustable wrenches, screwdrivers, knife, pliers and cutters, T handle, and 1/2" sockets in a durable aluminum frame tool case. Ideal for power plant, HVAC, automotive, military, aircraft field applications and more.



Contents	
PM-911	Insulated combination plier (195mm)
PM-917	Insulated side cutter(165mm)
PM-910	Insulated wire stripping plier (160mm)
SR-V210	Insulated cable cutter 250mm (80mm ²)
HW-V110B	Insulated single open end wrench 10mm
HW-V113B	Insulated single open end wrench 13mm
HW-V114B	Insulated single open end wrench 14mm
HW-V117B	Insulated single open end wrench 17mm
HW-V119B	Insulated single open end wrench 19mm
HW-V122B	Insulated single open end wrench 22mm
HW-V210B	Insulated single box end wrench 10mm
HW-V213B	Insulated single box end wrench 13mm
HW-V214B	Insulated single box end wrench 14mm
HW-V217B	Insulated single box end wrench 17mm
HW-V219B	Insulated single box end wrench 19mm
HW-V222B	Insulated single box end wrench 22mm
SD-800-S2.5	⊖ Insulated screwdriver(-2.5×75)
SD-800-S4.0	⊖ Insulated screwdriver (-4.0×100)
SD-800-S5.5	⊖ Insulated screwdriver (-5.5×125)
SD-800-S6.5	⊖ Insulated screwdriver (-6.5×150)
SD-800-P1	⊕ Insulated screwdriver (#1×80)
SD-800-P2	⊕ Insulated screwdriver (#2×100)
SK-V752	Insulated 1/2" drive T handle 200mm
HW-V710	Insulated 1/2" drive reverse flat ratchet handle 250mm
SK-V851	Insulated 1/2" drive extension bar 125mm
SK-V852	Insulated 1/2" drive extension bar 250mm
SK-V410B	Insulated 1/2" drive socket 10mm
SK-V411B	Insulated 1/2" drive socket 11mm
SK-V412B	Insulated 1/2" drive socket 12mm
SK-V413B	Insulated 1/2" drive socket 13mm
SK-V414B	Insulated 1/2" drive socket 14mm
SK-V416B	Insulated 1/2" drive socket 16mm
SK-V417B	Insulated 1/2" drive socket 17mm
SK-V418B	Insulated 1/2" drive socket 18mm
SK-V419B	Insulated 1/2" drive socket 19mm
SK-V422B	Insulated 1/2" drive socket 22mm
SK-V424B	Insulated 1/2" drive socket 24mm
PD-V003A	Insulated straight blade cable knife 50×180mm
SR-V336	Insulated electricians scissors 160mm
MS-V001	Insulated tape 20mm×10M
HW-V610	Insulated 10" adjustable wrench
TC-736	Expert & Elegant aluminum frame tool case (486x325x159mm)
9PK-2836M-TP	Top pallet for PK-2836M
9PK-2836M-P	Pallet for PK-2836M
Individual packing	Plain box + color label

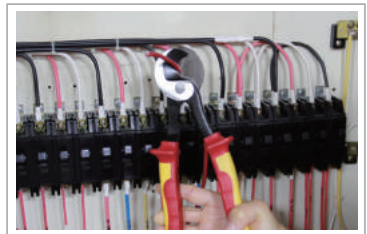
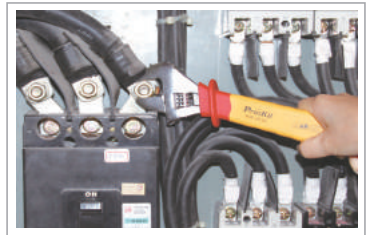

VDE TOOLS

SOLAR TOOLS



Clean energy requires quality tools to support.
Pro'sKit® is a friend that you can trust.



PK-2061 Solar MC3 & MC4 Crimping Tool kit



To open the locking device

To secure

To tighten the cable gland

Includes 2 pcs MC4 and MC4 PLUS open-end spanners and unlocking tools help you opening the locking device, securing and tightening the cable gland.



Specification

CP-3006F	Parallel action crimper frame
CP-5S1D	Die set for MC 3 solar connector (Multi-Contact) & 2.5/4/6mm ² (AWG 14/12/10) solar cable.
CP-5S2D	Die set for MC 4 solar connector (Multi-Contact) & 2.5/4/6mm ² (AWG 14/12/10) solar cable.
CP-246	Universal solar cable stripper, for 2.5/4/6mm ² (AWG 14/12/10) solar cable
8PK-A202	Forged cable cutter (160mm), for copper cable: 25mm ² flexible
9HW-MC4	2 pcs open-end spanner and unlocking tool (MC4 and MC4 PLUS)
9SD-202A	Pro-soft screwdriver 5x75mm
9SD-207B	Pro-soft screwdriver #2 x100mm
9Z-940KP	Zippered carrying bag(280×197×70mm)
Individual packing	Color Label Shink Parking

CP-3006FS1 / CP-3006FS2 Parallel Action Crimping Tool



Perfect fit for open barrel terminal and solar connectors

- **Reliable:** Parallel action crimping performance is consistent and accurate.
- **Practical:** Safety crimp release helps to eliminate rejected terminations due to incorrect positioning.
- **Comfortable:** Ergonomically shaped non-slip TPR handle for comfortable use in all conditions.
- **Versatile:** Interchangeable die sets for wide range of applications.

Body	Material	Handle	HRC	OAL.(mm)	Individual packing
S50C		TPR	45°±3°	254	Blister card

Model No.	Description	Die set	Crimp die profile	Application	Terminals
CP-3006FS1	Crimper frame with die set			For MC 3 solar connector (Multi-Contact) & 2.5/4.0/6.0 mm ² (AWG 14/12/10) solar cable AWG 14/12/10 DIN 2.5/4.0/6.0 mm ²	
CP-3006FS2				For MC 4 solar connector (Multi-Contact) & 2.5/4.0/6.0 mm ² (AWG 14/12/10) solar cable AWG 14/12/10 DIN 2.5/4.0/6.0 mm ²	



1PK-3003F Ergo-Lunar Crimper Frame



- **Decreases** work-related injuries.
- **Increases** productivity.
- Superior mechanical gain design.
- Interchangeable die sets for wide range of applications.

Material	HRC	OAL.(mm)	Individual packing
S45C	45°±3°	260	Blister card

Replacement die set	Description	Die set	Crimp die profile	Application	Crimp size	Terminals
CP-5S1D	Die only			For MC 3 solar connector (Multi-Contact) & 2.5/4.0/6.0 mm ² (AWG 14/12/10) solar cable	AWG 14/12/10 DIN 2.5/4.0/6.0 mm ²	
CP-5S2D				For MC 4 solar connector (Multi-Contact) & 2.5/4.0/6.0 mm ² (AWG 14/12/10) solar cable	AWG 14/12/10 DIN 2.5/4.0/6.0 mm ²	

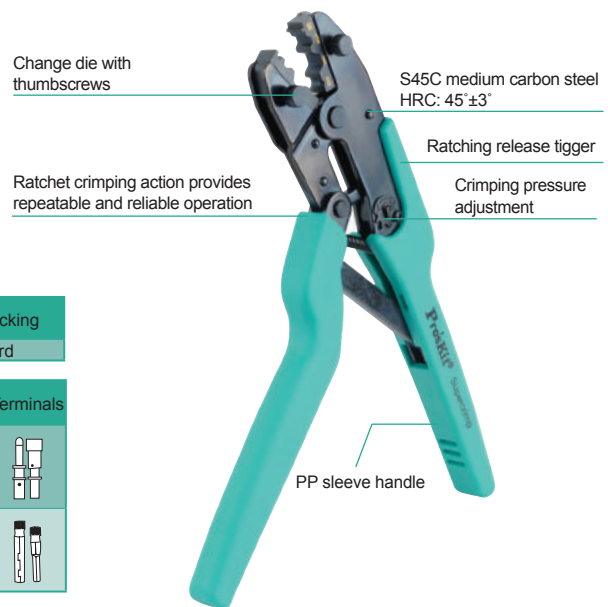

CP-246 Solar Cable Stripper



- Reliable stripping without damage, particularly for solar cables (2.5- 6.0 mm²)
- With adjustable length stop for accurate stripping length setting.

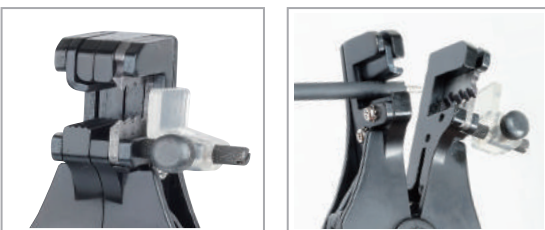

Body	Material	Blade	Handle	HRC	Application	OAL.(mm)	Individual packing
Zinc alloy		SK5	TPR	56°±2°	For 2.5/4/6mm ² (AWG 14/12/10) solar cable	177	Blister card



PRECISION TWEEZERS



Tweezers are little more than two pieces of metal stuck together. Finding the perfect tweezers is not as easy as initially thought. *Pro'sKit*® offers the right option to simplify your work.

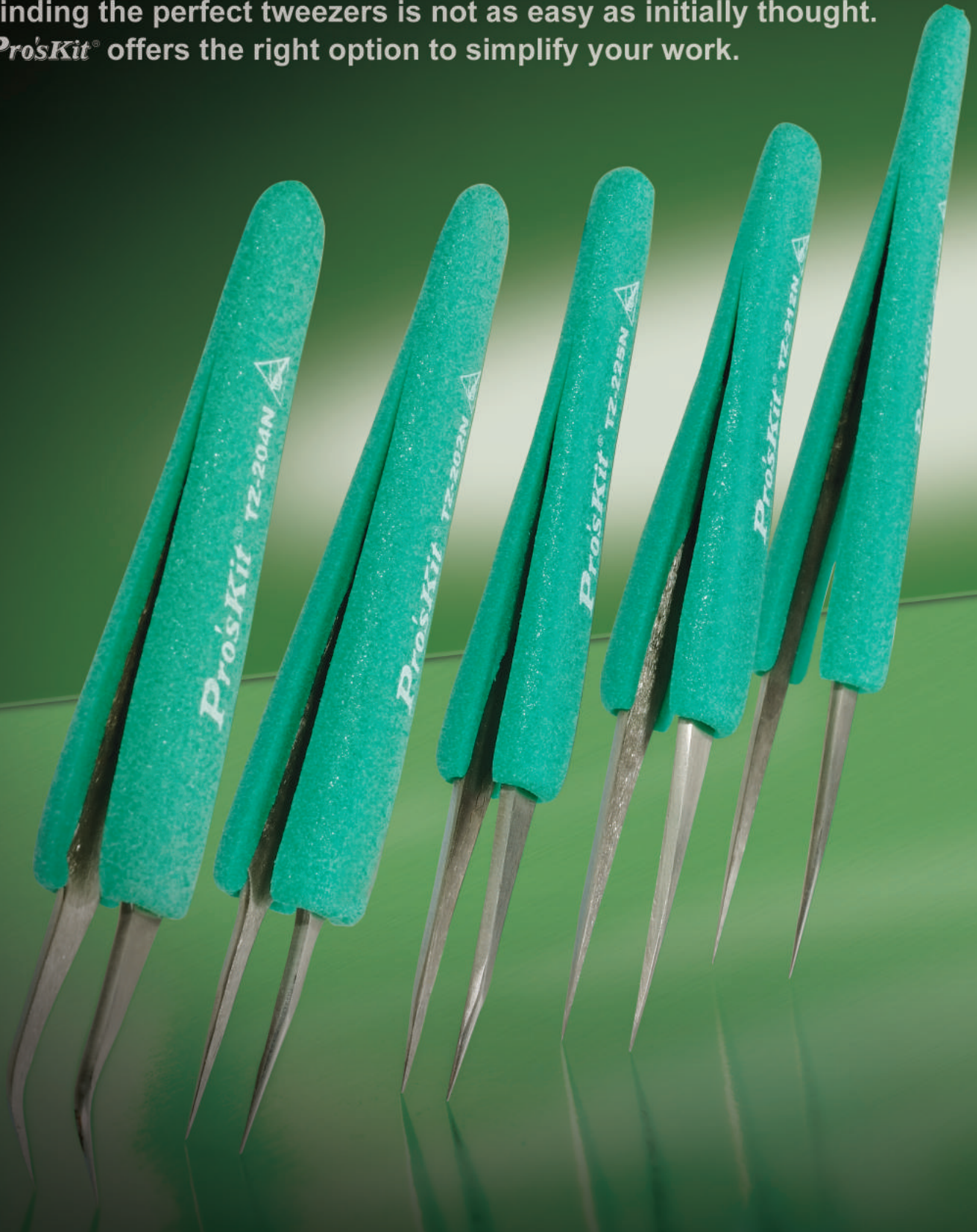

Pro'sKit®

886-2-22183233
Sales support

pk@mail.prokits.com.tw
E-mail

www.prokits.com.tw
Global website

ERGO-GRIP TWEEZER



- Static dissipative handle $10^9 \sim 10^{11}$
- Light weight design
- Precise tip offers safe access to hard-to-reach areas

- Cushioned handle increases operation comfort with less fatigue
- Constructed of high-quality stainless, chemical resistant tough, non-magnetic surface.

TZ-202N Super Fine Tip Straight Tweezer

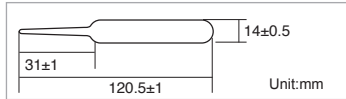

Material	Magnetic	OAL.(mm)	Individual packing
AISI 304	Non	120.5	Blister card

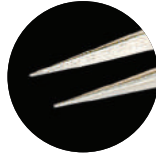

TZ-204N Fine Tip Curved Tweezer

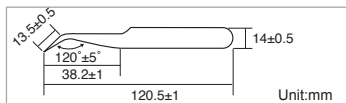

Material	Magnetic	OAL.(mm)	Individual packing
AISI 304	Non	120.5	Blister card



TZ-205N Fine Tip Straight Tweezer

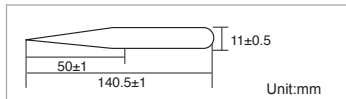

Material	Magnetic	OAL.(mm)	Individual packing
AISI 304	Non	140.5	Blister card

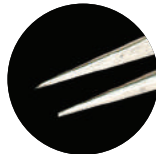

TZ-212N Extremely Fine And Sharp Tip Tweezer

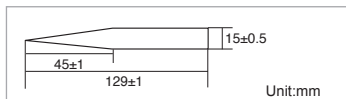

Material	Magnetic	OAL.(mm)	Individual packing
AISI 304	Non	129	Blister card

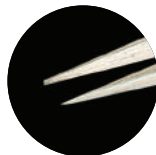

TZ-225N Super Fine Tip Straight Tweezer

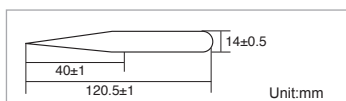

Material	Magnetic	OAL.(mm)	Individual packing
AISI 304	Non	120.5	Blister card



PRECISION
TWEEZERS

SMD TWEEZERS SERIES



- Ideal for handling highly complex SMD rework
- Precise tip meets the shape of chip parts

- Made of AISI 304 stainless steel, non-magnetic surface, anti-corrosive, less wear for long time.

▶ 1PK-TZ001 SMD Tweezer

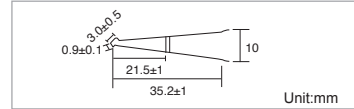

Material	Magnetic	OAL.(mm)	Individual packing
AISI 304	Non	120	Blister card

▶ 1PK-TZ002 SMD Tweezer

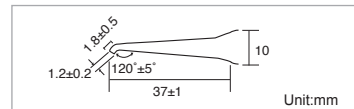

Material	Magnetic	OAL.(mm)	Individual packing
AISI 304	Non	120	Blister card

▶ 1PK-TZ003 SMD Tweezer

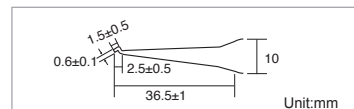
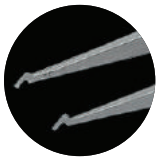

Material	Magnetic	OAL.(mm)	Individual packing
AISI 304	Non	120	Blister card

▶ 1PK-TZ004 SMD Tweezer

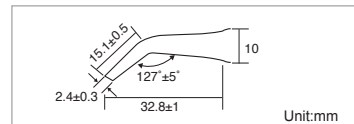

Material	Magnetic	OAL.(mm)	Individual packing
AISI 304	Non	120	Blister card

▶ 1PK-TZ005 SMD Tweezer

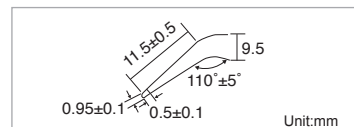

Material	Magnetic	OAL.(mm)	Individual packing
AISI 304	Non	115	Blister card

PRECISION TWEEZERS

▶ 1PK-101T Insulated Tweezer

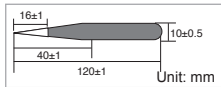

Material	Magnetic	OAL.(mm)	Individual packing
AISI 304	Non	120	Blister card

▶ 1PK-110T Cutting Tweezer

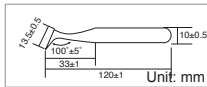

Material	Magnetic	OAL.(mm)	Individual packing
AISI 304	Non	120	Blister card

▶ 1PK-102T Super Fine Tip Straight Tweezer

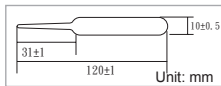

Material	Magnetic	OAL.(mm)	Individual packing
AISI 304	Non	120	Blister card

▶ 1PK-112T Extremely Fine And Sharp Tip Tweezer

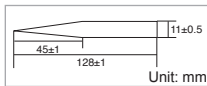

Material	Magnetic	OAL.(mm)	Individual packing
AISI 304	Non	128	Blister card

▶ 1PK-104T Fine Tip Curved Tweezer

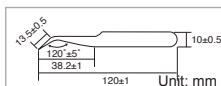

Material	Magnetic	OAL.(mm)	Individual packing
AISI 304	Non	120	Blister card

▶ TZ-116 Blunt Flat Tip Tweezer

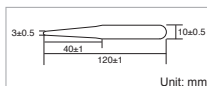

Material	Magnetic	OAL.(mm)	Individual packing
AISI 304	Non	120	Blister card

▶ 1PK-105T Fine Tip Straight Tweezer

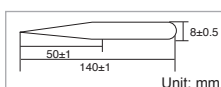

Material	Magnetic	OAL.(mm)	Individual packing
AISI 304	Non	140	Blister card

▶ 1PK-125T Super Fine Tip Straight Tweezer

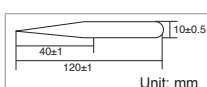

Material	Magnetic	OAL.(mm)	Individual packing
AISI 304	Non	120	Blister card

PRECISION
TWEEZERS

▶ 1PK-123T Heavy-Duty Tweezer

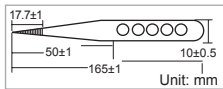

Material	Magnetize-able	OAL.(mm)	Individual packing
AISI 410	Yes	165	Blister card

▶ 1PK-106T Universal Tweezer

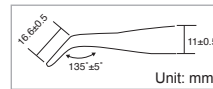

Material	Magnetize-able	OAL (mm)	Individual packing
AISI 410	Yes	175	Blister card

▶ 1PK-117T Cross Leg Soldering Tweezer

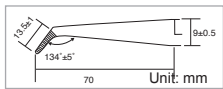

Material	Magnetize-able	OAL.(mm)	Individual packing
AISI 410	Yes	164	Blister card

▶ 1PK-108T Reverse Action Tweezer

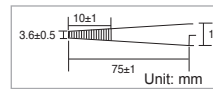

Material	Magnetize-able	OAL.(mm)	Individual packing
AISI 410	Yes	165	Blister card

▶ 1PK-118T Heavy Duty Tweezer

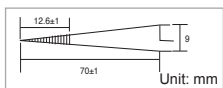

Material	Magnetize-able	OAL.(mm)	Individual packing
AISI 410	Yes	165	Blister card

▶ 1PK-119T Point Tweezer

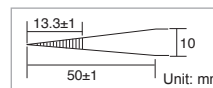

Material	Magnetize-able	OAL.(mm)	Individual packing
AISI 410	Yes	200	Blister card

▶ 1PK-115T Long Nose Tweezer

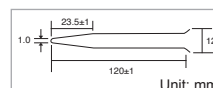

Material	Magnetize-able	OAL. (mm)	Individual packing
AISI 410	Yes	200	Blister card

▶ 1PK-TZ Series Optical Tweezer



1PK-TZ015



1PK-TZ017



1PK-TZ019

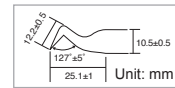
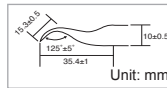
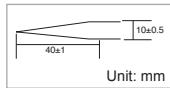

Model No.	Material	Magnification	Diameter	Magnetic	OAL. (mm)	Individual packing
1PK-TZ015	AISI 304	3x	ø32mm	Non	120	Blister card
1PK-TZ017						
1PK-TZ019						

▶ 808-389 4 PCS Tweezer Set



OAL:115mm

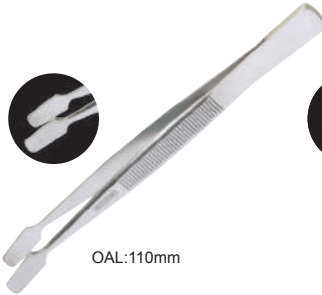

OAL:110mm

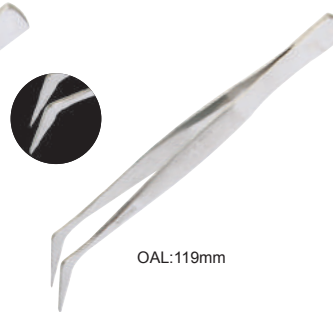

OAL:119mm

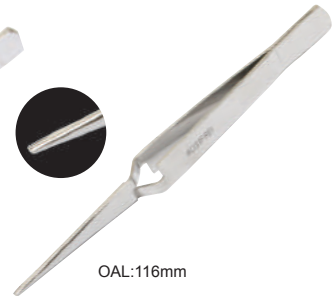

OAL:116mm

4 different style stainless steel tweezers for every need. Includes one self-locking; ideal for picking up small components in hard to reach places as well as component assembly one pc prototype boards.

Model No.	Material	Magnetize-able	OAL.(mm)	Individual packing
808-389	AISI 430	Yes	110~120	Pouch

▶ 908-T301 2 PCS Tweezer Set



2 pcs economic type tweezers with insulated coating handle.

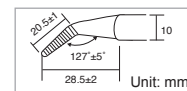
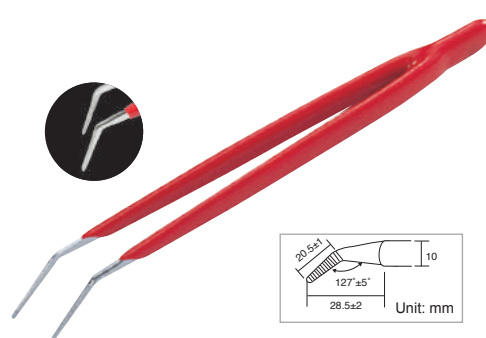
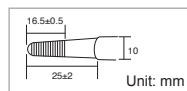
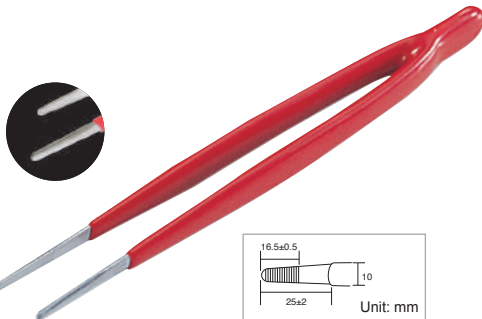

Model No.	Material	Magnetize-able	OAL. (mm)	Individual packing
908-T301	AISI 430	Yes	145	Blister card

TZ-300A / TZ-300B Static Dissipative Soft Tip Tweezer



Model No.	Material		Resistance	Replacement tip	Magnetic	OAL. (mm)	Individual packing
	Handle	Tip					
TZ-300A	AISI 302	PPS-hb	<math><10^6\Omega</math>	5TZ-300A	Non	130	Blister card
TZ-300B				5TZ-300B		125	

TZ-100 Series Conductive Tweezer



Model No.	Material	Resistance	Magnetic	OAL.(mm)	Individual packing
TZ-100A	PC + Carbon fiber	<math><10^6\Omega</math>	Non	115±2	Blister card
TZ-100B				120±2	
TZ-100C				115±2	
TZ-100D				118±2	

TZ-121 Ceramic Tip Tweezer



- Replaceable tips screw on stainless body.
- Made of fine ceramic (Zirconium) materials with non-magnetic surface.
- Ergonomic handle design with 0.5 mm tip makes the tweezers ideal for accessing in confined areas.
- Chemical-resistant.
- Heat-resistant.
- Anti-magnetic.

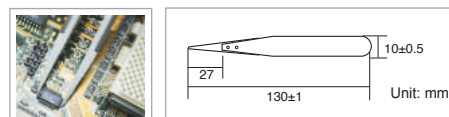

Material Handle	Material Tip	Replacement tip	Magnetic	OAL. (mm)	Individual packing
AISI 302	Ceramic (Zirconia)	9TZ-121-BIT	Non	130	Blister card + PP box with black EVA

PRECISION TWEEZERS

MAGNIFIER & LAMP



Protect your eyes. Broaden your view.



Pro'sKit[®]

886-2-22183233
Sales support

pk@mail.prokits.com.tw
E-mail

www.prokits.com.tw
Global website

Magnifier & Lamp

The materials of Pro'sKit® magnifier & lamps include Glass and Acrylic.

The characters of Glass:

- **Scratch-resistance:** The glass is not easy scratched due to their high density.
- **High-transmission:** It comes with smooth surface providing high transmission for clear view, anti-dust.
- **Low-glare:** The glass Lens feature low glare to reduce eye fatigue when used for long times.

The characters of Acrylic:

- **Light-weight:** The weight of Acrylic is only half of glass.
- **Anti-impact:** The impact strength of Acrylic is 7-18 times higher than that of glass.
- **High-transmission:** It has the excellent transparent materials at present, and transmission is better than glass.



Glass Lens



Acrylic Lens

The light source and electronic rectifier:

Pro'sKit® is always striving to improve its products to become more energy efficient and environmentally-friendly. All of Pro'sKit® magnifiers & lamps come with Electronic Rectifier, reducing the electromagnetic interference to almost zero and meet RoHS compliance. The Electronic Rectifier will provide even more stable performance and lights up more quickly for use than the traditional linear transformer.



LED LAMP Series

Pro'sKit® magnifier & lamp series is almost integrated to be LED light source for energy saving and environment protection. The series will feature you the following benefits:

- **50,000 Working Hours**
- **20 X Longer Lifetime** than incandescent lamp
- **80% Energy Saving** than incandescent lamp

Magnification chart of Pro'sKit® Magnifiers & Lamps:

- **Diopter(D)** is a measurement unit of the refractive power of a lens. Each diopter means an object has been magnified by 25%.
- **Magnification(X)** is a measurement of how much larger an object is after magnification. A power of 2x means the object size has been magnified by 100%.
- **Focal Length** is the distance from a point where the image of a distance object is formed (focal point) to lens

Diopter	% Bigger Than Object	Magnification (X)	Focal Length mm(in)
1 D	25%	1.25 X	1016 (40.00")
2 D	50%	1.5 X	508 (20.00")
3 D	75 %	1.75 X	339 (13.33")
4 D	100 %	2.00 X	254 (10.00")
5 D	125 %	2.25 X	203 (8.00")
6 D	150 %	2.50 X	169 (6.67")
7 D	175%	2.75X	145(5.71")
8 D	200 %	3.00 X	127 (5.00")
9 D	225 %	3.25 X	113 (4.44")
10 D	250 %	3.50 X	102 (4.00")
12 D	300 %	4.00 X	85 (3.33")
20 D	500 %	6.00 X	51 (2.00")
28 D	700 %	8.00 X	36 (1.43")
30 D	750 %	8.50 X	34 (1.33")

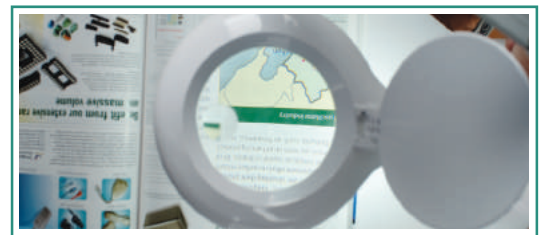
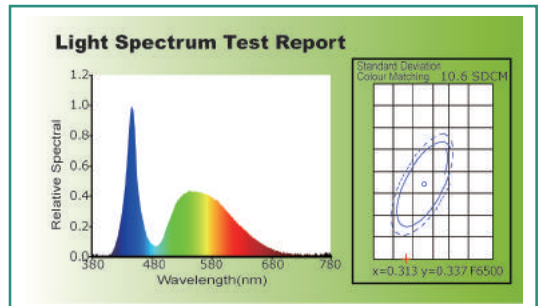

Caring for Eye Care

When you are doing any of these things which require staring at one place for 30 minutes, it is important to take a break for 5 minutes and look at things farther away.

MAGNIFIER & LAMP

MA-1008A MA-1008F LED Magnifier Floor Lamp



1.75X Magnification Easy Angle Adjustment

- Comes with floor stand, with 180 degree rotating bending lamp, even in sofa, bed or table allows to use for reading or a job
- Unique gooseneck arm allows angling and pointing the light position easily and safely
- Ideal for professional, home, beauty or hobby use, great reading, nail art, product quality inspection and visual aid.

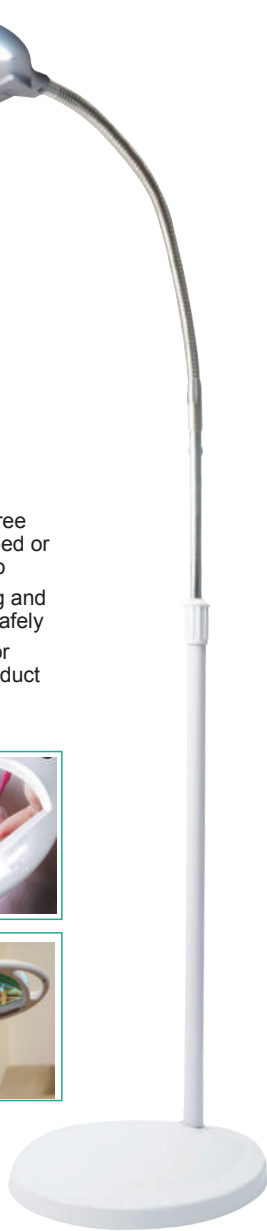

Model No.	MA-1008A	MA-1008F
Main unit	Light source	42pcs SMD LEDs
	Energy consumption	7 W
	Color temperature	6000~7000 Kelvin
	Luminance	about 450 lm
	Magnification	3D (1.75X)
	Lens material	Glass
Switching adapter	Lens size	100x167mm
	Input	110~120V AC 50/60Hz
	Output	DC21V 0.26A
	Plug type	A (I) F (II)
	Material	Spray painted steel tubing
Weight	6.5Kgs	
Accessories	Lamp shade, adapter, hex key & floor stand	
Individual packing	Color box	

MA-1209LA MA-1209LI LED Table Clamp Magnifier Lamp



- Universal joint and adjustable arm for easy positioning where it is most needed.
- Standard mount: Desktop clamp.



PCB checking



MAX 65mm

Model No.	Voltage	Standard plug
MA-1209LA	AC 110V~120V	A (I)
MA-1209LI	AC 220V~240V	I (II)

Color temperature	Illumination	Lens material	Magnification	Lens size	Light source	Individual packing
6000~7000 Kelvin	400 Lumen	Glass	5D(2.25X)	Ø127mm	90 pcs LEDs	Color box

MA-1219A MA-1219F Ultra-Efficient LED Magnifying Lamp



3 Level Illuminations 84 /42 LED Lighting Control

- Universal joint and unique internal cantilever design for easy positioning where it is most needed.
- Standard mount: Desktop clamp.

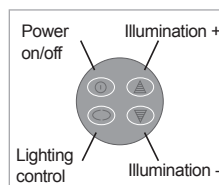

MAX 65mm

Model No.	Voltage	Standard plug
MA-1219A	AC 110V~120V	A (I)
MA-1219F	AC 220V~240V	F (II)

Color temperature	Illumination	Lens material	Magnification	Lens size	Light source	Individual packing
6000~7000 Kelvin	900 Lumen	Glass	3D (1.75X)	175x130mm	84 pcs LEDs	Color box

▶ MA-1205CA Magnifier Workbench Lamp MA-1205CB



- Wide open protection cover design can be swiveled up and won't spring back.
- Even, shadow-free light will make it easier for you to see and enjoy the activities longer.
- Spring balanced adjustable arm for easy maneuverability and positioning.



2.25X(5D)

MAX
65mm



Model No.	Voltage	Standard plug
MA-1205CA	AC 110V~120V	A (I)
MA-1205CB	AC 220V~240V	I (II)

Lens material	Magnification	Lens size	Light source	Individual packing
Glass	5D(2.25X)	ø127mm	22W	Color box

▶ MA-1503A Wide View Magnifier MA-1503I



- Shadow-free light will make it easier for you to see and enjoy the activities longer.
- Spring balanced adjustable arm for easy maneuverability and positioning.



1.75X(3D)

MAX
65mm

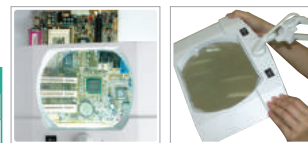

Model No.	Voltage	Standard plug
MA-1503A	AC 110V~120V	A (I)
MA-1503I	AC 220V~240V	I (II)

Lens material	Magnification	Lens size	Light source	Individual packing
Glass	3D(1.75X)	Ø 190 x155mm	PL 9W x 2 pcs	Color box

▶ MA-1215CA Table Clamp Magnifier With Workbench Lamp MA-1215CF



- Shadow-free light will make it easier for you to see and enjoy the activities longer.
- All metal housing mounted on a spring balanced arm that stays set in any position
- Dust-proof cover for lens protection.



2.25X(5D)

MAX
65mm



Model No.	Voltage	Standard plug
MA-1215CA	AC 110V~120V	A (I)
MA-1215CF	AC 220V~240V	I (II)

Lens material	Magnification	Lens size	Light source	Individual packing
Glass	5D(2.25X)	ø127mm	22W/T5 G10q	Color box

▶ MA-1225CA Gooseneck Magnifier Lamp MA-1225CF



- Shadow-free light will make it easier for you to see and enjoy the activities longer.
- The flexible gooseneck allows you to angle and point the light to where you need it most.
- Dust-proof cover for lens protection.



2.25X(5D)

MAX
65mm



Model No.	Voltage	Standard plug
MA-1215CA	AC 110V~120V	A (I)
MA-1215CF	AC 220V~240V	I (II)

Lens material	Magnification	Lens size	Light source	Individual packing
Glass	5D(2.25X)	Ø127mm	22W/T5 G10q	Color box

MA-1004A **Desk Type Magnifier**
MA-1004F **Lamp**



- The adjustable arm allows angling and pointing the light to where you need.
- Flip-down cover to keep the magnifier free of dust.

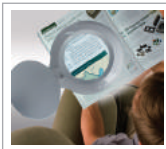

Model No.	Lens material	Magnification	Lens size	Light source	Color temp.	Luminance	Voltage	Standard plug
MA-1004A	Glass	3D(1.75X)	127×79 mm	56 LEDs	6000~7000 Kelvin	650 lumen	AC 110V~ 120V	A □
MA-1004F							AC 220V~ 240V	F ◁▷
Individual packing				Color box				

MA-1013MA **LED Desk Type Magnifier**
MA-1013MF **Lamp**



- Design with 3D(1.75X) large glass lens to provide high transmission for excellent view and 12D(4X) insert lens to inspect small parts and fine details.
- The adjustable arm allows angling and pointing the light to where you need.
- Flip-down cover to keep the magnifier free of dust.



Model No.	Lens material	Magnification	Lens size	Light source	Color temp.	Luminance	Voltage	Standard plug
MA-1013MA	Glass	3D(1.75X) & 12D(4X)	Ø100mm	40 LEDs	6000~7000 Kelvin	550 lumen	AC 110V~ 120V	A □
MA-1013MF							AC 220V~ 240V	F ◁▷
Individual packing				Color box				

MA-1003MA **Desk Type Magnifier**
MA-1003MF **Lamp**



- Design with 3D(1.75X) large glass lens to provide high transmission for excellent view and 12D(4X) insert lens to inspect small parts and fine details.
- The adjustable arm allows angling and pointing the light to where you need.
- Flip-down cover to keep the magnifier free of dust.



Model No.	Lens material	Magnification	Lens size	Light source	Voltage	Standard plug
MA-1003MA	Glass	3D/12D (1.75X/4X)	Ø 100 mm	12W/T4 G10q	AC 110V~120V	A □
MA-1003MF					AC 220V~240V	F ◁▷
Individual packing				Color box		

MA-1601A **LED Working Lamp**
MA-1601F



- The adjustable arm allows easy placement in any position you need.
- Shadow-free light will make it easier for you to see and enjoy the activities longer.
- Both high light and dim light for choices, more user friendly.

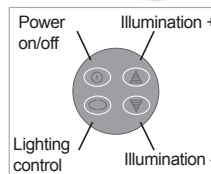

Model No.	Voltage	Standard plug
MA-1601A	AC 110V~120V	A □
MA-1601F	AC 220V~240V	F ◁▷

Color temperature	Illumination	Overall length	Light source	Individual packing
6000~7000 Kelvin	1200 Lumen	92 x 58 x 18cm	84 pcs LEDs	Color box

▶ MA-1006A / MA-1006F Desk Type LED Magnifier Lamp



- The adjustable arm allows angling and pointing the light to where you need.
- Flip-down cover to keep the magnifier free of dust.



Model No.	Lens material	Magnification	Lens size	Light source	Luminance	Voltage	Standard plug
MA-1006A	Glass	3D(1.75X)	115x73 mm	30 pcs LEDs	300 Lumen	AC 110V~120V	A (T)
MA-1006F						AC 220V~240V	F (C)
Individual packing				Color box			

▶ MA-015 Foldable Magnifier



- Glass lens with adjustable folding arms design.
- Great for working on hobbies, documents, and circuit boards, etc.



* Not for sale in Japan

Lens material	Magnification	Lens size	Light source	Battery	Individual packing
Acrylic	2D (1.5X)	Ø130mm (5")	1 LED	LR1130 (3AG12) x3 (Included)	Color box

▶ MA-016 Headband Magnifier



- Detachable LED light device.
- Adjustable LED light.
- Multiple lens provide better magnification.
- The belt size can be adjusted freely.

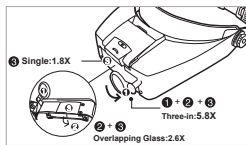

▶ 8PK-MA003N Personal Magnifier



- Light weight. Frame is made of durable impact resistant material.
- The comfortable headband is fully adjustable to fit any size.
- Easy to adjusting visor to most comfortable position.

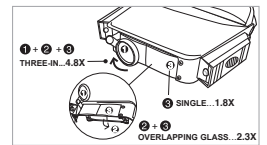

Model No.	Materials	Magnification	Lens size	Light source	Battery	Individual packing
MA-016	Acrylic	Single: 1.8X, Overlapping: 2.6X, Three-in: 5.8X	Round: Ø 28mm, Square: 89x29mm	1 pce high power LED	1.5V AAAx2 pcs (Not included)	Blister card
8PK-MA003N		Single: 1.8X, Overlapping: 2.3X, Three-in: 4.8X	Round: Ø 28mm, Square: 91x29mm	2 pcs Bulbs		

▶ 8PK-MA008 Sliding Magnifier



3X (one lens)



Lenses combined for higher magnification.



- Glass lens with hinged stainless cover.
- Great for very small objects, collection, and jewelry work.



Model No.	Lens material	Magnification	Light source	Lens size	Battery	Individual packing
8PK-MA008	Acrylic	Single: 8D (3X) Overlapping: 20D (6X)	-	22x35mm	-	Blister card
8PK-MA005		Single: 16D (5X) Overlapping: 36D (10X)	-	Ø 25mm	-	
MA-014	Glass	28D (8X)	1 LED	Ø 21mm (0.82")	LR11300 (AG10) x 3	

▶ MA-023 Handheld LED Light Magnifier



High quality 10D(2X)
Acrylic lens, Ø50mm

High quality 76D (15X)
Acrylic lens, Ø18mm



Comes with 2 LEDs
allowing use in light
insufficient place

Soft handle

Pull-out with dual lenses

10D(3.5X)/76D(20X) to meet many applications.

Comes with 2 LEDs light

Allows use in dark place.

Non-slip handle with rubber

Provides comfortable operation.



PCB checking



Jewelry work

Lens Material	Magnification & Lens size		Light Source	Battery	Individual packing
Acrylic	Big Lens	Small Lens	2 LEDs	1.5V AAA x3pcs (not included)	Blister card
	10D(2X) Ø50mm	76D(15X) Ø18mm			

▶ MA-020 22X Handheld LED Magnifier



LED light



jewelry work



- Comes with 2 LED lights.
- Excellent for jewelry work.

▶ MA-021 3.5X Handheld LED Magnifier



LED light



PCB checking



- Comes with 2 LED lights
- Suitable for reading, PCB checking & more.

▶ MA-022 7.5X Handheld LED Magnifier w/ Currency Detecting Function



LED light



Currency detection



jewelry work



- Comes with 1 LED light
- Combine with UV light for currency or credit card detection.

Model No.	Lens material	Magnification	Lens size	Light source	Battery	Individual packing
MA-020	Glass	Object lens 11.5D; Eyepiece 19D, (10X)	Ø 19mm	2 LEDS	1.5V AAA x3pcs (not included)	Blister card
MA-021		10D (3.5X)	Ø 46mm			
MA-022		26D (7.5X)	Ø 27mm	1+1LED (1UV LED)	CR2016 x 2 (not included)	

▶ MA-019 3X Handheld LED Light Magnifier with Currency Detecting Function



LED light



8 LED + 1 UV light

Ideal for reading, PCB checking, insect observation, etc.

▶ MA-013 3X Magnifier



- Glass lens with plastic holding handle.
- Ideal for very small objects and documents reading.

▶ 8PK-MA006 Illuminated Magnifier

4X w/Light

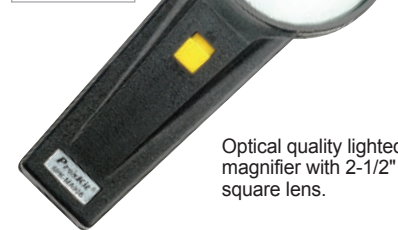
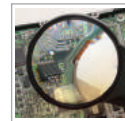

Optical quality lighted magnifier with 2-1/2" square lens.

Model No.	Lens material	Magnification	Lens size	Light source	Battery	Individual packing
MA-019	Glass	8D (3X)	Ø56mm	8+1 LEDS (1 UV LED)	1.5V AAA x3pcs (not included)	Blister card
MA-013		8D (3X)	Ø50mm (2")	-	-	
8PK-MA006		12D (4X)	Ø62mm	1 Bulb	1.5V AA x 2 pcs (Not included)	

MISCELLANEOUS



Pro'sKit® Diversity is beyond your imagination.



Pro'sKit®

886-2-22183233
Sales support

pk@mail.prokits.com.tw
E-mail

www.prokits.com.tw
Global website

TE-1201UB/TE-1401UB/TE-1203UB/TE-1403UB DC to AC Power Inverter

Microprocessor Controlled

- Converts 12-volt/24-volt DC to 230-volt AC power.
- Initial checking: Auto-detecting wrong battery cont. such as 12/24V.

Unique Protective Design



- Unique soft start to protect output short circuit.
- Low battery/Over-load/Over-heat: Shut-down or pre-alarm function.

Voltage Isolation

- High /Low voltage completely isolation for safety.

Extra USB Output

- Extra 5V USB output for using/ charging mobile phones and other USB devices.

Model No.	TE-1201UB	TE-1401UB	TE-1203UB	TE-1403UB
Input full load current	15A (12V) // 8A (24V)		30A (12V) // 15A (24V)	
Output continuous power	150W		300W	
Output surge power	450W		900W	
No load current draw	< 0.4A (12V)	< 0.3A (24V)	< 0.6A (12V)	< 0.5A (24V)
Input voltage	DC12V:10~15V	DC24V:20~30V	DC12V:10~15V	DC24V:20~30V
Output voltage/frequency	AC 220~240V, 50Hz Crystal controlled			
USB port output	5VDC (500mA MAX.)			
Output waveform	Modified sine wave 			
Efficiency	> 90%			
Output regulation	± 5% Intelligent AVR			
Auto temperature control fan	Non		Yes	
Low battery pre-alarm & shutdown	<11V or 22V±0.5V or 1V Pre-alarm <10V or 20V±0.5V or 1V Shut down & alarm		<10.5V or 21V±0.5 or 1.0V Pre-alarm < 10V or 20V ±0.5V or 1.0 Shut down & alarm	
Over heating	> 60°C Pre-alarm, > 65°C Shut down			
Over load	> 170W Pre-alarm, > 178W Shut down & alarm		> 310W Pre-alarm, > 324W Shut down & alarm	
Fuse	15A×1 pcs	10A×1 pcs	35A & 15A×1 pcs	20A & 15A×1 pcs
AC outlet	B 			
Dimension	113 × 73 × 58 mm		140 × 73 × 58 mm	
Weight	0.5 kg		0.75 kg	
Individual packing	Color box			



Modified Sine Wave 230V

150W 300W



Accessories: only for TE-1203UB/ TE-1403UB



TE-1206B/TE-1406B/TE-1210B/TE-1410B DC to AC Power Inverter

Microprocessor Controlled

- Converts 12-volt/24-volt DC to 230-volt AC power.
- Initial checking : Auto-detecting wrong battery cont. such as 12/24V.

Unique Protective Design

- Unique soft start to protect output short circuit.
- Low battery/Over-load/Over-heat: Shut-down or pre-alarm function.

Voltage Isolation



- High /Low voltage completely isolation for safety.



Accessories for TE-1206B TE-1406B



Accessories for TE-1210B TE-1410B

Model No.	TE-1206B	TE-1406B	TE-1210B	TE-1410B
Input full load current	60A (12V) // 30A (24V)		100A (12V) // 50A (24V)	
Output continuous power	600W		1000W	
Output surge power	1500W		2400W	
No load current draw	< 0.6A (12V)	< 0.4A (24V)	< 0.6A (12V)	< 0.5A (24V)
Input voltage	DC12V:10~15V	DC24V:20~30V	DC12V:10~15V	DC24V:20~30V
Output voltage/frequency	AC 220~240V, 50Hz Crystal controlled			
Output waveform	Modified sine wave 			
Efficiency	85 ~ 90%			
Output regulation	± 5% Intelligent AVR		±5% Intelligent PWM	
Auto temperature control fan	Yes			
Low battery pre-alarm & shutdown	< 10.5V±0.5V or 21V ±1V Pre-alarm < 9.5V ±0.5V or 20V ±1V Shut down & alarm		< 10.5V ±0.5V or 21V ± 1V Pre-alarm < 9.5V ±0.5V or 19V ±1V Shut down & alarm	
Over heating	> 60°C Pre-alarm, > 65°C Shut down & alarm			
Over load	> 615W Pre-alarm, > 644W Shut down & alarm		> 1140W Pre-alarm, > 1187W Shut down & alarm	
Fuse	25A × 3 pcs	15A × 3 pcs	20A x 6 pcs	10A x 6 pcs
AC outlet	B 			
Dimension	190 × 113 × 62 mm		340 × 135 × 79 mm	
Weight	1.5 kg		2.5 kg	
Individual packing	Color box			



Modified Sine Wave 230V

600W 1000W



TE-1206B
TE-1406B



TE-1210B
TE-1410B



MS-551B Electric Hot Knife

CE TÜV GS **150W 550°C**

16 Temperature Adjustment
Ideal For Foam Cutting Solution
Fast Heat Up

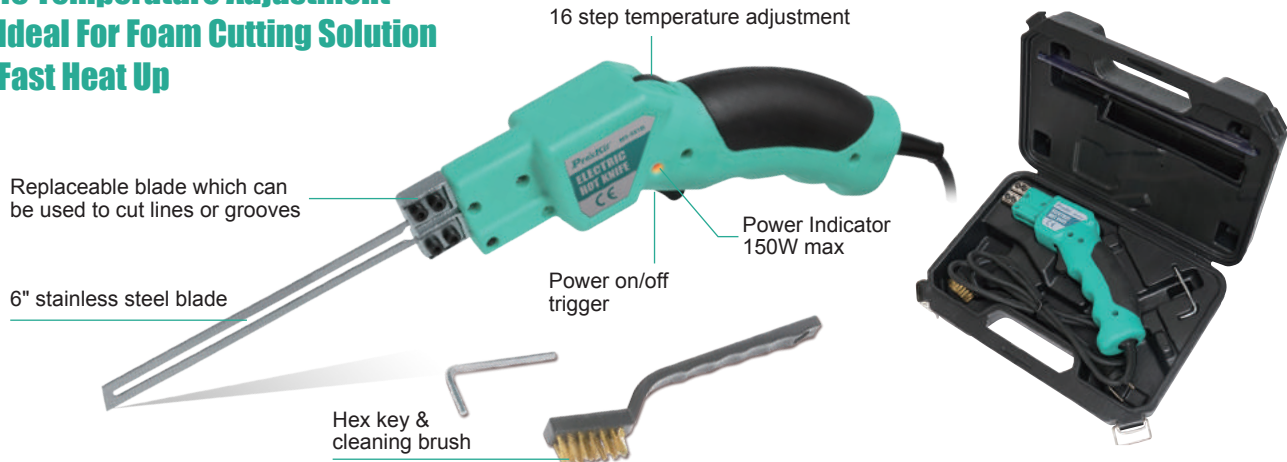

Model no.	MS-551B
Voltage	230V / 50Hz
Power	150W max
Temperature	550°C (Max)
Temperature adjustment	16 positions
Standard plug	B
Accessories	9MS-551-B: 6" stainless steel blade, Hex key, Cleaning brush, Blow-molded case
Size	310 x 210 x 85mm
Individual packing	Color box

Ideal solution for below materials

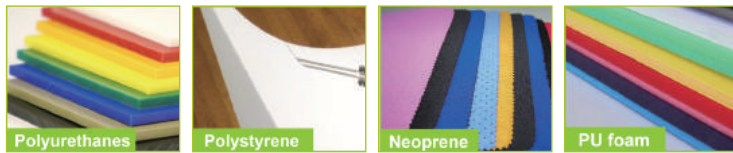

MS-325 7 in 1 Multi-Function Pocket Tool Key Chain

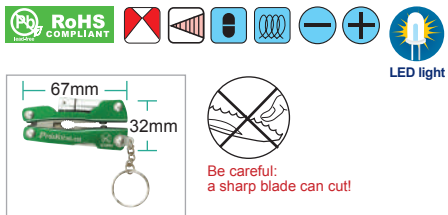

Material	2Cr13
HRC Body	45±2°
Application	Serrated saw, Opener & Slotted Screwdriver, Phillips screwdriver, Fruit Knife, Mini LED Flashlight
OAL.(mm)	105
Individual packing	Double blister card

MS-525 9-in-1 Multi-Tool

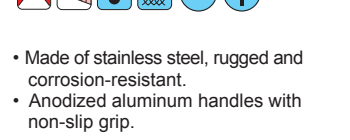

Material	3Cr13, ABS
HRC Body	45±3°
Application	Serrated knife, Can opener, Phillips, Pliers, Screwdriver, Knife, Saw, Bottle opener, Flat screwdriver, Flat file
OAL.(mm)	160
Individual packing	Double blister card

MS-526 12-in-1 Multi-Tool

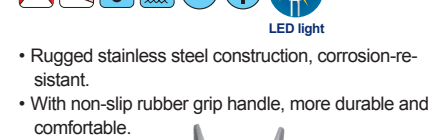

Material	3Cr13
HRC Body	45±3°
Application	Pliers, Scissor, Saw, Phillips, Screwdriver, Bottle opener, Can opener, Knife, Flat file, Flat screwdriver, Awl / Knife, Flat screwdriver
OAL.(mm)	155
Individual packing	Double blister card

▶ MS-C002 Mini Vacuum & Blowing Cleaner



Speed 25,000rpm



High speed rpm and easy-to-use handy vacuum cleaner with attachments for vacuuming / blowing / brushing off dirt and dust.



▶ MS-C001 Mini Vacuum Cleaner



- Cleans keyboards, printer, photographic equipment, audio/visual equipment and all office electronics.
- Compact size design and powered by battery.



Speed	Torque	Output	Voltage	Body size	Individual packing
25,000 rpm	26 g-cm	5.15W 1.83A	DC 6.0V (AA 1.5V×4 pcs)	Φ45×130×90 mm	Color box

Material	Voltage	OAL.(mm)	Individual packing
Polypropylene	DC 6.0V (AA 1.5V × 4pcs)	128	Blister card

▶ MS-C005I Dust Blowing & Vacuum Cleaner

- High power output 450W.
- Reusing washable dust bag.
- Easy operation and energy-saving.
- Large power trigger with conveniently located lock-on button.
- Maximum air volume of 2.3m³/min for faster clean up.



Accessories:
1 x Air flow tube
1 x Dust bag

Power	450 W
Voltage	230V / 50Hz
No load speed	0-16000 rpm
Air volume	2.3m ³ /min
Weight	50 oz (1.4Kg)
Accessories	1 x Air flow tube, 1x Dust bag
Dimensions	24.0 cm x 19.0 cm x 16.7 cm)
Individual packing	Color box



▶ MS-153A / MS-153C Bulb Blower



Air valve made by copper with chrome plating

MS-153A

Comes with copper nozzle, providing high air pressure for removing dust safely and gently.



Air valve made by copper with chrome plating

MS-153C

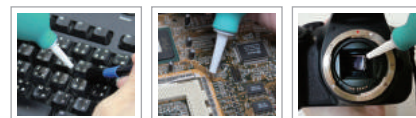

Model No.	Material	Nozzle material	Nozzle size	Air valve Material	Pump capacity	OAL.(mm)	Individual packing
MS-153A	PVC	Copper with chrome plating	Φ 2.2×14 mm	Copper with chrome plating	50 ml	Φ 42×94	Blister card
MS-153C	PVC	ABS	Φ 5.0×30mm	Copper with chrome plating	110 ml	Φ 56×140	

DK-2032 / DK-2033N / DK-2034N Fish Tape



DK-2032



DK-2033N



DK-2034N

Model No.	Container size(mm)	Steel tape size	Individual packing
DK-2032	Ø 214x27	15.2Mx3.2x1.6mm (50ft x 1/8" x 1/16")	PE shrink
DK-2033N	Ø 305x42	30.5Mx3.2x1.6mm (100ft x 1/8" x 1/16")	
DK-2034N	Ø 305x42	61.0Mx3.2x1.6mm (200ft x 1/8" x 1/16")	

- Made from flexible spring steel and black finished.
- Equipped with durable plastic container and slide handle.
- Easy to thread through the pipe and pull out the electric cable.

DK-2060SET/DK-2040 / DK-2041 / DK-2042 Measuring Tape



Auto Stop



DK-2060SET
(12pcs/SET)



DK-2040



DK-2041



DK-2042

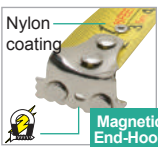

Model No.	L (Max.)	W (Max.)	Thickness(mm)	Blade coating	Individual packing
DK-2060SET	3M/10ft	16mm	0.11	PVC	Display box
DK-2040	3M/10ft	16mm	0.11	Nylon	Blister card
DK-2041	5M/16ft	19mm	0.11		
DK-2042	7.5M/25ft	25mm	0.11		

- Magnetic end-hook for convenient measuring.
- Anti-slip and shockproof rubber case.
- Hi-rel power tape.

PD-151 6" Electronic Caliper



- Hardened stainless steel.
- High quality 6"(150mm), thumb wheel for accuracy and ease with 4 measurement: inside, outside, depth and step.
- Precision-ground and lapped measuring surface.

PD-153 6" Standard Caliper

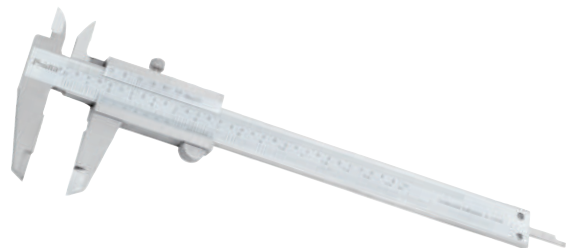

Inside dimension measurement



Outside dimension measurement

Model No.	Material	Range	Accuracy	Resolution	Power	Individual packing
PD-151	AISI 430	0~150mm/0~6"	±0.02mm/0.001"(<100mm) ±0.03mm/0.001"(>100mm)	0.01mm/0.0005"	LR44 (1.5V) ×1 pcs	Plastic box + Color label sleeve
PD-153		0~150mm/0~6"	±0.02mm/0.001"	0.02mm/0.001"	N/A	

▶ BX-412N Round Hole Bread Board

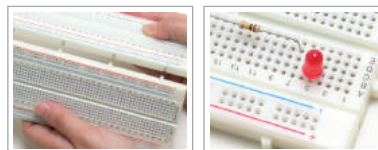
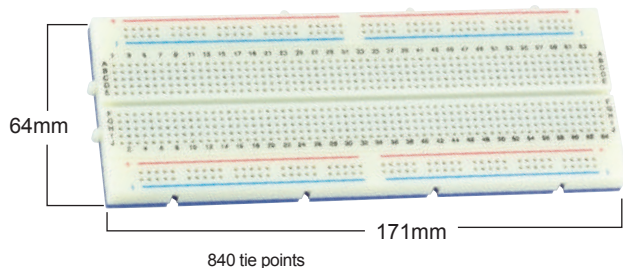

Excellent expandability Friendly graduations

- 840 tie points
- Round hole designed for easy plug and pull
- Expandable by combining several boards together to meet your different requirement
- Wearproof material made of ABS & phosphor bronze with good flexibility and electric conductivity

Individual packing
Blister card

▶ BX-4123 / BX-4135 Round Hole Bread Board



Edge plate can easily fold up

Application:
Used as a simulated layout for R&D and students.

Features:

- Round hole designed for easy plug and pull.
- Expandable by combining several boards together to meet your different requirement.
- Wearproof material made of ABS & phosphor bronze with good flexibility and electric conductivity.

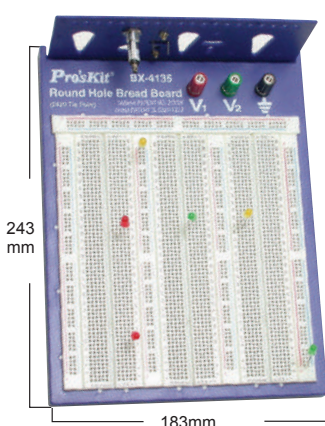

BX-4135 2420 tie points (Demo only)

TAIWAN PATENT NO. 215526
CHINA PATENT ZL 03231122.2

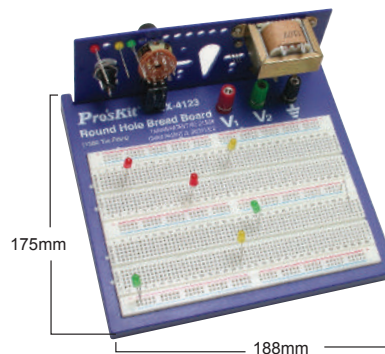

BX-4123 1580 tie points (Demo only)

Model No.	Tie points	Individual packing
BX-4123	1580	Blister card
BX-4135	2420	

▶ OP-E070 / OP-E351 Bread Board Accessory



OP-E070

- 70 pcs of 22 AWG solid wires
- Pre-cut, pre stripped and pre-formed on each end
- Variety of colors
- Completely reusable
- 14 lengths x 5 pcs each (2, 5, 7, 10, 12, 15, 17, 20, 22, 25, 50, 75, 100 and 125mm)



OP-E351

- 350pcs of 22 AWG solid wires
- Pre-cut, pre stripped and pre-formed on each end
- Variety of colors
- Completely reusable
- 14 lengths x 25 pcs each (2, 5, 7, 10, 12, 15, 17, 20, 22, 25, 50, 75, 100 and 125mm)

Case size (mm)	Individual packing
165x55x15	Poly bag + Hanger

Case size (mm)	Individual packing
178x90x28	Poly bag + Hanger

▶ 8PK-610 PLCC Extractor

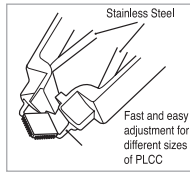

Material	OAL. (mm)	Individual packing
AISI 410 + POM	100x50	Blister card

A spring assisted chip carrier extraction tool, specially designed for the safe removal of PLCC's from sockets without damage to component parts.

Material	OAL (mm)	Individual packing
AISI 304 + POM	100x50	Blister card

▶ 908-609 IC Extractor



Stainless steel construction for removing dual in-line IC packages. (Insulated vinyl grip.)

Material	OAL (mm)	Individual packing
AISI 420J + PVC	105	Inner box

▶ 908-609A IC Extractor



Stainless steel construction for removing dual in-line IC packages.

Material	OAL (mm)	Individual packing
AISI 420J	112	Inner box

▶ 1PK-122 Vacuum Pick-Up Tool

The hand-held SMD vacuum pick-up tool is ideal for picking up and moving electronic components, large or small. With fountain pen dimensions, it fits easily into your hand or pocket.

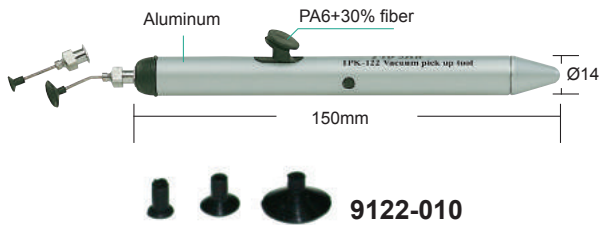

Replacement caps	Individual packing
9122-010 (3pcs/bag) 4, 6, 10mm	Color box

▶ MS-121 Vacuum Pick-Up Tool



Lightweight, portable and suitable for the picking and placing small components weight up to 50 grams and having a flat surface, dilly packages and surface mount components, etc.



Replacement caps	Individual packing
9122-010 (3pcs/bag) 4, 6, 10mm	Color box

▶ 1PK-390G Inspection Mirror

- All-angle ball joint mirror with stainless steel back.
- Visual inspection of hidden areas.
- Double ball joint links swivel mirrors for viewing to 360°.
- Made of tempered spring steel to move freely and hold desired position.
- Replaceable, plated, copper-backed, clear-view mirror.
- Non-rotating inner hex rods prevent mirror from swinging out of alignment.



Lens size	OAL (mm)	Individual packing
50x90mm (2"x3-1/2")	216 ~ 490 (8-1/2"~19-1/4")	Blister card

▶ MS-391 Inspection Mirror

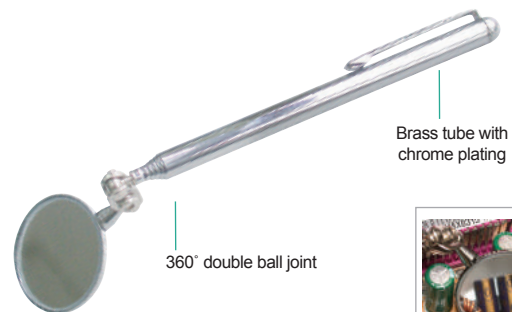

Lens size	Extension length	Individual packing
Ø32mm (1-1/4")	178~505mm	Blister card

▶ MS-323 Telescopic Magnetic Pick-Up Tool

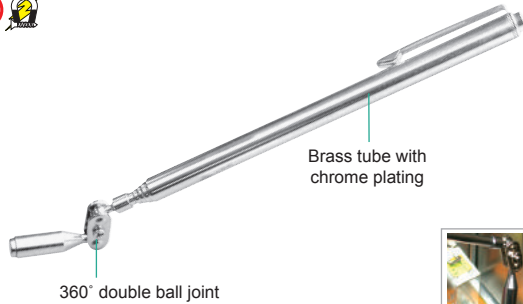

Maximum pick-up	Extension length	Individual packing
454g (1lb)	178-582mm	Blister card

▶ MS-322 Telescopic Magnetic Pick-Up Tool



- A handy chrome plated telescopic magnetic retrieving tool.
- Ideal for hard-to-reach working.
- Extension length: 80-450mm
- Maximum pick-up: 454g(1lb)

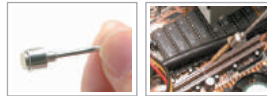
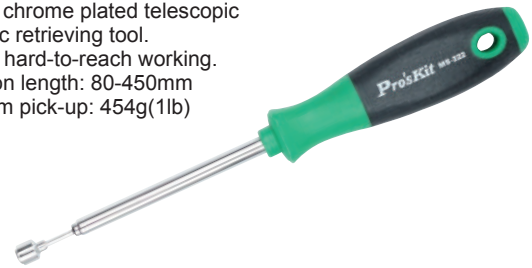

Individual packing
Blister card

▶ 8PK-3220 20 in 1 Screwdriver With Telescoping Pick-Up Tool



- Regular screwdriver with 13pcs screw bits 5-pcs. sockets and 1pce socket adaptor fits all kinds of job.
- Telescoping magnetic pick-up tool (up to 17-1/2" long/440mm) stored inside the tube pulling out to pick up small metal objects.

Individual packing
Blister card

▶ MS-329 Push-button Pick-up Tool

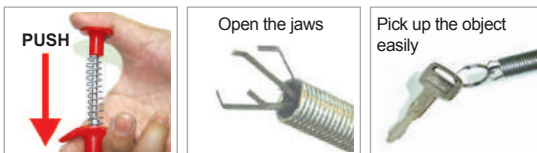

- Long Push-Button Pick-Up Tool has a 600mm flexible stem with a small set of jaws at one end.
- Ideal for home, shop, garage, work place etc.

Individual packing
Blister card

▶ MS-327 Long Pick-up Tool with Magnet Tip



- An extendable magnetic tool for picking up small metallic objects from inaccessible areas.
- This Pick-Up Tool has a 620mm flexible stem with a strong magnet at one end.
- Powerful magnet lifts 1.5KG
- Ideal for home, shop, garage, work place etc.

Individual packing
Blister card

▶ 1PK-3171 / 1PK-317N Spring Hook

- Can grab small spring and wires.
- Suitable for OA field service.

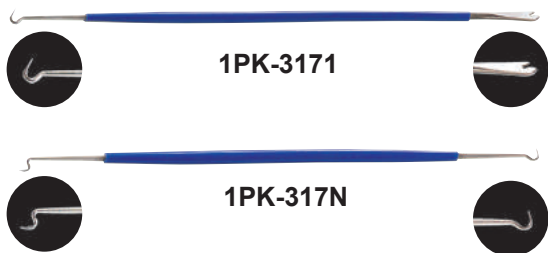

Model No.	Material	OAL.(mm)	Individual packing
1PK-3171	AISI 410 + PVC	205	Blister card
1PK-317N			

▶ 1PK-3175 5 PCS Hook Set

- Contains 6 parts.
- 5 different hooks can be screwed in a handle.

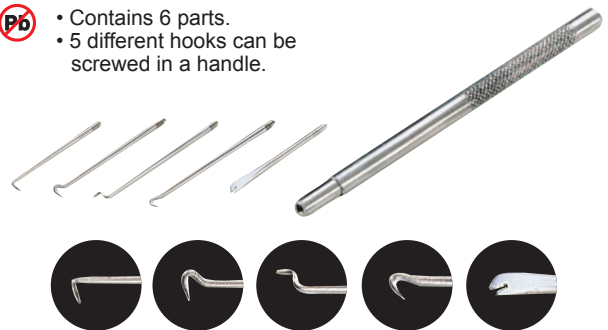

Material	OAL (mm)	Individual packing
AISI 410	210	Pouch

▶ 1PK-3178 4 PCS Probe Set

- 4pcs stainless steel single-ended probe that can be used for all kinds of precision work in electronics.
- Hook, curved, straight and angle tips 4 types packed in a vinyl pouch.

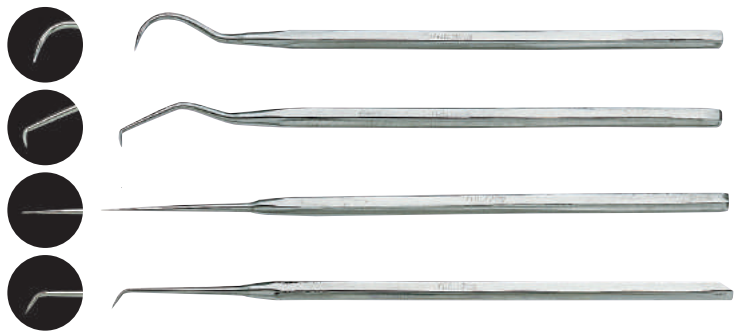

Material	OAL (mm)	Individual packing
AISI 410	Straight:145 Angled:140	Pouch

▶ FL-603 LED Flexible Flashlight



Light source	Illumination	Cable size	Handle size	Battery	Individual packing
White LED	11000mcd	Ø6.3 x 328mm	Ø15mm x 175mm	1.5V AAA x 3pcs (not included)	Blister card

▶ FL-528 1W LED Head Light



- 4 angles adjustment.
- High/Low/Flash modes.
- 60 Lumens brightness.
- 80,000 hours life.



Lamp material	Light source	Illumination	Battery	Dimension (mm)	Individual packing
ABS	1W white micro LED	60 Lumens	3 x 1.5V AAA	73 x 45 x 65	Blister card

▶ FL-506 LED Flashlight

- Rugged design aluminum body & contoured body for firm grip.
- Light weight and easy to carry.
- Switch on/off control on the bottom.



Material	Light source	Battery	OAL.(mm)	Individual packing
Aluminum	LED	1.5V AA x 2pcs (Not included)	ø26.5x155	Blister card

▶ FL-516 9 LED Flashlight

- Sturdy anodized aluminum construction, sealed at both ends with high grade rubber O-rings, water repellent and 1M drop protection
- LEDs last up to 100,000 hours.



Material	Light source	Battery	OAL.(mm)	Individual packing
Aluminum	9pcs White LEDs	1.5V AAA x 3pcs (Not included)	ø27 x 92	Blister card

MS-533 Pump-Action Drill Set



Ideal for drilling soft materials with thickness less than 5mm thickness, such as woods, pc board, plastic board and more.

- Chuck rotates as spindle nut is depressed, spring automatically rewinds to top.
- Includes 2pcs collet jaws for bits 0.5mm and 1.0~1.5mm (Bits are not included).

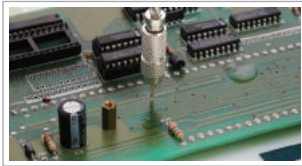

OAL.	Individual packing
190mm	Blister card

For use with
MICRO SIZED BITS



1PK-H064 Precision Hand Drill



Blade material	HRC	Diameter	Working length	Individual packing
HSS	56 \pm 3	\varnothing 3.5mm	31mm	Blister card

8PK-H081 Automatic Center Punch



High speed steel (HSS)

Tip material	OAL. (mm)	Individual packing
HSS	133	Blister card

1PK-T405 / 1PK-T406 / 1PK-T416 Stainless Steel Forceps



1PK-T405
1PK-T406



1PK-T416

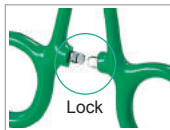

Model No.	Material	Type	OAL.(mm)	Individual packing
1PK-T405	AISI 410	Straight	130(5")	Blister card
1PK-T406			160(6")	
1PK-T416		Curved	160(6")	

SW-106 Junior Multi-Purpose Saw



A perfect small saw for all the odd jobs found at work, replacement blades available.



Handle	body	Blade	OAL (mm)	Replacement saw	Individual packing
PP	Aluminum alloy	S55C	255 x 92 x 22	5SW-106-B (100pcs/box)	Blister card

▶ MS-330 Home Hardware Assortment



- Great kit for indoor and outdoor use, such as home, office or workplace.
- High value assortment a variety of 6 different parts to suit your needs.

Contents	OAL (mm)	Individual packing
Cup hooks 5pcs Ø3.5mm tapping screw 10pcs Plastic anchor 10pcs Ø1.3x20mm wire nails 60pcs Ø2.0x38mm wire nails 10 pcs Picture hangers 5pcs	128 x 80 x 20mm	Color label shrink

▶ MS-9328 3D Printer Palette Knives

- Stainless steel blades with PP+TPR handle.
- Light and easy to grab. Also excellent for thick paint applications.
- Speeds removal of 3D print from print bed. Useful to pry prints off the bed, and to scrape off stuck-on plastic and glue.



Blade Material	Blade Size	Handle	OAL (mm)	Individual packing
Stainless steel	3"	PP+TPR	208	Blister card

▶ MS-602 Modeler Sandpaper Set

- Package included: 16 pcs grit silicon carbide sandpaper.
- Applications include sanding of model car, furniture finishes, polishing of plastic and glass.

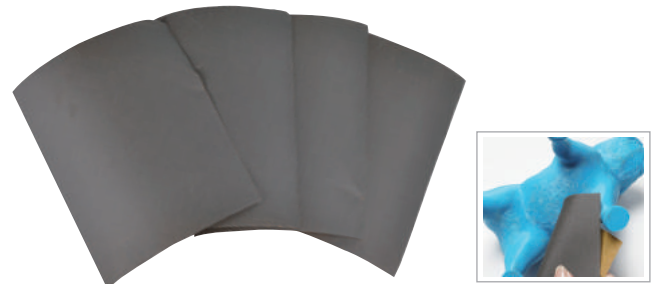

Material	Contents	Dimension	Individual packing
Silicone carbide	#320/#500/#800/#1000 4pcs of each	113 x138mm	opp bag+color label

▶ 8PK-605A 5 PCS Needle File Set

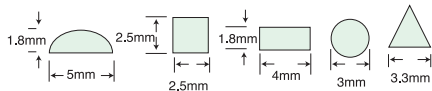

Material	HRC	Cut length	Handle O.D.	OAL	Individual packing
SKS-8	60°	75mm	Ø 5mm	170mm	Pouch

▶ 8PK-605L 5 PCS Needle File Set

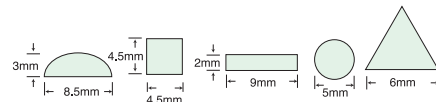

Material	HRC	Cut length	Handle O.D.	OAL (mm)	Individual packing
SKS-8	60°	85mm	Ø 7mm	180	Pouch

▶ 9K002A / 9K002B Flat File / Diamond Flat File

- Great tool for surface treatment.
- Working length:65mm.

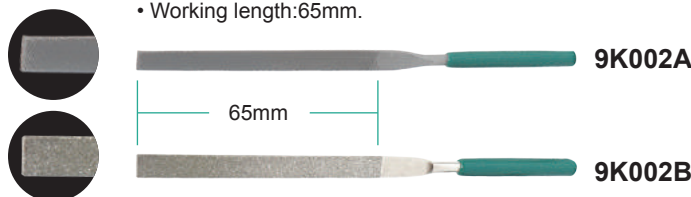

OAL	Individual packing
120mm	Bulk

▶ PD-376 Multi-Angle Swivel-Actions Vacu-Vise



- Swivels 360° and tilts 90° to desired angle.
- Equipped with slide-on rubber jaw for fragile work.
- 6 1/4" (158mm) triangular base.
- Aluminum die-cast construction.
- Light weight and durable.

Individual packing
Plain box+Color label

Note • Suction areas must be smooth, flat and clean.
• Adding a little water under vacuum base is recommended.

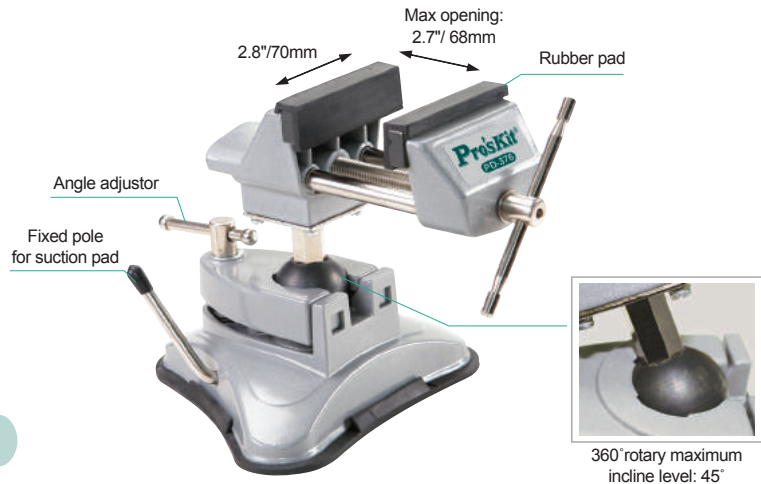

▶ PD-374 Hobby Vise



Individual packing
Blister card

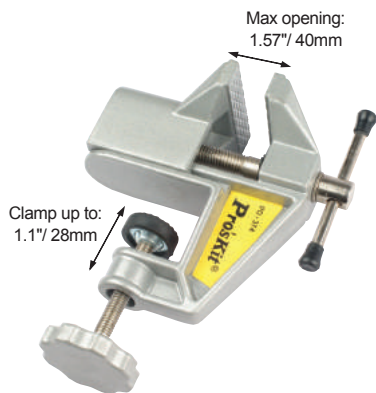

▶ PD-372 Mini Vise

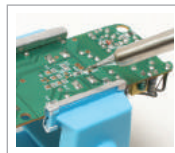

Individual packing
Blister card

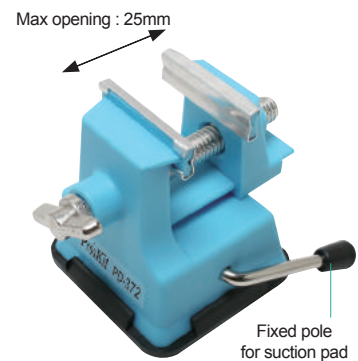

▶ PD-2609 8 oz Curved Claw Hammer



Material	Weight	OAL.(mm)	Individual packing
Handle: PP/TPR, S45C	227g (8 oz/0.5 lb)	250	Hanger

▶ PD-2612 8 oz Curved Claw Hammer



Material	Weight	OAL (mm)	Individual packing
Handle: PVC, S45C	227g (8 oz/0.5 lb)	250	Hanger

▶ PD-2606 Heavy Duty Curved-Claw



Material	Weight	OAL (mm)	Individual packing
Handle: Fiberglass, S45C	454g (16 oz/1 lb)	330	Bulk

▶ PD-2607 Ball Pen Hammer



Material	Weight	OAL.(mm)	Individual packing
Handle: Fiberglass, S45C	454g (16 oz/1 lb)	300	Bulk

MS-5156 iPhone Screw Position board



THE PHONE SCREW POSITION BOARD has a layout with a printed iPhone on top and holes to put in the screws at the right position. So It can help you always remember the position of each screw and it prevents you from mixing or losing them.



Model No.	
MS-152	2pcs screw position boards for iPhone 5(2pcs)
MS-15S2	2pcs screw position boards for iPhone 5S(2pcs)
MS-162	2pcs screw position boards for iPhone 6(2pcs)
MS-16S2	2pcs screw position boards for iPhone 6S(2pcs)
MS-16SP2	2pcs screw position boards for iPhone 6S plus(2pcs)
MS-5156	5pcs screw position boards for iPhone5/iPhone5S/iPhone6 / iPhone6S and iPhone 6S plus (qty one each)
Individual packing	Color box

MS-161 Heavy-Duty Suction Cup

• Ideal for open Imac, Ipad & glass-sheathed laptop displays.



ABS Handle

Capacity up to
11KG
(24.3lbs)



Size	Individual packing
Ø58mm x 72mm	Blister card

MS-018 Leak Proof Dispenser Pump Bottle

- Portable leak proof construction.
- Bottle scale indication.
- Anti dumping of cone design.



Material	Capacity	Individual packing
Polypropylene	180ml	Poly bag

MS-710 Anti-Fog UV Protective Glasses

CE **UV 400 Resistant**
Anti-Scratch
Anti-Fog

ANSI Z87.1-2003

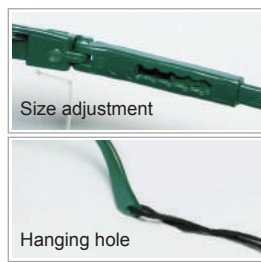

Contents	
Frame material	Nylon
Lens material	Polycarbonate
Product length (Temples folded)	147mm
Product width (Glasses included)	56.5mm
Temple length	117mm(MAX.)
Lens size	140 x 55mm
Lens thickness	2.0mm
Weight	34g
Individual packing	Poly bag

MS-035 Flux Bottle



• Dispenses flux evenly with a fine tipped needle.



Ø0.9 x 34mm

Material	OAL(mm)	Individual packing
PE	Ø37x150	Poly bag + Hanger (2 pcs/pack)

MS-004 MS-006 / MS-008 Liquid Dispenser Bottles



- Polyethylene bottles are not chemically reactive
- Purity pump to prevent backwash of contaminants into container



MS-008



MS-006



MS-004



Model No.	Description	Individual packing
MS-004	4 oz/114 ml	Poly bag + Hanger
MS-006	6 oz/170 ml	Poly bag + Hanger
MS-008	8 oz/227 ml	Poly bag + Hanger

▶ CP-382 Cable Tie Gun



- Neatly cuts end of cable tie off.
- Adjustable tension control.

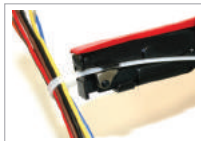

Material		HRC	Application	OAL. (mm)	Individual packing
Body	Blade				
Aluminum	S45C	Cutter 48°±2°	Cable tie from 3/32"~3/16" (2.2~4.8mm) and thickness up to 1.6mm	160	Blister card

▶ CP-385 Cable Tie Fasten Tool



- Tension adjustment allows the user to adapt the tool to the size of the tie.
- Cutting lever design to cut-off the excess tie for easy operation.



Tension



Cutting



Material		Application	OAL. (mm)	Individual packing
Body	Blade			
Aluminum	S45C	Cable ties thickness 3 mm and width 12mm	191	Blister card

▶ OP-1200 Cable Tie Assortments - 1200 PCS

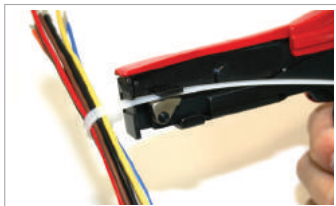

Carrying case : ø120x310mm

Description (mm)	Q'ty	Color	Individual packing
2.4x100	200 each	Natural	Color label
		Black	
		Red	
		Green	
2.5x140	100	Black	
3.6x200	100	Natural	

▶ MS-V305 MS-V306 / MS-V308 Hook and Loop Cable Ties



Material	Material	OAL. (mm)	Individual packing
MS-V305	Nylon /P,P	12x125	Poly bag (15 pcs/pack)
MS-V306		12x150	
MS-V308		12x200	

▶ 7UR / 7UY / 7UG Telecom Splice



Crimping Tool
Page. 82 (1PK-CT006/CP-148)



Model No.	Description	Application	Individual packing
7UR	UR connectors 1000 pcs/pack	19~26 AWG	Bulk
7UY	UY connectors 1000 pcs/pack	22~26 AWG	
7UG	UG connectors 1000 pcs/pack	19~26 AWG	

▶ 8PK-220 Magnetizer Demagnetizer



- A convenient pocket sized tool, housed in a strong plastic case.
- Ideal for the general magnetizer demagnetizer of small hand tool i.e screwdriver, hexagon keys.

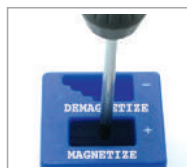

Individual packing
Blister card



INSTRUMENT CASES



Repair from place to place, instrument cases is your faithful friend.



Pro'sKit[®]

886-2-22183233
Sales support

pk@mail.prokits.com.tw
E-mail

www.prokits.com.tw
Global website

▶ TC-265 / TC-266 / TC-267 Heavy Duty Waterproof Case



Made of ABS thick resin, durable and anti-shock

All around water-tight seal for optimum protection of equipment inside

Large, corrosion resistant latches with padlock eye for better security and safety.

With pressure release valve

Water Proof Dust Proof Anti-Shock

(Demo only, instrument is not included)



Water-tight seal for equipment protection



TC-265

TC-266

TC-267



Comes with Pick and Pluck foam.



Ideal for carrying valuable precision equipment and instruments...etc.

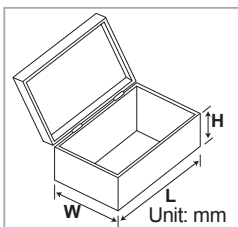

Model No.	Material	Load capacity	I.D.(LxWxH)(mm)	O.D.(LxWxH)(mm)	Individual packing
TC-265	ABS	20 KG	430x290x163	455x340x175	Color label shrink
TC-266		15 KG	330x217x160	340x260x170	
TC-267		15 KG	300x180x153	328x232x170	

▶ SB-3218 / SB-4121 Multi-Function Tool Box With Removable Tote Tray



Impact Resistant

TOOL CASES

Two large latches with padlock eye for better security and safety

Made of high-impact resistant polypropylene

Lift-out tray for small parts and tools

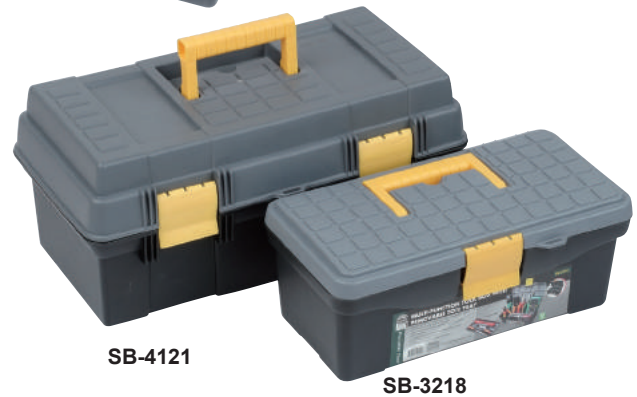
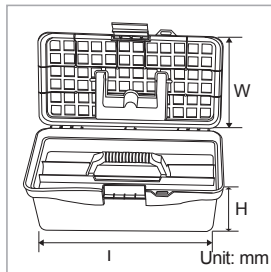
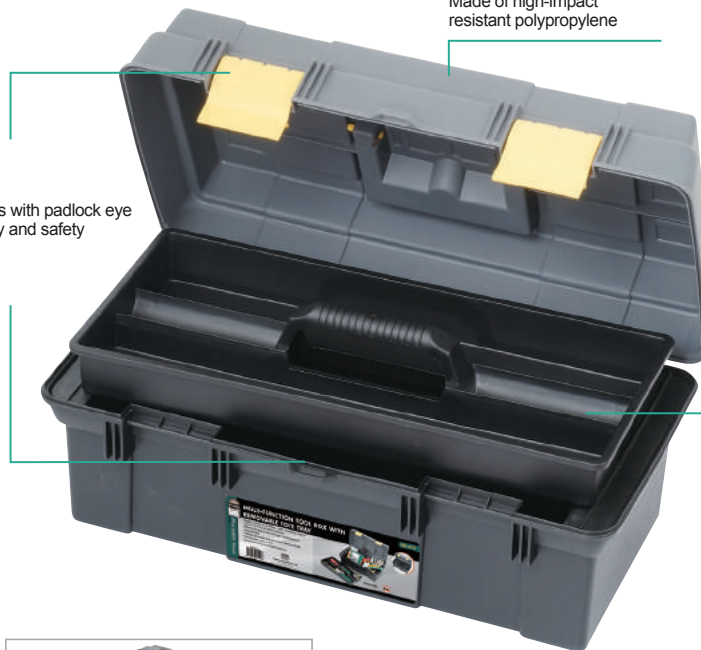

Model No.	Material	Load capacity	Dimension (LxWxH)(mm)	Individual packing
SB-3218	Polypropylene	5 KG	315x175x130	Color label shrink
SB-4121		10 KG	410x210x185	

▶ SB-2918 Multi-Function Tool Box With Storage Tray



Impact Resistant

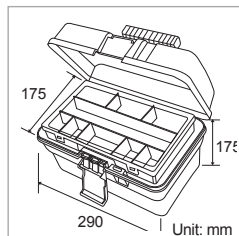

Portable lift-out box



Material	Load capacity	Dimension (LxWxH)	Individual packing
polypropylene	5 KG	290x175x175	Color label shrink

▶ SB-3428SB / SB-4536B Service Case



**Sturdy & Durable
High Impact**

Double sided opening



TOOL CASES



SB-3428SB

- Double sided opening.
- Adjustable dividers up to 15 compartments with 5 large and 5 small removable inserts in the other side for storage flexibility.



SB-4536B

- 6 large and 6 small removable inserts for storage flexibility.

- Properly divided spaces reach the different needs of any small components.
- Integrated handle and two locks for convenient carrying.
- Easy to store, easy to find.

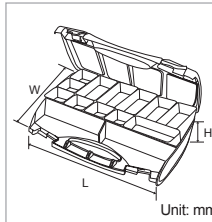

Model No.	Material	Dimension (LxWxH)
SB-3428SB	Polypropylene + Polystyrene	340x280x80
SB-4536B	Polypropylene + Polystyrene	450x355x75

Individual packing
Color label shrink

▶ SB-207P Plastic Tool Box With 2 Pallets



- Impact resistant
- Easy storage and carrying



Customized tool kit with this tool box is welcom.

Material	Dimension (LxWxH)	Individual packing
polypropylene	320x260x60	Color label shrink

▶ SB-2419 Storage Box



- Tight seal between top and compartments prevents small components from being mixed while closed.

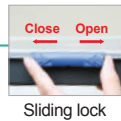
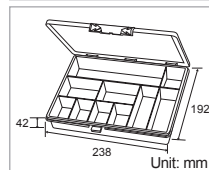

Material	Dimension (LxWxH)	Individual packing
Polypropylene	238x192x42	Color label shrink

▶ 103-132D Utility Component Storage Box

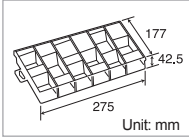

Material	Dimension (LxWxH)	Divider type	Optional divider	Individual packing
Polypropylene	275x177x42.5	Removable	503-132D-P (15 pcs/bag)	Shrink packing

▶ 203-132E Utility Component Storage Box

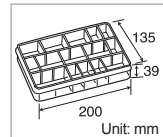

Material	Dimension (LxWxH)	Divider type	Optional divider	Individual packing
Polypropylene	200x135x39	Removable	503-132E-D12 (12 pcs/bag)	Shrink packing

▶ 203-132F Utility Component Storage Box

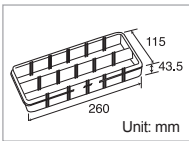

Material	Dimension (LxWxH)	Divider type	Optional divider	Individual packing
Polypropylene	260x115x43.5	Removable	503-132F-D10 (10 pcs/bag)	Shrink packing

▶ 203-132H Multi-Purpose Case

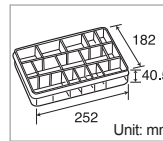

Material	Dimension (LxWxH)	Divider type	Optional divider	Individual packing
Polypropylene	252x182x40.5	Removable	503-132E-D12 (12 pcs/bag)	Shrink packing

▶ 903-132 Utility Component Storage Box

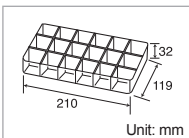

Material	Dimension (LxWxH)	Divider type	Individual packing
Polypropylene	210x119x32	Fixed	Poly bag

▶ 203-132I Multi-Purpose Case

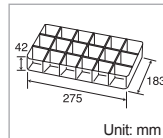

Material	Dimension (LxWxH)	Divider type	Individual packing
Polypropylene	275x183x42	Fixed	Shrink packing

▶ 203-132G Utility Component Storage Box

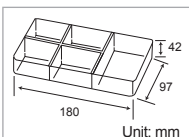

Material	Dimension (LxWxH)	Divider type	Individual packing
Polypropylene	180x97x42	Fixed	Shrink packing

▶ SB-1912 Utility Component Storage Box

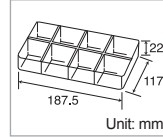

Material	Dimension (LxWxH)	Divider type	Individual packing
Polypropylene	187.5x117x22	Fixed	Shrink packing

▶ SB-1592 Component Storage Box



Demo only



▶ 103-132C Utility Component Storage Box

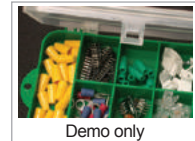

Demo only

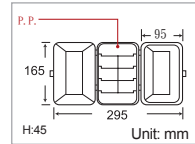

P.P. 165
H:45
295
95
Unit: mm

Material	Dimension(LxWxH)	Individual packing
Polypropylene	145x92x40	Color label + Shink packing

Material	Dimension(LxWxH)	Individual packing
Polypropylene	165x95x45	Shrink packing

▶ SB-1007K Multi-Purpose Box



Non-toxic



Unit: 2pcs/pack

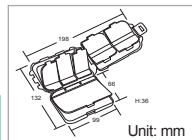

Unit: mm

Material	Dimension(LxWxH)	Individual packing
Polypropylene	99x66x36	Poly bag (2pcs/pack)

▶ 903-133S Utility Component Storage Box



Demo only

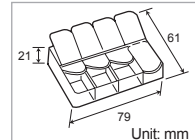

21
61
79
Unit: mm

Material	Dimension(LxWxH)	Individual packing
Polypropylene	79x61x21	Poly bag

▶ 203-115A / 203-115B Instrument Cases

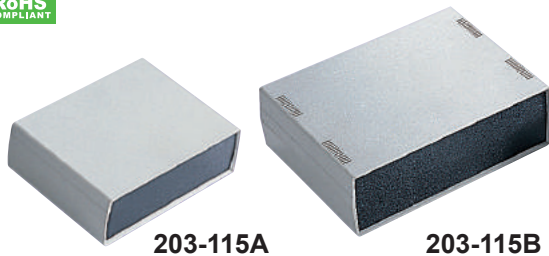

203-115A

203-115B

Model No.	Material	L		W		H		Individual packing
		OD	ID	OD	ID	OD	ID	
203-115A	ABS	200	197	158	146	64	58	Poly bag
203-115B		253	250	190	176	82	76	

▶ SB-1813 Stacking Bin



Demo only

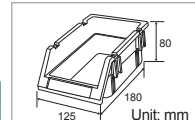

80
180
125
Unit: mm

Material	Dimension(LxWxH)	Individual packing
polypropylene	180x125x80	Shrink packing

▶ 203-125A / 203-125B / 203-125C Die Cast Aluminum Enclosures



203-125A



203-125B



203-125C

Channeled wall for easy PCB mounting.

Screws are included



Demo only

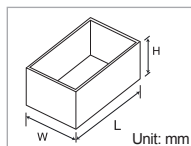

Unit: mm

Width of grooves:
203-125A:2.85mm
203-125B/C:2.45mm

Model No.	Material	OD		L		W		H		Individual packing										
		101	97	50.6	46.6	20.7	18.8	121	116.9	66.1	62	35.4	33.5	193.5	187.5	112.4	106.5	56.2	54	
203-125A	Aluminum																			Shrink packing
203-125B																				
203-125C																				

TOOL CASES



Everything is ready, except only one crucial item.



Pro'sKit[®]

886-2-22183233
Sales support

pk@mail.prokits.com.tw
E-mail

www.prokits.com.tw
Global website

▶ TC-311 Heavy-Duty ABS Case With Wheels And Telescoping Handle



Key locks for maximum security



Standard equipment for easy opening and closing.

Assemble

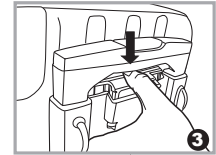
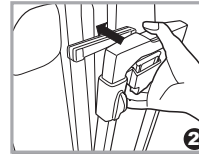
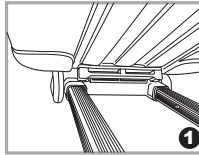

Material	Load capacity	Dimension (LxWxH)	Individual packing
ABS	12Kg	456x335x190	Color box

Unit: mm

▶ TC-850 ABS Carrying Tool Case W/2 Pallets

Deluxe die-cast chrome plating grip handle



Bag with rivet design, more durable



Key locks for maximum security

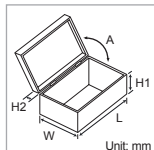

Material	Size	L	W	H1	H2	A	Individual packing
ABS	O.D	435	310	80	65	105°	Color box
	I.D	420	293	70	60		

▶ TC-2009 ABS Carrying Tool Case W/1 Pallet



Deluxe die-cast chrome plating grip handle



Aluminum corner

Removable pallet



Removable divider
Lining and partitions: EVA



Key locks for maximum security



Heavy duty metal protective corners

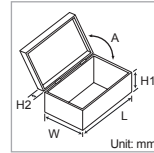

Material	Size	L	W	H1	H2	A	Individual packing
ABS	O.D	463	331	96	75	98°	Color box
	I.D	453	323	90	67		

▶ TC-747N Aluminium Frame Tool Case W/1 Pallet



Removable pallet



Removable divider
Lining and partitions: EVA

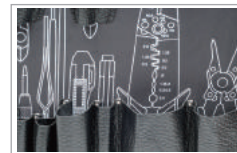

Bag with rivet design, more durable



Rugged and comfortable grip handle

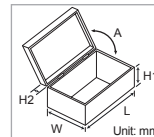

Material	Size	L	W	H1	H2	A	Individual packing
Frame: Aluminum	O.D	460	340	100	67	97°	Color box
	I.D	433	310	90	57		

▶ TC-752 Aluminium Frame Tool Case

8 heavy duty protective corners



Removable divider
Lining and partitions: EVA



Corner protection



Key locks for maximum security

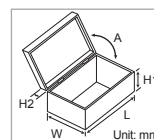

Material	Size	L	W	H1	H2	A	Individual packing
Frame: Aluminum	O.D	400	280	82	52	97°	Color box
	I.D	383	263	78	46		

▶ 8PK-735N Aluminium Frame Tool Case W/1 Pallet



Bag with rivet design, more durable.



Reinforce construction
3 hinges and corner protector.

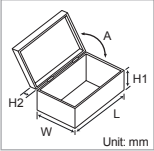

- Complete with one removable pallet and removable interior dividers.
- Lining and partitions: EVA.

Material	Size	L	W	H1	H2	A	Individual packing
Frame: Aluminum	O.D	460	334	103	60	93°	Color box
	I.D	442	322	93	49		



▶ 9PK-730N Aluminium Frame Tool Case W/1 Pallet



Bag with rivet design, more durable



Key locks for maximum security

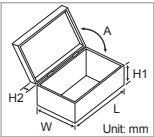

- Complete with one removable pallet and removable interior dividers.
- Lining and partitions: EVA.

Material	Size	L	W	H1	H2	A	Individual packing
Frame: Aluminum	O.D	458	330	101	49	97°	Color box
	I.D	438	312	95	41		



▶ TC-310 Deluxe Aluminium Frame Tool Case



Corner protection



3 Brackets
(Reinforce construction)

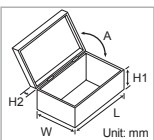

- Complete with one fixed pallet and removable interior dividers.
- Lining and partitions: EVA.

Material	Size	L	W	H1	H2	A	Individual packing
Frame: Aluminum	O.D	440	340	100	65	93°	Color box
	I.D	420	318	95	60		



▶ TC-755 Aluminum Frame Drawer Case



Drawer auto-locking design when lid is closed to prevent slide out



Key locks for maximum security

- Made of rugged plastic for strength and durability.
- Ball-bearing slides make drawer easy to open and close tightly.

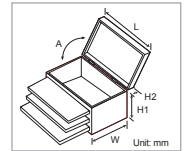

Material	Size	L	W	H1	H2	A	Individual packing
Frame: Aluminum	O.D	485	260	280	53	90°	Color box
	I.D	465	242	260	40		
	I.D(Drawer)	397	220	50	-		

▶ TC-736 Expert & Elegant Aluminum Frame Tool Case W/2 Pallets

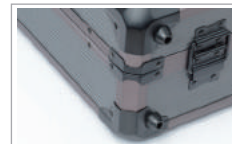

Heavy duty metal protective corners

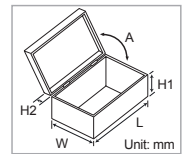

Material	Size	L	W	H1	H2	A	Individual packing
Frame: Aluminum	O.D	486	325	92	67	85°	Color box
	I.D	466	300	82	56		

▶ TC-700 Carrying Tool Case W/2 Pallets



Metal hinges, more durable



Metal protective corners



Anti-shock pads in the back and bottom.

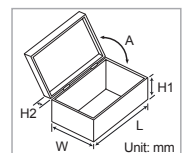

Material	Size	L	W	H1	H2	A	Individual packing
PVC leather	O.D	450	325	100	32	90°	Color box
	I.D	434	305	95	29		

▶ 8PK-750N / TC-750SN Aluminium Frame Tool Case W/1 Pallet

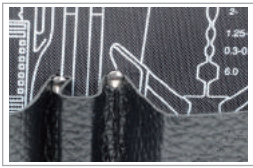

Bag with rivet design, more durable



8PK-750N

Aluminum frame

Removable pallet



TC-750SN

Removable pallet

ABS

Aluminum frame

Removable divider

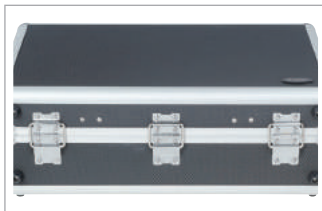

3 hinges reinforce construction



Heavy duty metal protective corners



8PK-750N

TC-750SN

Model No.	Material	Size	L	W	H1	H2	A	Individual packing
8PK-750N	Frame: Aluminum	O.D	458	330	90	60	97°	Color box
		I.D	434	308	82	53		
TC-750SN	Aluminum	O.D	320	227	98	62	93°	
		I.D	300	208	84	51		

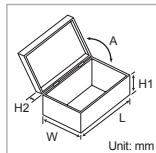

▶ 9PK-990 Tool Case W/1 Pallet

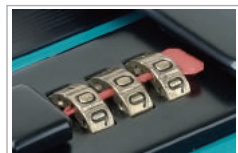

Number key lock



8 Brackets (Corner protector)

Deluxe die-cast chrome plating grip handle



Removable pallet



Removable divider

- Complete with one removable pallet and removable interior dividers.
- Lining and partitions: EVA

Material	Size	L	W	H1	H2	A	Individual packing
Frame: Aluminum	O.D	461	331	96	60	96°	Color box
	I.D	440	310	88	49		

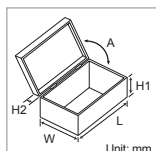

▶ 9PK-710P Deluxe Tool Case W/2 Pallets



- With 1PK-710K pallets x2.

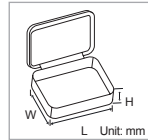
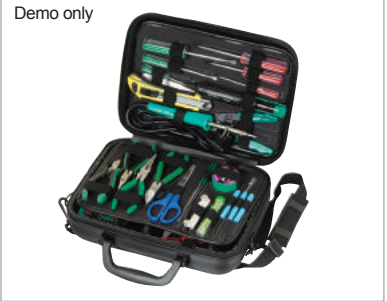

Material	L	W	H	Individual packing
PU leather	330	250	110	Color box

▶ 8PK-2003-P Zipper Bag W/2 Pallets



- With 1PK-2003 pallets x2.

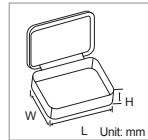

Material	L	W	H	Individual packing
600D Polyester	390	280	75	Color box

▶ ST-2012H Soft Sided Tool Pouch



- Keep your tools and supplies handy.
- Complete with universal tool best system.



Dual purpose belt for easy carrying on shoulder or waist

Material	L	W	H	Individual packing
600D Polyester	305	235	95	Poly bag +Hanger

▶ ST-4029 Multi-Purpose Tool Bag

- The main zipper has dual pulls for ease of use.
- With padded laptop compartment, fits 14-15.6-inch laptops.

3-way carrying system



Messenger bag

Backpack

Briefcase

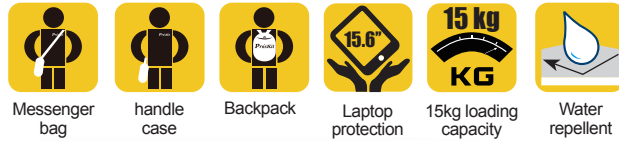

Messenger bag

handle case

Backpack

Laptop protection

15 kg loading capacity

Water repellent



Material	L	W	H	Individual packing
600D polyester	400	90	275	Poly bag + Hanger

▶ ST-12B Tool Bag

- Multi function bag with 4 inner layers.
- Ideal for storing tools, books, mobile computers, clothes, etc.

Convenient • Portable • Durable



Demo only



Material	L	W	H	Individual packing
600D Polyester	400	275	90	Poly bag

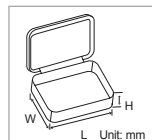

Water repellent

▶ ST-8BA Tool Bag

- Intensive structure of strap, zipper and handle designed to enhance the durability, ideal for student market.

Convenient • Portable • Durable



Demo only



Material	L	W	H	Individual packing
600D Polyester	390	260	110	Poly bag

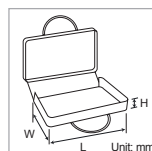

Water repellent

▶ ST-3216 Multi-Function Business Backpack

- 
Backpack
- 
15KG loading capacity
- 
Earbud hole
- 
Laptop protection
- 
Good ventilation
- 
Light weight

Decompress • Ventilation • Large Capacity



- Ergonomic shoulder straps
- Earbuds pass-through hole
- Cushion back
Good ventilation
- Large capacity
Adjustment strap
- Quick access front and side pockets
- Removable chest belt

Large capacity



The central multi compartments, interior pocket organizer provides extensive capacity for laptop, pad, smartphones, pens, CDs, tools and more. The mesh side pockets are perfect for water bottles, coffee mugs or other side pocket items.



Material	L	W	H	Individual packing
600D polyester	470	310	160	Hanger



▶ ST-3218G / ST-3218B / ST-32180 Colorful Fashion Backpack

- 
15KG loading capacity
- 
Water repellent
- 
Light weight



ST-3218G



Can be used as handy and back pack



Wide open mouth with interior pockets



Both pockets for bottles or foldable umbrella

Function and Fashion Combination

gives you great organize for a laptop, bottle, purse, magazines, phones, folding umbrella, charger, tools and more in schooling, travelling, working, shopping, leisure life, outdoors.



ST-3218B ST-32180 Back side

Material	L	W	H	Individual packing
900D nylon	390	270	220	Label+Poly bag

ST-13S / 9ST-23 / 9ST-33 / 9ST-43 Tool Bag

Convenient • Portable • Durable • Versatile

- With different size of elastic straps design for versatility, easy to organize tools inside the bag
- Easy way to reorganize tools and make your own combination tool bag quickly

Made of 400x300D Polyester

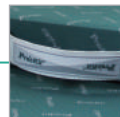

Micro injection plastic handle

Full logo stylish design around the bag



ST-13S

9ST-23

9ST-33

9ST-43

Heavy-duty zipper

TOOL CASES

Make your own combination, easy way to reorganize tools inside the bag

9ST-43 Size: 130x207x35mm
Loading Capacity: 3kgs

Demo only

9ST-33 Size: 255x180x50mm
Loading Capacity: 5kgs

Demo only

9ST-23 Size: 340x222.5x60mm
Loading Capacity: 10kgs

Demo only

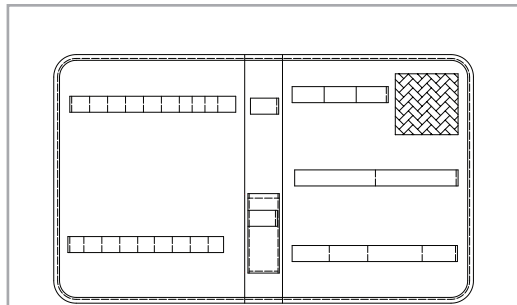

Demo only **ST-13S** Size: 385x300x55mm
Loading Capacity: 10kgs



Ultra Durable Tool Bag & Pouch Series



▶ **ST-5309**

14" Deluxe Tool Bag

10 pockets with 8 compartments for tool organize conveniently.

30KG / **Water**
Capacity / Repellent

Heavy Duty / Waterproof
Nothing but Convenient



Dimension (LxWxH) :

330 x 225 x 240mm

Individual packing :

Poly bag + Color label shrink

▶ **ST-5310** 14" Deluxe Tool Bag

7 pockets with 5 compartments for tool organize conveniently.



Rear view

Dimension (LxWxH) :

330 x 225 x 240mm

Individual packing :

Polybag+Color label shrink



Demo only

▶ **ST-5302** 16" Heavy-Duty Tool Bag

14 pockets with 4 mesh bags for tool organize conveniently.



Dimension (LxWxH) :

410 x 230 x 300mm

Individual packing :

Polybag+Color label shrink



Demo only

▶ **ST-5301**

20" Heavy-Duty Tool Bag With Wheels And Telescoping Handle

- 16 pockets with 4 mesh bags for tool organize conveniently.
- Telescopic handle & heavy duty wheel for easy transportation.

30 kg Capacity	Repellent	600D Polyester
Wide Open Mouth	High Density Webbing	Shoulder Strap

Dimension (LxWxH) : 560 x 270 x 300mm
Individual packing : Polybag+Color label shrink



▶ **ST-51503**

Universal Tool Bag

- Multiple compartments for all storage needs with easy arrangement.
- Easy grip stainless steel bar handle.

30 kg Capacity	Repellent	600D Polyester
Wide Open Mouth	High Density Webbing	Shoulder Strap

Dimension (LxWxH) : 420 x 210 x 265mm
Individual packing : Polybag+Color label shrink



▶ **ST-5701**

Double Tray Tote Bag

- 6 pockets with 12 mesh bags for tool organize conveniently.
- Easy grip stainless steel bar handle.

30 kg Capacity	Repellent	600D Polyester
Wide Open Mouth	High Density Webbing	Shoulder Strap

Dimension (LxWxH) : 420 x 210 x 265mm
Individual packing : Polybag+Color label shrink



Tool Bag / Tool Pouch Series



- Various styles for multiple tool usage.
- Different size compartments designed for easy tools classify and storage.
- Made of lightweight and durable polyester providing extra strength and carrying comfort.
- Suitable for Pro'sKit™ Tool Belt / Wrist Band series as page 249.



Demo only

▶ ST-5102 Multi Purpose Tool Pouch



Demo only



Compact Size Great Organizer

Dimension (LxWxH) : 250 x 250 x 170mm
Individual packing : Polybag+Hanger

▶ ST-5105 Multi Purpose Tool Pouch



2 Style in 1 Open mouth & Covered pouch

Dimension (LxWxH) : 200 x 160 x 250mm
Individual packing : Polybag+Hanger

▶ ST-5204 Tool Pouch



Great for small parts or mobile.



Demo only

Dimension (LxWxH) : 115 x 70 x 140mm
Individual packing : Polybag+Hanger

▶ ST-5203 Power Tool Holster



Especially designed for power tools.



Demo only

Dimension (LxWxH) : 190 x 295 x 60mm
Individual packing : Polybag+Hanger

▶ ST-5208 General Purpose Tool Pouch



Demo only

Dimension (LxWxH) : 165 x 290 x 50mm
Individual packing : Polybag+Hanger

▶ ST-5502 7 cm Wide Tool Belt

15KG Capacity



Material	Loading capacity	Dimension	Individual packing
Polypropylene	15kg	Width: 7cm Length: 145cm	Poly bag+Hanger

▶ ST-5503 3.5 cm Wide Tool Belt

10KG Capacity



Material	Loading capacity	Dimension	Individual packing
Polypropylene	10kg	Width: 4cm Length: 115cm	Poly bag+Hanger

▶ ST-5601 Magnetic Wrist Band



Material	Loading capacity	Dimension	Individual packing
600DX600D Polypropylene	10kg	Width: 5.5cm Length: 30cm	Poly bag+Hanger

▶ ST-5504 Tool Belt With Safety Lock

Extra lock design,
prevent belt loosening

15KG Capacity

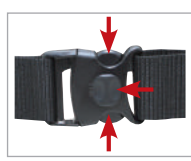

Material	Loading capacity	Dimension	Individual packing
Polypropylene	15kg	Width: 5cm Length: 145cm	Poly bag+Hanger

▶ TC-131 Heavy Duty Luggage Cart

- Fold flat for easy storage.
- Open quickly to hold up to 150lbs/68kg.
- Soft comfortable grip hand.
- Extra sturdy and lightweight construction.
- 5" 125mm large heavy duty wheels to go up and down stairs and curbs easily.
- Includes 2pcs on 100cm stretch band.

68 kg
KG



▶ TC-132 Folding Multi-Use Cart

- Constructed of durable steel, holds up to 99lbs/45KG.
- Soft TPR+PP padded handle for max. comfort.
- 4" 102mm large heavy duty wheels to go up and down stairs and curbs easily.
- Includes 1pc on 110cm bungee cord.

45 kg
KG

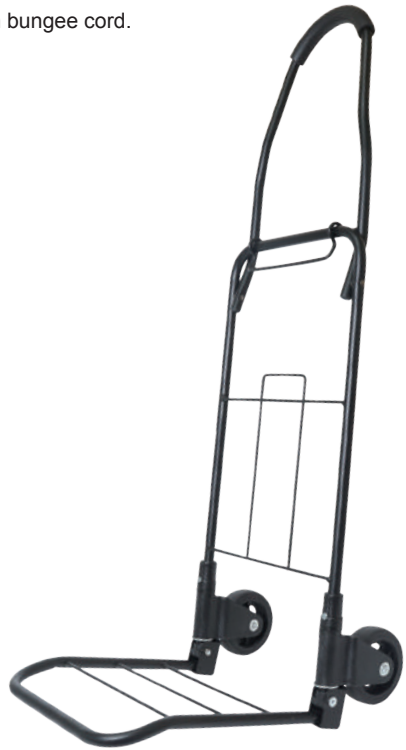

Material	Load capacity	Dimension (mm)	Weight (kg)	Individual packing
Body: Metal Platform: Aluminum steel Wheel: PP+TPU	68Kg (150lbs)	Fold: 385x 64x 763 Open: 385x 420x 1010 Platform: 385x280x6	3.5	Bulk

Material	Load capacity	Dimension (mm)	Weight (kg)	Individual packing
Body and platform: Metal Wheel: PP+TPR	45Kg (99lbs)	Fold: 298x 82x 656 Open: 330x 450x 1016 Platform: 310x298	2.89	Bulk

TOOL KITS



Behind every successful man, there is a tool kit.
And behind every tool kit, there is **Pro'sKit®**.



Pro'sKit®

886-2-22183233
Sales support

pk@mail.prokits.com.tw
E-mail

www.prokits.com.tw
Global website

PK-601

Modeler Basic Craft Tool Set

A must-have tool kit for model assembly.
Right tool just makes everything right.

PK-601 contents	
PM-396F	Stainless cutting plier
9SD-807	⊖ Precision screwdriver -3.0x75mm
9SD-808	⊕ Precision screwdriver PH1x75mm
9K002A	Flat file
9K002B	Diamond flat file
1PK-125T	Super fine tip straight tweezers

• Individual packing: Plastic box & Color sleeve



PK-2076B

Deluxe Basic Tool Kit

PK-2076B (Metric) contents	
PM-736	Dual color long nose plier 135mm
PM-737	Dual color diagonal cutting plier 115mm
1PK-H026	Adjustable wrench 6"
9FL-005	Mini flash light
9H032	Ratchet handle
9H035	10 pcs bit pack
9H038	Extension bar
9H043	Magnetic bit adaptor: 60mm(L)
DK-2039	Utility knife (3 blades self loading)
9H043A	6 pcs socket pack: 5, 6, 7, 8, 9, 10mm (metric)
9ST-43	Tool bag

• Bag size: 207x127.5x40 (mm)
• Individual packing: Inner box & Color label shrink



Ratcheting screwdriver
with double end design.

PK-2080

Compact Kit

PK-2080 contents	
PM-736	Dual color long nose plier 135mm
PM-737	Dual color diagonal cutting Plier 115mm
8PK-2061	⊕ Electronic screwdriver: #00, #0, #1
	⊖ Electronic screwdriver: 1.4, 1.8, 2.4
SD-5107D	⊕ Double-end reversible screwdriver #2/6 mm
1PK-125T	Fine tip straight tweezers
9ST-43	Tool bag

• Bag size: 207x127.5x40 (mm)
• Individual packing: Color sleeve shrink



1PK-640

Compact Kit

1PK-640 contents	
1PK-258A	Side cutter 125mm
1PK-258B	Long nose plier 138mm
1PK-H026	Adjustable wrench 6"
89102A	⊖ Line color screwdriver 5.0x75mm
89102B	⊕ Line color screwdriver #1x75mm
89107A	⊖ Line color screwdriver 6.0x100mm
89107B	⊕ Line color screwdriver #2x100mm
9ST-43	Tool bag

• Bag size: 207x127.5x40 (mm)
• Individual packing: Inner box & Color label shrink



• NOTE : For quality reason. we reserve the right to change the above specifications without notice.

**1PK-301****10 PCS Compact Tool Kit**

1PK-301 contents	
1PK-036S	Long nose plier 135mm
1PK-037S	Diagonal cutting plier 110mm
1PK-125T	Fine tip straight tweezer
89401A	⊖ Pro-soft s/d 3.2x75mm
89401B	⊕ Pro-soft s/d #0x75mm
908-395E-3	Precision screwdriver 2.4mm
908-395E-5	Precision screwdriver #0
9K003A-1	Needle file flat
9K003B-1	Needle file round
DK-2039	Utility knife (3 blades self loading)
908-801A	Zipper carrying bag

- Bag size: 205x144x35 (mm)
- Individual packing: Inner box & Color label shrink

**1PK-635****Precision Electronic Tool Kit**

1PK-635 contents	
1PK-125T	Fine tip straight tweezer
1PK-258A	Side cutter 125mm
1PK-258B	Long nose plier 138mm
SD-081-P2	⊕ Precision screwdriver #00x50mm
SD-081-P3	⊕ Precision screwdriver #0x50mm
SD-081-P4	⊕ Precision screwdriver #1x50mm
SD-081-S2	⊖ Precision screwdriver 1.6x50mm
SD-081-S3	⊖ Precision screwdriver 2.0x50mm
SD-081-S4	⊖ Precision screwdriver 2.4x50mm
SD-081-S5	⊖ Precision screwdriver 3.0x50mm
9ST-43	Zipper carrying bag

- Bag size: 207x127.5x40 (mm)
- Individual packing: Inner box & Color label shrink

**PK-2079****ESD Precision Tool Kit**

This precision pliers series made of high quality SK7, accurately machined design.



PK-2079 contents	
1PK-102-E	Long nose plier
1PK-104-E	Flat nose plier
1PK-105-E	Bent nose plier
1PK-209	Clean cut micro nipper
1PK-25P-E	Micro cutting plier 125mm
TZ-100A/B/C/D	4 pcs conductive tweezers set
AS-611	Wrist strap 10FT
SD-083-P2	⊕ ESD precision screwdriver #00
SD-083-P3	⊕ ESD precision screwdriver #0
SD-083-P4	⊕ ESD precision screwdriver #1
SD-083-S3	⊖ ESD precision screwdriver 2.0mm
SD-083-S4	⊖ ESD precision screwdriver 2.4mm
SD-083-S5	⊖ ESD precision screwdriver 3.0mm
9ST-23	Tool bag

- Bag size: 340x222.5x60 (mm)
- Individual packing: Inner box & Color label shrink

**PK-2091I/PK-2091M****Multi-Purpose Tool Kit**

PK-2091I (Inch) / PK-2091M (Metric) contents	
1PK-709	Long nose plier 160mm
1PK-H026	Adjustable wrench 6"
9HW-002A	7 pcs hex key set (inch) or (metric)
9HW-002B	
CP-108	Wire stripper cutter
DK-2040	Measuring tape 3M/10FT
PD-510	Quick point snap-blade knives
PN-086N	Slip joint plier 154mm
SD-5101A	⊖ Line color screwdriver 3.0x75mm
SD-5101B	⊕ Line color screwdriver #0x75mm
SD-5107A	⊖ Line color screwdriver 6.0x100mm
SD-5107B	⊕ Line color screwdriver #2x100mm
SD-5110A	⊖ Line color screwdriver 5.0x100mm
SD-5110B	⊕ Line color screwdriver #1x100mm
SD-5120A	⊕ Line color screwdriver 6.0x38mm
9ST-33	Tool bag

- Bag size: 255X172.5X55 (mm)
- Individual packing: Color sleeve shrink

• NOTE : For quality reason, we reserve the right to change the above specifications without notice.

PK-2623A/PK-2623B Professional Electronic Tool Kit

PK-2623A/PK-2623B contents		
MT-1132	3 1/2 Digital multimeter	
SI-130A-20	Ceramic soldering iron (110V or 220V)	
SI-130B-20		
9SD-201A	⊖	Pro-soft screwdriver (-3.0 3.0x75mm)
9SD-201B	⊕	Pro-soft screwdriver (#0 3.0x75mm)
9SD-202A	⊖	Pro-soft screwdriver (-5 5x75mm)
9SD-202B	⊕	Pro-soft screwdriver (#1 5x75mm)
9SD-207A	⊖	Pro-soft screwdriver (-6 6x100mm)
9SD-207B	⊕	Pro-soft screwdriver (#2 6x100mm)
8PK-366N-G	Desoldering pump	8PK-605A 5 pcs needle file set
908-609	IC extractor	9S001 Solder wire 63% SN
8PK-611	Wrist strap 10ft	CP-3001D Precision wire stripper
9PK-258A	Long nose plier	9PK-258B Cutting plier (130mm)
TZ-204N	Ergo-grip tweezer	9ST-23 Tool bag

- Bag size: 340x222.5x60 (mm)
- Individual packing: Inner box & Color label shrink

Model No.	Soldering voltage	Standard plug
PK-2623A	110V	A
PK-2623B	220~240V	B



1PK-302NA/1PK-302NB Personal Computer Tool Kit

1PK-302NA/1PK-302NB contents		
1PK-036S	Long nose plier 135mm	
1PK-125T	Fine tip straight tweezer	
1PK-H026	Adjustable wrench 6"	
SI-130A-20	Ceramic soldering iron 110V or 220V	
SI-130B-20		
89400-T10	⊖	Pro-soft s/d T10/T15
89400-T15	⊕	Pro-soft s/d T10/T15
89401A/89402A	⊖	Pro-soft s/d 3.2x75mm / 5.0x75mm
89401B/89402B	⊕	Pro-soft s/d #0x75mm / #1x75mm
19400-M5/9408	⊖	Pro-soft s/d 3/16"(inch) or 5mm(metric)
19400-M6/9409	⊕	Pro-soft s/d 1/4"(inch) or 6mm(metric)
8PK-154	Brush	8PK-3161 7 in 1 crimping tool
8PK-366N-G	Desoldering pump	908-609 IC extractor
9H003	3 pring holder	9H007 IC insert tool
9S001	Solder core 63% SN	8PK-611 Wrist strap 10FT
908-821A	Zipper carrying bag	

- Bag size: 325x195x48 (mm)
- Individual packing: Inner box & Color label shrink

Model No.	Soldering voltage	Standard plug
1PK-302NA (Inch)	110V	A
1PK-302NB(Metric)	220~240V	B



1PK-810A/1PK-810B Computer Service Tool Kit

1PK-810A/1PK-810B contents		
1PK-036S	Long nose plier 135mm	
1PK-037S	Diagonal cutting plier 110mm	
1PK-125T	Fine tip straight tweezer	
9S002A/B/C	3 pcs soldering aid tools	
1PK-H026	Adjustable wrench 6"	
SI-130A-20	Ceramic soldering iron 110V or 220V	
SI-130B-20		
19412	Screwdriver handle	
89402A	⊖	Pro-soft s/d 5.0x75mm
89402B	⊕	Pro-soft s/d #1x75mm
8PK-031B	Desoldering wick	
8PK-313A	Crimping tool (inch) or (metric)	
8PK-313B		
8PK-366N-G	Desoldering pump	908-609 IC extractor
9H003	3 prong holder	9H005 IC insert tool
9S001	Solder core 63% SN	9S003N Parts tube
9S004	Heat sink	9SD030-2 8 pcs bits pack
9Z-007A	Zipper carrying bag	

- Bag size: 325x195x48 (mm)
- Individual packing: Inner box & Color label shrink

Model No.	Soldering voltage	Standard plug
1PK-810A (Inch)	110V	A
1PK-810B(Metric)	220~240V	B



1PK-618A / 1PK-618B Maintenance Kit

1PK-618A / 1PK-618B contents		
1PK-052	Lineman's plier 165mm	
1PK-067	Side cutting plier 160mm	
1PK-709	Long nose plier 160mm	
1PK-H026	Adjustable wrench 6"	
SI-130A-20	Ceramic soldering iron 110V or 220V	
SI-130B-20		
89101A	⊖	Line color screwdriver 3.2x75mm
89101B	⊕	Line color screwdriver #0x75mm
89102B	⊕	Line color screwdriver #1x75mm
89107A	⊖	Line color screwdriver 6.0x100mm
89107B	⊕	Line color screwdriver #2x100mm
9108	Line color screwdriver nut 3/16"	
908-607	Alignment tool (200mm/2.0mm)	
9H002/9H002A	7 pcs folding type hex key set (inch) or (metric)	
DK-2039	Utility knife (3 blades self loading)	
DK-2040	Measuring tape 3M/10FT	
9K003A-1	Needle file flat	9K003B-1 Needle file round
908-328G	Testing screwdriver	PN-086N Slip joint plier 154mm
9IT	PVC insulated tape	908-818A Zipper carrying bag

- Bag size: 310x240x48 (mm)
- Individual packing: Inner box & Color label shrink

Model No.	Soldering voltage	Standard plug
1PK-618A (Inch)	110V	A
1PK-618B(Metric)	220~240V	B



• NOTE : For quality reason, we reserve the right to change the above specifications without notice.

▶ 1PK-690A/1PK-690B Professional Electrical Tool Kit



Model No.	Soldering voltage	Standard plug
1PK-690A	110V	A
1PK-690B	220~240V	B

1PK-690A/1PK-690B contents		
1PK-036S	Long nose plier 135mm	
1PK-037S	Diagonal cutting plier 110mm	
1PK-3171	Spring hook	
1PK-H026	Adjustable wrench 6"	
SI-130A-20	Ceramic soldering iron 110V or 220V	
SI-130B-20		
89401A	⊖ Pro-soft s/d 3.2x75mm	
89401B	⊕ Pro-soft s/d #0x75mm	
89402A	⊖ Pro-soft s/d 5.0x75mm	
89402B	⊕ Pro-soft s/d #1x75mm	
8PK-033	Crimping tool 8"	
8PK-366N-G	Desoldering pump	
908-607	Alignment tool (200mm/2.0mm)	
9H003	3 prong holder	9H032 Ratchet handle
9H035	10 pcs bit pack	9H036 9 pcs socket
DK-2039	Utility knife (3 blades self loading)	
9ST-23	Tool bag	

- Bag size: 340x222.5x60 (mm)
- Individual packing: Inner box & Color label shrink

▶ 1PK-612NA / 1PK-612NB School Tool Kit



Model No.	Solderin voltage	Standar plug
1PK-612NA (Inch)	110V	A
1PK-612NB(Metric)	220~240V	B

1PK-612NA/1PK-612NB contents		
103-132C	Utility component storage box	
1PK-125T	Fine tip straight tweezer	
1PK-258A	Side Cutter 125mm	
1PK-258B	Long nose plier 138mm	
SI-130A-20	Ceramic soldering iron 110V or 220V	
SI-130B-20		
89401A	⊖ Pro-soft s/d 3.2x75mm	
89401B	⊕ Pro-soft s/d #0x75mm	
89402A	⊖ Pro-soft s/d 5.0x75mm	
89402B	⊕ Pro-soft s/d #1x75mm	
89407A	⊖ Pro-soft s/d 6.0x100mm	
89407B	⊕ Pro-soft s/d #2x100mm	
8PK-154	Brush	
8PK-362S	Mini soldering stand with sponge	
8PK-366N-G	Desoldering pump	
908-609A	IC extractor	
9H002/9H002A	7 pcs folding type hex key set (inch) or (metric)	
9S001	Solder core 63%, SN	
DK-2039	Utility knife (3 blades self loading)	
9ST-23	Tool bag	

- Bag size: 340x222.5x60 (mm)
- Individual packing: Inner box & Color label shrink

▶ 1PK-636B Electrical Tool Kit



Model No.	Soldering voltage	Standard plug
1PK-636B(Metric)	220~240V	B

1PK-636B contents	
1PK-052DS	Dual color lineman's plier 165mm
1PK-067DS	Dual color side cutting plier 165mm
1PK-125T	Fine tip straight tweezer
1PK-709DS	Dual color long nose plier 165mm
1PK-H026	Adjustable wrench 6"
SI-130B-20	Ceramic soldering iron AC 220V
89401B	⊕ Pro-soft s/d #0x75mm
89402A	⊖ Pro-soft s/d 5.0x75mm
89402B	⊕ Pro-soft s/d #1x75mm
89407A	⊖ Pro-soft s/d 6.0x100mm
89407B	⊕ Pro-soft s/d #2x100mm
8PK-031B	Desoldering wick
9ST-23	Tool bag

- Bag size: 340x222.5x60 (mm)
- Individual packing: Inner box & Color label shrink

▶ PK-2086A / PK-2086B Basic Electrical Kit



Model No.	Soldering voltage	Standard plug
PK-2086A	110V	E
PK-2086B	220~240V	B

PK-2086A / PK-2086B contents	
1PK-052	Lineman's plier 165mm
1PK-067	Side cutting plier 160mm
1PK-709	Long nose plier 160mm
1PK-H026	Adjustable wrench 6"
9DP-031B	Desoldering wick
9DP-S001	Solder core 63%, SN
9SD-205A	⊖ Pro-soft screwdriver 3.0x100mm
9SD-205B	⊕ Pro-soft screwdriver #0x100mm
9SD-207B	⊕ Pro-soft screwdriver #2x100mm
9SD-210A	⊖ Pro-soft screwdriver 5.0x100mm
9SD-210B	⊕ Pro-soft screwdriver #1x100mm
SI-S106A	Convertible soldering iron/gun 110V or 220V
SI-S106B	
1PK-125T	Fine tip straight tweezer
9ST-33	Zipper carrying bag

- Bag size: 255x172.5x55 (mm)
- Individual packing: Color sleeve shrink

• NOTE : For quality reason, we reserve the right to change the above specifications without notice.

PK-2625 Light Current Engineering Repair Tools Kit

MT-1509

Pocket Autorange Multimeter

- Auto selection and auto range
- Non-contact ACV detector
- One touch smart meter
- LED flashlight

P.19



Ideal for **light current system**,
such as

**Building Automation System(BAS),
Fire Alarm System(FAS),
Closed-Circuit Television(CCTV),
Community Antenna Television(CATV)**
and more.

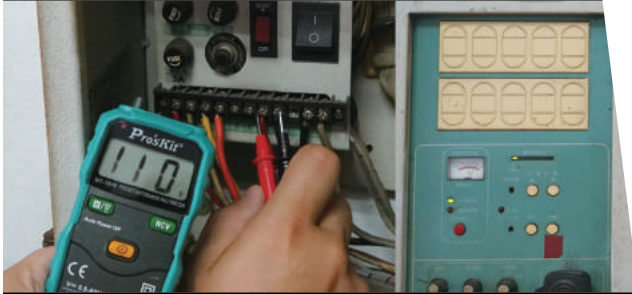

PT-1362U

USB Li-ion Cordless Screwdriver 3.6V

- USB charging
- Powerful 350 rpm/3 Nm torque
- Japan SANYO Li-ion battery

P.171



PK-2625 contents

PM-903	Lineman's Plier (225mm) Black Oxide Finish 9"
PM-908	Side Cutting Plier (160mm) Black Oxide Finish 6"
PM-909	Long Nose Plier (170mm) Black Oxide Finish 6"
MT-1509	Pocket Autorange Multimeter
CP-415	Cutter Stripper & Crimper
PT-1362U	USB Li-ion Cordless Screwdriver 3.6V
9ST-23	Tool Bag

- Bag size: 340x222.5x60 (mm)
- Individual packing: Inner box & Color label shrink

1PK-639 Electrical Tool Kit



1PK-639 contents

1PK-067AS	Side cutting plier 160mm
1PK-125T	Fine tip straight tweezer
1PK-709AS	Snipe nose pier 165mm
8PK-BL002	Cabling splicing knife

8PK-2066

7 pcs interchangeable S/D:

⊕	3/16x130	1/4x130
⊕	No.1x130	No.2x130
⊕	5.5x130	
⊕	AWLx130	

9ST-43

Tool bag

- Case size: 207x127.5x40 (mm)
- Individual packing: Inner box & Color label shrink

1PK-816N 1000V Hi-insulated Tool Kit



1PK-816N contents

1PK-052AS	Combination plier 165mm
1PK-067AS	Side cutting plier 160mm
1PK-709AS	Snipe nose pier 165mm
9PK-8100E-#0	⊕ Insulation s/d #0
9PK-8100E-#1	⊕ Insulation s/d #1
9PK-8100E-#2	⊕ Insulation s/d #2

9PK-8100E-2.5	⊕ Insulation s/d 2.5mm
9PK-8100E-4	⊕ Insulation s/d 4.0mm
9PK-8100E-5.5	⊕ Insulation s/d 5.5mm
9PK-8100E-6.5	⊕ Insulation s/d 6.5mm
9Z-016	Zipper carrying bag

- Bag size: 325x195x48 (mm)
- Individual packing: Inner box & Color label shrink

• NOTE : For quality reason, we reserve the right to change the above specifications without notice.

▶ 1PK-813A / 1PK-813B Basic Electronic Tool Kit



Model No.	Soldering voltage	Standard plug
1PK-813A (Inch)	110V	A
1PK-813B(Metric)	220-240V	B

1PK-813A/1PK-813B contents	
1PK-052	Lineman's plier 165mm
1PK-067	Side cutting plier 160mm
1PK-709	Long nose plier 160mm
1PK-125T	Fine tip straight tweezer
1PK-H026	Adjustable wrench 6"
SI-130A-20	Ceramic soldering iron 110V or 220V
SI-130B-20	
19400-M5/9408	⊖ Pro-soft s/d 3/16" (inch) or 5mm (metric)
19400-M6/9409	⊖ Pro-soft s/d 1/4" (inch) or 6mm (metric)
89401A	⊖ Pro-soft s/d 3.2x75mm
89401B	⊕ Pro-soft s/d #0x75mm
89402A	⊖ Pro-soft s/d 5.0x75mm
89402B	⊕ Pro-soft s/d #1x75mm
89407A	⊖ Pro-soft s/d 6.0x100mm
89407B	⊕ Pro-soft s/d #2x100mm
89413B	⊕ Pro-soft s/d #2x107mm
8PK-031B	Desoldering wick
8PK-366N-G	Desoldering pump
908-607	Alignment tool (200mm/2.0mm)
9IT	PVC insulated tape
9K003A-1	Needle file flat
9K003B-1	Needle file round
9S001	Solder core 63%, SN
9Z-013	Zipper carrying bag

- Bag size: 350x220x55 (mm)
- Individual packing: Inner box & Color label shrink

▶ PK-2096BM Computer & Notebook Service Kit



3 adjustable angle with high quality motor makes PT-1136F a great helper in repair work.

Model No.	Soldering voltage	Standard plug
PK-2096BM(Metric)	220V	B

PK-2096BM contents	
1PK-036S	Long nose plier (135mm)
1PK-037S	Diagonal cutting plier (110mm)
1PK-046S	Needle nose plier (150mm)
1PK-125T	Super fine tip straight tweezer (120mm)
SI-130B-20	Ceramic soldering iron 12W, 410°C(220v)
908-609	IC extractor
9DP-3616A	Square scraper/stainless steel brush
9DP-3616B	Slotted shaft/split 45 lever
9DP-3616C	Tapered reamer/tapered needle
9DP-3616D	Offset chip holder/45 chip holder
9H003	3 Prong holder
SD-2315M	Screwdriver handle, 4pcs 1/4"x50mm bits: ⊕ #1, #2, ⊖ 5.0, 6.0mm
	Extension blade 1/4"x30mm,
	9Pcs 1/4"x25mm socket set: ⊖ 5, 6, 7, 8, 9, 10, 11, 12, 13
AS-611	Wrist strap 10ft
DP-366D	Desoldering pump
PT-1136F	3.6V cordless screwdriver 220
9ST-23	Tool bag

- Bag size: 340x222.5x60 (mm)
- Individual packing: Color box

▶ PK-2087A / PK-2087B Maintenance Kit



Model No.	Soldering voltage	Standard plug
PK-2087A (Inch)	110V	A
PK-2087B(Metric)	220-240V	B

PK-2087A / PK-2087B contents	
1PK-067	Side cutting plier 160mm
1PK-606A	3 pcs anti-static alignment tool kit
1PK-709	Long nose plier 160mm
1PK-H026	Adjustable wrench 6"
9K003A-1	Needle file flat
9K003B-1	Needle file round
SI-130A-20	Ceramic Soldering iron 12W (110V or 220V)
SI-130B-20	
9DP-031B	Desoldering wick
9DP-S001	Solder core 63%, SN
9HW-002A/B	7 pcs Hex key set (inch) or (metric)
9MS-001	PVC insulated tape
9SD-200-11/M5	⊖ Pro-soft screwdriver 3/16"(inch) or 5mm(metric)
	⊖ Pro-soft screwdriver 1/4"(inch) or 6mm(metric)
9SD-200-12/M6	⊖ Pro-soft screwdriver 1/4"(inch) or 6mm(metric)
DK-2040	Measuring tape 3M/10FT
PD-510	Quick point snap-blade knives
PN-088N	Slip joint plier 154mm
9SD-205A	⊖ Pro-soft screwdriver 3.0x100mm
9SD-205B	⊕ Pro-soft screwdriver #0x100mm
9SD-207A	⊖ Pro-soft screwdriver 6.0x100mm
9SD-207B	⊕ Pro-soft screwdriver #2 x100mm
9SD-210A	⊖ Pro-soft screwdriver 5.0x100mm
9SD-210B	⊕ Pro-soft screwdriver #1x100mm
1PK-125T	Fine tip straight tweezer
9ST-23	Tool bag

- Bag size: 340x222.5x60 (mm)
- Individual packing: Color sleeve shrink

• NOTE : For quality reason, we reserve the right to change the above specifications without notice.

PK-2090EI/PK-2090BM Tool Set

PK-2090EI/PK-2090BM contents

1PK-052	Lineman's plier 165mm
1PK-067	Side cutting plier 160mm
DP-366P	Desoldering pump
1PK-709	Long nose plier 160mm
9DP-031B	Desoldering wick
9DP-S001	Solder core 63%, SN
9HW-002A	7 pcs hex key set (inch) or (metric)
9HW-002B	7 pcs hex key set (inch) or (metric)
DP-3615	Solder aid tools
PD-510	Quick point snap-blade knives
SD-5102A	⊖ Line color screwdriver 5.0x75mm
SD-5102B	⊕ Line color screwdriver #1x75mm
SD-5107A	⊖ Line color screwdriver 6.0x100mm
SD-5107B	⊕ Line color screwdriver #2x100mm
SD-5114B	⊕ Line color screwdriver #2x200mm
SD-5116A	⊖ Line color screwdriver 5.0x150mm
SI-S106A	Convertible soldering iron/gun 110V or 220V
SI-S106B	Convertible soldering iron/gun 110V or 220V
1PK-125T	Fine tip straight tweezer
9ST-23	Tool bag

Model No.	Standard plug
PK-2090EI (Inch)	E
PK-2090BM(Metric)	B



- Bag size: 340x222.5x60 (mm)
- Individual packing: Inner box & Color sleeve shrink

PK-2088A/PK-2088B PC Service Kit

PK-2088A/PK-2088B contents

1PK-036S	Long nose plier 135mm
1PK-037S	Diagonal cutting plier 110mm
1PK-H026	Adjustable wrench 6"
SI-130A-20	Ceramic Soldering iron 12W 110V or 220V
SI-130B-20	Ceramic Soldering iron 12W 110V or 220V
9DP-031B	Desoldering wick
DP-366D	Desoldering pump
9DP-3616A	Square scraper/Stainless steel brush
9DP-3616B	Slotted shaft/Split 45 lever
9DP-3616C	Tapered reamer/Tapered needle
9DP-S001	Solder core 63%, SN
9SD-200-11/M5	⊖ Pro-soft screwdriver 3/16"(inch) or 5mm(metric)
9SD-200-12/M6	⊖ Pro-soft screwdriver 1/4"(inch) or 6mm(metric)
AS-501A	Long handle static brush (40mm)
CP-108	Wire stripper cutter
AS-611	Wrist strap 10FT
9SD-200-T10H	⊕ Pro-soft screwdriver T10Hx75mm
9SD-200-T15H	⊕ Pro-soft screwdriver T15Hx75mm
9SD-201A	⊖ Pro-soft screwdriver 3.0x75mm
9SD-201B	⊕ Pro-soft screwdriver #0x75mm
9SD-202A	⊖ Pro-soft screwdriver 5.0x75mm
9SD-202B	⊕ Pro-soft screwdriver #1x75mm
1PK-108T	Reverse action tweezer
1PK-125T	Fine tip straight tweezer
9S004	Heat sink 9H003 3 prong holder
908-609	IC extractor PD-610 PLCC extractor
9ST-PK2088	Zipper carrying bag

Model No.	Soldering voltage	Standard plug
PK-2088A (Inch)	110V	A
PK-2088B(Metric)	220~240V	B



- Bag size: 265x330x45 (mm)
- Individual packing: Color sleeve shrink

1PK-616A / 1PK-616B Professional Electronic Tool Kit

1PK-616A/1PK-616B contents

1PK-052	Lineman's plier 165mm
1PK-258A	Side cutter 125mm
1PK-709	Long nose plier 160mm
1PK-362D	Soldering iron stand with sponge
DP-366P	Desoldering pump
SI-130A-20	Ceramic soldering iron 110V or 220V
SI-130B-20	Ceramic soldering iron 110V or 220V
89101A	⊖ Line color screwdriver 3.2x75mm
89101B	⊕ Line color screwdriver #0x75mm
89102A	⊖ Line color screwdriver 5.0x75mm
89102B	⊕ Line color screwdriver #1x75mm
89107A	⊖ Line color screwdriver 6.0x100mm
89107B	⊕ Line color screwdriver #2x100mm
9108	⊖ Line color screwdriver nut 3/16"
9109	⊖ Line color screwdriver nut 1/4"
8PK-2061	6 pcs electronic screwdriver set
MT-1210	3-1/2 compact digital multimeter
9H002 9H002A	7 pcs folding type hex key set (inch) or (metric)
9IT	PVC insulated tape
9S001	Solder core 63%, SN
9ST-23	Tool bag

Model No.	Soldering voltage	Standard plug
1PK-616A (Inch)	110V	A
1PK-616B(Metric)	220~240V	B



- Bag size: 340x222.5x60 (mm)
- Individual packing: Inner box & Color label shrink

• NOTE : For quality reason, we reserve the right to change the above specifications without notice.

Household Tool Kit

PK-2056 General Household Repair Kit

Includes full range of bits, sockets and hand tools that you need for tacking all assembly, maintenance, repair projects around the home or office.



- Case size: 400x310x80(mm)
- Individual packing: Color sleeve shrink



Metal lock



New stylish design



The T-handle with ratchet design permits greater force saving and comfort.

PK-2056 contents	
1PK-H028	Adjustable wrench - 8"
9MS-001	PVC insulated tape
PD-513	Utility knife
PD-2612	8 oz curved claw hammer
1PK-052DS	Dual color lineman's plier (165mm)
1PK-709DS	Dual color long nose plier (165mm)
NT-306	Non-contact voltage detector
9DK-2060	3M auto stop measuring tape
FL-516	9Pcs LED flashlight
HW-129	9Pcs long arm hex key set
9SD-2320-BIT	9pcs 1/4" bits: ⊖ 3,5,6, ⊕ PH1,PH2,PH3, ⊕ T10,T15,T20, adaptor
9SD-2320-SOC	6Pcs 1/4in drive sockets: ⊕ 5.0/6.0/7.0/8.0/9.0/10.0/11.0/12.0/13.0mm
9SD-2320M-EXT	1Pce extension bar (100mm)
9SD-2321M-HAN	1Pce mini T-handle ratchet driver
9SD-9857M-ADP	1Pce adapter 1/4" to 4mm adaptor
9SD-9857M-BIT1	⊖ 1.5,2.0,2.5,3.0,3.5 ⊕ PH00,PH0, PH1, PH2,PH3
9SD-9857M-BIT2	⊕ T4,T5,T6,T8,T10 ⊖ 0.9,1.3,1.5,2.0,2.5mm
9SD-9857M-HAN	Handle
MS-330	101 pcs home hardware assortment
9SB-2056	HDPE blow box

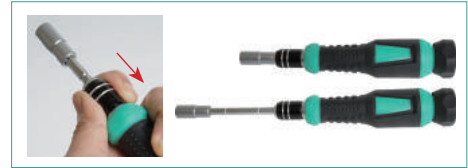

The T-handle with ratchet Adjustable 3-length extension bar up-to 115mm long, ideal for adjusting and accessing fasteners in narrow areas.

PK-2028T Household Tool Kit



PK-2028T contents	
1PK-052	Lineman's plier (165mm)
1PK-709	Long nose plier (160mm)
1PK-H028	Adjustable wrench - 8"
9MS-001	PVC insulated tape
9SD-329H	Screwdriver probe voltage tester
DK-2040	Measuring tape (3m/10ft)
FL-506	Led flashlight
HW-221M	8pcs aluminum case folding hex key (1.5,2,2.5,3,4,5,6,8mm)
PD-2609	8 oz curved claw hammer

SD-5107D	Double-end reversible screwdriver (#2/-6.0X100mm)
SD-9814	9 In 1 aluminum handle precision screwdriver set
SR-330	All purpose snip (165mm)
SW-106	6" Junior multi-purpose saw
9SB-207	Plastic tool box

- Case size: 320x260x60(mm)
- Individual packing: Color sleeve shrink

PK-2030T General Household Tool Kit



PK-2030T contents	
1PK-052DS	Dual color lineman's plier (165mm)
9MS-001	PVC insulated tape
9SD-329H	Screwdriver probe voltage tester
9DK-2060	Auto stop measuring tape (3m)
HW-008N	Adjustable wrench - 8"
HW-023	8Pcs ring type hex Key set (1.5,2,2.5,3,4,5,5.5,6Mm)
PD-2612	8 Oz curved claw hammer
PD-513	Utility knife

SD-9814	9 In 1 aluminum handle precision screwdriver set
SD-9817	6 In 1 ratchet screwdriver set
9SB-207	Plastic tool box

- Case size: 320x260x60(mm)
- Individual packing: Color sleeve shrink

• NOTE : For quality reason, we reserve the right to change the above specifications without notice.



▶ PK-2052TA/PK-2052TB

Technician's Tool Kit

PK-2052TA/PK-2052TB contents

1PK-052	Lineman's plier (165mm)
1PK-067	Side cutting plier (160mm)
1PK-125T	Super fine tip straight tweezers (120mm)
1PK-709	Long nose plier (160mm)
9DK-2060	Auto stop measuring tape (3m)
9MS-001	PVC insulated tape
9SD-329H	Screwdriver probe voltage tester
CP-412G	Heavy duty wire strippers/crimpers(8")
DP-366D	Desoldering pump
FL-516	9Pcs LED flashlight
HW-008N	Adjustable wrench - 8"
MT-1210	3 1/2 Compact digital multimeter
PD-2612	8 oz curved claw hammer
SD-5105A	⊖ Line color screwdriver (-3.0X 100mm)
SD-5105B	⊕ Line color screwdriver (#0 x 100mm)
SD-5107A	⊖ Line color screwdriver (-6.0 X 100mm)
SD-5107B	⊕ Line color screwdriver (#2 x 100mm)
SD-9608	30Pcs aluminum handle precision Screwdriver set
SI-130A-20/ SI-130B-20	Ceramic soldering iron (110V or 220V)
8PK-154	Brush
9DP-S001	Pen solder 63%
9SB-3935	Tool box
PD-513	Utility knife
AS-611	Wrist strap 10ft

- Case size: 390x350x90 (mm)
- Individual packing: Color sleeve shrink



▶ PK-2051T

General Household Tool Kit

PK-2051T contents

1PK-067	Side Cutting Plier (160mm)
1PK-709	Long Nose Plier (160mm)
9DK-2060	Auto Stop Measuring Tape (3M)
9MS-001	PVC Insulated Tape
9SD-329H	Screwdriver Probe Voltage Tester
FL-516	9PCS LED Flashlight
HW-008N	Adjustable Wrench - 8"
HW-221M	8PCS Aluminum Case Folding Hex Key (1.5,2,2.5,3,4,5,6,8mm)
PD-513	Utility Knife
SD-5101A	⊖ Line Color Screwdriver (-3.0x 75mm)
SD-5101B	⊕ Line Color Screwdriver (#0 x 75mm)
SD-5107A	⊖ Line Color Screwdriver (-6.0 x 100mm)
SD-5107B	⊕ Line Color Screwdriver (#2 x 100mm)
SD-9608	30pcs Aluminum Handle Precision Screwdriver set
SR-330	All Purpose Snip (165mm)
9SB-207	Plastic Tool Box

- Case size: 320x260x60 (mm)
- Individual packing: Color sleeve shrink



▶ PK-2015

Deluxe Basic Tool Kit

PK-2015 contents

1PK-H028	Adjustable wrench 8"
9FL-506	LED Flash Light
1PK-709	Long nose plier (160mm)
DK-2039	Utility Knife (3 Blades self loading)
1PK-052	Lineman's plier (165mm)
9SD-329H	Screwdriver Probe Voltage Tester
DK-2040	Measuring tape 3M/10FT
SD-5107D	Double-End Reversible Screwdriver (⊕ #2 / ⊖ 6.0x100mm)
HW-221M	8PCS Aluminum Case Folding Hex Key
SD-9814	9 in 1 Aluminum Handle Precision Screwdriver Set
9MS-001	PVC Insulated Tape
SW-106	Junior Multi-Purpose Saw
PD-2609	8 oz curved claw Hammer
9PK-2015-P1	Pallet for PK-2015
9PK-2015-P2	Pallet for PK-2015
SB-207P	Plastic Tool Box (with 2 pallets of PK-2015)

- Case size: 320x260x60 (mm)
- Individual packing: Color sleeve shrink



• NOTE : For quality reason, we reserve the right to change the above specifications without notice.

3D Printer Form Finishing Tool Kit

PK-3D01 offers a total solution to Finish, Repair and Modify 3D printed parts. All the essentials you need to quickly and neatly remove ABS and PLA rafts, trim and polish printed objects, and more—are included in PK-3D01! Ideal for Professionals, Hobbyists, and Makers.



TOOL KITS

MS-9328

3D printer 3" Palette Knives

- Stainless wide blade helps to remove prints without dropping.
- Clean and ensure the finer details are neatly finished, and more.



P.226

PT-5205U

3.7V USB Li-ion Mini Grinder Set

- USB charging
- 5000/1000/15000 rpm speed
- Assorted accessories for a variety of techniques



P.171

PD-392

3D Printer Carving Knife Set

- Quality constructed
- Long lasting hardened SK2 blade

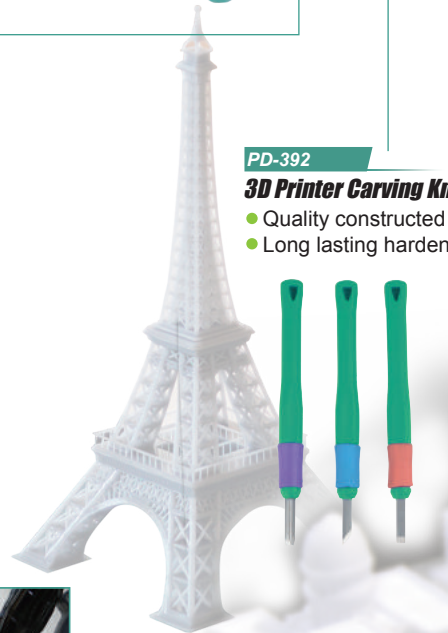

P.71



Cutting



Precision engraving

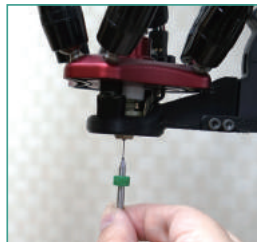

Cleaning



Polishing



Precision sanding



Engraving

PK-3D01 contents	
PM-805E	Plastic cutting plier (135mm)
1PK-036S	Long nose plier (136mm)
HW-229B	9Pcs ball point long arm hex key set
1PK-125T	Super fine tip straight tweezer (120mm)
8PK-605A	5Pcs needle file set
AS-501A	Long handle static brush (40mm)
PT-5205U	3.7V usb li-ion mini grinder set
1PK-H026	Adjustable wrench - 6"
SD-5107D	Double-end reversible screwdriver(#2/-6.0X100mm)
MS-710	Anti-fog UV protective glasses
9MS-001	PVC insulated tape
9MS-135	Mini brass wire brush
PD-392	3D printer carving knife set
MS-9328	3D printer 3" palette knives
9KS001	#320 Modeler sandpaper
9KS002	#500 Modeler sandpaper
9KS003	#800 Modeler sandpaper
9KS004	#1000 Modeler sandpaper
9MS-531	3D printer nozzle cleaning drill bit
SB-4121	Multi-function tool box with removable tobe tray

- Case size: 410x210x185 (mm)
- Individual packing: Color sleeve

• NOTE : For quality reason, we reserve the right to change the above specifications without notice

3D Printer Tool Kit

A **basic combination** to maintain and clean up 3D Models. It makes 3D printing easy and the printed results spectacular. Ideal for Hobbyists and Makers.



MS-9328

3D printer 3" Palette Knives

- Stainless wide blade helps to remove prints without dropping.
- Clean and ensure the finer details are neatly finished, and more.



P.226

PD-392

3D Printer Carving Knife Set

- Quality constructed, long lasting hardened steel blade



P.71

PM-805E

Plastic cutting plier

- Clean and smooth cutting
- Particularly design for precision field



P.55

PK-3D02	contents
PM-805E	Plastic cutting plier (135mm)
1PK-036S	Long nose plier (136mm)
HW-121M	8pcs folding hex key set
1PK-125T	Super fine tip straight tweezers (120mm)
9K003A-1	Needle file flat
AS-501A	Long handle static brush (40mm)
PD-392	3D printer carving knife set
MS-9328	3D printer 3" palette knives
9KS001	#320 Modeler sandpaper
9KS002	#500 Modeler sandpaper
9KS003	#800 Modeler sandpaper
9KS004	#1000 Modeler sandpaper
9MS-531	3D printer nozzle cleaning drill bit
9ST-33	Tool bag

- Bag size: 255x172.5x55(mm)
- Individual packing: Color label shrink



Cutting



Cutting

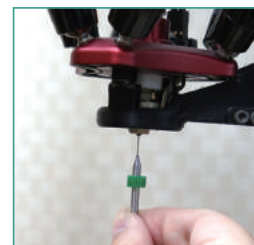

Cleaning



Removing prints from build platform

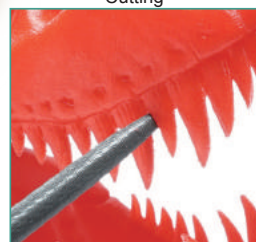

Precision sanding



Polishing

• NOTE : For quality reason, we reserve the right to change the above specifications without notice.



1PK-710KA/1PK-710KB

Basic Electronic Tool Kit

Ceramic Soldering Iron



- Soft touch
- Scratch proof



3-1/2 Compact Digital Multimeter

Model No.	Soldering voltage	Standard plug
1PK-710KA(Inch)	110V	A
1PK-710KB(Metric)	220~240V	B

1PK-710KA/1PK-710KB Series contents	
103-132C	Utility component storage box
1PK-125T	Fine tip straight tweezer
1PK-258A	Side cutter 125mm
1PK-258B	Long nose plier 138mm
1PK-708	Side cutting plier 150mm
1PK-709	Long nose plier 160mm
9S002A/B/C	3 pcs Soldering aid tools
1PK-362D	Soldering iron stand with sponge
SI-130A-20 SI-130B-20	Ceramic soldering iron 110V or 220V
89101A	⊖ Line color screwdriver 3.2x75mm
89101B	⊕ Line color screwdriver #0x75mm
89102A	⊖ Line color screwdriver 5.0x75mm
89102B	⊕ Line color screwdriver #1x75mm
89107A	⊖ Line color screwdriver 6.0x100mm
89107B	⊕ Line color screwdriver #2x100mm
9H002 / 9H002A	7 pcs folding type hex key set (inch) or (metric)
8PK-366N-G	Desoldering pump
9K003A-1	Needle file flat
9K003B-1	Needle file round
MT-1210	3-1/2 compact digital multimeter
8PK-3161	7 in 1 crimping tool
9IT	PVC insulated tape
9K002	Stainless scissors 6"
9S001	Solder core 63%, SN
DK-2039	Utility knife (3 blades self loading)
9PK-710P	Deluxe tool case w/2 pallets

- Case size: 330x250x110(mm)(O.D)
- Individual packing: Color box



1PK-2003A/1PK-2003B

Technician's Tool Kit

Ceramic Soldering Iron



3-1/2 Compact Digital Multimeter



Model No.	Soldering voltage	Standard plug
1PK-2003A(Inch)	110V	A
1PK-2003B(Metric)	220~240V	B

1PK-2003A/ 1PK-2003B contents	
103-132C	Utility component storage box
1PK-125T	Fine tip straight tweezer
1PK-258A	Side cutter 125mm
1PK-258B	Long nose plier 138mm
1PK-H026	Adjustable wrench 6"
SI-130A-20 SI-130B-20	Ceramic soldering iron 110V or 220V
89101A	⊖ Line color screwdriver 3.2x75mm
89101B	⊕ Line color screwdriver #0x75mm
89102A	⊖ Line color screwdriver 5.0x75mm
89102B	⊕ Line color screwdriver #1x75mm
89107A	⊖ Line color screwdriver 6.0x100mm
89107B	⊕ Line color screwdriver #2x100mm
8PK-031B	Desoldering wick
8PK-154	Brush
8PK-3161	7 in 1 crimping tool
8PK-362S	Mini soldering stand with sponge
8PK-366N-G	Desoldering pump
MT-1210	3-1/2 compact digital multimeter
908-607	Alignment tool (200mm/2.0mm)
908-609	IC extractor
9109	Line color screwdriver nut 1/4"
9FL-005	Mini flash light
9H002 / 9H002A	7 pcs folding type hex key set (inch) or (metric)
9IT	PVC insulated tape
9K003A-1	Needle file flat
9K003B-1	Needle file round
9S001	Solder core 63%, SN
DK-2039	Utility knife (3 blades self loading)
8PK-2003-P	Carry zipper bag w/2 pallets

- Bag size : 390x280x75 (mm)(O.D)
- Individual packing: Color box

• NOTE : For quality reason, we reserve the right to change the above specifications without notice.

1PK-7110A/1PK-7110B

Computer Maintenance Kit

Model No.	Soldering voltage	Standard plug
1PK-7110A(Inch)	110V	A
1PK-7110B(Metric)	220~240V	B

1PK-7110A/ 1PK-7110B contents	
1PK-125T	Fine tip straight tweezer
1PK-258A	Side cutter 125mm
1PK-258B	Long nose plier 138mm
1PK-317N	Spring hook
1PK-H026	Adjustable wrench 6"
SI-130A-20	Ceramic soldering iron 110V or 220V
SI-130B-20	Ceramic soldering iron 110V or 220V
8PK-031B	Desoldering wick
8PK-101D	Micro cutting plier 130mm
8PK-208D	Wire stripper/cutter
8PK-610	PLCC extractor
8PK-AS07-1	Field service kit
9FL-005	Mini flash light
9H002 / 9H002A	7 pcs folding type hex key set (inch) or (metric)
9PK-154B	Blowing brush
9PK-609D	IC extractor
9SD055-EX	Extension blade 7" (175mm)
9SD055N-6NA	Nut blade 1/4", 3/8", 3/16", 5/16", 7/16", 11/32", (inch) or 3mm, 4mm, 4.5mm, 5mm, 5.5mm, 6mm (metric)
9SD055-M3-M6	Driver blade T6
9SD055-T6	Driver blade T7
9SD055-T7	Driver blade T8
9SD055-T8	Driver blade T9
9SD055-T9	Super torque ratchet handle
9PK-3018SD	8 pcs screwdriver blades:
9SD055N-BIT	⊕ #0, #1, #2 ⊖ 3, 5, 6mm
MS-391	Inspection mirror
ST-13S	Tool bag

- Bag size: 385x300x55(mm)
- Individual packing: Color box



SI-130A/B-20

Ceramic Soldering Iron

- Ceramic heater
 - Fast heat
 - 60% energy saving
- P.109

8PK-610 PLCC Extractor

- Adjustable
- Safe-removal
- Ergonomic

P.222

9PK-609D IC Extractor

- Stainless steel
- Thumb-wheel design, making work firm and easy

9PK-3018SD Super Torque Ratchet Handle

- Ergonomic design
- TPR anti-slip

1PK-2002A/1PK-2002B

Technician's Tool Kit

Model No.	Soldering voltage	Standard plug
1PK-2002A(Inch)	110V	A
1PK-2002B(Metric)	220~240V	B

1PK-2002A/ 1PK-2002B contents	
1PK-108T	Reverse action tweezer
1PK-125T	Fine tip straight tweezer
8PK-154	Brush
8PK-3161	7 in 1 crimping tool
908-609	IC extractor
8PK-610	PLCC extractor
9110	Screwdriver handle
89402A	⊖ Pro-soft s/d 5.0x75mm
89402B	⊕ Pro-soft s/d #1x75mm
19400-M5/9408	⊖ Pro-soft s/d 3/16" (inch) or 5mm (metric)
8PK-611	Wrist strap 10FT
DK-2039	Utility knife (3 blades self loading)
9FL-506	LED Flash light
9H002 / 9H002A	7 pcs folding type hex key set (inch) or (metric)
9H003	3 prong holder
1PK-H028	Adjustable wrench 8"
9HAM-3	Mini hammer set (including 6 parts)
8PK-605A	5 pcs needle file set
1PK-036S	Long nose plier 135mm
1PK-037S	Diagonal cutting plier 110mm
1PK-051	Lineman's plier 210mm
1PK-054S	Flat nose plier 135mm
1PK-055S	Bent nose plier 130mm
8PK-2061	6 pcs electronic screwdriver set
DP-366P	Desoldering pump
SI-130A-20	Quick heat ceramic soldering iron 110V or 220V
SI-130B-20	Quick heat ceramic soldering iron 110V or 220V
9S001	Solder core 63%, SN
9S002A/B/C	3 pcs soldering aid tools
9S004	Heat sink
9SD045AN	⊖ / ⊕ Double-end blade 175mm length 4mm/T6
9SD045C	⊕ / ⊕ Double-end blade 175mm length #1/#2
9SD045DN	⊖ / ⊕ Double-end blade 175mm length 6mm/T8
9SD045E	⊖ / ⊕ Double-end blade 175mm length T10/T15
9SD045J	Extension blade 7" (175mm)
ST-13S	Tool bag

- Bag size: 435x325x90(mm)
- Individual packing: Color box

SI-130A/B-20

Ceramic Soldering Iron

- Ceramic heater
 - Fast heat
 - 60% energy saving
- P.109



1PK-051 Lineman's Plier

- Non-slip
- Heavy duty

P.57

1PK-H028 Adjustable Wrench 8"

- Max jaw open 25mm
- Securely fit

P.160

8PK-2061 6 pcs Electronic Screwdriver Set

- Ideal for mobile, video games and electronic devices repair purpose.

P.146

• NOTE : For quality reason, we reserve the right to change the above specifications without notice.

Pro's Tool Kit

1PK-1305 is a professional tool kit includes the common use tools for installation and maintenance in electronic and electrical field.

Electronic
Electrical

TOOL KITS



Model No.	Soldering voltage	Standard plug
1PK-1305NA (Inch)	110V	A
1PK-1305NB (Metric)	220~240V	B

1PK-1305NA/1PK-1305NB contents	
103-132C	Utility component storage box
PM-736	Long nose plier 135mm
PM-737	Diagonal cutting plier 113mm
PM-754	Flat nose plier 135mm
PM-755	Bent nose plier 130mm
1PK-108T	Reverse action tweezers
1PK-362D	Soldering iron stand with sponge
1PK-H026	Adjustable wrench 6"
SI-130A-20	Ceramic Soldering Iron 110V or 220V
SI-130B-20	
19400-M5/9408	⊕ Pro-soft s/d 3/16"(inch) or 5mm(metric)
19400-M6/9409	⊕ Pro-soft s/d 1/4"(inch) or 6mm(metric)
89401A	⊖ Pro-soft s/d 3.2x75mm
89401B	⊕ Pro-soft s/d #0x75mm
89402A	⊕ Pro-soft s/d 5.0x75mm
89402B	⊕ Pro-soft s/d #1x75mm
89407A-L	⊖ Pro-soft s/d 6.0x57mm
89407B-L	⊕ Pro-soft s/d #2x57mm

SD-220A	⊖ Pro-soft screwdriver 6.0x40mm
SD-220B	⊕ Pro-soft screwdriver #2x40mm
8PK-154	Brush
8PK-2061	6 pcs electronic screwdriver set
8PK-366N-G	Desoldering pump
MT-1210	3-1/2 compact digital multimeter
9H002	7 pcs folding type hex key set (inch) or (metric)
9H002A	hex key set (inch) or (metric)
9IT	PVC insulated tape
9K002	Stainless scissors 6"
9K003A-1	Needle file flat
9K003B-1	Needle file round
9S001	Solder core 63%, SN
9S002A	Soldering aid tool
9S002B	Soldering aid tool
9S002C	Soldering Aid Tool
DK-2039	Utility knife (3 blades self loading)
DK-2040	Measuring tape 3M/10FT
9PK-1305N-P	Pallet for 1PK-1305N
9PK-1305N-TP	Top pallet for 1PK-1305N
9TC-700	Carrying tool case

• Case size : 450x325x132(mm) (O.D)
• Individual packing: Color box

MT-1210

3 1/2 Compact Digital Multimeter

- Compact manual 3 1/2DMM
- Diode test
- Continuity test
- Transistor test

P.22



SI-130A/B

Ceramic Soldering Iron

- Ceramic heater
- Fast heat
- 60% energy saving

P.109



PM-7 Series

Precision Pliers

- High quality S45C forged hardened steel
- Ergonomic TPR handle

P.48



894series

Pro-Soft S/D

- Special inlaid blade insert
- Safe and durable

P.128



1PK-362D

Soldering Tool Stand

- 3 angle adjustment

P.121



DK-2040

Measuring Tape (3M/10FT)

- Magnetic end hook
- Hi-rel power tape
- Shockproof case

P.220



TC-700

Carrying Tool Case

- Aluminum frame
- Protective corners
- Anti-vibration pads
- Rivets reinforcement

P.240



• NOTE : For quality reason, we reserve the right to change the above specifications without notice

Pro's Tool Kit

MT-1210

3 1/2 Compact Digital Multimeter

- Compact manual 3 1/2DMM
- Diode test
- Continuity test
- Transistor test



P.22

SI-130A/B

Ceramic Soldering Iron

- Ceramic heater
- Fast heat
- 60% energy saving



P.109

PM-7 Series

Precision Pliers

- High quality S45C forged hardened steel
- Ergonomic TPR handle



P.48

9SD-200series

Pro-soft screwdriver

- Double structure handle provides user comfort and powerful use.



P.126

SR-330

All Purpose Snip

- Stainless steel blade for multi-purpose cutting work



P.69

DK-2040

Measuring Tape (3M/10FT)

- Magnetic end hook
- Hi-rel power tape
- Shockproof case



P.220

TC-700

Carrying Tool Case

- Aluminum frame
- Protective corners
- Anti-vibration pads
- Rivets reinforcement



P.240



TOOL KITS

Electronic Electrical

Model No.	Soldering voltage	Standard plug
PK-15305A (Inch)	110V	A
PK-15305B (Metric)	220-240V	B

PK-15305A/PK-15305B contents	
PM-736	Long nose plier 135mm
PM-737	Diagonal cutting plier 113mm
PM-754	Flat nose plier 135mm
PM-755	Bent nose plier 130mm
DP-366P	Desoldering pump
1PK-H026	Adjustable wrench 6"
9K003A-1	Needle file flat
9K003B-1	Needle file round
MT-1210	3-1/2 compact digital multimeter
8PK-2061	⊕ Electronic screwdriver: #00, #0, #1
	⊖ Electronic screwdriver: 1.4, 1.8, 2.4
9DP-3616A	Square scraper/stainless steel
9DP-3616B	Slotted shaft/split 45 lever
9DP-3616C	Tapered reamer/tapered needle
9DP-S001	Solder core 63%, SN
9HW-002A	7 pcs hex key set (inch) or (metric)
9HW-002B	
9MS-001	PVC insulated tape
9SD-200-11/ M5	⊕ Pro-soft screwdriver 3/16 (inch) or 5 (metric)

9SD-200-12/ M6	⊖ Pro-soft screwdriver 1/4 (inch) or 6 (metric)
DK-2039	Utility knife (3 blades self loading)
DK-2040	Measuring tape 3M/10FT
SR-330	All Purpose Snip
MS-153C	Blow brush Ø 56mm
SB-1912	Utility component storage box
9SD-201A	⊖ Pro-soft screwdriver 3.0x75mm
9SD-201B	⊕ Pro-soft screwdriver #0x75mm
9SD-202A	⊖ Pro-soft screwdriver 5.0x75mm
9SD-202B	⊕ Pro-soft screwdriver #1x75mm
9SD-207A	⊖ Pro-soft screwdriver 6.0x100mm
9SD-207B	⊕ Pro-soft screwdriver #2x100mm
9SD-220A	⊖ Pro-soft screwdriver 6.0x40mm
9SD-220B	⊕ Pro-soft screwdriver #2x40mm
SH-1025	Soldering tip cleaner
SI-130A-20	Ceramic Soldering iron 110V or 220V
SI-130B-20	
1PK-108T	Reverse action tweezer 165mm
9PK-15305-P	Pallet for PK-15305
9PK-15305-TP	Top pallet for PK-15305
9TC-700	Carrying tool case

- Case size: 450x325x132 (mm)(O.D)
- Individual packing: Color box

• NOTE : For quality reason, we reserve the right to change the above specifications without notice.

Electronic Master Kit

1PK-1700 is a professional tool kit includes the common use tools for installation and maintenance in electronic and electrical field.

Electronic Electrical



TOOL KITS

Model No.	Soldering voltage	Standard plug
1PK-1700NA (Inch)	110V	A
1PK-1700NB(Metric)	220~240V	B

1PK-1700NA/1PK-1700NB contents	
103-132C	Utility component storage box
PM-736	Long nose plier 135mm
PM-737	Diagonal cutting plier 113mm
1PK-051DS	Dual Color Lineman's Plier
PM-755	Bent nose plier 130mm
1PK-708	Side cutting plier 150mm
1PK-709DS	Dual color long nose plier
1PK-108T	Reverse action tweezers
9S002A/B/C	3 pcs soldering aid tools
1PK-362D	Soldering iron stand with sponge
1PK-H026	Adjustable wrench 6"
SI-130A-20	Ceramic Soldering Iron 110V or 220V
SI-130B-20	
19400-M5/9408	⊕ Pro-soft s/d 3/16"(inch) or 5mm (metric)
19400-M6/9409	⊕ Pro-soft s/d 1/4"(inch) or 6mm (metric)
89401A	⊖ Pro-soft s/d 3.2x75mm
89401B	⊕ Pro-soft s/d #0x75mm
89402A	⊖ Pro-soft s/d 5.0x75mm
89402B	⊕ Pro-soft s/d #1x75mm
89407A	⊖ Pro-soft s/d 6.0x100mm
89407B	⊕ Pro-soft s/d #2x100mm
9SD-220A	⊖ Pro-soft screwdriver 6.0x40mm
9SD-220B	⊕ Pro-soft screwdriver #2x40mm
8PK-031B	Desoldering wick

8PK-154	Brush
8PK-2061	6 pcs electronic screwdriver set
8PK-313A	Crimping tool (inch) or (metric)
8PK-313B	
8PK-366N-G	Desoldering pump
8PK-605A	5 pcs needle file set
908-328G	Testing screwdriver
908-607	Alignment tool (200mm/2.0mm)
908-609	IC extractor
9C004	Oil can
9FL-506	LED Flash light
9H002	7 pcs folding type hex key set (inch) or (metric)
9H002A	
9H003	3 prong holder
9H021	6 pcs open-end wrench set
PD-2606	Heavy duty curved-claw hammer
9IT	PVC insulated tape
9K002	Stainless scissors 6"
9S001	Solder core 63%, SN
9S003N	Parts tube
9S004	Heat sink
DK-2039	Utility knife (3 blades self loading)
DK-2040	Measuring tape 3M/10FT
MS-391	Inspection mirror
PN-P010N	Slip-channel pump pliers 254mm
9PK-1700N-P	Pallet for 1PK-1700N
9PK-1700N-TP	Top pallet for 1PK-1700N
9TC-700	Carrying tool case

• Case size: 450x325x132 (mm)(O.D)
• Individual packing: Color box

SI-130A/B

Ceramic Soldering Iron

- Ceramic heater
- Fast heat
- 60% energy saving

P.109



PM-7 Series

Precision Pliers

- High quality S45C forged hardened steel
- Ergonomic TPR handle

P.48



894series

Pro-Soft S/D

- Special inlaid blade insert
- Safe and durable

P.128



1PK-362D

Soldering Tool Stand

- 3 angle adjustment

P.121



DK-2040

Measuring Tape (3M/10FT)

- Magnetic end hook
- Hi-rel power tape
- Shockproof case

P.220



PN-P010N

Slip-Channel Pump Plier 10"

- 6 position channel joints allows wide variety of size accommodation

P.61



TC-700

Carrying Tool Case

- Aluminum frame
- Protective corners
- Anti-vibration pads
- Rivets reinforcement

P.240



• NOTE : For quality reason, we reserve the right to change the above specifications without notice

MT-1232

3 3/4 Autorange Digital Multimeter

- Auto range
- Frequency, Temperature, Capacitance, 3 3/4 DMM all in 1



P.21

SI-130A/B-20

Ceramic Soldering Iron

- Ceramic heater
- Fast heat
- 60% energy saving



P.109

PN-P010N

Slip-Channel Pump Plier 10

- 6 position channel joints allows wide variety of size accommodation



P.61

8PK-249

Snap Ring Plier Set

- 3 convertible tip jaws for 6 different internal-external purposes.



P.63

DK-2040

Measuring Tape (3M/10FT)

- Magnetic end hook
- Hi-rel power tape
- Shockproof case



P.220

8PK-CT009

Multi-Purpose Crimping Tool

- Strip and cut wire
- Crimp insulated and non-insulated terminals



P.90

TC-850

ABS Carrying Tool Case W/2 Pallets



P.237

Professional Field Engineer's Tool Kit



P.20



Electronic Electrical

Model No.	Soldering voltage	Standard plug
1PK-850A (Inch)	110V	A
1PK-850B (Metric)	220~240V	B

1PK-850A/1PK-850B Series contents	
103-132D	Utility component storage box
1PK-108T	Reverse action tweezer
1PK-3171	Spring hook
1PK-317N	Spring hook
1PK-701	Micro cutting plier
1PK-705	Diagonal cutting nipper
1PK-706	Long nose plier
1PK-A001	10 pcs trimming tool set
1PK-H028	Adjustable wrench 8"
SI-130A-20	Ceramic soldering iron 110V or 220V
SI-130B-20	Ceramic soldering iron 110V or 220V
89101A	⊕ Line color screwdriver 3.2x75mm
89101B	⊖ Line color screwdriver #0x75mm
89102A	⊕ Line color screwdriver 5.0x75mm
89102B	⊖ Line color screwdriver #1x75mm
89107A	⊕ Line color screwdriver 6.0x100mm
89107B	⊖ Line color screwdriver #2x100mm
89113A	⊖ Line color screwdriver 6.0x150mm
89113B	⊕ Line color screwdriver #2x150mm

89117B	⊕ Line color screwdriver #2x250mm
89120A	⊖ Line color screwdriver 6.0x38mm
89120B	⊕ Line color screwdriver #2x38mm
8PK-022	7 pcs miniature L shaped hex key set
8PK-2061	6 pcs electronic screwdriver set
8PK-249	Snap ring plier set
8PK-CT009	Multi-purpose crimping tool (metric) or (inch)
8PK-CT009A	Multi-purpose crimping tool (metric) or (inch)
9C004	Oil can
9FL-005	Mini flash light
9H063	Central punch tool
PD-2606	Carpenter hammer
9S002A/B/C	3 pcs soldering aid tools
DK-2039	Utility knife (3 blades self loading)
DK-2040	Measuring tape 3M/10FT
HW-609A	10 pcs electronic combination wrench (inch) or (metric)
HW-609B	10 pcs electronic combination wrench (inch) or (metric)
MS-391	Inspection mirror
MT-1232	3-3/4 Autorange digital multimeter
PN-P010N	Slip-channel pump pliers 254mm
TC-850	ABS carrying tool case w/2 pallet

- Case size: 435x310x145 (mm) (O.D)
- Individual packing: Color box

* NOTE - For quality reason, we reserve the right to change the above specifications without notice.

Electronic Tool Kit

**Electronic
Electrical**



TOOL KITS

Model No.	Soldering voltage	Standard plug
PK-15307E1 (Inch)	110V	A
PK-15307BM(Metric)	220~240V	B

PK-15307E1/PK-15307BM contents		
PM-736	Long nose plier 135mm	
PM-737	Diagonal cutting plier 110mm	
1PK-051DS	Dual color lineman's plier 205mm	
1PK-709DS	Dual color long nose plier 165mm	
1PK-H026	Adjustable wrench 6"	
1PK-067DS	Dual color side cutting plier 165mm	
8PK-605A	5 pcs needle file set	
SI-130A-20 SI-130B-20	Ceramic Soldering Iron 110V or 220V	
MT-1210	3-1/2 compact digital multimeter	
DK-2040	Measuring tape (3M/10FT)	
9DP-S001	Solder core 63%, SN	
9HW-002A 9HW-002B	7 pcs hex key set (inch) or (metric)	
CP-108	Wire stripper cutter	
DK-2039	Utility knife (3 blades self loading)	
SR-330	All Purpose Snip	
DP-3615	Solder aid tools	
DP-366P	Desoldering pump	
HW-609A HW-609B	10 pcs electronic combination wrench (inch) or (metric)	
MS-035	Flux bottle (2 pcs/pack)	
MS-153C	Blow brush (ø56mm)	

908-609	IC extractor
PN-086N	Slip joint plier 154mm
9SD-201A	⊖ Pro-soft screwdriver 3.0x75mm
9SD-201B	⊕ Pro-soft screwdriver #0x75mm
9SD-202A	⊖ Pro-soft screwdriver 5.0x75mm
9SD-202B	⊕ Pro-soft screwdriver #1x75mm
9SD-207A	⊖ Pro-soft screwdriver 6.0x100mm
9SD-207B	⊕ Pro-soft screwdriver #2x100mm
9SD-217B	⊕ Pro-soft screwdriver #2x250mm
9SD-220A	⊖ Pro-soft screwdriver 6.0x40mm
9SD-220B	⊕ Pro-soft screwdriver #2x40mm
SD-081-S3	ProSoft Precision Screwdriver 2.0x50mm
SD-081-S6	⊖ ProSoft Precision Screwdriver 2.4x75mm
SD-081-S7	⊕ ProSoft Precision Screwdriver 3.0x100mm
SD-081-P2	⊕ ProSoft Precision Screwdriver #00x50mm
SD-081-P5	⊕ ProSoft Precision Screwdriver #0x75mm
SD-081-P7	⊕ ProSoft Precision Screwdriver #1x150mm
SH-1025	Soldering tip cleaner
1PK-125T	Fine tip straight tweezer
SB-1912	Utility component storage box
PD-374	Hobby vise
9PK-15307-TP	Top pallet for PK-15307
9PK-15307-P	Pallet for PK-15307
9PK-730N	Aluminum frame tool case

- Case size : 458x330x150 (mm) (O.D)
- Individual packing: Color box

MT-1210

3 1/2 Compact Digital Multimeter

- Compact manual 3 1/2DMM
- Diode test
- Continuity test
- Transistor test



P.22

SI-130A/B-20

Ceramic Soldering Iron

- Ceramic heater
- Fast heat
- 60% energy saving



P.109

PM-7 Series

Precision Pliers

- High quality S45C forged hardened steel
- Ergonomic TPR handle



P.48

DK-2040

Measuring Tape (3M/10FT)

- Magnetic end hook
- Hi-rel power tape
- Shockproof case



P.220

PD-374

Hobby Vise

- Clamp to any surface up to 1.1"/28mm
- Max opening: 1.57"/40mm mechanism
- Aluminum die-cast construction



P.227

SD-081 series

Precision Screwdriver

- Special design for precision work



P.140

9PK-730N

Aluminium Frame Tool Case W/1 Pallet



- Bag with rivet design, more durable
- Key locks for maximum security

P.239

• NOTE : For quality reason, we reserve the right to change the above specifications without notice

MT-1210

3 1/2 Compact Digital Multimeter

- Compact manual 3 1/2DMM
- Diode test
- Continuity test
- Transistor test



P.22

1PK-362D

Soldering Tool Stand

- 3 angle adjustment



P.121

SI-130A/B-20

Ceramic Soldering Iron

- Ceramic heater
- Fast heat
- 60% energy saving



P.109

1PK-500series

Super Drill Set

- Low vibration
- High torque
- High speed



P.173

PM-7 Series

Precision Pliers

- High quality S45C forged hardened steel
- Ergonomic TPR handle



P.48

PD-374

Hobby Vise

- Clamp to any surface up to 1.1"/28mm
- Max opening: 1.57"/40mm mechanism
- Aluminum die-cast construction



P.227

9PK-730N

Aluminium Frame Tool Case W/1 Pallet



- Bag with rivet design, more durable
- Key locks for maximum security

P.239

Pro's Electronic Tool Kit



Electronic Electrical

Model No.	Soldering voltage	Standard plug
1PK-1900NA (Inch)	110V	A
1PK-1900NB (Metric)	220-240V	B

1PK-1900NA/1PK-1900NB contents	
103-132C	Utility component storage box
PM-736	Long nose plier 135mm
PM-737	Diagonal cutting plier 113mm
PM-754	Flat nose plier 135mm
PM-755	Bent nose plier 130mm
1PK-051DS	Dual Color Lineman's Plier
1PK-108T	Reverse action tweezer
1PK-500A-2	Super drill set w/adaptor 110V or 220V
1PK-500B-2	
9S002A/B/C	3 pcs soldering aid tools
1PK-362D	Soldering iron stand with sponge
1PK-H026	Adjustable wrench 6"
SI-130A-20	Ceramic Soldering Iron 110V or 220V
SI-130B-20	
19412	Screwdriver handle
19400-M5/9408	⊕ Pro-soft s/d 3/16" (inch) or 5mm (metric)
19400-M6/9409	⊕ Pro-soft s/d 1/4" (inch) or 6mm (metric)
89401A	⊖ Pro-soft s/d 3.2x75mm
89401B	⊕ Pro-soft s/d #0x75mm
89402A	⊖ Pro-soft s/d 6.0x75mm
89402B	⊕ Pro-soft s/d #1x75mm
89407A-L	⊕ Pro-soft s/d 6.0x57mm
89407B-L	⊕ Pro-soft s/d #2x57mm
89414B	⊕ Pro-soft s/d #2x157mm
89416B	⊕ Pro-soft s/d #1x150mm
9SD-220A	⊖ Pro-soft screwdriver 6.0x40mm

9SD-220B	⊕ Pro-soft screwdriver #2x40mm
8PK-154	Brush
8PK-313A/B	Crimping tool (inch) or (metric)
8PK-366N-G	Desoldering pump
8PK-509	Precision s/d set 6 pcs
8PK-605A	5 pcs needle file set
MS-C001	Mini-vacuum cleaner
9C002	Cleaning fluid, head (60cc)
9C003	Cleaning fluid, head (18cc)
MT-1210	3-1/2 compact digital multimeter
908-328G	Testing screwdriver
908-609	IC extractor
9FL-506	LED Flash light
9H002	7 pcs folding type hex key set (inch) or (metric)
9H002A	7 pcs folding type hex key set (inch) or (metric)
9H003	3 prong holder
9IT	PVC insulated tape
9K002	Stainless scissors 6"
9S001	Solder core 63%, SN
9SD013CT-1	Bit T10x30mm
9SD013CT-2	Bit T15x30mm
8PK-611	Wrist strap 10FT
DK-2039	Utility knife (3 blades self loading)
HW-609A	10 pcs electronic combination wrench (inch) or (metric)
HW-609B	
PD-374	Hobby vise (Jaw opening 40mm/width 60mm)
908-1900-1	Top pallet for 1PK-1900N
908-1900-2	Pallet for 1PK-1900N
9PK-730N	Aluminum frame tool case

- Case size : 458x330x150 (mm) (O.D)
- Individual packing: Color box

• NOTE : For quality reason, we reserve the right to change the above specifications without notice.

Jumbo Tool Kit

Electronic
Electrical



TOOL KITS

Model No.	Soldering voltage	Standard plug	
1PK-1990A (Inch)	110V	A	
1PK-1990B (Metric)	220-240V	B	
1PK-1990A/1PK-1990B contents			
103-132C	Utility computer storage box		
1PK-054S	Flat nose plier 135mm		
1PK-055S	Bent nose plier 130mm		
1PK-051	Lineman's plier 210mm		
1PK-067	Side cutting plier 160mm		
1PK-125T	Fine tip straight tweezer		
1PK-317N	Spring hook		
9S002A/B/C	3 pcs soldering aid tools		
DP-366P	Desoldering pump		
1PK-500A-2	Super drill set w/adaptor		
1PK-500B-2	110V or 220V		
1PK-606A	3 pcs anti-static alignment tool kit		
1PK-705	Diagonal cutting nipper		
1PK-706	Long nose plier		
1PK-709	Long nose plier 160mm		
1PK-H026	Adjustable wrench 6"		
SI-130A-20	Ceramic Soldering Iron 110V or 220V		
SI-130B-20			
1PK-T406	Straight forceps 6"		
19400-M5 / 9408	⊕ Pro-soft s/d 3/16"(inch) or 5mm(metric)		
19400-M6 / 9409	⊕ Pro-soft s/d 1/4"(inch) or 6mm(metric)		
89401A	⊕ Pro-soft s/d 3.2x75mm		
89401B	⊕ Pro-soft s/d #0x75mm		
89402A	⊕ Pro-soft s/d 5.0x75mm		
89402B	⊕ Pro-soft s/d #1x75mm		
89407A	⊕ Pro-soft s/d 6.0x100mm		
89407B	⊕ Pro-soft s/d #2x100mm		
89414B	⊕ Pro-soft s/d #2x157mm		
8PK-031B	Desoldering wick		
8PK-154	Brush		
8PK-2061	6 pcs electronic screwdriver set		
8PK-227	40 pcs socket & screwdriver set		
8PK-3001D	Precision wire stripper		
8PK-313A/B	Crimping tool (inch) or (metric)		
8PK-605A	5 pcs needle file set		
908-609A	IC extractor		
9FL-005	Mini flash light		
9H002	7 pcs folding type hex key set (inch) or (metric)		
9H002A			
9H003	3 prong holder		
PD-2606	Heavy duty curved-claw hammer		
9IT	PVC insulated tape		
9S001	Solder core 63%, SN		
9S004	Heat sink		
8PK-611	Wrist strap 10FT		
DK-2040	Measuring tape 3M/10FT		
HW-609A	10 pcs electronic combination wrench (inch) or (metric)		
HW-609B			
MS-391	Inspection mirror		
PN-086N	Slip joint plier 154mm		
9PK-1990EN-P	Pallet for 1PK-1990		
9PK-1990EN-TP	Top pallet for 1PK-1990		
9PK-990EN	Aluminum frame tool case		

- Case size : 461x331x156 (mm) (O.D)
- Individual packing: Color box

SI-130A/B-20

Ceramic Soldering Iron

- Ceramic heater
- Fast heat
- 60% energy saving

P.109

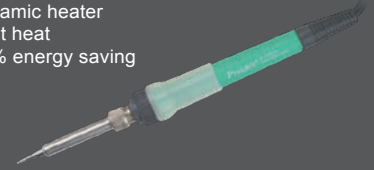

1PK-500series

Super Drill Set

- Low vibration
- High torque
- High speed

P.173



894series

Pro-Soft S/D

- Special inlayed blade insert
- Safe and durable

P.128



PN-086N

Slip Joint Plier 6"

- With 2-position milled jaws to meet different requirements

P.60



8PK-227

40Pcs Socket & Screwdriver Set

- 40pcs high quality 1/2"socket set with 2 different handles for different application

P.137



9PK-990EN

Aluminum Frame Tool Case

- Bag with rivet design, more durable
- Key locks for maximum security

P.241



• NOTE : For quality reason, we reserve the right to change the above specifications without notice

House Plumbing & Electrician Repair Tool Kit

A household tool set contains the most reached tools for constructing, repairing or performing maintenance on most plumbing and electrical jobs.

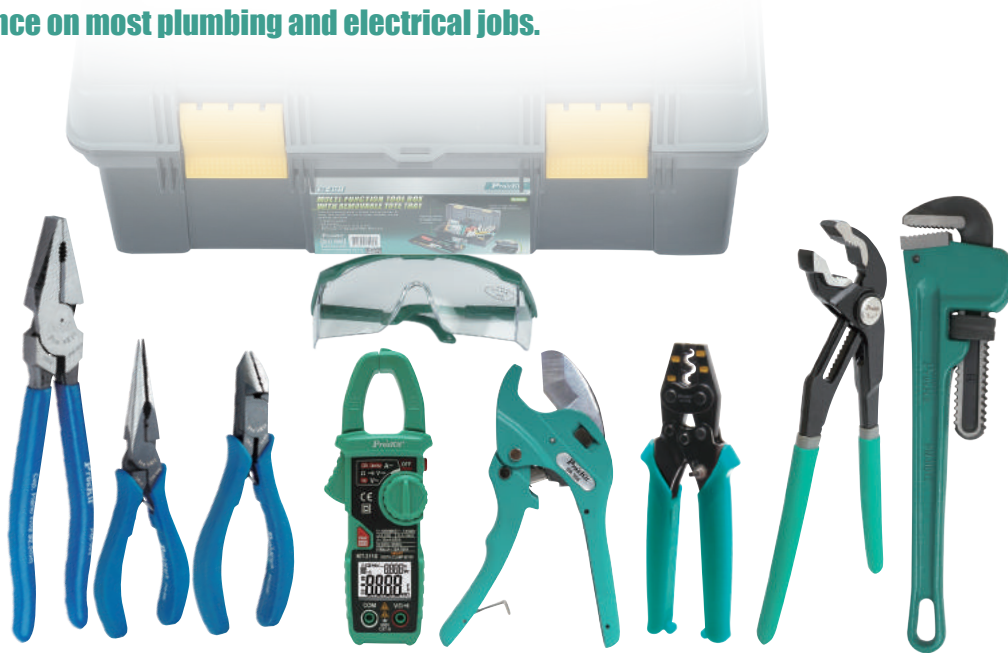

MT-3110

3 5/6 Smart Digital Clamp Meter

- 3 5/6 smart clamp meter with auto selection
- Simultaneous measurement dual display



Non contact ACV detector ACA measurement



Dual Display Simultaneous measurement



Max. jaw opening
25mm

One Key
operation
Auto Selection
Smart measurement

Dual Display
Simultaneous
Measurement

P.24

SR-366

Ratchet Plastic Pipe Cutter

- Blade quick release design
- V shaped SK5 blade
- Capacity: Max. 38mm/1.5inch



P.69

Securely housed in a multi-function tool box with removable tube tray for easy tool storage and management.



PK-2626 contents

PM-903	Lineman's plier (225mm) black oxide finish 9"
PM-909	Long nose plier (170mm) black oxide finish 6"
CP-380	Automatic wire stripper
CP-151B	Non-insulated terminals ratchet crimping tool
MT-3110	3 5/6 Smart digital clamp meter
PN-P110	Raptor 10" pump plier
SR-366	Ratchet plastic pipe cutter
MS-710	Anti-fog UV protective glasses
PM-908	Side cutting plier (160mm) black oxide finish 6"
PN-H012	12" Heavy duty pipe wrench
SB-4121	Multi-function tool box with removable tube tray

- Case size : 410x210x185(mm)
- Individual packing: Color sleeve

PN-P110

Raptor 10" Pump Plier

- 2X faster positioning with only one hand operation
- Jaw open (Max.) 45mm



P.61

CP-380

Automatic Wire Stripper

- Automatic wire stripper for 16-8 AWG wire, especially for stranded wire



P.91

• NOTE : For quality reason, we reserve the right to change the above specifications without notice.

Air Condition Installation & Repair Tool Kit

A complete set for A/C system installation and maintenance, such as air conditioner, heater, dehumidifier, central air conditioning system, refrigerator, and more.



TOOL KITS

MT-3110

3 5/6 Smart Digital Clamp Meter

- 3 5/6 smart clamp meter with auto selection
- Simultaneous measurement dual display

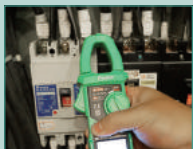

Non contact ACV detector



ACA measurement



Dual Display



Simultaneous measurement



Max. jaw opening
25mm

One Key
operation
Auto Selection
Smart measurement

Dual Display
Simultaneous
Measurement

P.24

CP-380

Automatic Wire Stripper

- Automatic wire stripper for 16-8 AWG wire, especially for stranded wire



P.91

MT-4606

Infrared Thermometer

- -50 to 380°C range
- Distance spot ratio 12:1
- Functions: Data hold, Max. value, unit selection and more.



P.27

Securely housed in a multi-function tool box with removable tobe tray for easy tool storage and management.



PK-2627 contents	
PM-903	Lineman's plier (225mm) black oxide finish 9"
PM-909	Long nose plier (170mm) black oxide finish 6"
MT-3110	3 5/6 Smart digital clamp meter
MT-4606	Infrared thermometer
HW-010	Adjustable wrenches - 10"
1PK-H028	Adjustable wrench - 8"
8PK-021N	7Pcs folding hex key set
CP-380	Automatic wire stripper
MS-710	Anti-fog uv protective glasses
SB-4121	Multi-function tool box with removable tobe tray

- Case size : 410x210x185 (mm)
- Individual packing:Color sleeve

• NOTE : For quality reason, we reserve the right to change the above specifications without notice

Service Technician's Tool Kit

MT-1270

3 1/2 Digital Multimeter

- Frequency,
- Capacitance,
- Temperature
- 3 1/2 DMM all in 1



P.20

SI-130A/B

Ceramic Soldering Iron

- Ceramic heater
- Fast heat
- 60% energy saving



P.109

8PK-SD016

23Pcs 1/4" Driver Socket Set

- Socket x 9pcs of each metric and inch size
- 2 handles for different applications



P.161

8PK-3001D

Precision Wire Stripper (AWG 30/28/26/24/22/20)

- Made by CNC machining process for best accuracy
- Ideal for stripping solid wire from AWG 30-20.



P.88

Super Torque Ratchet Screwdriver

- Adjust multi-angle 15 section
- High torque:220kgf-cm

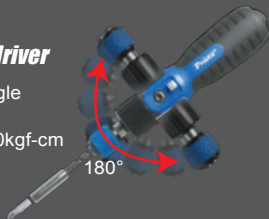

PN-P010N

Slip-Channel Pump Plier 10"

- 6 position channel joints allows wide variety of size accommodation



P.61

TC-2009

ABS Carrying Tool Case



P.238



Model No.	Soldering voltage	Standard plug
1PK-2009A (Inch)	110V	A
1PK-2009B(Metric)	220-240V	B

1PK-2009A/1PK-2009B contents	
103-132C	Utility component storage box
1PK-108T	Reverse action tweezer
1PK-606A	3 pcs anti-static alignment tool kit
1PK-701	Micro cutting plier
1PK-702	Long nose plier
1PK-705	Diagonal cutting nipper
1PK-706	Long nose plier
1PK-709	Long nose plier 160mm
8PK-BL002	Cabling splicing knife
1PK-H026	Adjustable wrench 6"
1PK-H028	Adjustable wrench 8"
1PK-H074	Solder aid tool
SI-130A-20	Ceramic soldering iron 110V or 220V
SI-130B-20	DMM with mechanical prevent mistaken operation
MT-1270	
89101A	⊖ Line color screwdriver 3.2x75mm
89101B	⊕ Line color screwdriver #0x75mm
89102A	⊖ Line color screwdriver 5.0x75mm
89102B	⊕ Line color screwdriver #1x75mm
89105A	⊖ Line color screwdriver 3.2x100mm
89107A	⊖ Line color screwdriver 6.0x100mm
89107B	⊕ Line color screwdriver #2x100mm
89118A	⊖ Line color screwdriver 3.2x200mm
89120A	⊖ Line color screwdriver 6.0x38mm
89120B	⊕ Line color screwdriver #2x38mm
89122A	⊖ Line color screwdriver 8.0x150mm
8PK-154	Brush
8PK-2061	6 pcs electronic screwdriver set

8PK-249	Snap ring plier set
8PK-3001D	Precision wire stripper
8PK-CT009	Multi-purpose crimping tool (Metric or (inch)
8PK-CT009A	
8PK-SD016	23 pcs 1/4" socket set
9C004	Oil can
9FL-005	Mini flash light
9H002/ 9H002A	7 pcs folding type hex key set (inch) or (metric)
9H063	Central punch tool
9H079	Feeler gauge
PD-2607	Ball peen hammer with fiberglass handle
1PK-3171	Spring hook
1PK-317N	Spring hook
9R006	Steel ruler 6"
9S002A/B/C	3 pcs soldering aid tools
9PK-3018SD	Super torque ratchet handle
9SD055N -HA/HB	4 pcs hex driver blades: 1/16", 5/64", 3/32", 1/8" (inch) or 1.5, 2, 3, 4mm(metric)
9SD055N-6NA 9SD055-113	7 pcs nut driver blades: 1/4", 3/8", 3/16", 5/16", 7/16", 11/32", 1/2" (inch) or 5, 6, 8, 9, 10, 11, 12mm (metric)
9SD055N-NB	
9SD057P	⊕ Double ended screwdriver 3mm/#0
DK-2047N	Electrician's scissors
HW-609A HW-609B	10 pcs electronic combination wrench (inch) or (metric)
MS-391	Inspection mirror
PN-P010N	Slip-channel pump pliers 254mm
TC-2009	ABS carry tool case plus another one pallet

- Case size : 463x331x171 (O.D) (mm)
- Individual packing: Color box

• NOTE : For quality reason, we reserve the right to change the above specifications without notice.

Comprehensive Pro's Tool Kit

This professional, comprehensive tool kit is a perfect combination of tools for the electronic, electrical, automotive industries and more.



PK-4043 contents	
1PK-036S	Long nose plier (136mm)
1PK-037S	Diagonal cutting plier (110mm)
1PK-051DS	Dual color lineman's plier (205mm)
1PK-067DS	Dual color side cutting plier (165mm)
1PK-709DS	Dual color long nose plier (165mm)
8PK-SD016	23 pcs 1/4" driver socket set
9DK-2060	3M auto stop measuring tape
9MS-001	PVC insulated tape
9SD-201A	⊖ Pro-soft screwdriver (-3.0 3.0x75mm)
9SD-201B	⊕ Pro-soft screwdriver (#0 3.0x75mm)
9SD-202A	⊖ Pro-soft screwdriver (-5 5x75mm)
9SD-202B	⊕ Pro-soft screwdriver (#1 5x75mm)
9SD-207A	⊖ Pro-soft screwdriver (-6 6x100mm)
9SD-207B	⊕ Pro-soft screwdriver (#2 6x100mm)
9SD-214B	⊕ Pro-soft screwdriver (#2 6x200mm)
9SD-220A	⊖ Pro-soft screwdriver (-6 6x40mm)
9SD-220B	⊕ Pro-soft screwdriver (#2 6x40mm)
9SD-222A	⊖ Pro-soft screwdriver (-8 8x150mm)
9SD-222B	⊕ Pro-soft screwdriver (#3 8x150mm)
CP-413G	Heavy duty wire strippers/crimpers(8.5")

DK-2112	Auto loading utility knife
FL-516	9 LED flashlight
HW-010	Adjustable Wrenches - 10"
HW-229BL	9pcs extra long arm ball point hex key set (1.5,2,2.5,3,4,5,6,8,10Mm)
HW-6514B	14pcs combination wrench (metric)
MS-323	Telescopic magnetic pick-up tool
MT-1232	3 3/4 autorange digital multimeter
NT-303	Non-contact voltage tester
PD-2606	Heavy duty curved-claw hammer w/fiberglass handle
PN-080	Slip joint plier 10" (254mm)
PN-P010N	Slip-channel pump plier 10" (254mm)
SD-9814	9 In 1 aluminum handle precision screwdriver set
SR-330	All purpose snip (165mm)
SR-331	All purpose snip (165mm)
TC-736	Expert & elegant aluminum frame tool case W/2 pallets

- Case size : 486x325x159(mm)(O.D)
- Individual packing: Color box

MT-1232

3 3/4 Autorange Digital Multimeter



- Auto range
- Frequency, Temperature, Capacitance, 3 3/4 DMM all in 1

P.21

8PK-SD016

23Pcs 1/4" Driver Socket Set

- Socket x 9pcs of each metric and inch size
- 2 handles for different applications



P.135

9SD-200series

Pro-Soft Screwdriver

- Double structure handle provides user comfort and powerful use



P.137

HW-6514B

14Pcs Combination Wrench

- Complete set for automotive, industry and more



P.159

DK-2060

3M Auto Stop Measuring Tape

- Magnetic end hook
- Hi-rel power tape
- Shockproof case



P.220

PN-P010N

Slip-Channel Pump Plier

- 6 position channel joints allows wide variety of size accommodation



P.61

TC-736

Expert & Elegant Aluminum Frame Tool Case



P.237

• NOTE : For quality reason, we reserve the right to change the above specifications without notice

Master Electrical Tool Kit

All the tools in this professional Aluminum tool case are specially selected for electrical engineers. It's a complete, professional and convenient kit for repairing and installing quickly and accurately.

TOOL KITS



MT-1232

3 3/4 Autorange Digital Multimeter

- Auto range
- Frequency, Temperature, Capacitance, 3 3/4 DMM all in 1



P.21

SI-130A/B-20

Ceramic Soldering Iron

- Ceramic heater
- Fast heat
- 60% energy saving



P.109

HW-5907M/I

Flex Head Gear Wrench

- 7pcs flex head ratchet wrench set



P.161

SR-332

All Purpose Snip

- Stainless blade for multi-purpose cutting work



P.69

PN-086N

Slip Joint Plier

- With 2-position milled jaws to meet different requirements



P.60

9SD-200series

Pro-Soft Screwdriver

- Double structure handle provides user comfort and powerful use



P.137

TC-736

Expert & Elegant Aluminum Frame Tool Case



P.237

Model No.	Soldering voltage	Standard plug
PK-4027AI (Inch)	110V	A
PK-4027BM (Metric)	220~240V	B

PK-4027AI / PK-4027BM contents	
DK-2039	Utility knife (3 blades self loading)
DK-2047N	Electrician's scissors
9FL-506	Led flash light
1PK-H028	Adjustable wrench - 8"
9MS-001	Pvc insulated tape
NT-305	Contact voltage tester
1PK-051	Lineman's plier
1PK-067	Side cutting plier
1PK-709	Long nose plier (160mm)
SI-130A-20	Ceramic soldering iron
SI-130B-20	110V or 220v
PN-086N	Slip joint plier 6"
PN-P008	Slip-channel pump plier 8"
9DP-S001	Pen solder 63%
9SD-201A	⊖ Pro-soft screwdriver (3.0 3.0X75mm)
9SD-201B	⊕ Pro-soft screwdriver (#0 3.0X75mm)
9SD-202A	⊖ Pro-soft screwdriver (5 5x75mm)

9SD-202B	⊕ Pro-soft screwdriver (#1 5x75mm)
9SD-207A	⊖ Pro-soft screwdriver (6 6x100mm)
9SD-207B	⊕ Pro-soft screwdriver (#2 6x100mm)
9SD-214B	⊕ Pro-soft screwdriver (#2 6x200mm)
CP-412G	Heavy duty wire strippers/crimpers (206mm)
DK-2041	Measuring tape (5m/16ft)
HW-129BA	9Pcs ball point long arm hex key set inch (1/16", 5/64", 3/32", 1/8", 5/32", 3/16", 1/4", 5/16", 3/8"), or metric (1.5, 2, 2.5, 3, 4, 5, 6, 8, 10mm)
HW-129B	
HW-5907I	Flex head gear wrench Inch:5/16", 3/8", 7/16", 1/2", 9/16", 5/8", 3/4" Metric:8, 10, 11, 13, 14, 17, 19mm
HW-5907M	
MT-1232	3-3/4 autorange digital multimeter
PD-2607	Ball peen hammer with fiberglass handle
SB-1912	Utility component storage box (187.5X117x22mm)
SW-106	6" Junior multi-purpose saw
SR-332	All purpose snip
TC-736	Aluminum frame tool case w/2 pallets

- Case size : 486x325x159 (mm) (O.D)
- Individual packing: Color box

• NOTE : For quality reason, we reserve the right to change the above specifications without notice.

Field and Maintenance Service Kit



TOOL KITS

Model No.	Soldering voltage	Standard plug
PK-15308EM	110V	A
PK-15308BM	220-240V	B

PK-15308EM / PK-15308BM contents

MT-1232	3-3/4 autorange digital multimeter
8PK-SD016	23 pcs 1/4" driver socket set
PD-2606	Heavy duty curved-claw hammer w/fiberglass handle
1PK-H028	Adjustable wrench 8"
908-609	IC extractor
PD-374	Hobby vise
PN-P010N	Slip-channel pump pliers 254mm
SD-081-S3	ProSoft precision screwdriver 2.0x50mm
SD-081-S6	ProSoft precision screwdriver 2.4x75mm
SD-081-S7	Prosoft precision screwdriver 3.0x100mm
SD-081-P2	Prosoft precision screwdriver #00x50mm
SD-081-P5	Prosoft precision screwdriver #0x75mm
SD-081-P7	Prosoft precision screwdriver #1x150mm
CP-108	Wire stripper cutter
9SD-202A	Pro-soft screwdriver 5.0x75mm
9SD-202B	Pro-soft screwdriver #1x75mm
9SD-210A	Pro-soft screwdriver 5.0x100mm
9SD-210B	Pro-soft screwdriver #1x100mm
9SD-207A	Pro-soft screwdriver 6.0x100mm
9SD-207B	Pro-soft screwdriver #2x100mm
9SD-217B	Pro-soft screwdriver #2x250mm

9SD-220A	Pro-soft screwdriver 6.0x40mm
9SD-220B	Pro-soft screwdriver #2x40mm
1PK-125T	Fine tip straight tweezer
SB-1912	Utility component storage box
PM-736	Long nose plier 135mm
PM-737	Diagonal cutting plier 110mm
1PK-052DS	Lineman's plier 165mm
1PK-067DS	Dual color cutting plier
1PK-709DS	Dual color long nose plier
HW-229B	9 pcs ball point long arm hex key set
HW-609B	10 pcs electronic combination wrench (metric)
8PK-605A	5 pcs needle file set
SI-130A-20	Ceramic soldering iron 110V or 220V
SI-130B-20	
9DP-031B	Desoldering wick
9DP-S001	Solder core 63%, SN
9MS-001	PVC insulated tape
DK-2039	Utility knife (3 blades self loading)
DK-2040	Measuring tape 3M/10FT
SR-330	All Purpose Snip
DP-366D	Desoldering pump
MS-035	Flux bottle (2 pcs/pack)
MS-153C	Blow brush (ø56mm)
MS-323	Telescopic magnetic pick up tool
MS-391	Inspection mirror
9PK-15308-P	Pallet for PK-15308
TC-311	Heavy-duty ABS cases with wheels and telescoping handle

- Case size : 465x335x190 (mm)(O.D)
- Individual packing: Color box

MT-1232

3 3/4 Autorange Digital Multimeter



- Auto range
- Frequency, Temperature, Capacitance, 3 3/4 DMM all in 1

P.21

SI-130A/B-20

Ceramic Soldering Iron

- Ceramic heater
- Fast heat
- 60% energy saving



P.109

PM-7 Series

Precision Pliers

- High quality S45C forged hardened steel
- Ergonomic TPR handle



P.48

PD-374

Hobby Vise

- Clamp to any surface up to 1.1"/28mm
- Max opening: 1.57"/40mm mechanism
- Aluminum die-cast construction



P.227

SD-081 series

ProSoft Precision Screwdriver

- Special design for precision work

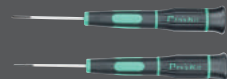

P.140

8PK-SD016

23Pcs 1/4" Driver Socket Set

- Socket x 9pcs of each metric and inch size
- 2 handles for different applications



P.161

TC-311

Heavy-duty ABS Cases with Wheels and Telescoping Handle



P.237

• NOTE : For quality reason, we reserve the right to change the above specifications without notice

Networking / Telecom / CCTV / CATV

PK-5011 CATV/CCTV Basic Tool Kit



This is a complete tool bundle along with F connectors to install or remove existing or additional cable TV, satellite outlets or cable modems. It includes adjustable waterproof compression tool, coaxial cable stripper/cutter and 4pcs F connectors to make your work smart and easy.



CP-316	Adjustable Compression Tool
CP-507	Coaxial Cable Stripper/Cutter
CN-710FCA2-BU	4pcs F connectors for RG6 quad coaxial
903-003	Carry case (160x120x45 mm)

• Individual packing: Blister card

PK-2006 LAN Basic Tool Kit



This is a complete tool bundle to make RJ45 or RJ11/RJ12 patch cords for phone and computer. It includes 6P/8P parallel action modular crimper and stripper to make your job well done.



CP-333	Modular crimping tool
6PK-501	Wire stripping tool
903-003	Carry case (160x120x45 mm)

• Individual packing: Blister card

6PK-3010 Coaxial Crimping Tool Kit



Crimper tool w/Die .068, .213, .256 (Hex)
Rotary coaxial cable stripper
Round cable cutter
Carry case (305x210x58mm)

• Individual packing: Color label shrink

6PK-330K Coaxial Crimping Tool Kit



Crimper tool	Rotary coaxial cable stripper
Round cable cutter	Screwdriver #1x125
DIE: .255", .213", .187", .068" (Hex)	
.319", .256", .213", .068" (Hex)	
.043" (SQ), .100", .213", .068", .137", .255" (Hex)	
.042" (SQ), .078", .151", .068", .128", .178" (Hex)	
.10", .128", .429" (Hex)	
Carry case (305x210x58mm)	

• Individual packing: Color label shrink

• NOTE : For quality reason, we reserve the right to change the above specifications without notice.

▶ 1PK-932 Deluxe Twisted Pair Kit



1PK-932 contents	
1PK-3003D11	RJ-45 die set
1PK-3003D12	RJ-11 die set
1PK-3003F	Supercrimp crimp tool frame
8PK-208D	Wire stripper/cutter
8PK-CT001	UTP/STP cable stripper
9RJ-11-50	6-position 4 contact flat stranded (50 pcs/bag)
9RJ-45-25	8-position 8 contact round stranded (25 pcs/bag)
9RJ-45PC	RJ-45 protection cap (20 pcs/bag)
903-015	Blowing case

- Blowing Case: 340x250x65(mm) (O.D.)
- Individual packing: Color label shrink

▶ 1PK-933 RJ-45/11 Combination Telecom Termination Kit



1PK-933 contents	
6PK-501	Wire stripper tool
CP-376ER	Modular crimping tool
8PK-CT001	UTP/STP cable stripper
9RJ-11-50	6-position 4 contact flat stranded (50 pcs/bag)
9RJ-45-25	8-Position 8 contact round stranded (25 pcs/bag)
9RJ-45PC	RJ-45 protection cap (20 pcs/bag)
903-015	Blowing case

- Blowing Case: 340x250x65(mm) (O.D.)
- Individual packing: Color label shrink

▶ PK-2633 Network Test Tool Kit



RJ11 cable test

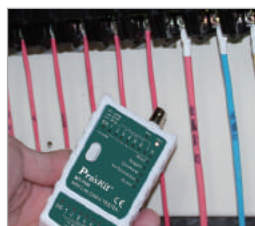

NCV detection



BNC cable test

PK-2633 contents	
CP-3141	Impact terminal tool for KRONE
CP-393	Pro-crimper modular tool (160mm)
CP-501BN	Wire stripper tool
MT-7058	Mini LAN cable tester
PD-513	Utility knife
SD-5102A	⊖ Line color screwdriver (-5.0 X 75mm)
SD-5102B	⊕ Line color screwdriver (#1 x 75mm)
SD-5107A	⊖ Line color screwdriver (-6.0 X 100mm)
SD-5107B	⊕ Line color screwdriver (#2 x 100mm)
SR-332	All purpose snip (165mm)
9ST-33	Tool bag

- Bag size: 255x172.5x55(mm)
- Individual packing: Color sleeve shrink

• NOTE : For quality reason, we reserve the right to change the above specifications without notice.

1PK-940E Category 5 Termination Kit

1PK-940E contents	
3PK-NT007N	Multi-network cable tester
8PK-3141A	Impact tool
CP-376ER	Modular crimping tool
8PK-CT001	UTP/STP cable stripper
9RJ-22-50	4-position 4 contact flat stranded (50 pcs/bag)
9RJ-45-25	8-position 8 contact round stranded (25 pcs/bag)
9RJ-45PC	RJ-45 protection cap. (20 pcs/bag)
9Z-940KP	Carrying zipper bag

- Bag size: 280x197x70(mm)
- Individual packing: Inner box & Color label shrink



1PK-940 Category 5e/6 Termination Kit

1PK-940 contents	
3PK-NT007N	Multi-network cable tester
CP-3148	Punch down tool with 110/88 and 66 double end blade
CP-376ER	Modular crimping tool
8PK-CT001	UTP/STP cable stripper
9RJ-22-50	4-position 4 contact flat stranded (50 pcs/bag)
9RJ-45-25	8-position 8 contact round stranded (25 pcs/bag)
9RJ-45PC	RJ-45 protection cap. (20 pcs/bag)
9Z-940KP	Carrying zipper bag

- Bag size: 280x197x70(mm)
- Individual packing: Inner box & Color label shrink



PK-4015 Cable Service Kit



PK-4015 contents	
MT-7068	All-in-one toner & probe kit
CP-373	Pro-crimper modular tool
CP-3148	Punch down tool with 110/88 and 66 double end blade
CP-505	Universal stripping tool (UTP/STP, RG-59/6/7/11)
1PK-SD006	6-in-1 magnetic quick change screw-driver
SR-332	All purpose snip
9ST-23	Tool bag

- Bag size: 340x222.5x60(mm)(O.D.)
- Individual packing: Inner box & Color label shrink



Copper cabling detecting



10 Base-T or 10/100 Base-T datacom networks



Locates and isolates cables quickly and easily

• NOTE : For quality reason, we reserve the right to change the above specifications without notice.

PK-2628
PK-2629

Telecom & Network Installer Tool Kits
Telecom & Network Installer Tool Kits (w/o MT-8006B)

Complete kit allows the professional installer or amateur enthusiast to handle cabling, terminating and troubleshooting with ease.



Model.	Product Name	PK-2628	PK-2629
1PK-067DS	Dual color side cutting plier (165mm)	•	•
CP-148	Telecom combi-crimper/plier	•	•
SD-201A	⊖ Pro-soft screwdriver (-3.0 3.0X75mm)	•	•
SD-201B	⊕ Pro-soft screwdriver (+#0 3.0X75mm)	•	•
CP-3141	Impact terminal tool for krone	•	•
CP-376E	Modular crimping tool (200mm)	•	•
MT-1210	3 1/2 Digital multimeter	•	•
MT-7029	Noise-filtering network PoE toner & probe	•	•
MT-8006B	Data diver	•	•
9ST-2628	Tool bag	•	•

- Bag size:385x330x55 (mm)
- Individual packing: Color sleeve shrink

MT-8006B
Data Diver

- Talk/monitor mode
- LCD display
- High voltage indication

P.6

MT-1210
3 1/2 Compact Digital Multimeter

- Compact manual 3 1/2DMM
- Diode test
- Continuity test
- Transistor test

P.22

MT-7029
Noise-Filtering Network PoE Toner & Probe Kit

- Strong anti-noise
- PoE switches & STP wire tracing
- Telephone line status / polarity

P.8

PK-4013

Network Installation Tool Kit

Combination of essential tools for network installation and maintenance.



PK-4013contents	
CP-376KX	Professional modular crimps strips & cuts tool (200mm)
DK-2039	Utility knife (3 blades self loading)
9DK-2060	3M auto stop measuring tape
9SD-329H	Screwdriver probe voltage tester
1PK-067DS	Dual color side cutting plier (165mm)
FL-516	9Pcs led flashlight
MT-7058	Mini lan cable tester
CP-302G	Precision wire stripper (awg 20/18/16/14/12/10)
CP-148	Telecom combi-crimper/plier
CP-3141	Impact terminal tool for krone
9CP-501BN	Wire stripper tool
SD-5101B	Line color screwdriver (#0 x 75mm)
SD-5101A	Line color screwdriver (-3.0X 75mm)
SD-5107A	Line color screwdriver (-6.0 X 100mm)
SD-5107B	Line color screwdriver (#2 x 100mm)
9ST-4013	Tool bag

- Bag size : 340x222.5x60(mm)
- Individual packing : Color sleeve shrink

MT-7058
Mini Lan Cable Tester

- One touch testing
- Multifunction
- Visual & audible dual indication

P.11

CP-376KX
Professional Modular Crimps Strips & Cuts Tool

- Parallel action for accurate crimping
- Ratchet design for force saving
- For 8P8C/RJ-45,6P6C/RJ-12,6P4C/RJ-11

P.80

CP-148
Telecom Combi-Crimper/Plier

- Stripper, cutter, crimper, plier 4 in one

P.82

• NOTE : For quality reason. we reserve the right to change the above specifications without notice



1PK-818A/1PK-818B

Network Maintenance Kit

Model No.	Soldering voltage	Standard plug
1PK-818A (Inch)	110V	A
1PK-818B(Metric)	220	B

1PK-818A/1PK-818B contents

1PK-705	Diagonal cutting nipper
1PK-706	Long nose plier
1PK-H026	Adjustable wrench 6"
SI-130A-20 SI-130B-20	Ceramic soldering iron 110V or 220V
1PK-T406	Straight forceps 6"
6PK-230PA	Coax connectors crimping tool
6PK-332	Rotary coaxial cable stripper
19400-M5/9408	Pro-soft s/d 3/16"(inch) or 5mm(metric)
19400-M6/9409	Pro-soft s/d 1/4"(inch) or 6mm(metric)
89400-T10	Pro-soft s/d T10
89400-T15	Pro-soft s/d T15
89400-T20	Pro-soft s/d T20
89401A	Pro-soft s/d 3.2x75mm
89401B	Pro-soft s/d #0x75mm
89402A	Pro-soft s/d 5.0x75mm
89402B	Pro-soft s/d #1x75mm
89407A	Pro-soft s/d 6.0x100mm
89407B	Pro-soft s/d #2x100mm
8PK-3001D	Precision wire stripper
8PK-366N-G	Desoldering pump
8PK-376FN	Pro-crimper modular tool
908-609A	IC extractor
9FL-005	Mini flash light
9H002/9H002A	7 pcs folding type hex key set (inch) or (metric)
MS-391	Inspection mirror
9ST-13	Tool case

- Bag size: 385x300x55 (mm)
- Individual packing: Inner box & Color label shrink

894series

Pro-Soft Screwdriver

- Special inlaid blade insert
 - Safe and durable
- P.128

SI-130A/B-20

Ceramic Soldering Iron

- Ceramic heater
 - Fast heat
 - 60% energy saving
- P.109

6PK-230PA

Coax Connectors Crimping Tool

- Pro-Crimper Ratcheting Crimper features 40-50% force saving.
- P.76



8PK-376FN

Pro-Crimper Modular Tool

- Ergonomic design
 - Stripping, crimping, cutting 3 In 1
- P.80



1PK-936A/1PK-936B

Master Network Installation Kit

1PK-936A (Inch) /1PK-936B (Metric) contents

1PK-3003D11	RJ-45 die set
1PK-3003D12	RJ-11 die set
CP-336DA4	RG-58/59/62/174 coaxial cables die set
1PK-3003F	Supercrimp crimp tool frame
3PK-NT007N	Multi-network cable tester
608-330	Round cable cutter
6PK-322	Rotary coaxial stripper
8PK-3001D	Precision wire stripper
CP-3148	Punch down tool with 110/88 and 66 double end blade
9FL-005	Mini flash light
9H002/9H002A	7 pcs folding type hex key set (inch) or (metric)
9SD055-EX	Extension blade 7" (175mm)
9SD055N-6NA 9SD055-M3-M6	Nut blade: 1/4", 3/8", 3/16", 7/16", 11/32", 5/16" (inch) 3mm, 4mm, 4.5mm, 5mm, 5.5mm, 6mm (metric)
9SD055-T6	Driver blade T6
9SD055-T7	Driver blade T7
9SD055-T8	Driver blade T8
9SD055-T9	Driver blade T9
9PK-3018SD	Super torque ratchet handle
9SD055N-BIT	8 pcs screwdriver blades: #0, #1, #2 3, 5, 6mm T10, T15
MS-391	Inspection mirror
9ST-23	Tool bag

- Bag size: 340x222.5x60 (mm)
- Individual packing: Inner box & Color label shrink

3PK-NT007N

Multi-network Cable Tester

Auto scanning the wires continuity, miss-wiring and polarization of network cables.

CP-3148

Punch Down Tool with 110/88 and 66 Double End Blade

Ergonomic punch down tool increased HI/LOW forces.

1PK-3003F

Supercrimp Crimp Tool Frame

Pro-Crimper Ratcheting Crimper features 40-50% force saving.



• NOTE : For quality reason, we reserve the right to change the above specifications without notice.

Master Network Installation Tool Kit



TOOL KITS

Model No.	Soldering voltage	Standard plug		
1PK-938A (Inch)	110V	A	9H002/9H002A	7 pcs folding type hex key set (inch) or (metric)
1PK-938B (Metric)	220-240V	B	9PK-154B	Blowing brush
1PK-938A (Inch) / 1PK-938B (Metric) contents			9SD055-EX	Extension blade 7" (175mm)
1PK-132D	Network connector kit		9SD055N-6NA	⊙ Nut blade: 1/4", 3/8", 3/16", 7/16", 11/32", 5/16"(inch) or 3mm, 4mm, 4.5mm, 5mm, 5.5mm, 6mm (metric)
1PK-258A	Side cutter 125mm		9SD055-M3-M6	Super torque ratchet handle
1PK-258B	Long nose plier 138mm		9PK-3018SD	8 pcs screwdriver blades: ⊕ #0, #1, #2 ⊖ 3, 5, 6mm ⊕ T10, T15
1PK-3003D11	RJ-45 die set		9SD055N-BIT	⊕ Driver blade T6
1PK-3003D12	RJ-11 die set		9SD055-T6	⊕ Driver blade T7
CP-336DA4	RG-58/59/62/174 coaxial cables die set		9SD055-T7	⊕ Driver blade T8
1PK-3003D16	RJ-22 die set		9SD055-T8	⊕ Driver blade T9
1PK-3003D3	RG-58, RG-59/62 AU BNC/TNC die set		9SD055-T9	AS-611 Wrist strap 10FT
1PK-3003F	Supercrimp crimp tool frame		MS-391	Inspection mirror
DP-366P	Desoldering pump		MT-1232	3- 3/4 autorange digital multimeter
SI-130A-20	Ceramic soldering iron 110V or 220V		9PK-938-P	Pallet for 1PK-938 serious
SI-130B-20	Ceramic soldering iron 110V or 220V		9PK-938-TP	Top pallet for 1PK-938 serious
1PK-T416	Curved forceps 6"		TC-850	ABS carrying tool case w/1 pallet
3PK-NT007N	Multi-network cable tester			• Case size: 435x310x145(mm) (O.D)
608-330	Round cable cutter			• Individual packing: Color box
6PK-322	Rotary coaxial stripper			
8PK-031B	Desoldering wick			
8PK-3001D	Precision wire stripper			
CP-3148	Punch down tool with 110/66 blades			
9FL-005	Mini flash light			

MT-1232

3 3/4 Autorange Digital Multimeter

- Auto range
- Frequency, Temperature, Capacitance, 3 3/4 DMM all in 1



P.21

SI-130A/B-20

Ceramic Soldering Iron

- Ceramic heater
- Fast heat
- 60% energy saving



P.109

3PK-NT007N

Multi-network Cable Tester

- Automatically check cable for continuity, miss-wired, and polarization

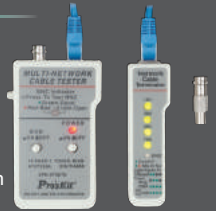

P.12

1PK-3003F

Supercrimp Crimp Tool Frame

- Interchangeable ratcheting crimper, 40%-50% force saving

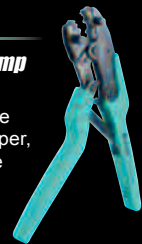

P.75/P.201

Super Torque Ratchet Handle

- Adjust multi-angle 15 section
- High torque:220kgf-cm

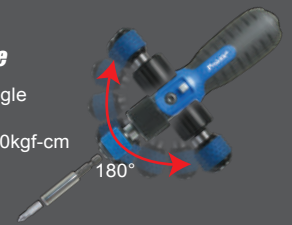

CP-3148

Punch Down Tool with 110/88 & 66 blades

- Punch down tool with high/low force



P.97

TC-850

ABS Carrying Tool Case w/2 Pallets



P.237

• NOTE : For quality reason, we reserve the right to change the above specifications without notice

MT-1210

3 1/2 Compact Digital Multimeter

- Compact manual 3 1/2DMM
- Diode test
- Continuity test
- Transistor test



P.22

MT-7051N

Multi-Modular Cable Tester

- Automatically check cable for short, continuity, open, or cross-wired.



P.12

SI-130A/B-20

Ceramic Soldering Iron

- Ceramic heater
- Fast heat
- 60% energy saving



P.109

CP-369AE

Wire Stripping Tool

- For stripping 0.5, 1.2, 1.6, 2.0mm wire



P.60

9SD-200series

Pro-Soft Screwdriver

- Double structure handle provides user comfort and powerful use



P.137

CP-371

Supercrimp Crimp Tool Frame

- Interchangeable ratcheting crimper, 30% force saving



P.137

9PK-730N

Aluminium Frame Tool Case W/1 Pallet



- Bag with rivet design, more durable
- Key locks for maximum security

P.239

PC Networking Tool Kit

PK-4302 is a professional PC networking tool kit, including digital multimeter, tester, crimper, stripper, pliers, punch down tool and soldering iron for system integrators and MIS engineers of computer repairing and networking installation



Model No.	Soldering voltage	Standard plug		
PK-4302AI (Inch)	110V	A	9SD-201B	Pro-soft screwdriver (⊕ #0 3.0X75mm)
PK-4302BM (Metric)	220V	B	9SD-210A	Pro-soft screwdriver (⊖ 5 5x100mm)
PK-4302AI/PK-4302BM contents				
1PK-067DS	Dual color side cutting plier (165mm)		9SD-210B	Pro-soft screwdriver (⊕ #1 5x100mm)
1PK-709DS	Dual color long nose plier (165mm)		CP-3140	Pouch down tool with 110 blades
SI-130A-20	Ceramic soldering iron (110V or 220V)		PD-2607	Ball peen hammer
SI-130B-20			CP-369AE	Wire stripping tool for 0.5, 1.2, 1.6, 2.0mm
9CP-246D8P	Die set for RJ45/8P8C		DK-2039	Utility knife (3 blades self loading)
9CP-346DC	Die set for RG 58, 59, 62, 6		DK-2040	Measuring tape (3M/10FT)
9CP-346DC2	Die set for RG 59, 6, F Type		DP-366D	Desoldering pump
9CP-346DG	Die set for fiber optic connector		9HW-002A/9HW-002B	7 Pcs folding type hex key set (inch/ metric)
CP-371	Supercrimp crimp tool frame		MT-1210	3 1/2 compact digital multimeter
9CP-501BN	Wire stripper tool		MT-7051N	Multi-modular cable tester
9DP-S001	Pen solder 63%		SB-1912	Utility component storage box (187.5X117x22mm)
9SD-200-M5	Pro-soft screwdriver		SR-332	All purpose snip
9SD-200-I1	⊕ 3/16"(Inch) or 5mm(metric)		9PK-730N	Aluminium frame tool case w/1 pallet
9SD-200-M6	Pro-soft screwdriver			
9SD-200-I2	⊕ 1/4"(Inch) or 6mm(metric)			
9SD-201A	Pro-soft screwdriver (⊖ 3.0 3.0X75mm)			

- Case size: 458x330x150(mm) (O.D.)
- Individual packing: Color box

• NOTE : For quality reason, we reserve the right to change the above specifications without notice.

LAN Master Engineers Tool Kit



TOOL KITS

Model No.	Soldering voltage	Standard plug
1PK-19382A (Inch)	110V	A
1PK-19382B(Metric)	220-240V	B

1PK-19382A / 1PK-19382B contents

1PK-125T	Fine tip straight tweezer
1PK-258A	Side cutter 125mm
1PK-258B	Long nose plier 138mm
1PK-3003D11	RJ-45 die set
1PK-3003D12	RJ-11 die set
CP-336DA4	RG-58/59/62/174 coaxial cables die set
1PK-3003D16	RJ-22 die set
1PK-3003D3	RG-58, RG-59/62 AU BNC/TNC die set
CP-3005F	Quick interchangeable ratcheting crimp frame
1PK-3171	Spring hook
1PK-317N	Spring hook
DP-366P	Desoldering pump
1PK-H026	Adjustable wrench 6"
SI-130A-20	Ceramic soldering iron 110V or 220V
SI-130B-20	
1PK-T406	Straight forceps 6"
3PK-NT007N	Multi-network cable tester
608-330	Round cable cutter
CP-505	Universal stripping Tool
19400-M5/9408	Pro-soft s/d 3/16"(inch) or 5mm(metric)
19400-M6/9409	Pro-soft s/d 1/4"(inch) or 6mm(-metric)
89401A	Pro-soft s/d 3.2x75mm
89401B	Pro-soft s/d #0x75mm
89402A	Pro-soft s/d 5.0x75mm
89402B	Pro-soft s/d #1x75mm
89407B	Pro-soft s/d #2x100mm
8PK-031B	Desoldering wick
8PK-3001D	Precision wire stripper
CP-3148	Punch down tool with 110/88 and 66 double end blade
8PK-CT001	UTP/STP cable stripper

9SB-1007G	Multi-purpose Box
908-607	Alignment tool (200mm/2.0mm)
9FL-005	Mini flash light
9H002/9H002A	7 pcs folding type hex key set (inch) or (metric)
9H075	Cable tie
9PK-154B	Blowing brush
9RJ-11-50	6-position 4 contact flat stranded (50pcs/bag)
9RJ-22-50	4-position 4 contact flat stranded (50pcs/bag)
9RJ-45-25	8-position 8 contact round stranded (25pcs/bag)
9RJ-45PC	RJ-45 protection cap. (20pcs/bag)
9S001	Solder core 63% SN
9SD055-EX	Extension blade 7"(175mm)
9SD055N-6NA	Nut blade: 1/4", 3/8", 3/16", 7/16", 11/32", 5/16" (inch) 3mm, 4mm, 4.5mm, 5mm, 5.5mm, 6mm (metric)
9SD055-M3-M6	
9PK-3018SD	Super torque ratchet handle
9SD055N-BIT	8 pcs screwdriver blades: ⊕ #0, #1, #2 ⊖ 3, 5, 6mm ⊕ T10, T15
9SD055-T6	⊕ Driver blade T6
9SD055-T7	⊕ Driver blade T7
9SD055-T8	⊕ Driver blade T8
9SD055-T9	⊕ Driver blade T9
DK-2040	Measuring tape 3M/10FT
DK-2047N	Electrician's scissors
MS-391	Inspection mirror
DK-2039	Utility knife (3 blade self loading)
8PK-611	Wrist strap 10FT
9PK-9382-P2	Pallet for 1PK-9382
9PK-938-P	Pallet for 1PK-938 series
9PK-938-TP	Top pallet for 1PK-938 series
9PK-730N	Deluxe carry bag plus another three pallets

- Case size: 458x330x150(mm)(O.D.)
- Individual packing: Color box

SI-130A/B-20

Ceramic Soldering Iron

- Ceramic heater
- Fast heat
- 60% energy saving

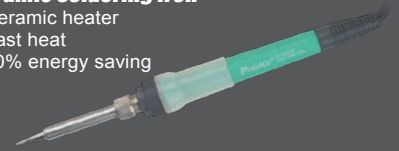

P.109

3PK-NT007N

Multi-network Cable Tester

- Automatically check cable for continuity, miss-wired, and polarization



P.61

CP-3005F

Quick interchangeable Ratcheting Crimp Frame

- New mechanical design for quick changing die set without tools



P.220

894series

Pro-Soft S/D

- Special inlaid blade insert
- Safe and durable



P.128

Super Torque Ratchet Handle

- Adjust multi-angle 15 section
- High torque:220kgf-cm

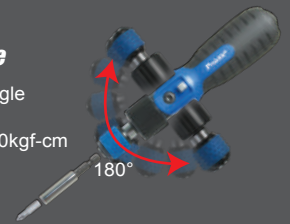

P.90

CP-3148

Punch Down Tool with 110/66 blades

- Punch down tool with high/low force



P.90

9PK-730N

Aluminium Frame Tool Case W/1 Pallet

- Bag with rivet design, more durable
- Key locks for maximum security



P.239

• NOTE : For quality reason, we reserve the right to change the above specifications without notice

ST-2012H

Soft Side Tool Pouch

- Keep your tools and suppliers handy
- Made from good fabric
- Complete with universal tool best system



MT-8001

Butt Set

- High impedance monitor for data safe operation, allowing use in tough weather environment



P.61

3PK-NT023N

Tone And Probe Kit

- Fast, accurate wire identification, virtually for any cable or wire!



P.220

MT-1232

3 3/4 Autorange Digital Multimeter

- Auto range
- Frequency, Temperature, Capacitance, 3 3/4 DMM all in 1



P.21

MT-8091

In-Line Modular Adapters

(4/6/8 Pin 3 In 1)

In-line modular adapter allows in-line testing for any plug/jack combination.



P.20

9SD-200series

Pro-Soft Screwdriver

- Double structure handle provides user comfort and powerful use



P.137

TC-310

Deluxe Aluminum Frame Tool Case

- Heavy duty structure
- 3 hinges / combination lock and corner protector



PK-12012H

Telecom Installation Kit



PK-12012H contents

PM-736	Dual color long nose plier 135 mm
PM-737	Dual color diagonal cutting plier 115 mm
CP-376KX	Professional modular crimps strips & cuts tool
CP-3140	Punch down tool 110 blade
MT-7051N	Multi-modular cable tester
MT-8001	Butt set

9SD-202A	⊖ Pro-soft screwdriver 5x75mm
9SD-207A	⊖ Pro-soft screwdriver 6x100mm
9SD-207B	⊕ Pro-soft screwdriver #2x100mm
9SD-220B	⊕ Pro-soft screwdriver #2x40mm
ST-2012H	Soft side tool pouch

- Bag size: 305x235x95(mm)
- Individual packing: Color box

PK-14019A PK-14019B

Communication Maintenance Kit



PK-14019A (Inch) / PK-14019B (Metric) contents

PM-736	Long nose plier 135mm
PM-737	Diagonal cutting plier 115mm
1PK-067DS	Dual color side cutting plier 165mm
1PK-709DS	Dual color long nose plier 165mm
1PK-H026	Adjustable wrench 6"
MT-1232	3 3/4 Autorange digital multimeter
3PK-NT023N	Tone probe kit
9HW-002A	7 pcs hex key set (inch) or (metric)
9HW-002B	
CP-3140	Punch down tool 110 blade
SR-330	All Purpose Snip
MT-8001	Butt set
MT-8091	In-line modular adapters 4/6/8 pin 3 in 1
PD-998	Electrician's knife

9SD-201A	⊖ Pro-soft screwdriver 3.0 x75mm
9SD-201B	⊕ Pro-soft screwdriver #0 x75mm
9SD-207A	⊖ Pro-soft screwdriver 6.0 x100mm
9SD-207B	⊕ Pro-soft screwdriver #2 x100mm
9SD-210A	⊖ Pro-soft screwdriver 5.0 x100mm
9SD-210B	⊕ Pro-soft screwdriver #1 x100mm
9SD-200-11/ M5	⊖ Pro-soft screwdriver 3/16" (inch) or 5mm (metric)
9SD-200-12/ M6	⊖ Pro-soft screwdriver 1/4" (inch) or 6mm (metric)
TC-310	Deluxe aluminum frame tool case

- Case size: 440x340x165(mm) (O.D)
- Individual packing: Plain box + Color label

• NOTE : For quality reason, we reserve the right to change the above specifications without notice.

Deluxe Telecom Installers Kit



TOOL KITS

PK-4021I (Inch) / PK-4021M (Metric) Series contents	
SR-332	All purpose snip
1PK-CT007	Double end socket can wrench
HW-121M	8 pcs folding hex key set
PD-994	Electrician's knife
PM-909	Long nose plier (170mm) black oxide finish 6"
1PK-258A	Side cutter(125mm)
8PK-101K	Micro cutting plier
1PK-H026	Adjustable wrench-6"
1PK-H078	Probe-pic spudder
DK-2047N	Electrician's scissors
9SD-207A	⊖ Pro-soft screwdriver (6.0x100mm)
9SD-207B	⊕ Pro-soft screwdriver (#2x100mm)
9SD-210A	⊖ Pro-soft screwdriver (5.0x100mm)
9SD-210B	⊕ Pro-soft screwdriver (#1x100mm)
9SD057P	Double-end screwdriver
1PK-H064	Precision hand drill
8PK-SD016	23 pcs 1/4" driver socket set
MT-7068	All-in-one toner & probe kit
MT-8091	In-line modular adapters 4/6/8 pin 3 in 1

CP-3148	Punch down tool with 110/88 and 66 double end blade
PD-2606	Heavy duty curved-claw hammer W/Fiberglass handle
DK-2032	Fish tape (50FT)
MS-V305	Velcro cable tie-5" assortment (15 pcs/pack)
HW-609A HW-609B	10 pcs electronic combination wrench (Inch) or (Metric)
103-132C	Utility component storage box (165x95x45mm)
CP-371	Pro-crimper (frame only)
CP-236DM5	Die set for CP-371G 8P8C/RJ45 plug & cable O/D around 5.2ø
CP-336DA4	Die set for CP-371O RG 58, 59, 62, 174
9PK-3003D10	Die set for CP-371T CATV F connectors RG 59, 6
DK-2040	Hi-rel tape measure 3M/10Ft
1PK-T406	6" straight forceps
9PK-4021-P	Pallet for PK-4021
9PK-4021-TP	Top pallet for PK-4021
9PK-990	Aluminum frame tool case plus another one pallet

• Case size : 461x331x156 (mm) (O.D)
• Individual packing : Color box

MT-7068

All-in-one Toner & Probe Kit

- VDV all in one tester (Video/ Data/ Audio)



P.9

MT-8091

In-line modular adapters 4/6/8 pin 3 in 1

- In-line modular adapter allows in-line testing for any plug/jack combination.



P.5

CP-371

Supercrimp Crimp Tool Frame

- Interchangeable ratcheting crimper, 30% force saving



P.137

8PK-SD016

23Pcs 1/4" Driver Socket Set

- Socket x 9pcs of each metric and inch size
- 2 handles for different applications



P.161

SR-332

All Purpose Snip

- Stainless blade for multi-purpose cutting work



P.69

9SD-200series

Pro-Soft Screwdriver

- Double structure handle provides user comfort and powerful use



P.137

9PK-990

Aluminum Frame Tool Case



P.237

• NOTE : For quality reason, we reserve the right to change the above specifications without notice

MT-1232

3 3/4 Autorange Digital Multimeter

- Auto range
- Frequency, Temperature, Capacitance, 3 3/4 DMM all in 1



P.21

MT-8006B

Data Diver

- Talk/Monitor Mode
- LCD Display
- High voltage indication



P.6

MT-7068

All-in-one Toner & Probe Kit

- VDV All in one tester (Video/ Data/ Audio)



P.9

8PK-301F2

All-in-one Toner & Probe Kit

- Ratchet crimping tool for ST, SC & FC fiber optic connectors, RG58, RG174 & Belden 8218



P.76

Super Torque Ratchet Handle

- Adjust multi-angle 15 section
- High torque:220kgf-cm

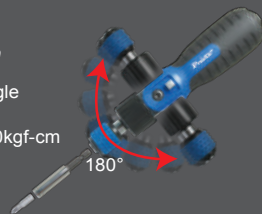

SI-130A/B-20

Ceramic Soldering Iron

- Ceramic heater
- Fast heat
- 60% energy saving



P.109

TC-2009

ABS Carrying Tool Case



P.238

Master Telecom Installation and Service Kit



Model No.	Soldering voltage	Standard plug
PK-4023EI (Inch)	110V	A
PK-4023BM(Metric)	220~240V	B

PK-4023BM / PK-4023EI contents	
8PK-031B	Soldering wick with 2.0mm
1PK-154B	Blowing brush
6PK-322	Rotary coaxial stripper
9PK-4023-P	Pallet for PK-4023
9PK-4023-TP	Top pallet for PK-4023
9SD055-EX	Extension blade 7" (175mm)
9SD055-T6	Driver blade T6
9SD055-T7	Driver blade T7
9SD055-T8	Driver blade T8
9SD055-T9	Driver blade T9
9SD055N-BIT	8 pcs screwdriver blades ⊕ #0, #1, #2 ⊖ 3, 5, 6mm ⊕T10, T15
8PK-611	Wrist strap 10FT
9SD055N-6NA	⊙ Nut blade: 1/4", 3/8", 3/16", 7/16", 11/32", 5/16"(inch) 3mm, 4mm, 4.5mm, 5mm, 5.5mm, 6mm(metric)
9PK-3018SD	Super torque ratchet handle
8PK-905A	5" cutting pliers (125mm)
8PK-906A	5.5" long nose pliers (140mm)

PM-901	8" lineman's pliers (215mm) black oxide finish
MT-1232	Professional 3 3/4 digital multimeter
SR-330	All purpose snip
1PK-H026	Adjustable wrench 6"
8PK-301F2	8.7" fiber optic crimping tool
HW-121M	8 pcs folding hex key set (Inch) or (Metric)
HW-121I	
HW-010	Adjustable wrenches-10"
1PK-CT007	Double end socket can wrench
DK-2039	Utility knife(3 blades self loading)
CP-3148	Punch down tool with 110/88 and 66 double end blade
CP-376TR	4P/6P/8P Telecom crimping tool
908-328G	Testing screwdriver
203-132F	Utility component storage box
SI-130A-20	Ceramic Soldering iron 110V or 220V/30W
SI-130B-20	
8PK-3002D	Precision wire stripper (AWG22/20/18/16/14/12/10)
MT-7068	All-in-one toner & probe kit
MT-8006B	Telecom test set
TC-2009	Tool case W/1 pallet (463x331x171 mm)

- Case size : 463x331x171(mm) (O.D)
- Individual packing : Color box

• NOTE : For quality reason, we reserve the right to change the above specifications without notice.

Telecom & Networking Installation Tool Kit



TOOL KITS

Model No.	Soldering voltage	Standard plug
PK-4028AI (Inch)	110V	A
PK-4028BM(Metric)	220V	B

PK-4028AI / PK-4028BM contents	
8PK-605A	5 Pcs needle file set
CP-371	Pro-crimper (frame only)
9CP-236D6P	Die set, rj11
9CP-236D8P	Die set, rj45 modular plugs 8 position (Standard plugs, not amp)
CP-3140	Punch down tool (with 110 blades)
5CP-3140-66	Replacement blade for cp-3140 with 66 type
9CP-336DH1	Die set for CP-372T CATV F connectors RG 59,6
9CP-336DP1	Die set for CP-372S RG 58,59,62,6
DK-2039	Utility knife(3 blades self loading)
DK-2047N	Electrician's scissors
DP-366D	Desoldering pump
9FL-506	LED flash light
1PK-H026	Adjustable wrenches 6"
9MS-001	PVC insulated tape
NT-305	Contact voltage tester
1PK-051AS	8" Combination plier
1PK-067AS	6" Side cutting plier
1PK-709AS	6" Long nose plier
SI-130A-20	Ceramic soldering iron 110V or 220V
SI-130B-20	

PN-P008	Groove joint plier 8"
9SD-202A	⊖ Pro-soft screwdriver (5 5x75mm)
9SD-202B	⊖ Pro-soft screwdriver (#1 5x75mm)
9SD-207A	⊖ Pro-soft screwdriver (6 6x100mm)
9SD-207B	⊕ Pro-soft screwdriver (#2 6x100mm)
9SD-220A	⊖ Pro-soft screwdriver (6 6x40mm)
9SD-220B	⊕ Pro-soft screwdriver (#2 6x40mm)
9CP-501BN	Wire stripper tool
DK-2040	Measuring tape (3M/10FT)
HW-129BA / HW-129B	9Pcs ball point long arm hex key set (1/16", 5/64", 3/32", 1/8"/5/32", 3/16", 1/4", 5/16", 3/8") (1.5, 2, 2.5, 3, 4, 5, 6, 8, 10mm)
MT-7057N	Cable sniffer-remote
MT-8091	In-line modular adapters 4/6/8 pin 3 in 1
PD-2607	Ball peen hammer with fiberglass handle
SR-332	All purpose snip
ST-2012H	Soft side tool pouch
9PK-4028-P	Pallet for PK-4028 series
9PK-4028-TP	Pallet for PK-4028 series
TC-736	Aluminum frame tool case w/2 pallets

• Case size : 486x325x159(mm)(O.D)
• Individual packing : Color box

MT-7057N

Cable Sniffer-remote

- RJ-45/ RJ-11/ RJ12 / USB /BNC tester, easy to detect open, short, miswired and cross-connected wire.



P.11

SI-130A/B-20

Ceramic Soldering Iron

- Ceramic heater
- Fast heat
- 60% energy saving



P.109

CP-371

Supercrimp Crimp Tool Frame

- Interchangeable ratcheting crimper, 30% force saving



P.137

NT-305

Contact voltage tester

- LED display for ACV Test: 70 to 250 ACV and DCV Test: Up to 12, 36, 55 DCV



P.32

SR-332

All Purpose Snip

- Stainless blade for multi-purpose cutting work



P.69

9SD-200series

Pro-Soft Screwdriver

- Double structure handle provides user comfort and powerful use



P.137

TC-736

Aluminum Frame Tool Case



P.237

• NOTE : For quality reason, we reserve the right to change the above specifications without notice

Model No	QTY/CTN	N.W.	G.W.	CUFT	M3	M.O.Q.	Page
10							
103-132C	120	16.50	17.50	4.02	0.11	120	235
103-132D	54	17.60	19.00	5.00	0.14	54	234
108-361	144	15.50	16.50	2.68	0.08	144	122
19400-M3	180	9.50	10.50	1.78	0.05	180	128
19400-M3.5	180	9.50	10.50	1.78	0.05	180	128
19400-M4	180	10.00	11.00	1.78	0.05	180	128
19400-M4.5	180	10.00	11.00	1.78	0.05	180	128
19400-M5	180	9.50	11.08	1.78	0.05	180	128
19400-M5.5	180	9.50	11.00	1.78	0.05	180	128
19400-M6	180	9.50	11.00	1.78	0.05	180	128
1F							
1FB-LC1	120	4.00	5.00	1.78	0.05	120	181
1FB-SC	120	4.00	5.00	1.78	0.05	120	181
1FB-ST	120	4.00	5.00	1.78	0.05	120	181
1H055-T	240	5.00	6.00	1.78	0.05	240	173
1PK							
1PK-034NA	300	5.40	7.50	1.78	0.05	300	147
1PK-034NB	300	5.40	7.50	1.78	0.05	300	147
1PK-034NC	300	5.40	7.50	1.78	0.05	300	147
1PK-034ND	300	5.40	7.50	1.78	0.05	300	147
1PK-034NE	300	5.40	7.50	1.78	0.05	300	147
1PK-034NF	300	5.40	7.50	1.78	0.05	300	147
1PK-034NG	300	5.40	7.50	1.78	0.05	300	147
1PK-034NH	300	5.40	7.50	1.78	0.05	300	147
1PK-036S	144	13.50	15.50	1.78	0.05	144	51
1PK-037S	144	13.00	15.00	1.78	0.05	144	51
1PK-046S	144	12.00	14.00	1.78	0.05	144	51
1PK-051	24	8.60	9.50	0.87	0.02	24	57
1PK-051AS	24	8.60	9.50	0.87	0.02	24	59
1PK-051DS	24	9.60	10.50	0.87	0.02	24	58
1PK-052	96	20.00	22.00	1.78	0.05	96	57
1PK-052AS	72	17.00	19.50	2.69	0.08	72	59
1PK-052DS	72	16.50	19.00	1.78	0.05	72	58
1PK-054S	144	17.00	19.00	1.78	0.05	144	51
1PK-055S	144	13.50	15.50	1.78	0.05	144	51
1PK-066N	96	8.16	10.50	1.78	0.05	96	43
1PK-067	96	17.00	19.00	1.78	0.05	96	57
1PK-067AS	72	17.50	20.00	2.69	0.08	72	59
1PK-067DS	72	15.50	18.00	1.78	0.05	72	58
1PK-101-E	144	12.96	15.00	1.87	0.05	144	38
1PK-101T	300	10.00	11.00	1.78	0.05	300	205
1PK-102-E	144	12.96	16.00	1.87	0.05	144	39
1PK-102T	300	9.50	10.50	1.78	0.05	300	205
1PK-104-E	144	12.96	15.80	1.87	0.05	144	39
1PK-104T	300	9.50	10.50	1.78	0.05	300	205
1PK-105-E	144	12.96	15.80	1.87	0.05	144	39
1PK-105T	300	9.50	10.50	1.78	0.05	300	205
1PK-106	144	14.00	15.00	1.78	0.05	144	53
1PK-106T	300	14.50	15.50	1.78	0.05	300	206
1PK-107	144	14.00	15.00	1.78	0.05	144	53
1PK-108T	300	13.00	14.00	1.78	0.05	300	206
1PK-110T	300	10.00	11.00	1.78	0.05	300	205
1PK-112T	300	10.00	11.00	1.78	0.05	300	205

Model No	QTY/CTN	N.W.	G.W.	CUFT	M3	M.O.Q.	Page
1PK-115T	300	14.50	15.50	1.78	0.05	300	206
1PK-117T	300	13.00	14.00	1.78	0.05	300	206
1PK-118T	300	13.00	14.00	1.78	0.05	300	206
1PK-119T	300	16.00	17.00	1.78	0.05	300	206
1PK-122	100	11.00	13.00	2.13	0.06	100	222
1PK-123T	300	11.00	12.00	1.78	0.05	300	206
1PK-125T	300	9.50	10.50	1.78	0.05	300	205
1PK-1305NA	2	13.00	14.00	2.16	0.06	2	264
1PK-1305NB	2	12.40	13.40	2.16	0.06	2	264
1PK-1700NA	2	17.00	18.00	2.16	0.06	2	266
1PK-1700NB	2	17.00	18.00	2.16	0.06	2	266
1PK-1900NA	2	19.00	20.00	2.37	0.07	2	269
1PK-1900NB	2	18.20	19.20	2.37	0.07	2	269
1PK-19382A	2	16.00	17.00	2.04	0.06	2	284
1PK-19382B	2	15.60	16.40	2.04	0.06	2	284
1PK-1990A	2	21.10	22.20	2.56	0.07	2	270
1PK-1990B	2	20.20	21.20	2.56	0.07	2	270
1PK-20	144	13.00	14.00	1.78	0.05	144	44
1PK-2002A	5	26.00	27.50	4.22	0.12	5	263
1PK-2002B	5	28.00	29.00	4.22	0.12	5	263
1PK-2003A	5	16.00	17.00	2.88	0.08	5	262
1PK-2003B	5	16.00	18.00	2.88	0.08	5	262
1PK-2009A	2	20.00	21.00	2.68	0.08	2	273
1PK-2009B	2	20.00	21.00	2.68	0.08	2	273
1PK-201	48	13.50	14.50	1.78	0.05	48	135
1PK-202A	72	18.00	19.00	1.81	0.05	72	136
1PK-202B	72	18.00	19.00	1.81	0.05	72	136
1PK-209	144	11.52	13.30	1.87	0.05	144	38
1PK-21	144	13.00	14.00	1.78	0.05	144	44
1PK-210	144	10.08	13.10	1.87	0.05	144	38
1PK-211	144	11.52	13.30	1.87	0.05	144	38
1PK-212	120	18.50	19.50	1.78	0.05	120	135
1PK-212H	120	18.50	19.50	1.78	0.05	120	135
1PK-22	144	9.07	11.50	1.78	0.05	144	44
1PK-23	144	13.00	14.00	1.78	0.05	144	44
1PK-239	144	15.00	16.00	1.78	0.05	144	45
1PK-24	144	12.00	13.00	1.78	0.05	144	44
1PK-243	144	16.00	17.00	1.78	0.05	144	45
1PK-244	144	17.00	18.00	2.69	0.08	144	45
1PK-25	144	12.00	13.00	1.78	0.05	144	44
1PK-256A	144	14.40	16.00	1.87	0.05	144	52
1PK-256B	144	13.68	16.00	1.87	0.05	144	52
1PK-256C	144	14.40	16.50	1.87	0.05	144	52
1PK-258A	144	13.00	15.00	1.78	0.05	144	46
1PK-258B	144	14.00	16.00	1.78	0.05	144	46
1PK-25P-CE	144	13.60	14.60	1.87	0.05	144	39
1PK-25P-E	144	13.50	14.50	1.87	0.05	144	39
1PK-26	144	12.00	13.00	1.78	0.05	144	44
1PK-27	144	11.00	12.00	1.78	0.05	144	45
1PK-28	144	14.00	15.00	1.78	0.05	144	45
1PK-29	144	14.00	15.00	1.78	0.05	144	45
1PK-291	144	14.50	15.50	1.78	0.05	144	45
1PK-3001E	144	18.72	20.50	1.87	0.05	144	88
1PK-3002E	144	18.72	20.50	1.87	0.05	144	88

Model No	QTY/CTN	N.W.	G.W.	CUFT	M3	M.O.Q.	Page	Model No	QTY/CTN	N.W.	G.W.	CUFT	M3	M.O.Q.	Page
1PK-3003D1	120	8.52	10.50	1.78	0.05	120	75	1PK-5101-CE	144	15.84	18.10	1.87	0.05	144	39
1PK-3003D10	120	8.64	10.50	1.78	0.05	120	74	1PK-5101-E	144	15.84	18.21	1.87	0.05	144	39
1PK-3003D11	120	9.72	12.00	1.78	0.05	120	74	1PK-5102-E	144	15.84	18.50	1.87	0.05	144	39
1PK-3003D12	120	9.24	12.00	1.78	0.05	120	74	1PK-606A	240	6.10	7.90	1.57	0.04	240	147
1PK-3003D13	120	9.36	12.00	1.78	0.05	120	74	1PK-612NA	10	17.00	18.00	2.57	0.07	10	254
1PK-3003D14	120	10.44	12.50	1.78	0.05	120	74	1PK-612NB	10	17.00	18.00	2.57	0.07	10	254
1PK-3003D16	120	9.84	12.00	1.78	0.05	120	74	1PK-616A	8	21.12	22.50	2.72	0.08	8	257
1PK-3003D17	120	10.44	12.50	1.78	0.05	120	74	1PK-616B	8	22.00	23.00	2.72	0.08	8	257
1PK-3003D17-MA	120	11.50	12.50	1.78	0.05	120	74	1PK-618A	10	22.50	23.50	1.98	0.06	10	253
1PK-3003D2	120	9.50	10.50	1.78	0.05	120	75	1PK-618B	10	21.80	22.80	1.98	0.06	10	253
1PK-3003D21	120	9.50	10.50	1.78	0.05	120	75	1PK-635	30	14.00	15.00	1.78	0.05	30	252
1PK-3003D22	120	11.50	12.50	1.78	0.05	120	74	1PK-636B	8	15.00	16.00	2.72	0.08	8	254
1PK-3003D25	300	18.00	19.00	0.50	0.01	300	74	1PK-639	20	17.00	18.00	1.42	0.04	20	255
1PK-3003D28	120	11.00	12.00	1.78	0.05	120	74	1PK-640	20	14.00	15.00	1.42	0.04	20	251
1PK-3003D3	120	9.50	10.50	1.78	0.05	120	74	1PK-690A	10	17.50	18.50	1.98	0.06	10	254
1PK-3003D30	120	10.00	11.00	1.78	0.05	120	74	1PK-690B	10	18.00	19.00	1.98	0.06	10	254
1PK-3003D31	120	10.00	11.00	1.78	0.05	120	74	1PK-701	144	10.00	11.00	1.78	0.05	144	49
1PK-3003D32	120	11.00	12.00	1.78	0.05	120	74	1PK-702	144	10.00	11.00	1.78	0.05	144	49
1PK-3003D33	120	10.00	11.00	1.78	0.05	120	74	1PK-705	144	14.00	15.00	1.78	0.05	144	49
1PK-3003D34	120	9.60	10.60	1.78	0.05	120	74	1PK-705Y	144	15.00	16.00	1.78	0.05	144	53
1PK-3003D36	300	24.00	25.00	1.80	0.05	300	75	1PK-706	144	14.00	15.00	1.78	0.05	144	49
1PK-3003D4	120	9.50	10.50	1.78	0.05	120	75	1PK-706Y	144	19.00	20.00	1.78	0.05	144	53
1PK-3003D42	120	9.50	10.50	1.80	0.05	120	75	1PK-708	96	16.50	17.50	1.78	0.05	96	57
1PK-3003D6	120	8.28	10.50	1.78	0.05	120	74	1PK-709	96	15.30	17.30	1.78	0.05	96	57
1PK-3003D8	120	9.50	10.50	1.78	0.05	120	74	1PK-709AS	72	13.20	15.70	2.69	0.08	72	59
1PK-3003D9	120	9.50	10.50	1.78	0.05	120	74	1PK-709DS	72	13.20	15.70	1.78	0.05	72	58
1PK-3003F	20	12.50	13.50	1.05	0.03	20	75/201	1PK-709Y	96	16.00	17.00	1.78	0.05	96	58
1PK-301	30	17.00	18.00	1.78	0.05	30	252	1PK-710KA	6	23.04	24.04	3.05	0.09	6	262
1PK-302NA	10	14.00	15.00	1.73	0.05	10	253	1PK-710KB	6	24.20	25.20	3.05	0.09	6	262
1PK-302NB	10	13.00	14.00	1.73	0.05	10	253	1PK-7110A	5	20.00	21.00	2.30	0.07	5	263
1PK-30-E	144	12.96	16.20	1.87	0.05	144	38	1PK-7110B	5	20.00	21.00	2.30	0.07	5	263
1PK-3171	360	10.50	11.50	2.09	0.06	360	224	1PK-717	200	16.00	17.50	1.48	0.04	200	49
1PK-3175	200	11.00	12.00	0.56	0.02	200	224	1PK-727	144	14.00	15.00	1.78	0.05	144	53
1PK-3178	180	13.50	14.50	1.78	0.05	180	224	1PK-810A	10	16.00	17.00	1.73	0.05	10	253
1PK-3179	144	11.00	12.00	2.70	0.08	144	149	1PK-810B	10	16.00	17.00	1.73	0.05	10	253
1PK-317N	360	11.50	12.50	2.09	0.06	360	224	1PK-813A	10	22.00	23.00	2.57	0.07	10	256
1PK-34	144	14.50	15.50	1.78	0.05	144	45	1PK-813B	10	20.80	21.80	2.57	0.07	10	256
1PK-3616	120	11.30	12.30	1.78	0.05	120	122	1PK-813B	10	20.80	21.80	2.57	0.07	10	256
1PK-362D	20	10.00	11.00	1.14	0.03	20	121	1PK-816N	10	12.90	13.90	1.73	0.05	10	255
1PK-390G	100	13.00	15.00	2.15	0.06	100	222	1PK-818A	8	23.00	24.00	2.72	0.08	8	281
1PK-396A	144	10.08	12.70	1.87	0.05	144	43	1PK-818B	8	22.20	23.20	2.72	0.08	8	281
1PK-396B	144	10.08	13.00	1.87	0.05	144	43	1PK-850A	2	15.40	16.00	2.16	0.06	2	267
1PK-396E	144	10.08	12.30	1.87	0.05	144	43	1PK-850B	2	15.90	16.90	2.16	0.06	2	267
1PK-500-1	40	12.00	13.00	1.78	0.05	40	173	1PK-932	10	18.00	19.00	2.49	0.07	10	278
1PK-500A-2	16	13.00	14.00	1.81	0.05	16	173	1PK-933	10	16.00	17.00	2.54	0.07	10	278
1PK-500B-2	16	7.80	8.80	1.81	0.05	16	173	1PK-936A	8	24.00	25.50	2.72	0.08	8	281
1PK-500C-2	16	14.50	15.50	1.81	0.05	16	173	1PK-936B	8	24.00	25.50	2.72	0.08	8	281
1PK-501A	144	8.64	10.50	1.87	0.05	144	42	1PK-938A	2	15.70	16.70	2.04	0.06	2	282
1PK-501B	144	8.64	10.50	1.87	0.05	144	42	1PK-938B	2	15.70	16.70	2.04	0.06	2	282
1PK-501C	144	8.64	10.90	1.87	0.05	144	42	1PK-940	8	11.00	12.00	1.98	0.06	8	279
1PK-501D	144	8.64	10.50	1.87	0.05	144	42	1PK-9401	10	8.50	9.50	1.84	0.05	10	128
1PK-501E	144	8.64	10.80	1.87	0.05	144	42	1PK-9402	60	14.50	15.50	1.39	0.04	60	128
1PK-5101	144	15.84	18.00	1.87	0.05	144	52	1PK-940E	8	10.80	11.80	1.98	0.06	8	279
1PK-5101-C	144	15.84	17.60	1.87	0.05	144	52	1PK-940KN	8	13.00	14.00	1.98	0.06	8	183

Model No	QTY/CTN	N.W.	G.W.	CUFT	M3	M.O.Q.	Page
1PK-A001	180	6.30	8.50	1.78	0.05	180	147
1PK-CT006	96	17.00	18.00	1.78	0.05	96	82
1PK-CT007	120	18.00	19.00	1.19	0.03	120	83
1PK-GS003	100	9.50	11.20	2.15	0.06	100	113
1PK-H024	240	13.90	16.00	1.78	0.05	240	160
1PK-H026	144	21.50	23.50	1.78	0.05	144	160
1PK-H028	48	12.00	13.50	0.87	0.02	48	160
1PK-H064	180	8.00	9.00	1.78	0.05	180	225
1PK-H074	300	5.00	6.00	1.78	0.05	300	122
1PK-SC109NB	40	10.00	11.50	1.90	0.05	40	111
1PK-SD006	60	13.00	14.00	1.62	0.05	60	133
1PK-T405	144	9.00	10.00	1.78	0.05	144	225
1PK-T406	144	11.00	12.00	1.78	0.05	144	225
1PK-T416	144	11.00	12.00	1.78	0.05	144	225
1PK-TZ001	300	10.50	11.50	1.78	0.05	300	204
1PK-TZ002	300	9.48	11.00	1.78	0.05	300	204
1PK-TZ003	300	9.24	11.00	1.78	0.05	300	204
1PK-TZ004	300	9.84	11.00	1.78	0.05	300	204
1PK-TZ005	300	9.30	11.00	1.78	0.05	300	204
1PK-TZ015	120	9.50	10.50	1.78	0.05	120	207
1PK-TZ017	120	9.10	11.00	1.78	0.05	120	207
1PK-TZ019	120	9.50	10.50	1.78	0.05	120	207
203							
203-115A	75	28.00	29.00	4.84	0.14	75	235
203-115B	40	24.00	26.30	4.84	0.14	40	235
203-125A	250	23.50	24.94	1.36	0.04	250	235
203-125B	100	17.50	18.80	1.33	0.04	100	235
203-125C	25	13.50	14.80	1.42	0.04	25	235
203-132E	72	13.75	15.10	3.43	0.10	72	234
203-132F	60	11.40	12.80	3.47	0.10	60	234
203-132G	120	13.00	14.00	3.86	0.11	120	234
203-132H	40	12.40	13.60	3.42	0.10	40	234
203-132I	40	14.00	15.00	3.72	0.11	40	234
3PK							
3PK-NT005N	48	9.60	10.80	2.52	0.07	48	12
3PK-NT007N	48	11.00	13.00	2.52	0.07	48	12
3PK-NT023N	20	9.00	10.00	2.71	0.08	20	10
50							
503-132D-P	100	3.50	3.67	0.02	0.00	100	234
503-132E-D12	-	-	-	-	-	-	234
503-132F-D10	-	-	-	-	-	-	234
508-366A-T	100	0.16	0.16	0.10	0.00	100	119
508-366C-T	-	-	-	-	-	-	119
508-366D-T	100	0.30	0.80	0.50	0.01	100	119
508-376E-B	-	-	-	-	-	-	79
508-376ER-B	-	-	-	-	-	-	79
508-394A-B	500	6.50	7.50	0.55	0.02	500	71
508-394B-B	500	10.00	11.00	0.70	0.02	500	71
5CP							
5CP-16	500	18.00	19.00	0.45	0.01	500	97
5CP-16A	500	18.00	19.00	0.45	0.01	500	97
5CP-16B	500	18.00	19.00	0.52	0.01	500	97
5CP-16BK	500	9.00	10.00	0.45	0.01	500	97
5CP-16D	300	18.00	19.00	0.45	0.01	300	97

Model No	QTY/CTN	N.W.	G.W.	CUFT	M3	M.O.Q.	Page
5CP-3140-110	-	-	-	-	-	-	98
5CP-3140-66	-	-	-	-	-	-	98
5CP-326-B	-	-	-	-	-	-	95
5CP-376U-BLADE	-	-	-	-	-	-	78
5CP-505-B	-	-	-	-	-	-	93
5CP-505-RG	-	-	-	-	-	-	93
5CP-508-B	-	-	-	-	-	-	93
5CP-508-RG	-	-	-	-	-	-	93
5DP							
5DP-366D-T	-	-	-	-	-	-	119
5DP-366J-T	-	-	-	-	-	-	119
5FB							
5FB-1688-BLADE	-	-	-	-	-	-	180
5GS							
5GS-210-H	-	-	-	-	-	-	113
5M T							
5MT-T-005N	-	-	-	-	-	-	113
5MT-T-007	-	-	-	-	-	-	113
5MT-T-008	-	-	-	-	-	-	113
5MT-T-009	-	-	-	-	-	-	113
5MT-T-010	-	-	-	-	-	-	113
5PD							
5PD-394A-B	-	-	-	-	-	-	71
5PD-510-B	432	10.80	11.00	0.31	0.01	432	71
5PK							
5PK-101-2T	-	-	-	-	-	-	113
5PK-14	-	-	-	-	-	-	99
5PK-14A	-	-	-	-	-	-	99
5PK-14B	-	-	-	-	-	-	99
5PK-14BK	-	-	-	-	-	-	99
5PK-14C	100	1.70	2.00	0.00	0.00	100	99
5PK-14D	-	-	-	-	-	-	99
5PK-14P	-	-	-	-	-	-	99
5PK-15B	-	-	-	-	-	-	98
5PK-15C	-	-	-	-	-	-	98
5PK-15D	-	-	-	-	-	-	98
5PK-312B-B	-	-	-	-	-	-	94
5PK-3140N-BIX	400	11.50	12.00	0.40	0.01	400	97
5PK-325-BL	-	-	-	-	-	-	95
5PK-3321	-	-	-	-	-	-	94
5PK-366NA-T	100	1.50	2.00	0.54	0.02	100	119
5PK-366N-T	100	1.50	2.00	0.59	0.02	100	119
5PK-366PN-T	-	-	-	-	-	-	119
5PK-376A-BLADE	-	-	-	-	-	-	80/92
5PK-376C-BLADE	-	-	-	-	-	-	78
5PK-376K-BLADE	-	-	-	-	-	-	77
5PK-502-B	-	-	-	-	-	-	95
5PK-535-FB	-	-	-	-	-	-	65
5PK-535-RB	-	-	-	-	-	-	65
5PK-S120NA-30H	-	-	-	-	-	-	110
5PK-S120NA-40H	-	-	-	-	-	-	110
5PK-S120NA-60H	-	-	-	-	-	-	110
5PK-S120NB-30H	-	-	-	-	-	-	110
5PK-S120NB-40H	-	-	-	-	-	-	110

Model No	QTY/CTN	N.W.	G.W.	CUFT	M3	M.O.Q.	Page	Model No	QTY/CTN	N.W.	G.W.	CUFT	M3	M.O.Q.	Page
5PK-S120NB-60H	-	-	-	-	-	-	110	5SI-216N-2.4D	-	-	-	-	-	-	106
5PK-SR250-BS	30	21.00	21.70	0.72	0.02	30	67	5SI-216N-2C	-	-	-	-	-	-	106
5PK-SR500-BS	20	21.20	22.20	0.72	0.02	20	67	5SI-216N-3.2D	-	-	-	-	-	-	106
5PT								5SI-216N-3C	-	-	-	-	-	-	106
5PT-0721-ADA	-	-	-	-	-	-	170	5SI-216N-4C	-	-	-	-	-	-	106
5PT-0721-ADF	24	12.00	13.00	1.73	0.05	24	170	5SI-216N-B	-	-	-	-	-	-	106
5PT-1080-P1	-	-	-	-	-	-	170	5SI-216N-B1.0	-	-	-	-	-	-	106
5PT-1201-ADA	24	12.00	13.00	1.73	0.05	24	170	5SI-216N-BC	-	-	-	-	-	-	106
5PT-1201-ADF	24	13.25	14.80	1.39	0.04	24	170	5SI-216N-I	-	-	-	-	-	-	106
5PT-1201-BAT	30	12.00	13.00	1.73	0.05	30	170	5SI-216N-K	-	-	-	-	-	-	106
5PT-1201-CH	24	12.00	13.00	1.73	0.05	24	170	5SI-259-B	-	-	-	-	-	-	105
5PT-1206-ADA	-	-	-	-	-	-	169	5SI-259-C	-	-	-	-	-	-	105
5PT-1206-ADF	-	-	-	-	-	-	169	5SI-259-D	-	-	-	-	-	-	105
5PT-1206-BAT	-	-	-	-	-	-	169	5SI-259-I	-	-	-	-	-	-	105
5PT-1206-BIT	-	-	-	-	-	-	166	5SI-259-K	-	-	-	-	-	-	105
5PT-1206-DRI	-	-	-	-	-	-	169	5SI-S106A-H	-	-	-	-	-	-	112
5PT-1207-SOC	-	-	-	-	-	-	169	5SI-S106B-H	-	-	-	-	-	-	112
5PT-1210-CB	-	-	-	-	-	-	169	5SR							
5PT-1210-PAD	-	-	-	-	-	-	169	5SR-536-FB	-	-	-	-	-	-	65
5PT-1210-SB	-	-	-	-	-	-	169	5SR-536-RB	-	-	-	-	-	-	65
5PT-1210-SP	-	-	-	-	-	-	169	5SS-331N-DG	-	-	-	-	-	-	104
5PT-1361-ADA	-	-	-	-	-	-	170	5SS-331N-H	-	-	-	-	-	-	104
5PT-1361-ADF	-	-	-	-	-	-	170	5SS-331N-NZ	-	-	-	-	-	-	104
5PT-1361-P1	-	-	-	-	-	-	170	5SS-331N-NZ1	-	-	-	-	-	-	104
5PT-1361-P1	-	-	-	-	-	-	170	5SS-331N-NZ2	-	-	-	-	-	-	104
5PT-1801-ADA	-	-	-	-	-	-	167	5SS-331N-NZ3	-	-	-	-	-	-	104
5PT-1801-ADF	-	-	-	-	-	-	167	5SS-593-F	-	-	-	-	-	-	107
5PT-1801-BAT	-	-	-	-	-	-	167	5SS-969NB-HG	-	-	-	-	-	-	103
5PT-1801-BIT1	-	-	-	-	-	-	166	5SS-969NE-HG	-	-	-	-	-	-	103
5PT-1801-DRI	-	-	-	-	-	-	166	5SS-989NB-H	-	-	-	-	-	-	101
5PT-1802-SOC	-	-	-	-	-	-	166	5SS-989NE-H	-	-	-	-	-	-	101
5PT-1805-BLA	-	-	-	-	-	-	171	5SW-106-B	80	8.80	9.80	1.23	0.03	80	225
5PT-1805-HK	-	-	-	-	-	-	171	5TZ							
5PT-1806-WHE	-	-	-	-	-	-	171	5TZ-300A	-	-	-	-	-	-	208
5PT-5501P1	-	-	-	-	-	-	172	5TZ-300B	-	-	-	-	-	-	208
5PT-5501P2	-	-	-	-	-	-	172	61							
5PT-5501P3	-	-	-	-	-	-	172	61103	-	-	-	-	-	-	117
5PT-5501P4	-	-	-	-	-	-	172	608							
5SI								608-330	60	11.40	12.66	1.30	0.04	60	63
5SI-125T-B	-	-	-	-	-	-	111	608-369A	48	19.00	20.00	1.44	0.04	48	91
5SI-125T-D	-	-	-	-	-	-	111	608-369B	48	18.24	19.74	1.50	0.04	48	91
5SI-125T-SB	-	-	-	-	-	-	111	608-369C	48	18.24	19.73	1.50	0.04	48	91
5SI-129-30H	-	-	-	-	-	-	109	608-384N	20	9.00	10.00	0.77	0.02	20	83
5SI-129-40H	-	-	-	-	-	-	109	608-391A	30	14.00	15.00	1.16	0.03	30	120
5SI-129-60H	-	-	-	-	-	-	109	608-391B	30	13.00	14.00	1.16	0.03	30	120
5SI-131-2C	-	-	-	-	-	-	109	608-391E	20	12.50	13.50	0.74	0.02	20	120
5SI-131-3C	-	-	-	-	-	-	109	608-400	60	18.00	19.00	0.45	0.01	60	83
5SI-131-B	-	-	-	-	-	-	109	608-611B	200	10.80	13.63	2.75	0.08	200	186
5SI-131-HT	-	-	-	-	-	-	109	608-611B-6	200	9.00	12.00	2.75	0.08	200	186
5SI-131-K	-	-	-	-	-	-	109	608-611C	200	10.60	13.60	2.75	0.08	200	186
5SI-216N-0.8D	-	-	-	-	-	-	106	608-611C-6	200	9.00	12.02	2.75	0.08	200	186
5SI-216N-1.2D	-	-	-	-	-	-	106	6HP							
5SI-216N-1.6D	-	-	-	-	-	-	106	6HP-9060	100	9.00	10.80	1.73	0.05	100	33
5SI-216N-1C	-	-	-	-	-	-	106	6HP-9100	100	9.40	10.50	1.78	0.05	100	33

Model No	QTY/CTN	N.W.	G.W.	CUFT	M3	M.O.Q.	Page
6HP-9101R	100	10.00	11.00	1.78	0.05	100	33
6HP-9150	100	10.00	11.00	1.78	0.05	100	33
6HP-9250	100	10.00	11.00	1.78	0.05	100	33
6HP-9258	100	9.70	11.00	1.78	0.05	100	33
6PK							
6PK-214	30	15.60	17.00	1.30	0.04	30	82
6PK-223	150	15.00	16.50	1.60	0.05	150	90
6PK-230C	30	16.50	17.80	1.12	0.03	30	76
6PK-230PA	30	17.10	18.20	1.17	0.03	30	76
6PK-3010	10	12.50	13.65	2.02	0.06	10	277
6PK-3010	10	12.50	13.65	2.02	0.06	10	277
6PK-301E	30	17.10	18.20	1.14	0.03	30	76
6PK-301H	30	16.60	17.60	1.13	0.03	30	76
6PK-301N	30	16.50	17.59	1.13	0.03	30	76
6PK-301R	30	16.60	17.60	1.20	0.03	30	76
6PK-301S	30	17.10	18.11	1.13	0.03	30	76
6PK-301U	30	16.50	17.71	1.13	0.03	30	76
6PK-312B	160	13.80	14.80	2.75	0.08	160	94
6PK-312S	160	11.50	13.50	2.80	0.08	160	94
6PK-322	150	10.50	11.50	2.30	0.07	150	94
6PK-330K	10	15.40	16.30	2.01	0.06	10	277
6PK-332	200	12.00	14.10	2.80	0.08	200	94
6PK-501	100	6.00	8.20	1.84	0.05	100	92
6PK-501N	250	9.00	10.50	2.10	0.06	250	94
6PK-508	30	14.50	16.00	1.20	0.03	30	81
6PK-535	20	16.80	18.03	1.39	0.04	20	65
6S							
6S-2	60	12.00	12.79	1.46	0.04	60	121
7U							
7UG	10	1.03	3.00	1.00	0.03	10	229
7UR	10	1.15	13.02	1.11	0.03	10	229
7UY	10	0.50	6.02	0.86	0.02	10	229
808							
808-080	100	24.00	25.90	3.11	0.09	100	92
808-330A	50	16.00	17.50	1.58	0.04	50	63
808-376A	60	18.00	19.00	1.28	0.04	60	80
808-376B	60	15.00	16.39	1.30	0.04	60	80
808-376C	60	18.00	19.60	1.61	0.05	60	80
808-376H	45	13.00	14.50	1.55	0.04	45	78
808-376I	45	15.00	16.50	1.55	0.04	45	78
808-389	180	12.00	13.50	1.17	0.03	180	207
808-Q03-1	1	28.50	31.00	1.33	0.04	1	187
808-Q04-1	1	18.00	20.00	1.33	0.04	1	187
808-Q05	200	8.00	11.00	2.73	0.08	200	187
891							
89101A	360	5.40	6.79	0.60	0.02	360	130
89101B	360	5.40	6.79	0.60	0.02	360	130
89102A	240	9.60	11.30	0.60	0.02	240	130
89102B	240	9.60	11.08	0.60	0.02	240	130
89105A	360	6.50	7.50	0.64	0.02	360	130
89105B	360	6.50	7.50	0.64	0.02	360	130
89106A	240	6.30	7.30	0.63	0.02	240	130
89106B	240	5.00	6.00	0.63	0.02	240	130
89107A	240	16.80	18.46	0.85	0.02	240	130

Model No	QTY/CTN	N.W.	G.W.	CUFT	M3	M.O.Q.	Page
89107B	240	16.80	18.41	0.85	0.02	240	130
89110A	240	10.80	12.33	0.62	0.02	240	130
89110B	240	10.80	12.08	0.62	0.02	240	130
89112A	120	8.60	9.60	0.86	0.02	120	130
89112B	120	8.60	9.60	0.86	0.02	120	130
89113A	240	19.44	21.20	0.96	0.03	240	130
89113B	240	19.20	21.20	0.99	0.03	240	130
89114A	120	11.04	12.25	0.83	0.02	120	130
89114B	120	10.80	12.21	0.82	0.02	120	130
89115A	120	7.50	8.50	0.86	0.02	120	130
89115B	120	7.50	8.50	0.86	0.02	120	130
89116A	240	12.48	14.56	0.96	0.03	240	130
89116B	240	12.48	14.56	0.96	0.03	240	130
89117A	120	12.48	13.70	0.82	0.02	120	130
89117B	120	12.48	13.70	0.82	0.02	120	130
89118A	240	6.00	7.00	0.63	0.02	240	130
89118B	240	6.00	7.00	0.63	0.02	240	130
89119A	120	9.50	10.50	0.86	0.02	120	130
89119B	120	9.60	10.50	0.82	0.02	120	130
89120A	240	9.60	11.42	0.84	0.02	240	130
89120B	240	9.60	11.70	0.86	0.02	240	130
89121A	120	14.00	15.00	0.86	0.02	120	130
89121B	120	14.00	15.00	0.86	0.02	120	130
89122A	120	16.50	17.50	1.01	0.03	120	130
89122B	120	16.50	17.50	1.01	0.03	120	130
89123A	120	19.00	20.00	0.96	0.03	120	130
89123B	120	19.00	20.00	0.96	0.03	120	130
894							
89400-H1.5	300	5.70	7.66	0.92	0.03	300	129
89400-H2	300	6.00	8.17	0.92	0.03	300	129
89400-H2.5	300	6.60	8.63	0.92	0.03	300	129
89400-H3	240	10.08	12.51	1.40	0.04	240	129
89400-T05	300	7.80	9.15	0.75	0.02	300	129
89400-T05H	300	7.50	9.17	0.78	0.02	300	129
89400-T06	300	7.80	9.16	0.75	0.02	300	129
89400-T06H	300	7.80	9.16	0.75	0.02	300	129
89400-T07	300	7.80	9.16	0.75	0.02	300	129
89400-T07H	300	7.80	9.16	0.75	0.02	300	129
89400-T08	300	8.70	10.60	0.75	0.02	300	129
89400-T08H	300	8.70	10.06	0.75	0.02	300	129
89400-T09	300	8.40	10.06	0.75	0.02	300	129
89400-T09H	300	8.40	10.06	0.75	0.02	300	129
89400-T10	300	8.70	10.16	0.75	0.02	300	129
89400-T10H	300	8.70	10.16	0.75	0.02	300	129
89400-T10HL	300	10.00	11.00	0.92	0.03	300	129
89400-T10HLX	300	11.50	12.50	0.92	0.03	300	129
89400-T15	300	8.70	10.06	0.75	0.02	300	129
89400-T15H	300	8.70	10.06	0.75	0.02	300	129
89400-T15HL	300	10.20	11.20	1.00	0.03	300	129
89400-T20HL	300	10.10	11.10	0.96	0.03	300	129
89400-TRI	200	7.60	9.25	1.65	0.05	200	129
89401A	300	7.50	8.91	0.75	0.02	300	128
89401B	300	7.20	8.92	0.75	0.02	300	128
89402A	240	13.20	14.96	1.39	0.04	240	128

Model No	QTY/CTN	N.W.	G.W.	CUFT	M3	M.O.Q.	Page	Model No	QTY/CTN	N.W.	G.W.	CUFT	M3	M.O.Q.	Page
89402B	240	12.48	14.86	1.39	0.04	240	128	8PK-033PS	40	20.00	21.00	0.30	0.01	40	123
89405A	300	7.50	9.70	0.97	0.03	300	128	8PK-033Q	40	20.00	21.00	0.30	0.01	40	123
89405B	300	7.50	9.58	0.97	0.03	300	128	8PK-033QD	40	20.00	21.00	0.30	0.01	40	123
89407A	240	19.00	20.00	1.46	0.04	240	128	8PK-033R	40	20.00	21.00	0.30	0.01	40	123
89407A-L	200	20.00	22.60	1.39	0.04	200	128	8PK-033RD	40	20.00	21.00	0.30	0.01	40	123
89407B	240	16.80	18.45	1.39	0.04	240	128	8PK-033ST	30	20.80	21.80	0.41	0.01	30	121
89407B-L	200	21.60	22.60	1.41	0.04	200	128	8PK-101-2	150	12.00	13.00	1.76	0.05	150	113
89410A	240	13.20	15.75	1.39	0.04	240	128	8PK-101D	144	12.96	14.24	1.87	0.05	144	37
89410B	240	14.40	16.02	1.42	0.04	240	128	8PK-101K	144	12.96	13.50	1.87	0.05	144	40
89412A	144	11.52	13.60	1.41	0.04	144	128	8PK-101KL	144	17.50	18.50	1.87	0.05	144	40
89412B	144	11.52	13.60	1.41	0.04	144	128	8PK-101KM	144	13.68	16.37	1.87	0.05	144	40
89413A	200	22.40	25.10	1.83	0.05	200	128	8PK-102D	144	14.50	15.50	1.87	0.05	144	37
89413B	200	22.00	25.13	1.83	0.05	200	128	8PK-104D	144	12.24	14.91	1.87	0.05	144	37
89414A	120	14.88	16.85	1.27	0.04	120	128	8PK-105D	144	12.96	15.00	1.87	0.05	144	37
89414B	120	15.00	16.78	1.30	0.04	120	128	8PK-2003-P	5	7.33	9.00	2.88	0.08	5	242
89416A	240	15.60	18.14	1.84	0.05	240	128	8PK-204A	24	14.00	15.00	0.93	0.03	24	137
89416B	240	15.60	18.20	1.84	0.05	240	128	8PK-2061	96	8.64	10.10	1.23	0.03	96	146
89417A	120	16.20	18.27	1.54	0.04	120	128	8PK-2062	96	8.83	9.91	1.23	0.03	96	146
89417B	120	16.20	18.23	1.54	0.04	120	128	8PK-2063	96	8.64	9.51	1.23	0.03	96	146
8BM								8PK-2065	60	14.40	16.10	1.98	0.06	60	149
8BM-401A	15	7.20	8.20	3.26	0.09	15	187	8PK-2066	72	19.50	20.50	1.55	0.04	72	134
8BM-405A	15	9.00	10.00	3.40	0.10	15	187	8PK-208D	144	13.54	16.70	1.87	0.05	144	90
8BM-612A	15	13.50	14.50	3.26	0.09	15	187	8PK-220	200	19.00	21.30	2.42	0.07	200	228
8PK								8PK-227	6	8.50	9.00	0.48	0.01	6	137
8PK-021L	60	15.60	16.85	1.29	0.04	60	153	8PK-249	60	12.00	13.90	1.75	0.05	60	63
8PK-021N	96	13.44	14.00	1.26	0.04	96	153	8PK-25PD	144	11.52	14.20	1.87	0.05	144	37
8PK-021NA	96	13.60	14.60	1.28	0.04	96	153	8PK-25PD-C	144	11.52	13.93	1.87	0.05	144	37
8PK-021T	96	12.48	13.35	1.07	0.03	96	153	8PK-3001D	144	18.72	20.10	1.87	0.05	144	88
8PK-022	144	5.04	6.71	1.31	0.04	144	154	8PK-3002D	144	17.28	20.00	1.87	0.05	144	88
8PK-027	18	18.00	19.90	2.05	0.06	18	154	8PK-301C	30	17.20	18.20	1.20	0.03	30	76
8PK-028	48	18.24	20.00	1.60	0.05	48	155	8PK-301F1	30	16.50	17.50	1.20	0.03	30	76
8PK-031B	1000	10.40	11.40	1.58	0.04	1000	123	8PK-301F2	30	16.50	17.50	1.20	0.03	30	76
8PK-031B	1000	10.40	11.40	1.58	0.04	1000	123	8PK-301J	30	16.50	17.50	1.20	0.03	30	76
8PK-031C	1000	10.00	11.00	1.58	0.04	1000	123	8PK-30D	144	15.50	16.50	1.87	0.05	144	37
8PK-033	100	21.00	21.60	1.41	0.04	100	89	8PK-313A	72	19.50	21.50	1.59	0.04	72	89
8PK-033D	120	12.00	14.00	0.65	0.02	120	123	8PK-313B	72	19.20	20.20	1.59	0.05	72	89
8PK-033DD	120	13.00	14.00	0.65	0.02	120	123	8PK-3141A	72	5.80	7.20	1.78	0.05	72	99
8PK-033DDS	120	12.00	13.83	0.64	0.02	120	123	8PK-3141B	36	4.80	6.00	1.62	0.05	36	99
8PK-033DS	120	13.00	14.00	0.65	0.02	120	123	8PK-315DR	36	17.10	18.57	1.56	0.04	36	98
8PK-033E	120	12.00	13.71	0.64	0.02	120	123	8PK-3161	100	15.00	16.50	1.20	0.03	100	88
8PK-033ED	120	13.00	14.00	0.65	0.02	120	123	8PK-3162	100	15.00	16.80	1.18	0.03	100	88
8PK-033F	120	12.00	13.95	0.64	0.02	120	123	8PK-3163	100	15.00	16.60	1.18	0.03	100	88
8PK-033FD	120	13.00	14.00	0.65	0.02	120	123	8PK-3220	48	13.44	15.00	2.22	0.06	48	223
8PK-033J	80	20.00	21.00	0.40	0.01	80	123	8PK-324B	100	12.90	15.00	1.70	0.05	100	99
8PK-033JD	80	20.00	21.00	0.40	0.01	80	123	8PK-325	60	9.00	11.06	2.27	0.06	60	95
8PK-033JDS	80	20.00	21.00	0.40	0.01	80	123	8PK-325B	60	11.40	13.15	2.27	0.06	60	95
8PK-033JS	80	20.00	21.00	0.40	0.01	80	123	8PK-326	100	13.50	14.50	1.45	0.04	100	180
8PK-033K	80	20.80	21.00	0.40	0.01	80	123	8PK-362	50	17.40	18.40	2.05	0.06	50	121
8PK-033KD	80	20.00	21.00	0.40	0.01	80	123	8PK-362A	24	21.00	23.00	0.84	0.02	24	121
8PK-033L	80	20.00	21.00	0.40	0.01	80	123	8PK-362S	200	9.00	10.00	1.11	0.03	200	121
8PK-033LD	80	20.00	21.00	0.40	0.01	80	123	8PK-366D	100	5.50	6.34	0.88	0.02	100	119
8PK-033P	40	20.00	21.00	0.30	0.01	40	123	8PK-366NA	100	8.00	9.25	1.40	0.04	100	119
8PK-033PD	40	20.00	21.00	0.30	0.01	40	123	8PK-366N-B	100	8.00	9.20	1.42	0.04	100	119
8PK-033PDS	40	20.00	21.00	0.30	0.01	40	123	8PK-366N-G	100	8.00	9.25	1.40	0.04	100	119

Model No	QTY/CTN	N.W.	G.W.	CUFT	M3	M.O.Q.	Page
8PK-366N-O	100	8.00	9.25	1.40	0.04	100	119
8PK-366N-S	100	8.00	9.20	1.42	0.04	100	119
8PK-366N-Y	100	8.00	9.25	1.40	0.04	100	119
8PK-371	60	18.18	19.54	1.59	0.05	60	92
8PK-371D	60	22.70	23.70	1.96	0.06	60	92
8PK-376FN	60	15.00	16.60	2.08	0.06	60	80
8PK-378A	72	14.40	16.20	1.50	0.04	72	62
8PK-378B	72	15.48	16.97	1.35	0.04	72	62
8PK-378C	36	13.50	14.50	1.00	0.03	36	62
8PK-394A	200	10.00	10.50	1.75	0.05	200	71
8PK-394B	200	12.00	13.91	1.82	0.05	200	71
8PK-401S	1	3.50	4.00	0.86	0.02	1	127
8PK-403S	1	4.00	4.50	0.86	0.02	1	127
8PK-502	100	17.00	19.10	3.04	0.09	100	95
8PK-509	100	12.00	13.53	1.56	0.04	100	146
8PK-5141N	50	11.50	12.50	2.17	0.06	50	146
8PK-605A	240	12.96	13.80	0.79	0.02	240	226
8PK-605L	200	27.20	28.60	0.95	0.03	200	226
8PK-610	200	7.50	8.50	1.91	0.05	200	222
8PK-611	200	10.60	13.50	2.75	0.08	200	186
8PK-611D	200	13.00	14.00	2.85	0.08	200	186
8PK-611D-6	200	8.00	12.37	2.88	0.08	200	186
8PK-611W	200	9.50	10.50	2.46	0.07	200	186
8PK-735N	2	8.18	9.00	2.73	0.08	2	239
8PK-750N	4	13.22	14.00	4.55	0.13	4	241
8PK-8100E	36	14.76	15.60	1.91	0.05	36	193
8PK-905	120	13.00	14.00	1.91	0.05	120	54
8PK-906	120	10.20	13.19	1.91	0.05	120	54
8PK-A201A	30	16.50	17.50	0.95	0.03	30	64
8PK-A202	60	10.60	12.60	1.04	0.03	60	64
8PK-A203	60	21.50	22.50	1.45	0.04	60	64
8PK-AS07-1	50	20.30	21.15	2.38	0.07	50	187
8PK-BL002	120	8.40	10.99	1.85	0.05	120	70
8PK-C002	200	17.50	18.50	3.52	0.10	200	181
8PK-CT001	500	12.50	13.50	2.26	0.06	500	95
8PK-CT004	1000	4.30	6.30	1.90	0.05	1000	83
8PK-CT005	60	14.80	15.80	1.45	0.04	60	82
8PK-CT006	60	18.60	20.20	1.70	0.05	60	63
8PK-CT009	100	24.10	25.10	2.15	0.06	100	90
8PK-CT009A	100	24.40	25.40	2.15	0.06	100	90
8PK-CT015	24	11.00	12.00	0.79	0.02	24	85
8PK-CT016	24	19.44	20.65	1.22	0.03	24	85
8PK-CT120	5	15.30	16.03	0.58	0.02	5	85
8PK-CT150	5	20.50	22.00	0.95	0.03	5	85
8PK-H081	120	12.00	13.04	1.21	0.03	120	225
8PK-MA003N	24	6.50	7.50	3.24	0.09	24	214
8PK-MA005	384	11.52	15.00	3.66	0.10	384	214
8PK-MA006	150	21.00	22.00	5.03	0.14	150	215
8PK-MA008	504	21.17	25.00	5.39	0.15	504	214
8PK-MA009	60	10.80	13.00	1.78	0.05	60	180
8PK-S118A	40	5.20	6.20	1.10	0.03	40	111
8PK-S118A-40	40	5.20	6.20	1.10	0.03	40	111
8PK-S118B	40	5.20	6.20	1.10	0.03	40	111
8PK-S118B-40	40	5.20	6.20	1.10	0.03	40	111

Model No	QTY/CTN	N.W.	G.W.	CUFT	M3	M.O.Q.	Page
8PK-S120NAD-30	40	8.80	10.20	1.85	0.05	40	110
8PK-S120NAD-40	40	8.80	10.20	1.85	0.05	40	110
8PK-S120NAD-60	40	11.20	13.20	2.11	0.06	40	110
8PK-S120NB-30	40	9.60	11.00	1.90	0.05	40	110
8PK-S120NB-40	40	9.60	11.00	1.90	0.05	40	110
8PK-S120NB-60	40	11.00	12.50	2.11	0.06	40	110
8PK-S120NBD-30	40	10.00	11.20	1.90	0.05	40	110
8PK-S120NBD-40	40	10.00	11.20	1.90	0.05	40	110
8PK-S120NBD-60	40	12.00	13.20	2.11	0.06	40	110
8PK-SC116NB	40	9.80	11.00	1.90	0.05	40	112
8PK-SD002N	24	10.20	11.40	1.57	0.04	24	146
8PK-SD009	72	18.36	19.42	1.55	0.04	72	135
8PK-SD009E	72	18.36	19.80	1.51	0.04	72	135
8PK-SD010	48	11.20	12.20	1.41	0.04	48	133
8PK-SD016	16	14.08	14.50	0.61	0.02	16	161
8PK-SR007	60	11.00	12.00	1.60	0.05	60	70
8PK-SR250	10	19.60	20.60	2.26	0.06	10	67
8PK-SR500	5	15.10	16.10	1.66	0.05	5	67
8S							
8S005	120	7.00	8.00	0.60	0.02	120	123
8SL-2000N	42	9.50	10.50	1.58	0.04	42	114
90							
903-132	120	19.20	20.20	4.65	0.13	120	234
903-133S	288	7.14	7.76	1.23	0.03	288	235
908-366A	100	8.50	9.60	0.88	0.02	100	119
908-607	1000	8.50	9.50	0.96	0.03	1000	147
908-607S	1000	6.00	13.00	1.40	0.04	1000	147
908-609	1000	10.00	16.73	1.90	0.05	1000	222
908-609A	1200	16.00	17.00	1.50	0.04	1200	222
908-611-6	200	10.70	11.70	2.83	0.08	200	186
908-T301	180	10.80	13.14	1.97	0.06	180	207
91							
9122-010	500	0.60	0.70	0.50	0.01	500	222
95							
9500-012A	50	20.20	21.20	0.91	0.03	50	173
9500-012C	50	25.00	26.00	1.20	0.03	50	173
9500-013B	120	10.20	11.20	1.31	0.04	120	173
9H							
9H084	-	-	-	-	-	-	122
9H085	-	-	-	-	-	-	122
9H086	-	-	-	-	-	-	122
9K							
9K002A	-	-	-	-	-	-	226
9K002B	-	-	-	-	-	-	226
9MS-551-B	-	-	-	-	-	-	218
9P							
9PK-710P	6	10.47	11.60	3.05	0.09	6	242
9PK-730N	2	7.00	8.00	2.35	0.07	2	239
9PK-990	2	7.00	9.00	2.60	0.07	2	241
9PT-5201A-P	-	-	-	-	-	-	173
9PT-5201B-P	-	-	-	-	-	-	173
9PT-5201-P2	-	-	-	-	-	-	173
9S							
9S001	500	13.00	14.10	0.76	0.02	500	123

Model No	QTY/CTN	N.W.	G.W.	CUFT	M3	M.O.Q.	Page	Model No	QTY/CTN	N.W.	G.W.	CUFT	M3	M.O.Q.	Page
9S002	500	12.50	13.10	0.78	0.02	500	123	9SS-900-H	-	-	-	-	-	-	101
9SC116N-2D	-	-	-	-	-	-	111	9SS-900-I	-	-	-	-	-	-	101
9SC116N-3C	-	-	-	-	-	-	111	9SS-900-J	-	-	-	-	-	-	101
9SC116N-B	-	-	-	-	-	-	111	9SS-900-K	-	-	-	-	-	-	101
9SC116N-SB	-	-	-	-	-	-	111	9SS-900-L	-	-	-	-	-	-	101
9SD-200-T05H	144	3.82	4.80	0.54	0.02	144	126	9SS-900-M	-	-	-	-	-	-	101
9SD-200-T06H	144	3.82	4.80	0.54	0.02	144	126	9SS-900-N	-	-	-	-	-	-	101
9SD-200-T07H	144	3.82	4.80	0.54	0.02	144	126	9SS-900NB-HG	-	-	-	-	-	-	101
9SD-200-T08H	144	3.82	4.80	0.54	0.02	144	126	9SS-900NE-HG	-	-	-	-	-	-	101
9SD-200-T09H	144	3.82	4.80	0.54	0.02	144	126	9SS-900N-HT	-	-	-	-	-	-	101
9SD-200-T10H	144	4.03	4.87	0.54	0.02	144	126	9SS-900N-SI	-	-	-	-	-	-	101
9SD-200-T15H	144	4.67	5.70	0.54	0.02	144	126	9SS-900-O	-	-	-	-	-	-	101
9SD-201A	144	3.82	4.87	0.54	0.02	144	126	9SS-969-A1	-	-	-	-	-	-	103
9SD-201B	144	3.82	4.87	0.54	0.02	144	126	9SS-969-A2	-	-	-	-	-	-	103
9SD-202A	144	9.07	10.40	1.26	0.04	144	126	9SS-969-A3	-	-	-	-	-	-	103
9SD-202B	144	9.04	10.50	1.26	0.04	144	126	9ST-23	30	15.06	16.00	2.75	0.08	30	245
9SD-205A	144	3.96	5.00	0.54	0.02	144	126	9ST-33	40	11.52	12.50	1.64	0.05	40	245
9SD-205B	144	3.96	5.00	0.54	0.02	144	126	9ST-43	-	-	-	-	-	-	245
9SD-207A	144	13.82	15.60	1.45	0.04	144	126	9TZ							
9SD-207B	144	13.82	15.60	1.45	0.04	144	126	9TZ-121-BIT	-	-	-	-	-	-	208
9SD-210A	144	9.50	11.00	1.26	0.04	144	126	AS							
9SD-210B	144	9.50	11.00	1.26	0.04	144	126	AS-501A	144	5.62	8.20	2.69	0.08	144	186
9SD-213A	144	15.12	17.00	1.45	0.04	144	126	AS-501B	144	6.34	8.90	2.69	0.08	144	186
9SD-213B	144	15.12	17.00	1.45	0.04	144	126	AS-501C	96	13.00	14.30	2.69	0.08	96	186
9SD-214A	96	11.52	13.10	1.19	0.03	96	126	AS-501D	72	7.40	8.40	3.01	0.09	72	186
9SD-214B	96	11.52	13.10	1.19	0.03	96	126	AS-501E	240	8.00	9.00	2.69	0.08	240	186
9SD-216B	144	10.73	12.10	1.45	0.04	144	126	AS-611	200	12.00	13.50	2.15	0.06	200	186
9SD-217B	96	12.58	14.20	1.39	0.04	96	126	AS-611-6	200	10.50	12.00	2.15	0.06	200	186
9SD-220A	288	13.82	15.30	1.26	0.04	288	126	AS-611F	200	6.00	8.70	1.92	0.05	200	186
9SD-220B	288	13.82	15.30	1.26	0.04	288	126	BX							
9SD-222A	144	20.88	22.00	1.45	0.04	144	126	BX-4112N	72	10.08	12.50	1.29	0.04	72	221
9SD-222B	144	20.88	22.40	1.45	0.04	144	126	BX-4123	40	14.40	16.50	1.91	0.05	40	221
9SI-B161-T	-	-	-	-	-	-	112	BX-4135	30	15.30	18.00	1.92	0.05	30	221
9SI-B162-T	-	-	-	-	-	-	112	CP							
9SI-B162-W	-	-	-	-	-	-	112	CP-080E	60	12.60	14.00	1.78	0.05	60	92
9SN-310G	500	8.50	12.00	0.47	0.01	500	123	CP-108	120	13.00	14.70	1.57	0.04	120	90
9SR-015-B	-	-	-	-	-	-	63	CP-147	96	13.30	14.30	1.78	0.05	96	84
9SS-202-R0.3	-	-	-	-	-	-	107	CP-148	96	16.50	17.50	1.78	0.05	96	82
9SS-202-SI	-	-	-	-	-	-	107	CP-151B	50	14.20	15.10	1.31	0.04	50	84
9SS-257-HT	-	-	-	-	-	-	105	CP-200	30	18.00	19.00	1.38	0.04	30	77
9SS-257-SI	-	-	-	-	-	-	105	CP-200R	30	18.00	19.10	1.34	0.04	30	77
9SS-602-A1	-	-	-	-	-	-	104	CP-236DE	200	17.00	18.00	1.32	0.04	200	75
9SS-602-A2	-	-	-	-	-	-	104	CP-236DE1	200	17.00	18.00	1.32	0.04	200	75
9SS-602-A3	-	-	-	-	-	-	104	CP-236DF	200	17.00	18.00	1.32	0.04	200	75
9SS-602B-H	-	-	-	-	-	-	104	CP-236DF1	200	15.50	17.00	1.32	0.04	200	75
9SS-602E-H	-	-	-	-	-	-	104	CP-236DM5	200	17.00	18.00	1.32	0.04	200	74
9SS-900-A1	-	-	-	-	-	-	101	CP-236DN	200	13.00	14.00	1.32	0.04	200	75
9SS-900-A2	-	-	-	-	-	-	101	CP-236DR	200	13.50	14.50	1.32	0.04	200	75
9SS-900-A3	-	-	-	-	-	-	101	CP-236DU	200	14.00	15.00	1.32	0.04	200	75
9SS-900-B	-	-	-	-	-	-	101	CP-246	48	19.50	20.50	1.98	0.06	48	91/201
9SS-900-C	-	-	-	-	-	-	101	CP-251B	20	8.80	9.60	0.78	0.02	20	84
9SS-900-D	-	-	-	-	-	-	101	CP-3001D	144	19.44	20.90	1.94	0.05	144	36/88
9SS-900-E	-	-	-	-	-	-	101	CP-3002D	144	21.00	22.00	1.94	0.05	144	36/88
9SS-900-F	-	-	-	-	-	-	101	CP-3003D45	300	24.00	25.00	0.50	0.01	300	75

Model No	QTY/CTN	N.W.	G.W.	CUFT	M3	M.O.Q.	Page
CP-3003D46	300	21.00	22.00	0.50	0.01	300	75
CP-3003D47	300	21.00	22.00	0.50	0.01	300	75
CP-3005F	20	11.00	12.00	0.81	0.02	20	75
CP-3006FD18	20	12.30	13.10	1.03	0.03	20	75
CP-3006FD2	20	12.30	13.10	1.03	0.03	20	75
CP-3006FD36	20	12.30	13.10	1.03	0.03	20	75
CP-3006FD45	20	12.30	13.10	1.03	0.03	20	76
CP-3006FD46	20	12.30	13.10	1.03	0.03	20	76
CP-3006FD47	20	12.30	13.10	1.03	0.03	20	76
CP-3006FS1	20	12.30	13.10	1.03	0.03	20	76/201
CP-3006FS2	20	12.30	13.10	1.03	0.03	20	76/201
CP-301F4	30	15.60	18.50	1.10	0.03	30	76
CP-301G	120	17.40	18.80	1.70	0.05	120	88
CP-302G	120	17.40	18.80	1.70	0.05	120	88
CP-311	72	12.50	13.50	1.60	0.05	72	63
CP-313	60	18.30	20.22	1.83	0.05	60	81
CP-3140	72	11.88	14.50	2.69	0.08	72	98
CP-3141	72	5.33	7.50	1.78	0.05	72	99
CP-3145A	100	6.00	7.29	1.92	0.05	100	99
CP-3145B	100	6.00	7.00	1.84	0.05	100	99
CP-3148	50	11.50	13.00	1.61	0.05	50	97
CP-315	100	23.00	24.50	2.21	0.06	100	81
CP-3150	50	12.00	13.00	1.75	0.05	50	97
CP-3151	50	10.00	11.00	1.28	0.04	50	98
CP-3152	60	10.00	11.00	1.28	0.04	60	98
CP-316	60	13.00	14.00	1.34	0.04	60	81
CP-318	40	9.50	10.50	1.49	0.04	40	89
CP-319	40	9.50	10.50	1.14	0.03	40	89
CP-326	60	4.50	6.00	1.20	0.03	60	95
CP-333	60	21.50	22.50	2.00	0.06	60	79
CP-336DA4	200	15.00	16.00	1.32	0.04	200	74
CP-336DC	200	16.00	17.00	1.32	0.04	200	74
CP-336DC1	200	13.50	14.50	1.32	0.04	200	74
CP-336DF1	200	13.00	14.00	1.32	0.04	200	75
CP-336DF2	200	13.00	14.00	1.32	0.04	200	75
CP-336DF4	200	11.40	15.50	1.32	0.04	200	75
CP-336DG	200	16.00	17.00	1.32	0.04	200	75
CP-336DI	200	15.50	17.00	1.32	0.04	200	74
CP-336DJ	200	15.50	17.00	1.32	0.04	200	75
CP-336DK4	200	15.50	16.50	1.32	0.04	200	75
CP-336DP1	200	16.00	17.00	1.32	0.04	200	74
CP-336DV	200	14.50	15.50	1.32	0.04	200	75
CP-336DY1	200	15.50	17.00	1.32	0.04	200	74
CP-336F	30	15.00	16.00	1.09	0.03	30	74
CP-351B	20	17.50	18.90	1.31	0.04	20	84
CP-353	20	15.10	16.60	1.32	0.04	20	84
CP-367A	60	11.00	12.00	2.50	0.07	60	90
CP-369AE	48	17.00	18.70	1.78	0.05	48	91
CP-369BE	48	17.00	18.70	1.78	0.05	48	91
CP-369CE	48	17.00	18.70	1.78	0.05	48	91
CP-371	30	16.50	18.30	1.70	0.05	30	74
CP-373	45	10.50	12.00	1.55	0.04	45	79
CP-376	30	17.00	18.00	1.36	0.04	30	77
CP-376D	20	7.20	7.80	0.79	0.02	20	79

Model No	QTY/CTN	N.W.	G.W.	CUFT	M3	M.O.Q.	Page
CP-376E	60	22.50	24.50	2.22	0.06	60	80
CP-376ER	20	12.00	13.00	0.86	0.02	20	79
CP-376K	30	18.00	19.00	1.34	0.04	30	77
CP-376KX	40	22.00	24.00	1.85	0.05	40	80
CP-376L	20	9.20	10.20	0.58	0.02	20	80
CP-376M	20	10.50	11.50	0.86	0.02	20	79
CP-376TR	45	16.00	17.50	1.55	0.04	45	78
CP-376UR	40	15.00	16.50	1.45	0.04	40	78
CP-376VR	40	16.80	17.98	1.37	0.04	40	78
CP-380	40	14.70	15.70	1.50	0.04	40	91
CP-382	45	17.00	18.50	2.13	0.06	45	229
CP-385	40	14.60	16.35	1.87	0.05	40	229
CP-393	50	12.50	13.75	1.78	0.05	50	79
CP-412G	72	14.04	17.50	1.40	0.04	72	89
CP-413G	72	15.84	17.50	1.40	0.04	72	89
CP-415	100	17.00	18.50	2.04	0.06	100	90
CP-418	36	10.00	11.00	1.08	0.03	36	82
CP-462G	40	17.00	19.00	1.59	0.05	40	83
CP-463	60	18.00	19.40	1.86	0.05	60	83
CP-501BN	60	4.08	5.10	1.85	0.05	60	92
CP-505	60	6.00	7.70	1.63	0.05	60	93
CP-507	160	9.00	10.00	3.28	0.09	160	93
CP-508	60	7.00	8.00	2.02	0.06	60	93
CP-509	120	9.00	10.00	2.10	0.06	120	93
CP-511A	90	6.30	7.10	1.18	0.03	90	95
CP-512	200	12.50	13.50	2.89	0.08	200	94
CP-521	120	8.00	9.00	2.10	0.06	120	93
CP-522	60	4.80	6.58	1.88	0.05	60	93
CP-5S1D	200	13.50	14.50	1.32	0.04	200	75/201
CP-5S2D	200	13.50	14.50	1.32	0.04	200	75/201
CP-806	20	10.80	11.60	0.78	0.02	20	81
CP-808	30	14.40	15.60	1.32	0.04	30	81
CP-FB01	72	13.70	14.70	1.80	0.05	72	180
DK							
DK-2026N	300	8.00	9.00	1.78	0.05	300	180
DK-2032	12	12.00	13.00	1.05	0.03	12	220
DK-2033N	12	22.62	24.82	2.96	0.08	12	220
DK-2034N	6	18.50	19.50	1.41	0.04	6	220
DK-2039	144	19.44	23.00	3.01	0.09	144	70
DK-2039-B	240	11.00	12.00	0.34	0.01	240	70
DK-2040	120	21.00	23.00	2.10	0.06	120	220
DK-2041	72	19.08	20.00	1.50	0.04	72	220
DK-2042	48	22.00	24.00	1.38	0.04	48	220
DK-2043	72	7.00	8.00	1.38	0.04	72	180
DK-2047N	120	14.00	16.00	1.78	0.05	120	70
DK-2060SET	10	17.00	18.00	1.17	0.03	10	220
DK-2112	48	14.16	15.00	1.19	0.03	48	70
DP							
DP-032B	144	14.00	15.50	1.80	0.05	144	123
DP-033A	300	8.00	9.00	1.38	0.04	300	123
DP-033B	300	8.00	9.00	1.38	0.04	300	123
DP-033C	300	8.00	9.00	1.38	0.04	300	123
DP-033D	300	8.00	9.00	1.38	0.04	300	123
DP-033E	300	8.00	9.00	1.38	0.04	300	123

Model No	QTY/CTN	N.W.	G.W.	CUFT	M3	M.O.Q.	Page	Model No	QTY/CTN	N.W.	G.W.	CUFT	M3	M.O.Q.	Page
DP-3616	144	11.52	14.00	1.53	0.04	144	122	HW-V106B	144	2.50	3.50	0.93	0.03	144	195
DP-366C	100	6.00	7.10	0.91	0.03	100	119	HW-V107B	144	3.00	4.00	0.93	0.03	144	195
DP-366D	60	5.40	6.50	1.39	0.04	60	119	HW-V108B	144	3.60	4.60	0.93	0.03	144	195
DP-366J	100	8.00	9.50	1.43	0.04	100	119	HW-V109B	144	4.50	5.50	0.93	0.03	144	195
DP-366P	100	11.50	14.00	2.25	0.06	100	119	HW-V110B	144	5.00	6.00	0.93	0.03	144	195
FB								HW-V111B	144	6.00	7.00	0.93	0.03	144	195
FB-1688	16	5.76	6.15	0.46	0.01	16	180	HW-V112B	132	7.00	8.00	1.31	0.04	132	195
FB-C010	24	4.00	5.00	0.87	0.02	24	181	HW-V113B	132	8.50	9.50	1.31	0.04	132	195
FL								HW-V114B	132	10.50	11.50	1.31	0.04	132	195
FL-506	144	11.38	13.50	1.78	0.05	144	224	HW-V115B	132	11.50	12.50	1.31	0.04	132	195
FL-516	144	9.00	10.00	1.78	0.05	144	224	HW-V116B	48	4.80	5.80	0.87	0.02	48	195
FL-528	100	10.00	12.00	5.65	0.16	100	224	HW-V117B	48	6.10	6.50	0.87	0.02	48	195
FL-603	100	10.00	11.00	2.48	0.07	100	224	HW-V118B	48	7.30	7.30	0.87	0.02	48	195
GK								HW-V119B	48	7.78	8.30	0.87	0.02	48	195
GK-361U	48	10.00	11.00	2.55	0.07	48	117	HW-V121B	42	7.30	8.30	0.87	0.02	42	195
GK-368	20	8.50	9.50	1.79	0.05	20	117	HW-V122B	42	8.00	9.00	0.87	0.02	42	195
GK-380A	20	6.44	8.50	2.15	0.06	20	117	HW-V124B	36	9.00	10.00	1.31	0.04	36	195
GK-380B	20	6.44	8.50	2.15	0.06	20	117	HW-V127B	36	11.70	12.70	1.31	0.04	36	195
GK-389B	20	9.80	11.80	2.60	0.07	20	117	HW-V130B	30	13.20	14.20	1.31	0.04	30	195
GK-390B	20	9.80	11.80	2.60	0.07	20	117	HW-V132B	36	18.43	19.63	1.31	0.04	36	195
GS-200K	24	12.50	13.50	2.66	0.08	24	114	HW-V206B	45	2.00	3.00	0.87	0.02	45	195
GS-210	48	5.00	5.50	1.10	0.03	48	113	HW-V207B	45	2.00	3.00	0.87	0.02	45	195
GS-23K	20	11.50	12.50	1.74	0.05	20	114	HW-V208B	45	3.00	4.00	0.87	0.02	45	195
HW								HW-V209B	45	3.30	4.30	0.87	0.02	45	195
HW-008N	48	11.14	13.20	0.87	0.02	48	160	HW-V210B	24	2.30	3.30	0.87	0.02	24	195
HW-010	36	16.74	17.00	1.08	0.03	36	160	HW-V211B	24	2.16	23.10	0.87	0.02	24	195
HW-012	24	17.21	18.00	1.31	0.04	24	160	HW-V212B	24	3.30	4.30	0.87	0.02	24	195
HW-0221	72	18.80	20.20	1.91	0.05	72	154	HW-V213B	24	3.00	4.00	0.87	0.02	24	195
HW-023	144	16.56	18.50	1.66	0.05	144	154	HW-V214B	12	2.00	3.00	0.93	0.03	12	195
HW-024	48	17.76	18.60	1.19	0.03	48	155	HW-V215B	12	2.00	3.00	0.93	0.03	12	195
HW-121L	72	10.80	12.50	1.21	0.03	72	153	HW-V216B	12	2.50	3.50	0.93	0.03	12	195
HW-121M	72	11.88	13.47	1.21	0.03	72	153	HW-V217B	12	2.50	3.50	0.93	0.03	12	195
HW-129	60	23.00	25.00	1.89	0.05	60	155	HW-V218B	12	2.80	3.80	0.93	0.03	12	195
HW-221L	48	9.00	10.00	0.75	0.02	48	153	HW-V219B	12	3.00	4.00	0.93	0.03	12	195
HW-221M	80	11.00	12.00	0.53	0.01	80	153	HW-V221B	12	3.80	4.80	0.93	0.03	12	195
HW-229B	24	9.50	10.50	0.85	0.02	24	155	HW-V222B	12	3.80	4.80	0.93	0.03	12	195
HW-229BL	24	11.00	12.00	0.97	0.03	24	155	HW-V224B	18	7.00	8.00	1.31	0.04	18	195
HW-312B	40	12.12	12.63	1.17	0.03	40	161	HW-V227B	18	7.80	8.80	1.31	0.04	18	195
HW-312S	160	18.44	19.44	2.56	0.07	160	161	HW-V230B	12	6.30	7.30	1.31	0.04	12	195
HW-322M	100	12.40	13.40	0.89	0.03	100	154	HW-V232B	12	6.50	7.50	1.31	0.04	12	195
HW-5907M	20	22.60	24.00	1.54	0.04	20	161	HW-V608	24	8.70	9.70	0.93	0.03	24	194
HW-5912E	50	20.00	21.50	1.52	0.04	50	161	HW-V610	18	11.00	12.00	1.31	0.04	18	194
HW-609A	100	12.50	13.50	0.56	0.02	100	160	HW-V612	18	16.00	17.50	1.31	0.04	18	194
HW-609B	100	12.50	13.50	0.56	0.02	100	160	HW-V708	12	4.50	5.50	1.31	0.04	12	196
HW-6509B	25	25.00	26.00	1.70	0.05	25	159	HW-V710	12	9.00	10.00	1.31	0.04	12	196
HW-6514B	12	26.00	27.00	1.43	0.04	12	159	HW-V803	96	5.00	6.00	0.87	0.02	96	194
HW-7509B	12	21.00	22.00	0.85	0.02	12	159	HW-V804	96	6.00	7.30	0.87	0.02	96	194
HW-7513B	6	20.00	21.00	0.74	0.02	6	159	HW-V805	96	8.00	9.00	0.87	0.02	96	194
HW-T21-40200	12	24.50	26.30	1.82	0.05	12	157	HW-V806	96	10.00	11.00	0.87	0.02	96	194
HW-T21-60340	12	27.60	28.70	1.82	0.05	12	157	HW-V808	30	6.50	7.50	1.31	0.04	30	194
HW-T41-315	24	9.60	10.50	0.94	0.03	24	157	HW-V810	36	9.60	10.60	1.31	0.04	36	194
HW-T41-525	24	8.52	10.32	0.94	0.03	24	157	HW-V812	36	14.00	15.00	1.31	0.04	36	194
HW-T716-3	90	13.50	17.00	1.78	0.05	90	157	MA							
HW-T83-20100	12	16.32	16.44	1.37	0.04	12	157	MA-013	240	13.20	17.00	4.44	0.13	240	215

Model No	QTY/CTN	N.W.	G.W.	CUFT	M3	M.O.Q.	Page
MA-014	120	14.40	17.00	3.42	0.10	120	214
MA-015	20	11.40	13.60	3.98	0.11	20	214
MA-016	48	12.72	16.00	7.00	0.20	48	214
MA-019	80	11.60	15.20	4.01	0.11	80	215
MA-020	120	10.20	13.00	3.20	0.09	120	215
MA-021	120	10.00	12.00	3.91	0.11	120	215
MA-022	480	12.00	13.00	3.48	0.10	480	215
MA-023	144	17.00	19.00	6.49	0.18	144	215
MA-1003MA	8	15.00	17.00	4.64	0.13	8	213
MA-1003MF	8	15.40	17.00	4.64	0.13	8	213
MA-1004A	4	9.20	11.00	2.50	0.07	4	213
MA-1004F	4	10.00	11.00	2.50	0.07	4	213
MA-1006A	4	10.50	11.50	1.63	0.05	4	214
MA-1006F	4	10.50	11.40	1.63	0.05	4	214
MA-1008A	1	9.30	10.00	1.11	0.03	1	211
MA-1013MA	8	14.40	15.40	3.98	0.11	8	213
MA-1013MF	8	14.10	15.10	3.98	0.11	8	213
MA-1205CA	4	15.00	16.00	5.15	0.15	4	212
MA-1205CB	4	15.00	16.00	5.15	0.15	4	212
MA-1209LA	4	13.00	14.00	2.60	0.07	4	211
MA-1209LI	4	13.00	14.00	2.60	0.07	4	211
MA-1215CA	6	11.00	14.00	3.12	0.09	6	212
MA-1215CF	6	13.00	14.00	3.12	0.09	6	212
MA-1219A	2	7.80	10.00	2.02	0.06	2	211
MA-1219F	2	7.80	10.00	2.02	0.06	2	211
MA-1225CA	4	11.00	12.80	2.62	0.07	4	212
MA-1225CF	4	11.00	12.00	2.62	0.07	4	212
MA-1503A	2	10.12	11.00	3.69	0.10	2	212
MA-1503I	2	10.12	11.00	3.69	0.10	2	212
MA-1601A	4	13.00	14.00	3.86	0.11	4	213
MA-1601F	4	13.00	14.00	3.86	0.11	4	213
MS							
MS-004	120	7.50	8.50	1.80	0.05	120	228
MS-006	96	7.00	8.00	2.15	0.06	96	228
MS-008	96	12.00	13.00	2.15	0.06	96	228
MS-018	200	9.50	10.50	4.17	0.12	200	228
MS-035	100	3.00	4.00	1.33	0.04	100	228
MS-121	240	7.00	8.00	1.77	0.05	240	222
MS-153A	120	6.00	8.20	3.01	0.09	120	219
MS-153C	60	5.00	7.20	3.01	0.09	60	219
MS-161	120	10.00	11.50	3.01	0.09	120	228
MS-3176	144	8.64	11.00	2.70	0.08	144	149
MS-3207	100	8.00	9.78	1.91	0.05	100	82
MS-322	100	6.50	7.70	1.23	0.03	100	223
MS-323	300	13.00	15.00	1.78	0.05	300	223
MS-325	96	9.70	11.50	1.88	0.05	96	218
MS-327	100	12.00	13.00	2.50	0.07	100	223
MS-329	100	9.00	10.89	2.44	0.07	100	223
MS-330	-	-	-	-	-	-	226
MS-391	240	12.00	14.00	1.78	0.05	240	222
MS-525	40	12.40	13.50	0.77	0.02	40	218
MS-526	40	14.40	15.50	0.77	0.02	40	218
MS-533	180	13.00	14.00	2.74	0.08	180	225
MS-551B	10	12.00	13.00	2.36	0.07	10	218

Model No	QTY/CTN	N.W.	G.W.	CUFT	M3	M.O.Q.	Page
MS-551H	10	12.00	13.00	2.36	0.07	10	218
MS-5156	-	-	-	-	-	-	228
MS-602	-	-	-	-	-	-	226
MS-710	180	10.00	11.00	3.85	0.11	180	228
MS-9328	-	-	-	-	-	-	226
MS-C001	100	12.40	14.70	4.49	0.13	100	219
MS-C002	60	13.00	14.00	3.17	0.09	60	219
MS-C005I	8	11.20	13.80	2.37	0.07	8	219
MS-I52	-	-	-	-	-	-	228
MS-I5S2	-	-	-	-	-	-	228
MS-I62	-	-	-	-	-	-	228
MS-I6S2	-	-	-	-	-	-	228
MS-I6SP2	-	-	-	-	-	-	-
MS-V001	72	4.00	5.00	1.78	0.05	72	191
MS-V305	200	3.30	4.10	1.78	0.05	200	229
MS-V306	200	3.70	4.30	1.78	0.05	200	229
MS-V308	200	4.40	5.40	1.78	0.05	200	229
MT							
MT-1132	40	16.20	17.20	2.58	0.07	40	21
MT-1210	60	15.00	16.00	3.05	0.09	60	22
MT-1217	30	16.20	17.20	2.24	0.06	30	20
MT-1232	40	16.20	17.60	2.57	0.07	40	21
MT-1233C	60	14.22	18.30	3.06	0.09	60	22
MT-1233D	60	16.20	18.30	3.06	0.09	60	22
MT-1250	20	7.00	8.00	1.92	0.05	20	21
MT-1270	30	16.50	17.50	2.21	0.06	30	20
MT-1280	30	16.05	17.50	2.21	0.06	30	20
MT-1506	64	10.50	11.50	1.12	0.03	64	18
MT-1508	60	13.00	14.00	2.68	0.08	60	19
MT-1509	60	13.00	14.00	2.68	0.08	60	19
MT-1630	60	8.64	10.50	3.05	0.09	60	19
MT-1632	100	15.00	16.00	1.37	0.04	100	19
MT-1705	54	16.00	17.00	1.89	0.05	54	17
MT-1707	20	10.40	11.40	1.30	0.04	20	17
MT-1710	30	17.40	23.00	2.63	0.07	30	17
MT-1820	30	20.80	21.80	3.12	0.09	30	14
MT-1860	30	20.80	22.80	3.12	0.09	30	14
MT-2017	32	16.50	17.50	2.20	0.06	32	26
MT-2018	32	14.50	15.50	2.20	0.06	32	26
MT-3102	20	9.00	11.00	2.36	0.07	20	25
MT-3109	20	9.00	10.50	2.36	0.07	20	24
MT-3110	30	10.50	11.20	1.35	0.04	30	24
MT-3112	20	8.50	9.50	1.42	0.04	20	18
MT-3266	20	9.60	10.35	2.96	0.08	20	25
MT-4606	40	6.40	7.36	1.58	0.04	40	27
MT-4612	20	5.20	5.90	1.60	0.05	20	27
MT-4615	24	7.50	8.50	2.69	0.08	24	28
MT-4616	25	7.00	8.00	2.15	0.06	25	29
MT-4617	24	7.50	8.50	2.69	0.08	24	28
MT-4617LED	24	7.60	8.60	2.69	0.08	24	28
MT-4618	25	8.00	9.00	2.15	0.06	25	29
MT-5110	30	16.80	18.50	2.63	0.07	30	15
MT-5211	30	18.00	19.00	2.63	0.07	30	15
MT-7028	20	11.00	12.00	2.07	0.06	20	8

Model No	QTY/CTN	N.W.	G.W.	CUFT	M3	M.O.Q.	Page	Model No	QTY/CTN	N.W.	G.W.	CUFT	M3	M.O.Q.	Page
MT-7029	20	11.00	12.00	2.07	0.06	20	8	PD-2607	24	14.76	17.30	0.88	0.03	24	227
MT-7051N	48	11.00	13.00	2.49	0.07	48	12	PD-2609	36	12.06	13.60	0.77	0.02	36	227
MT-7057N	50	13.50	14.50	2.00	0.06	50	11	PD-2612	36	12.06	13.30	0.78	0.02	36	227
MT-7058	60	9.50	11.00	2.42	0.07	60	11	PD-3141C	72	14.00	15.00	2.46	0.07	72	97
MT-7059	20	12.20	13.30	3.34	0.09	20	9	PD-3141D	100	8.00	9.00	1.92	0.05	100	97
MT-7062	40	8.00	8.50	1.19	0.03	40	11	PD-3141EBN	100	8.00	8.80	1.80	0.05	100	99
MT-7063	40	8.00	8.50	1.19	0.03	40	10	PD-3141EN	100	8.00	10.00	1.80	0.05	100	99
MT-7064	40	8.00	8.50	1.19	0.03	40	10	PD-372	60	6.30	7.80	1.91	0.05	60	227
MT-7068	20	17.00	18.00	2.34	0.07	20	9	PD-374	36	17.00	19.00	3.01	0.09	36	227
MT-7071	16	14.00	15.00	2.92	0.08	16	7	PD-376	10	13.00	14.50	1.28	0.04	10	227
MT-7501	50	7.50	8.00	0.92	0.03	50	179	PD-392	-	-	-	-	-	-	71
MT-7505	50	7.50	8.00	0.92	0.03	50	179	PD-394A	300	10.00	12.00	2.02	0.06	300	71
MT-7508	50	5.00	5.60	0.76	0.02	50	179	PD-395A	10	6.50	7.50	1.24	0.04	10	71
MT-7509	50	5.20	5.70	0.76	0.02	50	179	PD-398	80	10.00	11.00	1.51	0.04	80	71
MT-7510	50	7.50	8.00	0.92	0.03	50	179	PD-510	144	6.00	7.00	1.20	0.03	144	71
MT-7601	30	12.60	13.00	1.82	0.05	30	178	PD-513	288	12.96	17.80	2.85	0.08	288	71
MT-7602	50	10.00	11.00	1.94	0.05	50	178	PD-610	180	7.00	8.50	1.78	0.05	180	222
MT-7603	32	15.20	16.60	3.61	0.10	32	178	PD-994	120	16.00	18.00	1.78	0.05	120	70
MT-7610A	6	9.60	10.80	3.08	0.09	6	177	PD-998	144	12.00	13.30	2.04	0.06	144	70
MT-7610F	6	9.60	10.80	3.08	0.09	6	177	PD-V003A	72	7.00	8.50	0.87	0.02	72	194
MT-7801	30	11.70	12.70	1.87	0.05	30	179	PD-V003B	72	7.00	8.00	0.87	0.02	72	194
MT-7802	30	11.70	12.70	1.87	0.05	30	179	PD-V003C	72	7.00	8.00	0.87	0.02	72	194
MT-7803	30	11.80	12.80	1.87	0.05	30	179	PD-V003D	72	7.00	8.50	0.87	0.02	72	194
MT-8001	18	12.00	13.00	2.29	0.06	18	6	PD-V004A	72	7.00	8.50	38.30	1.08	72	194
MT-8006B	20	8.20	10.54	4.05	0.11	20	6	PK							
MT-8091	72	8.00	9.00	2.64	0.07	72	5	PK-12012H	5	10.00	12.30	1.90	0.05	5	285
MT-8100	16	13.30	14.30	3.37	0.10	16	5	PK-14019A	2	16.00	18.00	2.66	0.08	2	285
MT-9906	120	12.00	13.00	2.83	0.08	120	26	PK-14019B	2	16.00	18.00	2.66	0.08	2	285
MT-9907	120	12.00	13.00	2.83	0.08	120	26	PK-15305A	2	11.00	12.80	1.98	0.06	2	265
NT								PK-15305B	2	11.00	12.00	1.98	0.06	2	265
NT-1933	200	10.00	11.00	2.80	0.08	200	33	PK-15307BM	2	15.00	17.00	2.44	0.07	2	268
NT-1934	200	13.00	14.00	2.80	0.08	200	33	PK-15307EI	2	16.00	17.00	2.44	0.07	2	268
NT-303	100	5.50	6.70	2.01	0.06	100	32	PK-15308BM	2	25.00	27.00	5.15	0.15	2	276
NT-305	200	10.00	12.00	2.52	0.07	200	32	PK-15308EM	2	25.00	27.00	5.15	0.15	2	276
NT-306	100	4.50	5.60	1.44	0.04	100	32	PK-2006	20	11.00	12.00	1.80	0.05	20	277
NT-309	60	4.70	5.70	1.62	0.05	60	32	PK-2015	6	15.50	16.50	1.27	0.04	6	259
NT-311	50	6.40	8.00	1.23	0.03	50	30	PK-2028T	6	14.00	15.00	1.27	0.04	6	258
NT-312	50	7.20	8.80	1.34	0.04	50	30	PK-2030T	6	12.72	13.20	1.27	0.04	6	258
NT-316	50	7.35	8.00	1.05	0.03	50	30	PK-2051T	6	13.10	13.70	1.27	0.04	6	259
NT-6352	60	17.50	18.50	2.50	0.07	60	30	PK-2052TA	4	14.80	16.10	2.16	0.06	4	259
NT-8540	20	5.50	6.50	1.55	0.04	20	31	PK-2052TB	4	14.80	16.10	2.16	0.06	4	259
NT-8560	20	5.50	6.50	1.55	0.04	20	31	PK-2056	4	18.00	19.00	1.80	0.05	4	258
NT-8580	20	5.50	6.50	1.55	0.04	20	31	PK-2061	8	15.00	16.00	1.98	0.06	8	200
OP								PK-2076B	30	27.60	28.60	1.78	0.05	30	251
OP-1200	20	11.00	12.00	2.76	0.08	20	229	PK-2079	8	9.50	10.50	2.75	0.08	8	252
OP-E070	200	10.00	11.00	1.50	0.04	200	221	PK-2080	24	11.50	12.50	1.08	0.03	24	251
OP-E351	40	7.60	8.40	1.55	0.04	40	221	PK-2086A	8	12.00	13.00	1.08	0.03	8	254
PA								PK-2086B	8	12.00	13.00	1.08	0.03	8	254
PA-101	144	12.96	15.00	1.78	0.05	144	40	PK-2087A	8	18.00	19.00	1.78	0.05	8	256
PA-102	144	15.00	16.50	1.78	0.05	144	40	PK-2087B	8	18.00	19.00	1.78	0.05	8	256
PD								PK-2088A	8	14.00	15.00	1.78	0.05	8	257
PD-151	50	16.00	17.00	1.77	0.05	50	220	PK-2088B	8	14.00	15.00	1.78	0.05	8	257
PD-153	50	16.00	16.50	1.77	0.05	50	220	PK-2090BM	10	17.00	19.00	1.73	0.05	10	257
PD-2606	24	17.40	19.00	1.06	0.03	24	227	PK-2090EI	10	17.00	18.00	1.73	0.05	10	257

Model No	QTY/CTN	N.W.	G.W.	CUFT	M3	M.O.Q.	Page
PK-2091I	12	16.50	17.50	1.27	0.04	12	252
PK-2091M	12	16.50	17.50	1.27	0.04	12	252
PK-2096BM	8	16.00	17.00	1.78	0.05	8	256
PK-2623A	8	15.64	16.64	2.72	0.08	8	253
PK-2623B	8	15.64	16.64	2.72	0.08	8	253
PK-2625	8	20.00	21.00	2.73	0.08	8	255
PK-2626	4	20.00	21.00	2.42	0.07	4	271
PK-2627	4	19.00	18.00	2.42	0.07	4	272
PK-2628	6	17.00	18.00	1.27	0.03	6	280
PK-2629	6	15.00	16.00	1.27	0.03	6	280
PK-2633	12	12.60	13.60	1.27	0.04	12	278
PK-2801	8	10.00	11.00	1.80	0.05	8	197
PK-2802	5	9.50	10.00	1.07	0.03	5	197
PK-2803AM	5	16.00	17.00	1.94	0.05	5	198
PK-2803BM	5	17.00	18.00	1.94	0.05	5	198
PK-2807A	5	18.00	19.00	1.94	0.05	5	198
PK-2807B	5	18.00	19.00	1.94	0.05	5	198
PK-2809M	4	14.52	15.50	2.16	0.06	4	197
PK-2811M	4	6.60	7.60	1.13	0.03	4	195
PK-2812M	4	15.60	16.50	1.13	0.03	4	195
PK-2813M	4	9.80	10.80	1.13	0.03	4	198
PK-2836M	1	10.70	12.00	1.34	0.04	1	199
PK-3D01	6	18.00	19.00	3.62	0.10	6	260
PK-3D02	12	18.00	19.00	3.62	0.10	12	261
PK-4013	8	15.00	16.00	1.80	0.05	8	280
PK-4015	8	14.40	15.50	1.64	0.05	8	279
PK-4021I	2	21.00	22.00	2.75	0.08	2	286
PK-4021M	2	21.00	22.00	2.75	0.08	2	286
PK-4023BM	2	19.00	20.00	2.78	0.08	2	287
PK-4023EI	2	19.50	20.50	2.78	0.08	2	287
PK-4027AI	2	20.50	23.00	2.69	0.08	2	275
PK-4027BM	2	20.50	23.00	2.69	0.08	2	275
PK-4028AI	2	19.00	21.80	2.69	0.08	2	288
PK-4028BM	2	19.00	21.80	2.69	0.08	2	288
PK-4043	2	27.00	28.00	2.69	0.08	2	274
PK-4302AI	2	15.50	17.50	2.44	0.07	2	283
PK-4302BM	2	15.50	17.50	2.44	0.07	2	283
PK-5011	20	9.00	10.00	1.80	0.05	20	277
PK-601	72	13.50	14.50	1.75	0.05	72	251
PK-6942	8	13.70	14.70	2.72	0.08	8	182
PK-9110	100	4.50	5.65	1.29	0.04	100	149
PK-9112	8	7.00	8.00	1.19	0.03	8	151
PK-9116	8	18.00	19.00	1.80	0.05	8	151
PK-9456	8	15.00	16.00	1.19	0.03	8	182
PK-9458	1	4.20	5.50	0.80	0.02	1	183
PK-9460	8	5.20	6.20	1.60	0.05	8	182
PK-9461	8	6.50	7.50	1.27	0.04	8	182
PK-9462	8	8.00	9.00	1.57	0.04	8	182
PK-ST902	50	17.00	18.00	1.78	0.05	50	47
PM							
PM-023CN	144	12.00	14.00	2.02	0.06	144	47
PM-029CN	144	12.00	14.00	2.02	0.06	144	47
PM-036CN	144	13.00	14.80	2.02	0.06	144	47
PM-037CN	144	12.00	13.80	2.02	0.06	144	47

Model No	QTY/CTN	N.W.	G.W.	CUFT	M3	M.O.Q.	Page
PM-046CN	144	13.00	15.00	2.02	0.06	144	47
PM-053CN	144	13.00	15.00	2.02	0.06	144	47
PM-055CN	144	12.96	14.30	1.96	0.06	144	47
PM-071	144	12.00	13.00	1.78	0.05	144	50
PM-072	144	11.00	12.00	1.78	0.05	144	50
PM-073	144	8.64	10.00	1.78	0.05	144	50
PM-101D	144	13.82	15.32	1.94	0.05	144	36
PM-107	144	11.52	13.10	1.87	0.05	144	40
PM-107C	144	10.80	12.88	1.87	0.05	144	40
PM-108	144	10.08	12.10	1.87	0.05	144	40
PM-251	144	10.08	11.95	1.87	0.05	144	43
PM-252	144	8.64	10.82	1.87	0.05	144	43
PM-25PD	144	13.54	15.04	1.94	0.05	144	36
PM-25PD-C	144	13.68	15.18	1.94	0.05	144	36
PM-30D	144	14.83	16.33	1.94	0.05	144	36
PM-396F	144	8.64	10.30	1.87	0.05	144	41
PM-396G	144	7.92	10.19	1.87	0.05	144	41
PM-396H	144	7.92	10.13	1.87	0.05	144	41
PM-396I	144	8.64	10.03	1.87	0.05	144	41
PM-396K	144	8.64	10.30	1.87	0.05	144	41
PM-5101	144	16.99	18.49	1.94	0.05	144	36
PM-5101-C	144	17.14	18.64	1.94	0.05	144	36
PM-701F	200	15.00	17.10	1.52	0.04	200	49
PM-708Y	120	16.80	20.00	1.83	0.05	120	58
PM-711	120	10.80	13.15	1.85	0.05	120	48
PM-712	120	13.50	15.00	1.87	0.05	120	48
PM-717	120	8.60	9.60	1.93	0.05	120	53
PM-718	120	9.00	10.00	1.91	0.05	120	53
PM-720	144	14.26	15.86	1.87	0.05	144	46
PM-721	144	14.26	15.86	1.87	0.05	144	46
PM-722F	200	13.00	15.60	1.52	0.04	200	49
PM-723	144	13.82	15.32	1.87	0.05	144	46
PM-731	96	9.00	12.00	1.78	0.05	96	48
PM-736	96	11.00	13.00	1.78	0.05	96	48
PM-737	96	10.00	12.20	1.78	0.05	96	48
PM-746	96	9.00	11.50	1.78	0.05	96	48
PM-754	96	13.00	14.30	1.78	0.05	96	48
PM-755	96	10.00	12.50	1.78	0.05	96	48
PM-804	36	19.00	20.30	1.08	0.03	36	85
PM-805E	100	11.00	13.00	1.15	0.03	100	55
PM-805F	100	10.70	11.70	1.01	0.03	100	55
PM-806A	120	18.60	21.00	1.87	0.05	120	55
PM-806B	120	22.00	23.00	1.91	0.05	120	55
PM-806E	100	13.00	15.00	1.15	0.03	100	55
PM-806F	120	18.00	19.20	1.24	0.03	120	55
PM-807E	60	15.00	16.00	1.22	0.03	60	55
PM-808	144	10.80	13.20	1.88	0.05	144	51
PM-811	120	20.10	21.10	1.85	0.05	120	55
PM-901	60	22.00	23.50	1.48	0.04	60	60
PM-903	60	24.00	25.00	1.48	0.04	60	60
PM-905F	200	17.50	18.50	1.48	0.04	200	50
PM-905FHC	100	10.00	11.00	1.37	0.04	100	50
PM-908	120	21.60	24.53	1.85	0.05	120	59
PM-909	120	23.00	24.00	1.87	0.05	120	59

Model No	QTY/CTN	N.W.	G.W.	CUFT	M3	M.O.Q.	Page
PM-910	72	16.20	18.70	2.70	0.08	72	190
PM-911	24	8.00	9.00	0.87	0.02	24	190
PM-912	72	17.00	19.50	2.69	0.08	72	190
PM-916	72	22.00	24.50	2.69	0.08	72	190
PM-917	72	17.50	20.00	2.69	0.08	72	190
PM-918	24	6.00	7.00	0.87	0.02	24	190
PM-919	72	14.00	16.50	2.69	0.08	72	190
PM-921	45	13.50	14.50	0.87	0.02	45	60
PM-925	120	11.28	13.90	1.91	0.05	120	54
PM-955	120	15.00	17.24	1.87	0.05	120	54
PM-956	120	21.60	23.60	1.85	0.05	120	54

PN

PN-080	36	17.50	18.50	1.31	0.04	36	60
PN-086N	72	14.50	16.50	1.78	0.05	72	60
PN-088	60	18.00	20.00	1.78	0.05	60	60
PN-378D	36	20.16	21.00	1.56	0.04	36	62
PN-378E	36	14.04	16.80	0.84	0.02	36	62
PN-H010	24	15.00	16.00	0.66	0.02	24	62
PN-H012	16	15.00	16.00	0.59	0.02	16	62
PN-P008	36	11.00	12.00	0.87	0.02	36	61
PN-P010N	36	16.00	17.00	1.31	0.04	36	61
PN-P012	24	16.00	17.50	1.31	0.04	24	61
PN-P110	30	13.00	14.00	0.93	0.03	30	61

PT

PT-036U	14	2.60	3.80	0.61	0.02	14	171
PT-0721A	10	7.80	8.20	1.27	0.04	10	170
PT-0721F	10	7.80	8.20	1.27	0.04	10	170
PT-1136A	20	14.60	16.00	2.22	0.06	20	172
PT-1136F	20	14.60	16.00	2.22	0.06	20	172
PT-1201A	5	14.00	15.00	1.54	0.04	5	170
PT-1201F	5	14.00	15.00	1.54	0.04	5	170
PT-1206A	6	12.50	13.50	2.33	0.07	6	169
PT-1206F	6	12.50	13.50	2.33	0.07	6	169
PT-1207A	6	12.10	13.00	2.33	0.07	6	169
PT-1207F	6	12.10	13.00	2.33	0.07	6	169
PT-1210A	6	11.80	13.00	2.33	0.07	6	169
PT-1210F	6	11.80	13.00	2.33	0.07	6	169
PT-1361A	10	7.15	7.70	1.10	0.03	10	170
PT-1361F	10	7.15	7.70	1.10	0.03	10	170
PT-1362U	20	9.00	10.40	1.80	0.05	20	171
PT-1801A	4	13.50	15.00	2.56	0.07	4	166
PT-1801F	4	13.50	15.00	2.56	0.07	4	166
PT-1802A	4	12.70	14.00	2.56	0.07	4	166
PT-1802F	4	12.70	14.00	2.56	0.07	4	166
PT-1805A	4	13.70	15.00	2.56	0.07	4	167
PT-1805F	4	13.70	15.00	2.56	0.07	4	167
PT-1806A	4	15.00	16.00	2.56	0.07	4	167
PT-1806F	4	15.00	16.00	2.56	0.07	4	167
PT-5201A	24	12.00	13.00	2.08	0.06	24	173
PT-5201B	24	12.00	13.00	2.08	0.06	24	173
PT-5202A	20	13.50	14.50	1.21	0.03	20	173
PT-5202F	20	13.50	14.50	1.21	0.03	20	173
PT-5203A	12	6.00	6.80	0.81	0.02	12	172
PT-5203I	12	6.00	6.80	0.81	0.02	12	172

Model No	QTY/CTN	N.W.	G.W.	CUFT	M3	M.O.Q.	Page
PT-5205U	0	-	-	-	-	0	171
PT-5501A	10	14.00	15.50	2.01	0.06	10	172
PT-5501I	10	14.00	15.50	2.01	0.06	10	172

SB

SB-1007K	80	10.24	10.95	1.71	0.05	80	235
SB-1592	72	5.20	6.62	1.81	0.05	72	235
SB-1813	20	11.00	12.00	4.30	0.12	20	235
SB-1912	120	10.00	11.00	2.69	0.08	120	234
SB-207P	20	18.00	19.00	4.20	0.12	20	233
SB-2419	60	15.60	16.60	4.34	0.12	60	233
SB-2918	24	17.50	19.00	7.46	0.21	24	232
SB-3218	20	10.60	13.00	5.45	0.15	20	232
SB-3428SB	20	20.70	22.70	5.86	0.17	20	233
SB-4121	9	8.64	10.00	5.48	0.16	9	232
SB-4536B	10	13.20	15.20	4.71	0.13	10	233

SD

SD-081A	72	19.50	20.50	2.38	0.07	72	141
SD-081-A1	300	7.20	8.20	1.92	0.05	300	140
SD-081-A2	300	7.20	8.20	1.92	0.05	300	140
SD-081B	72	16.56	18.40	2.50	0.07	72	141
SD-081E	120	14.30	15.30	1.72	0.05	120	141
SD-081F	100	7.50	8.36	1.08	0.03	100	141
SD-081G	100	9.20	10.22	1.38	0.04	100	141
SD-081-H1	300	7.20	8.10	1.92	0.05	300	140
SD-081-H2	300	8.00	9.00	1.92	0.05	300	140
SD-081-H3	300	7.20	8.20	1.92	0.05	300	140
SD-081-H4	300	7.20	8.20	1.92	0.05	300	140
SD-081-H5	300	7.20	8.40	1.92	0.05	300	140
SD-081-H6	300	7.20	9.85	1.79	0.05	300	140
SD-081-H7	300	7.20	9.80	1.92	0.05	300	140
SD-081-M3	300	10.00	11.30	1.92	0.05	300	140
SD-081-M3.5	300	10.00	11.30	1.92	0.05	300	140
SD-081-M4	300	11.60	12.60	1.92	0.05	300	140
SD-081-M4.5	300	10.00	12.00	1.92	0.05	300	140
SD-081-M5	300	10.00	12.00	1.92	0.05	300	140
SD-081-M5.5	-	-	-	-	-	-	140
SD-081-M6	300	10.00	12.80	1.92	0.05	300	140
SD-081-P1	300	6.90	8.94	1.79	0.05	300	140
SD-081-P2	300	6.90	8.95	1.79	0.05	300	140
SD-081-P3	300	8.30	9.30	1.79	0.05	300	140
SD-081-P4	300	5.70	9.68	1.79	0.05	300	140
SD-081-P5	300	5.70	9.40	1.79	0.05	300	140
SD-081-P6	300	7.00	9.80	1.88	0.05	300	140
SD-081-P7	300	11.40	13.62	2.04	0.06	300	140
SD-081-PL5	300	11.40	13.62	2.04	0.06	300	140
SD-081-PL6	300	11.40	13.62	2.04	0.06	300	140
SD-081-S1	300	8.00	9.00	1.79	0.05	300	140
SD-081-S2	300	6.90	9.00	1.79	0.05	300	140
SD-081-S3	300	6.00	8.10	1.79	0.05	300	140
SD-081-S4	300	6.30	9.17	1.79	0.05	300	140
SD-081-S5	300	7.50	9.60	1.79	0.05	300	140
SD-081-S6	300	7.20	9.45	1.79	0.05	300	140
SD-081-S7	300	8.40	10.00	1.71	0.05	300	140
SD-081-S8	300	10.80	13.45	2.04	0.06	300	140

Model No	QTY/CTN	N.W.	G.W.	CUFT	M3	M.O.Q.	Page
SD-081-T1	300	6.90	9.02	1.79	0.05	300	140
SD-081-T10	300	8.00	8.80	1.78	0.05	300	140
SD-081-T10H	300	8.00	8.80	1.78	0.05	300	140
SD-081-T15	300	6.90	10.81	1.79	0.05	300	140
SD-081-T15H	300	8.70	10.81	1.79	0.05	300	140
SD-081-T2	300	8.00	8.20	1.78	0.05	300	140
SD-081-T20	300	7.17	10.83	1.79	0.05	300	140
SD-081-T20H	300	8.70	10.83	1.79	0.05	300	140
SD-081-T3	300	6.90	9.05	1.79	0.05	300	140
SD-081-T4	300	7.50	9.60	1.79	0.05	300	140
SD-081-T5	300	7.50	9.62	1.79	0.05	300	140
SD-081-T5H	300	7.50	9.62	1.79	0.05	300	140
SD-081-T6	300	7.50	9.72	1.79	0.05	300	140
SD-081-T6H	300	7.50	9.72	1.79	0.05	300	140
SD-081-T7	300	7.50	9.72	1.79	0.05	300	140
SD-081-T7H	300	7.50	9.72	1.79	0.05	300	140
SD-081-T8	300	7.50	9.75	1.79	0.05	300	140
SD-081-T8H	300	7.50	9.72	1.79	0.05	300	140
SD-081-T9	300	7.50	9.76	1.79	0.05	300	140
SD-081-T9H	300	7.50	9.76	1.79	0.05	300	140
SD-081-TA20	300	8.00	8.80	1.78	0.05	300	140
SD-081-TA23	300	8.00	8.90	1.78	0.05	300	140
SD-081-TA27	300	8.00	8.90	1.78	0.05	300	140
SD-081-TRI0	300	7.20	9.18	1.79	0.05	300	140
SD-081-TRI00	300	6.00	8.10	1.79	0.05	300	140
SD-081-TRI000	300	7.50	8.10	1.78	0.05	300	140
SD-081-TRI1	300	7.50	8.80	1.78	0.05	300	140
SD-081-TRIY06	300	8.15	9.15	1.86	0.05	300	140
SD-081-TS1	300	6.90	9.00	1.79	0.05	300	140
SD-081-Z1	300	8.10	9.10	1.78	0.05	300	140
SD-081-Z2	300	7.20	9.30	1.79	0.05	300	140
SD-081-Z3	300	7.20	9.38	1.79	0.05	300	140
SD-081-Z4	300	8.40	10.82	1.79	0.05	300	140
SD-0839	60	10.20	11.72	1.86	0.05	60	139
SD-083-A1	300	9.50	10.50	2.02	0.06	300	139
SD-083-A2	300	9.50	10.50	2.02	0.06	300	139
SD-083-H1.5	300	9.50	10.50	2.02	0.06	300	139
SD-083-H2.0	300	9.50	10.50	2.02	0.06	300	139
SD-083-H2.5	300	9.50	10.50	2.02	0.06	300	139
SD-083-H3.0	300	9.50	10.50	2.02	0.06	300	139
SD-083-P2	300	8.10	9.97	1.89	0.05	300	139
SD-083-P3	300	8.10	10.10	1.89	0.05	300	139
SD-083-P4	300	8.40	10.70	1.89	0.05	300	139
SD-083-S3	300	8.10	9.92	1.89	0.05	300	139
SD-083-S4	300	8.10	10.15	1.89	0.05	300	139
SD-083-S5	300	8.70	10.66	1.89	0.05	300	139
SD-083-T10H	300	9.50	10.50	2.02	0.06	300	139
SD-083-T15H	300	9.50	10.50	2.02	0.06	300	139
SD-083-T20H	300	9.50	10.50	2.02	0.06	300	139
SD-083-T4	300	9.50	10.50	2.02	0.06	300	139
SD-083-T5H	300	9.50	10.50	2.02	0.06	300	139
SD-083-T6H	300	9.50	10.50	2.02	0.06	300	139
SD-083-T7H	300	9.50	10.50	2.02	0.06	300	139
SD-083-T8H	300	9.50	10.50	2.02	0.06	300	139

Model No	QTY/CTN	N.W.	G.W.	CUFT	M3	M.O.Q.	Page
SD-083-T9H	300	9.50	10.50	2.02	0.06	300	139
SD-086-P1	-	-	-	-	-	-	142
SD-086-P2	-	-	-	-	-	-	142
SD-086-P3	-	-	-	-	-	-	142
SD-086-P4	-	-	-	-	-	-	142
SD-086-P5	-	-	-	-	-	-	142
SD-086-P6	-	-	-	-	-	-	142
SD-086-P7	-	-	-	-	-	-	142
SD-086-S1	-	-	-	-	-	-	142
SD-086-S2	-	-	-	-	-	-	142
SD-086-S3	-	-	-	-	-	-	142
SD-086-S4	-	-	-	-	-	-	142
SD-086-S5	-	-	-	-	-	-	142
SD-086-S6	-	-	-	-	-	-	142
SD-086-S7	-	-	-	-	-	-	142
SD-205	12	8.04	8.75	0.58	0.02	12	136
SD-2301	24	11.00	12.20	1.90	0.05	24	126
SD-2302	24	6.96	8.20	1.90	0.05	24	126
SD-2309	12	9.00	10.00	0.54	0.02	12	137
SD-2310	24	16.08	16.80	0.66	0.02	24	137
SD-2313	48	13.92	15.60	1.40	0.04	48	133
SD-2314M	24	18.40	19.40	1.71	0.05	24	134
SD-2316M	16	13.60	14.50	1.23	0.03	16	138
SD-2317M	16	13.20	14.20	1.31	0.04	16	138
SD-2318M	40	14.80	16.00	1.10	0.03	40	136
SD-2319M	48	14.40	15.30	1.03	0.03	48	134
SD-2320M	36	13.50	14.50	1.81	0.05	36	134
SD-2393K	1	12.00	13.00	2.84	0.08	1	127
SD-2400-S10	200	12.00	13.00	1.76	0.05	200	132
SD-2400-S4	200	8.80	10.32	1.80	0.05	200	132
SD-2400-S6	200	10.70	11.70	1.82	0.05	200	132
SD-2400-S8	200	12.00	12.92	1.76	0.05	200	132
SD-2404	100	19.50	20.50	2.48	0.07	100	132
SD-2610M	96	15.00	16.00	2.14	0.06	96	136
SD-2800-M10	96	13.44	15.54	1.89	0.05	96	132
SD-2800-M11	96	17.95	20.06	2.26	0.06	96	132
SD-2800-M12	96	18.14	20.30	2.26	0.06	96	132
SD-2800-M13	96	18.72	20.71	2.26	0.06	96	132
SD-2800-M4	96	12.10	14.03	1.89	0.05	96	132
SD-2800-M5	96	12.29	14.06	1.89	0.05	96	132
SD-2800-M5.5	96	12.48	14.23	1.89	0.05	96	132
SD-2800-M6	96	12.48	14.25	1.89	0.05	96	132
SD-2800-M7	96	13.06	14.79	1.89	0.05	96	132
SD-2800-M8	96	13.25	15.04	1.89	0.05	96	132
SD-2800-M9	96	13.44	15.19	1.89	0.05	96	132
SD-315A	20	10.70	11.20	1.60	0.05	20	193
SD-3502	96	9.50	10.50	1.10	0.03	96	146
SD-5101A	360	5.40	6.90	0.46	0.01	360	131
SD-5101B	360	5.40	6.90	0.46	0.01	360	131
SD-5102A	360	13.90	15.50	0.69	0.02	360	131
SD-5102B	360	13.90	15.50	0.69	0.02	360	131
SD-5105A	360	7.60	9.20	0.46	0.01	360	131
SD-5105B	360	7.60	9.20	0.46	0.01	360	131
SD-5106A	240	4.50	6.00	0.46	0.01	240	131

Model No	QTY/CTN	N.W.	G.W.	CUFT	M3	M.O.Q.	Page	Model No	QTY/CTN	N.W.	G.W.	CUFT	M3	M.O.Q.	Page
SD-5106B	240	4.50	6.00	0.46	0.01	240	131	SD-9315	72	16.00	17.00	2.00	0.06	72	143
SD-5107A	240	16.50	18.00	0.75	0.02	240	131	SD-9316	72	19.00	20.00	2.00	0.06	72	143
SD-5107B	240	16.50	18.00	0.75	0.02	240	131	SD-9326M	16	8.00	9.00	1.31	0.04	16	150
SD-5107D	120	14.00	15.00	1.78	0.05	120	131	SD-9608	80	16.24	17.50	1.45	0.04	80	144
SD-5110A	240	10.50	11.70	0.51	0.01	240	131	SD-9701M	24	11.50	12.50	1.39	0.04	24	133
SD-5110B	240	10.50	11.70	0.51	0.01	240	131	SD-9802	36	9.50	10.50	1.75	0.05	36	144
SD-5112A	180	11.90	13.30	0.65	0.02	180	131	SD-9803	72	17.64	19.56	2.07	0.06	72	141
SD-5112B	180	11.90	13.30	0.65	0.02	180	131	SD-9804	24	5.50	6.50	1.16	0.03	24	144
SD-5113A	240	18.70	20.00	0.94	0.03	240	131	SD-9805	48	17.28	19.13	2.61	0.07	48	193
SD-5113B	240	18.70	20.00	0.94	0.03	240	131	SD-9806	40	13.00	15.00	2.15	0.06	40	149
SD-5114A	180	16.00	17.70	0.98	0.03	180	131	SD-9808N	40	12.00	13.06	1.13	0.03	40	145
SD-5114B	180	16.00	17.70	0.98	0.03	180	131	SD-9810A	4	10.00	11.50	1.36	0.04	4	135
SD-5116A	240	12.20	13.60	0.63	0.02	240	131	SD-9811	96	14.00	15.00	2.33	0.07	96	145
SD-5116B	240	12.20	13.60	0.63	0.02	240	131	SD-9812	120	10.50	11.50	2.04	0.06	120	143
SD-5117A	180	18.00	19.70	0.98	0.03	180	131	SD-9814	144	8.64	10.00	1.88	0.05	144	143
SD-5117B	180	18.00	19.70	0.98	0.03	180	131	SD-9815	100	16.50	17.50	1.64	0.05	100	145
SD-5119A	180	13.50	15.00	0.74	0.02	180	131	SD-9816	36	19.50	21.00	1.86	0.05	36	133
SD-5119B	180	13.50	15.00	0.74	0.02	180	131	SD-9817	36	6.66	7.65	1.21	0.03	36	133
SD-5120A	360	14.50	16.00	0.83	0.02	360	131	SD-9819	100	11.00	12.50	1.05	0.03	100	145
SD-5120B	360	14.50	16.00	0.83	0.02	360	131	SD-9824	48	20.21	21.10	1.76	0.05	48	142
SD-5121A	180	19.80	21.60	1.11	0.03	180	131	SD-9828	40	13.00	14.00	1.02	0.03	40	150
SD-5121B	180	19.80	21.60	1.11	0.03	180	131	SD-9829M	24	4.00	5.00	1.31	0.04	24	145
SD-800-M10	96	14.21	15.85	1.89	0.05	96	192	SD-9857M	24	11.50	12.50	1.68	0.05	24	138
SD-800-M11	96	18.43	20.57	2.26	0.06	96	192	SD-T635-0112	24	7.68	8.51	0.94	0.03	24	158
SD-800-M12	96	18.53	20.74	2.26	0.06	96	192	SD-T635-16	24	10.44	11.34	1.07	0.03	24	158
SD-800-M13	96	19.01	21.25	2.26	0.06	96	192	SD-T635-510	24	10.42	11.34	1.07	0.03	24	158
SD-800-M4.0	96	12.67	13.70	2.47	0.07	96	192	SD-T636	20	17.00	17.60	1.40	0.04	20	158
SD-800-M5.0	96	12.67	13.70	2.47	0.07	96	192	SD-T860	20	16.66	17.20	2.10	0.06	20	193
SD-800-M5.5	96	12.96	14.80	1.89	0.05	96	192	SH							
SD-800-M6.0	96	12.96	14.00	2.47	0.07	96	192	SH-1025	80	10.00	11.80	2.15	0.06	80	121
SD-800-M7.0	96	13.54	14.60	2.47	0.07	96	192	SH-1025-B	40	6.00	8.00	3.01	0.09	40	121
SD-800-M8.0	96	13.73	14.80	2.47	0.07	96	192	SH-4017	120	9.00	10.00	1.78	0.05	120	122
SD-800-M9.0	96	13.82	14.90	2.47	0.07	96	192	SH-4020	20	10.00	11.00	1.60	0.05	20	121
SD-800-P0	240	14.30	15.30	3.11	0.09	240	192	SI							
SD-800-P1	240	21.70	22.70	3.36	0.10	240	192	SI-124B-100	50	16.50	18.20	2.36	0.07	50	110
SD-800-P2	144	16.85	19.67	2.89	0.08	144	192	SI-124B-30	50	12.50	13.80	2.36	0.07	50	110
SD-800-P3	96	18.24	20.25	2.31	0.07	96	192	SI-124B-40	50	13.00	14.50	2.36	0.07	50	110
SD-800-S2.5	240	12.00	14.67	3.11	0.09	240	192	SI-124B-60	50	13.50	15.20	2.36	0.07	50	110
SD-800-S3.0	240	13.90	14.90	3.11	0.09	240	192	SI-125A-20	80	10.40	12.41	2.82	0.08	80	111
SD-800-S4.0	240	14.40	17.00	3.11	0.09	240	192	SI-129B-30	40	8.50	10.00	1.94	0.06	40	109
SD-800-S5.5	144	12.96	15.78	2.16	0.06	144	192	SI-129B-40	40	8.50	10.00	1.94	0.06	40	109
SD-800-S6.5	144	18.72	21.84	3.12	0.09	144	192	SI-129B-60	40	8.50	10.00	1.94	0.06	40	109
SD-800-S8.0	96	21.12	22.00	2.60	0.07	96	192	SI-130A-20	80	11.20	13.00	3.18	0.09	80	109
SD-800-Z0	240	15.40	16.40	2.92	0.08	240	192	SI-130A-25	80	11.20	13.00	3.18	0.09	80	109
SD-800-Z1	240	22.60	23.60	3.35	0.09	240	192	SI-130B-20	40	9.38	11.00	1.59	0.04	40	109
SD-800-Z2	144	15.50	16.50	2.03	0.06	144	192	SI-130B-25	40	9.38	11.00	1.59	0.04	40	109
SD-800-Z3	96	19.20	20.20	2.31	0.07	96	192	SI-131B	40	8.50	10.00	1.94	0.06	40	109
SD-8011	10	9.21	10.20	1.84	0.05	10	192	SI-132A	20	7.00	8.00	1.23	0.03	20	116
SD-803	10	7.40	8.40	1.50	0.04	10	147	SI-132B	20	13.00	14.00	1.23	0.03	20	116
SD-804	10	10.40	11.40	1.53	0.04	10	147	SI-138A	20	13.00	14.00	1.21	0.03	20	116
SD-9302	48	20.50	21.50	2.60	0.07	48	144	SI-138B	20	13.00	14.00	1.21	0.03	20	116
SD-9312	96	18.00	19.00	2.07	0.06	96	142	SI-168U	50	5.00	6.00	0.87	0.02	50	111
SD-9313	30	13.00	14.00	1.81	0.05	30	150	SI-B161	80	7.20	9.10	1.99	0.06	80	112
SD-9314	72	12.50	13.50	1.72	0.05	72	149	SI-B162	100	4.50	6.00	2.54	0.07	100	112

Model No	QTY/CTN	N.W.	G.W.	CUFT	M3	M.O.Q.	Page
SI-S106A	50	11.50	13.00	1.96	0.06	50	112
SI-S106B	50	11.50	13.00	1.96	0.06	50	112
SI-S120T-4B	100	11.00	12.00	1.80	0.05	100	110
SI-S120T-4BC	100	11.00	12.00	1.80	0.05	100	110
SI-S120T-4C	100	11.00	12.00	1.80	0.05	100	110
SI-S120T-4SB	100	11.00	12.00	1.80	0.05	100	110
SI-S120T-5B	100	11.00	12.00	1.80	0.05	100	110
SI-S120T-5BC	100	11.00	12.00	1.80	0.05	100	110
SI-S120T-5C	100	11.00	12.00	1.80	0.05	100	110
SI-S120T-5SB	100	11.00	12.00	1.80	0.05	100	110
SI-S120T-6B	100	9.00	10.00	1.80	0.05	100	110
SI-S120T-6BC	100	9.00	10.00	1.80	0.05	100	110
SI-S120T-6C	100	9.00	10.00	1.80	0.05	100	110
SI-S120T-6SB	100	9.00	10.00	1.80	0.05	100	110
SK							
SK-22301M	12	14.80	15.80	0.60	0.02	12	162
SK-22401M	12	15.72	16.60	0.60	0.02	12	162
SK-23801M	8	13.00	14.00	0.60	0.02	8	162
SK-42401M	4	21.40	22.10	0.75	0.02	4	162
SK-42601M	4	22.48	23.00	0.79	0.02	4	163
SK-612401M	1	20.50	21.50	2.46	0.07	1	163
SK-V308B	72	2.00	3.00	1.31	0.04	72	196
SK-V310B	72	2.50	3.50	1.31	0.04	72	196
SK-V311B	72	2.50	3.50	1.31	0.04	72	196
SK-V312B	72	2.80	3.80	1.31	0.04	72	196
SK-V313B	72	2.80	3.80	1.31	0.04	72	196
SK-V314B	72	2.80	3.80	1.31	0.04	72	196
SK-V316B	72	2.80	3.80	1.31	0.04	72	196
SK-V317B	72	3.30	4.30	1.31	0.04	72	196
SK-V318B	72	3.30	4.30	1.31	0.04	72	196
SK-V319B	72	4.00	5.00	1.31	0.04	72	196
SK-V321B	72	4.30	5.30	1.31	0.04	72	196
SK-V322B	72	4.80	5.80	1.31	0.04	72	196
SK-V410B	72	4.50	5.50	1.31	0.04	72	196
SK-V411B	72	4.50	5.50	1.31	0.04	72	196
SK-V412B	72	4.50	5.50	1.31	0.04	72	196
SK-V413B	72	4.50	5.50	1.31	0.04	72	196
SK-V414B	72	4.80	5.80	1.31	0.04	72	196
SK-V416B	72	4.80	5.80	1.31	0.04	72	196
SK-V417B	72	5.50	6.50	1.31	0.04	72	196
SK-V418B	72	5.80	6.80	1.31	0.04	72	196
SK-V419B	72	5.00	6.00	1.31	0.04	72	196
SK-V421B	72	5.50	6.50	1.31	0.04	72	196
SK-V422B	72	6.30	7.30	1.31	0.04	72	196
SK-V424B	72	6.30	7.30	1.31	0.04	72	196
SK-V427B	72	8.50	9.50	1.31	0.04	72	196
SK-V430B	72	10.50	11.50	1.31	0.04	72	196
SK-V432B	72	10.50	11.50	1.31	0.04	72	196
SK-V732	32	11.00	12.00	2.22	0.06	32	196
SK-V752	32	18.00	19.00	2.22	0.06	32	196
SK-V831	60	8.50	9.50	1.31	0.04	60	196
SK-V832	30	8.00	9.00	1.31	0.04	30	196
SK-V851	60	13.30	14.30	1.31	0.04	60	196

Model No	QTY/CTN	N.W.	G.W.	CUFT	M3	M.O.Q.	Page
SK-V852	30	13.00	14.00	1.31	0.04	30	196
SN							
SN-002	40	8.20	9.50	2.14	0.06	40	121
SN-390	20	13.50	14.50	2.05	0.06	20	120
SN-392	24	16.08	16.50	1.12	0.03	24	120
SN-394	48	11.04	12.87	2.18	0.06	48	120
SN-396	4	5.56	6.50	1.55	0.04	4	120
SR							
SR-015	80	18.50	19.20	1.71	0.05	80	63
SR-228	60	11.10	12.60	1.29	0.04	60	63
SR-255	30	21.00	24.00	2.67	0.08	30	65
SR-330	100	8.50	10.00	1.49	0.04	100	69
SR-331	100	14.00	16.00	2.27	0.06	100	69
SR-332	100	15.50	17.30	2.27	0.06	100	69
SR-333	200	8.00	10.28	2.58	0.07	200	69
SR-363A	60	12.00	13.00	1.34	0.04	60	64
SR-363B	60	10.80	11.90	1.34	0.04	60	88
SR-366	48	14.88	15.67	1.78	0.05	48	69
SR-533	20	16.00	17.00	1.19	0.03	20	66
SR-536	20	14.10	16.00	1.40	0.04	20	65
SR-538	10	12.10	12.59	0.99	0.03	10	66
SR-539	-	-	-	-	-	-	66
SR-V206	30	7.30	8.30	0.87	0.02	30	191
SR-V210	18	10.00	11.00	1.31	0.04	18	191
SR-V336	48	5.76	6.70	1.78	0.05	48	191
SR-V537	24	12.60	13.60	1.84	0.05	24	191
SS							
SS-202A	20	15.00	16.00	1.05	0.03	20	107
SS-202F	20	15.00	16.00	1.05	0.03	20	107
SS-206B	8	18.30	19.30	2.21	0.06	8	106
SS-206E	8	14.40	16.40	2.21	0.06	8	106
SS-207B	8	18.00	19.00	2.21	0.06	8	106
SS-207E	8	14.40	16.40	2.21	0.06	8	106
SS-256B	4	10.90	11.90	1.26	0.04	4	105
SS-256E	4	10.90	11.90	2.20	0.06	4	105
SS-257B	4	12.80	13.32	2.20	0.06	4	105
SS-257E	4	12.80	13.32	2.20	0.06	4	105
SS-259B	4	12.80	13.32	2.20	0.06	4	105
SS-259E	4	12.80	13.32	2.20	0.06	4	105
SS-331B	2	6.00	7.00	0.92	0.03	2	104
SS-551B	20	12.50	13.50	1.24	0.04	20	108
SS-552B	20	13.10	14.10	1.24	0.04	20	108
SS-553B	16	17.00	18.00	1.76	0.05	16	108
SS-554B	16	17.90	18.90	1.76	0.05	16	108
SS-562B	6	17.00	18.00	2.13	0.06	6	108
SS-571B	6	17.00	18.00	2.13	0.06	6	108
SS-593A	4	6.80	7.50	2.13	0.06	4	107
SS-593B	4	6.80	7.50	2.13	0.06	4	107
SS-595A	8	8.00	9.00	2.03	0.06	8	107
SS-595B	8	8.00	9.00	2.03	0.06	8	107
SS-602B	20	11.80	12.80	1.40	0.04	20	104
SS-602E	20	7.00	8.00	1.40	0.04	20	104
SS-611A	5	7.50	8.50	1.35	0.04	5	115

Model No	QTY/CTN	N.W.	G.W.	CUFT	M3	M.O.Q.	Page	Model No	QTY/CTN	N.W.	G.W.	CUFT	M3	M.O.Q.	Page
SS-611B	5	7.50	8.50	1.35	0.04	5	115	TC-310	2	9.00	10.60	2.69	0.08	2	239
SS-621B	10	11.80	12.50	2.22	0.06	10	115	TC-311	2	8.80	12.50	5.01	0.14	2	237
SS-803F	6	9.00	9.50	2.28	0.06	6	118	TC-700	2	5.50	7.00	1.98	0.06	2	240
SS-820B	4	10.20	13.80	2.86	0.08	4	118	TC-736	2	10.50	11.00	2.68	0.08	2	240
SS-956B	4	17.00	18.00	2.83	0.08	4	102	TC-747N	4	13.44	16.50	5.39	0.15	4	238
SS-956E	4	17.00	18.00	2.83	0.08	4	102	TC-750SN	4	7.20	9.00	2.56	0.07	4	241
SS-968B	4	16.50	17.50	2.77	0.08	4	103	TC-752	1	1.85	2.70	0.93	0.03	1	238
SS-968E	4	16.50	17.50	2.77	0.08	4	103	TC-755	2	19.60	21.50	5.80	0.16	2	240
SS-969B	6	11.88	12.65	2.07	0.06	6	103	TC-850	4	15.00	17.00	4.51	0.13	4	237
SS-969E	6	11.88	12.65	2.07	0.06	6	103	TE							
SS-989B	4	23.08	23.93	2.69	0.08	4	101	TE-1201UB	24	12.00	13.00	1.54	0.04	24	217
SS-989E	4	23.08	23.93	2.69	0.08	4	101	TE-1203UB	16	12.00	13.00	1.34	0.04	16	217
ST								TE-1206B	12	16.92	18.20	1.62	0.05	12	217
ST-12B	5	8.40	9.80	2.70	0.08	5	243	TE-1210B	6	15.84	16.50	2.49	0.07	6	217
ST-13S	20	15.52	16.30	3.20	0.09	20	245	TE-1401UB	24	12.00	13.00	1.54	0.04	24	217
ST-2012H	30	11.40	12.50	2.69	0.08	30	242	TE-1403UB	16	12.16	13.00	1.34	0.04	16	217
ST-3216	10	8.80	9.80	3.92	0.11	10	244	TE-1406B	12	18.00	19.50	1.62	0.05	12	217
ST-3218B	10	8.75	10.60	3.25	0.09	10	244	TE-1410B	6	15.50	16.50	2.49	0.07	6	217
ST-3218G	10	8.75	10.60	3.25	0.09	10	244	TE-5305B	2	10.70	12.40	1.41	0.04	2	33
ST-3218O	10	8.75	10.60	3.25	0.09	10	244	TE-8202A	1	6.40	7.60	1.65	0.05	1	176
ST-4029	10	8.50	9.50	2.80	0.08	10	243	TE-8202A-W	1	5.50	6.70	1.65	0.05	1	176
ST-5102	6	2.34	3.40	2.31	0.07	6	248	TE-8202F	1	6.40	7.60	1.65	0.05	1	176
ST-5105	8	3.36	4.50	2.34	0.07	8	248	TE-8202F-W	1	5.50	6.70	1.65	0.05	1	176
ST-51503	2	5.42	6.50	2.67	0.08	2	247	TZ							
ST-5203	40	4.80	5.80	3.11	0.09	40	248	TZ-100A	300	5.00	7.20	1.78	0.05	300	208
ST-5204	45	3.83	5.00	2.31	0.07	45	248	TZ-100B	300	5.00	7.20	1.78	0.05	300	208
ST-5208	40	8.80	10.00	2.42	0.07	40	248	TZ-100C	300	5.00	7.20	1.78	0.05	300	208
ST-5301	4	9.08	9.80	3.31	0.09	4	247	TZ-100D	300	5.00	7.20	1.80	0.05	300	208
ST-5302	8	8.80	9.80	3.22	0.09	8	246	TZ-116	300	10.00	11.00	1.78	0.05	300	205
ST-5309	10	8.50	9.00	1.77	0.05	10	246	TZ-121	72	4.03	5.50	1.78	0.05	72	208
ST-5310	10	10.00	11.20	2.93	0.08	10	246	TZ-202N	300	11.50	12.50	1.78	0.05	300	203
ST-5502	40	8.00	9.60	2.90	0.08	40	248	TZ-204N	300	11.50	12.50	1.78	0.05	300	203
ST-5503	100	9.50	10.40	2.31	0.07	100	248	TZ-205N	300	11.50	12.50	1.78	0.05	300	203
ST-5504	60	12.00	13.00	2.32	0.07	60	248	TZ-212N	300	11.50	12.50	1.78	0.05	300	203
ST-5601	100	13.50	14.00	1.20	0.03	100	249	TZ-225N	300	11.50	12.50	1.78	0.05	300	203
ST-5701	2	4.20	4.80	1.99	0.06	2	247	TZ-300A	300	8.50	10.50	1.78	0.05	300	208
ST-8BA	10	8.17	9.20	3.27	0.09	10	243	TZ-300B	300	8.50	10.50	1.78	0.05	300	208
SW								TZ-V302A	72	2.50	3.50	1.31	0.04	72	194
SW-0118	24	12.00	14.40	2.65	0.08	24	145	TZ-V302B	72	3.00	4.00	1.31	0.04	72	194
SW-106	80	12.00	13.50	3.01	0.09	80	225	TZ-V302C	72	3.00	4.00	1.31	0.04	72	194
SW-2125	80	14.50	15.50	2.09	0.06	80	129	TZ-V302D	72	3.50	4.50	1.31	0.04	72	194
SW-2125H	80	14.50	15.50	2.09	0.06	80	129								
SW-2128	1	11.50	12.50	2.84	0.08	1	127								
SW-9106	40	12.50	13.50	1.58	0.04	40	130								
SW-9107D	100	11.00	12.00	1.58	0.04	100	131								
SW-9109D	50	12.00	12.50	0.82	0.02	50	130								
TC															
TC-131	3	10.28	11.30	2.23	0.06	3	249								
TC-132	4	11.20	12.70	2.85	0.08	4	249								
TC-2009	4	12.48	16.50	5.20	0.15	4	238								
TC-265	6	14.40	16.00	7.14	0.20	6	231								
TC-266	6	10.80	12.50	4.77	0.14	6	231								
TC-267	8	10.60	13.50	4.61	0.13	8	231								

Ваш поставщик:
ООО "КОМПАНИЯ ОПТУЛС"
Москва, ул.Иловайская, д.3
Тел.: +7 (495) 646-00-96
sale@opttools.ru
www.opttools.ru

Pro'sKit®



Certificate Number: TW00123230A

PROKIT'S INDUSTRIES CO., LTD.

5F, No.7, Lane 130, Ming-Chung Rd., Hsin-Tien Dist,
New Taipei City, Taiwan, R.O.C Post code:23141

Tel: 886-2-22183233(Rep.) Fax: 886-2-22182722

E-mail: pk@mail.prokits.com.tw <https://www.prokits.com.tw>